

THE
INTERNATIONAL



E DUCATION
S E R I E S



12-172 = 160

$$\begin{array}{r} 250 \overline{) 500} \\ \underline{500} \\ 0 \end{array}$$



Digitized by the Internet Archive
in 2007 with funding from
Microsoft Corporation

International Education Series

EDITED BY

WILLIAM T. HARRIS, A. M., LL. D.

VOLUME IV.

INTERNATIONAL EDUCATION SERIES.

EDITED BY W. T. HARRIS.

It is proposed to publish, under the above title, a library for teachers and school managers, and text-books for normal classes. The aim will be to provide works of a useful practical character in the broadest sense.

The following conspectus will show the ground to be covered by the series :

I.—History of Education. (A.) Original systems as expounded by their founders. (B.) Critical histories which set forth the customs of the past and point out their advantages and defects, explaining the grounds of their adoption, and also of their final disuse.

II.—Educational Criticism. (A.) The noteworthy arraigments which educational reformers have put forth against existing systems: these compose the classics of pedagogy. (B.) The critical histories above mentioned.

III.—Systematic Treatises on the Theory of Education. (A.) Works written from the historical standpoint; these, for the most part, show a tendency to justify the traditional course of study and to defend the prevailing methods of instruction. (B.) Works written from critical standpoints, and to a greater or less degree revolutionary in their tendency.

IV.—The Art of Education. (A.) Works on instruction and discipline, and the practical details of the school-room. (B.) Works on the organization and supervision of schools.

Practical insight into the educational methods in vogue can not be attained without a knowledge of the process by which they have come to be established. For this reason it is proposed to give special prominence to the history of the systems that have prevailed.

Again, since history is incompetent to furnish the ideal of the future, it is necessary to devote large space to works of educational criticism. Criticism is the purifying process by which ideals are rendered clear and potent, so that progress becomes possible.

History and criticism combined make possible a theory of the whole. For, with an ideal toward which the entire movement tends, and an account of the phases that have appeared in time, the connected development of the whole can be shown, and all united into one system.

Lastly, after the science, comes the practice. The art of education is treated in special works devoted to the devices and technical details useful in the school-room.

It is believed that the teacher does not need authority so much as insight in matters of education. When he understands the theory of education and the history of its growth, and has matured his own point of view by careful study of the critical literature of education, then he is competent to select or invent such practical devices as are best adapted to his own wants.

The series will contain works from European as well as American authors, and will be under the editorship of W. T. HARRIS, A. M., LL. D. The price for the volumes of the series will be \$1.50 for the larger volumes, 75 cents for the smaller ones.

Vol. I. The Philosophy of Education. By Johann Karl Friedrich Rosenkranz.

Vol. II. A History of Education. By Prof. F. V. N. Painter, of Roanoke, Virginia.

Vol. III. The Rise and Early Constitution of Universities. With a Survey of Mediæval Education. By S. S. Laurie, LL. D., Professor of the Institutes and History of Education in the University of Edinburgh.

INTERNATIONAL EDUCATION SERIES

THE
VENTILATION AND WARMING OF
SCHOOL BUILDINGS

BY

GILBERT B. MORRISON

TEACHER OF PHYSICS AND CHEMISTRY IN KANSAS CITY HIGH-SCHOOL

NEW YORK
D. APPLETON AND COMPANY
1887

COPYRIGHT, 1887,
BY D. APPLETON AND COMPANY.

EDITOR'S PREFACE.

THE practical character of the present volume will be at once manifest. Of the four departments of educational literature—history, criticism, theory, and practice—the last includes two classes of works:

1. Those that relate to instruction and discipline, and the details of teaching. Under this head come the arrangement of the course of study, the programme of daily work, the methods of teaching and discipline.

2. Those that relate to the organization and supervision of schools. Under this head we include works relating to school legislation, governing boards, the building of school-houses, and the organization of a corps of teachers.

Of these *practical* matters—practical because they relate to the application of theory to details, and imply the adaptation of means to ends—the question of the proper construction of school-houses is justly esteemed to be of great importance. The school-house is a permanent affair. Other matters may be changed with less ceremony; a building stands for two or more generations. If it is faulty in its method of lighting, it will send out every seven years its quota of children all

affected more or less with a tendency to weakness of eyes, near-sightedness, and to nervous dyspepsia and irritability of temper. If the ventilation has been defective, and a remedy has been sought by opening the windows, so as to admit cold air from the bottom, the seeds of future rheumatism and heart-disease have been sowed. If the warming has been imperfect, a long series of colds have weakened the lungs of pupils, and many cases of consumption resulted.

The author truly remarks that "the greatest necessities are often not felt as wants." Our early experience in a school-room that failed in these essential particulars has left on our minds, perhaps, in most cases, the impression that we did very well in the old-fashioned school-house. We were not able then to trace causes and effects in these matters on account of ignorance of hygiene. We have seen evil enough befall our companions in their life subsequent to the school, but it has not occurred to us to trace it to the exposure incident to improperly constructed school-buildings.

It is believed that the present work furnishes a good text-book and book of reference to be used in normal institutes and normal schools. A short course of lessons or lectures will suffice to qualify a teacher to judge correctly in matters of ventilation, and to act efficiently under all circumstances. When this is considered, it will be seen that every corps of teachers should be taught the theory and practice of warming and ventilating according to the experimental or investigating method.

I have drawn up the following syllabus of topics and suggestions for a course of eight lessons, covering

the most important items of the subject. I have also added a full analysis of the contents of the volume :

LESSON I.—The general principles of hygiene as related to ventilation. The necessity of pure air. Analysis of air. What impurities are found in the air of unventilated school-rooms. Pasteur's experiments. Effect of breathing impure air—stupor, headaches, diseases of the lungs, dyspepsia, nervous affections, etc. (Chapters I, II, III).

LESSON II.—How to test the purity of the air (Chapter IV). The proper degree of moisture in the air—73 per cent of saturation (Chapter III). How to test the degree of humidity (Appendix A, page 161, Glaisher's factors). Amounts of moisture in the out-door air at different temperatures (page 162): at 80° Fahr., elastic force 1.023; at 70°, .733; at 50°, .361; at 32°, .181; at 20°, .108; at zero, .044. If out-door air at a temperature of 20° Fahr. is heated in the school-room to 70° without adding moisture to it, it is seven times as dry—that is to say, its capacity to absorb moisture has become seven times as great as before. Hence the deleterious effect on the mucous membrane of the air-passages and even on the skin of the body.

LESSON III.—The proper amount of light for a school-room. It should be lighted on two sides—from the rear of the pupils and from the left-hand side—not from the right-hand side, because of the shadow of the hand upon the paper when writing or drawing. The windows should extend to the top of the room, or at least as high as one half the width of the room, in order to light sufficiently the pupils sitting farthest from the windows. Hence the room should not be too wide—

not over 24 or 28 feet when the windows extend 14 feet above the floor. The length of the room may be 32 or 34 feet. There should be three windows on the side and two at the end of the room. Double windows are very desirable for ventilation purposes (Chapter X), and for protection in very cold weather, when a current of chilled air falls down the surface of the window. If a room happens to be seated so that light comes from the right hand of the pupil, the desks may be changed so as to bring it from the left hand and rear. A school-building is ill constructed if its rooms have windows on one side only, unless the rooms are very narrow, and receive light solely from the north, as such rooms are sometimes constructed in Europe for advantages in drawing-lessons. Rooms on the south, east, or west side of the building must exclude the direct rays of the sun during some portion of the day by curtains or shutters, and the consequence is that pupils sitting remote from the windows get too little light, unless thin white curtains are used and the windows are very large, and in height equal to two thirds the width of the room. Pupils sitting in twilight (the shutters being closed) become near-sighted in consequence of straining their eyes, or because they acquire a habit of holding the book too near the eyes. The correct form of school-building requires four rooms to each story—one on each corner. Two or three stories at most is enough, and a school-house should not stand nearer than 70 feet to another building, on account of the obstruction to light occasioned by it, especially to the rooms of the ground story.

LESSON IV.—The amount of air required per pupil

—2,000 feet per hour (Chapter V). The average school-room, $28 \times 34 \times 14$, with 50 pupils, furnishes fresh air enough to last 7 minutes. Methods of calculating the size of ventilators necessary, and the rapidity of the movement of the currents of air admitted through them (Chapter V). The registers for the entrance of fresh air properly warmed should be distributed around the room. Natural ventilation depends on the fact that heated air is lighter and rises; passing out of the top of the room, it sucks in fresh air through the inlets below (Chapters V and VI). The inlets should be placed near the floor. Why? (Chapter VII.) Size of flues admitting fresh air for 75 children—10 square feet of total area. The foul-air flues should have an equal area. Importance of frequent cleaning of the foul-air shafts (Chapter VIII).

LESSON V.—Aspirating chimneys—what they are, and how large. The velocity of the column of air ascending to be 7.7 feet per second. Discuss the two methods: (a) Drawing the foul air out of the bottom of the room into the aspirating chimney; (b) out of the top of the room (Chapter IX). The theory that impure air falls to the floor incorrect (Chapter VII). Method of drawing down pure air through a ventilating shaft. Necessity of heating the column of air in a foul-air shaft to secure its efficient movement. The best plan to build large aspirating chimneys with iron smokestacks passing up through the center to heat the foul air.

LESSON VI.—Ventilation by windows (Chapter X). Inconveniences of such ventilation—dust, smoke, waste of heat, cold drafts, etc. On account of defective plans

for school-buildings, 99 per cent of the school-houses depend on windows and doors for ventilation. Always lower the windows from the top, except when the outdoor temperature is above 80° Fahr., when they may be also raised from the bottom. In very cold or windy weather the windows should be lowered only one inch, or even less; in moderate weather 12 inches, or even more. But all windows should be lowered alike, so as to move all the air in the room; otherwise the ventilation will be very imperfect. If a window is opened too wide in cold weather, a chilly current pours in upon the necks and shoulders of children, and produces colds or rheumatism. If the windows are lowered only slightly, the cold fresh air moves down the surface of the wall and gets warmed somewhat in its descent by contact with the heated air. The devices of oblique boards fastened to the sash (Chapter X). The effects of the wind when strong sometimes require the windows on one side to be nearly or quite closed.

LESSON VII.—The most efficient means of ventilating is a fan or blower (Chapter XII). It should be placed in the flues for fresh warm air (plenum movement), and not in the impure-air shaft (vacuum movement) (pages 79 and 80). The action of Rittenger's fan (pages 84-87 and Appendix C); of the Blackman fan (Appendix F). The method of calculating the efficiency of the aspirating chimney (Chapter XI and Appendix B).

LESSON VIII.—The proper temperature of a room, 70° Fahr. (Chapter XVI). General methods of warming: conduction, i. e., by stove-pipes; convection, i. e., by hot air from furnace or steam-coil; radiation, i. e.,

by open fire-place, standing coil, or stove. Importance of using large stoves or furnaces to avoid the necessity of overheating. The poisonous gases that escape through iron when heated to redness. Great advantage of radiant heat. Nearest to solar heat. Dr. Arnott's smokeless grate; open fireplaces (Chapter XVII). The Ruttan system. Advantages and disadvantages of steam heating (Chapter XVIII). Direct radiation from steam-coils not good for the school-room, because it does not provide for moving the air of the room and for supplying fresh air; warms the same air over and over; difficult to provide for moistening the air; needs a ventilating fan to render it efficient. Prof. Morrison's ideal plan for warming and ventilating; distributes his steam-coils underneath the floor with many small registers opening into the aisles of the school-room; foul air escapes at the top of the room into an aspirating chimney.

CONTENTS.

CHAP.	PAGE
I.—NEEDED INFORMATION	11
II.—THE EFFECTS OF BREATHING IMPURE AIR	17
III.—THE AIR	24
IV.—EXAMINATION OF THE AIR	31
V.—AMOUNT OF AIR REQUIRED	38
VI.—GENERAL PRINCIPLES OF VENTILATION	45
VII.—NATURAL VENTILATION	48
VIII.—INLETS	51
IX.—REGULATING THE DRAFT OF OPENINGS—THE WIND.	56
X.—VENTILATION BY WINDOWS	62
XI.—ARTIFICIAL VENTILATION	70
XII.—THE MOVEMENT OF THE AIR BY MECHANICAL MEANS	78
XIII.—AIR-PROPELLERS	82
XIV.—CAN THE PLENUM MOVEMENT BE AFFORDED?	90
XV.—THE COST OF VENTILATION	97
XVI.—WARMING	104
XVII.—METHODS OF WARMING	111
XVIII.—STEAM HEATING	129
XIX.—AN IDEAL PLAN FOR WARMING AND VENTILATING	144
APPENDIX A.—METHOD OF TESTING THE HUMIDITY OF THE AIR	160
B.—ASPIRATING CHIMNEYS	163
C.—RITTENGER'S FAN (page 84)	166
D.—CONDUCTING POWER OF MATERIAL	167
E.—RADIATING AND ABSORBING POWER OF MATERIALS	168
F.—THE BLACKMAN FAN	169

ANALYSIS OF CONTENTS.

CHAPTER I. *Needed Information.*—Advice plentiful (p. 11); questions to be answered regarding impure air—where found, its causes, its remedies; most of the school-houses in the United States made without attention to ventilation (p. 12); they depend on loose-fitting windows and doors for fresh air; report of the commission appointed by Congress on the public-school buildings in the District of Columbia (p. 13); systems of warming and ventilating in Boston, Denver, London, Vienna (p. 14); authorities consulted, R. S. Roeschlaub, Professors Parkes and Draper, Dr. de Chaumont, General Moran; Dr. Neil Arnott (p. 15) and his labors (p. 16).

CHAPTER II. *The Effects of Breathing Impure Air.*—Symptoms caused by breathing impure air; stupor, headache, etc. (p. 17); not the carbonic dioxide, but the poisonous emanations from the skin and lungs (p. 18); bad air the cause of consumption; authorities and statistics; ventilation on ships; New York Board of Health attributes 40 per cent of all deaths to breathing impure air (p. 21); effect of bad air on the work of the pupils and on their behavior (p. 22); financial waste in neglecting ventilation (p. 23).

CHAPTER III. *The Air.*—*Its composition*: contains carbonic dioxide, even in its pure state, one part in 2,500 (p. 24). *Its impurities*: their dilution in the air, diffusion; ammonia the great supporter of microscopic animals, 200 forms of them found in the air; Koch's and Pasteur's experiments (p. 26); street-dust near the ground contained 45 per cent of organic matter and 30 per cent at a height of 134 feet; ground air unwholesome; air poisoned by stoves and heating apparatus (p. 27). *Humidity of the air*: importance of supplying moisture to air heated in cold weather; the dew-point; 73 per cent of saturation the healthy standard; statistics in hospitals, Washington and Boston; shallow ves-

sels of water on stoves and heating coils or hot-air ducts (p. 30); hygrometers.

CHAPTER IV. *Examination of the Air.*—*Microscopic*: Woulfe's bottles of pure distilled water connected by tubes and an air-pump (p. 32); cultivating solution. *Chemical*: tests for carbonic dioxide, (pp. 33-37).

CHAPTER V. *Amount of Air required.*—One person evolves from 0.4 to 0.7 of a cubic foot of carbonic dioxide in an hour, and vitiates 2,000 to 3,500 cubic feet of air per hour (p. 39); a school-room of average size (28 × 34 × 14 feet) would supply fresh air for less than seven minutes if there were no means of ventilation; how to estimate the amount of air passing through a room (p. 40); air rushes into a vacuum with a velocity equal to what a body acquires in falling five miles; it rushes into a room through a ventilator at a velocity equal to eight times the square root of the height of the exit orifice multiplied by the difference between the out-door and in-door temperatures in degrees Fahr. and divided by 491 (p. 42); the anemometer can measure this; insufficiency of ventilating registers and flues ordinarily in use (p. 44); air should be distributed to all parts of room through many registers.

CHAPTER VI. *General Principles of Ventilation.*—Natural ventilation secured through the tendency of heated air to rise; artificial ventilation secured by mechanical power; illustration (p. 47).

CHAPTER VII. *Natural Ventilation.*—Ventilators should be at the top of the room (p. 48); foul air rises with the heated air and is not to be found at the bottom of the room; Mr. Leeds's experiment not conclusive (p. 50).

CHAPTER VIII. *Inlets.*—Should be placed near the floor; but avoid cold drafts; warm the air before admitting it to the room; downward currents in summer; the inlets for air for 75 children should have an area of 10 square feet, and there should be the same area to the outlet flues, where there is a good aspirating chimney giving a velocity of 7.7 feet per second; the inlets should always be distributed round the room, so that free diffusion may occur; the air furnished from a pure source and drawn from some distance above the ground (p. 54); shapes of cowls or conical caps to the shafts; shafts frequently cleaned (p. 56).

CHAPTER IX. *Regulating the Draft of Openings—the Wind.*—The action of the wind modifies the results obtained: increases the pressure of the air on the windward side of the room; measurement of its amount (p. 57); classification of winds; Dr. Arnott's current-regulating air-valve (p. 58); admission of air at the top of the room; McKinnell's circular tube (p. 61).

CHAPTER X. *Ventilation by Windows.*—Primary office of windows to admit light; secondary office to ventilate; the best ventilators in summer; admit dust and smoke; deflection of currents admitted by means of oblique boards fastened to the sash (p. 64); method of opening windows when the wind is blowing in order to secure fresh air without drafts (p. 66); the best results secured by double windows (p. 68).

CHAPTER XI. *Artificial Ventilation.*—The vacuum movement—aspirating chimneys; a column of heated air moves up the chimney and sucks up the foul air from the school-room through a register; English House of Commons uses aspirating chimneys; pure air drawn down one chimney and foul air drawn up another (p. 72); Montgolfier's formula for calculating the velocity of an upward current in a chimney (p. 74); objection to carrying down the foul-air tubes to the furnace (p. 75); necessity of tall chimneys for ventilating; efficiency of jets of steam in moving air (p. 76); "absolute temperature"; the distance above "absolute zero" which is -459.4° Fahr.; best to combine ventilating-flue with the smoke-chimney.

CHAPTER XII. *Movement of the Air by Mechanical Means.*—Vacuum movement; place in the foul-air duct an extracting fan or blower (p. 79); or let the blower force the fresh air into the room, a better method because it fills the room with pure air, whereas the exhaust fan draws out the air from the room, but does not regulate the quality of the inflowing air; hence impure air may come in through windows and doors as well as fresh air; the "plenum movement" forces the fresh air into the room, the propeller being placed in the inlet duct; the air forced into the room—perflation, blowing through—can be regulated perfectly in all climates (p. 80); the plenum movement by far the best method of ventilating.

CHAPTER XIII. *Air-Propellers.*—Revolving fans used for the most part; Dr. Arnott's ventilating propeller (p. 83); Rittenger's fan (p. 84); Comb's fan (p. 87); Blackman's fan as modified by Hope Brothers; patent of Hendry and others (p. 88).

CHAPTER XIV. *Expense of the Plenum Movement.*—Table of temperatures; number of months that fire is required in twenty-eight cities (p. 91); a thermal unit, the amount of heat required to raise the temperature of one pound of water 1° will raise 48 cubic feet of air 1° (p. 92); 180,000 feet required in one hour in a school-room of 60 pupils; hence, to raise that temperature 35° , the average amount for Chicago, 131,250 thermal units per hour are required; the loss of heat through the walls exposed to external air, for 4 walls, 7,937 thermal units per hour (p. 93); loss

through 6 windows, 3,572 thermal units, making total loss per hour, for fresh air and walls, 142,759 thermal units, requiring 18 pounds of coal per hour; for seven months, a 10-room building would cost \$512, if coal is \$5 per ton (p. 94); this about the actual average cost of fuel in buildings that do not secure ventilation, but use the same air 30 to 60 minutes (p. 95); the heat is ordinarily wasted by windows, doors, too small heating-surfaces, and the failure to introduce warm air at different points in the room (p. 96).

CHAPTER XV. *Cost of Ventilating Apparatus.—Cost of Aspirating Chimney* (p. 97); to secure a velocity of 8 feet per second for the air in the chimney requires 21 pounds of coal per hour, which is 3 pounds more than is required to heat the room, making the aspirating chimney expensive unless heated by the smoke-stack (p. 99); diagram of aspirating chimney heated by smoke-stack (p. 100); such chimneys usually made too small; should furnish at least 6 square feet of sectional area for each room, and for 14 rooms be 9 feet square (p. 101); *cost of the plenum movement* (p. 102); the Rittenger fan requires one horse-power for each room, and 5 to 8 pounds of coal per hour; the Blackman fan and the Hope water-motor fan much cheaper (p. 102); advantages of plenum movement—acts in all weathers and establishes current of fresh air independent of windows or accidental openings (p. 103).

CHAPTER XVI. *Warming.*—Temperature of the room should be 70° for school-rooms (p. 104); with sluggish circulation of blood, a person needs a higher temperature; transmission of heat by conduction, convection, and radiation (p. 105); heaters should be large, so as to avoid overheating of surface; poisonous gases escape from a red-hot stove; stoves, steam-pipes, and stove-pipes heat by conduction; an open fire in a grate heats by radiation; radiant heat the healthiest (p. 106); spectrum analysis (p. 107); sanitary effects of radiant heat—it warms the body without heating the air (p. 108); but warms only one side at a time (109); convection is the method of conveying heat by the movement of currents of warm air (p. 110).

CHAPTER XVII. *Methods of Warming.*—The open fireplace in the City of London High-School (p. 111); Dr. Arnott's smokeless grate (112); description of it (p. 113); would use 4 pounds of coal per hour for a school-room 30 × 30 × 14 feet; Boyd's open fireplace provides for admission of cold fresh air and warming it (p. 114); if stoves are used, large ones should be selected, so as to avoid overheating, and should be lined with fire-brick—long smoke-pipe, extending round the room, so as to economize the heat (p. 116); stoves the cheapest means of warming

known ; Dr. Arnott's self-regulating stove (p. 117) ; smoke consumed by it ; common stove with a drum (p. 119) ; improved stoves by A. M. Hicks and A. Dishman, of Kentucky ; Baltimore Heater (p. 120) ; the Ruttan system discussed ; Smead's invention for mixing hot and cold fresh air (p. 122) ; escape of foul air at the bottom of the room in the Ruttan system (p. 125) ; necessity of strong draft to secure proper ventilation by this system ; waste of heat in the top of room (p. 126) ; necessity of cleansing foul-air passages ; mistakes or neglect of builders.

CHAPTER XVIII. *Steam-Heating.*—English House of Commons heated by means of furnace-warmed air, on a modified plan of Dr. Reid (p. 129) ; hot-air-chamber beneath the floor, foul-air flues at the top of the room ; amount of heat conveyed by steam ; experiment to prove the ratio of latent heat in water to sensible heat (p. 132) ; upon condensation, all the latent heat of steam becomes sensible heat ; Mr. Holly's method of insulating steam-pipes ; 1,600 feet of 3-inch pipe lost by radiation only 2½ per cent (p. 134) ; one pound of coal converts 9 pounds of water into steam, and realizes 8,640 thermal units ; hence 16.66 pounds of coal necessary to supply a room for an hour, being 2 pounds less than by furnace heat (p. 136) ; direct radiation by steam-coils condemned, unless ventilation is provided ; plan of room with proper ventilation (p. 138) ; Washington school-buildings heated by direct radiation and without ventilation (p. 139) ; steam-pipes extending round the sides of the room near the floor (p. 140) ; heating of same air over and over ; indirect radiation by steam-coils placed beneath the floor, and fresh air warmed by passing over them and into the school-room ; needs a good aspirating chimney or a ventilating fan ; steam radiators placed under windows, in order to counteract cold currents, or near the inside walls of the room, to save loss of heat (p. 143) ; but the heat ascends to the top of the room, and is not distributed properly.

CHAPTER XIX. *Ideal Plan for Warming and Ventilating.*—The feet should be kept warmer than the head (p. 145) ; plan described for warming and distributing fresh air through the floor (p. 146) ; chimney 8 feet square, with foul-air flues opening into it from the tops of rooms ; fresh-air shaft bringing down the air from the top of the building ; registers along the aisles by the side of the desks (p. 148) ; method of cleansing the registers (p. 150) ; method of creating a draft in warm weather (p. 152) ; three pipes to regulate the amount of heat supplied (p. 153) ; double joists in the floor necessary for this plan ; sufficient ventilation without resort to the windows ; plan of 16-room school-house, two stories in height (p. 156) ; chimneys placed between the rooms ; iron ladders inside

the chimneys (p. 157); one half size for 8-room building; plan for a 6- or 12-room building (p. 158).

APPENDIX.

A. Mr. Glaisher's observations on dry- and wet-bulb thermometers; his factors for testing the moisture of the air (p. 161).

B. Simple form of aspirating chimney (p. 164); formulæ for calculating its efficiency.

C. Formulæ for constructing Rittenger's fan (see pp. 84-87).

D. Conducting powers of materials; copper more than twice the conducting power of iron and zinc, and nearly five times that of lead; 19 times as great conducting power as marble; 100 times that of brick; 300 times that of oak.

E. Radiating and absorbing power of bodies; silver lowest and oil highest (p. 168).

F. The Blackman fan with author's improvements; drawings showing formation of the blades (p. 170); description of devices to prevent back-flow of air (p. 171).

P R E F A C E .

THE following pages are not intended to "fill a long-felt want." The greatest necessities are often not felt as wants. If an individual suffers from a cause which is unknown to him, he feels no want, necessarily, to remove that cause. If a man sickens from a want of pure air, without knowing the cause of his ailment, he never longs for a more salubrious atmosphere as a cure.

I am fully convinced that people are prematurely dying by thousands simply from a lack of correct and positive convictions concerning impure air; for, when the true nature of a danger is fully appreciated, the requisite means to avert it will generally be found.

Every teacher, or other person who works in a vitiated atmosphere, has doubtless noticed the peculiarly exhilarating effect of going into the open air after a day's indoor confinement. My own experience in this respect is so marked that I seldom step from a crowded room into the open air without reflecting on the nature of that invisible cause which made possible a change so sudden and so marked. This reflection is always followed by the mental query: Can not this great difference between the qualities of outdoor and indoor air be remedied?

This experience, together with almost daily observation of the attempts of builders to ventilate houses, wherein the simplest physical laws are commonly ignored, has led to the writing of these pages.

The work is confined to the consideration of school-buildings for three reasons: 1. I am better acquainted with the needs and present condition of school-houses than of any other class of buildings. 2. These buildings, because of crowded occupancy during successive days, are most in need of perfect ventilation. 3. Knowledge of the correct principles of school-house ventilation is knowledge equally applicable to all buildings, as the same principles underly all.

Correct theories and their successful application to the arts of life can not be conceived and executed in a day. Our knowledge of warming and ventilating is a growth to which each generation has probably in some measure contributed. Any contribution, therefore, to be of value, must be made in the full light of what has preceded it. In preparation for the present task, therefore, I have carefully read the writings of the following authors who have contributed to this subject: Parkes, de Chaumont, Ritchie, Hood, Morin, Edwards, Eassie, Reid, Arnott, Tomlinson, Billings, Galton, Leeds, Schumann, Baldwin, Draper, and Lincoln. I also procured from the United States Patent Office drawings and specifications of thirty-different ventilating appliances which have from time to time been patented. Whatever the Bureau of Education has furnished has also been read. The best, therefore, that has been thought or done on this subject has been carefully studied, and whatever is valuable has become assim-

lated into this work, in so far as it informed, invigorated, and corrected my own thought.

The chapter on window-ventilation will, I think, be useful to teachers. While windows at best can furnish only partial and imperfect ventilation, it is only by their skillful management that even so much may be realized from them.

The discussion in this book of some of the modern systems of warming and ventilating is made from an independent and unbiased study of their merits, and without any interest in advertising either their excellences or their defects.

The ideal plan described and illustrated in the last chapter was not conceived until nearly all preceding it had been written. It may be regarded, therefore, as the result of a long and exclusive application to the subject.

For valuable suggestions, I wish to acknowledge my obligations to Prof. Wm. Jones, Professor of Chemistry in the Kansas City Medical College, for reading the manuscripts on the chemical examination of the air; to Prof. L. Wiener, of the Kansas City High School, for reading the mathematical discussion of ventilating fans; and to Prof. J. M. Greenwood, Superintendent of Kansas City Schools, for reading the same and other portions of the manuscripts.

G. B. MORRISON.

Kansas City, Mo.

VENTILATION AND WARMING OF SCHOOL-BUILDINGS.

CHAPTER I.

NEEDED INFORMATION.

ADVICE regarding "fresh air" has not been lacking in amount. Even the most ignorant have some indefinite notion that there is such a thing as "bad air," and that it is not good to breathe it. Teachers of hygiene proclaim to pupils the virtues of pure air, shut up in school-houses where it is impossible to get it. Physicians advise their patients to take fresh air, and this by going out of doors; thus tacitly realizing that it can not be found indoors. Preachers in churches, where deadly gases from the lungs and poisonous organic emanations from the skin are imprisoned from week to week, emphasize the importance of properly preserving the physical body. There is a universal recognition that it is bad to breathe impure air; there is an ignorance no less universal of the conditions of how to avoid it. When the nature and composition of a deadly drug are known and marked "Poison," it is properly avoided. In the next section we shall see that much of the air we breathe should be labeled with skull and cross-bones.

Where is the impure air? What makes it impure?

What are the nature and amount of the impurities? These are important questions which, among the educated, are tolerably well known. But when these impurities exist in an occupied room, how are they to be eliminated and replaced by pure air of the proper temperature? These are questions which are no less important; but they are questions which are seldom answered. How to know where impurities exist; how to expel them as fast as formed, and supply their place with the pure, life-giving element, is a problem second in usefulness to none other. Of the difficulty of the problem we have ample evidence in the fact that it has been but partially solved, and in general practice almost wholly ignored. True, we hear men talk of "good ventilation" and "poor ventilation," but how little this generally means we hope, at least partially, to show in the pages of this little book.

Of the lack of definite information on this all-important subject we have abundant evidence. We often hear the questions: "What is the best way to ventilate a school-room? Where should the foul air escape? Where should the pure air be admitted?" These questions, among the first to be met in ventilation, show that even the first principles of matter and its properties are not commonly applied to the gas we call air.

The school-houses throughout the United States, while they are elegant, tasteful, and costly, are in the main deficient in their sanitary requirement of warming and ventilating. Whoever may be disposed to doubt the truth of this statement has but to visit the nearest school-house. Probably in nine tenths of all the school-houses in this country ventilation has been ignored altogether, leaving that important function to be performed by the doors and windows. But ventilation should be independent of

doors and windows, which are primarily intended for other purposes. How many school-rooms in the land could maintain a school with doors and windows made air-tight? Probably very few, and in the majority suffocation would result in less than thirty minutes! It is a sad travesty on our school architecture that we owe our lives to the mistakes of carpentry, which mistakes are usually sufficiently ample to supply, in a crude, unwholesome, and unsatisfactory way, the deficiencies of direct ventilation.

This want of sufficient and definite information regarding the ventilation of school-houses is not peculiar to any locality; it is wide-spread and general. Even the District of Columbia, which is under the direct control of the Central Government, experiences the embarrassments which this all-important but vexed problem presents. By a resolution of the House of Representatives, dated February 20, 1882, a commission was appointed for the purpose of investigating the public-school buildings of the District of Columbia. A few quotations from the report of this committee will be to the point: "The principal defect, from a sanitary point of view, in all these buildings is in regard to the fresh-air supply, which is entirely insufficient. The method adopted for this purpose is to admit the air through a perforated plate placed beneath the sills of four windows in each room. Having passed through this plate, the air is supposed to pass downward through a narrow slit in or behind the wall, and to enter the room at a level with the floor and then pass up through a steam radiator which is placed against the window. The sum of the clear opening in the external plate of each window is from twenty-two to twenty-five square inches, so that the area of clear opening for the supply of pure air to the room is from eighty-eight to

one hundred square inches, giving an average of about two thirds of one square foot. When it is remembered that this is intended to supply fresh air for sixty children, each of whom should have as a minimum thirty cubic feet of air per minute, it will be seen that it is simply impossible to obtain such a supply through the openings provided, which in fact will hardly furnish five cubic feet per minute per pupil."

This report has not been quoted from to show the best that has been done in school-house ventilation, but rather what may be considered a fair representation of the average state of affairs throughout the country.

Something toward a rational system of warming and ventilating is said to have been accomplished at the Boston High School; also at Denver, in this country; but more especially at the City of London High School, and the High School of Vienna, in Europe.

When first contemplating the preparation of this volume, I thought to write to several superintendents, in cities having a reputation for good school-houses, asking them to furnish me with descriptions of their system of heating and ventilating, that I might use them as a feature of my work, incorporating them as models of the best modern types of school-house architecture. Some answered by sending a pamphlet in which ventilation is barely referred to; others by letter; but the average significance of them all may be given in the exact words of one of them: "Our high school is a showy building on the outside, but it is not well warmed and ventilated."

Few things are more needed than a systematic dissemination of the best that is known of proper methods of ventilation, as well as stimuli to investigate the underlying principles. A subject so vital to the health and safety of the growing generation should be investigated by every

teacher of physics, and the known laws of fluid pressure and motion be directly applied and taught. It should be a theme for the educated physician, whose duty it is not only to cure disease but to prevent it. It should be the duty of every school-house architect not only to make the best practical use of the best that is known on the subject, but to furnish annual reports of the conditions of the school-buildings, a description of each building, the cost, method of warming and ventilating, the air-space for each pupil, the percentage of heat which is utilized in the consumption of fuel, etc. The people's right to information on any subject should be measured by the value and indispensableness of the information; and surely nothing is of more universal importance than the air we breathe, affecting as it does our health, life, and future condition.

The importance of this kind of information has not been wholly ignored. The Denver report of 1883 contains a chapter on school architecture in which the studious labors of the architect, Mr. Robert S. Roeschlaub, are laid down for the consideration and enlightenment of the public. Many valuable hints on the general subject of warming and ventilating have been given by different writers on hygiene, among whom may be mentioned Professors Parkes and Draper. From a purely scientific standpoint probably the most has been done by Dr. de Chaumont. The governments of France and England have contributed much knowledge on the subject by health commissions appointed to investigate the sanitary conditions of barracks occupied by soldiers; the reports of General Moran being especially valuable. But it is to Dr. Neil Arnott, the famous Scotch educator and physician, that humanity owes most for practical knowledge on warming and ventilating. Deeply versed in physics,

being the author of a valuable text-book on that subject, he understood the principles and laws underlying the subject. A physician, being one of the most eminent in the realm, he well understood the vitiating effects of impure air. A practical inventor, he put his theories in practice by inventing many heating and ventilating appliances, among which may be mentioned the Arnott stove, the smokeless grate, and an automatic valve for admitting fresh air to fire-places. A philanthropist, he gave his thoughts and inventions to the world free of charge, refraining always from securing patents and copyrights. He did not overlook the needs of the schools; he applied his principles to the "Field Lane Ragged School"—by a method to be noticed hereafter—with excellent results.

A little reflection will answer why a teacher should undertake to contribute to this important subject. The heaviest blows in any cause have always been struck in self-defense. The teacher is defending himself in endeavoring to better the atmospheric condition of the school-room where he spends the most of his active life. Whatever may be said in the defense of children who are submitted to the contaminating influences of an impure atmosphere, the same may be urged with tenfold emphasis in the defense of teachers; for while the pupil's school life lasts only a few years, the teacher's term is a life-time. While it is the duty and desire of all good men to help others, the sternest efforts are always made in the direction of self-preservation, which, if successful, will increase the capacity to help others. I offer no apology, therefore, for contributing to a subject in which all humanity, and especially all teachers, are so deeply interested.

CHAPTER II.

THE EFFECTS OF BREATHING IMPURE AIR.

NONE except he who has given special study to the facts begins to realize the injurious effects of breathing impure air. Every one knows that a disagreeable feeling accompanies the breathing of impure air; that a feeling of stupor; inactivity, drowsiness, and sometimes nausea, headache, and vertigo, result directly from the occupancy of ill-ventilated rooms. These sensations are temporary, and are experienced only while the cause is active, and usually the only thought is to temporarily relieve the inconvenience by a recess or a break for fresh air. Seldom do persons reflect on the ulterior effects of these violations of Nature's laws, and when the outer air is reached, and long draughts of the pure element relieve the depressed sensations, and send the invigorating oxygenated life-blood current coursing through the system, raising the spirits and clearing the brain, their reflection usually end with relief, and, when more or less resuscitated and rescued from the fatal stupor (I use the phrase advisedly), the unsuspecting victims crawl back into their "Black Holes," again to fill the system with gaseous poisons, thinking of it only as an unpleasant duty, the immediate endurance of which will bring subsequent freedom and relief. But this is a great mistake; the temporary suffering consequent on the act of breathing vitiated air is but a small part of the objection to be urged against it. The principal charge against the breathing of impure air is that it sows the seeds of disease and death, the length of time in which the subject will succumb being in proportion to his strength and power of endurance.

No subject has been more carefully and intelligently studied than the direct and ultimate effects of impure air on the human system, and on no subject is there more unanimity of competent opinion. Besides the general debilitating and weakening effects, which render the system susceptible to infectious diseases, breathing impure air is believed by the best authorities to be a direct cause of phthisis (consumption) and its accompanying diseases—catarrh, bronchitis, pneumonia, and many others.

The individual effects of breathing separately the foreign gases usually found in the atmosphere need not be considered here, but it is their combined effect, combining as they do with organic emanations from the skin and lungs, that chiefly concerns us in considering the effect of impure air made so by respiration. Carbonic dioxide, CO_2 , is commonly considered the poisonous substance in the atmosphere; this is in the main untrue, for moderately large quantities, when pure and mixed with air, can be breathed with impunity. CO_2 , by its inability to support life, will produce asphyxia by shutting out the needed oxygen, but it can not be regarded as a poison. Substantially the same conclusions have been reached by Demarquay, Angus Smith, W. Müller, Eulenberg, and Hirt, all of whom have made close investigations. It is when mixed with the organic emanations from the skin and lungs that the poisonous quality seems to be present; and Gavarret and Hammond found that the organic matter when taken alone is "highly poisonous." It seems, therefore, that the principal poisoning agents in impure air are organic. Nevertheless, the amount of CO_2 in the air is highly important, for its presence is a very good index of the amount of the organic impurities, and to measure the percentage of CO_2 is indi-

rectly to measure the degree of vitiation of the air. (See Examination of the Air.)

On the disease-producing effects of air rendered impure by respiration we have a host of authorities. The following statistics are from the English sanitary record, given by Ransom, showing the comparative death-rate from pulmonary diseases in different localities where the relative impurities are known to vary in about the same ratio as is shown in the death-rate. For all England, 1865-'76, 3·54; for Salford, 5·12; Manchester, 7·7; Westmoreland, one of the healthiest counties, 2·27; North Wales, 2·51. It is, of course, not to be forgotten that other causes, such as intemperance, insufficient and improper food, sedentary pursuits, etc., also conspire in these unfavorable localities to produce the final result. "But," as Dr. Parkes remarks, "allowing the fullest effect to all other agencies, there is no doubt that the breathing of the vitiated atmosphere of respiration has a most injurious effect on the health." Consumption is commonly attributed to sudden and undue exposure to wet and cold, want of sufficient food, clothing, etc., but Baudelocque says that "impure air is the great cause of consumption, and that hereditary predisposition, uncleanness, want of clothing, bad food, cold and humid air, are by themselves non-effective." The following paragraph from Parkes's "Hygiene" I copy for the weight of authority in the eminent names mentioned therein:

"Carmichael, in his work on 'Scrofula' (1810), gives some most striking instances where impure air, bad diet, and deficient exercise concurred together to produce a most formidable mortality from phthisis. In one instance in the Dublin House of Industry, where scrofula was formerly so common as to be thought contagious, there were in one ward, sixty feet long by eighteen feet

wide, thirty-eight beds, each containing four children; the atmosphere was so bad that in the morning the air of the ward was unendurable. In some of the schools examined by Carmichael the diet was excellent, and the only causes for the excessive phthisis were the foul air and the want of exercise. This was the case also in the house and school examined by Neil Arnott in 1832. Lepelletier also records some good evidence. Prof. Alison, of Edinburgh, and Sir James Clark, in his invaluable work, lay great stress on it. Neil Arnott, Toynbee, Guy, and others, brought forward some striking examples before the Health of Towns Commission. Dr. Henry MacCormac has insisted with great cogency on this mode of origin of phthisis; and Dr. Greenhow also enumerates this cause as occupying a prominent place."

Gavin Milroy, in his pamphlet on the "Health of the Royal Navy," expresses his belief that the extraordinary mortality from consumption on some of the ships was due mainly to improper ventilation. The writer on the subject of "Consumption" in "Chambers's Encyclopædia" says: "Among the determining causes of consumption in large populations the best ascertained are those connected with overcrowding and *bad ventilation*." Langenbeck, an eminent anatomist, says that the prime cause of consumption is breathing impure air.

Impure air is also believed by the best authorities to be one of the principal causes of epidemics. Dr. Carpenter, than whom there is no abler authority, says: "It is impossible for any one who carefully examines the evidence to hesitate for a moment in the conclusion that the fatality of epidemics is almost invariably in precise proportion to the degree in which an impure atmosphere has been habitually respired." The Board of Health of New York conclude that forty per cent of all deaths are caused

by breathing impure air. In view of such alarming facts, this same board declares: "Viewing the causes of preventable diseases, and their fatal results, we unhesitatingly state that the first sanitary want in New York and Brooklyn is *ventilation*." Direct experiment described in another place, no less than the direct evidence of the senses, proves that the air in our school-rooms is impure in almost all cases, and in a majority of them to a degree far beyond the danger line.

In view of these facts, and the results as proved by the authorities above cited, why is it regarded by the public with such indifference? When a school-house is blown down by a hurricane, killing and maiming a score of children, it is justly regarded as a great calamity; a vacation is given to quiet the excited fears of parents and children; investigating committees are appointed to locate the responsibility, and the faces of the whole populace are blanched with apprehension. Why is this? Why does the intelligent parent send his child to a school-room poorly ventilated and crowded with children, some of whom are breathing into a stagnant air the germs of disease and death, while others, from unwashed bodies, are delivering into it their deadly emanations, and all without a protest on the part of those even who provide proper hygienic conditions at home? It is because the effects of the one are immediate, occupy little time, the number killed can be actually counted, and the exact magnitude of the calamity estimated all at once. In the other case the process is slower, but of far greater extent; the actual results are by the general public less definitely known, and custom and attention to other matters divert the attention, and the deadly destruction of the innocents by impure air goes on silently, constantly, and powerfully. While noisy demonstrations

like that of the cyclone attract attention, and inspire fear and terror, it is in the silent forces that the danger lies. Nature's most destructive forces, as well as her strongest constructive ones, are silent in their operations ; but when Science detects a silent, insidious enemy to human welfare, it is not only our duty to assume an attitude of self-defense and self-protection, but it should be regarded as folly not to do so. Could the real effects of breathing impure air be fully realized by the public, and the actual amount that is really breathed be definitely known, such a knowledge would constitute a most powerful stimulus toward solving the problem of ventilation, as well as create a disposition to provide the means necessary thereto.

The effects of breathing impure air thus far considered are pathological, but it has its pedagogical and economical aspects. Every observing teacher knows the immediate relation between the vitiated air in the school-room and the work he wishes the pupils to perform. Much of the disappointment of poor lessons and the tendency to disorder are due directly to this cause. The brain unsupplied with a proper amount of pure blood refuses to act, and the will is powerless to arouse the flagging energies ; the general feeling of discomfort, dissatisfaction, and unrest which always accompanies a bad state of the blood breeds most of the school-room squabbles, antagonism, misunderstanding, and dislike which are wont to occur between teacher and pupil. The pupil apparently at variance with his teacher is really at war with his own feelings, caused by an impure and stagnated condition of the blood. The teacher who sometimes thinks the pupils are all conspiring against him, and who, with dizzy and clouded brain, says the wrong thing at the wrong time, is really struggling with the poison which, on account of his long seclusion from the cheerful air, has

taken possession of him. Teachers observe how much more satisfactory is the work of the first hour of the day than that of any subsequent hour ; this is not because of weariness of the pupils, it is because they are made stupid and obtuse, and the teachers made uneasy and fretful, by the accumulating poisons from skin and lungs.

From an economical standpoint it would, of course, be impossible to estimate the financial waste of breathing impure air, but it can not but be enormous. In a comfortable atmosphere of proper temperature and purity as much mental labor can be accomplished in one hour as can be accomplished in six in an atmosphere rendered impure by respiration. This is, of course, but a random estimate, but I am quite sure that whatever of error it contains is on the side of underestimating the deteriorating influences of impure air rather than of overestimating the value of pure air. If, then, we suppose perfect ventilation possible, and that this estimate is not overdrawn, the conclusion follows that in those school-rooms where ventilation is imperfect and the air impure six sevenths of the money expended to educate a child is wasted. Doubtless this will appear to some as an exaggerated statement ; but, if we accept the premises (and this will readily be done by all who have tried to think in an unventilated room), the conclusion is inevitable. This conclusion supposes that perfect ventilation costs no more than imperfect or no ventilation ; while this is not strictly true, the difference is insignificant when compared with the loss we are considering. In any discussion of the feasibility of incurring the additional expense of the most perfect ventilation, this loss occasioned by the want of such ventilation must not be ignored.

CHAPTER III.

THE AIR.

The Composition of the Air.—The gaseous envelope which surrounds the earth, and which we call air, is one of the conditions of animal and plant existence. It is evident, therefore, that a definite knowledge of its composition and properties is all important. In order to investigate the abnormal conditions which often prevail, with a view to correcting them, we must first know the normal conditions.

The air is composed mainly of two gases, oxygen and nitrogen, in the proportion of about 21 of the former to 79 of the latter. The following, from Parkes's "Hygiene," is probably as exact as has yet been ascertained :

Oxygen.....	209.6	per 1,000 volumes.
Nitrogen.....	790.0	" " "
Carbonic dioxide (CO ₂)....	.4	" " "
Watery vapor.....	Varies with the temperature.	
Ammonia.....	Trace.	
Organic matter.....	} Variable.	
Ozone.....		
Salts of sodium.....		
Other mineral substances. }		

Pure air is usually considered as consisting exclusively of oxygen and nitrogen, all other elements existing as impurities in it. But as the air is a mixture of the constituents, and not a chemical compound, and as the proportion of these elements is variable, it seems more reasonable to regard as the true normal air that proportion of the different elements which best conserves the ordinary uses of air in the support of plant and animal life. Without the CO₂, small though it be, the air would

be wanting in that constituent which plants most need ; and a certain amount of watery vapor is equally indispensable for the use of animals. It seems, therefore, that CO_2 and watery vapor, in the proportions above mentioned,* are really as truly constituents of air as oxygen and nitrogen.

Impurities in the Air.—There are many substances, in many forms and from various sources, constantly passing into the air, tending to make it impure and unfit for respiration. Of these, those which more especially concern us in consideration of the condition of our school-houses are vapors and gases from the skin and lungs, principally CO_2 and vapor of water ; solid particles of sealy epithelium from the skin, fibers of cotton, wool, etc., bits of hair, wood, coal, chalk-dust, and many other things which have a tendency to enter the blood through the delicate air-cells in the lungs, if gaseous, and to lodge in the air-passages or be drawn into the lungs if solid, there to irritate by their presence, and poison the system by their decay.

But Nature, when not hampered by man, has provided a compensation for this poisoning process by a counter process of purification. The winds scatter the impurities, diluting them with large quantities of air, oxidizing them into simple compounds, and rendering them harmless. The tendency which gases have to diffuse causes poisonous substances to be rapidly diluted, to such a degree as to destroy their destructive power. It is evident, then, that wherever the contaminating process is active there also should the purifying process be active. Wherever an unusual amount of unwholesome matter is being

* The exact amount of watery vapor in the air which best serves the purposes of respiration is not definitely known, but, as far as ascertained, it is considered to be about seventy per cent of saturation.

evolved, there especially should the purifying conditions be present; air in such places, to remain pure, must be changed in rapid succession, in order that dilution, diffusion, and oxidation may fulfill their legitimate functions. In a school-room the contaminating process can not but be rapid, and wherever ample provision is not made for rapidly changing the air of the room a dangerous condition of affairs is sure to exist.

In addition to the inorganic substance suspended in the air there is a vast number of organized bodies. While some of these organisms are to be found in pure air, they are vastly more numerous in impure air, and more especially in that impure air made so by animals. Ammonia seems to be the great supporter of the countless hosts, so much so that the amount of this gas found present in the air at any time and place is thought to be a fair indication of the relative number of organisms there present. More than two hundred distinct forms of microscopic animals have been discovered in the atmosphere* (Ehrenburg). The precise effect of these organisms on health is not known, but it is generally believed the effect is detrimental. Bacteria of many forms, and spores of fungi, are also found in the air, and all these organisms are known to thrive in the organic impurities found in the air. Pains-taking investigations as to the disease-producing power of these organisms have been in progress within the past few years by Drs. Koch and Pasteur, and while it is generally believed that these organisms and certain diseases are related as cause and effect, no definite germ theory of disease has yet (1886) been accepted by the medical profession. The facts that are known, how-

* The presence of organic matter in the air may be shown by the *aëroscope*, or by forcing air through strong sulphuric acid, when, if present, the organic matter will turn the acid dark.

ever, and in which we are here interested are : That a large number of impurities exist in the air—that these impurities congregate in inclosed, unventilated spaces where they are produced, and that they have a detrimental influence on the health.

The external air from which the school-room must be supplied has impurities peculiar to itself and to the locality whence obtained. Dust and smoke exist in the air in large quantities, as well as the products of decaying organic matter from the surface of the earth. Equal quantities of these impurities are not found in all parts of the air. Dust and smoke, owing to their tendency to settle, will be found in larger quantities nearest the earth. In a series of analyses on street-dust, at different elevations, Tichborne found that the amount of dust was not only inversely proportional to the elevation, but that the percentage of organic matter that it contained decreases with the elevation ; street-dust near the ground containing 45·2 per cent of organic matter, and that at the top of a pillar 134 feet high only 29·7 per cent. The same must be true as to the relative quantity of organic impurities at different elevations. Gases rising from decaying matter on the earth must rise a certain distance before they can come into contact with sufficient pure air to dilute and diffuse them. The reason why “ground-air” is unwholesome is thus seen to be evident. The importance of these facts will appear when we come to consider the source of the fresh-air supply in ventilation.

There are other sources of impurities, not to be overlooked, always existing in rooms heated by stoves or by the direct radiation of steam-pipes. The most serious of these is found in the use of stoves, which give off, when hot, a poisonous gas. The blue flame sometimes noticed in stoves, when coal is first put in, is due to the burning

of carbonic monoxide—CO—a very poisonous gas. Iron, when moderately hot, is not pervious to this gas, which then passes harmlessly up the chimney; but, when strongly heated, iron loses the power of retaining it, becomes pervious, and allows the poisonous gas to escape into the room.

Another source of impurity, which is common both to stoves and to steam-pipes, where the latter are exposed, is in the burning and charring of small particles of organic matter which settle on them. This burning is known to have a very injurious effect on the breathing qualities of air in a room, and should be remembered when considering the choice of the method of heating.

Humidity of the Air.—The quantity of watery vapor found in the air varies with the locality, temperature, and various local conditions, and is important from a sanitary point of view. The right proportion of moisture in the air constitutes one of the conditions of a healthy climate. In the heating and ventilating of buildings, where the proper proportion of watery vapor is found not to be present, it may be supplied by artificial means. A knowledge, therefore, of the proper conditions of humidity, as well as a knowledge of the means of supplying them when absent, is thus seen to be important.

In crowded school-rooms the symptoms of fainting often evinced by pupils is thought to be partly or wholly due to an insufficient amount of moisture in the air of the room. Other physiological symptoms of an atmosphere too dry are parched lips and tongue, a dry, feverish condition of the skin, and, in those children predisposed to lung diseases, a hacking cough, resulting from the desiccating effect of excessively dry air on the lungs and bronchial tubes.

The drying power of air depends not so much upon the actual quantity of moisture already in the air, as upon the capacity of the air, under certain conditions, to receive more; these conditions being mainly the variations of temperature. If the air of a room containing a certain amount of moisture be raised in temperature several degrees, its capacity for more moisture may be much increased, while the actual amount already present may not be materially diminished. Hot air expands, and is thereby rendered thirsty, greedily extracting water from everything moist with which it comes in contact. Air at any temperature, when it contains as much vapor of water as it can hold without depositing it in the form of dew, fog, etc., is said to be saturated, but it is plain that air which is saturated at one temperature will cease to be so at a higher temperature unless more moisture be added. This point of saturation is called the dew-point. The dew-point—the temperature at which the vapor in the air condenses—is, therefore, variable, and always dependent on the amount of vapor of water in the air. The dew-point is taken as the standard in estimating the humidity of the air, and is taken as 100 per cent.

The sanitary condition of the air, as influenced by humidity, has not received the attention that its importance demands, yet enough has been done to enable us to estimate within limits fairly narrow. Dr. de Chaumont, in some experiments in various rooms containing air of standard respiratory purity, found that the average humidity is 73 per cent of saturation. This, it must be remembered, was taken in England, where the climate is much more moist than that of America. Probably an humidity somewhat less would answer for our climate, but in any case a given standard must be regarded as only provisional, changing with the temperature of the room

at the time of testing ; 63° Fahr. was the temperature used in the experiments of de Chaumont.

Some observations have been made in this country by D. L. Huntington at the Barnes Hospital, Washington, and by Dr. Cowles at the Boston City Hospital. The results are as follows : “ First week in December, 1877. Average external temperature 38½° ; average temperature of the wards, from 71° to 76° Fahr. Average relative humidity, from 44 to 49 per cent of saturation ; of outer air, 74.” This, it will be noticed, shows a much lower per cent of moisture in the room than that given by the English standard, yet it was claimed that notwithstanding this small quantity “ a peculiar feeling of freshness and purity was perceived by those who entered the room.”

This “ peculiar feeling ” which is always experienced in passing into a warm room in winter is, I think, hardly a trustworthy test of the atmospheric purity ; and it seems further unreasonable to suppose that the best sanitary conditions would admit so great a difference as 74 and 44 per cent between the outer and inner air. This opinion will be further strengthened if we accept the statement of Dr. Parkes, that “ warmth and great humidity are borne on the whole more easily than cold and great humidity.” There is little doubt that some difference exists in the amount of atmospheric moisture required by different individuals, but arrangement should always be made to suit the average needs of the majority. From what I have been able to learn from study and observation, I believe that 70 to 75 per cent may safely be taken as a provisional standard of humidity for the air of school-rooms.

In rooms where the air is too dry, it may be moistened in winter by placing shallow vessels of water on stoves, on heating coils of steam or hot-water pipes, or in the

hot-air ducts. In summer, moistening by artificial means will seldom be required, but when, on account of unusual dryness of season, the conditions so require, it may be done by sprinkling floors (not a very advisable method), or by ejecting cold water in spray through a series of small holes.

The humidity of the air may be determined directly by means of an hygrometer, or indirectly by means of wet and dry bulb thermometers. In most hygrometers a bright surface is cooled till dew is deposited thereon, and the temperature then noted. Owing to the sensitiveness of hair to changes in humidity, it is sometimes made use of as an hygrometer; hair shortens in dry and lengthens in moist air; and if a hair be fastened by one end to an inflexible support and the other end attached to one end of a needle hung on a pivot, the other end of the needle moving over a graduated scale, it will form a tolerably accurate measure of humidity. The method used by me is that of the wet and dry bulb thermometer with Glaisher's factors. (See Appendix A.)

CHAPTER IV.

EXAMINATION OF THE AIR.

Microscopic.—The microscopic examination of bodies suspended in the air is rapidly growing in importance. While the work may still be regarded as in its infancy, much has been done by Koeh, Pasteur, and others, toward determining the effect on the health of organic microscopic bodies in the air.

It is, of course, not to be expected of one who is merely testing the respirability of the air in a school-

room to search for specific disease-producing germs ; but as large quantities of dust, smoke, etc., suspended in the air, tend to make it irrespirable in proportion to the amount of these impurities existing therein, a knowledge of the relative quantity of suspended matter, as well as the nature of it, becomes a necessary part of the work of testing the fitness of air for respiration. A fair knowledge of the respirable quality can be obtained without microscopic tests ; but as these observations are otherwise interesting and instructive, I here describe the method used by me, which is only one of the many now in use by microscopists.

Arrange a series of Woulfe's bottles containing *pure distilled* water, connected by tubes, and pass through this the air to be examined. The air in passing through the water leaves its suspended particles in the water, a drop of which can be examined under the microscope. If the water was *pure distilled*, all matter found in it in the experiment came from the air.*

As a means of passing the air through the water, an air-pump or aspirator may be used. I use an air-pump which is so constructed as to admit the easy attachment of a small tube. The cubical capacity of the cylinder being known, the amount of air drawn through the water may be found by multiplying the capacity of the cylinder by the number of strokes. Should such a pump not be accessible, an aspirator may be made by taking a tin vessel of known capacity, with an opening at the top to receive the tube, and a tap below to let out the water. Fill this with water, attach the tube and open the tap ; as the water runs down, the vessel will be filled with air drawn through the water.

* It is not, as some suppose, a native characteristic of water to contain "live things." Pure water is absolutely devoid of everything except its two constituent elements, oxygen and hydrogen.

The nature of the organisms in the air can be further studied, if desired, by passing the air through a cultivating solution, which is set aside and the germs carefully studied from day to day as they develop. A solution of isinglass, two parts in 400 parts of pure distilled water (Fodor), makes a good medium.

Chemical.—A complete analysis of impure air comprehends the quantitative and qualitative tests for carbonic dioxide, CO_2 , free ammonia, NH_3 , and other nitrogenous matter, oxidizable matters, nitrous and nitric acids, and hydrogen sulphide, H_2S ; but for ordinary practical purposes the determination of the CO_2 is by far the most important, and is ordinarily the only one which need be made. While the poisonous qualities of the air are not wholly due to the presence of the CO_2 *per se*, the amount of this gas found to be present is, in air made impure by respiration, generally a good measure for other impurities to which the poisonous quality is principally due. Owing to this fact, a careful test for the amount of CO_2 contained in a given atmosphere is generally the only one which need be made where air is tested merely to determine its respiratory purity.

The mere presence of CO_2 in the air may be tested by exposing baryta-water in a shallow open dish; if CO_2 is present, a white deposit of barium carbonate will be formed on the surface of the liquid, the amount and rapidity of the formation being proportional to the amount of CO_2 in the air. The exact proportion of CO_2 in a given quantity of air may be determined by different processes; but that of Pettenkofer, which is familiar to me by use, is probably as good as any. Briefly it is as follows: Take a glass bottle of about one gallon capacity— $4\frac{1}{2}$ litres; fill the bottle with water in the place where the air is to be tested. Pour out the water, allowing it to drain. This expels the

air formerly in the bottle, and fills it with the air of the room. Now pour into the bottle 60 c. c. (cubic centimetres) of clear lime- or baryta-water; close the mouth *air-tight*, and shake. Allow this to stand eight hours if lime-water, or one hour if baryta-water. The CO_2 will all be absorbed by the water, the causticity of which will be lessened in proportion to the quantity of CO_2 in the vessel; the CO_2 , being acid, neutralizing the lime by forming a neutral carbonate. If now the causticity of the water be known before and after the CO_2 has been united with it, the difference will show the amount of lime which has united with CO_2 . To find the causticity of lime, prepare an oxalic-acid solution.* Take 30 c. c. of fresh lime-water, like that used in the first part of the experiment, and mix with it just enough of the oxalic solution to exactly neutralize it.† The amount of the oxalic solution which will be required to do this will be somewhere between 34 and 41 milligrammes, the amount varying with the temperature. Now take 30 c. c. of the solution in the large bottle, after the expiration of the prescribed time, and try how much of the oxalic solution it takes exactly to neutralize it. The difference between this and the preceding shows the number of milligrammes of lime which were united with the CO_2 contained in the air in the bottle. Multiply this difference by 0·795,‡

* This solution is prepared by dissolving 2·25 grammes of crystallized oxalic acid in one litre of pure distilled water; 1 c. c. neutralizes 1 milligramme of lime.

† It will be neutralized when it does not change the color of turmeric paper dipped into it.

‡ The molecular weight of CaO (lime) is 56, and that of CO_2 , 44, the weight of CO_2 being therefore $\frac{44}{56}$ that of lime. The ratio between weight and volume at 32° Fahr. is ·506. Then $\frac{44}{56} \times 506 \times 2 = \cdot795$, the factor used above. The reason for multiplying by 2 will be evident by remembering that only 30 c. c. of the lime-water was used out of the 60 c. c. put in.

which gives the number of c. c. of CO_2 contained in the air examined. Find the amount of air in the bottle by subtracting the volume of the lime-water put in, 60 c. c., from the total capacity of the bottle expressed in litres. The c. c. of CO_2 divided by the volume of air will give the number of c. c. of CO_2 in 1,000 parts of air. The following general formula will be found useful in solving ex-

amples: $x = \frac{(a-a') 0.795}{c-d}$. Reference: $x =$ c. c. of CO_2 per

litre; $a =$ first alkalinity of lime-water; $a' =$ alkalinity after exposure to air in the jar; $c =$ capacity of the jar; $d =$ space occupied by the lime-water. When the air is several degrees either below or above the freezing point, as will generally be the case, a correction for temperature must be made, as a given volume of air when expanded by heat is less dense, and when contracted by cold more dense, than normal. "Air expands or contracts .2 per cent for every degree it deviates from the standard"; hence .2 per cent added to the result for every degree above 32° Fahr., or subtracted for every degree below 32° Fahr., will be a sufficient correction for temperature. At ordinary elevations a correction for pressure will not be necessary.

The following example, selected from a series of experiments made by me, will be sufficient to illustrate the process. By first testing the alkalinity of the lime-water $a=38$; after exposure $a'=30$; $c=4,500$ c. c., $d=60$ c. c.

Then $x = \frac{(38-30) 0.795}{4,500-60} = 1.432$ c. c. of CO_2 per 1,000 vol-

umes of air. Correcting for temperature, which was in this instance 80° , or 48° above 32° : $48 \times .002 + 1 \times 1.432 = 1.569$. As there are only .4 c. c. CO_2 in air of standard purity, the above test shows a bad condition of air.

Prof. William Jones proposes the following modification of this method, which will give the same results,

lessening somewhat the work of calculation where a large number of tests are made. If we take the molecular weights of CO_2 and $\text{H}_2\text{C}_2\text{O}_4 + 2\text{H}_2\text{O}$ (oxalic acid), which are 43.89, and 125.7 respectively, we see that one part by weight of CO_2 is equal to $\frac{125.7}{43.89}$, or 2.8639 by weight of $\text{H}_2\text{C}_2\text{O}_4 + 2\text{H}_2\text{O}$; and as one part by weight of CO_2 is equal to 0.5086 part by volume, then each 2.8639 parts of oxalic acid are equal to 0.5086 part by volume of carbonic acid. Therefore 0.5086 : 28,639 :: 1 : 56,309, or 5.6309 parts by weight of oxalic acid are equal to 1 volume of carbonic acid; consequently, if we dissolve 5.63 grains of crystallized oxalic acid in 1 litre of distilled water, 1 c. c. of this solution will be equal to 1 c. c. of CO_2 , thus indicating the volume of CO_2 present in a given amount of air by the difference in the number of cubic centimetres of oxalic acid solution required to neutralize a given amount of lime- or baryta-water before and after shaking with the air, without any more calculation; except that if we use only one half the amount of lime-water that has been shaken with the air, it will be necessary to multiply the result by 2.

In the absence of the means for chemical tests, the sense of smell by a healthy person may be employed with fair results. Dr. de Chaumont states that .4132 parts of CO_2 per 1,000 volumes of air can be barely perceived by the sense of smell carefully exercised. When 0.6708 of a part is present the organic matter becomes disagreeable, and when 0.9054 of a part is present it becomes offensive and oppressive. After this limit has been reached, and the air becomes loaded with still more impurities, the sense of smell becomes unable to detect shades of difference. He concludes, from a long series of such experiments, that "0.2 per 1,000 in round numbers is the maximum of respiratory impurity admissible in a properly

ventilated air-space.”* It must be remembered that after the first few minutes in the room the sense of smell becomes unreliable. This test can be applied only by persons of keen sense and close and discriminating judgment, and then only at the moment of first entrance into the room from pure external air.

EXPERIMENTAL TESTS.

No. of examination....	1	2	3	4
Time of day at which air was taken.....	11 A. M.	2 P. M.	11 A. M.	4 P. M.
No. of pupils in the room.....	50	55	45	51
No. and condition of windows.	8, all open above and below.	6, three of them being open at the bottom.	8, three of them raised from the bottom.	4, on opposite sides and all open.
External temperature..	50°	75°	60°	70°
Internal temp. } Above	80°	76°	88°	70°
} Below.	68°	72°	76°	68°
Condition of the wind.	Strong breeze.	Calm.	Gentle breeze.	Gentle breeze.
No. of parts of CO ₂ in 1,000 parts of air taken from near ceiling.....	3·063	3·387	2·155	1·055
No. of parts of CO ₂ in 1,000 parts of air taken from near the floor.....	1·569	1·923	1·642	·6415
No. of parts of CO ₂ in 1,000 parts of external air taken outside the building.....	·507	·513	·493	·486
Method of heating....	Steam—direct radiation.	No fire.	Steam—direct radiation.	No fire.
Method of ventilating.	One outlet, 10x16 in., into a shaft without heat.	By windows only.	One outlet, 10x16 in., into a shaft without heat.	

* Roscoe found in a school of sixty-seven boys 3·1 parts of CO₂ per

The accompanying tabulated record shows the results of a few tests made by me on specimens of air taken from different school-rooms.

These results show — first, that all the rooms from which air was taken contained an amount of CO_2 considerably above the limit of respiratory impurity (*i. e.*, $\cdot 4 + \cdot 2 = \cdot 6$ parts in 1,000 parts of air); secondly, that the amount of CO_2 is due not so much to the number of hours the room had been occupied as to the conditions of ventilation. In Experiment 4, where the purest air was found, the room had been occupied all day, but on this particular day the weather was fine, with a breeze from the west. The windows were on opposite sides, east and west, so that a current of air was passing directly through the room. On some other day, when the windows might have to be closed on account of bad weather, and the wind happened to blow in some other direction, this room would have no ventilating advantages over the others. Thirdly, that CO_2 was in every case found in the largest quantities at the top of the room; and, fourthly, that the external air is generally pure, so far as CO_2 is concerned.

CHAPTER V.

AMOUNT OF AIR REQUIRED.

WHEN decided by examination that the air of a school-room is unfit for respiration, the question naturally presents itself, How may this air be renewed, and what should

1,000. Weaver found in a girls' school in Leicester, England, 5·28 parts per 1,000. Pettenkofer found in an occupied room 7·23 parts per 1,000.

be the rate of this renewal in order that it may be maintained in a state of respirable purity? Let us consider the latter question first: The amount of CO_2 evolved by one person in one hour is—adult males, 0·7 of a cubic foot; adult females, 0·6; children, 0·4. If we take 0·2 CO_2 per 1,000 volumes of air as the extreme admissible limit of vitiation (and this is as much as is *safely* admissible), the number of cubic feet of *fresh* air which will be vitiated by each person in one hour may be expressed by the formula $v = \frac{a}{b}$, where v = the required amount of fresh air per hour; a = the amount of CO_2 exhaled by each person, and b = the limit of admissible impurity. In the case of children, where the amount of CO_2 exhaled is 0·4, we have by substitution $\frac{0\cdot4}{0\cdot2} = 2$. b in the formula is expressed per thousand volumes; therefore v represents the number of *thousands* of cubic feet of air.

The number of cubic feet of air vitiated by each child in one hour is 2,000. In high-schools, where pupils are large, it would be more nearly correct to use 0·6 of a cubic foot as the amount of CO_2 evolved by each; and in colleges 0·7 of a cubic foot, the amount given off by adults. These conditions, then, would require, respectively, for small children, 2,000 cubic feet per head; for high-school pupils, 3,000 cubic feet; and for college students, 3,500 cubic feet. In a school-room of ordinary size there are $28 \times 34 \times 14 = 13,328$ cubic feet of air. From the foregoing it was seen that each child requires 2,000 cubic feet of pure air per hour; sixty children—about the average school number—will therefore require the same amount in one minute. It is plain, then, to see that the air in the average school-room, were there no means for ventilation, would become vitiated in less than

seven minutes — $13,328 \div 2,000 = 6.66+$ min. It appears evident, then, that in order to meet the requirements of perfect ventilation the air in the room must be changed every seven minutes, and the total amount of fresh air which must be passed through a school-room of ordinary capacity and occupancy is $2,000 \times 60 = 120,000$ cubic feet per hour.

After the first few minutes—the time required to vitiate the amount of air the room contains—the size of the room makes no difference in the constant amount required. It is the number and size of the occupants which must regulate the amount necessary for ventilation. The size of the room, and the number of cubic feet to be supplied each pupil, are important only for the fact that a given amount of air can be passed through a large room without producing strong currents more easily than the same amount through a small room. The size of the room, therefore, and the number of cubic feet per head, are no indications of the respiratory quality of the air therein contained.

How to Estimate the Amount of Air passing through a Room.—The air passing through a room may be estimated either by measuring it as it comes in or as it passes out. Before making these measurements they should be made intelligible by an understanding of a few fundamental properties of fluids, of which air is one.

All movement in the air is caused by an inequality of pressure in different localities due to inequality of heat. Wind—air in motion—is simply the movement of the air of one locality toward another locality containing air of less density. As heat expands the air, making it lighter, the movement of the air will always be in the direction of the warmer temperature. The air, being matter, has weight, and is subject to the same laws of pressure and

falling as other matter. If the atmosphere were of uniform density from top to bottom, it would form an envelope around the earth about five miles in depth.

The velocity which a body acquires in falling is expressed by the formula $v = \sqrt{2gH}$, where v = velocity, H = height through which the body falls, g = the acceleration due to gravity. This is nearly equal to eight times the square root of the height, and for simplicity may be so expressed : $8\sqrt{H}$.

The particles which constitute a fluid, as water or air, have no friction among themselves, and exert pressure in all directions. Another fundamental law following from this is that fluids will pass through an orifice below the surface with the same velocity that a body would acquire in falling a distance equal to that between the surface and the orifice ; and that, when passing through an orifice in a partition separating the fluid from another fluid of different height, the velocity will be equal to that of a body falling a distance equal to the difference of the depth of the fluids on the two sides. The pressure of the air on any surface near the earth is about fifteen pounds to the square inch, and is the weight of a column of air five miles in height. Air, then, would rush into a vacuum with a velocity which a body would acquire in falling five miles. It would rush into a room containing air of a less pressure, which may be considered as a partial vacuum, with a velocity due to a height which represents the difference between outside and inside pressure. Now, a direct relation exists in any substance between weight and density, and as a volume of air increases regularly with the temperature, lessening its density and weight in the same ratio, a means for measuring the difference of pressure by comparing the temperature of the air on either side of the partition is thus afforded ; and this, together

with a comparison of the relative height of the entrance and exit orifices in a room, enables us to calculate the velocity with which air is passing.

Air expands $\frac{1}{491}$ of its volume for every degree Fahrenheit. The height through which a body would fall having the required velocity which we are considering is expressed by the formula $H = \frac{h \times t}{491}$, where H = the height through which a body would fall to acquire the velocity under consideration; h = height from the entrance to the exit orifice; t = the difference in temperature between inside and outside. By substituting this value of H in the general formula ($v = 8 \sqrt{H}$) for falling bodies, we have $v = 8 \sqrt{\frac{h \times t}{491}}$ in feet per second.

Example: Suppose $h = 14$ ft., $t = 20^\circ$; then $v = 8 \sqrt{\frac{14 \times 20}{491}} = 6.032$ ft., the velocity of the air per second. An allowance of from one sixth to one half of the theoretical velocity must always be made for friction,* according to circumstances and special peculiarities of the openings and ducts or tubes leading thereto. Having found the velocity, the amount of fresh air may be found by multiplying the velocity by the sum of the areas of the openings expressed in feet.

These calculations are equally true whether the openings are windows or apertures constructed especially for ventilation. When windows are used, a difficulty arises in making the computation, due to the difficulty of ascertaining where the air enters and where it leaves the room; windows on different sides of the room, being of the same

* For discussion of particular cases and practical formulas for determining velocity, see Appendix "B."

distance from the floor, and their openings at different times varying in position and size to suit the freaks of the occupants, are inlets or outlets according to the circumstances. The same window may be inlet and outlet at the same time, producing cross-currents and strong draughts, the disagreeable nature of which is well known to all victims of window-ventilation.

The simple conditions governing the possibilities of this method of measuring the amount of air which is passing through a room are, that the air in the room must be of a higher temperature than that outside; the air must pass in from below and pass out above. In summer, when the outside temperature is equal to or higher than that inside, this method is not available. It is also unreliable when the wind is blowing, unless the openings are properly guarded against the unequal pressure due to this cause.*

The Anemometer.—When the wind is blowing, or any of the conditions of the above method of measuring the velocity of the air are otherwise not complied with, the anemometer must be used. Of these instruments many kinds are now in use, but in principle they are all essentially the same. They consist of fans revolving on an axis (after the manner of a wind-mill) which is connected by wheel-work with an indicator showing the velocity of the air which is moving the fans.

Insufficiency of ordinary Air-Supply.—School-houses which make pretensions to ventilation other than by means of doors and windows commonly have a single register for the admission of fresh air, and one for the exit of foul air. These are variously situated—sometimes at the top of the room, sometimes at the bottom,

* See "Regulating the Drafts of Openings," page 56.

and at other times midway between floor and ceiling. The proper position for these ventilating openings will be considered in another place ; but, supposing them to be situated properly, we are ready from the foregoing to consider the efficiency of these breathing-holes.

These registers are usually about 16×18 inches, and sometimes much smaller ; this gives a total area for the entrance of pure air of 288 square inches, or 2 square feet ; multiplying by 6, the number expressing the velocity in the example previously given (where the height of the room is 14 feet, the difference between the temperature of air outside and inside 20°), we have 12, the number of cubic feet of air passing into the room per second ; multiplying this by 3,600, we have 43,200, the number of cubic feet of air passing into the room per hour. We saw above that each pupil requires 2,000 cubic feet per hour in order that the degree of vitiation may not exceed the limit, 0.2 of a part of CO_2 per 1,000 parts of air ; and that sixty pupils require 120,000 cubic feet of pure air per hour. It thus becomes evident that this amount of opening will ordinarily supply only about one third of the quantity of air required. Air passed through an opening of this size, in order to be sufficient, would have to move at the rate of about eighteen feet per second, or about eight and a half miles per hour. When air is moving two miles per hour, it becomes perceptible to the senses as wind ; and if it were passing into a room at the rate of eight miles an hour it would be a breeze which would be dangerous to the pupils sitting near it, especially if it was not warmed before passing in. This velocity of air would be neither tolerable nor possible, unless it should be first warmed and then forced into the room by means of aspirating chimneys, or by mechanical means described in another place.

The Distribution of Air.—No less important than the adequate quantity of air to be supplied to a room is its proper distribution. This is impossible where but a single opening is furnished for admission, and the same for exit. Under these conditions the air may pass through the room in a narrow current, without being utilized by mixing with the vitiated air of the room.

In considering these single openings of the ordinary size, I have supposed the conditions such as to make them count for their greatest possible utility; but when we remember that they are often misplaced—that the difference in internal and external temperature is often not so favorable as the case considered; that the passages through which the air must pass before reaching the room, and in making its final escape in leaving it, do by friction greatly lessen the amount given by the theoretical estimate; and that these passages are often neglected and impure—we are forced to the conclusion that this much provision for furnishing pure air to a school-room is in its effects, if not absolutely *nil*, so very little that it may be ignored. The further conclusion is, that what air pupils generally get comes in through windows and doors.

CHAPTER VI.

GENERAL PRINCIPLES OF VENTILATION.

HAVING learned something of the nature and requirements of the air we breathe, of the source of its impurities, the amount needed, and the way by which it may be measured, we are ready to consider how a room is to be supplied with air of the requisite quantity and quality,

and how its proper temperature may be maintained. How to remove the air from a room as fast as it becomes vitiated, and to supply its place with pure air of the proper temperature, are questions in engineering, to answer which is at once necessary and difficult.

The difficulties which attend the answering of these questions are in part theoretical and in part mechanical; theoretical, in that all devices and means to accomplish the ends of ventilation must rest on general principles, and conform to the known laws of matter and motion; mechanical, in that the successful application of the most obvious general principle implies good workmanship.

The most perfect theory of ventilation, based on correct physical principles, might be totally defeated in its ends by a bungling carpenter. These important questions, then, can be met and answered only by accurate and skillful workmanship, based on correct theory.

A secondary difficulty attending all efforts to engineer air is that it is invisible. Could the air and the impurities which it contains be seen, we should at every turn receive practical hints how to move it, as well as constant admonition that it is to our best interests to do so; but, instead of the advantages which the visibility of the air would afford, we have to rely on our knowledge of its properties and laws, and on our reason in interpreting existing causes and their attendant effects.

Warming and ventilating are antagonistic processes—the one is addition, the other subtraction; the one a giving, the other a taking away. But, as the two processes are inseparably connected and mutually interdependent, it will be necessary, partially at least, to treat of them together.

Natural and Artificial Ventilation.—So many different devices of warming and ventilating have been em-

ployed, some of which make use of mechanical means to move the air, that ventilation is usually considered under two classes—*natural* and *artificial* ventilation.

In natural ventilation the openings are so constructed and arranged as to make the natural forces in the rising of warm air, and in the falling of cold air, do the work of changing the air of the room.

In artificial ventilation, the air is forced into the room by mechanical power.

This classification, while convenient enough, is, after all, entirely arbitrary. All ventilation is in one sense artificial, and in another sense all ventilation is natural. "Natural" ventilation is artificial, as it requires art in making the openings of the proper construction and position; "artificial" ventilation is natural in that natural laws must be utilized and directed.

Illustration of the General Theory of Ventilation.—As the laws of motion and pressure governing fluids are equally applicable to air and to water, the following interesting experiment illustrates the general theory of ventilation :

Take a large glass jar and fill it with clear water to represent the external atmosphere. Fill a large square bottle, having apertures near the top and bottom, with colored water to represent the internal air of the room and its impurities; see that it is of the same temperature as the water in the jar, and then suspend the bottle in the water in the jar. On carefully opening the apertures it will be noticed that a mingling of the clear and colored waters takes place very slowly. This is due to diffusion, and illustrates what takes place in the air when the internal and external temperatures are equal and the atmosphere quiet. If now the colored water be heated to a temperature several degrees above that of the clear water,

it will be seen to rise and pass out of the upper apertures, the outside clear water, being heavier, flowing in at the lower aperture. The colored water soon passes out, leaving the bottle filled with the pure water. This illustrates ventilation in winter, when the air of the room is warmer than that outside. If the colored water in the bottle be cooled by ice or a freezing mixture, and the outside water be warmed, the current will be reversed; the heavier, cool colored water will flow out at the lower aperture, and the outside clear water will flow in through the upper one to fill the space thus left. This illustrates the action of the air in summer, when the air of the room is cooler than the air outside.

CHAPTER VII.

NATURAL VENTILATION.

Position of Ventilators.—The question is often asked, Where should ventilators be placed? Some say at the top of the room, others say at the bottom; the experiment described in the foregoing chapter answers this question. When only the conditions of ordinary natural ventilation are present, there can be but one answer—*ventilators should be at the top of the room.* The air in the room, when warmer than the outside air, must come in at the bottom and go out at the top; and, when cooler than the outside air, must come in at the top and pass out at the bottom.

This movement may be reversed, but it must be done by means other than that afforded by natural ventilation; and, even in the *plenum* movement described in another

place, it is always the part of economy to work with Nature, and not against her.

Ventilators are often placed near the floor because of the erroneous idea that the foul air is below. The fact that CO_2 is a little heavier than air has led to the hasty conclusion that it at once settles, and is to be found near the floor. The facts are that CO_2 forms a very small percentage of each expired breath, and its temperature, as well as that of the air from the lungs with which it is mixed, is when leaving the mouth much higher than that of the surrounding air; it is therefore lighter, and at once rises; and the tendency it has toward rapid diffusion prevents its sinking even after it has become as cool as the air of the room.

The tendency which gases of great differences of density have to diffuse, even against the force of gravity, may be illustrated by taking two bottles, filled, one with hydrogen, the lightest gas known, and the other with the heavy CO_2 gas which we are considering. Connect the bottles by a glass tube passing through the cork stoppers of each. Leave them for a time with the light hydrogen above and the heavy CO_2 below, and in a short time they will be thoroughly mixed, the heavy gas having risen against gravity to mix with the hydrogen.

In certain modern systems of heating and ventilating, to be described hereafter, the ventilating ducts are placed near the floor. This is thought by the inventors of these systems necessary to prevent the too rapid escape of the fresh air as it enters the room and immediately rises to the top. If this warm air were properly distributed as it entered, it would be sufficiently vitiated to require its removal on reaching the top of the room; but, as this is seldom the case, the difficulty is met by placing the outlets below, allowing the upper hot air to press the cooler air down and out.

As a justification for this arrangement, the authors of these systems have tried to persuade themselves and the public that the foul air of a room is at the bottom, and have conducted some curious experiments to prove this; among which may be mentioned those of Mr. Leeds, of Philadelphia.

He first takes a large glass tube, with perforated caps at each end, as represented in Fig. 1. Smoke is blown

FIG. 1.

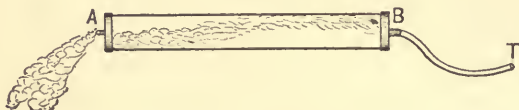

into the tube through the rubber tube T. It will first rise to the top of the tube, but on cooling it soon settles to the bottom and flows out at A. This smoke is intended to represent the carbonic-acid gas, CO_2 , from the lungs, which it is claimed by this experiment will fall like the smoke at a temperature of from 60° to 70° .

This, with no further knowledge of the nature of smoke and CO_2 , would readily pass for a legitimate comparison; but a moment's reflection reveals a fallacy. Smoke is solid matter in a fine state of division floating in warm rising air. When the air cools and ceases to rise, these solid particles by their superior specific gravity fall. But CO_2 is not a solid; it is a gas; and gases have the property of rapid diffusion. The relatively small quantity of CO_2 at any one time rising with the heated air will have more than time thoroughly to diffuse in the air before the latter cools sufficiently to allow the settling of a similarly suspended solid.

Another alleged proof, by the same author, consists

of admitting some CO_2 in an undiluted state into an inclosed space in which tapers are burning at different heights. The CO_2 being heavier than air, when thus poured in, of course sinks to the bottom, and extinguishes the lower lights first, which is given as sufficient proof that foul air is found at the bottom of the room. Here the quantity of CO_2 used, and the time given for its diffusion, are all out of proportion with the actual conditions ever existing in an occupied room.

Experimental demonstration does not always demonstrate. Nothing may be more misleading in its teaching than an experiment which is only half interpreted. Should this reasoning be thought insufficient, the facts may be easily ascertained by examining the air for CO_2 . (See Experimental Tests, page 37.)

CHAPTER VIII.

INLETS.

Position.—Inlets, as before intimated, should be placed near the floor. It is sometimes claimed that in order to avoid cold air on the feet the inlets should be placed seven to nine feet from the floor, so that the cold air on entering may sink and mingle with the warmer air of the room as it descends. Too much can not be said against submitting the occupants of a room to cold drafts of air; and where the air is allowed to enter without being warmed, or without provision being made for its warming as it enters, it is perhaps less objectionable to admit the air from above; but, as it should be a settled principle in building school-houses that *the air should never enter without some pro-*

vision for its warming, the objection to its admission from below disappears. To admit it from anywhere else is practically to destroy the upward direction of the current, upon which the regular change of the air of the room mainly depends.

In summer, when the inside air is sometimes cooler than the outside, the ventilation will be downward, and the inlet and outlet openings at the bottom and top of the rooms respectively will change functions, the air coming in at the top and going out at the bottom; but this is not often the case, especially in school-houses where school is not in session during the hottest weather.

Total Size and Distribution of Inlets.—Inlets should, of course, be of sufficient area to admit the requisite amount of air without requiring so high a velocity as to cause drafts. The total area may be easily approximated

by the formula $A = \frac{V}{3,600v'}$, where A equals the sectional area of the inlet; V equals the volume of air passing through the inlet per hour; v' equals the velocity of air in feet per second through the inlet; 3,600 equals number of seconds per hour. It is generally more convenient to let A represent the number of cubic feet of air required per hour by each pupil, then the amount required for any number of pupils can easily be obtained. The value of V has already been discussed. (See Appendix "B.")
Example :

What will be the total sectional area of inlets required in a room capable of accommodating 75 pupils? If each pupil requires 3,000 cubic feet per hour, and the velocity with which the air can be admitted is found to be 7 feet per second, then $A = \frac{3,000}{3,600 \times 7} = .119$ square foot = 17.1 square inches for each pupil. By referring to the exam-

ple in Appendix "B," it will be seen that 7·7 is the velocity attained when a good aspirating chimney is used. It often happens in ordinary conditions of natural ventilation that the velocity is not more than 5 feet per second.

Using this number in the above problem, $A = \frac{3,000}{3,600 \times 5} = \frac{1}{6}$ square foot, or 24 square inches. Counting 60 as the number of pupils to be supplied, the total area of inlets will be $60 \times 24 = 1,440$ square inches. This is equal to one inlet 37·8 inches square, or 10 square feet. About the same area is required for outlets, making 20 square feet as the total area required for inlets and outlets in an ordinary school-room.

Distribution of Inlets.—The air should never be admitted through a single inlet, but should be so distributed around the room that free diffusion may occur. To pass air into a single opening of a large room, and allow it to pass directly out at another opening, may be likened to a waiter who would feed a company by carrying a quantity of food through a dining-room without stopping to pass it around. One foot square is large enough for one opening. In the example given above we have then ten openings, which should be equally distributed around the room; the same number of outlets would not be required, though they must be equal in area.

Source of the Air supplying Inlets.—It is an important matter, though often overlooked, that the air which furnishes the supply to inlets should come from a pure source. It is generally understood that the surface condition of any locality determines largely the condition of the air which comes in contact with that surface. A wind, if blowing over an icy region, will be cold; if across a dry and arid region, it will be dry, desiccating, and parching; if over a swampy, wet locality,

where large quantities of organic matter are in a state of decay, it will be laden with sickening vapors and malarial germs.

In full knowledge of these universally recognized facts, the air which furnishes the inlets is often drawn from near the damp ground, and sometimes from the vicinity of back yards and alleys, where all kinds of filth and refuse pollute this "fresh supply" before it enters the school-room.

Unless the school-house is extremely fortunate in its location-site, and at some distance away from all other buildings, the air supply should be drawn at some distance from the ground, by means of upright shafts or tubes of the height determined by the circumstances of each case. Fig. 2 illustrates the movement of the air down the shaft, through the room, and out at the ventilator. A, downcast tube, with conical-shaped cap inverted; B, entrance shaft; C, upcast eowl, with conical-shaped cap erect; D, outlets in the ceiling; E, registers admitting air into the room; R, room; W, windows.

The chief objection to the use of down shafts for the purpose of getting pure air is to be found in the retardation due to the friction. This may be entirely overcome by means of aspirating chimneys, but even when these are absent the friction may be largely compensated for by properly arranging the shape of the shafts and ventilators. Reference to Fig. 2 will show how this may be done: the wind striking the inclined surface of the inverted conical cap is deflected downward into the shaft, thus increasing the amount of air entering the room. In the ventilator C, on the other hand, the wind striking against the oppositely inclined surface of the erect conical cap, as well as the flange C' below, is deflected upward, causing an upward draft in the ventilating tube.

“Lobster-backed” cowls are sometimes used on ventilators to increase their aspirating power. These revolve

FIG. 2.

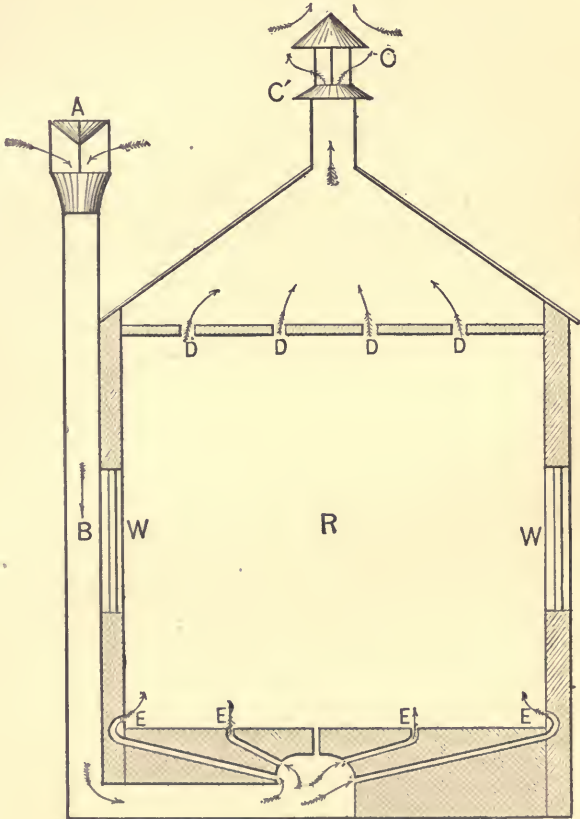

with the wind, keeping the back to the windward, thus preventing the wind from blowing down the tube; the

liability, however, of these cowls to get out of order has led to their disuse.

All shafts and tubes leading to the room should be so constructed as to reduce friction to a minimum, and admit of frequent cleaning; they should therefore be lined with some smooth, hard material, and be made accessible to the brush of the janitor. Neglect in this particular is often a considerable source of vitiation. Rough brick and mortar shafts and ducts collect large quantities of dirt and organic matter, which by its decay forms a source of pollution, and, being by their construction inaccessible, their vitiating action is constant.

CHAPTER IX.

REGULATING THE DRAFT OF OPENINGS—THE WIND.

WE have discussed in another place the nature and velocity of air passing through inlets and outlets, when caused by the inequality of internal and external temperature, and the difference in height between inlets and outlets. But the results thus obtained will nearly always be modified by the action of the wind, which is usually blowing in some degree, and which must be in some manner compensated for by properly arranged inlets.

The action of the wind is to increase the pressure of the air on the windward side of the room, and by the aspirating power which a moving air-current has on neighboring air to decrease the normal pressure on the leeward side. The extra pressure exerted by the wind may be estimated by first ascertaining the velocity by means of an anemometer (*q. v.*), squaring and multiplying by .005.

This is expressed by the empirical formula $v^2 \times .005 = P$, where v = velocity of the wind, P = pressure in pounds per square foot, and $.005$ = a constant.

When an anemometer is not accessible, a tolerably correct estimate of the wind's pressure may be obtained by Beaufort's classification of winds : 1, faint air ; 2, light air ; 3, light breeze ; 4, gentle breeze ; 5, fresh breeze ; 6, gentle gale ; 7, moderate gale ; 8, brisk gale ; 9, fresh gale ; 10, strong gale ; 11, hard gale ; 12, storm. In this classification the force of the wind is estimated by the scale 0 to 12, which represents all degrees from a calm to a hurricane. In using this, any estimate divided by 2, and the result squared, will approximately represent the wind's pressure in pounds. Example: Suppose a "gentle breeze" is blowing. Referring to the classification above, it is seen that "gentle breeze" is No. 4 ; then $(\frac{4}{2})^2 = 4$, the number of pounds pressure on one square foot of surface. Again : If a "strong gale" is blowing, then $(\frac{12}{2})^2 = 36$ pounds.

In the absence of an anemometer, the velocities of the different winds above enumerated may be calculated by finding the pressure in each by the method last given, and then substitute this value of P in the first formula, from which then find the value of v . For convenient reference I have made the calculations, which may be considered as simply a popular translation into the common language of terms used in referring to wind :

1. Faint air,	7	miles	per	hour.
2. Light air,	14	"	"	"
3. Light breeze,	21	"	"	"
4. Gentle breeze,	28	"	"	"
5. Fresh breeze,	35	"	"	"
6. Gentle gale,	42	"	"	"
7. Moderate gale,	49	"	"	"

8. Brisk gale,	56 miles per hour.
9. Fresh gale,	63 " "
10. Strong gale,	70 " "
11. Hard gale,	78 " "
12. Storm,	85 " "

If action of the wind is not anticipated and provided for, it will defeat the most carefully laid plans for ventilation; but, if properly controlled, it may by its perflating, aspirating, and motive power be made an aid instead of being a hindrance. By its perflating power it may be used in counteracting friction by directing the current downward through entrance shafts, as shown in Fig. 2 A. By its aspirating power it may increase the upward draft of a ventilator chimney by blowing directly across the top, or by being directed upward by means of a deflecting surface (Fig. 2 C).

When inlets are not preceded by down-shafts, but only by short tubes or ducts coming directly from the outer air, they should be guarded by means of guards or valves, to prevent strong gusts of wind from entering the room, which might otherwise occur. The best possible arrangement for this purpose would be a modified form of Dr. Arnott's current-regulating air-valve, which he invented for regulating the draft of closed stoves. A sectional

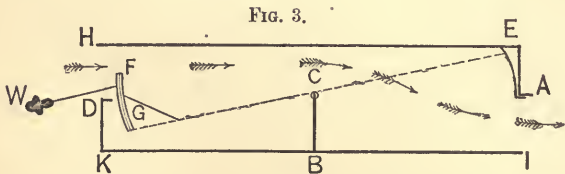

diagram of this ingenious device is here represented (Fig. 3). The bounding lines H E I K represent the outside

walls of the tube to be fitted into the inlet duct. The arrows show the direction of the air-current; A I is the opening of the inner extremity of the box, and D H the opening to the outer extremity. G E represents the edge of a lever-frame balanced across the partition C B. F G is a door attached to the lower extremity of the lever-frame E G. W is a sliding weight on the rod extending from F. The half of the lever-frame shown by the broken line C E is covered by a wire screen, through which the air-current flows in its passage into the room. If the current is strong, it is resisted somewhat by the friction against the wires. This resistance causes the screen end of the frame to be depressed, and the opposite end, carrying the door F, to be elevated—thus partly closing aperture H D. The size of the opening will thus always be inversely proportional to the strength of the wind. When out of proper balance, it may be corrected by moving the weight W. This device is remarkable for its ingenious simplicity, and it is also remarkable that it has never been utilized as a current-regulator in ventilation.

Various devices have been contrived at the inner terminus of inlets for preventing a perceptible draft on the windward side of buildings, among which may be mentioned the Shirringham valve, which gives the wind a deflection upward as it enters the room. Other forms have been made by Messrs. Bayle, Weaver, and Ellison. All these, however, must be regarded as so many attempts to correct what ought not to exist. If the velocity of wind is not checked before it reaches the inside of the room, it is then too late to manage it satisfactorily. The wind might be successfully managed, and the air at the same time be freed from many of its suspended impurities, by constructing, outside the building to be supplied, large air receptacles supplying the inlets. These receptacles would

serve a purpose in supplying air analogous to that of our large reservoirs in supplying water. The entrance to these receptacles could be guarded by filters for abstracting suspended impurities; and the fluctuating air pressure due to the wind could be regulated by automatic valves.

Admitting Air at the Top.—When a room is situated so as to make the admission of the air at the bottom inconvenient, it may be admitted from the top. Fig. 4 represents McKinnell's circular tube, which is probably the best arrangement for this form of ventilation. The heat of the room causes the air to rise and pass out at the inner tube, as indicated by the arrows. The addition of the cowl A would tend to promote the same upward current. The partial vacuum thus formed will be filled by the outside air flowing in at the large encircling tube, the action of which would be further promoted by the addition of the inverted flange B. The horizontal flange C, at the lower extremity of the inner tube, deflects the inflowing air along the ceiling, distributing it before it falls to mingle with the warm air of the room.

This method of admitting the air has some advantages. The cold air, by its contact with the warm air near the ceiling, becomes warm before reaching the occupants of the room. By its admission through a tube encircling the warm inner tube, the inflowing air, if cold, becomes warm by contact. This tube will not always act as an outlet. If the windows are opened, cold air will come in from below, supplying the place of the ascending warm air, which will then pass out at both tubes, making them both outlets.

The conditions of natural ventilation may be summarized briefly: The air of the room, made warm by artificial means, and by the heat of bodies, has a tendency to rise; that it may pass out as fast as vitiated, this ten-

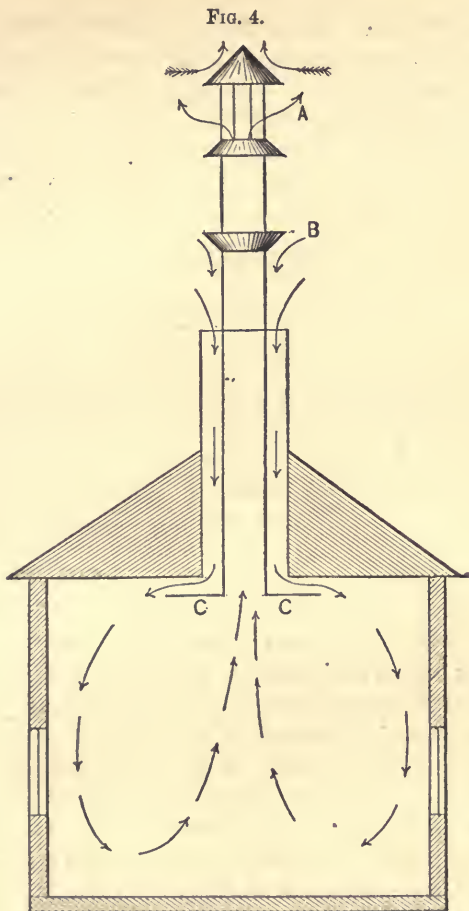

dency must not be resisted, but promoted by openings from above into aspirating cowls or chimneys. Fresh air, which supplies the place of the outgoing air, must be so admitted as to facilitate the same movement by utilizing

its power to push. In order that it may be pure, it must be taken from an elevated source by means of an upright shaft. The regularity of the supply must be regulated by properly constructed valves.

CHAPTER X.

VENTILATION BY WINDOWS.

THE primary office of windows is to admit light ; but owing to a lack of proper provision for the passage of fresh air, they must also serve the secondary office of ventilation. It has already been shown that, where ventilators exist, they are usually only nominal, their size, position, and construction making their utility almost wholly imaginary. As windows, then, in school-houses already existing, are our only source of fresh air, and furnish us the only means that we may soon reasonably hope for, it behooves us to make the most of them. Where the means are meager, their skillful manipulation becomes still more a necessity. Generally speaking, windows are poor ventilators. On a balmy day in spring, when the sky is clear, the dust having been laid by a light shower, and a gentle zephyr is blowing, all the windows may be raised (or dispensed with entirely), and the air allowed to circulate freely through the room. Under such circumstances, windows are the best possible ventilators, unless it were possible to remove the walls also. To ventilate a room on such a day requires little forethought. The common instinct of a school-girl to throw open a window is all the art or philosophy which the case requires. But when the bitter

winds of winter are blowing, or rain or snow is pelting one side of the house, or perhaps clouds of dust and smoke are rolling toward the house, the case is different ; the instinct which throws up a window to escape a stifling atmosphere, throws it down again to escape a worse evil.

When wind has any of the disagreeable accompaniments above mentioned, the windows should, when possible, be opened on the leeward side. The aspirating power of the wind has a vacuum-forming tendency on the side opposite its direction ; the air will, therefore, if windows be opened on that side, flow out of the room, and sufficient air to supply the vacancy thus made will work its way through cracks and crevices on the windward side.

It often occurs that windows are all on one or two sides of the room ; we then have our choice between the suffocation of closed windows or braving the elements admitted by open ones. Where the only windows happen to be on the windward side, and the wind must be admitted, it is better to open them at the top. The wind will blow in, forcing some of the impure air out.

Just where the outlets will be can hardly be guessed. About half of the openings to a room, when there is movement of the air through them, must of necessity be outlets. Where the outlets are will depend upon the position of the inlets and the freaks of the wind. A single opening will sometimes be both inlet and outlet where shifting cross-currents are irregularly passing. The air which thus enters will in some measure mix with the vitiated air of the room, diluting the exhaled poisons. The air which is forced out will carry with it some of the impurities ; the amount, however, depending on local and changing conditions. This kind of ventilation may be likened to the imperfect blood-circulation in the cold-blooded reptiles, which have a single ventricle for both

pure and impure blood, which is sent through the system in a mixed state.

The force of the wind admitted through open single windows may be partially checked by fastening a piece of board to the top sash and extending into the room obliquely upward so as to retard its fall on the heads of the pupils. In Fig. 5, *a*, the arrows show the direction of

FIG. 5.

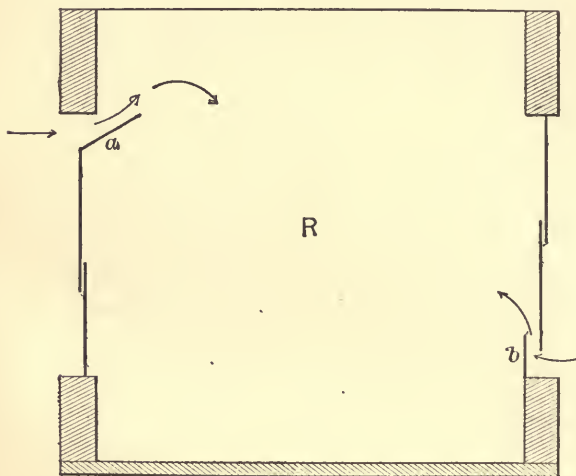

the air deflected upward as it passes into the room, R, by the oblique board, *a*, attached to the upper sash; *b*, on the other side, represents a board fitted between the casings on the window-stool, and serves a similar function.

No set rules can be given as to whether windows should be opened from the top or from the bottom. This will depend entirely upon the circumstances—upon whether a window when opened is intended for an outlet or an inlet. This requires close observation on the part of the

teacher, as well as careful study and an intelligent understanding of the existing conditions. When the wind is not blowing, all the windows should be opened, both top and bottom; the size of the openings being regulated to suit the temperature. In this way the air of the room, if it is warmer than the outside air, will rise and pass out at the top; the outside air, being heavier, will flow in at the bottom. In summer, when the air of the room is cooler than that on the outside, the current will be reversed.

When the internal and external temperature is about equal, and when no wind is stirring, the windows should be opened about equally from above and below, and as wide as possible, giving diffusion, the only means for ventilation which is under the supposed conditions existing, as much freedom as possible.

It is when the wind is blowing that the greatest difficulty is found in ventilating by windows, but by skillful

FIG. 6.

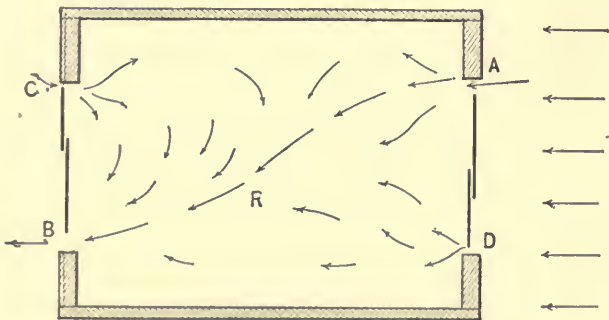

management much more can be done toward establishing a constant current than is generally supposed. The most favorable condition is when windows are on opposite sides of the room. Fig. 6 supposes this case, where a moder-

ate wind is blowing from the direction indicated by the large arrows. By opening the window on the windward side at the top, and the one on the leeward side at the bottom, a current is established as indicated by the large inside arrows ; this direction being the resultant of two forces—one the horizontal force of the wind, the other the greater specific gravity of the cold air. This current, as it passes through, will have an aspirating power to draw the air of the other parts of the room toward it. This is simply the vacuum-forming tendency which fluids always possess when moving. The small arrows show the direction of the air in the various parts. Now if the window at D be slightly raised, and the one at C slightly lowered, the vacuum-forming tendency within will initiate a sufficient current through these openings to supply the vacancy. Admitting the cold air at the top, and letting the foul air out below, seems to contradict the natural theory of ventilation as before described ; but it must be remembered that here the force of the wind is utilized instead of the unequal weights of columns of hot and cold air. A further advantage is here realized in the cold air being warmed before it strikes the occupants of the room.

It more frequently occurs, especially in school-houses containing several rooms, that the only windows are on two adjacent sides. In this case it is generally best to make the principal top openings on the side of the strongest wind, and the principal bottom openings on the remaining side. The wind will then after entering be deflected by the opposite wall in the direction of least resistance, which will be toward the largest openings on the adjacent side.

When windows are only on one side of the room, the difficulty is still further increased. In this case it is generally better to make the principal opening at the top,

and a smaller one at the bottom. The purpose of this is illustrated by Fig. 7. When the wind is very strong, the upward tendency of the inside air may be counteracted

FIG. 7.

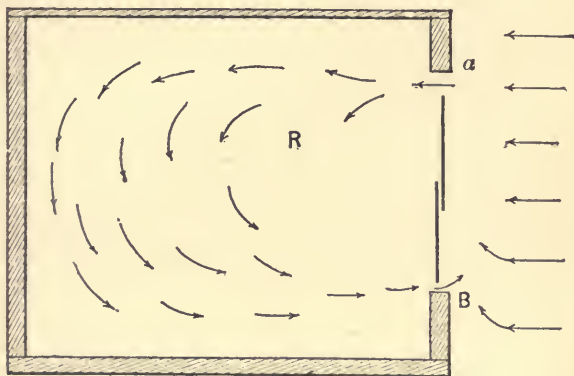

by a large opening at *a*. The air, being thus forced in, will seek the lines of least resistance in escaping. By making a small opening at B it will become an outlet, as it has less to oppose than at *a*, where the momentum of a large inflowing quantity would be encountered. From the laws of fluid pressure it would at first appear that the tendency of the outside air to enter at B would be as great as at *a*, and, indeed, even more, owing to the greater depth below the surface; but, when it is remembered that the relative friction which fluids have to overcome in passing through small orifices is so much greater, it is plain that in the case of the present example the relative absence of friction in the larger top opening gives to the wind when passing through a momentum which is sufficient to establish the current. If, however, the wind is of only moderate velocity, the current will be likely to set

the other way—will enter at the bottom, and pass out at the top. In this case the size of the openings must be suited to the temperature, the number of pupils in the room, as well as their capacity to bear hardship.

When the wind is not strong, and the location of inlets and outlets is not evident, they may generally be found by the aid of a feather fastened to the end of a pointer, which, held in front of an opening, will indicate the direction of the passing current.

The best possible window ventilation requires the use of double windows. Ideal window ventilation would require double windows on four sides of the room. Such conditions would afford a fair degree of purity. By means of double windows the wind may be admitted or kept out when and where desired. Its force could be broken by

FIG. 8.

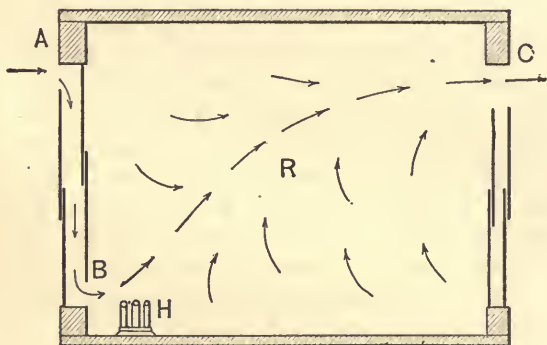

being made to pass perpendicularly between the windows before entering the room. Inlets and outlets could be made at the top or bottom as required by the circumstances, and the strong drafts unavoidable in single windows avoided. Fig. 8 illustrates a single ease, which, of

course, permits of indefinite modification to suit existing circumstances and changing conditions. Here the air enters at A by the upper outer window being lowered; descending, it enters the room at B, by the inner lower sash being raised; passing over the heater H, it is warmed before striking the pupils; rising, it passes through the room, and escapes at C, by both inner and outer windows being lowered.

Suppose another case, that of a stove situated in the middle of the room. Fig. 9 illustrates an instance where

FIG. 9.

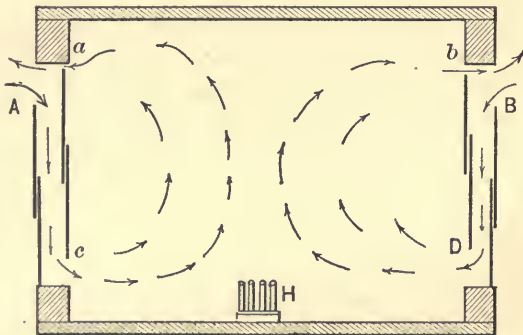

a single opening serves both as inlet and outlet. By making large openings at A c and B D, by lowering the outside windows and raising the inside ones; and the smaller openings, a and b, by slightly lowering the inside windows, it is possible to divide the cold and hot air currents, as indicated by the arrows—the chief controlling principle here being the unequal weight of hot and cold air. Without multiplying instances, suffice it to say that in window ventilation the place and relative size of openings must be conditioned by the direction of the wind, the velocity of the wind, and the position of the heater.

CHAPTER XI.

ARTIFICIAL VENTILATION.

As distinguished from so-called natural ventilation, where the air is changed by means of doors and windows, or other openings, the moving forces being the wind and the unequal weights of hot and cold air, certain additional or artificial means may be used whereby the change of air may be made to take place more rapidly, and the regularity of the movement more certain, than is possible in natural ventilation.

The changes of temperature both in frequency and amount are in this country so marked, and the direction and velocity of the wind so various and fickle, that even the most carefully worked plans for the use of the natural methods above described are attended with constant embarrassment and partial defeat.

Something has been done toward an intelligent solution of the all-important problem of how to measure out, warm, and furnish to the occupants of crowded rooms air of the proper quantity and quality; but the subject has not received a tithe of the attention that its merits demand. To know exactly how much air is needed by a school, and to furnish it by exact mechanical measurement, is not a very severe problem, and is one with which the designers of buildings should be familiar. To measure the amount of water, and estimate its velocity, which is necessary to do a certain amount of work, is a problem of every-day experience with the civil engineer. Now air, no less than water, is matter, and subject to nearly the same laws of weight, motion, and measurement; and to manipulate it in the manner required by the conditions and necessities of ventilation, providing at the same time

for its exigencies, is an element in school-house construction plainly possible, and should be recognized as a part of the duty of him who is intrusted with this important function. It is as easy to measure air as to measure any other substance; and, owing to its extreme mobility, its movement is effected more easily than most other matter.

The different ways by which this movement may be effected may be conveniently considered under two general heads—the vacuum movement and the plenum movement.

The Vacuum Movement—Aspirating Chimneys.—The act of animal respiration is a pumping or vacuum-forming process. As the respiratory cavity is enlarged by muscular effort, the air rushes in to fill the vacancy thus made. Chimneys which serve the purpose of removing smoke from a fire, or the foul air from a room, are therefore called aspirating, because they imitate in a certain way the breathing out of the internal impurities.

The vacuum-forming power in chimneys, instead of muscular action, is the expanding power of heat, which lightens the air in the chimney when the outside heavier air pushes it upward. The use of the aspirating chimney is evident. It is plain that if the air of a room has communication with a chimney by an opening leading into it where the air is hot, rare, and rising, it will be drawn out and up to the outside air.

The velocity of the air-currents produced by natural ventilation, described above, can by this means be greatly augmented. The utility of downcast shafts for the purpose of securing pure air is in ordinary natural ventilation greatly lessened by the friction which air encounters in passing through them; so much so, indeed, that they sometimes have to be discarded, being, when the friction is in excess of the drawing power, obstructionists instead

of promoters to ventilation. By the use of the aspirating chimney this difficulty may be overcome.

In Fig. 10, the fire on the grate *G* produces an upward current through the chimney *D*. This draws the air

FIG. 10.

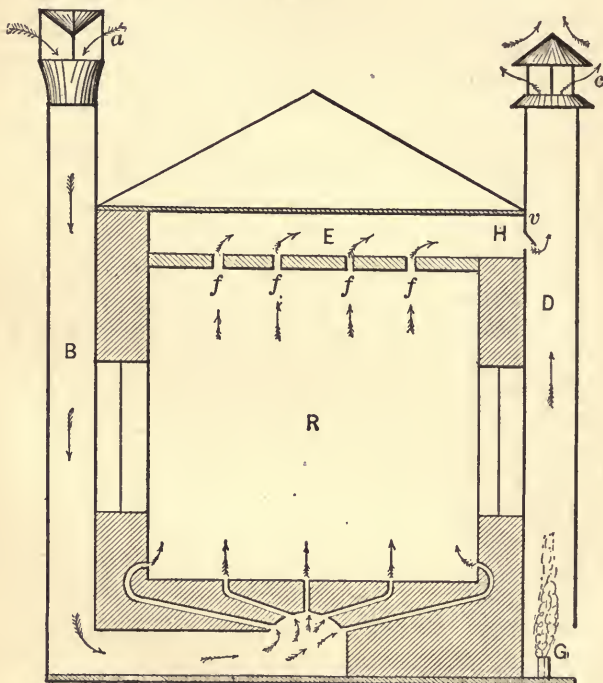

from the tube *E*, into which the foul air of the room flows, through the openings *f*. The partial vacuum thus formed in the room causes the air to flow down the shaft *B*. The downward and upward cast cowls, *a* and *c*, described above, aid further in facilitating the movement. The

figure is only intended to illustrate the principle. The details must, of course, be modified in each case to suit circumstances, without violating any of the laws which give to the aspirating chimney its main value.

The main principles which the figure illustrates are : the air is taken from an elevated source, it is admitted below, and is distributed around the room. It rises and passes out naturally at the top of the room into the partial vacuum made in the chimney by the heat from the fire at G. The tube E is sometimes carried down to the base of the chimney before entering it ; the object of this being to prevent the reflux of smoke sometimes resulting from sudden changes of conditions, as the wind, rapid lowering of the temperature, etc., producing a temporary reversal of the current down the chimney. This may be effectually prevented by adjusting at the aperture H a valve *v* opening toward the chimney. This, when uninfluenced by currents, should hang naturally, closing the aperture by its own weight, yielding readily to a slight pressure of a current from the direction of the room, and closing effectually against a pressure from an opposite current, thus shutting off the smoke resulting from down draught. This method of removing the foul air was first put in successful practice by Dr. Reid in his class-room in Edinburgh. The English House of Commons is ventilated on the same principle.

There are other advantages in carrying the foul-air tube directly into the chimney instead of carrying it downward. The friction resulting from lengthening the tube, and the inclusion of two more elbows, would materially lessen the draught; furthermore, it has been proved by experiment that the draught in a chimney is greatest near the top, directly under the roof. This may be due partly to the increased velocity of the hot air in the chimney near

the top, caused by an upward acceleration acquired in rising, and partly to diminished resistance to the air as it nears its point of release from the confining walls of the chimney.

It may at first appear contrary to known laws that the velocity of a rising column of air should be accelerating, but a moment's consideration will be sufficient to understand the paradox. Acceleration will always occur when a body free to move is acted upon by a constant sufficient, as the action of gravity on falling bodies.

The space passed over in unit time, taken at any period of a body's movement, will be measured by the initial velocity due to the constant, plus the velocity previously acquired. Now, a body which has a tendency to rise will accelerate so long as the tendency is constant. Thus, a cork, or other light body, in rising from a great depth in water, would have a greater velocity when near the surface than when it first began to rise. The cause of its rise is the difference between the pressures on its upper and lower surfaces, but as this *difference* is always the same, whether at a great depth or near the surface, it is a constant which augments at every instant the velocity already attained.

Montgolfier's formula, $v = \sqrt{2gh}$, is, under the supposed conditions, as true of rising as of falling bodies—remembering that g , instead of being 32 feet, now represents the distance the body would rise the first second. This would, of course, depend on the specific gravity of the substance, and would need be determined experimentally. The case of the air in the chimney is a little different from the one supposed, unless it be that the source of the heat be equally distributed along the whole length of the chimney. When the source of heat is as usual at the bottom, each particle of air loses some of its heat, and

therefore some of its tendency to rise in passing out ; but the retardation due to this cause is slight in comparison with the momentum which has been stored up by previous impulses. Even this loss of heat may not occur if we are to credit the testimony of practical architects. E. E. Rice, of Washington, inventor of a system of ventilation, says : "I find in practice the highest temperature immediately below the level of the roof." If this be true, it furnishes still further reason for upward acceleration.

In some systems of heating and ventilating now in use the foul-air tubes are carried down and admitted to the chimney beneath the fire. It might at first seem that this arrangement would give a stronger draught, on account of the fact that this air is depended upon to supply the combustion in the chimney, but when wholly depended upon for this purpose the fire will lack much of that vigor of combustion upon which the aspirating power of the chimney will mainly depend. Air which has already been robbed of much of its oxygen, and been contaminated with the products of respiration, is a poor supporter of combustion. It appears, therefore, that in order to give the chimney its greatest aspirating power, the fire should be fed with pure air. It is as poor economy to feed a fire with CO_2 as to feed pupils with it. Whatever intensifies the fire increases the draught.

The power of a strong upward current of air in a chimney to abstract air from tubes opening into it will be better appreciated by remembering that some of the most effective air-pumps are constructed on precisely this principle. An almost perfect vacuum can be made in a vessel leading by a tube to another tube through which a column of water is falling. In Bunsen's pump, constructed on this principle, water is used ; and in Sprengel's, mercury. In an aspirating chimney the moving

current is gaseous instead of liquid, and, although less effective, is sufficiently so to create a powerful draught. In view of this fact, it might be better in a house above one story to carry all the ventilating tubes to a main tube extending up nearly to the roof before opening into the chimney.

Owing to the fact that the momentum of columns of air is proportional to their volume, aspirating chimneys should be built as high as convenient. Where buildings are heated by steam, the draught in aspirating chimneys may be created by carrying steam jets into them; the escaping steam causing a partial vacuum, which is filled by air coming from below toward the direction taken by the steam. See Fig. 11, where C represents the aspirating chimney, B the boiler, F the furnace, D the air-duct.

FIG. 11.

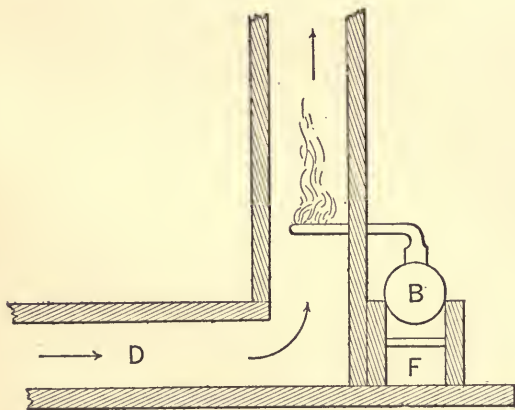

The arrows show the direction of the current. The steam thus issued into a chimney will set in motion a body of air about 217 times its own bulk. When steam is used,

the foul-air tubes would perhaps better be placed below the jets, as it would in this case be no interference to combustion, and the chief vacuum-producing power is, in this case, where the steam is escaping.

In buildings furnished with burning-gas, a few jets kept burning in a chimney are often sufficient to produce the requisite draught. In summer this will be all-sufficient. General Morin found that one cubic foot of gas is sufficient to set in motion 1,000 cubic feet of air.

Where buildings are heated by steam, it is better to run a coil of steam-pipe into the base of the shaft. The following formula, deduced by Prof. W. P. Trowbridge, may be found useful for determining the amount of steam-pipe necessary to be put at the base of an aspirating chimney in order to maintain the desired draught:

$$S = \frac{WTa}{H(Ts - Ta)} \times 1,500$$
, where S = number of square feet in exterior surface of the coil at the base of the chimney; Ta = absolute temperature of the external air—that is, the common or thermometric temperature plus 459.4° ; * W = weight of air in pounds which is discharged in 1 second; H = height of flue; Ts = absolute temperature of the steam in the pipe. The constant 1,500 is determined from other constants which were employed in de-

* The absolute temperature is obtained from the relations which exist between the temperature of a body and its rate of expansion. If air at 0° C. be heated, its volume will be increased $\frac{1}{273}$ of its original volume for every degree raised. Then its volume will be doubled when 273° is reached. If it be cooled below 0° , its volume will be diminished $\frac{1}{273}$ for every degree lowered. If this diminution should proceed at the same ratio till -273° is reached, its volume would be nothing. This is, of course, true only theoretically, as it is impossible to freeze matter out of existence. But this point is taken as *absolute zero*, which when used makes all temperatures positive. Reduced to the Fahrenheit scale, it is 459.4° .

ducing the formula ; they were : the force of gravity, specific heat of air, ratio of transfer of heat to air by coils, and the ratio between the theoretical and actual velocity in the flue.

Steam-coils are used for the purpose here named in Columbia College, New York, where the heating and ventilating apparatus was arranged by Prof. Trowbridge. They are also used in the Johns Hopkins University of Baltimore.

It is always best when possible to have the ventilating-flue combined with the smoke-chimney, so as to utilize the heat of the waste products of combustion. When heat from this source is insufficient, it can be supplemented by the use of the steam-coils.

CHAPTER XII.

THE MOVEMENT OF THE AIR BY MECHANICAL MEANS.

The Vacuum Movement.—A current of air through a room for the purpose of ventilation is sometimes produced by putting into the ventilating or foul-air duct an extracting fan, Archimedean screw, pump, or blower. Such an arrangement may take the place of an aspirating chimney, or by being put into the chimney become a part of it, supplementing its draught-producing function. The function of mechanical propellers, when put in the foul-air duct, is always the same, that of producing a partial vacuum in the room by extracting the foul air, thus making room for a fresh supply, which will find its way in by openings provided for that purpose.

When mechanical means are thus made use of, it of

course makes no difference, in the rapidity of change which the air in the room will undergo, whether the propeller be placed in the foul-air duct and draws the air through the room, or whether it be placed in the fresh-air duct and pushes the air through the room, for in either case the propeller moves the same quantity of air.

Whatever is forced in must find a way out, and whatever is drawn out must be supplied by inlets. When air is thus drawn out, it is a vacuum-forming process, and the pressure of air on the inner parts of the room will be somewhat less than that on the outside. Currents of air, therefore, through small openings, cracks, windows, as also from halls, closets, etc., will be inward; the quality of the air, therefore, will be determined by the character of the inlets, and the function of the intended inlets may be usurped by an open door delivering air too cold, an open closet delivering impure air, or an elevated crack or other opening delivering air too high up to be utilized, and so drawn out unused.

Another objection to this manner of drawing the air through the room, especially where the draught is from several rooms, is that the draught will not be equal. In rooms which have their inlets through tubes comparatively short, where the incoming air encounters very little friction, the supply will be ample and at the expense of more remote rooms to which the air must pass through long tubes and perhaps pass abrupt angles. The relative draught will also fluctuate with changes in the force and direction of the wind, sometimes favoring one side of the house, sometimes another.

The Plenum Movement.—Instead of drawing the foul air from the room by placing the propeller in the exit shaft, the pure air may be forced in by placing the propeller in the inlet duct. This may be called the *plenum*

movement, and produces in the room a perflating instead of a vacuum-forming tendency.

The plenum has many advantages over the vacuum movement. In this movement the atmospheric fullness in the room, produced by perflation, causes all currents through accidental openings to be outward instead of inward, thus preserving the air of the room from the incidental external impurities of closets, cellars, basements, etc.

The plenum movement has not received the attention which its usefulness demands. Much as may be said in favor of natural ventilation, and evident as it is that all successful ventilation must depend on a studious and skillful conformity to the few natural laws underlying the whole process, it will still remain questionable, after everything possible has been done to produce draught by differences of height and temperature, whether it is possible to supply at all times a large school-house full of pupils with air of the necessary quantity and quality.

We have seen in preceding pages how fast air must pass through a room in order to supply the requirements of respiration. We have also seen that this current must be properly distributed and be of a certain temperature and humidity. Now these conditions are approached in different degrees by different systems of heating and ventilating; but *in no system has the ideal been reached without the aid of mechanical means.*

There are many good systems now in use, the inventors of which deserve great credit for much good work toward solving the great problem of warming and ventilating. But the efficiency of none of these systems is quite commensurate with the claims of their inventors. The comparative merits of some of the best systems now

in use are discussed in another place, where the principles involved in each are examined.

The assertion which I here venture, that perfect warming and ventilating has not been attained without the aid of mechanical means, is easily demonstrated on general principles. What is implied in perfect ventilation? As an example of it, we might suppose the case of a balmy spring day, when a gentle breeze, barely perceptible, is passing through the wide-open opposite windows of a room situated in a salubrious locality. In this case the air is of a genial warmth. It has not been blown across a burning desert or through an artificial furnace. It does not enter the room scorching hot, where it mixes with other air icy cold. It is not kept in the room till it has become dangerously impure; but in passing directly through it gathers the impurities of the passing breath and carries them away as fast as formed, leaving the room while still in a state of respirability.

Now this may be produced artificially, by warming the air to the proper temperature and forcing it through the room by mechanical means, but by any other means now in use it is impossible. A little reflection will make this plainly evident.

We have previously seen that when adequate ventilation is maintained by an upward current through the room, it is caused mainly by the difference between the internal and external temperatures and the vacuum-producing power of aspirating chimneys. But how is this difference of temperature in very cold weather to be produced? If by stoves, the temperature in different parts of the room will be unequal—some parts hot, and other parts cold; if by the direct radiation of steam pipes, the entering air is cold, and, although it be warmed by passing over the heater, it will be warmed unequally

and imperfectly. If by warm air entering the room, it must enter fast enough to change the air in the room about every seven minutes; but air of this temperature will not enter thus rapidly by any ordinary medium of pipes and tubes, on account of friction, etc.

The main cause of the inflow of the warm air is the difference of its specific gravity due to heat. For the inflow to be rapid the heat must be great, but hot air must be ruled out of the legitimate conditions of perfect ventilation. It is, I think, possible to pass air not above a temperature of genial warmth when it enters, in sufficient quantities to serve the ends of ventilation, and sufficiently to warm the room in cold weather, but it requires a different arrangement of pipes and furnaces than has yet been put in practice, and might exceed in cost a good plenum movement.

CHAPTER XIII.

AIR-PROPELLERS.

THE problem of setting in motion quantities of air sufficient to supply the requirements of ventilation, and to so direct this air as to approximate a maximum of movement with a minimum of expended power, is a mechanical problem which becomes important in considering the plenum movement, both from the standpoint of work accomplished and the economy of accomplishing it.

Of propellers for moving air, many kinds have been used, among which may be mentioned those of Combs, Rittenger, Hales, Letoret, Howorth, Roots, Glepin, Arnett, Chaplin, Perrigault, Lloyd, Fernie, Hendry, Hope,

and Blackman. Most of these are in some form of revolving fan, the floats of which are so placed as to set in motion the air outward radially, thereby creating a partial vacuum near the axis, thus setting more air in motion as it is filled.

The object of a propeller is not only to set in motion large quantities of air, but to set it in motion in such a manner as not to produce loss by opposing counter currents and by useless friction. Air, on account of its extreme mobility, requires primarily very little power to move it, but when it is forced through small apertures, or set in motion in such a way as to produce cross currents, great power may be required to accomplish a little work. Dr. Arnott observed this in the working of revolving fans, and invented a ventilating pump which he put in operation in a hospital. So conserved was the power by the construction of his propeller that the entire building was supplied with air by the motive power derived from the descent of the water used in the building from a high reservoir to the basement. It may be remarked here that everything which Dr. Arnott devised for the improvement of ventilation possessed singular and unusual merit.* Since Dr. Arnott's time, however, considerable improvement has been made in revolving fans and other propellers.

* As before mentioned, Dr. Arnott never secured the exclusive right to his inventions by letters patent, but in a true philanthropic spirit gave the results of his labors to the world. It is doubtful, however, whether this did not hinder rather than promote the propagation of his ideas. It is noteworthy that while these inventions are acknowledged to be superior to most others, and are free to everybody, they have been comparatively little used. Had the worthy author secured his inventions by letters patent everybody would be ready to scrutinize their merits and pay the price; but when a gift is offered it is little regarded, so prone is human nature to think it impossible for a man to give away that which is of value.

The objection which has heretofore been made to the plenum movement is its expense. Owing to the extreme mobility of air, the power required in merely moving it is theoretically almost nothing; the expense, then, must result from the *manner* of moving it—from forcing it through small apertures, and from friction and collision due to misdirecting it. The construction of the machines for propulsion is, therefore, of so much importance in the economy of mechanical ventilation that I shall notice at some length the construction and efficiency of some of the earlier and later types of revolving propellers.

Rittenger's Fan.—Fig. 12 represents Rittenger's fan. A is a side view showing the shell *y*, which is of the form

FIG. 12.

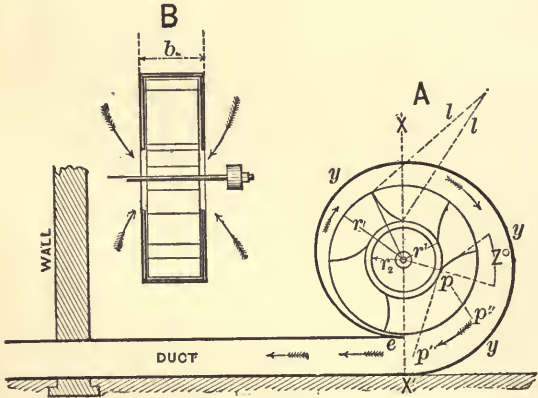

of an Archimedean spiral, beginning at *e*; the radius of the inlet r_2 , the outer and inner radii of the vanes r and r^1 , the radii l of the curve of the vanes; the angle z° between the radius and the initial line of the vane. B is a section on the line xx' . The arrows show the direction of the current,

The construction of this fan shows that its design is, first, by the angle z , to produce a motion of the air radially, producing a vacuum-forming tendency at the center, causing the air to be pushed in toward that point from the outside; and, second, by curving the vanes forward, to direct the tangential motion of the air as far as possible toward the outlet duct.

To understand the action of the vanes on the air, suppose a single particle of air at p struck by the vane as it reaches that point in its revolution. If the angle z° were 0, then the particle would be impelled forward on the tangent $p'p$; but as the angle z° increases, the direction taken by p will be more radial, the amount of this change of direction being proportional to the sine of z° , the relation holding between 0 and 90° . If the vanes be straight, increasing z will give the air a receding tendency; this the curve is intended to prevent. Now, the nature of this curve is of course important. Its radius of curvature

is expressed by Rittenger by the formula $l = \frac{r^2 - r_1^2}{2r_1 \sin z^\circ}$,

where $r =$ outer radius of the vanes, $r_1 =$ inner radius of the vanes, $z^\circ =$ the angle between the radius and the initial line of the vane, and $l =$ radius for the curvature of vanes. The formula shows that as the vanes are narrowed, or as $r^2 - r_1^2$ is diminished, l will decrease. Reference to the figure, with a little mechanical conception, will prove the general correctness of these relations. For, if we imagine r_1 to be increased, thus narrowing the fan, the particle of air p will have its distance from the shell diminished, so that when deflected radially by increasing z° it would have a sharper curve to give it the required forward impulse than when it started from a greater distance, giving more time for deflection.

The formula shows, further, that as $\sin z^\circ$ (or z°) is

increased l will be diminished. Referring to the figure again, the reason becomes evident. For as z° is increased the particle of air p will be deflected more radially; to counteract this before the circumference is reached the curve must be made sharper— l must be lessened.

The effect which in this fan is realized in practice is about forty per cent of the power expended. Yet this is one of the best fans which have been thoroughly tested. Surely there is an open field in the economy of applied power for the mechanical engineer.

In this fan, it appears to me that much of the loss of effect comes from beating the air too much radially, and not enough tangentially; or, rather, that the radial and tangential forces are not properly distributed. In this case the direction of the impulses is too much outward on the shell, and not enough forward toward the duct. Now, this can be partially corrected in making the curve of the vane elliptical instead of circular, where each vane comprises one fourth of the ellipse. I would therefore propose the following modified formula: $l = \frac{(r^2 - r_1^2) e}{2 r_1 \sin z^\circ}$, where l = semi-major axis of the ellipse, e = the ratio between the major and minor axes, and r , r_1 , and z° = same as in the preceding. This relation shows that e increases with the width of the vanes, and also with the length of the semi-diameter of the curve.

The amount of work which is required to deliver any given amount of air by means of fans may be calculated by the formula $\text{Hp.} = \frac{62.5}{550} \times \frac{100}{x} \times V h$, where Hp. = number of horse-powers, 62.5 = weight of a cubic foot of water, 550 = number of pounds in one second by one horse-power, x = per cent of efficiency, V = volume of air delivered in cubic feet per second, h = the relative

weight of the air compared with an equal bulk of water. As the air is denser than normal when being forced through the ducts, h must be determined by the manometer. V can be found by means of an anemometer. (See Appendix C.)

Combs's Fan is of different construction, but as its per cent of efficiency is somewhat less than that of *Rittenger's* it will not here be discussed.

FIG. 13.

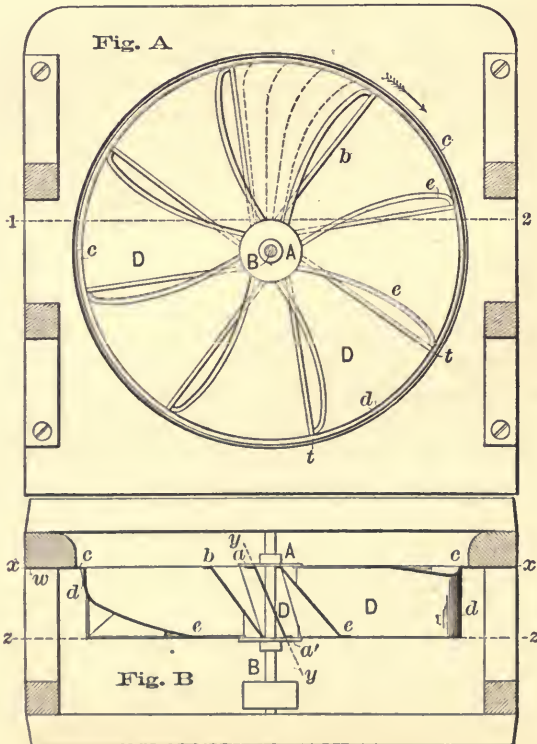

Blackman's Fan (see Fig. 13).—As an example of modern improvement in revolving fans, I copy from the patent-office specifications the description of what seems to me one of the best yet constructed (see Appendix F).

The Hope Fan.—An improvement on the Blackman Fan has recently (1886) been patented by Hope Brothers, of Kansas City, Missouri. The improvement consists of a slight modification of the vanes, and the conversion of the whole fan into a water motor, which is the power used.

This fan motor undoubtedly possesses some advantages over any other yet devised. It can be used either as an exhauster or a perflator, and, by being placed directly at the entrance into the room, the loss from friction of moving air through long ducts is prevented. By applying the power at the circumference of the wheel, instead of near the center, as is usual when belting from an engine, much power is gained, especially when a relatively small quantity of water is used under high pressure.

Of course, when other things are equal, no gain would be realized by applying the power at the circumference, as what is thus gained in power would be lost in velocity, but in the case supposed, where a small stream of water under high velocity is used, much of the effective power will exist in its *vis viva* as it strikes the buckets. Now, as the *vis viva* is proportional to the mass of the moving body, and to the square of its velocity, the increase of velocity will be more effective than an increase of mass.

One of these fans is adequate to move the air of a school-room of ordinary size. It can be run for five cents per hour, as proved by actual experiment in Kansas City, when the water pressure is eighty pounds.

Patent of Hendry and Others.—One of the most advantageous arrangements is to put the fan in the angle of

the shaft and ventilating duct, as illustrated in Fig. 14. The advantage gained in this arrangement consists in car-

FIG. 14.

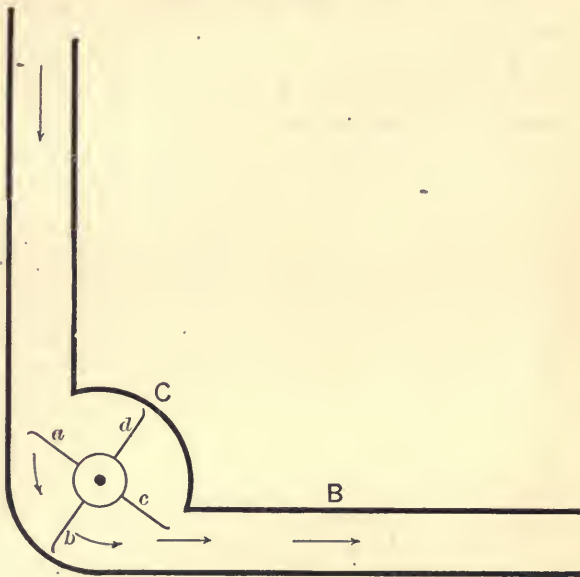

rying the entering air only one fourth of a revolution before releasing it.

In the figure, the arrows show the direction of the fan's revolution, and also the direction taken by the air. As the vane *a* is moving forward in its present position it carries in front of it the air in the lower part of the shaft A; the tangential motion which the revolution gives to this air will, when one fourth of a revolution has been made, send it through the duct B. This manner of placing the fan is used by A. J. Hendry, of Georgia, in an invention patented in 1883. The amount of friction

which this arrangement obviates would allow the use of clock motors which could be wound up at stated intervals. A shaft and tube could be supplied each room, and the motors thus distributed would furnish ample power for propulsion.

The plenum movement, so far as at present attained in practice, will deliver from fifty to one hundred and fifty cubic feet of air per horse-power per second. But these estimates have been made irrespective of accompanying effects of natural ventilation. In arranging for the plenum movement every provision should also be made to derive all possible aid from natural movement. Whenever it is possible to ventilate by natural means, the mechanical means could be suspended. It should be the object of the plenum movement to supplement the natural, not to replace it. By working with Nature as an aid the amount of power required would be greatly lessened.

CHAPTER XIV.

CAN THE PLENUM MOVEMENT BE AFFORDED?

IN order to answer this question understandingly it will be necessary to enter into somewhat lengthy detail concerning the amount of heat needed, the amount of unavoidable waste, and the amount of fuel necessary to the supply; then to consider the cost of adding thereto the cost of the plenum movement, and to compare the total estimate thus made with present expenditures.

In making these estimates I shall consider a single room, of average size, and supposing the average conditions as to exposure, number of windows, locality, etc. The

TABLE OF TEMPERATURES.

STATION.	MINIMUM AND MEAN TEMPERATURES OF EACH MONTH.												No. of months fire is required.	Mean temperature of fire months.	Average number of degrees temperature to be raised.	Maximum number of degrees temperature to be raised.												
	Jan.		Feb.		Mch.		Apr.		May.		June.						July.		Aug.		Sept.		Oct.		Nov.		Dec.	
	Minimum.	Mean.	Minimum.	Mean.	Minimum.	Mean.	Minimum.	Mean.	Minimum.	Mean.	Minimum.	Mean.					Minimum.	Mean.	Minimum.	Mean.	Minimum.	Mean.	Minimum.	Mean.	Minimum.	Minimum.	Mean.	Minimum.
Albany, N. Y.	-16.24	-18.25	4	35	13	47	29	60	40	68	48	72	45	70	33	61	23	49	10.39	-17.28	35	87						
Baltimore, Md.	3.31	3.32	0.39	23	52	34	61	49	71	59	75	52	75	40	67	30	55	16.44	1.34	31	72							
Boston, Mass.	3.27	3.28	2.36	11	46	32	57	44	66	46	72	50	69	35	62	26	51	2.40	-11.30	31	81							
Buffalo, N. Y.	5.28	-13.28	3.30	13	34	29	52	41	64	47	69	46	68	21	65	25	48	2.31	6.30	35	83							
Burlington, Vt.	16.20	30.20	1.31	10	42	30	55	43	65	47	70	45	68	32	60	22	48	-10.86	-18.24	38	90							
Chicago, Ill.	-20.24	-13.25	5.32	17	46	27	50	40	63	50	71	52	68	37	60	25	48	0.88	-14.29	35	90							
Charleston, S. C.	26.52	26.52	13.43	18	54	36	64	49	71	60	70	63	79	57	70	39	64	28.55	23.51	3	47							
Cincinnati, O.	7.33	11.33	0.37	15	39	28	60	42	70	50	72	46	70	38	67	26	51	6.42	6.34	7	77							
Cleveland, O.	-15.27	-20.27	2.35	8	46	29	56	38	66	50	70	45	67	35	60	22	48	4.88	9.27	7	83							
Detroit, Mich.	-38.13	-34.16	-25.24	3	33	26	50	36	58	46	68	45	64	34	59	21	43	-29.24	-30.20	8	108							
Indianapolis, Ind.	-18.86	-8.36	9.42	19	46	31	66	45	77	54	78	48	70	35	70	25	51	2.37	-15.37	7	88							
Key West, Fla.	50.68	53.74	54.76	61	78	63	80	73	88	73	83	73	84	72	75	65	76	52.73	44.71	0	26							
Leavenworth, Kan.	-20.28	-9.29	2.40	20	49	31	67	37	54	83	55	81	67	42	72	28	54	3.42	4.32	0	33							
Louisville, Ky.	-10.37	0.39	16.46	21	49	36	68	49	81	58	81	56	79	42	72	28	54	10.41	-5.39	0	42							
Memphis, Tenn.	2.45	13.45	18.53	35	55	44	72	53	81	62	83	63	82	44	73	30	56	25.49	3.44	5	31							
Milwaukee, Wis.	-25.25	-22.29	3.35	12	41	25	51	40	65	50	70	48	67	32	61	23	51	-14.88	-19.23	8	95							
New Orleans, La.	26.56	32.59	36.66	48	66	56	76	67	81	70	81	70	84	59	79	40	68	39.61	28.57	0	44							
New York, N. Y.	6.30	1.30	8.38	20	49	34	59	49	68	57	75	53	73	42	66	31	54	7.43	2.33	7	40							
Philadelphia, Pa.	5.32	1.33	9.42	21	51	36	59	49	69	60	73	55	71	45	64	28	51	8.41	4.33	7	40							
Pittsburgh, Pa.	-12.20	-10.31	2.39	14	50	27	61	43	69	52	73	49	71	36	64	28	51	8.41	6.31	7	39							
Portland, Me.	7.20	7.21	1.30	14	40	34	50	42	59	51	66	48	65	37	57	28	46	4.85	-12.24	8	33							
San Francisco, Cal.	36.49	41.51	41.51	40	55	45	58	48	59	49	59	50	61	49	59	59	59	44.57	39.51	4	53							
St. Louis, Mo.	-16.33	-3.35	8.44	23	58	32	66	48	74	57	78	55	70	40	69	25	55	11.41	-5.34	5	37							
St. Paul, Minn.	-30.14	-32.14	-15.34	7	37	24	62	39	69	46	75	43	70	30	61	21	41	24.26	-27.19	7	25							
Washington, D. C.	3.34	2.37	12.45	22	56	38	66	46	74	58	78	50	76	40	68	26	57	16.45	3.37	5	40							
Wilmington, N. C.	17.50	15.48	22.57	28	63	48	70	53	80	63	79	56	77	50	74	32	61	28.52	15.40	4	50							
Portland, Or.	3.43	24.44	31.45	28	54	36	60	46	68	46	68	43	65	39	61	32	50	27.47	17.37	0	43							

table on page 91 shows the minimum and mean temperatures of each month, compiled from observations of the Signal Service, U. S. A., and Blodgett's "Climatology of the United States." As the table shows, the amount of heat required depends partly on the latitude and locality of the place. I select for our estimate that of Chicago, as representing a high average, but, of course, at places far north or south, other figures will be found in the table which will be more appropriate. 70° is taken as the temperature of comfort, and to which existing temperature must be raised. Taking seven as the number of months fire is required; the average temperature of these months 35° ; then the average number of degrees of temperature to be raised will be $70^{\circ} - 35^{\circ} = 35^{\circ}$. Taking the average number of pupils in one room as 60, the cubic feet of air required in one hour will be $60 \times 3,000 = 180,000$. A thermal unit, or unit of heat, is the amount of heat required to raise one pound of water one degree. By careful experiment and comparison of the specific heats of air and water, it is established that this amount of heat—one thermal unit—will raise 48 cubic feet of air one degree.

Then $\frac{180,000}{48} = 3,750 =$ number of thermal units necessary to raise 180,000 cubic feet of air one degree, and $3,750 \times 35$, the average number of degrees to be raised, equal 131,250, the number of thermal units necessary to supply the occupants of one school-room one hour.

Loss through the Walls.—The formulas which it will be necessary to use in making these estimates may seem difficult, but they have been deduced from well-known laws and properties of matter familiar to every physicist, and formulated by the best European mathematicians. They are in practical use by skilled engineers everywhere. The loss of heat through walls, when all sides of the build-

ing are exposed, may be calculated from the formula $U = \frac{l_2 c q (T - T_1)}{C(2l_2 + r) + e l_2 q}$, where U = total units of heat lost per hour per square foot; l_2 = loss by contact of air for a difference of $1^\circ = .4912$ when the air is moving; C = conducting power of material (see table, Appendix D, page 167); r = radiating power of material (see table, Appendix E, page 168); $q = r + l_2$; T = temperature of air in the room; T_1 = temperature of external air; e = thickness of wall in inches. The loss of heat through floors and ceilings when not exposed to the external air is usually regarded as null. Taking 26 feet \times 34 \times 14 as the size of the average school-room, $120 \times 14 = 1680$, area of walls in square feet. Counting six windows, each $9 \times 3\frac{1}{2}$ feet, $9 \times 3\frac{1}{2} \times 6 = 188$, area of windows; $1680 - 188 = 1492$ square feet of wall surface. The wall is supposed to be 18 inches thick.

The values in this example to be used in the above formula will be $l_2 = .4912$; $c = 4.83$; $q = r + l_2 = .7358 + .4912 = 1.227$; $r = .7358$; $e = 18$ inches; $T = 70^\circ$; $T_1 = 35^\circ$. Then

$$U = \frac{.4912 \times 4.83 \times 1.227 \times 35}{4.83(2 \times 4.912 + .7358) + 18 \times 4.912 \times 1.227} = \frac{101.88}{19.13} = 5.32 = \text{thermal units per square foot per hour; } 5.32 \times 1492 = 7937.44 = \text{thermal units lost through the walls in one hour.}$$

Loss through Windows.—When the windows are not more than $\frac{1}{4}$ inch in thickness the following formula is used for finding the value of U : $U = q (T - t_4)$, where t_4 = temperature of the glass; $q = r + l_2$; r = radiating power of the glass; l_2 = loss by contact of air for a difference of $1^\circ = .4912$.

The values in this example are, $q = (r + l_2) = (.5948 + .4912) = 1.086$, $T = 70^\circ$; $t_4 = 3\frac{1}{2}^\circ = 17.5$; then $U =$

$1.086 \times 17.5 = 19 =$ thermal units per square foot.
 Area of six windows = 188 square feet $\times 19 = 3572 =$
 loss through the windows in one hour.

Total Loss.

From incoming fresh air	131,250
From walls.....	7,937
From windows.....	3,572
	<hr/>
Total thermal units.....	142,759

Now, in the burning of one pound of coal 13,000 thermal units are evolved. The efficiency of a heating apparatus depends upon the amount of surface exposed and skill in firing. In practice, the efficiency of heaters is from 38 per cent to 80 per cent of the whole heat evolved. Taking 60 per cent as a fair average of efficiency, $\frac{142,759}{13,000} \times \frac{100}{60} = 18.3+$, number of pounds of coal required for one room for one hour. From this as a unit the cost for a building of any number of rooms may be obtained.

For example, counting seven the number of fire months, eight as the number of hours per day in which fire will be needed, \$5 the price of a ton of coal, the cost of heating a building of ten rooms would be,

$$\frac{18.3 \times 20 \times 7 \times 8 \times 5 \times 10}{2000} = \$512.$$

Now, under the conditions supposed, this will be the necessary expense ; any less would imply that the children and teachers are fed on impure air. To heat such vast quantities of air as the conditions of sufficient ventilation necessitates requires large expenditures of heat. There is no help for this. The rations of pure, life-giving air measured out to children shut up in close houses should be as certain a quantity as the daily allowance of bread and butter.

By examining reports of school boards from various cities I find that the expenditure above calculated is not far from the actual average cost of supplying such school-houses similarly conditioned. That is to say, the present expenditure for fuel is sufficient to supply the most rigid demands of sanitary ventilation.

We are not ready, however, to conclude that all is well. The coincidence of these facts proves nothing. There would have to be an important additional element to make these two first facts possess a causal relation to each other. If the school expending this amount of fuel should be visited by an expert who, after examining the air, testing for CO₂ and noting the rate of renewal, found that the air was being renewed every six to seven minutes, and the CO₂ not above .2 per 1000 of air, then the conclusion would follow that the expenditures had been made economically.

But, unfortunately, this important third element is wanting. The real facts are too well known to admit of any mistake here. Instead of the air of the average school-room being changed every six minutes, it is not changed oftener than once in thirty minutes, and more frequently probably not oftener than once per hour. In thousands of houses it is not changed at all, just enough air working its way in by diffusion to prevent immediate death by suffocation.

These are the facts. It would be tedious to enumerate the commissions which have from time to time in different parts of the world been appointed to investigate this subject. While there is variety in the character, number, and locality of these investigations, there is singular unanimity of results. The invariable verdict of all may be epitomized as *bad*, BAD, BAD! Some are better than others (or, rather, some are not so bad as

others), but the difference is rather in degree than in kind.

The question which now confronts us is, What became of the heat from all of that coal? There is but one answer: *It was wasted.* There may be many sources for this waste. Windows and doors are thrown open to relieve the temporary inconvenience of a depressing atmosphere. These openings, especially when near the heater or incoming warm air, at once become outlets, setting the current toward them, and drawing out the warm, pure air as fast as furnished.

Too small heating surfaces or unskillful firing may also be causes of waste. Overheating the air and confining in the top of the room (as is the practice of some hot-air systems) till it cools down to the temperature of comfort is a positive waste by conduction through the upper walls and windows. The only way to utilize the excess of heat in supra-heated air would be to thoroughly mix it with such an amount of cold air as would be required to reduce the temperature to that of comfort.

In view of this state of the case, what is the remedy? How is the heat which is being expended to be utilized? The answer is evident. There must be some means whereby the air in a room may be changed with requisite frequency, and *this independent of the doors and windows.* The heating surface must be properly proportioned to the amount of fuel consumed in order to lessen the waste through the smoke chimney. Air must not be heated much above the temperature at which it is to be used, in order that there may not be loss in cooling.

We return now to the original question, Can the plenum movement be afforded? Can the extra expense of moving this air through the building be assumed by the people? This, it seems to me, is much like the

question of a man who, after having paid a high price for a stove, asked his wife if they could afford the coal to build a fire in it. Not to provide the means of utilizing expense already incurred is simply to waste this expense.

I am aware that many economize by an exact count of dollars and cents concerned in immediate expenditures. But to this question true economy has but one answer : *This air must in some way be moved.* If it can be done by aspirating chimneys, of proper size and construction, very well ; if not, it must be moved by mechanical means. At all events, *it must be moved by some means.*

CHAPTER XV.

THE COST OF VENTILATION.

Cost of the Aspirating Chimney.—Let us approximate the cost first of the aspirating chimney. We have seen (see Appendix B) that where the fresh-air inlets are of adequate area the velocity of the air in the ducts should be at least 7·7 feet per second, say 8 feet. Assume the height of the aspirating chimney to be 70 feet.

To find the sectional area of an aspirating chimney which is to take away all the air that passes in one hour,

we have $A = \frac{V}{36,000 v}$, where A = the sectional area of the aspirating chimney ; V = volume of air passing through the chimney per hour ; v = velocity of air per second in ducts ; 3,600 = seconds in one hour. Then the sectional area of a chimney required for a single room in our example above is $A = \frac{180,000}{3,600 \times 8} = 6\cdot2$ square feet. The ve-

locity of the air will depend upon the difference of temperature between the air in the chimney and the air outside.

Now, the number of degrees temperature which the air in the chimney will have to be raised in order to produce a velocity of 8 feet (or other given rate) may

$$\text{be formulated : } t_3 = \frac{v^2 (1 + e t) \left(1 + f \frac{l}{d} + f_1 \right)}{2 g h} - (t_1 - t),$$

where t_3 = increase of temperature by fire ; v = velocity of air in feet per second in ducts ; e = expansion of air per 1° temperature = $\cdot 00203$; t = external temperature ; f = co-efficient of friction in ducts ; l = total length of ducts ; d = diameter of ducts ; t_1 = internal temperature of room ; g = accelerated gravity ; h = height of chimney ; f_1 = co-efficient of friction in elbows.

The corresponding values in our example are : $v^2 = 8^2 = 64$; $e = \cdot 00203$; $t = 35^\circ$; $f = \cdot 05$ (for rough flues) ; $f_1 = 4\cdot 5$ (assuming three square elbows, which is probably a fair average) ; $l = 180$ (this includes the height of the chimney, the height of the pure-air shaft, and the ducts) ; 180 is a fair average ; $d = 2\cdot 5$ (for estimate made on necessary size of total inlets, *q. v.*) ; $g = 32\cdot 16$; $h = 70$ feet ; $t_1 = 70^\circ$. Substituting these values :

$$t_3 = \frac{64 (1 + \cdot 00203 \times 35) \left(1 + \cdot 05 \frac{180}{2\cdot 5} + 4\cdot 5 \right)}{2 \times 32\cdot 16 \times 70 \times \cdot 00203} - 35 =$$

$$\frac{623\cdot 7795}{9\cdot 1398} - 35 = 33\cdot 35^\circ.$$

The quantity of coal necessary to produce any given temperature is expressed $K = \frac{t_3 s W}{u \%$, where K = number of pounds of coal per hour ; s = specific heat of air = $\cdot 238$; W = weight of air in pounds carried off per hour ;

u = units of heat utilized in one pound of coal when burned on a grate = 6000 ; $\%$ = per cent of loss by radiation through wall of chimney = $\cdot 9$.

Present values: $t_1 = 33\cdot 35^\circ$; $s = \cdot 238$; $W = 14,400$ pounds (weight of 1 cubic foot of air at 35° being $\cdot 08$, then $180,000 \times \cdot 08 = 14,400$) ; $\%$ = $\cdot 9$. Substituting : $K = \frac{33\cdot 35^\circ \times \cdot 238 \times 14,400}{5,400} = 21$, the number of pounds of

coal necessary to burn per hour on a grate in the chimney in order to secure sufficient ventilation.

This, it will be observed, is more by nearly 3 pounds per hour than was found to be required for heating. Evidently, then, coal burned on a grate in an aspirating chimney, for the purpose of creating a draft, is expensive. Can it be afforded? If there were no better way to accomplish the same work there would be but one answer : Yes, of course, it can be afforded, for the children and teachers must have air.

But this supposed expense is not necessary. Instead of heating the aspirating chimney, as heretofore described, it may be combined with the smoke chimney, which will generally, if properly constructed, be sufficient to heat the aspirating chimney to the required degree. This may be done, has been done, in various ways. The foul-air ducts may lead to an aspirating chimney built around the smoke chimney so as to be warmed by it. They may open directly into the smoke chimney, either above or below the fire, or they may be carried up to near the top before entering. On account of a possible tendency to smoke in windy weather, it is probably best to have the chimneys so arranged that the heat from the smoke chimney may be utilized in the aspirating chimney without direct communication between them internally. To effect this, I would suggest that the smoke and escaping heat

from the heater be carried off through a large number of small metallic tubes extending up through the chimney. The large surface thus exposed to the air inside the chimney would thoroughly heat it to the temperature required in an aspirating chimney.

In Fig. 15, C represents the wall of the chimney ; F, the furnace ; the lower arrows, the course through the

FIG. 15.

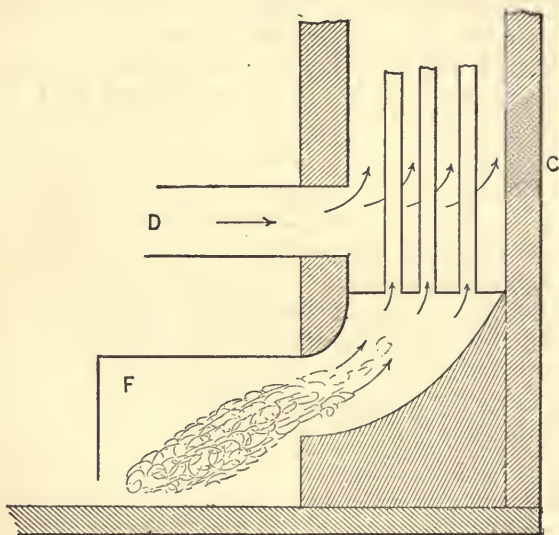

tubes taken by the smoke ; D, the foul-air duct leading from the school-room ; the upper arrows, the course between the tubes taken by the foul air. A number of small-sized stove-pipes would answer well for the tubes. In this case the chimney would have to be made large enough, so that a cross-section of the chimney, minus the sum of the cross-sections of the tubes, would leave a

remainder equal to the required size of an aspirating chimney.

The main trouble with aspirating chimneys has been from making them entirely too small. We saw above that the sectional area necessary for a single school-room is over 6 square feet. Calling it 6, then, for six rooms, it would be 36 square feet—6 feet square. For eight rooms, 48 square feet—nearly 7 feet square. For fourteen rooms, 84 square feet—over 9 feet square. In the arrangement above illustrated the necessary area for smoke-flues must be added to these numbers to obtain the size which the chimney would have to be built.

To calculate the area of smoke-flues, engineers usually use the formula $A = .128 \frac{K}{\sqrt{h}}$, where A = sectional area in square feet; K = pounds of coal consumed in one hour; $.128$ = a constant; h = height of chimney in feet.

The corresponding values in the present calculation are: $K = 18.3$; $h = 70$. Then $A = .128 \frac{18.3}{\sqrt{70}} = .279$ square feet = $.279 \times 144 = 40.1$ square inches. We found above that the necessary area of an aspirating chimney for one room is 6.2 square feet = 892.8 square inches; 40.1 inches being .044 of 892.8 square inches, the entire size of the chimney, including smoke- and foul-air flues, may be found by multiplying the necessary aspirating chimney area by 1.044. Then 6.2 square feet, the area of an aspirating chimney for one room, multiplied by 1.044 = 6.472 square feet. This is sufficient to show that the chimneys, when intended for the double purpose of carrying smoke and foul air, must be large and high. On this account, where there are more than six rooms in the same building, it is better to have two chimneys. It

thus appears from the foregoing that, by a properly-constructed aspirating chimney, ventilation may be, under favorable conditions, secured without additional cost for fuel. The attendant unfavorable conditions will be noticed presently.

Cost of the Plenum Movement.—Now, to calculate the cost of the plenum movement: If the Rittenger fan be used, and calling its per cent of efficiency 40—the value of x in formula for estimating Hp. (see page 86)—we have $\text{Hp.} = .28 V h$ (h = height of manometer). In the present example $V = 180,000$; $h = .08$ (taking the average). Then $\text{Hp.} = \frac{.28 \times 180,000 \times .08}{3,600} = 1.1$, say one horse-power for each room. In practice, it requires from 5 to 8 pounds of coal per horse-power per hour, so that the cost of moving the air by mechanical power would be about one third of the cost of heating.

This estimate is made without reference to recent improvements which have been made in fans and blowers for moving air more economically. The efficiency of the Blackman fan is doubtless as much as 70 per cent, and, with the Hope water-motor fan, where the water-pressure is as much as 60 pounds to the square inch, the cost would not be more than one third of that of the one above calculated.

It is also important to remember that, in this calculation, enough power has been provided to remove the air independent of the aid of aspirating chimneys. The aspirating chimney should be considered one of the essential parts of every school-house. It will cost nothing but the first cost of building, except in warm weather, when heating is not necessary; when, of course, means must be provided to build a fire in it for the sole purpose of creating a draft. The aspirating chimney always serves a

good purpose, and, in ordinary conditions, will be sufficient for all the purposes of ventilation ; but there will be times when it will not be wholly adequate. In windy weather it is impossible so to regulate the draft that all the rooms of a large building will be ventilated equally.

Again, it must not be forgotten that the aspirating chimney, drawing as it does the air from the room, is a vacuum-forming process, so that the incidental openings of doors and windows, as well as the crevices around imperfect fitting ones, necessarily become inlets, thus interfering with the draft through the inlets intended to admit the fresh warm air. (Let it be repeated and emphasized here, that in cold climates double windows should be provided. They lessen by one half the amount of heat lost by conduction through them, as well as shut off air-currents where they are not wanted.)

It becomes evident, then, that in systems now in use the plenum movement is necessary as a supplement to the aspirating chimney. This gives a fullness of air in the room, restoring the balance between internal and external air, made unequal by the aspirating chimney when acting alone. It also establishes the current independent of accidental openings, and prevents interference to draft in windy weather. When thus working with the chimney, the power required is of course much less than when alone doing the whole work of moving the air. It should be under the control of a competent janitor, who could regulate its working to suit existing conditions.

Considering, then, the plenum movement as a supplementary aid, taking advantage of modern improvements in propellers, and supposing the adjustments to be supervised by one who understands the principles of ventilation, there remains no room for doubt as to whether this method of ventilation can be afforded. It not only can

be afforded, but it should be regarded as indispensable. Nothing is more needed in this age than a general enlightenment on this subject of ventilation. Ignorance of employés should be no excuse for deferring necessary improvements. The improvements are needed by the public. The public are willing to pay for them, and there are persons competent to make them. When this kind of service is demanded, the supply will follow as a natural consequence.

CHAPTER XVI.

WARMING.

Heat : The Amount needed for Comfort.—The degree of temperature most conducive to health is not a constant. The temperature varies not only for different individuals but for the same individuals at different times. A youthful, healthy adult, actively employed, will be comfortable at a temperature of 60° , while elderly persons or invalids require a temperature of 68° to 75° . Children generally require a higher temperature than adults, and this especially when they are bodily inactive, as in the school-room. It is impossible to fix the temperature of a school-room to suit the changing conditions and individual characteristics of all, but some degree must be maintained which most nearly approximates the average necessities. A temperature of 70° is generally considered the proper degree for school-rooms ; it is probably as nearly correct as any fixed temperature can be.

The relative humidity of the air has something to do with the temperature which will be most conducive to

comfort. In a moist atmosphere a temperature of 65° would probably seem as warm as 70° in a dry atmosphere. It is worthy of remark here that many medical authorities think that the American tendency is to overheat our houses, and that a much lower temperature than that generally maintained would be more healthy. Feeling is, no doubt, the truest guide to the proper temperature. The body should be made comfortable, even if a higher temperature be required than is thought normal. If an individual's circulation is so sluggish as to require a high temperature to maintain comfort, the remedy is not in an immediate deprivation of the heat, but in removing the desire for it by exercise and due attention to the laws of health.

The Transmission of Heat.—Heat is transmitted in three ways—by conduction, by radiation, and by convection. By conduction, heat passes through bodies from particle to particle, without any change of relative position between the particles. Heat applied to one end of a metallic rod passes through its entire length. The facility with which heat passes by conduction depends upon the nature of the medium through which it passes. All substances conduct heat, but some so slowly that they are sometimes called non-conductors. In general, the metals are good conductors, while air, water, and dry vegetable fabrics, such as wood, cotton, etc., are bad conductors.

The conductivity of bodies usually diminishes as the temperature is raised, though no definite laws of the rate of this decrease have been formulated. This fact becomes important in house-heating, and furnishes another objection to overheating stoves and heaters; for while in this condition they not only become pervious to poisonous gases, but by their diminished conductivity compel the heat to seek an exit through the chimney instead of con-

ducting it into the room. In selecting stoves and heaters, due precaution should be exercised on these two important points, thus securing a maximum of heat, and a minimum of escaping gases. Heaters should therefore be large, so as to furnish a large surface moderately heated, instead of a small surface highly heated. They should be lined with fire-clay or brick, to intercept the poisonous carbonic oxide and other gases. By the conductivity of iron the heat stored up in steam or hot water is utilized in a room after having been carried some distance from the source of the heat. It will also be a source of great waste if the convey-pipes leading to the several places where heat is wanted are not packed in some non-conducting material, to prevent the escape of heat into places where it is not wanted.

Radiation.—Radiant heat differs from conducted heat in several ways. While conducted heat requires a sensible medium for its transmission, and a time which is determined by the nature of that medium, radiant heat requires no such medium, and travels with the velocity of light. Radiant heat will perhaps be better understood by a few introductory remarks on light, with which radiant heat is probably identical. Without entering into a discussion of radiant energy, it may be said that all experimental observation thus far serves to corroborate the theory that light is a mode of molecular motion in a subtle medium not cognizable to the senses and permeating all space. It travels at the rate of 185,000 miles per second. Its effects on life are well known, it being the prime active agent in all vegetable and animal existence. If a beam of solar light be admitted into a darkened room and allowed to pass through a prism, it divides into seven parts, and, if projected on a white wall or screen, it will appear in as many different colors, red, orange, yellow,

green, blue, indigo, and violet, commonly called the solar spectrum. When passing from one medium to another of different density light is bent out of its direct course. This is termed refraction. Now, in the solar spectrum the several parts denoted by the seven colors are refracted at different angles, the red least and the violet most. It is this which makes the light spread out like a fan and appear as a continuous band on the screen.

These colors, when examined separately, manifest properties somewhat different, though they have many properties in common. The red ray—the least refracted—shows the greatest heat, and the violet the least. By Newton's interference disks it is proved that these rays also differ in wave-length, the red being the longest and the violet shortest, but their vibratory rapidity is inversely as their length. In common, all these rays have the property of reflection, refraction, and polarization. The relevancy of these remarks will now appear.

If the spectrum be examined, just beyond the red, where it appears dark, it will be found to possess the same characteristics, except visibility, as other parts of the spectrum. The ratio of increasing heat from the violet to the red is continued into the dark part, which is found to be of a higher temperature than any other part. This part may be deflected from its course by a smooth surface, and collected by a lens, showing that it possesses in common with light the properties of reflection and refraction. It differs from light only in being invisible. Its waves are longer and vibratory motion slower than the luminous parts of the spectrum. The waves and vibrations are not of the requisite length and frequency to affect the optic nerve. That is to say, there is nothing in the organ of sight to respond to waves and vibrations of this length and rate.

The effect of radiant heat from the sun, both luminous and non-luminous, is well known to all. No artificial heat can take the place of solar heat. The sanitary beneficence of sunshine is proverbial. It is reasonable now to suppose that the form of artificial heat which most nearly resembles solar heat is most healthful. All bodies radiate heat. If two bodies are separated by nothing but air, each is constantly receiving heat from the other, but if one is of a higher temperature than the other the hotter body will radiate more than it receives, while the cooler body will radiate less than it receives; hence, by this process of exchange, the heat of the two bodies will become equalized. The air between the bodies will not be affected by the radiant heat of either, and this is equally true whether the radiant heat is luminous, as from an open fireplace, or non-luminous, as from stoves or heated pipes.

Radiant heat is transmitted in straight lines, and, like light, diminishes in intensity as the square of the distance from the source of heat increases. It passes through the air without affecting it, but heats all solid bodies upon which it strikes. Tyndall, by a series of experiments, has concluded that vapor of water in the atmosphere, if in considerable quantity, intercepts the passage of radiant heat, and to such a degree as almost to make a humid air opaque to radiant heat. This, however, has not been verified by other experiments.

The air of a room heated by radiation can not be accurately tested by a thermometer, as the bulb receives radiant heat, while the air surrounding it remains cool. To prevent this, the bulb should be surrounded by a bright piece of tin, to reflect away the radiant heat.

One advantage of radiant heat is that it warms the body and the objects in the room without heating the air

we breathe. An accompanying disadvantage is that, in ordinary heating by radiation, especially that of the fireplace, the radiant heat can warm but one side of the body at the same time. There is no doubt that if the body could receive sufficient radiant heat to warm it on all sides an atmospheric temperature of 50° would be more healthful than a higher one.

Radiant heat is believed to possess peculiar sanitary virtues, and we have seen good reasons for this belief. Some writers even express the relative values of conducted, radiant, and convected heat by characterizing radiant heat as "golden," conducted heat as "silver," and convected heat as "copper." From the earliest times the open fire has been instinctively felt to possess special virtue. The peculiar exciting glow produced by the fireplace is the common experience of everybody. Its peculiar virtue is not alone in abstracting foul air from the room, but in the nervous stimulus of direct radial contact.

The relative value of luminous and non-luminous radiation is not known, but there is little doubt that the former far exceeds the latter. There is reason for this. The luminous heat appeals to one more sense, that of sight, and, even though the physical qualities of the two kinds were otherwise the same, this alone might materially modify the total effect. We always look at the glowing grate, and are never indifferent to it. The direct luminous radiation of a fireplace is the best substitute for sunshine, and the direct radiation of a heated body is probably next in value. It will be seen, however, in our discussion of combined methods of heating and ventilating, that direct radiation alone is not sufficient.

Convection.—In fluids, such as air and water, the composing particles are free to move among one another,

there being no friction or cohesion between them. When any of these particles become heated by contact with a hot body they expand, decrease in density, and rise, other particles moving in to fill their places. The circulation thus caused is termed convection. Convection is not, like radiation, a specific kind of heat, but is simply a mode of heat-conveyance. The particles, when separately considered, are heated by conduction, when they at once, by their diminished specific gravity, rise and give place to others to be heated in the same manner. The process may be likened to a large number of pupils crowded around a stove; the nearer ones become warm, fall back and give place to the others, till the whole number become warmed. It is by convection that air and water are heated. Both of these fluids are poor conductors, and were it not for the lack of cohesion between their particles there would be no hope of warming them. Their non-conducting property may be proved by trying to heat them from the top downward. If ether be poured on the surface of water it may be burned off without affecting the bulb of a thermometer placed half an inch below the surface of the water; but the same amount of heat applied at the bottom of the containing vessel would sensibly raise the temperature of the whole contents. It is evident, then, that air or water must be heated at the bottom.

To prevent the too rapid escape of heat, warm air is sometimes admitted at the top of the room, and drawn out at the bottom near the floor. This has been tried in some of the European hospitals. As naturally to be expected, this method has not been successful. It is working against the force of gravity instead of with it. If accomplished at all, it must be at the expense of considerable power. Hot water can by means of a syringe

be forced to the bottom of a vessel of cold water, thus warming it, but it takes power to do it. The same principle holds when dealing with air.

CHAPTER XVII.

METHODS OF WARMING.

THE various methods of warming school-houses will be considered in connection with their accompanying possibilities of ventilation ; for a system of heating the air which does not at the same time provide for its necessary renewal is hardly worthy of consideration ; such methods, therefore, will be considered only to expose their defects, that they may the sooner give place to better ones.

The Open Fireplace.—The open fire, as a means of heating, is coming to be regarded as an antiquated institution, which very well answered the purpose of our unlearned forefathers, but which is now regarded as too primitive for this age of steam, hot air, and patent stoves. While the open fire still has a limited existence in private dwellings, in the form of ornamental, badly-constructed grates, and dummy mantels, it is no longer even thought of in this country as a means of warming school-houses. It will receive attention here, not as an historical relic, but partly because it is the best arrangement, as far as it goes, for the combined purpose of warming and ventilating that has ever been devised, and partly because the best school-house in the world—the City of London High School—is so warmed, ventilated, and made comfortable.

The history of the open fireplace, from its first use by the Romans, need not here be given ; we are interested

only in that form of it which best conforms to the principles of heating and ventilating. One of the best con-

FIG. 16.

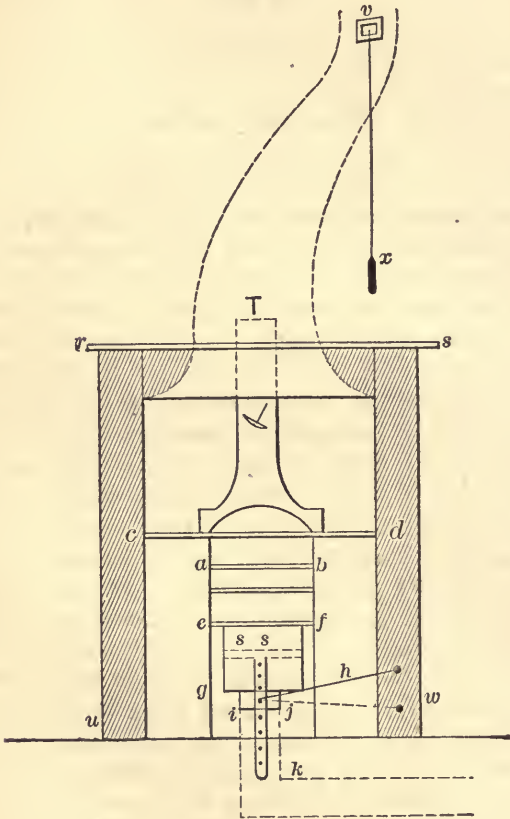

structed fireplaces is Dr. Arnott's smokeless grate, which may be understood by reference to Fig. 16. The chimney, *r s u w*, is of the usual construction; *a b e f* repre-

sent the front bars of a bottomless grate, it being open for the admission of coal, and needs to be supplied only once a day. The fire is lighted by laying on the surface of the coal, at *ef*, a sufficient quantity of light wood to insure ignition. The coal below becomes heated; the bitumen rises and burns. As the fire burns low, it is raised by means of a lever, *h*, working in the notched bar *l*, which pushes up a false bottom *ss*, upon which the coal rests. The fire is supported by air which passes through the bars in front; *v* represents a valve or damper in the wall near the ceiling, and regulates an opening into the chimney. This further serves as a ventilator, and may be controlled by means of the cord *x* suspended within easy reach. In ordinary fireplaces the large space above the fire robs the room of much of its pure air, which mixes with the smoke in large quantities and passes up the chimney. This is prevented in the grate now under consideration by a device, here described in Dr. Arnott's own words: "The whole of the air so contaminated, and which may be in volume twenty, fifty, or even a hundred times greater than that of the true smoke or burned air, is then all called smoke, and must all be allowed to ascend away from the room, that none of the true smoke may remain. It is evident, then, that if a cover or hood of metal be placed over a fire, as represented by *T* in the diagram, or if, which is better, the space over the fire be equally contracted by brickwork, so as to prevent the diffusion of the true smoke or the entrance of pure air from around to mix with it, except just what is necessary to burn the inflammable gases which arise with the true smoke, there will be a great economy. This is done in the new fireplace, with a saving of from one third to one half of the fuel required to maintain a desired temperature. In a room the three dimensions of which are

15 feet, $13\frac{1}{2}$ feet, and 12 feet, with two large windows, the coal burned to maintain a temperature of 65° in cold winter days has been 18 pounds for 19 hours, or less than a pound an hour."

The room here supposed has about one fourth the capacity of an ordinary school-room. This fireplace would then, according to Dr. Arnott, warm a school-room with less than 4 pounds of coal per hour. But we found by a previous calculation that about 18 pounds are necessary when the conditions of ventilation are all provided for and the temperature to be raised is 35° . It would appear from this great difference that, after making due allowance for the four extra windows and for the rigor of our climate over that of England, a form of open fire, such as that just described, is as economical as other modes of heating.

Heat is further economized in Boyd's open fireplace, by means of which, in addition to Dr. Arnott's plan, the cold fresh air is admitted from the outside to a chamber-box just back of the fire. This being put in communication with the room furnishes an inlet of pure warm air. It is this kind of fireplace which is used in the magnificent high-school building of London, which has only recently been finished. Further provision was made in the construction of this school-house in making foul-air openings near the ceiling and leading to a mammoth aspirating chimney extending to the basement. For the open fireplaces a separate flue is provided for each room independent of all the others.

In a climate in which the heat thus supplied is sufficient, this plan is about as nearly ideally perfect as can be imagined. Here the room is heated by convection of the ascending warm currents rising from the fire, by that which comes in from behind the grate, and, best of all,

by the direct radiation of live luminous heat direct from the open fire. The fresh air is warmed before entering, without being overheated. The room is ventilated both from the top and from the bottom of the room. The CO_2 , and other respired impurities, always at the top of the room, are drawn off by the aspirating chimney. Other foul colder gases, from the floors and neighboring closets, which may be lurking in the lower strata of the air, are effectually drawn off by the draft of the fireplace.

Whether this mode of warming would be adequate for the coldest days of an American winter is not known. It has never been tried. But it is safe to presume that it would be sufficient for nine tenths of the time in which a fire is needed. In severe weather it could be supplemented with steam-pipes, of which more hereafter.

Stoves.—Everybody who reads this book knows what a stove is, hence no general definition need be given. As a means of warming, a stove may be good or bad, according as the principles which should govern warming and ventilation are conformed to or violated. As the latter practice is more common, stoves are growing into general disfavor.

The necessary conditions governing the selection of a stove are : 1. It must be large, having sufficient surface to warm sufficiently without overheating. The evils of overheating the air have already been referred to in another place, and it may be here emphasized that air coming in contact with a highly-heated surface is ruined for purposes of respiration. The peculiarly disagreeable odor of such air is probably due to a charring of the organic matter contained in the air. The relative humidity of such air is so low that it is rendered not only unfit for respiration but ruinous to all animal tissue with which it comes in contact. 2. A stove should be lined with fire-

brick, or other similar material, to intercept poisonous gases which would otherwise pass through the heated iron into the room and contaminate the air. 3. It should combine or be accompanied with some efficient means of ventilation. 4. The smoke-pipe should be long, taking a turn around the room so as to economize the heat.

These requirements being complied with, there is little objection to the use of stoves. On the contrary, there is much in favor of them. In point of economy it is the cheapest means of warming known. But where the requirements just enumerated are not observed—when stoves are small, without lining, often heated to redness, and without means of ventilation—they are not only useless but become engines of destruction. Hundreds of different kinds of stoves are in use, but I shall specify no further than is necessary to illustrate the correct application of underlying principles. After canvassing the whole ground, I return to Dr. Arnott, who understood principles, and knew how to apply them. Fig. 17 illustrates the Arnott closed stove, and is thus described by him: “The complete self-regulating stove may indeed be considered as a close stove with an external case, and certain additions and modifications to be described. The dotted lines and the small letters mark the internal stove, and the entire lines the external case or covering. The letters A B C D mark the external case, which prevents the intense heat of the inner stove, *a b c d*, from damaging the air of the room. F is the regulating valve for admitting the air to feed the fire (see Fig. 4). It may be placed near the ashpit-door, or wherever more convenient. The letters *ff* mark the fire-brick lining of the fire-box or grate, which prevents such cooling of the ignited mass as might interfere with steady combustion. H is a hopper or receptacle with open mouth below, suspended above

the fire like a bell, to hold a sufficient charge of coal for twenty-four hours or more, which coal always falls down

FIG. 17.

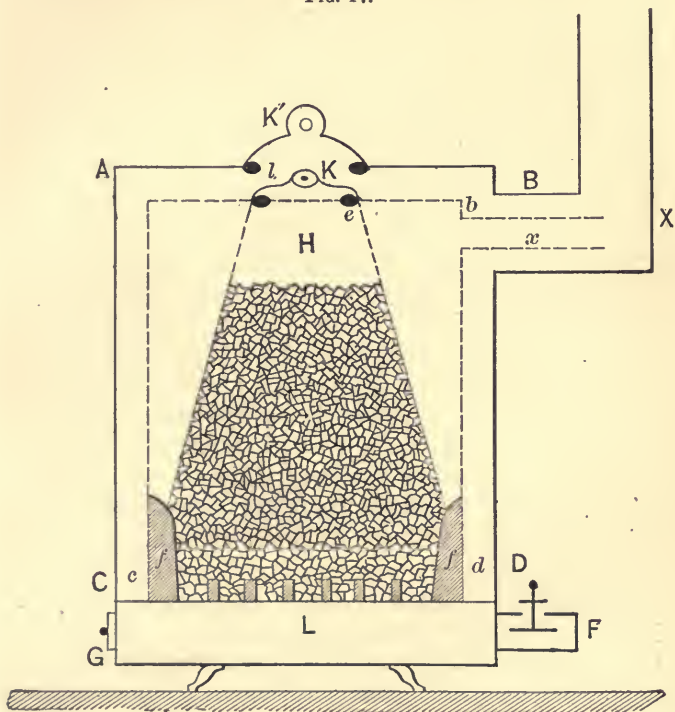

of itself, as that below it in the fire-box is consumed. The hopper may at any time be filled with coal from above through the lid K, of the hopper, and the other lid K' of the outer case. These lids are rendered nearly air-tight by sand-joints; that is, by their outer edges or circumference being turned down and made to dip into grooves filled with sand at *ee*. The burned air or smoke from the fire

rises up in the space between the hopper and the inner stove-case, to pass away by the internal flue α into the other flue X of the outer case. L is the ash-pit under the fire-bars ; G is the ash-pit door, which must be carefully fitted to shut in an air-tight manner by grinding its face or otherwise. The coal is intensely ignited below where the fresh air maintains combustion, but colder gradually as it is further up. Only the coal in the fire-grate below, where the fresh air has access to it through the fire-bars, can be in a state of active combustion."

This, it will be observed, is the origin of the modern "base-burner," which is a somewhat degenerated modification. Modern stove-mongers study for ornament rather than utility.

To be complete as a ventilator, furnishing an abundance of pure warmed air, the space between the inner and outer stove-cases should be in connection with the outside air by means of an air-duct, in which there would be found an inflowing current as the air rises in becoming heated. The outer flue X should be open into the room in order that this warmed air may be utilized. This was not the intent of Dr. Arnott, as he supposed the air in contact with the inner case to be vitiated by excessive heating. But the stove could easily be made of such a proportion between the size of the coal-hopper and the weight and surface of iron used in the construction of the cases as, together with the cold-air connection, to prevent overheating.

A very simple, effective, and inexpensive stove is illustrated by Fig. 18. F represents a stove of ordinary construction, upon which is placed a large double drum, the outer part, F, of which is in connection with the fire, and conducts away the smoke and waste products through the pipe P. The inside drum A communicates with the

outside air by the duct D. The size of the drum and the length of the pipe P should be such as to utilize all the

FIG. 18.

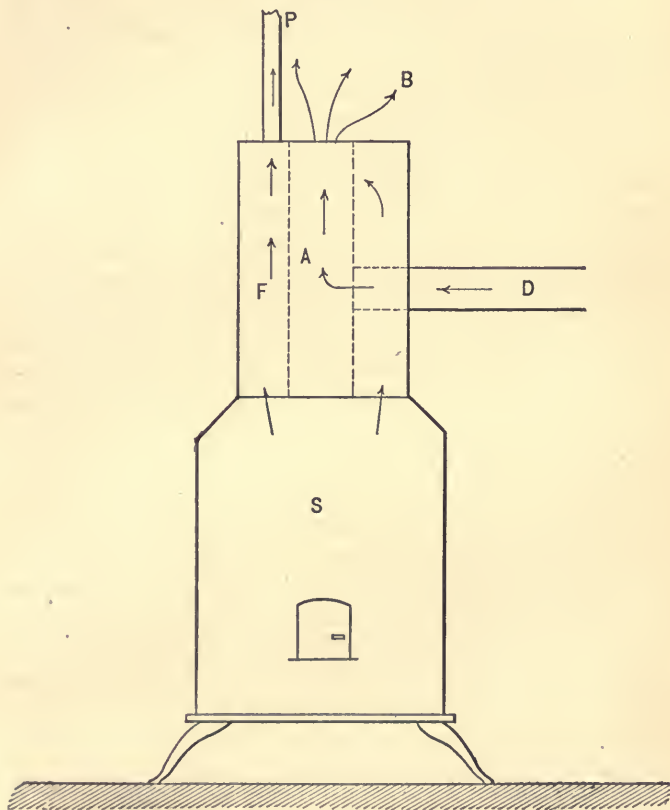

heat before the chimney is reached. The action is simple. As the air inside the drum becomes heated by the fire-draft around it, it expands, rises, and passes out at B

into the room. The partial vacuum thus formed is filled with inflowing cold air through the duct D. If desired, an upper room may be heated by the same fire by extending the pipe P through the ceiling, enlarging it in the room above into a drum of the same construction as the one described. A patent was granted in 1884 to A. M. Hicks and A. Dishman, of Kentucky, for the invention of a stove of similar construction.

Stoves, while not the best means of warming, may by a little care and attention be made serviceable and economical. Considering their comparative simplicity and easy adjustment, and the qualifications of the average builder, it is questionable whether it would not in the majority of cases be better to make use of improved stove heating than tamper with those more improved systems, the adjustment and management of which require scientific knowledge and technical skill. A fairly good system properly managed is better than a more excellent one in unskillful hands.

Many forms of open stoves have recently been made, intended to combine the advantages of the closed stove and the open fireplace; among which may be mentioned the so-called "Baltimore Heater." It consists of an open-front stove set back into a chimney recess resembling the common fireplace. The smoke-pipe extends up through the entire length of the chimney, leaving the space between it and the inside walls of the chimney as a ventilating flue which may be put in communication with the room.

The Ruttan System.—Stoves may be greatly enlarged and placed in a separate apartment, preferably a basement, where they are made to furnish the heat to the various parts of a building by means of communicating tubes. They are, when so situated, sometimes called furnaces.

Many different kinds of furnaces are in use for thus supplying rooms with hot air, all having for their object the heating of air and transferring it to the various rooms. Many of these furnaces are constructed with the sole object of heating, no provision being made for ventilation. Some of these fulfill their object well, but, as it is not the purpose here to consider the merits of heaters simply as such, they will not be discussed.

The most which has been accomplished in the way of warming by means of hot air, where ventilation at the same time has not been ignored, has been done by the so-called Ruttan system. This system of heating and ventilating is coming into quite extensive use in Canada and many of the Northern States, where it is receiving many testimonials of approval.

For some of the excellent features which this system undoubtedly possesses, and for some of the overdrawn estimates of its merits made by its friends, its merits and demerits will here be considered. The system combines the patented inventions of Henry Ruttan, of Canada; J. D. Smead, of Toledo, Ohio; and B. R. Hawley. For heating, the tubular furnace is used, which, on account of the large surface which is thus brought in direct contact with the fire, is economical as a consumer, and the large surface which is also subjected to the air makes it effective as a heater. It conforms well to the requirements of a heater which have already been insisted on under the discussion of stoves. The fire-box, by its construction, presents a large surface to the fire and to the air. The surface is further increased by causing the smoke and burned products to pass successively through the tubes. The furnace is set into masonry, into which the cold air is admitted for warming, and passes out at the tubes to the rooms. The method of admitting the

heated air into the room is embodied in an invention of Mr. Smead, patented by him in 1882. It may be understood by reference to Fig. 19, which represents a vertical

FIG. 19.

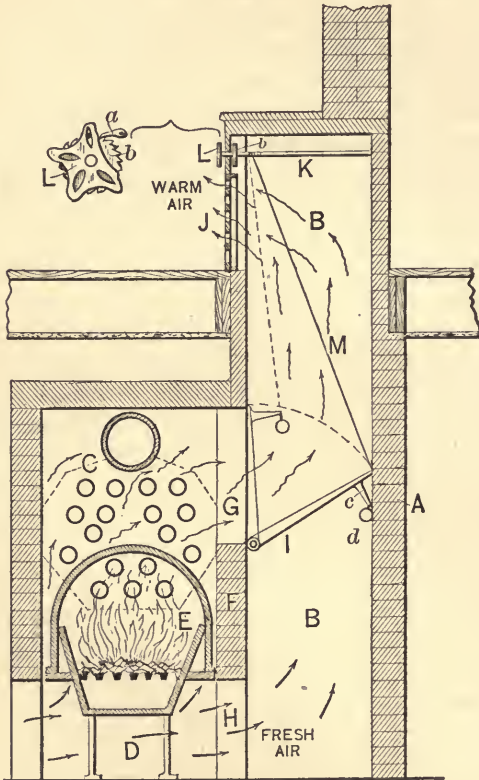

transverse section through the heater and lower part of one of the flues. A represents the building, B the air-flue, C the heating chamber, D the cold-air duct, E the

furnace chamber, F a wall separating the furnace from the flues, G an opening from the furnace into the flue, H the opening from cold-air duct into the flue, I a hinged valve for regulating the relative supply of hot and cold air, J the opening into the room to be warmed, L a hand-knob for raising and lowering the valve I, *d* a weight to hold the valve in position. The arrows show the direction of the air. The action of this arrangement is as follows: The air in the chamber C becomes heated, rises and passes up the flue M, and into the room through J. The cold air flows in at D to fill the partial vacuum thus made. When the room becomes too warm, the inflowing hot air is mixed with cold air by turning the knob L, which raises the valve I, closing the hot-air passage G and opening the cold-air passage B. The height to which this valve is raised regulates the relative size of the hot- and cold-air openings. It will be well at this point to notice that, while the relative size of the hot- and cold-air openings may be thus regulated, it is doubtful whether the same proportions maintain between the hot and cold air passing through them. The quantity of inflowing hot air may undoubtedly be regulated by this valve, by opening and closing it; but how the cold air is to rise and flow in its place is not so clear. Suppose the valve be raised so as to make the size of the hot- and cold-air openings equal, what will then be the action? The hot air rising through the flue has a vacuum-forming tendency, and it is supposed by the inventor that the cold air at the bottom of the flue will rise up to fill the partial vacuum. This it might do were there not a source of supply by which the vacuum is supplied with less resistance. There is an inexhaustible supply of hot air coming from the furnace, already possessing a tendency to rise, and half closing the hot-air opening, as in the case supposed, further increases

the tension of the hot air thus resisted as it rises from the furnace. Will not, then, this supply of hot air with high tension be sufficient to supply all vacuum which the air rising in the flue will create? If the cold air will rise under these conditions, it is difficult to see why the cold air of the room into which the warm air enters will not rise along with and be drawn up by it as it passes in at J and rises to the top of the room.

This is not a case parallel with the aspirating chimney, where hot air rising in a shaft will cause cooler air to flow in through openings into it. In this case the partial vacuum has no other adequate source of supply, which we have seen is not the case in the flue under consideration.

It is not here maintained, however, that this valve is useless; on the contrary, it may be, under certain conditions, very useful. If it be nearly or quite raised, so as to shut off most or all of the hot air, and if there is a good aspirating chimney drawing the foul air from the room which is being supplied, and if the doors and windows are carefully closed, then the cold air will rise in this cold-air duct. But it is safe to conclude that all these conditions are necessary. If there is no aspirating chimney there will be no vacuum-forming tendency in the room sufficient to cause cold air to rise. If a door or window is opened, the draft in all cold-air ducts immediately ceases, as air, like all other moving bodies, seeking the line of least resistance, will come from a source where it is least opposed; and through an open door or window the resistance by friction is nothing, while in the cold-air flue it is considerable. Here, let it be observed, is another argument for double windows and spring-closing doors.

In the Ruttan system the foul air is drawn out of the room from the bottom through registers near the floor.

These outlets are placed, when convenient, on the sides of the room opposite the final outlet, so that foul warm air, as it leaves the room, will pass under the floor which it is thus intended to warm. The foul air thus passing from the different rooms is all collected into a foul-air room adjacent to the smoke-chimney, into the bottom of which it communicates by a large opening.

The theory of the system may be summarized as follows: The air warmed by the furnace rises through the air-flue into the room, where, within convenient reach, a hand-knob is placed for regulation of hot and cold air. The warm air, after its admission, rises to the top of the room which, on being filled from the top downward, presses the cold air down and out of the outlets. The foul air, it is claimed, being "at the bottom," is thus drawn off, and the upper part of the room kept constantly filled with pure warm air. The floor is warmed by the foul air as it passes beneath on its way out. This foul air is kept in motion by the draft of the chimney into which the foul-air room opens. It may be said in favor of this system that it shows throughout a studied effort toward conformity to physical laws, and is therefore a valuable contribution toward the solution of the difficult and all-important problem of ventilation. It is an ingenious system, and is doing comparatively good service. The critical review to which it will now be submitted is intended to be in the interest of truth and the public good, and toward suggesting improvements rather than condemning the system.

In the first place, considering the large amount of friction which the air necessarily encounters in finding its way out, and the rapid passage of air which is necessary to secure proper ventilation, a higher degree of furnace heat is necessary than is harmless to the air.

Again, if the air entered the room at the temperature of comfort, as claimed in the theory, it would be too cold to be endured after having made its circuit to the top of the room and settled down to the point of utilization.

These two reasons make the overheating of the air unavoidable. We have seen that overheated air is damaged for purposes of respiration; and it is evident that the heat necessary to raise air to a high temperature is nearly all lost, as this surplus heat must pass away through walls and windows in cooling down to the degree of comfort.

The origin of this difficulty seems to be in the lack of proper distribution of the air as it enters the room. When the incoming air is all at one place, it will of course rise to the top of the room before it becomes sufficiently vitiated to allow its escape before it has been used. It must therefore be retained, but it can not be retained without placing the outlets below. If the air was properly distributed as it enters, it would be sufficiently vitiated to be allowed to pass out at the top of the room, on reaching that point, the natural place for its exit.

The placing of the outlets below is further justified, by the theory of this system, in supposing the vitiated air is at the bottom of the room. The fallacy of this assumption is shown in another place, under the consideration of the position of outlets, and need not be repeated here.

A condition of things may exist, and probably does in this system, where the most of the undiffused CO_2 occupies a position somewhat near the breathing line. If the incoming air is warmer than the breath—about 95° —it will rise above the breath and prevent its ascent higher than that stratum of air having a temperature of 95° . Instead, therefore, of making a dive for the floor, the respired breath, carrying CO_2 and organic matter, will rise

a short distance, and, before passing out of the room, must again cross the breathing line. Now, the shorter the distance between this stratum and the breathing line, the less opportunity for diffusion to take place in time to prevent rebreathing the expired impurities.

An objection to the arrangement for warming the floor might reasonably be urged in the fact that so large a part of the building is submitted to the contamination of foul air with no provision for cleansing. The walls of a shaft or room in which there exist large quantities of air vitiated by respiration soon become coated with an offensive and poisonous accumulation of organic matter which, if not removed, is liable to contaminate the entire building, and in case of temporary reversal of the draft, as is sometimes sure to take place in warm weather, when little or no fire is required, the air, in passing over this foul matter, becomes unfit for respiration before it reaches the room. All foul-air passages should be accessible to the brush of the janitor.

One obstacle in the way of this system is the difficulty of managing the average builder. In order that the possibilities of the system may be realized, buildings must be constructed from the beginning with special design for its application. In buildings not specially constructed for this system it is practically worthless, and the same is true in buildings improperly designed for it by designers who do not fully understand the principles which the system requires of them to materialize. This is in itself no fault of the system, but is, in the present state of mechanical service, an inevitable obstacle.

It is not unfrequent to see school-houses built for this system where the construction ignores the very principles upon which the success of the system mainly depends. In one instance which I now have in mind, and which I

had excellent opportunities of observing, the foul-air outlets led to single chimneys for each room, which were closed up solid at the bottom, and unconnected with the smoke-chimney or other source of heat. The windows were numerous and loosely fitted, which allowed the hot air to pass out at the top of them before it arrived at a point low enough to be utilized. The small dummy aspirating chimneys, having little draft, failed in their legitimate function of removing the foul air of the room in order to give place to the incoming hot air, which could not otherwise find an entrance sufficient to warm the room. These circumstances admitted of but one result. The hot air, all that could be forced to enter, found a lodgment in the upper part of the rooms, where a temperature of about 200° was maintained, while at the floor it was little above the freezing point. Of course the apparatus had to be taken out.

In conclusion, it may be said of the Ruttan system that, if the requirements of the theory be carefully conformed to in the construction of the buildings, the windows and doors made tight-fitting and kept closed, it will work comparatively well, yet even at its best it has inherent defects which must be recognized and met before it can be received as a perfect system.

CHAPTER XVIII.

STEAM HEATING.

IN heating with steam, water is converted into steam in a boiler heated by a furnace situated in the basement or other convenient locality. The steam is then conveyed by means of pipes to the parts of the building to be warmed.

It will be seen by a careful reading of the foregoing pages that one of the chief defects in all systems of warming and ventilating so far considered is the inadequate distribution of the warmed air. This is a matter of prime importance. Heat should be furnished not only of the necessary amount, but it should be furnished in such a manner that it can be utilized.

We have seen that it is impossible thoroughly to do this by stoves and hot-air furnaces in buildings more than one story in height. If our school-houses could be confined to a single story, furnace-warmed air might be used, and perfect ventilation be attained. The English House of Commons is heated by means of furnace-warmed air, on a modified plan of Dr. Reid, and all the required conditions of ventilation and distribution are there complied with. But the same results would not be possible in an upper story of a building.

In this building a hot-air chamber, extending beneath the entire floor, supplies the room with warmed air admitted through a perforated floor. Ventilation is at the top, and the foul-air flues have their opening into an aspirating chimney.

In buildings of several stories, containing many rooms, the difficulties of heat distribution without waste are met by the use of steam. This is inevitable from the natural

properties which steam possesses. A correct popular understanding of these properties would eventually settle the question as to the best method of warming large school-buildings. While these properties are easy of demonstration, it is curious what erroneous notions are current concerning them.

Of course it can not be expected that the printed advertisements prepared by furnace-heating companies will contain much that is scientifically reliable concerning the peculiar heating advantages of steam ; and while it might be pertinent to ask why they do not remain silent regarding that which they either misrepresent or misunderstand, it may perhaps be excused as a sort of special pleading which has come to be regarded as legitimate in advertising.

But this is not the only source of published error concerning the properties of steam. A single instance will suffice. W. C. Whitford, ex-Superintendent of Public Instruction of Wisconsin, in a book on "Plans and Specifications of School-Houses," in referring to steam heating says : "A very considerable percentage of the force derived from the heat applied to the water in generating steam is lost in expanding and driving this steam along the iron pipes or through the radiators. In other words, the heat of the burning fuel appears in part in mechanical action and not in temperature."

That this mechanical action is *lost* is a somewhat strange doctrine. A few quotations from authors who have given special attention to physical laws will be sufficient to stand against this view.

Gage, in his "Physics," says : "*Heat that is consumed in liquefying solids and vaporizing liquids is always restored when the reverse change takes place. . . .*" The fact that steam in condensing generates a large

amount of heat is turned to practical use in heating buildings by steam."

William J. Baldwin, a scientific mechanical engineer, in his work on "Steam Heating for Buildings," says: "When a solid becomes a liquid, or a liquid becomes a vapor, heat is absorbed more than was necessary to raise it to the temperature of conversion, and this latent heat does work in the destruction in the force of cohesion and other occult changes which take place, and must be absorbed *from some other substance*. In the case of steam in a boiler, it comes from the fuel during combustion, and when a pool of water is vaporized in the street, it comes from the sun directly, and from the earth, air, etc., indirectly. When steam or vapor is condensed this same quantity of heat that was received, no matter where, is given off to any substance within its influence, air, water, etc., colder than itself, and it is this property, to convey *more* heat within ordinary controllable temperatures than any other substance, which makes water and its vapor so valuable."

These properties of steam may be demonstrated by a simple and interesting experiment:

An apparatus, consisting of a flask, lamp or Bunsen burner, bent tube, and beaker, is arranged as shown in Fig. 20. Into the flask A pour one ounce of water at 32° Fahr., and into the beaker C pour 5½ ounces at the same temperature. In a short time the water in A will be converted into steam, which will pass through the tube B and be condensed in the beaker C. Immediately after the total evaporation of the water in A, the water in C will be found by testing to be at a temperature of 212° Fahr. By carefully noting the time which elapsed from the first application of the heat till boiling commenced, and also from when boiling commenced till the evapora-

tion was completed, it will be found that the latter time is $5\frac{1}{3}$ times the former, that it requires $5\frac{1}{3}$ times as long

FIG. 20.

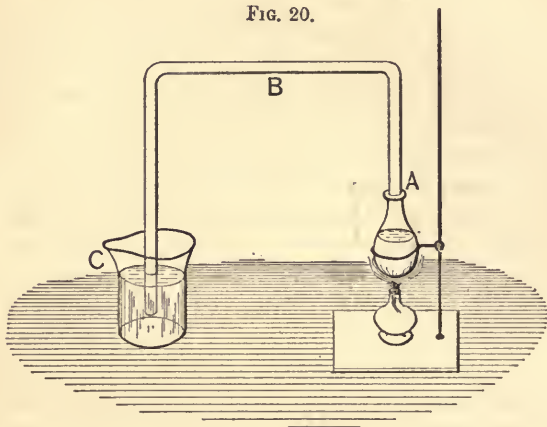

to convert boiling water into steam as it does to raise water from the freezing to the boiling point.*

Now, these facts teach, first, that, as the application of the heat is constant, $5\frac{1}{3}$ times as much of it exists as latent heat than exists as sensible heat. During the entire process, neither the boiling water nor the steam acquires a temperature above 212° , the boiling-point of water. Second, that this so-called latent heat is really no heat at all, but mechanical energy, into which the sensible

* To avoid accident in this experiment, the flask should not be allowed to boil quite dry, as this would cause a vacuum to be formed in the flask, which would suddenly be filled by a rush of water from the beaker through the tube. To avoid a similar result, the tube should always be raised out of the beaker before the heat is removed, for if the water ceases to boil the steam will cease to be driven off, and a vacuum will result the same as though the flask were allowed to boil dry.

heat of the flame was converted; this energy being sufficient to overcome the cohesion between the particles of the water and to transfer them against gravity over into the beaker. Third, that as the water in the beaker, containing $5\frac{1}{2}$ times as much as was evaporated, was raised to a temperature equal to the highest temperature of the steam, this latent heat, in the form of mechanical energy, appears as sensible heat as soon as condensation takes place. Fourth, that during the passage of the steam through the tube, none of the latent heat is lost; that its re-appearance as sensible heat is reserved until the instant of condensation.

In view of these principles, practical insight need not be very far-reaching to see the great advantage possessed by steam for the purposes of heating, when heat is to be carried to some distance and distributed. The mechanical work necessary to "drive steam through pipes and radiators" exists in the steam itself, for its inherent property of expansion makes it *self-driving*.

If steam-pipes could be perfectly insulated, so as absolutely to prevent exchange of temperature between them and the air, heat could be transferred to any distance whatever, and without loss. Perfect insulation is of course impossible, but it may easily be made sufficiently good to render the loss in a single large building practically nothing.

This has been demonstrated by Mr. Holly, who has extended the system from heating a few buildings to as many hundreds, where the steam is all generated in one place and conveyed through carefully insulated tubes to the several houses.

The method of insulating the pipes which Mr. Holly used may be described in the words of his circular: "The pipe is placed in a lathe, and wound about first with as-

bestos, followed by hair felting, porous paper, manilla paper, finally thin strips of wood laid on lengthwise, and the whole fastened together by a copper wire wound spirally over all. This is thrust into a wooden log, bored to leave an intervening air-chamber between the pipe and the wood, and of sufficient size to leave from three to five inches of wood covering. The elasticity of the wrappings permits the free expansion and contraction of the pipe irrespective of the wooden log, which is securely anchored and made immovable. The whole is placed in a trench a short distance below the surface without regard to frost. At the bottom of the trench is laid an earthen tile drain to carry off any earth moisture, and in order further to insure the continuous dryness of the wooden log inclosing the pipe."

Such careful insulation is of course wholly unnecessary in the heating of a single building. This description is given simply as an example in further demonstration of the principles in steam heating.

Mr. Holly also demonstrated, by a carefully conducted experiment, that steam may be conveyed through 1,600 feet of three-inch pipe, with a loss by radiation of only $2\frac{1}{4}$ per cent. This is sufficient to show that in single buildings, where the risers are about the only pipes from which radiation is not wanted, the loss may be regarded as practically nothing.

It has already been noticed that steam, when not under pressure, has a temperature of only 212° , that of boiling water. When, however, its free expansion is arrested, its temperature will increase in proportion to the pressure to which it is subjected. It is better, therefore, in order not to overheat the air by contact with superheated iron, to have the pressure as light as possible. Here is another important advantage of steam heating : the air need never

be overheated if a proper regulation of pressure be observed, and a sufficient amount of piping be used to furnish the requisite surface for radiation.

Steam-pipes can be carried to any place in a building where heat is desired. In most other systems of heating the heads of the occupants of a room inevitably occupy a position having a higher temperature than that of the feet. This is exactly the reverse of what it should be. Nothing is more subversive of good circulation than cold feet. On the other hand, if the feet are kept warm, good circulation may comfortably be maintained, even when other parts of the body are subjected to a comparatively low temperature.

An arrangement of steam-pipes beneath the floor, as hereafter described, would settle the question of cold feet, and remove the necessity of so high a temperature in other parts of the room as is commonly maintained. There remains no question, then, as to the superior facilities of steam for heat distribution.

Its cost may be figured otherwise than from the above negative consideration of the loss. The latent heat of steam is 960, that is, it requires 960 units of heat to convert one pound of boiling water into steam. This is really the amount that is actually realized as heat. The hot water, when first condensed in the pipes, does on its return impart some of its heat to the room, but the same amount will be necessary to raise it again to the boiling-point in the boiler before it can again be utilized. Theoretically, one pound of coal will furnish heat sufficient to convert 14 pounds of water into steam, but in the average practice only 9 pounds are realized. Then $960 \times 9 = 8,640$ is the number of thermal units which can be realized from one pound of coal.

It was found, when calculating the cost of heating in

another place, that 142,959 units of heat are necessary to supply the requirements of one average school-room for one hour, where all the demands of warming and ventilating are rigidly complied with. Now, $142,959 \div 8,640 = 16.66$, the number of pounds of coal necessary to supply one room for one hour. In the former calculation it was found that 18.3 pounds was the number required, which shows nearly 2 pounds per hour in favor of steam.

So far, steam has been treated with sole reference to its warming and distributing facilities. Objection is sometimes made to steam heating that it does not furnish sufficient ventilation. To this it may be answered that the same is true of any method of heating simply as such

It has already been explained how heating and ventilating are antagonistic processes, ventilation always being at the expense of heat. In any method of heating ventilation must be provided for and arranged as an accessory to the heating. No heating apparatus is in itself a ventilator. Good ventilation is possible with any system of heating, as no ventilation at all frequently accompanies good methods of heating when by themselves considered.

That poorly ventilated school-houses are sometimes heated by steam is no argument against steam as a method of warming; nor does it prove that good ventilation is not possible with steam heating. This will soon be made apparent in the consideration of the different methods of steam heating, which are of three kinds, viz., heating by direct radiation, by indirect radiation, and by direct-indirect radiation. Heating with hot water is not well adapted to school-buildings, which are occupied only at intervals. This method, therefore, while possessing superior advantages for warming private dwellings, will not be here considered.

Direct Radiation.—In direct radiation the coils of steam-pipe or radiators are placed within the room to be warmed. They warm the air of the room by radiation and convection, and do precisely the work of a simple stove where heating is alone provided for and ventilation ignored. The single point of superiority of this method over that of the stove is in the comparatively large radiating surface and moderate temperature. As a mere heater, where the temperature of the room is alone considered, no method is more effective, but when so used to the neglect of ventilation, heating by direct radiation alone *can not be too heartily condemned.*

Enough has already been said concerning the evils of heating the air of a room without provision being made for frequently changing it. It needs only to be noted here that nothing is more certain to produce these evils than direct radiation when used alone.

This must not be considered as an argument against direct radiation in itself, but *by* itself; indeed, it should form a part of every system of steam heating. It is here condemned only when used exclusively. When direct radiation is used in association with a good aspirating chimney, in which coils of steam-pipe may be placed to give a good draft, and when the radiators are so arranged that the cold air from the inlets will come in around them and be warmed before reaching the occupants of the room, it makes a fairly good arrangement. This is illustrated in Fig. 21, where D is the outside wall; W, the window; E, the cold-air duct; R, the radiator; A, the ventilating shaft; B, the upper foul-air vent; C, the lower foul-air vent. The arrows show the direction of the currents.

This arrangement is commonly met with in school-houses, and is somewhat better than no provision at all for ventilation, but it is very inadequate. The heat can

not by this means be properly distributed. If the outlet B is kept open, the warm unused air will escape ; if it is

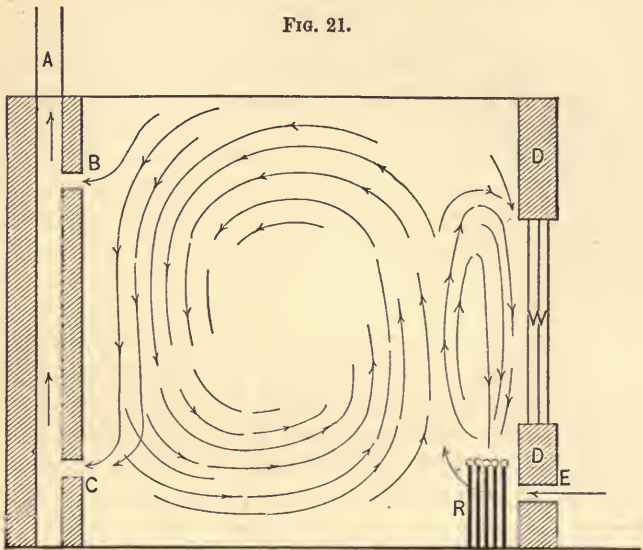

kept closed, the foul air will accumulate in the top of the room. The radiator R, while good so far as it goes, does not warm the air sufficiently as it enters to prevent cold drafts, providing the inlets are sufficiently large for the demands of ventilation.

Steam heating by direct radiation, even without any provision for ventilation other than by windows, is prevalent, almost discouragingly so. As a single illustration, the following words of John D. Philbrick, in his circular on "City School Systems in the United States," may be used. In speaking of the high-school in the city of Washington he says : "It is to be regretted that the high-school

house recently erected in our national capital should be in its planning so far behind the times. Its conspicuous absence of merit was not to have been anticipated, considering the high reputation which the city had acquired for good school-house building in the erection of the Franklin and so many other good school buildings. . . . The heating is effected by means of direct steam radiation."

Washington is here named because of its prominence and the common interests which center there ; but it is not the only city in which blunders have been made, and are being made, in school-house building relative to heating and ventilating. In fact, the taking of Washington as typical is exceeding liberality toward other cities, some of which are really much worse.

During the summer of 1886 I visited many school-buildings, with a view of studying their provisions for warming and ventilating. Among those which were warmed by direct radiation, several were arranged as represented in Fig. 22, which is here given, as some of these buildings were new and may be supposed to represent the best that has been done in the localities where they were found. The figure shows the interior of a school-room with the two sides nearest the observer removed. R represents the steam-pipes, extending along the sides of the room under the windows. S is a ventilating shaft in the corner of the room opposite the windows, made tight at the bottom, with no provision for heating the air inside of it. V is an outlet about one foot square, from the room into the ventilating shaft, and situated near the floor. No provision is made for air to enter the room except through the windows.

The theory of this arrangement is difficult to guess, but the only one which approaches rationality is that the air is expected to rise from the pipes, move along the top

of the room to the opposite corner, then to dive down to the bottom of the room and crawl up the shaft. This,

FIG. 22.

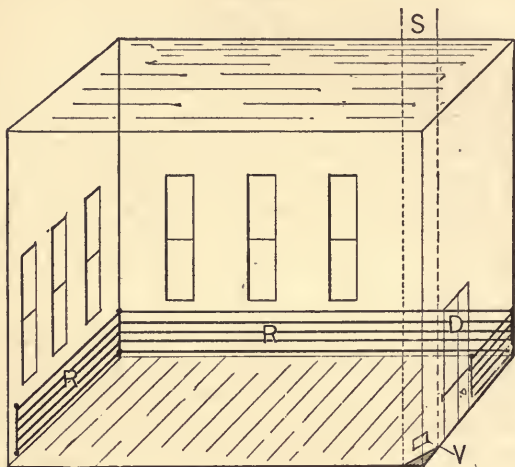

while quite as reasonable as many current ideas concerning ventilation, is expecting altogether too much of the air, whose power of moving is passive and not active.

The air will rise from the pipes to the top of the room. This is the only correct supposition in the above supposed theory. There is nothing to make it descend when it reaches the corner opposite, unless it is colder than the air below it, and what is to make it colder? It may be at a temperature lower than when it started from the pipes, but it is still of a higher temperature than the air below it, in all parts not directly over the pipes. Hot air constantly rising to the top of an inclosed space will stratify along the highest plane, the warmest occupying the highest level. As the process continues the line of

demarkation between warm and cold air will descend lower and lower till the floor is reached, provided there is no outlet higher than the floor through which the warm air may escape. But in the present case there is such an opening, for the air is expected to enter at the windows, and where air can flow in when room is made for it within, it can also flow out when room is made for it without. Now, room will always be made for it without, when the windows are on the leeward side of the room. It has been previously explained how wind produces a partial vacuum on the leeward side of buildings or other obstructions. The air inside will, therefore, have a tendency to flow outward on that side unless there is some counteracting force inside to prevent it, and in the present case there is none. Cross-currents will thus set in, and the windows will be both inlets and outlets.

If this little foul-air shaft were converted into an aspirating chimney of sufficient size in which heat could be easily supplied from coils of steam-pipe extended into it, there would be something to counteract this influence of the wind, as well as to furnish an adequate exit for foul air. In short, these little foul-air shafts, when so arranged, are almost useless. They are not quite useless, because in cold weather, when the air is still, there will be a slight upward draft through them, due to the air in them being a little warmer than the outside air, but when the wind is blowing they are liable to become inlets. Direct radiation, with no other means than this for ventilating or preventing cold drafts, is objectionable. The use of direct radiation, when accompanied with other provisions, will appear hereafter.

Indirect Radiation.—In indirect radiation the pipes are not placed inside of the room to be warmed, but outside in an inclosed chamber opening into the room and

into the outside air. The air in these chambers becomes heated, rises and passes into the room, and is followed by fresh cold air from outside the building.

It is evident that a room warmed in this manner is necessarily partially ventilated, for the warming is not by radiation or convection, but from inflowing warm air, which

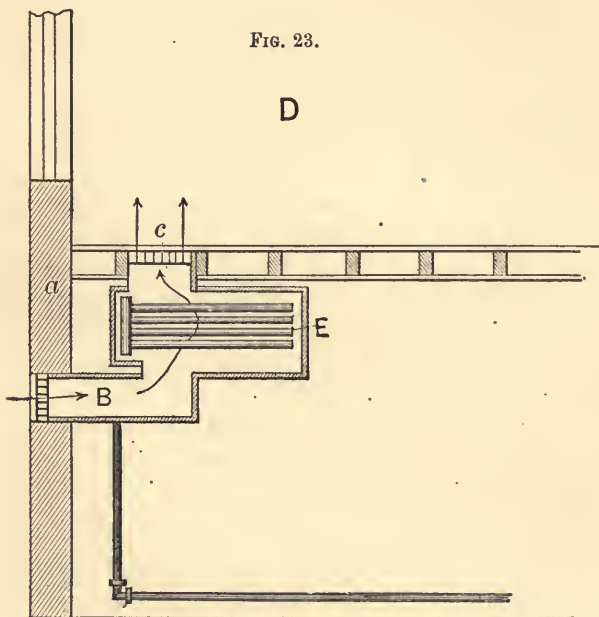

must in entering displace an equal amount of air previously in the room.

This method of warming may be understood by reference to Fig. 23, where *a* = outside wall of the house ; B = the fresh-air duct ; *c* the register opening into the room, and E the coils of steam-pipe.

Indirect radiation should be accompanied with adequate means for abstracting the foul air from the room, either in the form of a good aspirating chimney or a ventilating fan. Unless this be done, any form of indirect radiation will fail; for, as two bodies can not occupy the same space at the same time, the foul air must pass out before fresh air can pass in. A mere outlet into the open air will not generally suffice, for then the air must be pushed out by the air coming in from the radiators, a work which can not thus be adequately performed.

The position of the radiators in a system of indirect radiation may vary according to local circumstances. Some builders, however, have a rule of placing them in the outside walls, and others in the inside walls near a central fresh-air shaft situated near the center of the building. Mr. Baldwin is of the former class, and gives as a reason for the outside position that, as the windows furnish a constant source of rapid cooling, a current of cold air is always passing down inside the room in front of them, thence along the floor, cooling the feet of the occupants. Placing the radiators in the outside walls under the windows furnishes an upward current of warm air which meets this cold current, thus counteracting it.

Mr. Briggs, on the other hand, is of the latter class, and gives as reasons for interior locations of radiators: That basement piping is thereby saved; that it obviates danger from freezing of pipes; that it prevents loss of heat from introduction ducts or flues which run up the outer exposed walls of the building, and that the internal location makes it possible to place the inlets and outlets on the same side of the room, which it is claimed facilitates the bringing down of the warmed air from the top of the room, where it first rises, to the breathing line.

Each of these plans of locating radiators possesses

some advantages over the other, but both are equally at fault on the one thing necessary to make steam heating perfectly successful. Both admit the warm air through a few large openings situated at the sides of the room, where it at once rises to the top before it is utilized. This, of course, necessitates the placing of the outlets near the floor, in order to retain the warm air till it has cooled sufficiently to descend and be used. The problem of distributing the warm air as it enters is not solved by either of these methods. Until it is solved, until the air can be so admitted that it can be utilized while on its way to the top of the room, so that when arriving there it may be let out at the ceiling, the place where Nature plainly dictates that its exit should be made, instead of trying to force hot air downward ; until this can be accomplished, steam heating has little advantage in point of ventilation over some other systems.

CHAPTER XIX.

AN IDEAL PLAN FOR WARMING AND VENTILATING.

THE necessary physical conditions of warming and ventilating have now been fairly well discussed. In our investigations of the different plans which have been employed, the merits and demerits of each have been pointed out. While all have some characteristic points of excellence, none so far considered are without numerous and serious defects. Thus far no system has been devised that so distributes the air as it enters the room that it may be let out at the top—the place which Nature plainly dictates for its exit. No plan has yet been hit upon which

keeps the feet of the occupants warmer than the head—a necessity which the laws of blood-circulation make plainly evident. No system has yet been put in practice which does not at some point oppose the natural laws of ascent and descent.

A device will now be described which I believe will not only remedy these defects but will comply with all the requirements of ventilation. In order better to estimate its value, let us first enumerate the requirements of ventilation. 1. The air must come from a pure source. 2. It must be sufficient in quantity. 3. It must be warmed before being admitted into the room. 4. It must not be overheated. 5. It must be distributed as it enters, so that it may be utilized before it reaches the top of the room. 6. In order that this may be possible, it must be admitted through the floor. 7. It must not be entrapped in the top of the room. 8. The ventilation and air-supply must be independent of doors and windows.

A careful study of the following figures will show how this may be accomplished. Fig. 24 shows the interior of a double chimney, with partition and side toward the observer removed so as to reveal the parts. B is the floor of a fresh-air shaft which constitutes one division of the chimney, as shown by the broken partition wall E G. H is the opening into the large tube C, which carries fresh air to the rooms; X X shows the front of this tube, cut away so as to show the other side. J J are floor-joists. A shows where the fresh-air tube sends off a branch directly under the floor of the first story; F is the foul-air register, opening from the top of the room into the chimney. J' J' A' and F' show corresponding parts for the second story. A is the floor of the aspirating chimney, which contains the fresh-air tube just described,

FIG. 24.

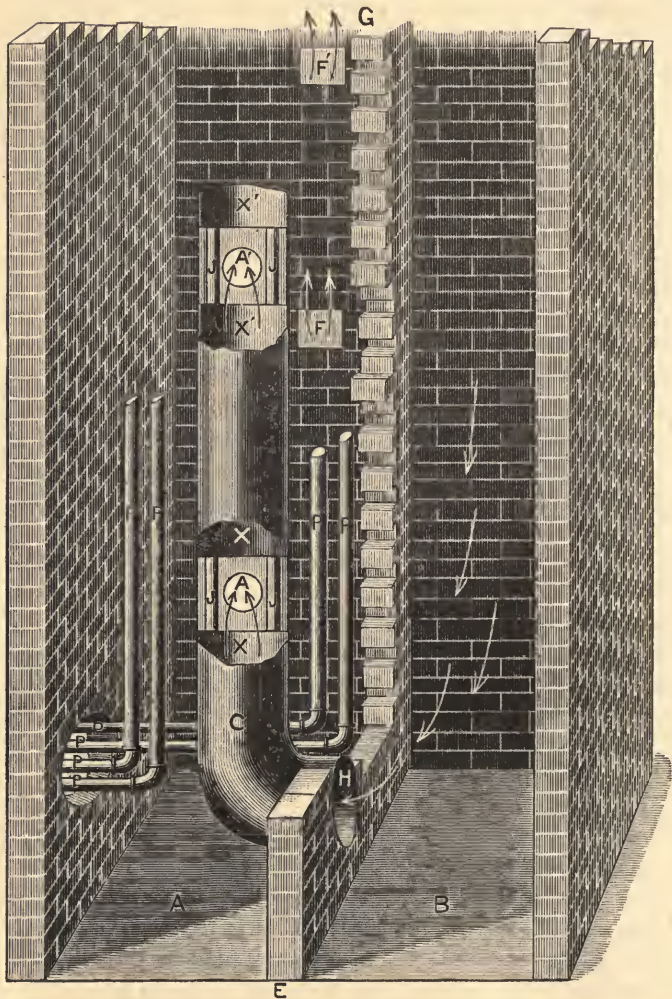

and also the smoke pipes, P, which come from the furnace and extend to the top of the chimney.

The action of this chimney explained is as follows: This chimney is to perform the work of ventilating and carrying the fresh air to four school-rooms. The large furnace pipe is divided into the several smoke pipes, P, so that the waste heat from the fire may be utilized in heating the air in the chimney, by making the heated radiating surface as large as possible. The air in this part of the chimney, thus heated, rapidly rises and creates a powerful upward draft, making a partial vacuum, which draws the foul air through the foul-air registers F at the top of the room. The smoke-pipes are extended upward to the top of the chimney, to prevent the possible reflux of smoke which might otherwise occur in windy weather. The heat from these pipes will also be communicated to the fresh-air pipe C; and the fresh air which it contains, being thus warmed, will rise and pass under the floor through the branch tubes A and A'. It would probably be better to have the fresh-air tubes leading to the separate rooms independent of one another to avoid inequality of draft. In the figure two rooms are represented as being supplied from one main pipe C, merely for convenience of illustration. The air thus rising in the tube C is followed by cold pure air from the fresh-air shaft B through the aperture H. This shaft, being a part of the chimney, extends to the top of the building, and therefore brings the air from an elevated and pure source. The top of the fresh-air shaft should be several feet below the top of the smoke part of the chimney to avoid the drawing down of smoke.

As we have seen in previous pages, this chimney must be large. There is little danger, under the present arrangement of conveying the smoke, of getting it too large.

It should, if built for four rooms, have an area of cross-section of at least 64 square feet, making it equivalent to 8 feet square. Summarized, a chimney thus constructed furnishes an outlet for smoke, for foul air, and an inlet for fresh air. The heat in it from the furnace has a tendency both to draw the foul air out and the pure air into the rooms, as explained.

How, now, is the fresh air thus admitted beneath the floor to be warmed and distributed? This may be understood by reference to Fig. 25. J represents a series of

FIG. 25.

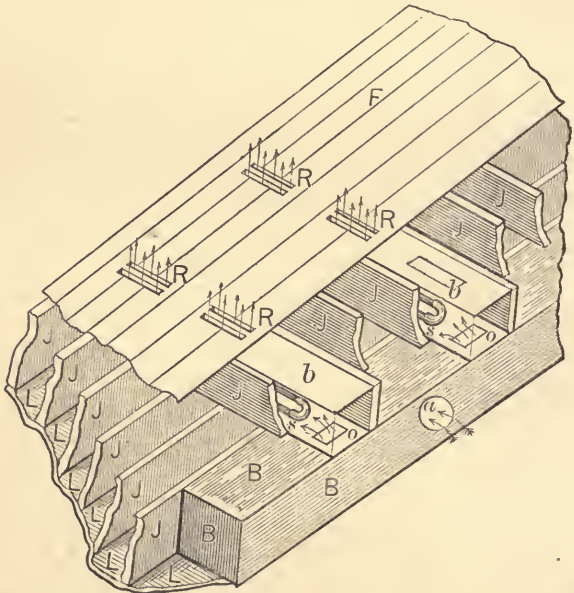

floor joists, and J' another series resting upon the first at right angles. This double arrangement is to give sufficient

room for the various radiating boxes necessary to perfect distribution. The inlet *a* corresponds to A and A' of Fig. 24, and is the opening into the box B, extending along under one side of the room; O are openings or registers, opening from the large box B into smaller radiating boxes *b*, which extend along under the floor between the upper set of floor-joists; *s s* are steam-pipes for further warming the air as it enters.

The heat from this source gives to the air already in motion another impulse in the same direction, upward through the floor register R, as indicated by the arrows, thus further increasing and securing constancy and steadiness of the air movement.

The air, on thus entering, will be properly warmed, and being admitted at the floor will secure comfort for the feet. There should be a radiating box, *b*, for every row of desks, to deliver the air through registers situated at frequent intervals along the aisles. The warm air, thus perfectly distributed, as it enters rises toward the ceiling, both by its own specific lightness due to temperature, and by its tendency to fill the vacuum produced at the top of the room from the draft of the aspirating chimney, as explained in Fig. 24.

Here there can be no uncertainty about the disposition of CO₂ and the organic emanations from skin and lungs. All of these impurities are carried off as fast as formed, both from a tendency which an animal temperature of 98° gives them to rise, and the constant stream of rising air into which they are poured.

Steam-pipes should also be placed in the large radiating box B, to aid both in warming the air and in increasing the strength and steadiness of the movement. These boxes should be made of wood and lined with tin. F is the floor of the room. At O there should be a damper

for regulating the draft, and controlled by a lever extending up through the floor. The opening, *a*, should be large, as the amount of air delivered through it is great. The form and proportion are of course not specified in the figure, which is only intended to make the principle of the movement understood.

What, now, it may be asked, will prevent the space beneath the floor from filling with dirt through the floor registers? This is answered in Fig. 26, which represents

FIG. 26.

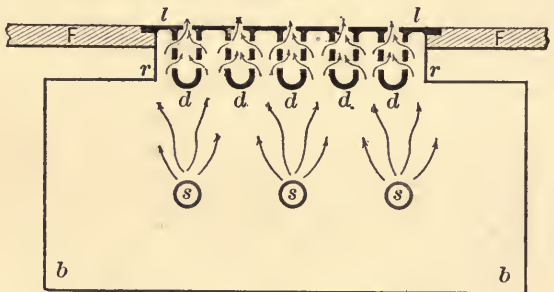

a cross-section through a portion of the floor, the radiating box, and containing steam-pipes. *F* shows the floor; *r* the connecting box-riser; *b b*, the radiating box; *s s s*, the steam-pipes; and *l l*, the lid of the register in the space fitted for it in the floor.

The peculiar shape of this lid, as represented, will be sufficient to suggest how the dirt is prevented from falling into the box. Everything which falls through the spaces at the top of the lid will be received by the loops at *d*. The arrows indicate the direction of the air through the numerous holes made in the perpendicular sides of the several loops. Floating dust will have no tendency to enter these holes, because the current of air will pre-

vent it, being from the direction to drive it away. These lids, made of light castings, will not be expensive, and can be easily raised out and freed from dirt, which from time to time will accumulate in the loops.

The two sets of floor-joists which this system necessitates will incur some additional expense, but this will be slight when the accompanying advantages are considered. The greater space which the double arrangement would require would not necessitate any increase in the height of the building, for it is plain that when rooms are ventilated as above described, the height of the room is not important. The number of cubic feet of air space for each pupil loses importance as perfect ventilation is approximated. Thousands of people may stand crowded together in the open air and all be provided with pure air. This is simply because the ventilation of Nature is perfect. The heated emanations from the body rise and fresh air comes in from all sides to fill the partial vacuum. This is the method above proposed. The movement of all the air in the room is upward, with ample provision for the supply of plenty of fresh warm air from below.

Thus far we have considered ventilation with reference to the requirements of winter, or when artificial heat is required to raise the internal temperature of the rooms above that of the outside. In the fall and spring, when no extra heat is needed in the rooms—when the internal and external temperatures are nearly equal—it is then only necessary to heat the air in the foul-air compartment of the chimney in order to maintain a draft sufficient to abstract the foul air as fast as formed. There are several ways to do this. A stove may be set at the bottom of the chimney, or coils of steam-pipe may extend into it from the boiler. For the system we are considering this is the proper method of heating the chimney in warm weather.

By means of valves the steam may be shut off from all the radiator pipes, allowing it to pass only through the pipes in the chimney. And, owing to the manner in which the heat of the smoke and the waste products of combustion are utilized, the necessary heat could be by this means most economically produced.

This heating of the chimney in warm weather should not be neglected. It is commonly supposed that in warm weather, when the windows may be opened, ventilation is easily secured. This is a great mistake. It is easier to ventilate in winter than in summer. In cold weather the inequality of internal and external temperature is in itself a cause of movement, as heretofore explained; but when the internal and external temperatures are nearly equal, change of position takes place (in the absence of wind) only by diffusion.

In order to suit the conditions of cool weather, when a little heat is needed, the pipes extending through the radiators should be connected in sections, so that steam could be shut off from any number of them as desired. For instance, Fig. 27 shows a main supply pipe, sending off branches which are again subdivided, each sending a pipe to the several radiators. Thus, section A sends one pipe through each radiating box in the building; section B another, section C another. When only a third of the usual amount of heat is required, all the valves are closed except C, through which steam will then alone be admitted. If more heat is needed, open valve B. In coldest weather, open all. For the severest weather, in high latitudes, a section should be set apart leading to direct radiators placed in the rooms. By skillful management of the details any temperature may be secured and ventilation be equally good in all seasons.

Another advantage which the double set of floor-joists

secures is in the effectual deadening of sound which the enlarged space would secure. In all school-houses of

FIG. 27.

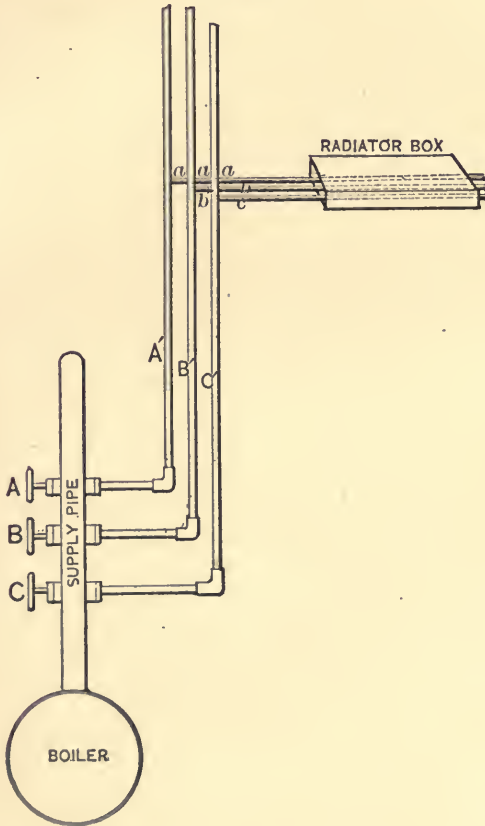

two or more stories some means of deadening the sound of moving feet, conducted through the floor and ceiling

to the room below, is absolutely essential. Where this is effectually done, the cost will exceed that of the double joists. This system of warming and ventilating, it appears to me, answers all the requirements of ventilation :

1. The air taken from the height of the building is from a pure source.
2. From the large size of the chimney and fresh-air shaft, this air is sufficient in quantity.
3. By the distribution of steam-pipes as described it is warmed before being admitted into the room.
4. By a proper apportionment of these pipes the air need not be overheated.
5. By the numerous small registers distribution is perfect.
6. It is through the floor, thus securing the warmth of the feet.
7. It is not entrapped in the upper part of the room, but rapidly hurried away from this point.
8. The inlets and outlets being of ample size, and the velocity of the air sufficient, the ventilation will be independent of doors and windows.

On the latter point too much stress can not be laid. Open doors and windows, especially in a city, are a source of great annoyance. The rattle of passing vehicles, the din of machinery and steam-whistles, sometimes render it impossible to hear a recitation. In windy weather great clouds of dust from the streets, and smoke from neighboring chimneys, pour in through open windows to complete the discomfiture of all helpless victims of window ventilation. In winter, where windows are relied upon, currents of icy cold air pour in, endangering the lives of pupils ; while currents of warm air pour out, sometimes before it has been utilized.

It will doubtless be a surprise to many that the fresh-air shafts and chimneys for foul air need to be so large ; but a careful perusal of the foregoing pages will convince the intelligent reader that there is no help for this if anything like perfect ventilation is approximated. Facilities

for ventilation are to a house what lungs are to an animal. They must be capacious and active, to maintain a healthy and vigorous life. The ventilating and warming apparatus constitute the vital organs of a building, and are therefore of first importance in school-house building. Utility first and ornamental finish last. Where utility and architectural symmetry conflict, the latter should give way to the former. Give us life first and beauty second. However, it need not be supposed that symmetry is necessarily sacrificed or school-room capacity interfered with by the use of these generous chimneys.

The three essential qualities of a school-house, named in the order of their importance, are utility, simplicity, and beauty. If these qualities are attended to in the order here named, all three are possible of attainment; but if the order be reversed, as is commonly the case, only the first—beauty—will be attained.

In a two-story building one chimney should not be required to serve more than four rooms. If three stories, it may supply six rooms. A peculiarity of this system of ventilating is that the higher the building the greater is its efficiency. The reason for this is evident. The draft of a chimney is not only always increased with its height, but in this case the higher the building the farther the fresh-air tubes will extend upward through the heated air of the aspirating chimney. This not only adds still more power to the draft, by the additional heat given to the ascending fresh air, but this heat is utilized in giving additional warmth to the air before it enters the radiators.

There are many designs which might be made, whereby all the qualities of a good school-house are secured. An original plan is suggested in Fig. 28, which may be considered the first story either of a two or three story building. If two stories, there will be sixteen rooms; if

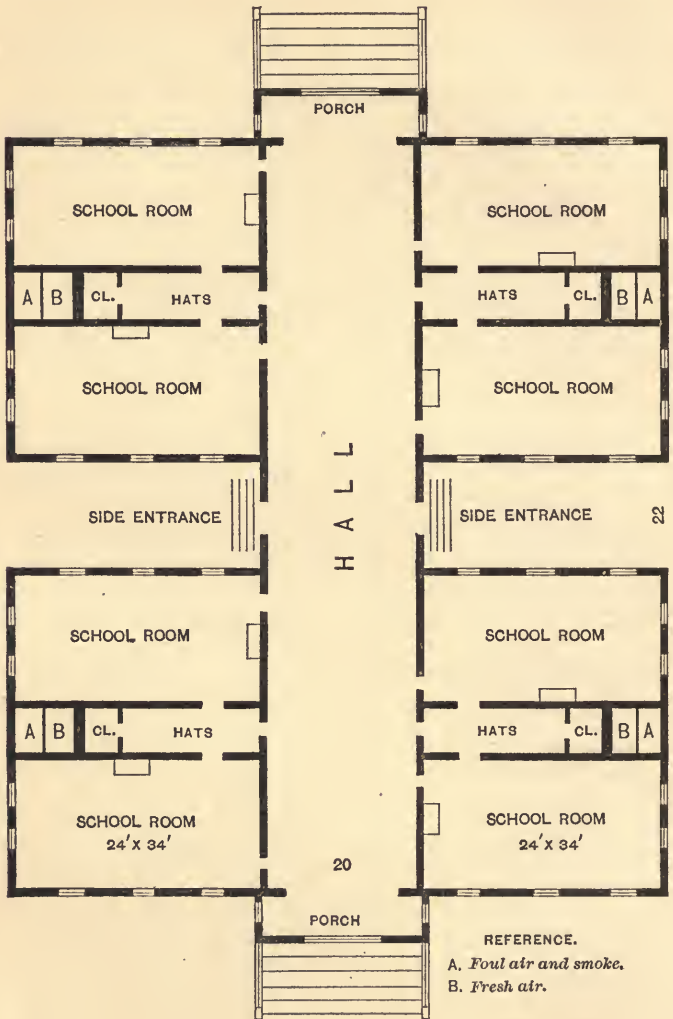

three stories, twenty-four rooms. This is as many rooms as will commonly be found necessary in a single building.

The plan is self-explanatory. The spaces between the rooms serve the purposes of fresh air, foul air, smoke, water-closet, and hat-room. The water-closet adjoins the foul-air part of the chimney. An opening through the dividing wall will effectually ventilate the closet. A is the smoke and foul-air part of the chimney, and B the fresh-air shaft; the latter communicating with the former, as shown in Fig. 24. The combined chimney and fresh-air shaft should have at least 64 square feet sectional area. It may be made by this plan of almost any size without inconvenience or sacrifice of symmetry. Iron ladders should be secured on the inside of both compartments of the chimney to facilitate the adjustment and repair of the various pipes.

One half of this design makes a plan for an eight-room building. Eight rooms is generally preferable to any other number. For this arrangement not only gives unobstructed light on two sides of each room, but more easily meets architectural requirements, and is sufficient to serve the ends of ordinary graded school-work. The large plan is here given to answer the requirements in large and crowded cities where the economy of space requires as few buildings as possible, and for high-school buildings where eight rooms are sometimes insufficient to serve the demands of the proper specialization of the various departments.

Fig. 29 is a plan illustrating how the same qualities may be secured in a building of 6 or 12 rooms.

The advantages which these plans secure are : 1. The whole building is perfectly warmed and ventilated. 2. There is light on two sides of each room. 3. The chimneys are out of the way and do not project into the school-

rooms. 4. There is plenty of blackboard room on plane surface unbroken by adajutting ehimneys and a multi-
 plicity of windows.

Let it be noted here that narrow hat-rooms are gen-

FIG. 29.

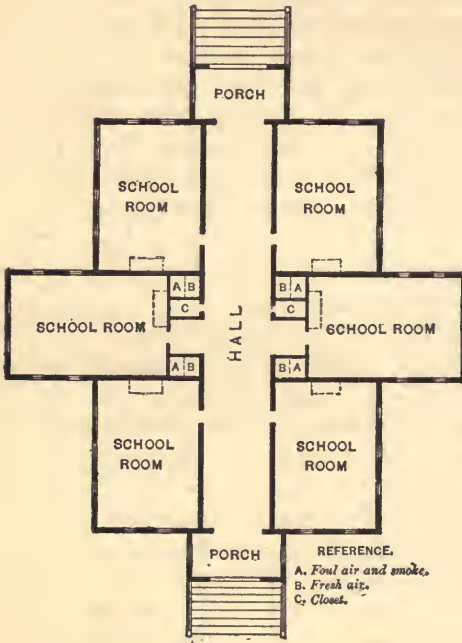

erally a nuisance, and a source of crowding and disorder at dismissal. The halls should be wide, with a stationary hat-rack extending along each side about three feet from the wall. This arrangement gives not only plenty of room for hats and wraps, but makes them accessible. The small hat-rooms in the foregoing plan are given not so much to meet any real necessity for them, as to utilize space which

would otherwise be useless. By using them as merely supplementary to the hall space, crowding in them may be avoided.

These, it appears to me, are some of the essentials of a school-house. I leave the superficial embellishments to the taste of the architect. Towers, turrets, buttresses, cantilevers, balustrades, consoles, corbels, scrolls, cupolas, pilasters, pendants, paint, and colored glass are of later consideration. These are all useful after the essentials are first secured. They are educative, and should be encouraged to the full extent of the remaining means for procuring them after the vital organs have been intelligently planned and skillfully adjusted.

NOTE.—A patent on this system has been applied for.

APPENDIX.

A.

By a long and laborious series of observations with hygrometers and dry- and wet-bulb thermometers, Mr. Glaisher deduced empirically a series of factors which are of inestimable value in testing the humidity of the air by means of the wet and dry bulbs. To use these factors, multiply the difference between the dry and wet bulb readings by the factor which stands opposite the dry bulb temperature, and the product subtracted from the dry bulb temperature will give the dew point.

Let t = temperature of dew point.

“ t^2 = “ “ dry bulb.

“ t^1 = “ “ wet bulb.

“ k = factor.

We then have the formula

$$t = t^2 - (t^2 - t^1) k. \quad . \quad . \quad . \quad (1.)$$

GLAISHER'S FACTORS.

Reading of dry bulb.	Factor <i>k</i> .	Reading of dry bulb.	Factor <i>k</i> .	Reading of dry bulb.	Factor <i>k</i> .	Reading of dry bulb.	Factor <i>k</i> .
10°	8.78	33°	3.01	56°	1.94	79°	1.69
11	8.78	34	2.77	57	1.92	80	1.68
12	8.78	35	2.60	58	1.90	81	1.68
13	8.77	36	2.50	59	1.89	82	1.67
14	8.76	37	2.42	60	1.88	83	1.67
15	8.75	38	2.36	61	1.87	84	1.66
16	8.70	39	2.32	62	1.86	85	1.65
17	8.62	40	2.29	63	1.85	86	1.65
18	8.50	41	2.26	64	1.83	87	1.64
19	8.34	42	2.23	65	1.82	88	1.64
20	8.14	43	2.20	66	1.81	89	1.63
21	7.88	44	2.18	67	1.80	90	1.63
22	7.60	45	2.16	68	1.79	91	1.62
23	7.28	46	2.14	69	1.78	92	1.62
24	6.92	47	2.12	70	1.77	93	1.61
25	6.53	48	2.10	71	1.76	94	1.60
26	6.08	49	2.08	72	1.75	95	1.60
27	5.61	50	2.06	73	1.74	96	1.59
28	5.12	51	2.04	74	1.73	97	1.59
29	4.63	52	2.02	75	1.72	98	1.58
30	4.15	53	2.00	76	1.71	99	1.58
31	3.66	54	1.98	77	1.70	100	1.57
32	3.32	55	1.96	78	1.69		

The elastic force of vapor of water increases with the temperature. If, then, the elastic force of vapor of water at the temperature of saturation (dew point) be divided by the elastic force of vapor at a given temperature, the quotient will express the ratio of humidity to saturation.

The following table shows the elastic force of vapor of water, measured in inches of mercury :

Let *t* = temperature of dew point.

“ R = ratio of humidity.

“ *p* = elastic force of vapor at temperature T.

“ T = temperature of the air.

“ *p'* = elastic force of vapor at temperature *t* (dew point).

$$\text{Then } R = \frac{p'}{p} \dots \dots \dots (2.)$$

Tempera- ture of the air.	Force of vapor in inches of mercury.	Tempera- ture of the air.	Force of vapor in inches of mercury.	Tempera- ture of the air.	Force of vapor in inches of mercury.	Tempera- ture of the air.	Force of vapor in inches of mercury.
T°	p	T°	p	T°	p	T°	p
0	0.044	24	0.129	48	0.335	72	0.785
1	0.046	25	0.135	49	0.348	73	0.812
2	0.048	26	0.141	50	0.361	74	0.840
3	0.050	27	0.147	51	0.374	75	0.868
4	0.052	28	0.153	52	0.388	76	0.887
5	0.054	29	0.160	53	0.403	77	0.927
6	0.057	30	0.167	54	0.418	78	0.958
7	0.060	31	0.174	55	0.433	79	0.990
8	0.062	32	0.181	56	0.449	80	1.023
9	0.065	33	0.188	57	0.465	81	1.057
10	0.068	34	0.196	58	0.482	82	1.092
11	0.071	35	0.204	59	0.500	83	1.128
12	0.074	36	0.212	60	0.518	84	1.165
13	0.078	37	0.220	61	0.537	85	1.203
14	0.082	38	0.229	62	0.556	86	1.242
15	0.086	39	0.238	63	0.576	87	1.282
16	0.090	40	0.247	64	0.596	88	1.323
17	0.094	41	0.257	65	0.617	89	1.366
18	0.098	42	0.267	66	0.639	90	1.401
19	0.103	43	0.277	67	0.661	91	1.455
20	0.108	44	0.288	68	0.685	92	1.501
21	0.113	45	0.299	69	0.708	93	1.548
22	0.118	46	0.311	70	0.733		
23	0.123	47	0.323	71	0.759		

Example 1.—Suppose the temperature of the room as indicated by the dry bulb to be 72° ; the temperature of the wet bulb 68° . Required the temperature of the dew point, and the degree of humidity. In formula (1) $t^2 = 72^{\circ}$; $t' = 68^{\circ}$; $k = 1.75$; then, $t = 72^{\circ} - (72^{\circ} - 68) 1.75$; $t = 47.5^{\circ}$.

In formula (2) p' , for $47.5^{\circ} = 0.323$; p , for $72^{\circ} = 0.785$; $R = \frac{p'}{p} = \frac{0.323}{0.785} = .40$ (per cent of saturation).

This shows an atmosphere somewhat too dry. The degrees of difference between the dry and wet bulb readings which should exist in order to conform to any required standard may be shown by the following:

Example 2.—If the temperature of the room as shown by the dry-bulb thermometer be 72° , what should be the temperature of the wet bulb in order to conform to the provisional standard of humidity given by de Chaumont, 73° ? From formula (2) $p' = R p = .73 \times .785 = .573$. The degree in the table corresponding to this number is 63° . This is the dew point corresponding to our standard.

From formula (1) $t' = \frac{t + t^2 k - t^2}{k} = \frac{63 + (1.75 \times 72) - 72}{1.75} = 66$, the number of degrees which should be shown by the wet bulb when the dry bulb shows 72° .

B.

Aspirating chimneys and ventilating shafts are sometimes employed to counteract the force of the wind, to increase the velocity of the flow of air into the room by means of a fire in the chimney, to warm the air before it enters the room, and to draw the air from an elevated source to insure purity. The following, Fig. 30, illustrates a simple form, sufficiently accurate to illustrate the use of the formulas, though not ideally correct as to the relative position and number of openings. Reference: 1, entrance shaft; 2, horizontal air-duets; 3, room; 4, aspirating chimney; 5, grate. We have here, in addition to the conditions before given, an acceleration in the velocity of the air entering the room due to the aspirating power of the chimney; increase of temperature in the chimney by fire; and friction due to the surfaces and angles in the air-passages. The *co-efficients of friction* used by engineers are as follows: In duets, 0.024; for rough flues, 0.05; for brick flues, 0.05; for square elbow,

1.50 ; for circular elbow, 0.50 ; air passing from a larger to a smaller flue, .50 ; air passing through a wall or plate,

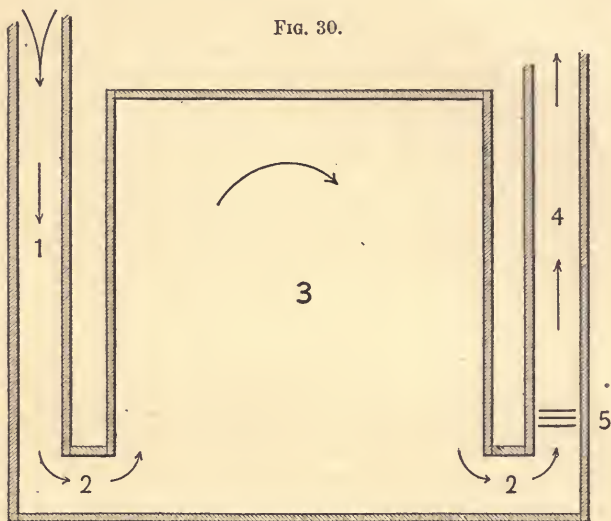

0.50 ; air passing from a smaller to a larger flue through an opening in the wall, Fig. 31. Reference : A, A^1, A^2

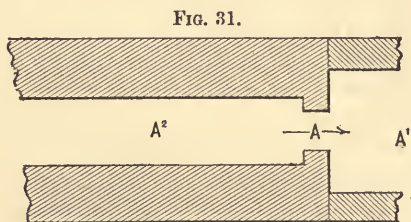

= areas of flues ; f = co-efficient of friction in ducts ;
 f^1 = co-efficient of friction in elbows ;

$$a = \cdot 60 \text{ when } A > A^2, f^1 = \left\{ \frac{A}{A^1 a} - 1 \right\}^2,$$

$$\text{when } A^1 = A^2 < A, f^1 = \left\{ \frac{A}{A^1} - 1 \right\}^2.$$

When the angle of a tube, ventilating shaft, or other air-passage is not 90° the conditions of any angle between 0 and 180° may be approximately expressed by the formula :

$\frac{1 + \cos \phi}{2}$. With these new elements, and from the fact

that the velocity is inversely proportional to the square root of the friction, and that for similar cross-sections the friction is inversely as the diameter, we have the following, another modification of Montgolfier's formula :

$$V = \sqrt{\frac{e(t_2 - t)}{1 + et} \cdot \frac{2gh}{1 + f\frac{l}{d} + f^1}};$$

where V = velocity of air in feet per second in ducts.

e = expansion of air for 1° Fahr., $\cdot 00203$.

t = external temperature.

t^2 = internal temperature of the chimney.

l = length of ducts, including $h + h^2 + l^1 + l^2$.

f = co-efficient of friction in ducts.

f^1 = co-efficient of friction in elbows.

g = acceleration due to gravity = $32\cdot 166$ feet.

d = diameter of ducts.

h^1 = height of aspirating chimney.

h^2 = height of entrance chimney.

h = total height of chimneys.

Example.—Suppose that $t^2 = 100^\circ$; $t = 60$; $l = h + h^2 + l^1 + l^2 = 80 + 30 + 8 + 8 = 126$ feet; $h = 80$; $f = \cdot 05$ for brick flues; f^1 for 2 square elbows = $1\cdot 5 \times 2 = 3$; $d = 3$. Then :

$$V = \sqrt{\frac{\cdot 00203 (100 - 60)}{1 + \cdot 00203 \times 60} \cdot \frac{2 \times 32 \cdot 16 \times 50}{1 + \cdot 05 \frac{136}{3} + 3}} =$$

$$\sqrt{\frac{\cdot 0812 \times 5145 \cdot 6}{1 \cdot 1218 \times 6 \cdot 266}} = \sqrt{\frac{417 \cdot 82272}{7 \cdot 02919}} = \sqrt{59 \cdot 44} = 7 \cdot 7 \text{ feet}$$

per second. This, being the rate at which the air passes out of the room, may also be taken as the rate passing in. It thus appears that where the friction is considerable the aspirating chimney, or other means of accelerating the movement of air, becomes a necessity.

C. (See page 84.)

The following formulas, taken from Schumann's "Manual," will be useful in determining the size and construction of the various parts of the fan :

Reference :

V = volume of air delivered in cubic feet per second.

h = height of manometer.

c = velocity of air entering the fan.

c_1 = velocity of air leaving the fan.

r = outer radius of vanes.

r_1 = inner radius of vanes.

r_2 = radius of inlet.

b = width of vanes.

a = height of outlet.

a_1 = distance from vertical radius to point e (see Fig. 14).

n = number of revolutions per minute.

p = radius of a circle whose diameter is unity = 3.1416.

$r_2 = \sqrt{\frac{V}{c p}}$, where there is one inlet.

$r_2 = \sqrt{\frac{V}{2 c p}}$, where there are two inlets.

$$b = \frac{r_2^2}{2 r_1}, \text{ where there is one inlet.}$$

$$b = \frac{r_2^2}{r}, \text{ where there are two inlets.}$$

$$b = \frac{V}{2 p r_1 c}; r_1 = r_2 \text{ to } 2 r_2;$$

$$n = \frac{2636}{r} \sqrt{h}; a = \frac{V}{b c_1};$$

$$a_1 = 0.159 a.$$

D.

CONDUCTING POWER OF MATERIALS. *

Value c , being the units of heat transmitted per hour per square foot of a plate 1 inch thick, the two surfaces differing in temperature 1° .

$c =$

Copper.....	515.000
Iron.....	233.000
Zinc.....	225.000
Lead.....	113.000
Marble, gray, fine grained.....	28.000
Marble, white, coarse grained.....	22.400
Stone, calcareous, fine.....	16.700
Stone, calcareous, ordinary.....	13.680
Glass.....	6.600
Brick-work, baked clay.....	4.830
Plaster, ordinary.....	3.860
Oak, perpendicular to fibers.....	1.700
Walnut, perpendicular to fibers.....	0.830
Pine, perpendicular to fibers.....	0.748
Pine, parallel to fibers.....	1.370
Walnut, parallel to fibers.....	1.400

$c =$

Gutta-percha.....	1.380
India-rubber.....	1.370
Brick-dust, sifted.....	1.330
Coke, pulverized.....	1.290
Cork.....	1.150
Chalk, in powder.....	0.869
Charcoal of wood, powdered.....	0.636
Straw, chopped.....	0.563
Coal, small sifted.....	0.547
Wood-ashes.....	0.531
Mahogany dust.....	0.523
Canvas of hemp, new.....	0.418
Calico, new.....	0.402
Writing-paper, white.....	0.346
Cotton or sheep's wool.....	0.323
Eider-down.....	0.314
Blotting-paper, gray.....	0.274

For double windows, when the glass is not less than 2 inches apart, $c = 3.6$.

Stagnant air, $c = 0.3$.

E.

Value of r , being the radiating and absorbing power of bodies, in units of heat per square foot, for a difference of 1° Fahr., from the experiments of Piclet :

$r =$

Silver, silvered copper.....	0.02657
Copper.....	0.03270
Tin.....	0.04395
Zinc and brass, polished.....	0.04906

r =

Iron, tinned.....	0·08585
Iron, sheet	0·09200
Iron, ordinary.....	0·56620
Iron, cast, new.....	0·64800
Iron, sheet and cast, rusted.....	0·68680
Lead, sheet.....	0·13286
Glass	0·59480
Chalk.....	0·67860
Wood sawdust, fine.....	0·72150
Building stones, plaster, wood, brick ..	0·73580
Sand, fine.....	0·74000
Calico.....	0·74610
Woolen stuffs.....	0·75220
Silk stuffs, oil paint	0·75830
Paper.....	0·77060
Lampblack	0·81960
Water.....	1·08530
Oil	1·48000

F. (See page 87.)

The Blackman Fan.—My invention is a ventilating-fan, constructed, as fully described hereinafter, so as to rapidly transmit motion to large volumes of air, carrying the same in solid columns without dispersing it or creating back currents.

In the drawings, Fig. A (see page 87, Fig. 13) is a near view of a ventilating-fan with my improvements. Fig. B is a section on the line 1, 2, Fig. A. Figs. C to G (Fig. 32, page 170) are diagrams illustrating the formation of the blades. Fig. H, a perspective view of a blade and the hub.

FIG. 32.

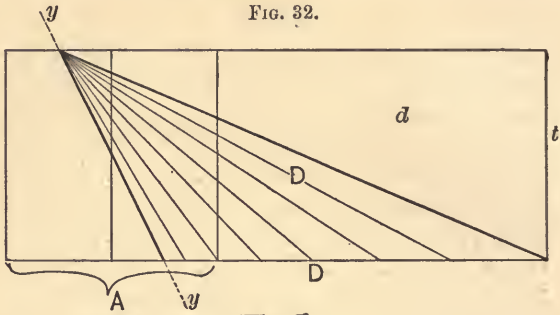

Fig. C



Fig. D

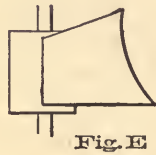

Fig. E

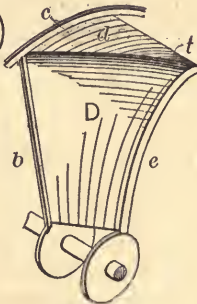

Fig. H



Fig. F



Fig. G

In experimenting with that class of fans used to put air in motion for ventilating and other purposes, I ascertained that, in ordinary constructions, while volumes of air would be driven forward by the revolution of the fans, other volumes would be thrown off radially, and still others would be thrown backward instead of forward, as desired, creating currents interfering with the free flow of air to the fan. After many experiments I ascertained that by bending each blade outward at the upper end, forming peripheral sections, thus compelling the large volumes ordinarily dissipated in this direction to move directly forward.

My present invention relates to certain improvements whereby I have succeeded in preventing altogether any back-flow, insuring a forward propulsion of all the air coming within the influence of the wheel.

In the course of my experiments I ascertained that it was necessary to so construct each blade of the wheel as to draw or deflect outward the air from the forward edge of every portion of the blade, and to set every portion or face of the blade at such an angle that the forward edge at every point would "cut under" the air rather than move it laterally or carry it with the wheel, and that while portions of the blade might be so bent as to throw the air outward, other portions, if not properly shaped, would draw it back, creating counter currents. I found that to prevent such results it was essential to vary the angle and curve of the blade at different points, and that although such angles and curves would be different, according to the sizes of the wheels and number of blades, there were certain definite and specific proportions and forms common to all, which result in much improved effects, and which I will now specify.

The hub A of the wheel may be solid, or may consist of disks *a a'* secured to the shaft B. From the hub ex-

tend radial ribs b , which meet an annular rim c , and said ribs constitute the straight edges of the blade D , the rim c and ribs being all in the same vertical plane x . The diameter of the hub A and the depth of the wheel should, to secure the best results, be about equal to one sixth of the diameter of the wheel, and the ribs or edges b , instead of being radial, should coincide with lines extending from the periphery, through the hub, midway between the axis and periphery of the latter. The blades, instead of being set with their inner ends parallel to the axis, join the hub upon lines yy , crossing the axial line at an angle at the center, and the forward edge of each blade corresponds to a curve which is gradually increased toward the outer end, the edges of all the blades being upon a plane zz , parallel to the plane xx . Thus the forward edge of each blade may be a rib, e , extending from the hub nearly parallel for a short distance with the rib b , and then curved forward until it nears the periphery, when the curve is sharper, as shown. The body of the blade, between the edges or ribs b , e , is gradually bent at an angle which becomes more and more obtuse to the axis of the shaft as it approaches the periphery, as shown in fine lines, Fig. C, and is also bent from a perpendicular line, parallel to the edge b , as it recedes from said line toward the edge e , as shown in dotted lines, Fig. A. At the periphery the blade is bent to form a peripheral section, d , that extends from the blade to the rim c , and has a forward edge, t , parallel to the axis of the shaft. This peripheral section may form part of the blade, or may be a separate piece riveted or otherwise secured thereto. If the blade were bent or hollowed from each end to the center, as shown by the outline, Fig. D, the air collected by the ends of the blade, instead of being carried outward, would be drawn to the center and thrown backward in currents,

interfering with the flow of air to the wheel ; so, if the blade at any point, as at the hub, Fig. E, is too nearly parallel with the axis of the shaft, the air, instead of being sent forward, will be carried round with the wheel, and the effect will not be proportioned to the power expended. By setting the blade at an angle to the axis, as shown in Fig. C, by maintaining the portion near the hub comparatively flat, by bending the body beyond the center, and by giving a sharper curve thereto near the periphery, where it meets the peripheral section, as described, I have succeeded in preventing any back-flow, and have with comparatively little power imparted movement to large volumes of air in one direction, and in nearly solid columns. This effect is increased by setting the blade somewhat tangential to the axis, as described, instead of radially, the outer end thus being pitched forward, so as to draw in the air, instead of dispersing it radially. This will be best understood on reference to diagrams Figs. F and G, in which diagram F illustrates a radial blade which throws out the air by its revolution, while diagram G represents a blade set tangentially to the hub, and tending to draw the air toward the latter. It will be evident that the ribs *b e* may be flanges formed by bending the edges of the blades.

It is common to set ventilating-fans in openings in walls or frames, which completely surround the peripheries of the fans and prevent any radial inflow of air. I set my fan back so that the front face will be nearly on the same plane as the inner surface, *w*, of the wall or frame, as shown, thus permitting a free flow of air to the periphery (see Fig. 13).

BOOKS FOR TEACHERS.

Spencer's Education:

INTELLECTUAL, MORAL, AND PHYSICAL. Divided into four chapters: What Knowledge is of most Worth?—Intellectual Education—Moral Education—Physical Education. Price, \$1.25.

Bain's Education as a Science.

The author views the "teaching art" from a scientific point of view, and tests ordinary experiences by bringing them to the criterion of psychological law. Price, \$1.75.

Bain's On Teaching English,

WITH DETAILED EXAMPLES, AND AN INQUIRY INTO THE DEFINITION OF POETRY. Price, \$1.25.

Johonnot's Principles and Practice of Teaching.

This is a practical book by an experienced teacher. The subject of education is treated in a systematic and comprehensive manner, and shows how rational processes may be substituted for school-room routine. Price, \$1.50.

Baldwin's Art of School Management.

This is a very helpful hand-book for the teacher. He will find it full of practical suggestions in regard to all the details of school-room work, and how to manage it to best advantage. Price, \$1.50.

Greenwood's Principles of Education Practically Applied.

The object of this work throughout is to impress this important question upon the mind of the teacher: "*How shall I teach so as to have my pupils become self-reliant, independent, manly men and womanly women?*" Price, \$1.00.

Sully's Outlines of Psychology,

WITH SPECIAL REFERENCE TO THE THEORY OF EDUCATION. Price, \$3.00.

Sully's Hand-Book of Psychology,

ON THE BASIS OF OUTLINES OF PSYCHOLOGY. A practical exposition of the elements of Mental Science, with special applications to the Art of Teaching, designed for the use of Schools, Teachers, Reading Circles, and Students generally. Price, \$1.50.

Bain's Moral Science.

A COMPENDIUM OF ETHICS. Divided into two divisions. The first—the Theory of Ethics—treats at length of the two great questions, the ethical standard and the moral faculty; the second division—on the Ethical Systems—is a full detail of all the systems, ancient and modern, by conjoined abstract and summary. Price, \$1.50.

McArthur's Education,

IN ITS RELATION TO MANUAL INDUSTRY. The important subject of manual education is thoroughly and clearly treated. Price, \$1.50.

Hodgson's Errors in the Use of English.

A work for the teacher's table, and invaluable for classes in grammar and literature. Price, \$1.50.

Descriptive Catalogue sent free on application. *Special prices will be made on class supplies.*

D. APPLETON & CO., Publishers,
New York, Boston, Chicago, Atlanta, San Francisco.

A NEW AND CAREFULLY REVISED EDITION OF

JOHN STUART MILL'S
PRINCIPLES OF POLITICAL ECONOMY.

Abridged, with Critical, Bibliographical, and Explanatory Notes, and a Sketch of the History of Political Economy.

By JAMES LAURENCE LAUGHLIN, Ph. D.,
Assistant Professor of Political Economy in Harvard University.

*With Twenty-four Maps and Charts. 8vo. 658 pages.
Cloth, \$3.50.*

No writer on Political Economy, since Adam Smith, the acknowledged father of Political Science, can be compared in originality, exact and forcible expression, and apt illustration, to John Stuart Mill. His writings on this great subject, while practical and popular in their adaptation, are also characterized by the true philosophic method. In his knowledge of facts and conditions, his clearness of understanding, and the soundness of his reasoning, he excels all other writers on the subject, and his "PRINCIPLES OF POLITICAL ECONOMY" has been an unfailing source of information and authority to all subsequent writers and students of political science.

To present this work in form, size, and method, somewhat better adapted to class-room use, and present modes of study, and at the same time to preserve it so far as possible in the form and language of its great author, has been the aim in the present revision. The editor has made this work essentially a revision, and not a *systematic mutilation*. The publishers therefore feel confident that the new edition will be found thoroughly adapted to class use, and as such will prove a valuable and satisfactory text-book, and at the same time will be found to retain and present all the essential and valuable features of the original work.

The new edition retains, in its own clear exposition, the connected system of the original, and at the same time its size is lessened by omitting what is Sociology rather than Political Economy. The difficulties of the more abstract portions of the original work are much lightened, and the new edition presents, in connection with the general tenor of the work, some important additions of later writers.

For sale by all booksellers ; or sent by mail, post-paid, on receipt of price.

New York: D. APPLETON & CO., Publishers, 1, 3, & 5 Bond Street.

EDUCATION IN RELATION TO MANUAL INDUSTRY.

By ARTHUR MACARTHUR, LL. D. 12mo. Cloth, \$1.50.

"Mr. MacArthur's able treatise is designed to adapt to the usual methods of instruction a system of rudimental science and manual art. He describes the progress of industrial education in France, Belgium, Russia, Germany, and Great Britain, and the establishment of their professional schools. The technical schools of the United States are next reviewed. Mr. MacArthur is anxious that the State governments should take up the subject, and enable every girl and boy to receive a practical education which would fit them for use in this world. This valuable book should be carefully read and meditated upon. The discussion is of high importance."—*Philadelphia Public Ledger*.

"The importance of this book can not be too greatly urged. It gives a statistical account of the industries of various countries, the number of workmen and workwomen, and the degree of perfection attained. America is behind in native production, and, when we read of the importation of foreign workmen in simple manufactures such as glass, it is a stimulus for young men to train themselves early as is done in foreign countries. The necessity of training-schools and the value and dignity of trades are made evident in this work. It is particularly helpful to women, as it mentions the variety of employments which they can practice, and gives the success already reached by them. It serves as a history and encyclopædia of facts relating to industries, and is very well written."—*Boston Globe*.

"The advocates of industrial education in schools will find a very complete manual of the whole subject in Mr. MacArthur's book."—*Springfield Republican*.

"A sensible and much-needed plea for the establishment of schools for industry by the state, supported by the practical illustration of what has been accomplished for the good of the state by such schools in foreign countries. Great Britain has never regretted the step she took when, recognizing at the Crystal Palace Exhibition her inferiority in industrial art-work, she at once established the South Kensington Museum, with its annexed art-schools, at a cost of six million dollars."—*The Critic*.

"The aim of the book is succinctly stated, as it ought to be, in the preface: 'What is industrial education? What are its merits and objects, and, above all, what power does it possess of ministering to some useful purpose in the practical arts of life?' These are questions about which we are deeply concerned in this country, and the author has essayed to answer them, not by an abstract discussion of technical instruction, but by giving a full and accurate account of the experiments in industrial training which have been actually and successfully carried out in Europe."—*New York Sun*.

"A most interesting and suggestive work on a matter of immediate and universal importance."—*New York Daily Graphic*.

"An admirable book on a much-neglected subject. Those countries have made the most rapid advance in the line of new industries which have paid the most attention to the methods here recommended of primary instruction. The land that neglects them will sooner or later cease to be in the front ranks of applied science and the useful arts."—*New York Journal of Commerce*.

For sale by all booksellers; or sent by mail, post-paid, on receipt of price.

New York: D. APPLETON & CO., 1, 3, & 5 Bond Street.

SULLY'S TWO GREAT WORKS.

Outlines of Psychology, with Special Reference to the Theory of Education.

A Text-Book for Colleges. By JAMES SULLY, A. M., Examiner for the Moral Sciences Tripos in the University of Cambridge, etc., etc.

"A book that has been long wanted by all who are engaged in the business of teaching and desire to master its principles. In the first place, it is an elaborate treatise on the human mind, of independent merit as representing the latest and best work of all schools of psychological inquiry. But of equal importance, and what will be prized as a new and most desirable feature of a work on mental science, are the educational applications that are made throughout in separate text and type, so that, with the explication of mental phenomena, there comes at once the application to the art of education."

Crown 8vo. Price, \$3.00.

Teacher's Hand-Book of Psychology.

On the Basis of "Outlines of Psychology." By JAMES SULLY, M. A.

A practical exposition of the elements of Mental Science, with special applications to the Art of Teaching, designed for the use of Schools, Teachers, Reading Circles, and Students generally. This book is not a mere abridgment of the author's "Outlines," but has been mainly rewritten for a more direct educational purpose, and is essentially a new work. It has been heretofore announced as "Elements of Psychology."

NOTE.—No American abridgments or editions of Mr. Sully's works are authorized except those published by the undersigned.

12mo, 414 pages. Price, \$1.50.

D. APPLETON & CO., PUBLISHERS,
New York, Boston, Chicago, Atlanta, San Francisco.

13





LB
3241
M8

THE LIBRARY
UNIVERSITY OF CALIFORNIA
Santa Barbara

THIS BOOK IS DUE ON THE LAST DATE
STAMPED BELOW.

Prins vs

UC SOUTHERN REGIONAL LIBRARY FACILITY



A 000 907 231 5

