



Calhoun: The NPS Institutional Archive
DSpace Repository

Theses and Dissertations

1. Thesis and Dissertation Collection, all items

2017-09

Improved Airfield Damage Assessment System (IADAS) capstone

Baker, Jennifer; Chinoski, David; Haka, George; Masco, John; Patchet, Edwin; Squire, Cynthia

Monterey, California: Naval Postgraduate School

<http://hdl.handle.net/10945/56173>

Downloaded from NPS Archive: Calhoun



Calhoun is a project of the Dudley Knox Library at NPS, furthering the precepts and goals of open government and government transparency. All information contained herein has been approved for release by the NPS Public Affairs Officer.

Dudley Knox Library / Naval Postgraduate School
411 Dyer Road / 1 University Circle
Monterey, California USA 93943

<http://www.nps.edu/library>



**NAVAL
POSTGRADUATE
SCHOOL**

MONTEREY, CALIFORNIA

**SYSTEMS ENGINEERING
CAPSTONE PROJECT REPORT**

**IMPROVED AIRFIELD DAMAGE ASSESSMENT
SYSTEM (IADAS) CAPSTONE**

by

Jennifer Baker, David Chinoski, George Haka, John Masco,
Edwin Patchet, and Cynthia Squire

September 2017

Project Advisors:

Paul Shebalin
Joseph W. Sweeney III

Approved for public release. Distribution is unlimited.

THIS PAGE INTENTIONALLY LEFT BLANK

REPORT DOCUMENTATION PAGE			<i>Form Approved OMB No. 0704-0188</i>	
Public reporting burden for this collection of information is estimated to average 1 hour per response, including the time for reviewing instruction, searching existing data sources, gathering and maintaining the data needed, and completing and reviewing the collection of information. Send comments regarding this burden estimate or any other aspect of this collection of information, including suggestions for reducing this burden, to Washington headquarters Services, Directorate for Information Operations and Reports, 1215 Jefferson Davis Highway, Suite 1204, Arlington, VA 22202-4302, and to the Office of Management and Budget, Paperwork Reduction Project (0704-0188) Washington, DC 20503.				
1. AGENCY USE ONLY	2. REPORT DATE September 2017	3. REPORT TYPE AND DATES COVERED Capstone project report		
4. TITLE AND SUBTITLE IMPROVED AIRFIELD DAMAGE ASSESSMENT SYSTEM (IADAS) CAPSTONE			5. FUNDING NUMBERS	
6. AUTHOR(S) Jennifer Baker, David Chinoski, George Haka, John Masco, Edwin Patchet, and Cynthia Squire				
7. PERFORMING ORGANIZATION NAME(S) AND ADDRESS(ES) Naval Postgraduate School Monterey, CA 93943-5000			8. PERFORMING ORGANIZATION REPORT NUMBER	
9. SPONSORING /MONITORING AGENCY NAME(S) AND ADDRESS(ES) N/A			10. SPONSORING / MONITORING AGENCY REPORT NUMBER	
11. SUPPLEMENTARY NOTES The views expressed in this thesis are those of the author and do not reflect the official policy or position of the Department of Defense or the U.S. Government. IRB number: 2017.0042-DD-N.				
12a. DISTRIBUTION / AVAILABILITY STATEMENT Approved for public release. Distribution is unlimited.			12b. DISTRIBUTION CODE	
13. ABSTRACT (maximum 200 words) Timeliness is paramount when restoring partial airfield capability after an airfield has been damaged. The project's focus was to develop conceptual system alternatives for improving the timeliness of airfield damage assessment. The systems engineering methods used included a morphological box and Pugh matrix for determining physical components and Constructive Systems Engineering Cost Model for cost analysis. Two separate improved airfield damage assessment system solutions were designed, evaluated, and compared regarding their cost and performance. Equipment and standard operating procedures selected were based on the design reference mission (DRM) and the limited time to complete the study. The first system used a remotely piloted aircraft (RPA) paired with a day camera. The second system used a set of fixed-tower emplacements, each with a day camera. Models were created and simulations were executed against the DRM to demonstrate the performance for each alternative. After reviewing the cost and simulation data, the RPA alternative showed superior performance. The modular design could be used with other airfield configurations. The RPA alternative cost more than the fixed-tower alternative. Further research is recommended in order to determine the cost and performance improvements that might result from different equipment configurations and improved camera technology.				
14. SUBJECT TERMS improved airfield damage assessment, airfield damage assessment, remotely piloted aircraft			15. NUMBER OF PAGES 183	
			16. PRICE CODE	
17. SECURITY CLASSIFICATION OF REPORT Unclassified	18. SECURITY CLASSIFICATION OF THIS PAGE Unclassified	19. SECURITY CLASSIFICATION OF ABSTRACT Unclassified	20. LIMITATION OF ABSTRACT UU	

THIS PAGE INTENTIONALLY LEFT BLANK

Approved for public release. Distribution is unlimited.

**IMPROVED AIRFIELD DAMAGE ASSESSMENT SYSTEM (IADAS)
CAPSTONE**

Jennifer Baker
John Masco

David Chinoski
Edwin Patchet

George Haka
Cynthia Squire

Submitted in partial fulfillment of
the requirements for the degrees of

MASTER OF SCIENCE IN SYSTEMS ENGINEERING

and

MASTER OF SCIENCE IN ENGINEERING SYSTEMS

from the

**NAVAL POSTGRADUATE SCHOOL
September 2017**

Lead editor: Cynthia Squire

Reviewed by:

Dr. Paul Shebalin
Project Advisor

Joseph W. Sweeney III
Project Advisor

Accepted by:

Dr. Ronald Giachetti
Chair, Systems Engineering Department

THIS PAGE INTENTIONALLY LEFT BLANK

ABSTRACT

Timeliness is paramount when restoring partial airfield capability after an airfield has been damaged. The project's focus was to develop conceptual system alternatives for improving the timeliness of airfield damage assessment. The systems engineering methods used included a morphological box and Pugh matrix for determining physical components and Constructive Systems Engineering Cost Model for cost analysis.

Two separate improved airfield damage assessment system solutions were designed, evaluated, and compared regarding their cost and performance. Equipment and standard operating procedures selected were based on the design reference mission (DRM) and the limited time to complete the study. The first system used a remotely piloted aircraft (RPA) paired with a day camera. The second system used a set of fixed-tower emplacements, each with a day camera. Models were created and simulations were executed against the DRM to demonstrate the performance for each alternative. After reviewing the cost and simulation data, the RPA alternative showed superior performance. The modular design could be used with other airfield configurations. The RPA alternative cost more than the fixed-tower alternative. Further research is recommended in order to determine the cost and performance improvements that might result from different equipment configurations and improved camera technology.

THIS PAGE INTENTIONALLY LEFT BLANK

TABLE OF CONTENTS

I.	INTRODUCTION.....	1
A.	BACKGROUND	1
B.	PROBLEM STATEMENT	8
C.	BENEFIT OF STUDY	8
D.	PROJECT SCOPE.....	9
1.	IN SCOPE.....	9
2.	OUT OF SCOPE.....	10
E.	PROJECT OBJECTIVES.....	10
F.	STAKEHOLDER IDENTIFICATION AND ANALYSIS.....	11
1.	EOC.....	11
2.	AFCEC and READINESS DIRECTORATE.....	11
3.	RED HORSE	12
4.	NAVY SEABEES	12
II.	PROJECT APPROACH	15
A.	INTRODUCTION.....	15
B.	REQUIREMENTS ANALYSIS METHODOLOGY	19
C.	FUNCTIONAL ANALYSIS METHODOLOGY	19
D.	PHYSICAL ARCHITECTURE METHODOLOGY	20
E.	ANALYSIS OF ALTERNATIVES METHODOLOGY	20
F.	MODELING METHODOLOGY	20
1.	Cost Modeling Methodology	20
2.	Effectiveness Modeling Methodology.....	21
G.	DESIGN REFERENCE MISSION	23
III.	SYSTEMS DESCRIPTIONS.....	29
A.	INTRODUCTION.....	29
B.	REQUIREMENTS ANALYSIS	29
C.	CURRENT ADAS SYSTEM AND FUTURE IADAS CONCEPTS.....	37
D.	SYSTEMS DESCRIPTION SUMMARY.....	44
1.	Current ADAS.....	44
2.	IADAS I.....	51
3.	IADAS II.....	58
IV.	SYSTEMS EVALUATION.....	67
A.	INTRODUCTION.....	67

B.	CURRENT ADAS.....	68
1.	ExtendSim Model Analysis	68
2.	Cost Analysis	74
C.	IADAS I.....	75
1.	ExtendSim Model Analysis	75
2.	Cost Analysis	83
D.	IADAS II.....	88
1.	ExtendSim Model Analysis	88
2.	Cost Analysis	94
V.	CONCLUSIONS AND RECOMMENDATIONS.....	101
A.	PROJECT SUMMARY.....	101
B.	PROJECT CONCLUSIONS.....	104
C.	RECOMMENDATIONS FOR FUTURE STUDIES.....	105
	APPENDIX A. PROGRAMS AND TOOLS	107
A.	EXTENDSIM	107
B.	INNOSLATE.....	107
C.	COSYSMO/COCOMO II	108
	APPENDIX B. INSTITUTIONAL REVIEW BOARD QUESTIONS	111
	APPENDIX C. ADDITIONAL DATA.....	127
	LIST OF REFERENCES.....	153
	INITIAL DISTRIBUTION LIST	157

LIST OF FIGURES

Figure 1.	Scope of Project	10
Figure 2.	DOD Acquisition Life Cycle. Source: Defense Acquisition University (2017).....	15
Figure 3.	Systems Engineering Process. Source: Defense Acquisition University (2001).....	17
Figure 4.	Effectiveness Assessment Methodology. Source: Air Force Material Command (2010).	22
Figure 5.	Effectiveness Analysis Methodology. Source: Air Force Material Command (2010).	23
Figure 6.	DRM. Adapted from Aircraft Owners and Pilots Association (2017).....	28
Figure 7.	IADAS DFD	30
Figure 8.	ADAS Mission Functional Architecture Hierarchy Chart (First Three Levels).....	45
Figure 9.	Assess Airfield Damage Decomposed.....	45
Figure 10.	Assess UXO on Airfield Decomposed	45
Figure 11.	Current ADAS EFFBD	46
Figure 12.	Current ADAS IDEF0 Diagram.....	47
Figure 13.	Current ADAS Sequence Diagram	48
Figure 14.	Current ADAS Class Diagram.....	49
Figure 15.	Current ADAS CONOPS.....	51
Figure 16.	IADAS I Mission Functional Architecture Hierarchy Chart	52
Figure 17.	IADAS I EFFBD.....	53
Figure 18.	IADAS I IDEF0 Diagram	54
Figure 19.	IADAS I Sequence Diagram.....	55
Figure 20.	IADAS I Class Diagram	55
Figure 21.	IADAS I CONOPS	58

Figure 22.	IADAS II Mission Functional Architecture Hierarchy Chart.....	59
Figure 23.	IADAS II EFFBD	60
Figure 24.	IADAS II IDEF0 Diagram.....	61
Figure 25.	IADAS II Sequence Diagram	62
Figure 26.	IADAS II Class Diagram	63
Figure 27.	IADAS II CONOPS.....	66
Figure 28.	Current ADAS ExtendSim Model	69
Figure 29.	ADAT Travel Route. Adapted from Aircraft Owners and Pilots Association (2017).....	70
Figure 31.	IADAS I ExtendSim Model.....	76
Figure 32.	IADAS I Sequence of Events. Adapted from Aircraft Owners and Pilots Association (2017).....	78
Figure 33.	IADAS I Cost Modeling Summary.....	85
Figure 34.	IADAS II ExtendSim Model	89
Figure 35.	IADAS Option II Cost Modeling Summary	96
Figure C-1.	Russian RBK-500 BetAB Cluster Bomb. Sources: Jane’s Air Launched Weapons (2007) and Flankers Site (2017).....	127
Figure C-2.	Russian RBK-500RTM AO Cluster Bomb. Sources: International Campaign to Ban Landmines (2012) and The Fighter Collection & Eagle Dynamics (2013).....	128
Figure C-3.	Russian FAB-500T. Source: Global Security.org (2016).....	129
Figure C-4.	ADAS ExtendSim Model	136
Figure C-5.	ADAS Simulation Inputs	137
Figure C-6.	ADAS Simulation Outputs (Last Run Only)	138
Figure C-7.	IADAS I ExtendSim Model.....	139
Figure C-8.	IADAS I Simulation Inputs	140
Figure C-9.	IADAS I Simulation Outputs (Last Run Only).....	141
Figure C-10.	IADAS I Systems Engineering Costs, Page 1	142

Figure C-11. IADAS I Systems Engineering Costs, Page 2	143
Figure C-12. IADAS I Software Engineering Cost, Page 1	144
Figure C-13. IADAS I Software Engineering Cost, Page 2.....	145
Figure C-14. IADAS II ExtendSim Model	146
Figure C-15. IADAS II Simulation Inputs	147
Figure C-16. IADAS II Simulation Outputs (Last Run Only)	148
Figure C-17. IADAS II Systems Engineering Cost	149
Figure C-18. IADAS II Software Engineering Costs, Page 1	150
Figure C-19. IADAS II Software Engineering Costs, Page 2.....	151

THIS PAGE INTENTIONALLY LEFT BLANK

LIST OF TABLES

Table 1.	ADR Damage Descriptions.....	6
Table 2.	IADAS Project Approach, Key Strategies, Constraints, and Assumptions.....	18
Table 3.	DRM Weapon Information	25
Table 4.	Detailed Attack Information	27
Table 5.	Stakeholder Needs	29
Table 6.	Requirements Analysis Results.....	31
Table 7.	Functional Requirements Traceability Matrix	34
Table 8.	Non-functional Requirements.....	35
Table 9.	IADAS MOEs.....	36
Table 10.	Current ADAS System Components	37
Table 11.	The Future IADAS System Components.....	38
Table 12.	Final List of Options for Pugh Matrix Analysis	38
Table 13.	Pugh Matrix Analysis	41
Table 14.	Pugh Matrix Results.....	43
Table 15.	IADAS I Physical Architecture	56
Table 16.	IADAS II Physical Architecture	63
Table 17.	Model Inputs: DRM Damage and UXO Types and Quantities	70
Table 18.	Model Inputs: Damage and UXO Detection and Measurement	71
Table 19.	Model Inputs: Staging Time, Assessment/Travel Speed, and Reporting Times.....	72
Table 20.	Current ADAS Effectiveness/Performance Measures and Metrics	72
Table 21.	Current ADAS Effectiveness/Performance Measures	74
Table 22.	ADAS Cost Estimate	75

Table 23.	IADAS I Model Inputs: DRM Damage and UXO Types and Quantities	78
Table 24.	IADAS I Model Inputs: RPA Camera Specifications.....	79
Table 25.	IADAS I Model Inputs: RPA Imagery Collection.....	79
Table 26.	IADAS I Model Inputs: Activity/Parameters	80
Table 27.	IADAS I Model Inputs: Automated and Manual Detection Probabilities	81
Table 28.	IADAS I Simulation Outputs.....	82
Table 29.	IADAS I Simulation Output Results.....	83
Table 30.	IADAS I COSYSMO SE Inputs/Assumptions	84
Table 31.	IADAS I O&S Costs.....	86
Table 32.	IADAS I Cost Estimate.....	88
Table 33.	IADAS II Model Inputs: DRM Damage and UXO Types and Quantities	90
Table 34.	IADAS II Model Inputs: Activity/Parameters	91
Table 35.	IADAS II Model Inputs: Automated and Manual Detection Probabilities	92
Table 36.	IADAS II Simulation Outputs	93
Table 37.	IADAS II Simulation Output Results	94
Table 38.	IADAS II COSYSMO SE Inputs/Assumptions.....	95
Table 39.	IADAS II O&S Costs.....	97
Table 40.	IADAS II Cost Estimate	99
Table 41.	Comparison of Results of Cost Modeling and Simulation Runs	102
Table 42.	IADAS Alternative Assessment	103
Table C-1.	DRM RBK-500 BetAB (1) Pattern.....	130
Table C-2.	DRM RBK-500 BetAB (2) Pattern.....	131
Table C-3.	DRM RBK-500 AO-2.5.RT.....	132

LIST OF ACRONYMS AND ABBREVIATIONS

AB	airbase
ADA	airfield damage assessment
ADAS	airfield damage assessment system
ADAT	airfield damage assessment team
ADR	airfield damage repair
AFCEC	Air Force Civil Engineer Center
AoA	analysis of alternatives
CBU	cluster bomb unit
CCDR	combatant commanders
COCOMO II	Constructive Cost Model II
CONOPS	concept of operations
COSYSMO	Constructive Systems Engineering Cost Model
CPU	central processing unit
CSBA	Center for Strategic and Budgetary Assessments
CXD	Explosive Ordnance Disposal Division
DA	damage assessed
DDL	digital data link
DFD	data flow diagram
DOD	U.S. Department of Defense
DoDAF	Department of Defense Architecture Framework
DRM	design reference mission
EA	effectiveness assessment
EOC	emergency operations center
ESLOC	equivalent source lines of code
GAO	Government Accounting Office
GeoExPT	Geospatial Expeditionary Planning Tool
HD	high definition
HMMWV	high mobility multipurpose wheeled vehicle
HP	Hewlett Packard
HSI	human systems integration

IADAS	improved airfield damage assessment system
IDEF0	integrated computer aided manufacturing definition for function modeling
IEEE	Institute of Electrical and Electronics Engineers
INCOSE	International Council on Systems Engineering
IP	internet protocol
INL	Idaho National Laboratory
LiDAR	light detection and ranging
M&S	modeling and simulation
MAOS	minimum airfield operating surface
MBSE	model-based systems engineering
MGRS	military grid reference system
MOE	measure of effectiveness
MOP	measure of performance
MOPP	mission oriented protective posture
MOS	measure of suitability
NBC	nuclear, biological, and chemical
NPS	Naval Postgraduate School
O&S	operations and support
R&D	research and development
RADAR	radio detection and ranging
RADAS	rapid airfield damage assessment system
RED HORSE	rapid engineer deployable heavy operational repair squadron engineer
RPA	remotely piloted aircraft
SE	systems engineering
SLOC	source lines of code
SysML	systems modeling language
TPM	technical performance measures
TTP	tactics, techniques, and procedures
UA	UXO assessed
UAV	unmanned aerial vehicle

UGV	unmanned ground vehicle
USAF	United States Air Force
UXO	unexploded ordnance
WBS	work breakdown structure

THIS PAGE INTENTIONALLY LEFT BLANK

EXECUTIVE SUMMARY

The United States Air Force Emergency Operations Center (EOC) has the responsibility to assess the extent of airfield damage after an airfield has been damaged. The Airfield Damage Assessment (ADA) process must be accurate and timely in measuring airfield damage. Based upon past airfield damage repair (ADR) experience, the assessment phase can be quite time-consuming and dangerous. The damage assessment is conducted in two phases: initial reconnaissance and detailed damage assessment. The initial reconnaissance provides enough information to allow the EOC to send ADA teams to parts of the airfield that need a more detailed assessment. The detailed damage assessment provides detailed reporting of airfield runway damage and identification of unexploded ordnance (UXO). The completion time is highly variable based on the quantity and types of UXOs and the extent of runway damage.

The problem is that the current ADA process, when UXO is present, takes significantly longer than is required to support timely ADR. The Department of Defense is looking for a solution that will provide accurate location information for damage and UXOs, which reduces the time to complete the ADA mission, along with complete coverage of the damaged area to be assessed, within the specified timeframe of 45 minutes.

There are currently no fielded autonomous systems capable of performing the role of ADA. The benefit of this project was to provide the stakeholders with sufficient information to understand the benefits and costs associated with the original process and two alternative systems. A systems engineering (SE) analysis has been performed comparing the current process to the potential autonomous system solutions being researched.

An analysis of alternatives was documented, focusing on two alternative systems that have the potential to meet the criteria to perform ADA. Because the purpose of this project was to focus on the ADA, the Design Reference Mission (DRM) was defined to begin after an enemy attack on a U.S. airfield.

The scope of this project was to focus solely on the airfield damage assessment activity. The scope of the problem being researched includes the activities that begin after the airfield attack and initial reconnaissance for damage and ended once the damage assessment results were communicated to the EOC.

This alternative assessment is provided for the stakeholders to have a high-level view of the performance differences between the three systems performing ADA activities. The merits of each system can be evaluated against each other and the metrics used to determine “success” against a known DRM. In order to make as complete a comparison as possible, focus was placed on the development costs (software, SE, and 10-year maintenance), and instantiation costs (hardware, installation, and 10-year maintenance), which could be readily accessed in the timeframe for this report.

For this project, the system requirements were refined based on stakeholder needs. The stakeholder needs for the new improved airfield damage assessment system (IADAS) were identified based on user representatives, the problem statement, literature research, and stakeholder analysis. A functional architecture was generated for the current airfield damage assessment system (ADAS), IADAS I, and IADAS II. This top-down decomposition showed the functions that were performed for a notional ADA mission.

The process of determining the potential alternatives for the IADAS system included determining the components used in the current ADAS system, and those potential components that could be leveraged for the IADAS system. The SE tools used to analyze the necessary ADAS mission components were the morphological box and the Pugh matrix SE concepts. Based on the analysis of alternatives results, the IADAS I system analyzed in the project was a remote piloted aircraft (RPA) with a day camera and wireless sensors. The IADAS II system analyzed was a network of stationary towers each with a day camera and wireless sensor.

The functional analysis of these alternatives included the creation of multiple types of diagrams to be used as tools to fully understand the functional capabilities of the system. This analysis included the use of the functional architecture hierarchy chart,

functional block diagram, Integrated Computer Aided Manufacturing Definition for Function Modeling (IDEF0) diagrams, sequence diagrams, class diagrams, and concept of operations diagram.

In order to best determine a viable alternative, the decomposed architectures were implemented into modeling and simulation tools. Imagine That Inc. ExtendSim software was used to conduct this analysis. By developing the alternatives into models, the processes were able to be simulated and repeated in order to provide measurement data for analysis and evaluation. The models were run 500 times for statistical significance and to also model system variability. The model was built to allow for the input of six different types of damage and three types of UXO. The probability of detection, classification time, and measurement time for each damage and UXO type were estimated based on input from subject-matter experts and engineering judgment.

Several measures were derived from the simulation model to evaluate the effectiveness of the alternatives. The selected measures used throughout the simulation and analysis are *percent airfield damage assessed, percent UXO assessed, airfield damage assessment time, travel/detection time, classification time, and communication time*.

Finally, the life-cycle cost components for each IADAS alternative were as follows: research and development, SE, personnel, and operations and support costs (hardware, training, and 10-year maintenance). The SE cost was determined using Constructive Systems Engineering Cost Model (COSYSMO). The total life-cycle costs were estimated to be:

ADAS	\$1782K
IADAS I	\$2944K
IADAS II	\$1436K

By comparing the system alternatives to the measures of effectiveness associated with this project, IADAS I was the recommended solution for the stakeholders. The IADAS I system met, or exceeded, the threshold values for both assessing the percent of

damage and UXO mission parameters. In addition, the IADAS I system significantly reduced the ADA timeline. The overall capability of the system delivers significantly reduced ADA time as compared to the original ADAS. For the DRM scenario studied in this project, the current ADAT time was estimated at 174 minutes. The IADAS I completed the simulation in just 52 minutes. The implementation cost for IADAS I was higher than the IADAS II alternative; however, the IADAS I system conducted the mission in a more efficient and cost-effective manner. The IADAS I has a significantly smaller footprint on the airfield of interest. This would include a small hardened storage container for the RPA and spares, along with the ground control station. Additionally, IADAS I has an added feature of being easily moved from one airfield to another as required. The IADAS II has a more significant logistics impact on the infrastructure of the airfield, having towers placed at fixed intervals along the area of interest, as defined in the DRM.

Considering the multitude of options available for outfitting an IADAS, the project focused on defined alternatives due to the limited timeframe available. The DRM allows for many alternative solutions including a variety of RPA options, tower elements, cameras, and sensors. Future systems under consideration can take advantage of these options as well as upgraded benchmarks for key system elements such as image quality, computer processing speed, and networked communications. As noted in the computations for IADAS I and IADAS II, communications and processing were significant contributors to the time spent on the overall mission.

ACKNOWLEDGMENTS

The team would like to thank its advisors, Dr. Paul Shebalin and Professor Joseph Sweeney, for their continuous support, guidance and insight throughout this capstone project. The team would also like to thank the following:

- Dr. John Olive, Air Force Civil Engineer Center (AFCEC)/Explosive Ordnance Disposal Division (CXD), for his participation and feedback. We also thank Dr. Olive for supporting In-Process Reviews (IPR) #1.
- MAJ Allen G. Branco III, executive officer to the Director of Civil Engineers, Deputy Chief of Staff for Logistics, Engineering and Force Protection, Headquarters, U.S. Air Force, Washington, D.C., formerly the combined joint engineer of the North Atlantic Treaty Organization Air Command–Afghanistan and the chief of engineering for the 9th Air and Space Expeditionary Task Force-Afghanistan in Kabul. Thanks for his participation and feedback. We also thank MAJ Branco for supporting IPR #2.
- Mr. Lance Filler, Airfield Damage Repair program manager, for his participation, feedback, and programmatic slides.

Finally, to the families of the team: Our deepest gratitude and heartfelt thanks for their love, patience, and support throughout the entire process.

THIS PAGE INTENTIONALLY LEFT BLANK

I. INTRODUCTION

The Department of Defense (DOD) operates in a multitude of environments, including homeland security, training, peace-keeping, and combat. In all of these environments, especially in combat, United States Armed Forces must be able to conduct aircraft operations on a variety of airfield types and locations. Anytime an airfield is damaged through natural disasters, accidents, or hostile means, the ability to launch and recover aircraft sorties is diminished. In order to restore full airfield capability, a series of steps must be taken. One of the first steps is to complete an airfield damage assessment (ADA).

A. BACKGROUND

According to the document, *Airfield Damage Assessment after Attack Tactics, Techniques, and Procedures (TTP)* (Department of the Air Force 2016), “Airfield damage assessment is the process of locating, classifying, and measuring airfield damage and unexploded ordnance (UXO) after an attack.” The current process is very personnel-intensive with little automation.

The United States Air Force (USAF) Emergency Operations Center (EOC) has the responsibility to assess the extent of airfield damage after an airfield has been damaged. At least three minimum airfield operating surface (MAOS) candidates are selected to be briefed to the Installation Commander as soon as possible after the attack (Department of the Air Force 2016). To help meet that operational requirement, the airfield damage assessment (ADA) process must be accurate and timely in measuring airfield damage. Based upon past airfield damage repair (ADR) experience, the assessment phase can be quite time consuming and dangerous. The damage assessment is conducted in two phases: initial reconnaissance and detailed damage assessment. The initial reconnaissance rapidly assesses damage to broad areas of the airfield pavement from a distance and is done fairly quickly (estimated 10 to 20 minutes), but does not provide a detailed damage estimate as observations are done at a long distance from the damaged airfield areas. The initial reconnaissance provides enough information to allow

the EOC to send airfield damage assessment teams (ADAT) to parts of the airfield that need a more detailed assessment (Department of the Air Force 2016). The detailed damage assessment provides detailed reporting of airfield runway damage and identification of UXO. The completion time is highly variable based on the quantity and types of UXOs and the extent of runway damage.

According to the *AFPAM 10-219, Contingency and Disaster Planning* (Department of the Air Force 2008), managing airfield damage consists of:

1. Pre-positioning of Assets
2. Reporting of Airfield Damage Event
3. Initiating an ADA
4. Determining the MAOS
5. Performing Rapid Runway Repair

The preparation step (#1, in the list provided above), especially in an expeditionary (hostile) environment, usually occurs well ahead of any engagement by an enemy. Resources, such as personnel, heavy equipment, and repair materials are brought to strategic airfields in preparation for being able to respond to any situation, which could interrupt the mission of the airbase. Depending on the characteristics of the airbase (number of runways, supported aircraft, and criticality of the missions being supported), this may involve a considerable amount of resources.

The first step in the actual scenario (#2, in the list provided above) occurs when an event creates some type of damage hazard to the airfield, or surrounding infrastructure, necessary to flight operations. This may include bombing runs from enemy aircraft, sabotage from insurgent forces, accidents/crashes by friendly aircraft, or damage from natural disasters, which could hinder the mission of the airfield.

This triggers the next step (#3, in the list provided above) in the scenario, which is assessing the airfield damage. The airfield damage assessment teams are typically comprised of five to seven individuals and are sent out to gather the information

necessary to determine the quantity and location of damage and UXOs within the boundaries of the airfield (Mallerski 2009). The number of ADATs required for an operation is based on a number of factors such as “the number of runways and airfield operating surfaces that need to be maintained” (Department of the Navy 2001). Those teams first have to wait for the all-clear to be given, which is normally provided at the end of the air raid, or conclusion of the storm. Either event would trigger a need for an assessment of damage. The ADATs, using armored vehicles or on foot, travel predetermined routes and inspect for potential damage to various airfield infrastructures, runways, taxiways, and apron surfaces. The ADATs are usually comprised of a team leader, two explosive ordnance disposal technicians, one radio operator/driver, one spall damage assessor, and two crater damage assessors (Department of the Navy 2001). See [Table 1](#) for damage definitions. The ADATs then perform their role of mapping the damage sites (size and location) and UXO locations. Currently, all of the steps within the detailed assessment portion are performed manually. The team gets into position, performs their operations, and relays the information to the EOC.

The information from the ADATs is transferred to the MAOS Selection Cell (#4, in the list provided above). This current process is dangerous to personnel as UXO or time delayed munitions may be present on the routes they travel. Additionally, this process takes up valuable time and could easily lead to miscommunication. The MAOS Selection Cell’s purpose is to calculate the minimum airfield, which could sustain operations, or determine the minimum amount of repair work, which could bring about the minimum airfield necessary. The MAOS Selection Cell manually enters the reported damage into the Geospatial Expeditionary Planning Tool (GeoExPT) system (a U.S. Government off-the shelf product). According to *GeoExPT’s website*, GeoExPT “is a decision support tool for mission planners and engineers to ... analyze and repair airfield damage for optimal selection” of the MAOS (Dynamic Software Solutions 2017). The MAOS Selection Cell then selects different MAOS options in order to bring the airfield back into operation. According to *Air Force Tactics, Techniques, and Procedures 3–23.11*, “the MAOS Selection Team briefs the MAOS candidates by order of preference to the Installation Commander or Senior Airfield Authority who then selects the preferred

MAOS that must be cleared and repaired to launch and recover aircraft” (Department of the Air Force 2016). The MAOS is a section of the airfield that can be operated in isolation from the rest, making it a priority for repairs. The time required to complete the ADA is heavily dependent on the amount of damage and number of teams available to survey the required areas.

The final step (#5, in the list provided above) in the process is the actual repair of the runway and removal of the UXO, if present. Personnel would draw upon the pre-positioned equipment and material to go about the work to re-establish flight operations following the activity, which impeded them in the first place. Any damage not listed in Table 1 is not within the scope of this project.



Performing ADA is fundamental to resuming activities. As such, “speed and accuracy during damage assessment are essential for the success of subsequent rapid airfield damage repair activities.” (Department of the Air Force 2016). The USAF has an “ongoing project,” named Rapid Airfield Damage Assessment System (RADAS), to perform the damage assessment using remote sensing techniques in order to accomplish the task quicker and in a safer environment (Earth Imaging Journal 2015). A mixture of ground mobile systems, fixed-installation systems (tower-based), and unmanned aircraft systems technology has been examined. Listed below are some of the technologies that have been explored to date.

1. “Idaho National Laboratory (INL) developed an unmanned aerial vehicle (UAV) based system, RADAS, for rapid airfield damage assessment. These operations are usually conducted by two, three-man teams navigating the field in vehicles and require between 60 to 90 minutes to complete” (Satnews Daily 2009). NOTE: According to the USAF, the terminology used for a UAV is a remotely piloted aircraft (RPA). Depending on the source of the information, this terminology may be used interchangeably.
2. iFerret and Super Bullseye systems designed by Stratech Systems Limited were also being integrated into RADAS. The Super Bullseye sensors were placed in fixed positions to detect weapon impact times and locations and the

iFerret sensors can scan the runway to assess damage in real time (Echerri 2015).



3. The U.S. Army is investigating methods for airfield assessments. The U.S. Army's Common Robotic System – Individual program is “to provide dismounted troops with the ability to conduct lower-level reconnaissance, surveillance, and target acquisition; and to remotely perform chemical, biological, radiological and nuclear detection” (Tomkins 2016). Additional features such as remote UXO disposal and counter measure operations were also considered (Tomkins 2016).
4. Hydra Fusion Tools by Lockheed Martin CDL Systems is developing a near real-time software solution to generate a three dimensional model from data collected on Lockheed Martin's Indago quadcopter using the Snap Dragon 12 megapixel camera. This product can be deployed using laptop systems. (Chandler 2016) The concept is to deliver accurate images of the damage to decrease potential personnel damage as well as decrease response time.

Table 1. ADR Damage Descriptions

Type of Damage	Description	Graphical Description
Craters	<p>“Left when an object punctures the bottom surface of the pavement and aggregate is exposed. They can be as small as three feet and as large as 50 feet” (Earth Imaging Journal 2015).</p>	 <p>Source: (Filler 2014)</p>
Spall	<p>“Similar to a crater, but it does not puncture the bottom surface of the pavement” (Earth Imaging Journal 2015).</p>	 <p>Source: (Filler 2014)</p>

Continued on next page.

Table 1. Continued from previous page.

Type of Damage	Description	Graphical Description
Camouflet	<p>“Munition penetrates the pavement and explodes under the surface to create a cavity. These are difficult to find and a dangerous hazard as aircraft weight can collapse these unseen holes” (Earth Imaging Journal 2015).</p>	 <p>Source: (Filler 2014)</p>
UXO	<p>“The main challenge is to determine the classification (e.g., bomb, missile, or rocket), but sensors need to be able to determine the fuse type to assess the threat as well as the mitigation strategy” (Earth Imaging Journal 2015).</p>	 <p>Source: (Filler 2014)</p>

According to an article in the *Earth Imaging Journal*, the RADAS Government Program Lead, USAF, stated that the goal was to accomplish the damage assessment within 30 minutes with a “24/7 capability that can be used in all weather and in a variety of conditions” (Earth Imaging Journal 2015). Air Force engineers have looked at these imaging sensors in support of RADAS:

- video
- electro-optical
- infrared (long wave, medium wave infrared, near infrared, shortwave infrared)
- radio detection and ranging (RADAR) (millimeter wave, Ku, X-Band, synthetic aperture RADAR)
- seismic and acoustic

“An important consideration when choosing sensors for ADR is being able to recognize the different types of airfield damage” (Earth Imaging Journal 2015) as described in Table 1.

To date, technology limitations have posed some issues. “Electro-optical sensors work well in a daytime environment and in all weather conditions, but not at night. Infrared works well at night, but small amounts of weather create large problems. [The] RADAR is another platform that performs well in most environments, but does very poor during rain or bad weather” (Earth Imaging Journal 2015).

B. PROBLEM STATEMENT

The problem is that the current ADA process, when UXO is present, takes significantly longer than is required to support timely airfield damage repair. The DOD is looking for a solution that will provide accurate location information for damage and UXOs, along with complete coverage of the damaged area to be assessed.

C. BENEFIT OF STUDY

There are no fielded autonomous systems capable of performing the role of ADA, although there are several prototype systems that had the potential for performing that

role. The benefits of this project were to provide the necessary stakeholders with sufficient information to understand the benefits and costs associated with two alternative systems. A systems engineering (SE) analysis has been performed comparing the current process to the potential autonomous systems being researched.

An SE analysis of alternatives (AoA) was documented, focusing on two alternative systems that had the potential to meet the criteria to perform ADA. Requirements were documented. Models were built and simulations were run to estimate how effective those systems operate. The quantitative analysis showed the results against the baseline of having personnel perform 100% of the operations.

D. PROJECT SCOPE

1. IN SCOPE

The scope of this project was focused solely on the airfield damage assessment activity (Figure 1). The scope of the problem being research includes the activities that begin after the airfield attack and initial reconnaissance for damage. The scope ended once the damage assessment results were communicated to the EOC. The ADA activity was in the DOD context. The scope of the analysis was narrowed to certain listed requirements as covered in the design reference mission (DRM).

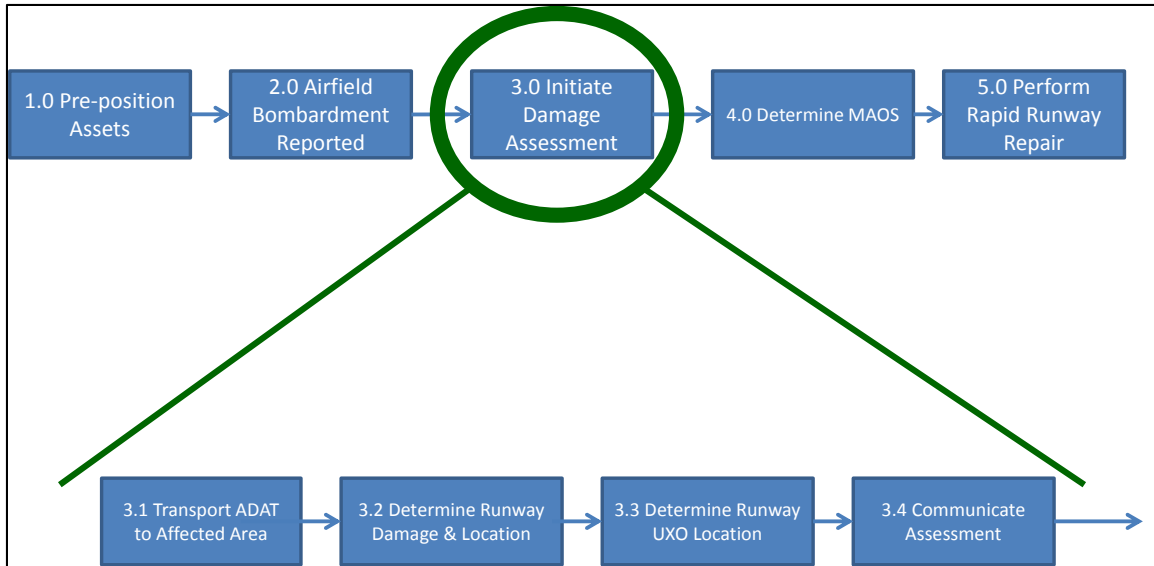

As shown in the figure, there are many steps involved with returning an airfield back to an operational status. The focus of this project was limited to performing the damage assessment.

Figure 1. Scope of Project

The architecture and cost analysis of the current system were described. Two alternative system solutions were selected and their architecture and cost analysis were described. An AoA was performed and the results were documented in this report. In the end, the project stakeholders have both quantitative and qualitative analyses in order to compare each solution against one another.

2. OUT OF SCOPE

The activities related to determining the MAOS and performing runway repair were out of the scope of this project. Any damage not listed in [Table 1](#) was considered debris and therefore, not within the scope of this project. The ADA activity for this report does not cover airfield damage caused by natural disasters.

E. PROJECT OBJECTIVES

The project objectives were to provide:

1. A description of the current baseline ADAS.

2. Descriptions of two new conceptual systems (Improved Airfield Damage Assessment System (IADAS) I and IADAS II).
3. A cost-effectiveness comparison of the baseline ADAS and the two conceptual IADAS systems.
4. A discussion on recommendations about what the next steps should be.

F. STAKEHOLDER IDENTIFICATION AND ANALYSIS

The identified stakeholders are the EOC, the U.S. Air Force Civil Engineer Center (AFCEC) and Readiness Directorate, the U.S. Air Force Rapid Engineer Deployable Heavy Operational Repair Squadron Engineer (RED HORSE), and the U.S. Navy SeaBees.

1. EOC

The EOC is responsible for coordinating the airfield recovery process to include the ADR. In order to develop an airfield recovery plan, the EOC must first collect damage assessments of the take-off and landing surfaces as well as hazards that could impede the recovery process (such as UXOs, and damage to the airbase that could prevent airfield recovery efforts). By providing the EOC accurate near-real time ADA, the EOC will be able to reduce the time between the attack and the creation of the MAOS and allow the ADR teams to be released and begin airfield repair when the base is sent into alarm black/initial release. Alarm black/initial release is the state of an airbase after an attack has been completed. The EOC announces the condition alarm black/initial release when it is time to send the ADAT out to complete their mission.

2. AFCEC and READINESS DIRECTORATE

From the AFCEC/Readiness website (U.S. Air Force Civil Engineer Center 2017), their mission is described below:

The Readiness Directorate, located at Tyndall Air Force Base, Florida, provides readiness and emergency services support and serves as the source for civil engineer research, development and acquisition to the Air Force civil engineer community. Through technical information, guidance and standardized methodology, the directorate enables civil engineers

worldwide to execute their expeditionary combat support and emergency services missions safely, effectively and efficiently. The directorate has five divisions: Explosive Ordnance Disposal; Emergency Management; Fire Emergency Services; Expeditionary Engineering; and Requirements and Acquisition.

The AFCEC is responsible for building the guidance/direction/regulations Air Force Civil Engineers will use in an expeditionary environment such as while repairing and recovering an airbase after an attack. The AFCEC is also responsible for ensuring that the Air Force Civil Engineer career field is prepared for the future of expeditionary warfare by integrating the latest technology into TTPs as well as standard operating procedures.

3. RED HORSE

From AFI 10-209 (Department of the Air Force 2012a), the role of a RED HORSE unit is described as:

[The] RED HORSE [unit] directly supports combat air power worldwide. They provide air component commanders a dedicated, flexible airfield and base heavy construction and repair capability, along with many special capabilities that allow the unified [combatant commanders] CCDRs to move and support missions as the air order of battle dictates.

The RED HORSE unit can rapidly repair a damaged airfield, obtained through various means.

4. NAVY SEABEES

The Navy Seabees are responsible for providing the U.S. Navy with rapid, expeditionary construction to include ADR. “Since its inception during the early days of World War II, Airfield Damage Repair (ADR) has been one of the Seabees’ core competencies” (Pierce 2016). They are required to assess, locate, plot, and repair damage done to an airfield in order to enable the rapid use of airpower in a wartime environment. The Navy Seabees provide a similar capability to the U.S. Navy that the RED HORSE provides to the U.S. Air Force.

The U.S. faces potential threats around the globe in which Seabees may be called upon once again to provide ADR services for our nation’s and for our allies’

expeditionary forces. For this reason there has been a renewed focus on their ADR capabilities (Pierce 2016).

THIS PAGE INTENTIONALLY LEFT BLANK

II. PROJECT APPROACH

A. INTRODUCTION

This chapter outlines the methodology that was utilized when conducting the IADAS concept development. All work during this phase of the project fell within the Material Solution Analysis Phase shown in Figure 2.

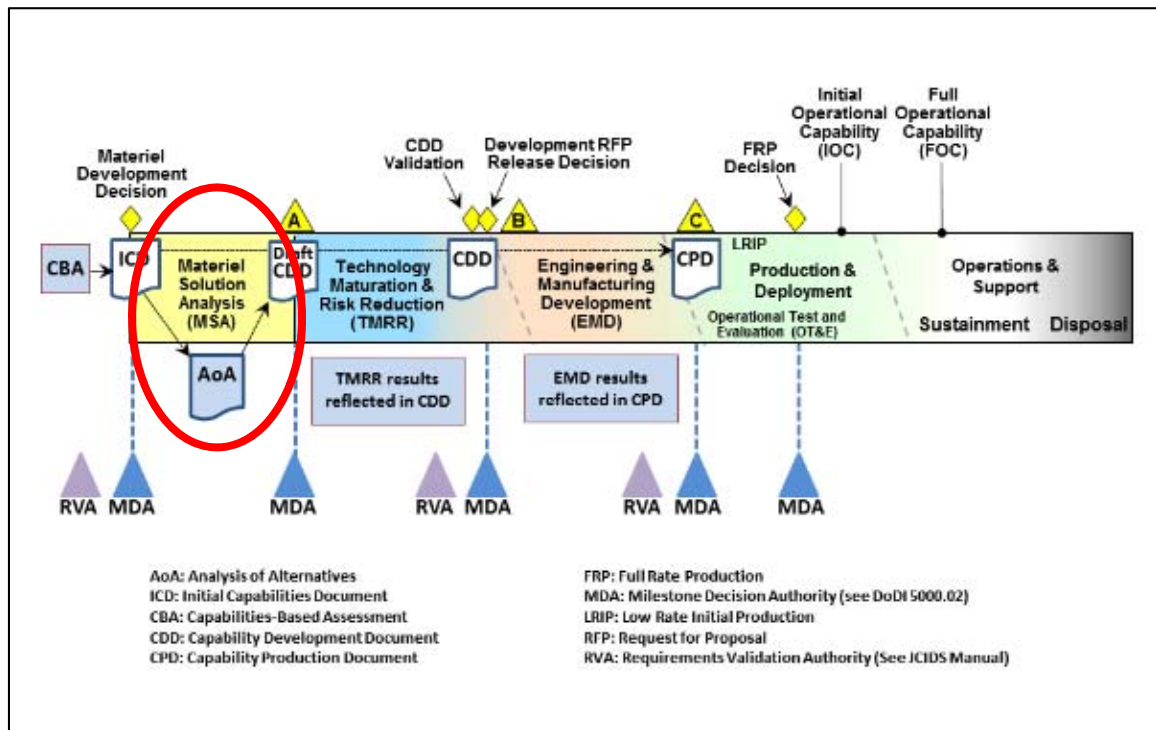

Figure 2. DOD Acquisition Life Cycle. Source: Defense Acquisition University (2017).

The following activities are performed to support the development of alternative system architectures:

1. Requirements Analysis. Stakeholder requirements were adapted into system requirements that characterized the attributes and performance of the IADAS.
2. Functional Analysis. IADAS high level functions identified through requirement analysis were subsequently decomposed.

3. Design (Physical) Synthesis. Physical resources required for all functions identified in the functional architecture were detailed.
4. Alternate IADAS Candidate Architectures. The specific physical resources used for each of the two alternate systems were selected using a morphological box rooted in the functional analysis and physical synthesis.

The SE process shown in Figure 3 was used to support the completion of the requirements analysis, functional analysis, and design synthesis. Upon completion of development of the alternate IADAS systems, an AoA was performed. The AoA was performed based on estimated system cost and performance to provide stakeholders with sufficient information to understand the benefits, risks, and costs associated with each alternative system.

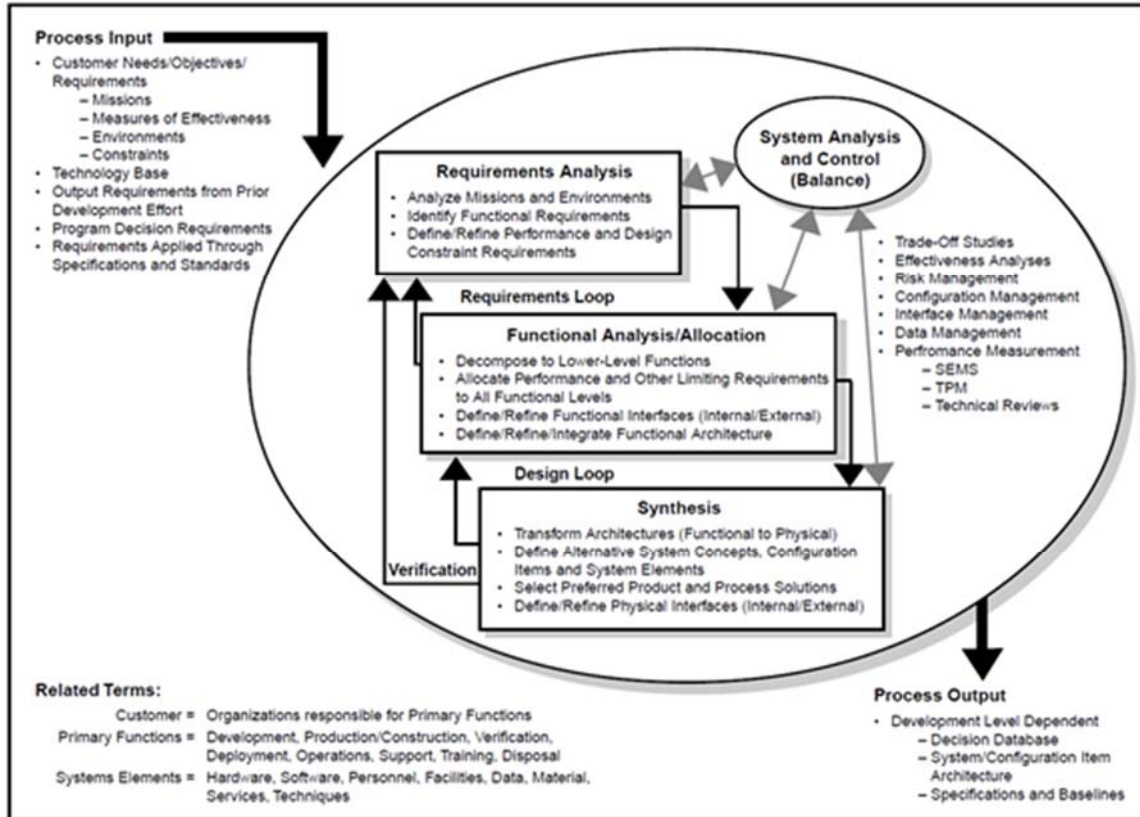

Figure 3. Systems Engineering Process. Source: Defense Acquisition University (2001).

The SE technical approach, key SE strategies, programmatic constraints, and programmatic assumptions are shown in Table 2.

Table 2. IADAS Project Approach, Key Strategies, Constraints, and Assumptions

Approach
<ol style="list-style-type: none"> 1. Documented the extent of the ADA problem 2. Identified the stakeholders and their requirements 3. Described and evaluated the current overall system of ADA (including functional and system architectures) 4. Described and evaluated the current means to identify UXO 5. Defined the measures (Measures of Effectiveness (MOEs), Measures of Performance (MOPs)) for ADA 6. Generated and evaluated two alternatives to the current system 7. Documented the evaluation approach (including the use of Modeling and Simulation (M&S)) 8. Developed functional and physical architectures for the alternatives 9. Prepared an AoA between the current process and the two alternatives
Key Strategies
<ol style="list-style-type: none"> 1. Tailored SE process and products using Spec Innovations Innoslate 2. Deliverables were coordinated with the team through the team leader 3. Research questions were generated by the team 4. Data collected through the use of online resources and libraries 5. M&S were run to estimate how effective the alternative systems operate and leveraged tools such as ExtendSim 6. Cost estimation was performed to the best extent possible using the Center for Systems and Software Engineering Constructive Systems Engineering Cost Model (COSYSMO)/Constructive Cost Model II (COCOMO II) 7. Two alternatives were generated 8. Made sure to keep the functional focused on the “what” to be accomplished, and the physical on the “how” things were accomplished
Constraints
<ol style="list-style-type: none"> 1. The team had limited access to actual stakeholders 2. The project was completed within three semesters according to Naval Postgraduate School (NPS) guidelines 3. The project team was fixed to the identified six people and did not expand nor contract to complete the project work 4. Certain physical components examined were not able to meet the requirements of the system

Continued on next page.

Table 2. Continued from previous page.

Assumptions
<ol style="list-style-type: none"> 1. There were enough data for the project through web search and interview data collection 2. Attributes from equivalent components were used for modeling 3. No real budget existed. There were no expenditures to complete the project. There was no procurement 4. The proposed solution to the problem was not actually implemented 5. There was no materiel solution to deploy 6. Not all physical component attributes were readily available to the team. Analogies to other, related technologies, were substituted for the purpose of this report

B. REQUIREMENTS ANALYSIS METHODOLOGY

Requirements analysis was performed using the Institute of Electrical and Electronics Engineers (IEEE) SE standard P1220 titled “*Standard for System Engineering.*” Fifteen task areas were taken into consideration during this analysis (Schmidt 2002). Taken into account during the requirements analysis were inputs, controls, and enablers. For the purpose of the IADAS effort, inputs, controls, and enablers were leveraged as much as possible to conduct a thorough requirements analysis.

C. FUNCTIONAL ANALYSIS METHODOLOGY

Functional analysis is an SE process activity that transforms the requirements into functions necessary for the system to accomplish its mission. The system functions then guide the system design. The objective at this stage was to identify what the system will accomplish and not how the system will do it. “The purpose of the ‘functional analysis’ is to present an overall integrated and composite description of the systems’ functional architecture, to establish a functional baseline for all subsequent design and support activities, and to provide a foundation from which all physical resource requirements are identified and justified; that is, the system’s physical architecture” (Blanchard and Fabrycky 2011). Enhanced functional flow block diagrams were used to describe the functional architecture.

D. PHYSICAL ARCHITECTURE METHODOLOGY

The physical architecture of the IADAS system identified the physical resources required for all functions identified in the functional architecture (Blanchard and Fabrycky 2011). The tool leveraged for the physical architecture was the morphological box. Research was performed in order to determine the physical components that had the capability to deliver the appropriate functionality to address the needs of IADAS. A comparison of options resulted in a wide variety of potential systems that needed to be reduced further to get down to the target of evaluating two system concepts. The SE tool used to perform this comparison was the Pugh matrix. The purpose of the Pugh matrix was to take the multitude of requirements and begin to reduce the alternatives to a manageable number. Once the Pugh matrix analysis was complete, the two IADAS alternatives were identified.

E. ANALYSIS OF ALTERNATIVES METHODOLOGY

The SE process built the foundation necessary for an AoA. The requirements had been decomposed from the stakeholders. Several representations of the functional components were documented so the system could be understood from a visual perspective. This, in turn, was further elaborated upon by creating the physical architecture of the IADAS alternatives. The main components of the AoA were cost and effectiveness. First, the cost per component was researched, either through documentation from existing systems or relative costs from components that delivered similar functionality. Second, the performance data was derived from similar components available at the time of the study. All of the data was collected, summarized and used as inputs to the system model. Modeling is described in the next chapter.

F. MODELING METHODOLOGY

1. Cost Modeling Methodology

A cost analysis was performed to provide the estimated ownership cost, associated for each of the three systems, through a 10-year life cycle. This approach captured the cost for a single implementation of each alternative over the defined 10-year life cycle and included cost incurred for:

- research and development (R&D) (IADAS I and II only)
- the SE (IADAS I and II only)
- personnel
- operations and support (O&S)

The parametric method for estimating was chosen because there was limited program and technical definition. The NPS System Cost Model Suite software was used to develop estimated systems engineering, software, and hardware costs over a 10-year life cycle for each of the alternative systems. The comparison was made between all three systems, comparing their ownership costs against each other, and determining the best value against the time to accomplish the mission of ADA and reporting.

2. Effectiveness Modeling Methodology

The effectiveness methodology (Figure 4) was the sum of the processes used to conduct the effectiveness assessment (EA).

This methodology was designed to compare the effectiveness of the three ADAS systems based on their military and operational worth. The EA addressed both operational effectiveness and operational suitability. The IADAS mission tasks were developed based on the requirement analysis performed previously. The MOE estimates were developed to assess the ability of the alternative IADAS systems to satisfy the developed mission tasks. The MOEs are a measure of how well a mission task was accomplished through using a given alternative system.

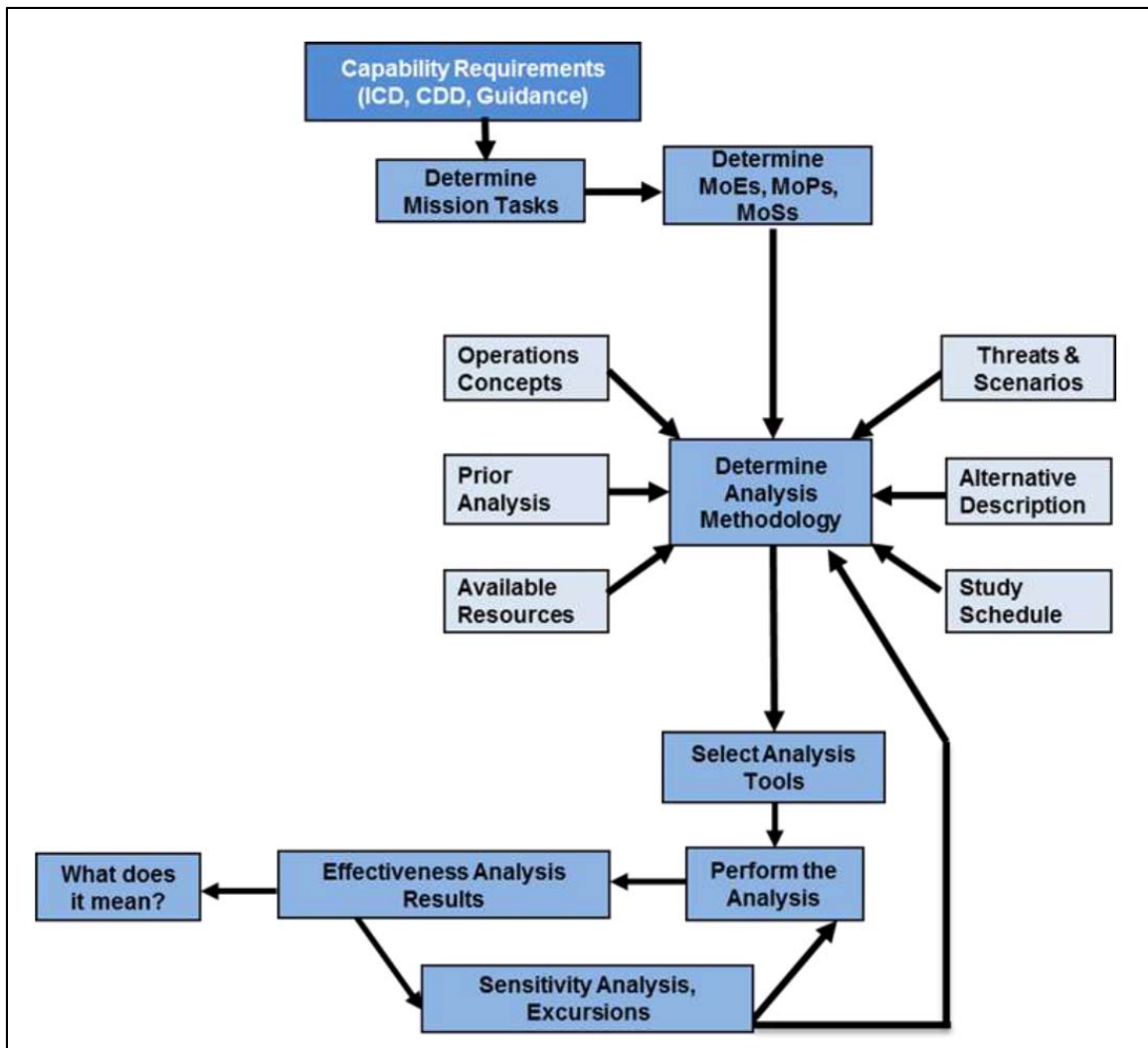

Figure 4. Effectiveness Assessment Methodology. Source: Air Force Material Command (2010).

The effectiveness analysis was conducted at the engagement level to model the interaction between IADAS alternatives versus a single threat situation, as shown in Figure 5. This level of analysis was chosen due to the time constraints associated with the project and the increased complexity of analyzing at a higher level especially with respect to M&S.

The methods used to support the IADAS effectiveness assessment included modeling and simulation, comparative analysis with legacy systems, and engineering assessments.

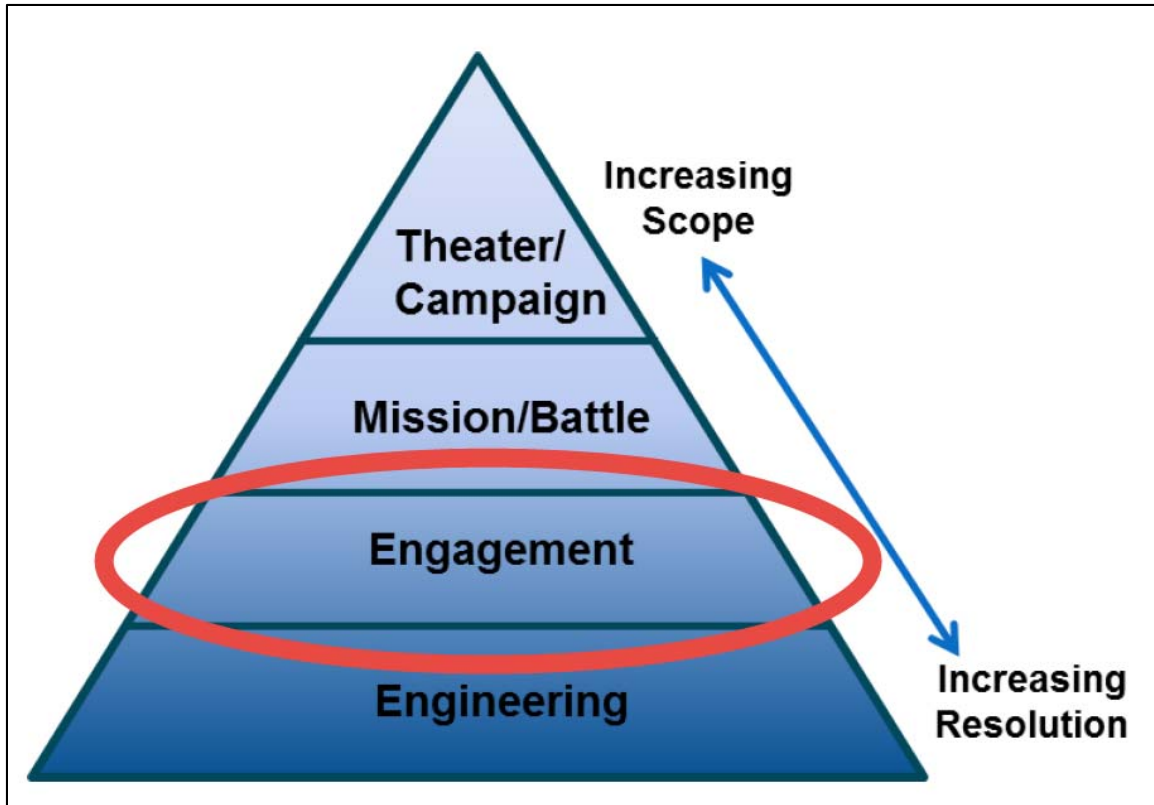

Figure 5. Effectiveness Analysis Methodology. Source: Air Force Material Command (2010).

G. DESIGN REFERENCE MISSION

The ADA is most critical after an enemy attack when seconds matter in returning the airfield back to operational status. Because the purpose of this project was to focus on the ADA, the DRM was defined to be beginning after an enemy attack on a U.S. airfield. In order to design a solution that is operationally feasible for a majority of the airfields, it is understood that the ADA should be all encompassing to include:

1. Various types of airfield surfaces such as paved, unimproved, or dirt
2. Airfields of various dimensions to include length and width
3. The UXO types, size, and quantity
4. Weather conditions such as hot, cold, rain, wind, fog, or snow

5. Available lighting such as day, night, or twilight.

A DRM that is limited in scope was generated due to the limited resources available to include the time to complete the study and number of personnel conducting the study. Interested stakeholders can expand the results of this study to determine if the recommended solutions also work well with the other environmental considerations listed above.

Development of the DRM involved researching the characteristics of various foreign bombs likely to be involved in an airbase attack in order to have a realistic input into the model. After careful consideration, the Russian RBK-500 BetAB Cluster Bomb (see [Figure C-1](#)) was selected as one of the weapons to be used against an airfield in the theater of interest. The Russian RBK-500 BetAB carries 12 BetAB, which are concrete penetrating bomblets for anti-airfield attacks (Jane's Air Launched Weapons 2007). It is reported that each bomblet (BetAB) is capable of penetrating 400 mm concrete and causes a damage area of 4 m² (Jane's Air Launched Weapons 2007). The BLU-97 was selected as a comparable weapon to determine the failure rate of the RBK-500: "The official failure rate of the BLU-97 is seven percent, but failure rates of at least 16% have been observed in Afghanistan. The failure rate of the Soviet sub-munitions is not known. Their fuses would be less sensitive, making it more difficult to unintentionally detonate a failed sub-munition" (Handicap International 2007). Based on this similarity, a dud rate of 16% was selected for the DRM. The RBK-250 AO-1 was used for comparison purposes to determine the maximum footprint for the RBK-500 BetAB. The RBK-250 AO-1 is equipped with 150 fragmentation bomblets. The canister is 2120 mm long, 325 mm in diameter, and weighs 273 kg, including 150 kg of sub-munitions. The maximum footprint area is 4,800 m² (The Fighter Collection & Eagle Dynamics, Inc. 2013). The RBK-250 AO-1 is an antipersonnel CBU. The similarity between the two weapons allows for the "maximum footprint" to be the used for the DRM.

An RBK-500 Cluster Bomb Unit (CBU) filled with AO2.5RTs is also part of the DRM. The main reason for this is to add UXOs to the model. The AO-2.5RT is an anti-personnel fragmentation sub-munition, which could be used to slow down the damage assessment and repair phases. It carries 108 AO-2.5RT sub munitions (fragmentations)

(International Campaign to Ban Landmines 2012). It also has a footprint of 224,000 ft² (267 ft. radius) (SU-27 Flanker 2017). Based on the same rationale provided for the RBK-500, a dud rate of 16% was used for the DRM.

After careful consideration, the Russian FAB-500 T General Purpose Bomb (see [Figure C-3](#)) was selected as the other weapon to be used against an airfield in the theater of interest. In the case of slow blasting crater, the FAB-500 T had a depth 13 m, diameter of 22.5 m, and the radius of the separation of fragments was 430 m. Such an effect is possible due to the fact that the bomb at high speed penetrates and digs into the ground and then later explodes (Global Security.org 2016). The DRM weapon characteristics are summarized in Table 3.

Table 3. DRM Weapon Information

Weapon	Number of Sub-munitions	Dud Rate (%)	Crater Size/ Damage Footprint	Crater Depth	Clean up/ Spalling Diameter	Max Dispersal
Russian RBK-500 BetAB Cluster Bomb	12 BetAB	16	4 m ²	N/A	N/A	40 m/ (~130 ft)
Russian RBK-500RTM AO Cluster Bomb	108 AO-2.5RT	16	20810.3 m ² (224,000 ft ²)	N/A	N/A	81.4 m (267 ft)
Russian FAB-500 T Bomb	N/A	N/A	398 m ² / (4273 ft ²)	13 m/ (43 ft)	430 m/ (1411 ft)	N/A

The DRM scenario follows:

The USAF has established Chinoski Air Base (AB), a forward operating airbase in fictional Kasnia, which was considered a hostile area. Chinoski AB has two primary runways of concern and the runways are the focus of the ADA. These runways run parallel to each other and are 5676 and 6521 feet in length and 150 feet wide. Chinoski AB was prepared for an attack, and they prepositioned and dispersed equipment and personnel as a preemptive measure as well as established and assigned members for the ADA and UXO team in addition to the EOC. A grid map, a map with X, Y coordinates for reference, of the airfield was created and dispersed to the personnel within the EOC and the ADAT to help support the determination of where the damage and UXO locations were specified. At 1000 local time, the base RADAR detected enemy aircraft approaching Chinoski AB, and the base commander determined there was not enough time to launch a counter attack. The base was immediately put into an “Alarm Red” condition, which indicated that all personnel needed to take immediate cover in preparation of an attack on Chinoski AB. It should be noted that each base follows an overarching protocol such as those described in *AFPAM 10-219* (Department of the Air Force 2008) for Alarm Red conditions, with each individual base establishing local procedures. At 1030, the attack concluded, the base was put into “Alarm Black,” and ADA started. Table 4 provides the detailed information about the attack including the weapon used, the grid location where it landed, and the damage produced. Figure 6 shows a layout of the takeoff and landing surfaces as well as the damage as a result of the attack on Chinoski AB. Additional details can be found in Appendix C, [Tables C-1 through C-3](#).

Table 4. Detailed Attack Information

Weapon	Location Dropped (X, Y coordinates)	Damage
RBK-500 BetAB (1)	3261,700	<ul style="list-style-type: none"> • 12 BetAB bomblets landed on runway 27R/9L • 4 Bomblets did not function and are currently classified as a UXO • 0 Bomblets landed on runway 9R/27L
RBK-500 BetAB (2)	1000,75	<ul style="list-style-type: none"> • 0 Bomblets landed on runway 27R/9L • 12 BetAB bomblets landed on runway 9R/27L • 5 Bomblet did not function and are currently classified as a UXO
RBK-500 AO-2.5RT	500,700	<ul style="list-style-type: none"> • 43 Bomblets landed on runway 27R/9L • 4 Bomblets did not function and are currently classified as a UXO
FAB-500 T (1)	2130,700	<ul style="list-style-type: none"> • Landed on runway 27R/9L • Formed a crater 22.6 m (74 ft) wide and 13 m (43 ft) deep, with debris and spalling diameter of 430 m (1411 ft)
FAB-500 T (2)	5000,75	<ul style="list-style-type: none"> • Landed on runway 9R/27L • Formed a crater 22.6 m (74 ft) wide and 13 m (43 ft) deep, with debris and spalling diameter of 430 m (1411 ft)
FAB-500 T (3)	4000,700	<ul style="list-style-type: none"> • Landed on runway 27R/9L • Formed a crater 22.6 m (74 ft) wide and 13 m (43 ft) deep, with debris and spalling diameter of 430 m (1411 ft)
FAB-500 T (4)	3261,75	<ul style="list-style-type: none"> • Landed on runway 9R/27L • Formed a crater 22.6 m (74 ft) wide and 13 m (43 ft) deep, with debris and spalling diameter of 430 m (1411 ft)

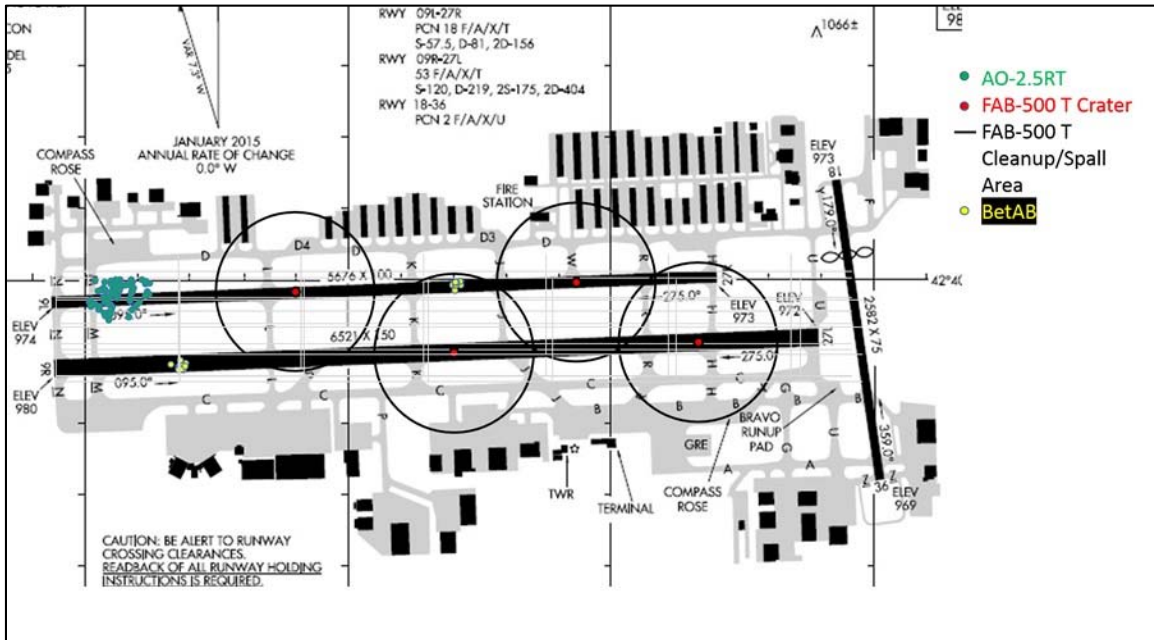

This DRM is based on a forward operating airbase in a hostile area. Based on enemy aircraft approaching, the base was put into an “Alarm Red” condition. Following the attack, the base was put into an “Alarm Black” condition. The damage from the enemy attack is noted on the figure.

Figure 6. DRM. Adapted from Aircraft Owners and Pilots Association (2017).

III. SYSTEMS DESCRIPTIONS

A. INTRODUCTION

During this phase of the project, the system requirements were refined based on stakeholder needs. The functional and physical architectures were developed. The current system was described and the two alternate systems created.

B. REQUIREMENTS ANALYSIS

The stakeholder needs (Table 5) for the new IADAS were identified based on the user and problem statement, literature research, and the stakeholder analysis. The data flow diagram (DFD) (Figure 7) was developed based on the stakeholder needs to determine the system boundary, system inputs, system outputs, and internal/external data flows.

Table 5. Stakeholder Needs

Reference	Description
1.0	Damage Assessment
1.1	IADAS shall detect when an airfield has been damaged.
1.2	IADAS shall classify the type of airfield damage.
1.3	IADAS shall locate and measure airfield damage.
2.0	UXO Assessment
2.1	IADAS shall detect UXO on airfield surfaces.
2.2	IADAS shall classify the type of UXO on airfield surfaces.
2.3	IADAS shall provide a location of UXO on airfield surfaces.
2.4	IADAS shall automatically transmit damage and UXO data into GeoExPT.
2.5	IADAS shall not expose personnel to explosive hazards during UXO and damage assessment activities.
3.0	Time Assessment
3.1	IADAS shall complete damage and UXO assessment and reporting in less than 30 minutes (objective)/45 minutes (threshold).

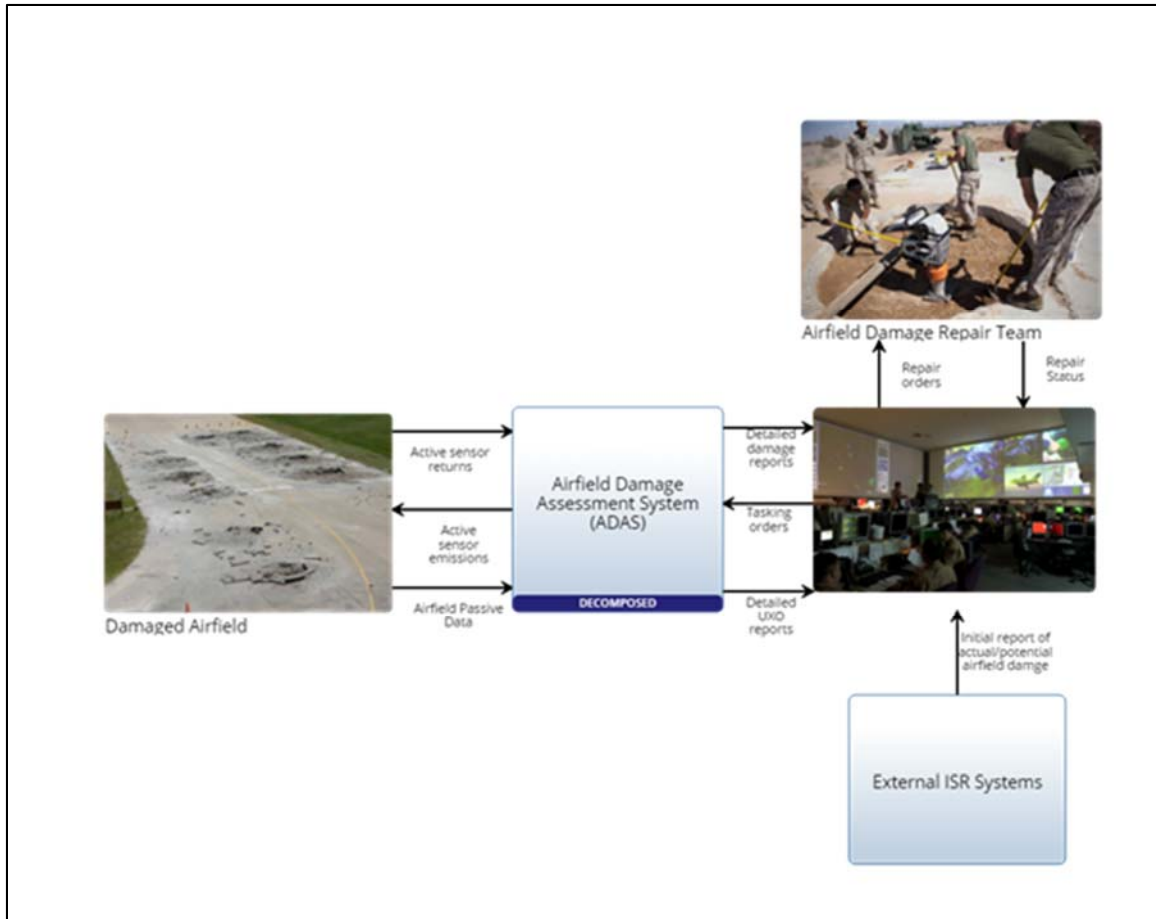

The DFD is comprised of the ADAS, the ADR team, external sensor systems, and the damaged area.

Figure 7. IADAS DFD

The results from examining the 15 task areas during requirements analysis are provided in Table 6. From here, the functional (what the system should do) vs. non-functional requirements (how well the system works) for IADAS were developed. [Table 7](#) provides the Functional Requirements Traceability Matrix and [Table 8](#) provides the Non-Functional Requirements.

Table 6. Requirements Analysis Results

Task	Results	Scope Limitation
Customer expectations	At the highest level, the expectation of the IADAS was to reduce the time for detailed assessment and quantity of ADAT required to complete an ADA. Information acquired from the interview was used in this report.	
Project and enterprise constraints	Constraints imposed upon the system were primarily the policies and procedures that were required to perform an ADA successfully. Other constraints were the lack of financial and human resource allocations to the effort.	
External constraints	One of the primary hurdles the system development faced was the level of advancement in the current technology base.	
Interfaces	The interfaces used in IADAS provide communication between hardware components to ensure the system was able to complete the mission. Software was used to coordinate sensors and communicate appropriate messages between IADAS sensors and also to the User.	Due to time constraints, the primary interface was limited to the GeoExPT.
Utilization Environments	The environment in which the IADAS will operate will vary from location to location, all over the world. Weather conditions of all types may be encountered, including but not limited to, rain, snow sun, wind, ice, dust, and fog. Extreme temperature ranges and relative humidity may be encountered. All land based topologies were taken into account for the IADAS system. Topologies include but were not limited to mountain, desert, plains, and vegetation.	Due to time constraints, the environment under consideration was limited to daylight and fair weather conditions.

Continued next page.

Table 6. Continued from previous page.

Task	Results	Scope Limitation
Life cycle process concepts	<p>The IADAS will follow the DOD acquisition life cycle, as specified in DODI 5000.02, with all relevant key life cycle process milestones. Driving down cost and risk over the full life cycle of the system were the key drivers for following this process (Under Secretary of Defense (AT&L) 2003). Regular reviews throughout the life cycle ensured that the IADAS baseline was developed to be producible, testable, operable, supportable, and trainable. Reviews include Initial Technical Review, Alternative System Review, System Requirements Review, Integrated Baseline Review, System Functional Review, Preliminary Design Review, Critical Design Review, Test Readiness Review, Flight Readiness Review, System Verification Review, Functional Configuration Audit, Production Readiness Review, Operational Test Readiness Review, Physical Configuration Audit, and In-Service Review.</p>	<p>These reviews were outside the scope of this report.</p>
Functional Requirements	<p>The functions of the IADAS were the foundational elements that enabled the system to accomplish its mission. The basic high level functions of the IADAS were to detect, identify, assess, classify, measure, and report. See Table 7 for a listing of the functional requirements.</p>	
Operational scenarios	<p>The operational scenario for the IADAS was defined in the DRM. The IADAS must be capable of performing a detailed analysis of a damaged airfield consisting of runways, taxiways, and aprons with UXO present. A standard dual runway is nominally sized 12,000 feet by 150 feet each and ramps, aprons and taxiways nominally total 86,000 by 100 feet.</p>	
MOE and Measure of Suitability (MOS)	<p>The performance measures used to determine the ability of the IADAS to meet the customer's mission mainly focus on effectiveness.</p> <ul style="list-style-type: none"> MOE1: Damaged Assessed MOE2: UXO Assessed MOS1: Safety MOS2: Operability MOS3: Reliability 	<p>Due to time constraints, the MOS evaluation was outside the scope of this report.</p>

Continued next page.

Table 6. Continued from previous page.

Task	Results	Scope Limitation
System boundaries	Physical and software components developed specifically for use in the IADAS were under design control of this activity. Any components leveraged from outside systems, including government furnished equipment was not under this system boundary and was the responsibility of the owning Program Manager. Interfaces between the IADAS and external systems, to include both hardware and software interfaces, were under the IADAS system boundary.	
Performance Requirements	Assessing the damage and UXO evaluation became the basis for the performance requirements of the IADAS systems.	
Modes of operation	The IADAS must have multiple modes of operation (manual, autonomous, or a combination of both).	
Technical performance measures (TPMs)	The key indicators of system performance for the IADAS were related to the most important performance parameters derived from the system requirements. The survey time and the accuracy of the reporting the damage location and size were of the utmost importance and were defined as the TPM for the IADAS.	
Physical characteristics	The physical characteristics of IADAS were appropriate to satisfy all given environmental requirements.	Due to time constraints, a physical characteristics evaluation was outside the scope of this report.
Human Systems Integration (HSI)	HSI aspects of the IADAS were designed to standards as specified in the MIL-STD-1472G DOD Design Criteria Standard for Human Engineering (Department of Defense 2012).	Due to time constraints, HSI evaluation was outside the scope of this report.

Table 7. Functional Requirements Traceability Matrix

IADAS Specification Reference (From Innoslate)	IADAS System Specification Requirement Description ¹	From Stakeholder Needs
1.1.1	IADAS shall detect craters on paved surfaces greater than or equal to 90 percent of the total number of craters.	1.1 and 1.2
1.1.2	IADAS shall detect craters on airfield infield surfaces greater than or equal to 50 percent of the total number of craters. ²	1.1 and 1.2
1.1.3	IADAS shall detect craters on semi-prepared airfield surfaces greater than or equal to 80 percent of the total number of craters. ²	1.1 and 1.2
1.2.1	IADAS shall detect camoufllets on paved surfaces greater than or equal to 80 percent of the total number of camoufllets.	1.1 and 1.2
1.2.2	IADAS shall detect camoufllets on paved airfield infield surfaces greater than or equal to 50 percent of the total number of camoufllets. ²	1.1 and 1.2
1.3.1	IADAS shall detect UXOs on Paved Surfaces greater than or equal to 80 percent of the total number of UXOs. Objective is 90 percent of the total number of UXOs.	2.1
1.3.2	IADAS shall detect UXOs on semi-prepared airfield surfaces greater than or equal to 80 percent of the total number of UXOs. Objective is 90 percent of the total number of UXOs. ²	2.1
1.3.3	IADAS shall detect UXOs on airfield infield surfaces greater than or equal to 50 percent of the total number of UXOs. Objective is 75 percent of the total number of UXOs. ²	2.1
1.4	IADAS shall classify UXO by major class category IAW the Airman's Manual: Class A (Large Bombs); Class B (Rockets and Missiles); Class C (Projectiles and Mortars); Class D (Landmines); Class E (Bomblets); and Class F (Rocket Propelled Grenades and Grenades). ³	2.2
1.5.1	IADAS shall measure apparent diameter of surface damage for camoufllets, craters and spalls within 20 percent of actual diameter.	1.3
1.5.2	IADAS shall measure apparent damage of surface damage for camoufllets, craters and spalls within 10 percent of actual diameter.	1.3
1.5.3	IADAS shall measure apparent diameter of a camoufllets under a surface within 10 percent of actual diameter.	1.3
1.6.1	IADAS shall locate damage by the center point of the object.	1.3
1.6.2	IADAS shall report horizontal positional accuracy of less than or equal to ten feet. Objective is a horizontal positional accuracy of two (2) feet.	1.3

Continued next page.

Table 7. Continued from previous page.

IADAS Specification Reference (From Innoslate)	IADAS System Specification Requirement Description ¹	From Stakeholder Needs
1.6.3	IADAS shall report location data in Mapping Grade precision using the Military Grid Reference System (MGRS).	2.4
1.9.1	IADAS shall complete damage and UXO assessment and reporting in less than 30 minutes.	3.1

NOTES:

¹Derived from the RFI in support of planning/acquisition strategy development for RADAS dated 07 June 2012 (Department of the Air Force 2012b).

²Due to time constraints, the requirements identified were not evaluated as part of the AoA.

³Technology to identify and classify UXO is still relatively new. The bigger push at this time is to identify damage. No known objective or threshold values for correctly classifying the UXO are available at this time.

Table 8. Non-functional Requirements

IADAS Specification Reference (From Innoslate)	IADAS System Specification Requirement Description ¹	From Stakeholder Needs
1.7.1	IADAS shall be assessable in day, night ² and civil twilight ² lighting conditions.	4.2
1.7.2	IADAS shall operate in temperature conditions from -45 to +130 degrees Fahrenheit ³ .	4.2
1.7.3	IADAS shall be able to assess through obscurants such as fog, fog oil, and brass flakes. ²	4.2
1.7.4	IADAS shall operate in relative humidity up to and including 100 percent. ²	4.2
1.7.5	IADAS shall perform assessment through precipitation and accumulation of rain 0.3"/hour, snow accumulation of 3"/hour, and dry and wet surfaces with water puddles. ²	4.2
1.7.6	IADAS shall be operable from a sheltered location near the airfield.	4.3
1.7.7	IADAS shall be remotely operable from an installation operations center.	4.3

Continued next page.

Table 8. Continued from previous page.

IADAS Specification Reference (From Innoslate)	IADAS System Specification Requirement Description¹	From Stakeholder Needs
1.7.8	IADAS shall be small-arms resistant and blast resistant. ²	4.2
1.7.9	IADAS shall be capable of withstanding Nuclear, Biological, and Chemical (NBC) decontamination procedures. ²	4.2
1.8.1	IADAS shall be capable of being operated and maintained (excluding depot-level maintenance) while wearing NBC mission oriented protective posture (MOPP)-IV clothing for indoor and outdoor tasks. ²	4.1
1.8.2	IADAS shall be capable of being operated and maintained while wearing cold weather clothing for outdoor tasks or tasks performed in non-temperature controlled shelters. ²	4.1
<p>NOTES: ¹Derived from the RFI in support of planning/acquisition strategy development for RADAS dated 07 June 2012 (Department of the Air Force 2012b). ²Due to time constraints, the requirements identified were not evaluated as part of the AoA. ³Due to time constraints, temperatures outside ambient were not evaluated as part of the AoA.</p>		

The final step for the requirements analysis was to develop the MOEs based on the requirements (see Table 9). Three MOEs were utilized to evaluate the effectiveness of the systems.

Table 9. IADAS MOEs

MOE 1	Damage Assessment Time
MOE 2	Percent Damage Assessed
MOE 3	Percent UXO Assessed

C. CURRENT ADAS SYSTEM AND FUTURE IADAS CONCEPTS

The next step in the process of determining the potential alternatives for the IADAS system was to determine the components used in the current ADAS system, and those potential components which could be leveraged for the IADAS system. The tools used to perform those activities were the morphological box and the Pugh matrix SE concepts.

Starting with the morphological box concept, the functional architecture was referenced in order to create the categories of physical components. The next step was to research the broad spectrum of tools which could deliver the required capabilities within each of those categories.

The morphological box for the current ADAS system was fairly straightforward, since the process was mainly a manual effort performed by the ADAT resources. Table 10 shows both the functional categories (columns) and physical components (rows) which make up the concept used today. The column entitled Mechanism refers to the mode of transportation used to convey the ADAT team to the area of interest which is ground travel via a High Mobility Multipurpose Wheeled Vehicle (HMMWV) tactical vehicle. The column entitled Sensor refers to the components used to gather the necessary data for the assessment of airfield damage, UXO identification, and location information. The third column entitled Data Processor indicates the resource utilized to put the ADA report information together. The final column entitled Communication refers to the hardware utilized to communicate the report data back to the EOC.

Table 10. Current ADAS System Components

Mechanism	Sensor	Data Processor	Communication
HMMWV	Eyes	Human	Radio
	Tape Measure		

The next step was to take the morphological box categories and expand them to cover the “art of the possible” as it applied to future concepts to deliver the same

capability as the manual process applied by the ADAT resources. The results of that effort are documented in Table 11.

Table 11. The Future IADAS System Components

Mechanism	Sensor	Data Processor	Communication
RPA	LiDAR ¹	CPU ²	Hardwire
Stationary Setting	RADAR		Removable Storage
UGV ³	Acoustic Imaging		Wireless
Satellite	Infrared Imaging		
	Day Camera		
	Imbedded Sensors		
¹ Light Detection and Ranging		² Central Processing Unit	
³ Unmanned Ground Vehicle			

A design feature interaction analysis was used where all of the components were evaluated against each other. The purpose was to sort out any combinations which would not be compatible with one another. Using this method, the complete set of 72 options was reduced to 50 options. These options were further reduced based on USAF studies in which UGV or Acoustics solutions were eliminated due to being functionally improbable. Additionally, based on USAF studies, satellite and imbedded sensors were eliminated due to cost. This reduced the number of viable options to 20. The results are captured in Table 12.

Table 12. Final List of Options for Pugh Matrix Analysis

Option	Mechanism	Sensor	Data Processor	Communication
1	RPA	LiDAR	CPU	Wireless
2	RPA	RADAR	CPU	Wireless
3	RPA	Infrared Imaging	CPU	Wireless
4	RPA	Day Camera	CPU	Wireless
5	RPA	LiDAR	CPU	Removable Storage
6	RPA	RADAR	CPU	Removable Storage
7	RPA	Infrared Imaging	CPU	Removable Storage
8	RPA	Day Camera	CPU	Removable Storage

Continued next page

Table 12. Continued from previous page

Option	Mechanism	Sensor	Data Processor	Communication
9	Stationary Tower	LiDAR	CPU	Hardwire
10	Stationary Tower	RADAR	CPU	Hardwire
11	Stationary Tower	Infrared Imaging	CPU	Hardwire
12	Stationary Tower	Day Camera	CPU	Hardwire
13	Stationary Tower	LiDAR	CPU	Wireless
14	Stationary Tower	RADAR	CPU	Wireless
15	Stationary Tower	Infrared Imaging	CPU	Wireless
16	Stationary Tower	Day Camera	CPU	Wireless
17	Stationary Tower	LiDAR	CPU	Removable Storage
18	Stationary Tower	RADAR	CPU	Removable Storage
19	Stationary Tower	Infrared Imaging	CPU	Removable Storage
20	Stationary Tower	Day Camera	CPU	Removable Storage

The next step was to start to build the options using the Pugh matrix. The requirements were reduced down to a manageable amount so as to reduce the complexity of the calculations. The major requirements for the IADAS system were considered: damage location, damage size, damage accuracy, UXO location, UXO identification, reporting, and IADAS portability. Additional non-functional requirements considered included affordability, maintainability, reliability, and survivability. For each option a “+,” “-,” or “S” was entered into each cell to represent if the new concept is significantly better “+,” worse “-,” or the same “S” as the datum concept. The utilization of the Pugh matrix helped to quantitatively analyze the various combinations of system components being brought together to create various design alternatives. By going through the Pugh matrix process, the IADAS alternatives were compared based on how they addressed the

requirements from a complete system perspective (see Table 13). [Table 14](#) provides the results of the Pugh matrix analysis.

Table 13. Pugh Matrix Analysis

Requirement Number	Concept Critical to Satisfaction or Requirement	Importance Rating	0	1	2	3	4	5	6	7	8	9	10	11	12	13	14	15	16	17	18	19	20
				RLW	RRW	RW	RDW	RLR	RRR	RIR	RDR	SLH	SRH	SIH	SDH	SLW	SRW	SIW	SDW	SLR	SRR	SIR	SDR
1.1.1	Damage count accuracy for craters on paved surfaces	10		+	+	+	+	+	+	+	+	S	S	S	S	S	S	S	S	S	S	S	S
1.2.1	Damage count accuracy for camouflets on paved surfaces	9		-	+	-	+	+	-	-	+	+	-	-	+	+	-	-	+	+	-	-	+
1.3.1	UXO detection accuracy on paved surfaces	9		+	+	+	+	+	+	+	+	S	S	S	S	S	S	S	S	S	S	S	S
1.4	UXO classification	6		-	--	-	+	-	--	-	+	-	--	-	+	-	--	-	+	-	--	-	+
1.5.1	Surface damage measurement accuracy for craters	5		+	+	+	+	+	+	+	+	-	-	-	-	-	-	-	-	-	-	-	-
1.5.1	Surface damage measurement accuracy for camouflets	2	DATUM	S	+	S	S	S	+	S	S	S	+	S	S	S	+	S	S	S	+	S	S
1.5.1	Surface damage measurement accuracy for spalls	6		S	S	S	S	S	S	S	S	S	S	S	S	S	S	S	S	S	S	S	S
1.5.3	Subsurface damage measurement accuracy for camouflets	7		S	+	S	S	S	+	S	S	S	+	S	S	S	+	S	S	S	+	S	S
1.6.1	Damage location at center point of object	4		S	S	S	S	S	S	S	S	+	+	+	+	+	+	+	+	+	+	+	+
1.6.2	Damage location accuracy	6		-	-	-	-	-	-	-	-	+	+	+	+	+	+	+	+	+	+	+	+
1.6.3	Damage location using MGRS	3		S	S	S	S	S	S	S	S	+	+	+	+	+	+	+	+	+	+	+	+

Continued next page.

Table 13. Continued from previous page.

Requirement Number	Concept Critical to Satisfaction or Requirement	Importance Rating	0	1	2	3	4	5	6	7	8	9	10	11	12	13	14	15	16	17	18	19	20
				RLW	RRW	RIW	RDW	RLR	RRR	RIR	RDR	SLH	SRH	SIH	SDH	SLW	SRW	SIW	SDW	SLR	SRR	SIR	SDR
1.9.1	Damage and UXO assessment in timely fashion	10		+	+	+	+	--	--	--	--	+	+	+	+	+	+	+	+	--	--	--	--
1.7.1	IADAS accessible during the day	4		S	S	-	+	S	S	-	+	S	S	-	+	S	S	-	+	S	S	-	+
1.7.6	IADAS co-located with the airfield being assessed	7		+	+	+	+	+	+	+	+	+	+	+	+	+	+	+	+	+	+	+	+
1.7.7	IADAS remotely operable from EOC	8		+	+	+	+	+	+	+	+	+	+	+	+	+	+	+	+	+	+	+	+
Non-Functional	Affordability	10		-	-	+	+	S	+	+	+	-	-	-	S	-	-	-	S	-	-	-	S
Non-Functional	Maintainability	7		+	+	+	+	+	+	+	+	-	-	+	+	-	-	-	+	-	-	+	-
Non-Functional	Reliability	8		S	S	S	S	S	S	S	S	S	S	S	S	S	S	S	+	S	S	S	S
Non-Functional	Survivability	7		+	+	+	+	+	+	+	+	--	--	--	--	--	--	--	--	--	--	--	--

Table 14. Pugh Matrix Results

	1 RLW	2 RRW	3 RIW	4 RDW	5 RLR	6 RRR	7 RIR	8 RDR	9 SLH	10 SRH	11 SIH	12 SDH	13 SLW	14 SRW	15 SIW	16 SDW	17 SLR	18 SRR	19 SIR	20 SDR
Sum of Positives	8	11	9	13	8	10	8	11	8	9	8	12	8	9	7	13	7	8	7	9
Sum of Negatives	4	4	4	1	4	6	6	3	6	8	7	3	6	8	7	2	8	10	8	5
Sum of Neutrals	7	5	6	6	8	5	6	6	7	5	6	7	7	5	6	6	7	5	6	7
Positives - Negatives	4	7	5	12	4	4	2	8	2	1	1	9	2	1	0	11	-1	-2	-1	4
Weighted Sum of Positives	63	81	73	98	62	72	63	82	53	53	51	76	53	53	44	84	43	43	41	46
Weighted Sum of Negatives	31	28	25	6	32	47	45	26	42	57	48	19	42	57	48	12	62	77	61	39
Weighted Sum of Neutrals	0	0	0	0	0	0	0	0	0	0	0	0	0	0	0	0	0	0	0	0
Weighted Positives - Weighted Negatives	32	53	48	92	30	25	18	56	11	-4	3	57	11	-4	-4	72	-19	-34	-20	7

Based on the results, the IADAS I system for further consideration is an RPA with a day camera and wireless sensors with a score of 92. The IADAS II system for further consideration is a stationary tower with day camera and wireless sensors with a score of 72. Both of these systems are highlighted in green in [Table 13](#) and [Table 14](#). Honorable mentions include a stationary tower with a day camera and hard-wired sensors with a score of 57 and an RPA with day camera and a removable hard drive with a score of 56. These two systems are highlighted in yellow in [Table 13](#) and [Table 14](#).

D. SYSTEMS DESCRIPTION SUMMARY

The next step in the SE process was to define the various artifacts that would describe the current ADAS solution. This section includes the functional analysis, physical architecture, and CONOPS of the current ADAS, IADAS I, and IADAS II systems.

1. Current ADAS

a. Functional Analysis

A functional architecture was generated for the current ADAS system. This top-down decomposition showed the functions that were performed for a notional ADA mission. Figure 8 provides the top three levels of the current ADAS system. The current ADAS system is broken down into Perform Initial Reconnaissance, Perform Detailed Damage Assessment, and Compose Damage Assessment Report. Within these functions, the ADAS must Observe and Perform a visual inspection, assess airfield damage, and assess UXO on airfield. Figure 9 provides further decomposition for the Assess Airfield Damage action. Figure 10 provides further decomposition for the Assess UXO on Airfield action.

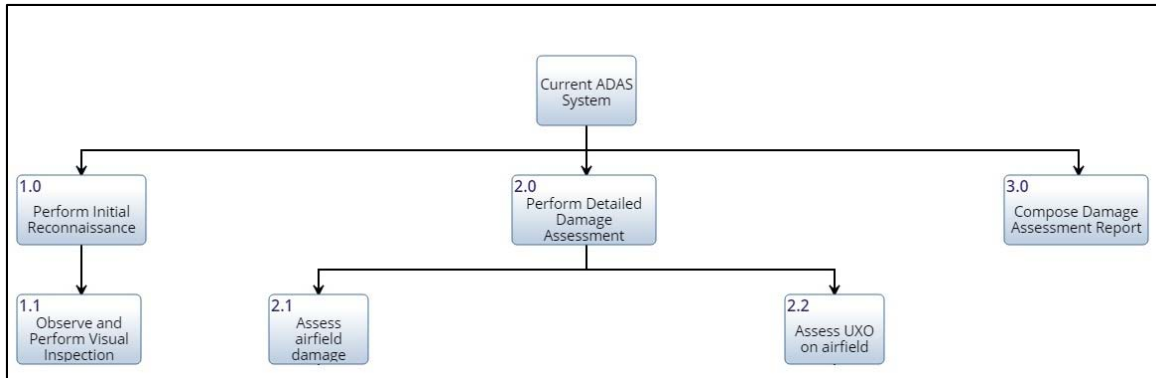

Figure 8. ADAS Mission Functional Architecture Hierarchy Chart (First Three Levels)

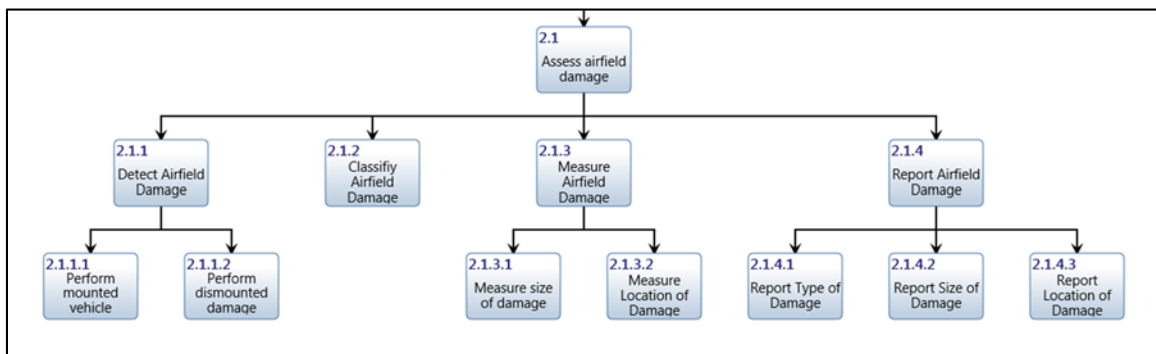

Figure 9. Assess Airfield Damage Decomposed

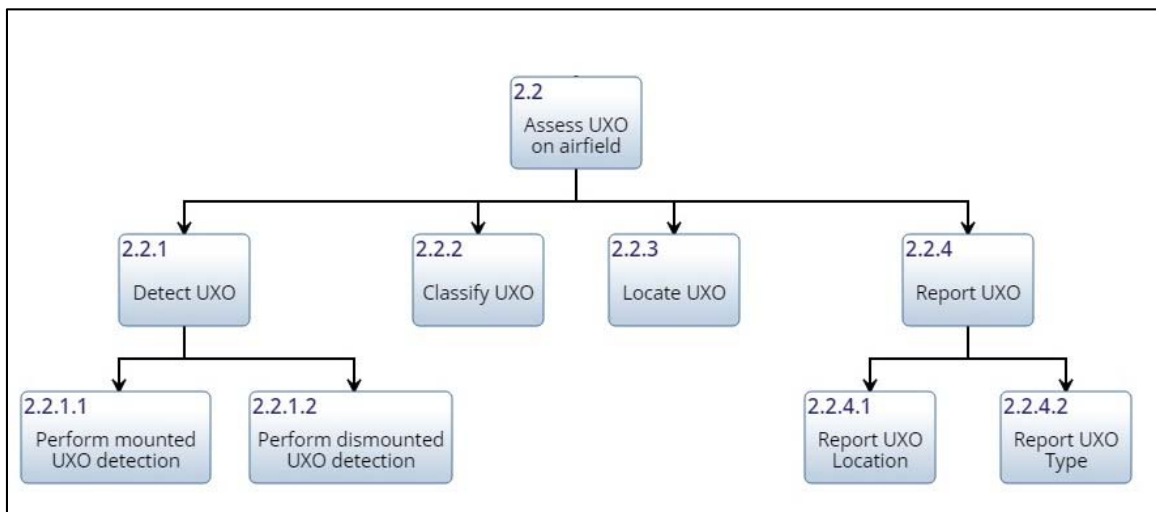

Figure 10. Assess UXO on Airfield Decomposed

The functional architecture was broken out into multiple levels. The first level was the mission of the ADAS which was comprised of the assess airfield damage, assess UXO, and interoperate with existing airfield damage reporting tools level two functions. These level two functions were then decomposed and refined into level three and four functions.

The existing ADAS must assess airfield damage which entailed detecting, classifying, measuring, and reporting on the damage. Similarly, the ADAS performed these same functions to assess any UXO on the airfield. Interoperability with existing airfield damage reporting tools was critical for the rapid reporting and processing of data.

The EFFBD defines task sequences and their relationships. As can be seen in Figure 11, the top level of the ADAS system was comprised of three functions; perform initial reconnaissance, perform detailed damage assessment, and compose damage assessment report. The functions that the ADAS was performing were decomposed further to lower level FFBD, matching the actions in the functional architecture hierarchy chart. The actions were traceable through all of the functional levels.

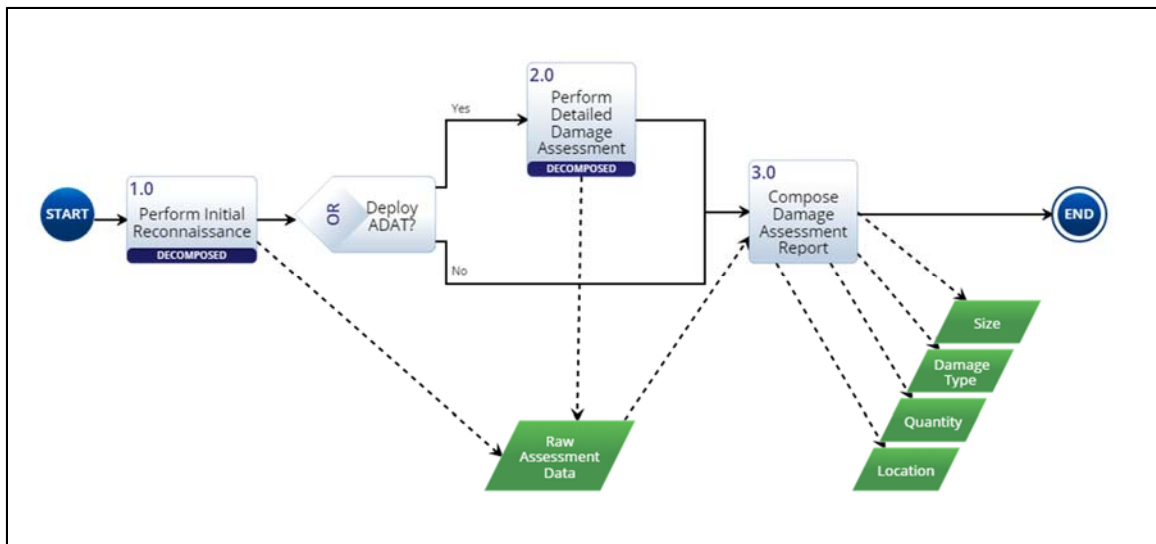

Figure 11. Current ADAS EFFBD

The next step in developing the functional architecture was to decompose all of the functions into the Integrated Computer Aided Manufacturing Definition for Function Modeling (IDEF0) format. The IDEF0 diagram of the current ADAS shows the data flow, system control, and overall functional flow. Figure 12 shows the IDEF0 diagram of the current ADAS. This diagram depicts controls, inputs, outputs, and mechanisms used to control each function.

For the current ADAS, the controls are the Base Alarm, EOC Communication, and Raw Assessment Data. Inputs include the visual damage observation data and the visual UXO observation data. The mechanisms used in the functions are Observations, Trained Personnel, and the ADAT. Outputs include the Compiled Report, Quantity, Location, Damage Type, and Size information.

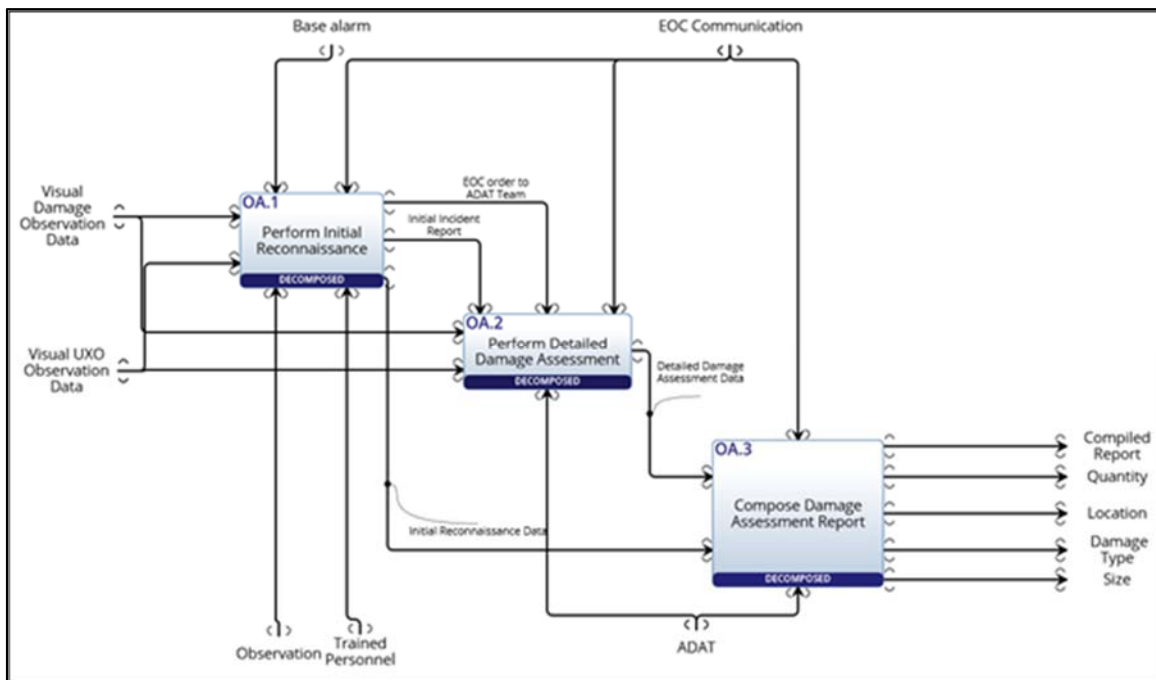

Figure 12. Current ADAS IDEF0 Diagram

Following preparation of the IDEF0 diagram, it was necessary to analyze the timeline of events for the current ADAS functional process. The sequence of events occurs between the EOC, ADAT, and Tape Measure. The EOC sends the ADAT

Deployment Order to the ADAT who then use the information provided by the tape measure to gain Raw Assessment Data. The ADAT then relays the Damage Notification and Measurements, as well as UXO Notification and Measurements to the EOC. The ADAT also provides the Compiled Report to the EOC. The sequence diagram can be seen in Figure 13.

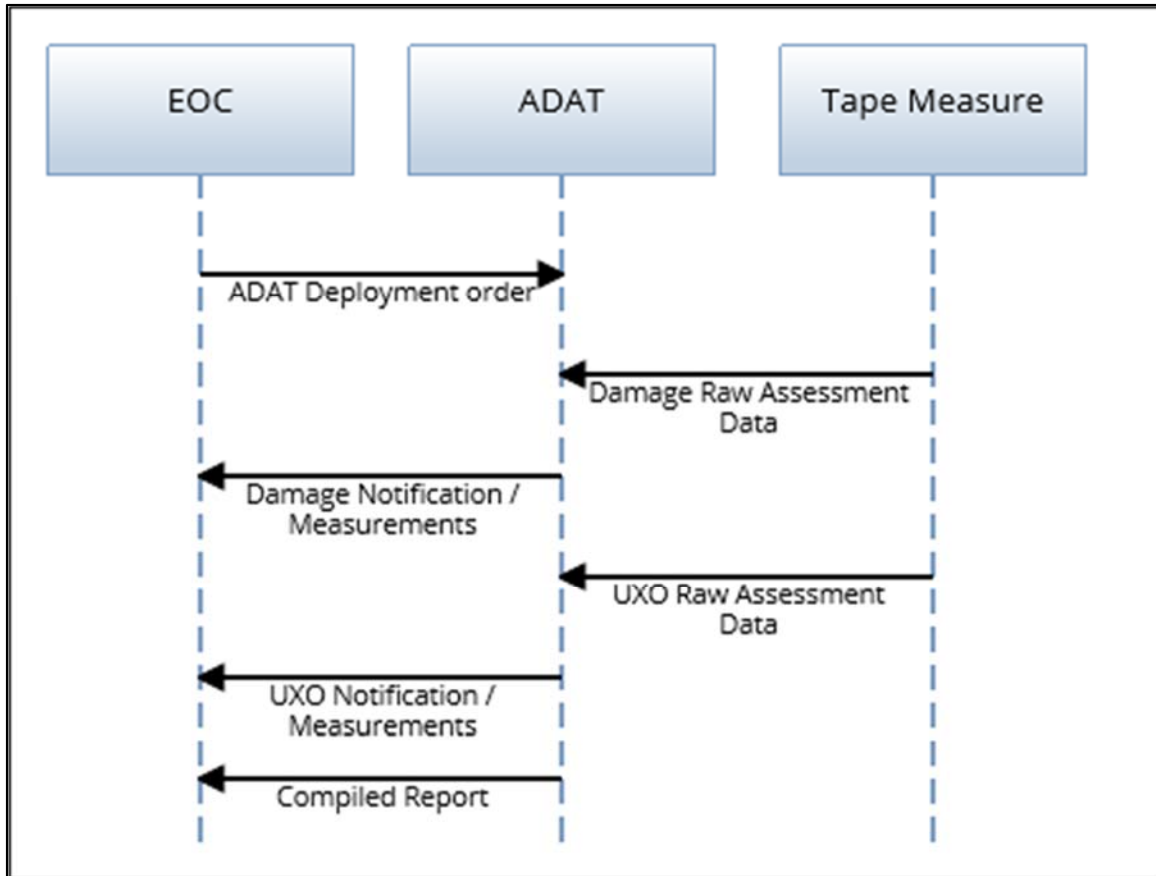

Figure 13. Current ADAS Sequence Diagram

Breaking down the activity further was a class diagram to describe the ADAS classes. The classes included attributes, operations, and parameters which were used to illustrate the relationship between classes, or assets. This is shown in Figure 14. The ADAS was decomposed by the EOC, observers, and the ADAT. The operations and

attributes may be seen in the diagram and how they relate to the outside class, the damaged airfield.

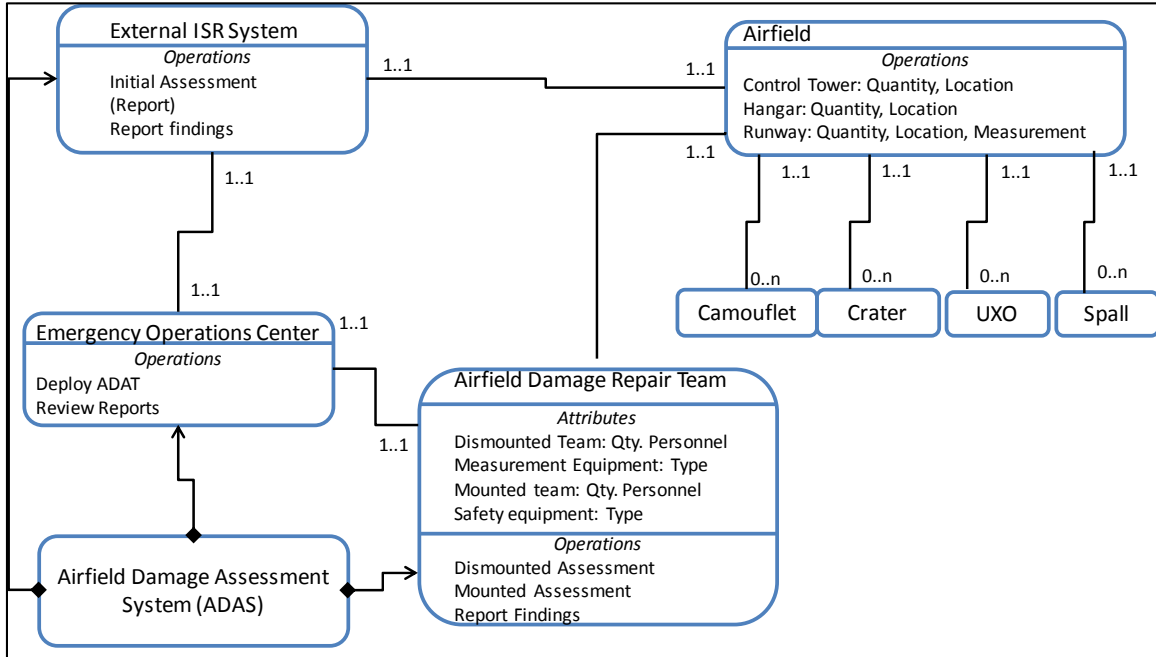

Figure 14. Current ADAS Class Diagram

b. Physical Architecture

The current ADAS system consists of ADAT personnel traveling to the area of interest either by foot or by ground vehicle from a staging area closely located to the mission area. Per *AFPAM 10-219* (Department of the Air Force 2008), the following equipment is recommended for the ADAT deployment kit: data recording and reporting equipment to include base grid maps, damage assessment forms, clipboards, writing instruments, radios, spare radio batteries, nonmetallic measuring tapes, flags and UXO markers. With these components in hand, the ADAT personnel would survey the area for what the mission calls for, make the appropriate notations, and return to the EOC to start the next phase of the process – entering the necessary data into GeoExPT.

c. CONOPS

Figure 15 shows the CONOPS diagram for the current ADAS. The steps below correspond to the numbers in Figure 15.

1. The observers at the Control tower/observation points relay initial damage reconnaissance to the EOC (1a) and concurrently the EOC orders the ADAT to move from staging area to start point (1b).
2. ADAT begins predetermined survey route to gather detailed damage and UXO data.
3. ADAT visual observation and reporting of Bomb and Bomblet Fields to EOC.
4. ADAT visual observation and reporting of UXO and Craters to EOC.
5. ADAT visual observation and reporting of Camouflets and Spall damage to EOC
6. Data reported to EOC includes; location, shape, color, markings, coordinates, render-safe time

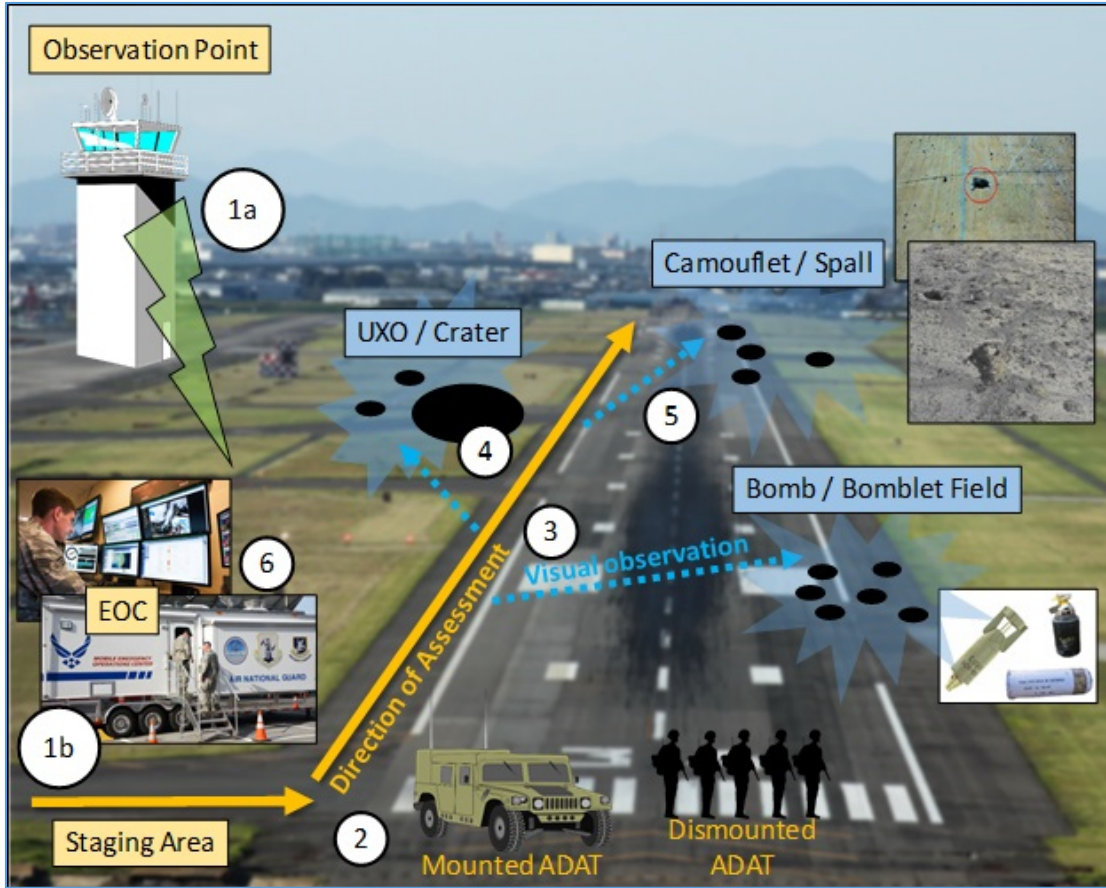

Figure 15. Current ADAS CONOPS

2. IADAS I

The next step in the SE process was to define the various artifacts which would describe the first alternative IADAS solution.

a. Functional Analysis

A functional architecture was generated for the IADAS I system (see Figure 16). This top-down decomposition showed the functions that were performed for a notional IADAS I mission. Similar to the ADAS mission, the IADAS I mission is decomposed into the Perform Initial Reconnaissance and Compose Damage Assessment functions. However, with the use of the RPA, there are also Dynamic Assessment and Data Analysis functions. These functions are further decomposed to Observe and Perform

Visual Inspection, RPA Scan of Airfield Damage, RPA Scan of Airfield UXO, Automated Analysis, Visual Analysis, Formatting of The report, and Transmission of the Report.

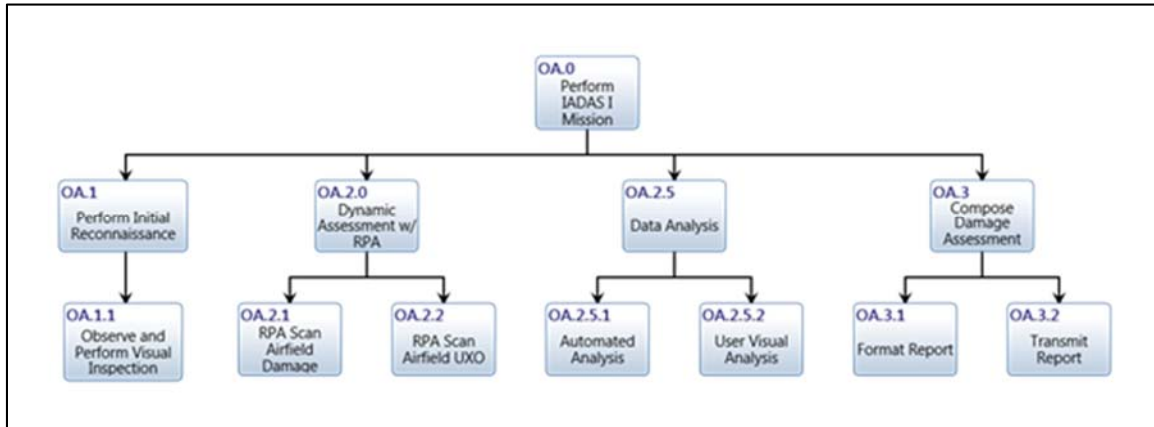

Figure 16. IADAS I Mission Functional Architecture Hierarchy Chart

Figure 17 shows the EFFBD for the IADAS I. The overall mission is the same as the baseline ADAS; however, there is an additional step included in order to analyze the data being collected by the RPA. This is seen in Block 2.5 in Figure 17. The raw assessment data is used from the initial reconnaissance and dynamic assessment with the RPA and used for data analysis and to compose the damage assessment report. The data analysis step includes parallel efforts of computer algorithm analysis and a user visual analysis to determine the extent of damage and UXO. The output of the damage assessment report includes information of the threat such as size, damage type, location, and quantity.

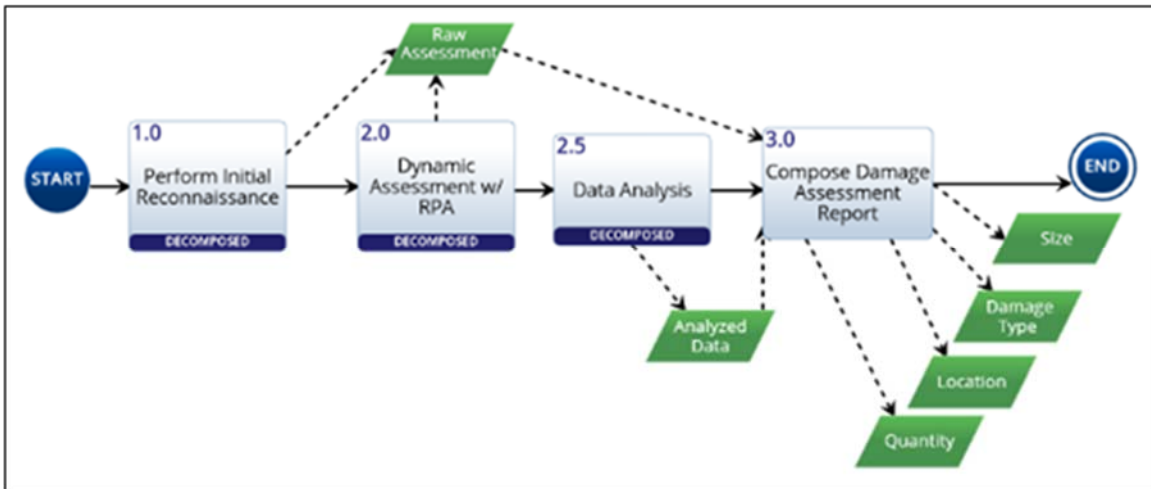

Figure 17. IADAS I EFFBD

The next step in developing the functional architecture was to decompose all of the functions into the IDEF0 format. The IDEF0 diagram of the IADAS I shows the data flow, system control, and overall functional flow. Controls to the IADAS I include the Base Alarm, EOC Communication, Detection Algorithm, and Raw Assessment Data. The input include the Visual UXO Observation Data, Visual Damage Observation Data, Visual Airfield data, and the Programmed Flight information, while the outputs include the Analyzed Data, Compiled Report, Quantity, Location, Size, and Damage Type. The mechanisms included in IADAS I are Observation, Trained Personnel, Day Camera, and ADAT. Figure 18 shows the IDEF0 diagram of the IADAS I.

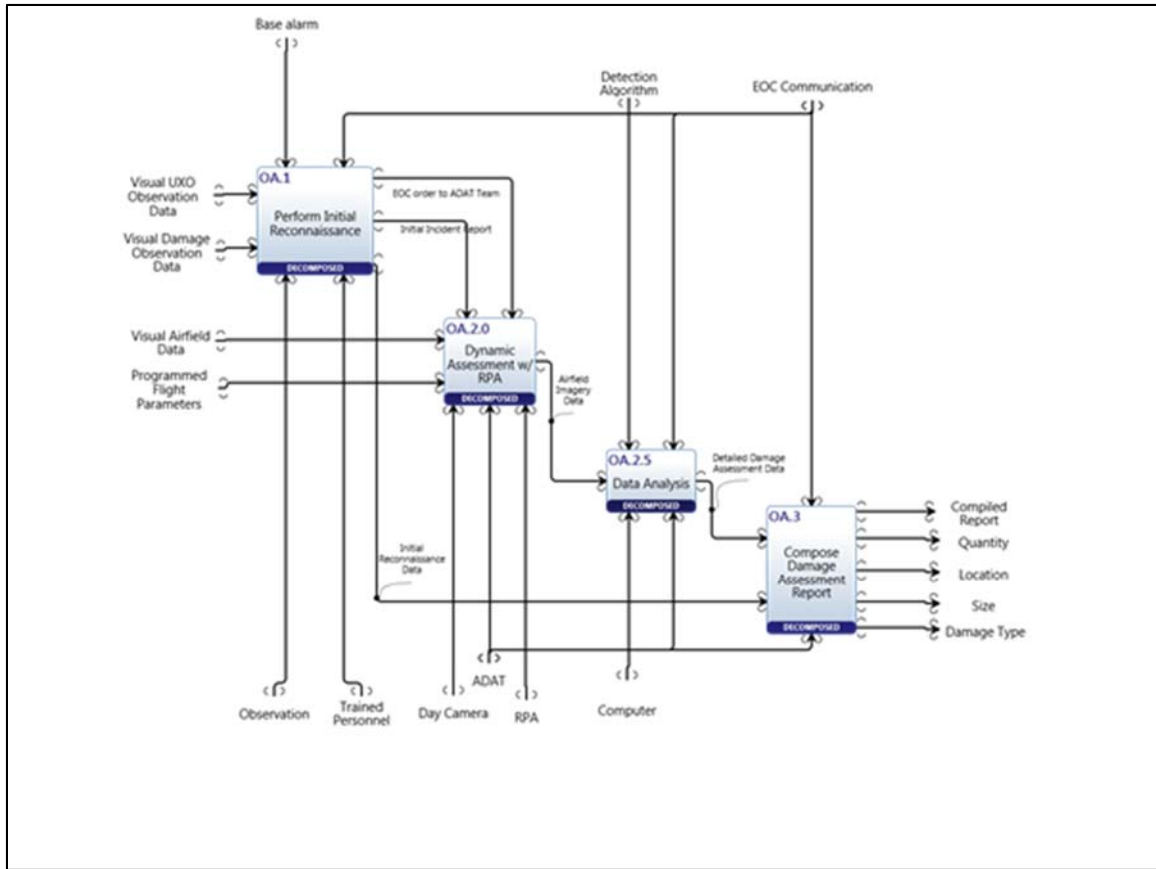

Figure 18. IADAS I IDEF0 Diagram

Following construction of the IDEF0 diagram, it was necessary to analyze the timeline of events for the IADAS I functional process. The sequence of events occurs between the ADAT, Algorithm Processing Computer, EOC, RPA Operator, RPA Flight Control, and the Day Camera. The EOC initiates the ADAT Deployment Order to the ADAT. The ADAT then sends the Programmed Flight Path Data and the RPA Launch Order to the RPA Operator to begin their mission. The flights tasks are then provided to the RPA Flight Control. Once in the air, the Day Camera provides a direct feed of Live Imagery onboard the RPA, which is relayed as Raw Assessment Data to the ADAT and Algorithm Processing Computer. The computer processes this information and provides Algorithm Analyzed Data to the ADAT who then compile the report and provide it to the EOC. The sequence diagram can be seen in Figure 19.

b. Physical Architecture

There are four main components in the physical architecture for the IADAS I system. The main categories are: mechanism, sensor, data processor, and communication. Extracting the data associated with the highest score from the Pugh matrix in [Table 14](#), option 4 provides the physical architecture subcomponents for IADAS 1. The elements are described in Table 15.

Table 15. IADAS I Physical Architecture

Mechanism	Sensor	Data Processor	Communication
RPA (Puma AE RQ-20B)	Day Camera (Zenmuse X5S)	CPU	Digital Data Link (DDL)

The Puma AE (All Environment) RQ-20B was selected based on the inherent capabilities of the system and how these capabilities would lend to a reasonable solution for the IADAS I system. This system is fully waterproof, small, and designed for land or maritime operations. The Puma AE has an enhanced precision navigation system with a secondary GPS to provide greater positional accuracy and reliability (AeroVironment 2017). The Puma AE was upgraded with a Zenmuse X5S camera capable of capturing 21 megapixel images in order to capture very high resolution imagery of the surveyed area (DJI 2017b). This camera has been successfully integrated onto other types of RPAs including the DJI Inspire 2 RPA to capture high resolution imagery (DJI 2017a). The RPA cameras in general will not be exposed to all the weather conditions like the tower cameras and will only be exposed to various weather conditions during flight operations.

In searching for an appropriate CPU, the analysis led the team to specify a high-end computer with the versatility of a laptop. After performing an extensive search, the resulting selection was for a Hewlett Packard (HP) ZBook 17 G4 Mobile Workstation. The website (Hewlett Packard 2017) provided the ability to select the platform with the highest memory (16GB) along with the highest storage (1TB) in order to process large file sizes due to the high resolution images planned for that hardware. In addition, since

the primary goal of the platform would be to evaluate images, a graphics card and image processor with significant capability was selected.

Once the physical architecture was determined, the next step in the process was to complete the CONOPS diagram, visually displaying how the components work together to provide the system operation.

c. CONOPS

Figure 21 provides the CONOPS for IADAS I. The steps below correspond to the numbers in Figure 21.

1. Observers at the Observation points relay initial damage reconnaissance to EOC (1a) and concurrently the on/remote site EOC orders dynamic assessment utilizing representative RPA equipped with day camera (1b)
2. RPA day camera begins predetermined survey scan to gather detailed damage and UXO data
3. RPA imagery analyzed using specific algorithms at the EOC; report on Bomb and Bomblet Fields
4. RPA imagery analyzed using specific algorithms at the EOC; report on UXO and Craters.
5. RPA imagery analyzed using specific algorithms at the EOC; report on Camouflet and Spall damage.
6. Data reported to EOC includes; location, shape, color, markings, coordinates, render-safe time. The software will create a shapefile with a summary of all the damage and UXO locations that will be transferred via network connection to the GeoExPT operator for import into GeoExPT.

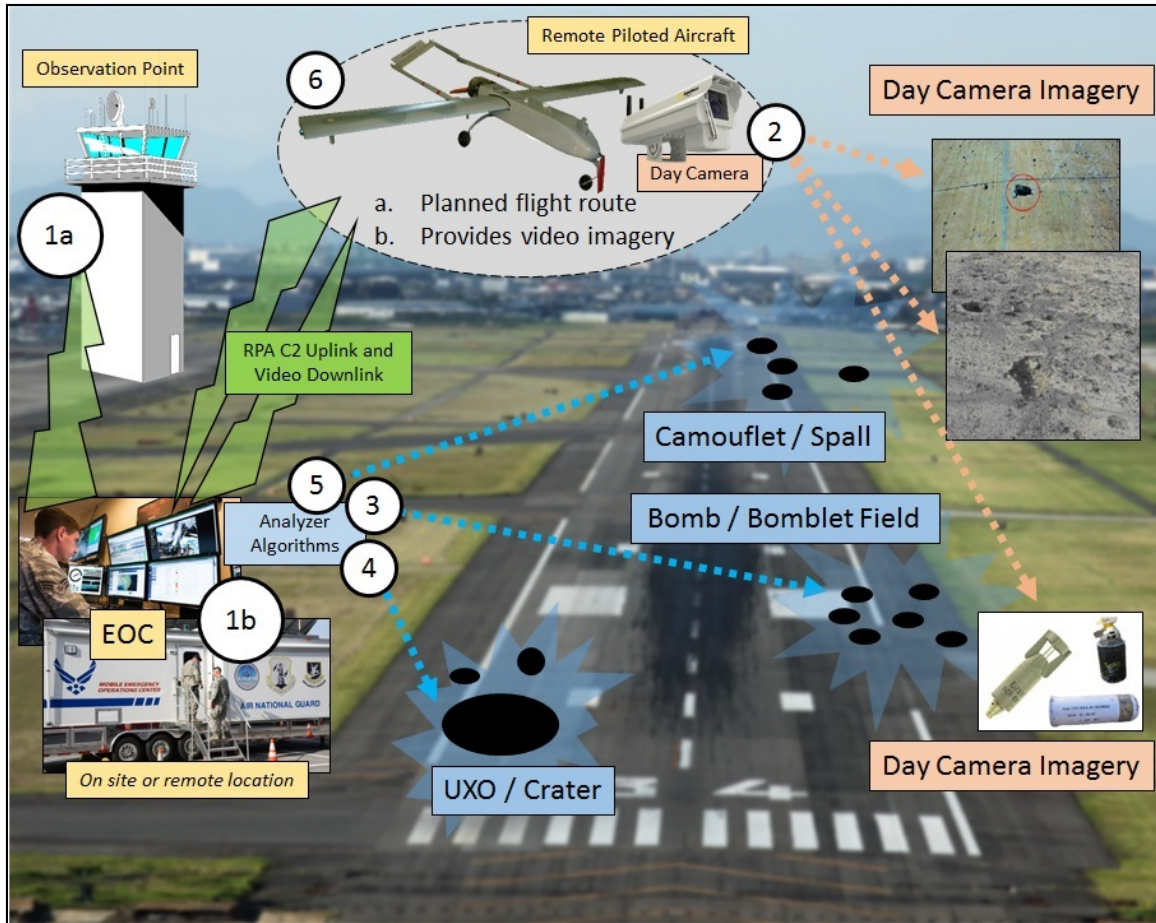

Figure 21. IADAS I CONOPS

3. IADAS II

The next step in the SE process was to define the various artifacts which would describe the second alternative IADAS solution.

a. Functional Analysis

A functional architecture was generated for the IADAS II system (see Figure 22). This top-down decomposition showed the functions that were performed for a notional IADAS II mission. Similar to the previous alternative, the IADAS II system decomposes the IADAS II mission to the same four functions: Perform Initial Reconnaissance, Perform Dynamic Assessment, Data Analysis, and Compose Damage Assessment. Further refinement and decomposition allow this mission to be performed by a Tower in

subsequent functions. The level three functions include Observe and Perform Visual Inspection, Tower Scan of Airfield Damage, Tower Scan of Airfield UXO, Automated Analysis, User Visual Analysis, Formatting of the Report, and Transmission of the Report.

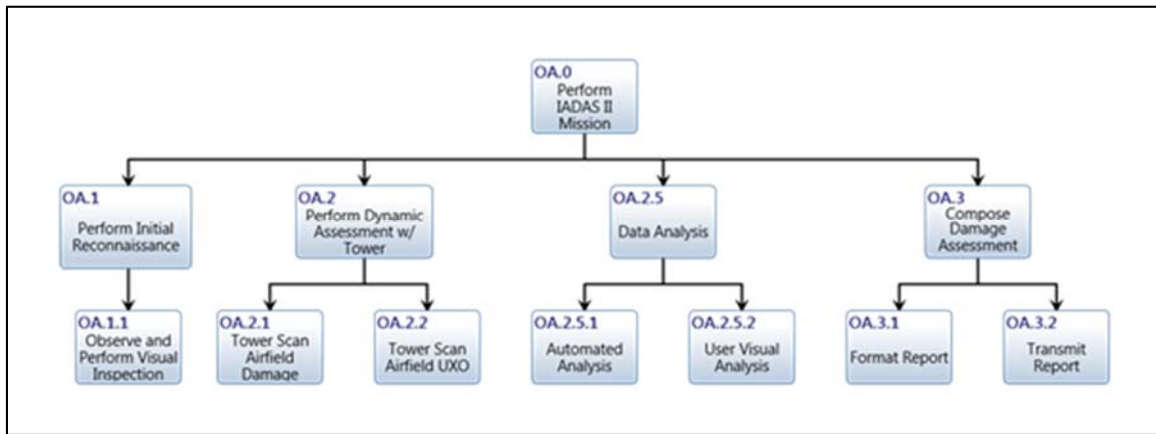

Figure 22. IADAS II Mission Functional Architecture Hierarchy Chart

Figure 23 shows the EFFBD for the IADAS II. The overall mission is the same as the baseline ADAS; however, there is an additional step included in order to analyze the data being collected by the Tower. This is a similar process as the IADAS I alternative. This is seen in Block 2.5 in Figure 23. The raw assessment data is used from the initial reconnaissance and dynamic assessment with the Tower and used for data analysis and to compose the damage assessment report. The data analysis step includes parallel efforts of automated analysis and a user visual analysis to determine the extent of the damage and presence of UXOs. The output of the damage assessment report includes information of the threat such as size, damage type, location, and quantity.

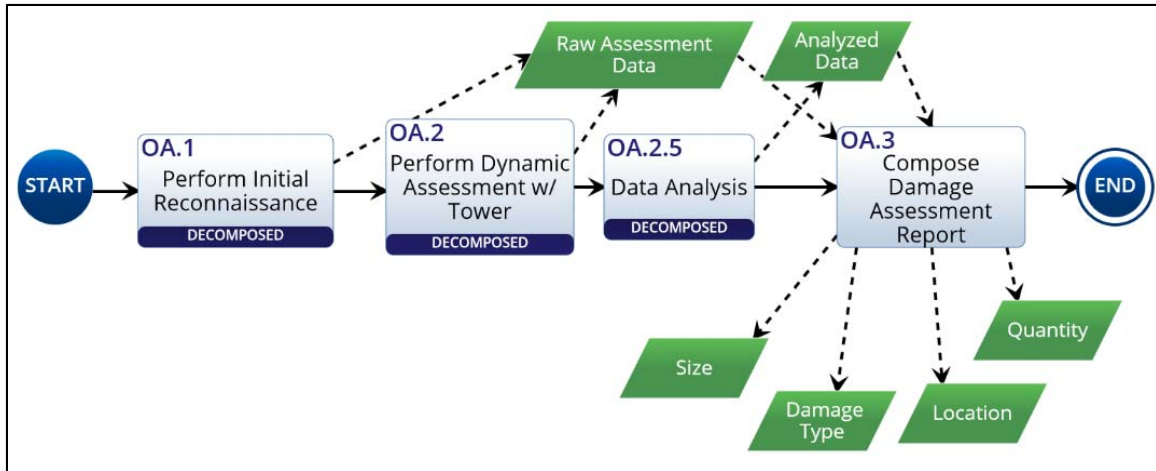

Figure 23. IADAS II EFFBD

The next step in developing the functional architecture was to decompose all of the functions into the IDEF0 format. The IDEF0 diagram of the IADAS II shows the data flow, system control, and overall functional flow. Controls for the IADAS II include the Base Alarm, EOC Communication, Raw Assessment Data, and the Detection Algorithm. The input includes the Visual UXO Observation Data, Visual Damage Observation Data, the Predetermined Scan Area, and the Visual Airfield Data. Outputs include the Analyzed Data, Compiled Report, Location, Quantity, Size, and Damage Type. The mechanisms used in IADAS II are Observation, Trained Personnel, Tower, Day Camera, Computer, and the ADAT. Figure 24 shows the IDEF0 diagram of the IADAS II.

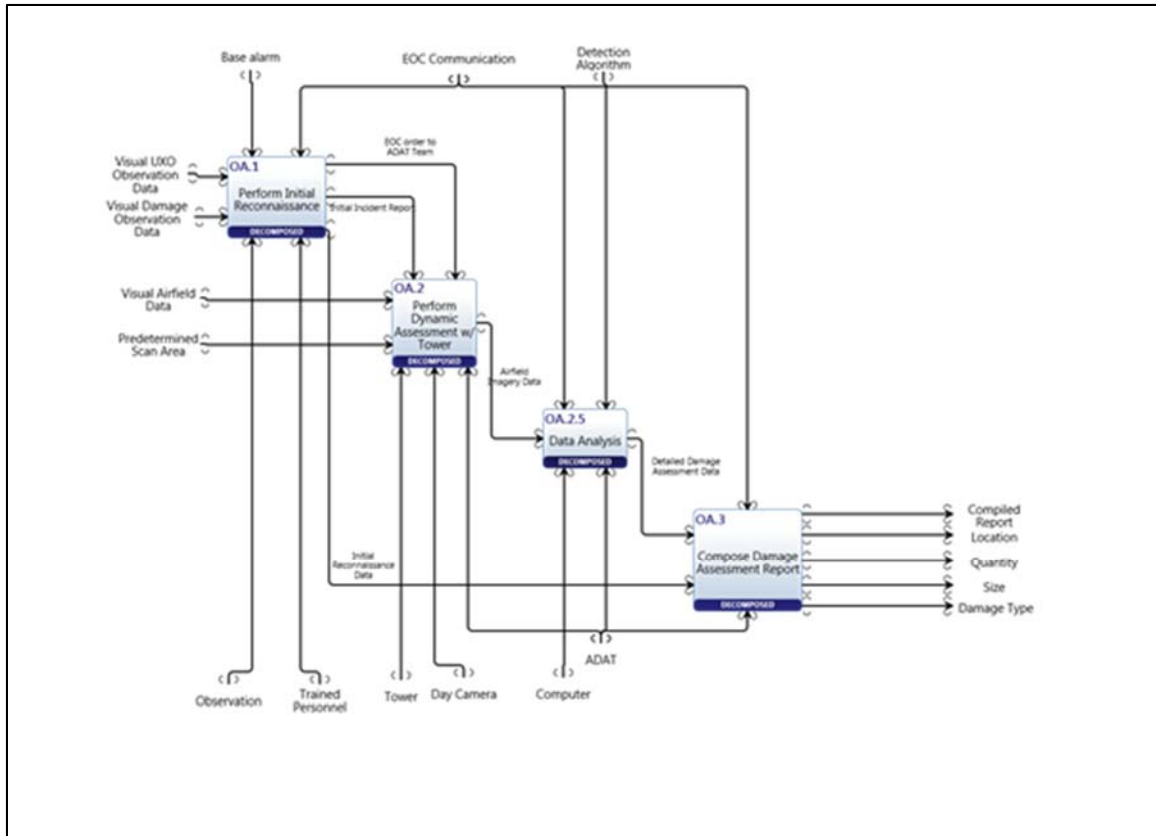

Figure 24. IADAS II IDEF0 Diagram

Following construction of the IDEF0 diagram, it was necessary to analyze the timeline of events for the IADAS II functional process. The functions used in the decomposition of the sequence are the ADAT, Algorithm Processing Computer, EOC, Tower, and Day Camera. The EOC sends the ADAT Deployment Order to the ADAT. The predetermined scan area is provided to the Tower which uses the scan coordinates to point the day camera. The Day Camera provides the live imagery to the Tower which provides this information as Raw Assessment Data to the ADAT and Algorithm Processing Computer. The Computer then analyzes this data to produce Algorithm Analyzed Data to the ADAT. The ADAT uses this information to then compile the report and provide it to the EOC. The sequence diagram can be seen in Figure 25.

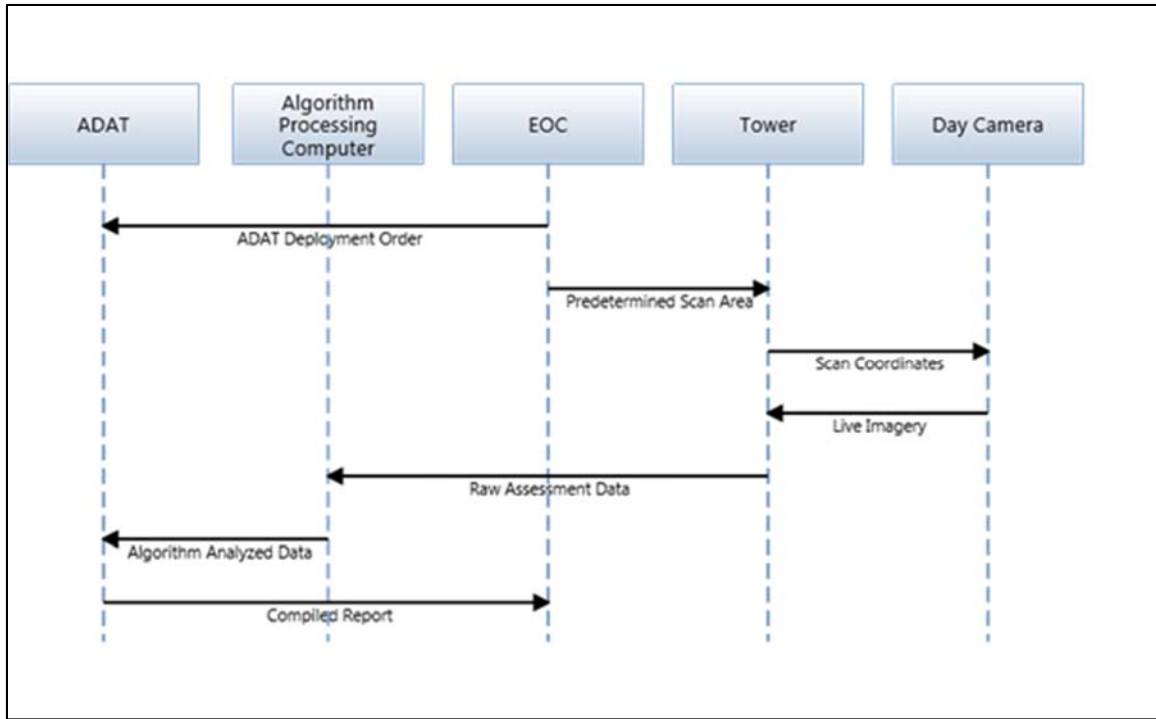

Figure 25. IADAS II Sequence Diagram

Breaking down the activity further was a class diagram to describe the IADAS II classes. The classes included attributes, operations, and parameters which were used to illustrate the relationship between classes, or assets. This is shown in Figure 26.

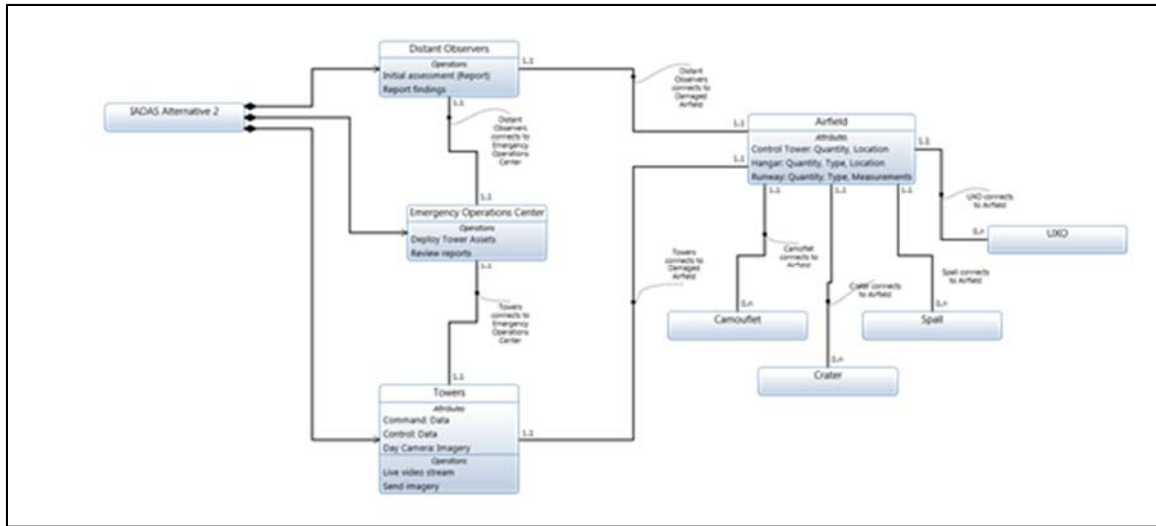

Figure 26. IADAS II Class Diagram

b. Physical Architecture

Similar to the physical architecture for IADAS I, IADAS II was selected from the second-highest scoring alternative in the Pugh matrix in [Table 14](#). Option #16 was selected, and is described in Table 16.

Table 16. IADAS II Physical Architecture

Mechanism	Sensor	Data Processor	Communication
Stationary Tower	Day Camera	CPU	Wireless

The stationary towers selected are produced by Rohn Products LLC and are 15.2 m (50 ft) free standing tower kits (25SS040) (Solid Signal, Signal Group LLC & Affiliates n.d.). Based on the DRM, the 1730 m (5,676 ft) runway will require 15 towers and the 1981.2 m (6,500 ft) runway will require 17 towers for a total of 32 towers. Each tower will be placed for enough away from the runway to prevent any adverse interaction with aircraft.

In searching for an appropriate CPU, the analysis led the team to specify a high-end computer with the versatility of a laptop. After performing an extensive search, the

resulting selection was for an HP ZBook 17 G4 Mobile Workstation. The *HP Store website* (Hewlett Packard 2017) provided the ability to select the platform with the highest memory (16GB) along with the highest storage (1TB) in order to process the enormous images planned for that hardware. In addition, since the primary goal of the platform would be to evaluate images, a significant graphics card and image processor was selected.

The camera selected is a 4k security camera that offers ultra-high definition (HD) video recording resolution and is internet protocol (IP) accessible from a network computer. This camera uses the “latest Progressive Scan Impact Sensor to produce 12 megapixel video at up to 15 fps or 4k ultra HD” (CCTV Camera World Inc. 2015). These cameras had the highest resolution commercially available at the time of researching based on being able to withstand different types of continual environmental conditions that can be encountered in the field and are designed to be mounted on towers and buildings with little or no modification. An additional feature is that the 4k Ultra HD allows an operator to digitally zoom with “the highest amount possible before pixilation occurs” (CCTV Camera World Inc. 2015). This can be very useful when trying to identify the type of UXO or the extent of damage.

Once the physical architecture was determined, the next step in the process was to complete the CONOPS diagram, visually displaying how the components work together to provide the system operation.

c. CONOPS

Figure 27 provides the CONOPS for IADAS II. The steps below correspond to the numbers in Figure 27.

1. Observers at the Control tower/observation points relay initial damage reconnaissance to the EOC (1a) and concurrently EOC orders dynamic assessment utilizing day camera and wireless sensors (1b)
2. Tower day camera begins predetermined survey scan to gather detailed damage and UXO data

3. Tower imagery analyzed using specific algorithms at the EOC report on Bomb and Bomblet Fields
4. Tower imagery analyzed using specific algorithms at the EOC report on UXO and Craters
5. Tower imagery analyzed using specific algorithms at the EOC report on Camouflet and Spall damage
6. Data reported at the EOC includes; location, shape, color, markings, coordinates, render-safe time. The software will create a shapefile with a summary of all the damage and UXO locations that will be transferred via network connection to the GeoExPT operator for import into GeoExPT.

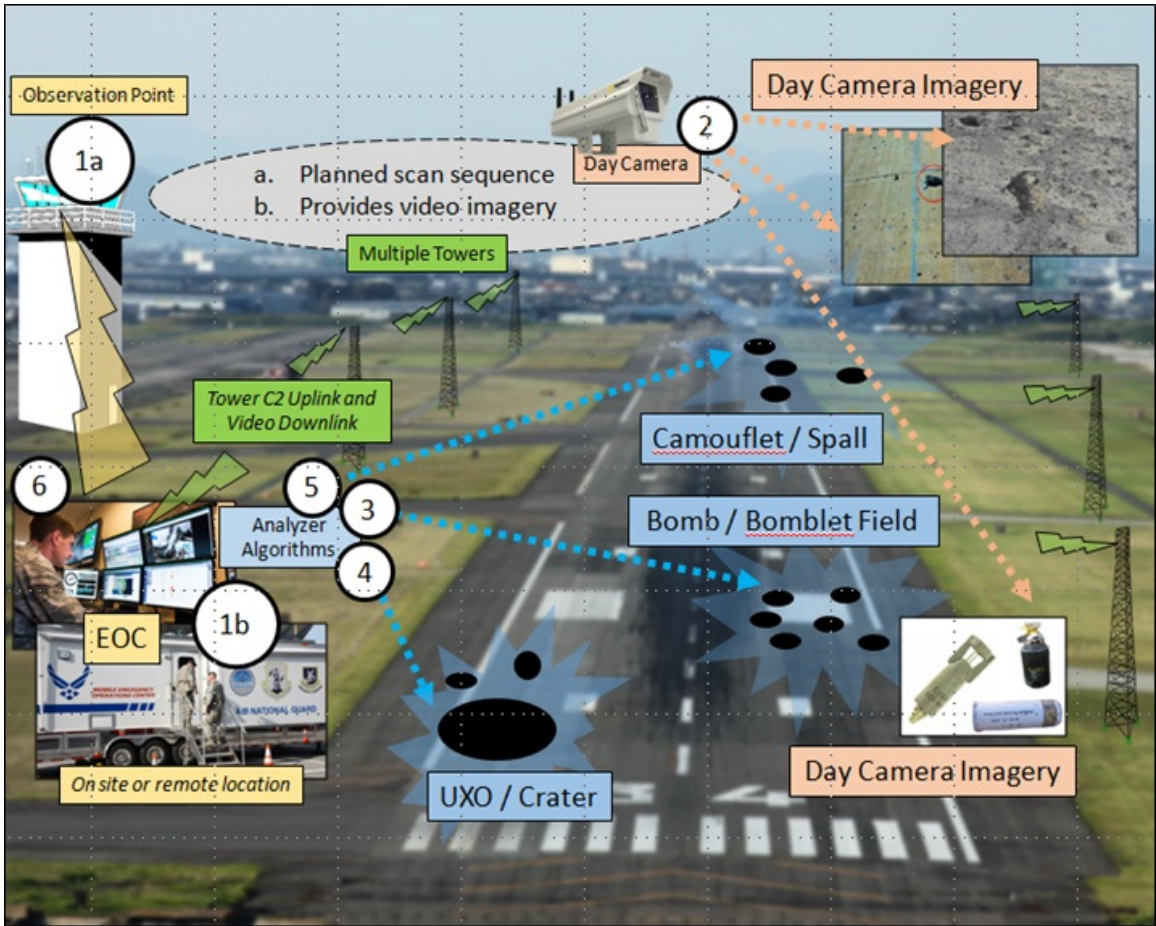

Figure 27. IADAS II CONOPS

IV. SYSTEMS EVALUATION

A. INTRODUCTION

In order to best determine a viable alternative, the decomposed architectures from Chapter III were modeled using the ExtendSim tool and the resulting simulations run to estimate the MOEs for each alternative. By implementing the alternatives as ExtendSim models, a Monte Carlo approach could be used to allow for randomness in user behavior. In this chapter, the ExtendSim model analysis, model inputs, metrics, and cost analysis are discussed.

Limited validation and verification of the ExtendSim models was performed due to the compressed timelines of the project, lack of available information, and lack of funding. Since the ADAS operation is completely manual (drive to airfield location, dismount to damage location, manual measurement of width/depth), the team based assessment times on approximations for a two-man crew to measure a crater and/or assess UXO and move onto the next location.

When developing the IADAS I model, the imagery collection parameters were heavily dependent upon the flight characteristics of the RPA, selected camera resolution, and system image requirements. Recommendations for image collections and calculations from the DroneMapper Imagery Collection Worksheet (Drone Mapper 2015b) were integrated into the ExtendSim model to validate the RPA and camera settings needed for the required imagery resolution (5 cm/pixel). This enhanced the confidence in the IADAS I model with respect to the times allocated to collect the required imagery based on the selected UAS and camera combinations. Using free Drone Mapper RAPID photogrammetric imagery processing software (Drone Mapper 2015a) and sample data provided by Drone Mapper (Drone Mapper 2017), the sample data was processed. Even though the software did have limitations, the time measured to process the sample imagery provided confidence that the IADAS I image processing times input into the model appeared to be feasible. No similar software was available to provide an estimation for the time required to process the imagery for the IADAS II system. The increased

difficulties in processing the poorer images due to the poor angle and less camera resolution were reflected when modelling the IADAS II model image processing time.

B. CURRENT ADAS

1. ExtendSim Model Analysis

Discrete event simulation and analysis of the collected simulation data was used to evaluate the estimated effectiveness of the current ADAS. The current ADAS was modeled using ExtendSim Software (see Figure 28 and [Figures C-4 through C-6](#)). The ExtendSim model was based on the process outlined from the functional analysis and CONOPS found in Chapter III.

The model simulated a single ADAT travelling in an HMMWV detecting, classifying, measuring, and reporting runway damage and UXO along a predetermined route. In addition to the time required to perform the assessment, the simulation also incorporated the time delay for the ADAT team to travel from their staging location to the start of the predetermined survey route. The staging area and predetermined assessment route is shown in [Figure 29](#).

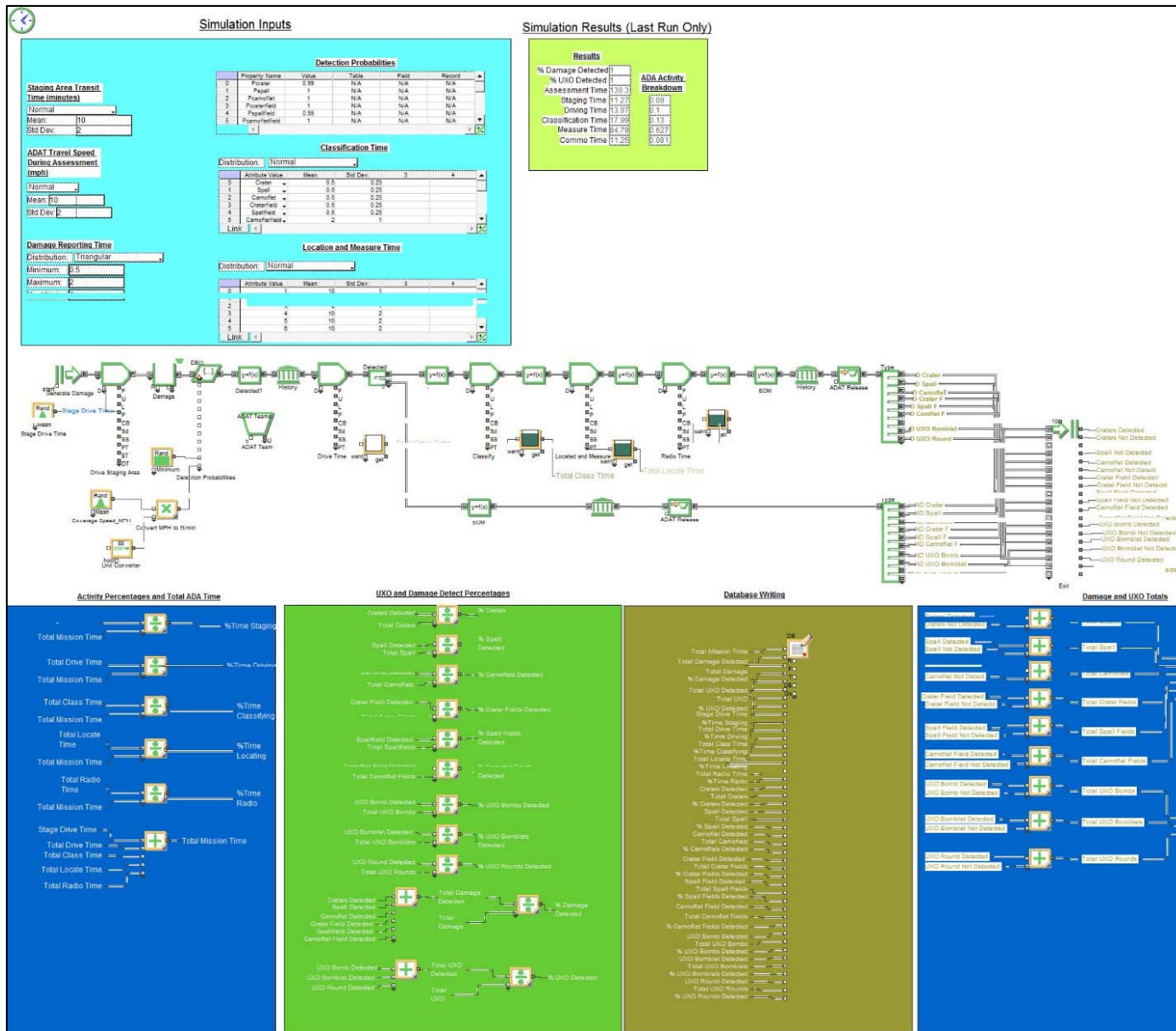

Figure 28. Current ADAS ExtendSim Model

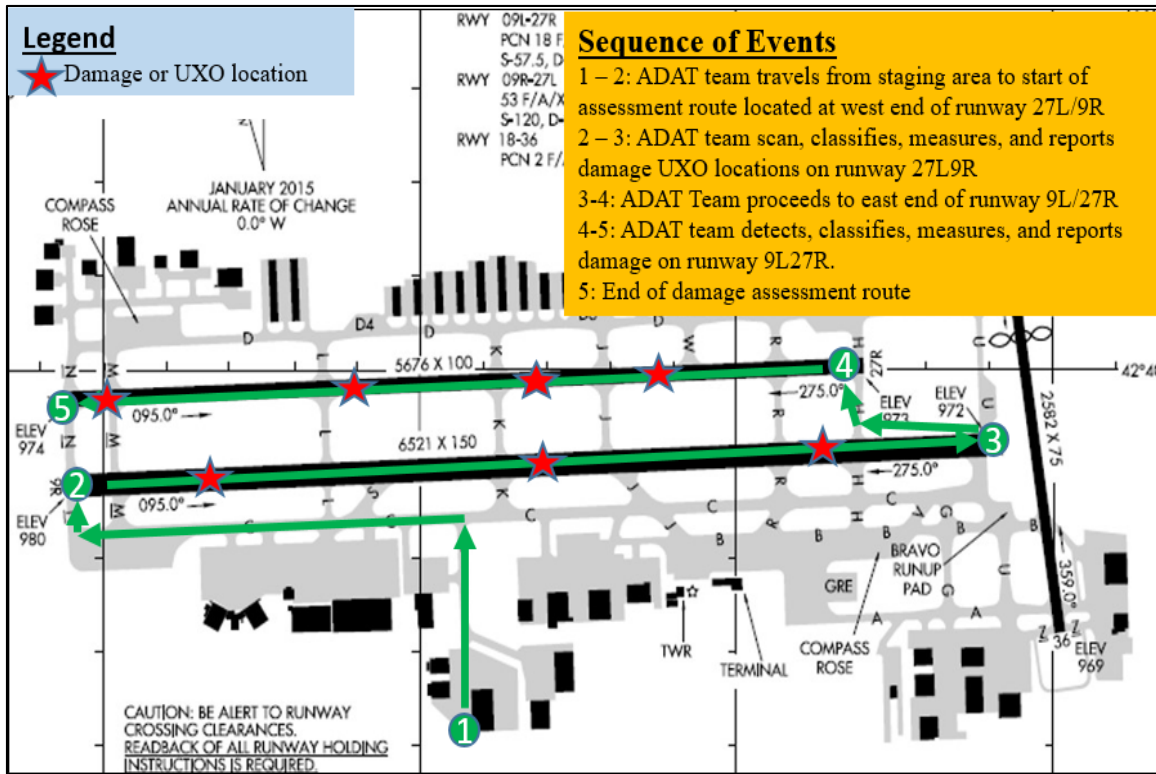

Figure 29. ADAT Travel Route. Adapted from Aircraft Owners and Pilots Association (2017).

The damage and unexploded ordnance incorporated into the model was based on the DRM outlined previously and is summarized in Table 17. Because the DRM is based on an expeditionary attack, the intent is to focus on the bare minimum runway surfaces necessary to resume sortie traffic. It should be noted that assessing all taxiways and ramp areas would increase the total time to complete a thorough assessment.

Table 17. Model Inputs: DRM Damage and UXO Types and Quantities

Damage/UXO Type	Quantity
Small Craters	15
Large Craters	4
Spall Fields	1
UXO Bomblets	13

The model as built allowed for the input of six different types of damage and three types of UXO. The probability of detection, classification time, and measurement time for each damage and UXO type were estimated based on input from subject matter experts and engineering judgement and shown in Table 18.

Table 18. Model Inputs: Damage and UXO Detection and Measurement

Damage/ UXO Type	Description	Probability of Detection	Classification Time (min)			Measurement Time (min)		
			Dist.	Mean	SD	Dist.	Mean	SD
Small Crater	< 10 foot diameter	0.95	Normal	0.5	0.1	Normal	2	0.33
Large Crater	> 10 foot diameter	1	Normal	0.5	0.1	Normal	10	2
Spall	Spall type damage	0.95	Normal	0.5	0.1	Normal	2	0.33
Camouflet	Camouflet type damage	0.9	Normal	0.5	0.1	Normal	1	0.25
Crater Field	Field of 20+ craters located in close proximity	1	Normal	0.25	0.1	Normal	15	2
Spall Field	Field of 20+ spalls located in close proximity	1	Normal	0.25	0.1	Normal	10	2
UXO-Bomblet	Submunition	0.9	Normal	2	0.25	Normal	3	1
UXO-Bomb	Large aircraft type bomb	0.95	Normal	2	0.5	Normal	2	0.5
UXO-Round	Mortar/Artillery Round	0.9	Normal	2	0.25	Normal	3	1
NOTES: SD - Standard Deviation Dist - Distribution Type								

Travel time for the ADAT team from the staging location to the start of the predetermined route and the rate at which ADAT team could travel and visually search for damage/UXO during the actual assessment were also estimated and input into the model (see Table 19).

Table 19. Model Inputs: Staging Time, Assessment/Travel Speed, and Reporting Times

Input	Description	Distribution	Mean	Standard Deviation
Staging Travel Time (minutes)	Time to travel from staging area to start of damage assessment route	Normal	10	2
ADAT Travel Assessment Speed (miles per hour)	Average speed of vehicle during damage assessment	Normal	20	2
Assessment Report Time (minutes)	Time to transmit damage/UXO report at each location	Triangular	0.5 minimum, 1.5 Maximum, 1 most likely	

Several MOEs were outputs of the simulation model and were used to evaluate the effectiveness of the current ADAS method. These MOEs were selected to allow a comparison of the effectiveness between the three systems. The selected MOEs used throughout the simulation and analysis are presented in Table 20 and described in detail.

Table 20. Current ADAS Effectiveness/Performance Measures and Metrics

MOEs	Metrics
% Airfield Damage Assessed	Airfield Damage Assessed/Total Airfield Damage
% UXO Assessed	UXO Detected/Total Airfield UXO
Airfield Damage Assessment Time	Time from end of airfield attack to completion of ADA
Travel/Detection Time	Total ADAT time spent travelling/detecting damage and UXO
Classification Time	Total ADAT time spent classifying damage and UXO
Measure Time	Total ADAT time spent measuring and locating damage
Communication Time	Total ADAT time spent communicating damage results to EOC

% Airfield Damage and % UXO Assessed. The mission of the ADA is to provide a detailed damage and UXO assessment to the EOC to support determination of repair

efforts, therefore, these are the primary MOEs of concern. Failure to assess the majority of damage/UXO results in mission failure.

Airfield Damage Assessment Time. The mission of the ADA is to provide a detailed damage and UXO assessment as quickly as possible so runway repair activities can commence. A faster ADA time provides an indication that one system may be more capable than another.

Travel/Detection Time. This MOE estimates how much time it takes to transit the assessment route scanning for damage. A faster travel/detection provides an indication that one system may be more capable than another.

Classification Time. This MOE estimates how much time it takes to classify damage and UXO. A faster classification time provides an indication that one system may be more capable than another.

Measure Time. This MOE estimates how much time it takes to determine the location and measure the size of the damage or UXO. A faster measure time provides an indication that one system may be more capable than another.

Communication Time. This MOE estimates how much time it takes to communicate the location and the size of the damage or UXO. A faster measure time provides an indication that one system may be more capable than another.

The model was run 500 times for statistical significance and to also model system variability. The collected simulation data was analyzed at the conclusion of the simulation and the results are shown in Table 21.

Table 21. Current ADAS Effectiveness/Performance Measures

Measure	Average	95% Confidence Interval	Min	Max
% Damage Assessed*	95.3%	[94.9 , 95.7]	73.7	100.0
% UXO Assessed*	95.4%	[94.8 , 95.9]	71.4	100.0
Airfield Damage Assessment Time*	174.2	[173.5 , 175]	147.2	195.3
Staging Transit Time (minutes)	10.0	[9.9 , 10.2]	3.2	16.1
Assessment Travel/Detection Time (minutes)	6.7	[6.7 , 6.8]	5.8	8.0
Assessment Classification Time (Minutes)	31.3	[31.1 , 31.4]	23.4	35.3
Assessment Measure Time (minutes)	94.6	[94.1 , 95.2]	68.5	111.5
Assessment Comm Time (minutes)	29.3	[29.1 , 29.4]	26.3	35.8
NOTE: * Measure of Effectiveness as described in Table 9				

The effectiveness of the ADAT team in assessing UXO and damage is very high which is not surprising as the damage and UXO in the DRM should not be hard to identify with the ADAT team surveying damage from very close distances. Also expected was the long overall duration of the assessment which is due to the very low automation and serial process in which the process must be conducted.

2. Cost Analysis

The first step in determining the cost associated with the current ADAS, was to determine which costs were considered. Using the cost methodology previously defined, the costs were: R&D, SE, Personnel, and O&S. Both the R&D and SE costs were \$0 for the ADAS system. The reasoning for this was based on the fact that the current system is a completely manual process. Personnel costs include barracks and base salary for five personnel. Since these are shared resources, only a portion of the total personnel cost is considered for ADAS purposes. The O&S cost includes annual training, transport, maintenance, and fuel. Table 22 breaks down the estimated costs associated with ADAS.

Table 22. ADAS Cost Estimate

Type of Cost	Description	Cost
R&D	Shared between all Resources	\$0
SE	System Engineering expenses for defining the system	\$0
Personnel	Barracks = \$1.2M, 10% for ADAT	\$120K
	Salary = \$500K/yr, 20% for ADAT over 10 yrs	\$1000K
O&S		
Transportation	HMMWV = \$220K, 20% for ADAT	\$44K
Maintenance	Annual Training = \$500K, since same for all three options for personnel (\$10K/year/ADAT team member – five personnel per team)	\$500K
	Transport Maintenance = According to a RAND study (Pint, et al. 2008) the cost is about \$5.53/mile. Estimate 10K miles/year = \$55.2K/year for maintenance. Ten years = \$550K, 20% for ADAT	\$110K
	Fuel = HMMWV average 8 MPG on the highway and 4 MPG in the city (Richard 2008). Using the average of 6 MPG, and 20% of 10K miles/year = 2K miles. For 10 years that is 20K miles. At 6 MPG, that is about 3,334 gallons of diesel fuel. In today's dollars that is about \$2.50/gallon = \$8K	\$8K
Total ADAS Cost		\$1782K

C. IADAS I

1. ExtendSim Model Analysis

Discrete event simulation and analysis of the collected simulation data was used to evaluate the estimated effectiveness of the first IADAS alternative system. The first system alternative was modeled using ExtendSim Software (see Figure 30 and [Figures C-7 through C-9](#)) and was based on the process outlined from the functional analysis and CONOPS found in Chapter III.

As shown in Figure 31, the model simulated an RPA collecting overhead imagery of the runway surfaces that was then transmitted over a digital data link to the RPA ground control station for subsequent analysis by the ADAT. The ExtendSim model incorporated the follow activities and sequence:

- the RPA was launched and travelled from launch site to beginning of predetermined survey route
- the RPA flew predetermined route collecting overhead imagery at predetermined intervals and transmitted imagery via digital data link to the RPA ground control station
- the imagery was processed into a single orthomosaic image by the ADAT
- the imagery was analyzed by the ADAT using software that automatically detected, classified, and measured damages
- verification of the automated damage assessment was performed manually by ADAT personnel to verify results and eliminate false detections
- manual review of the orthomosaic image was conducted by ADAT personnel to identify damage that was missed by the automated damage assessment

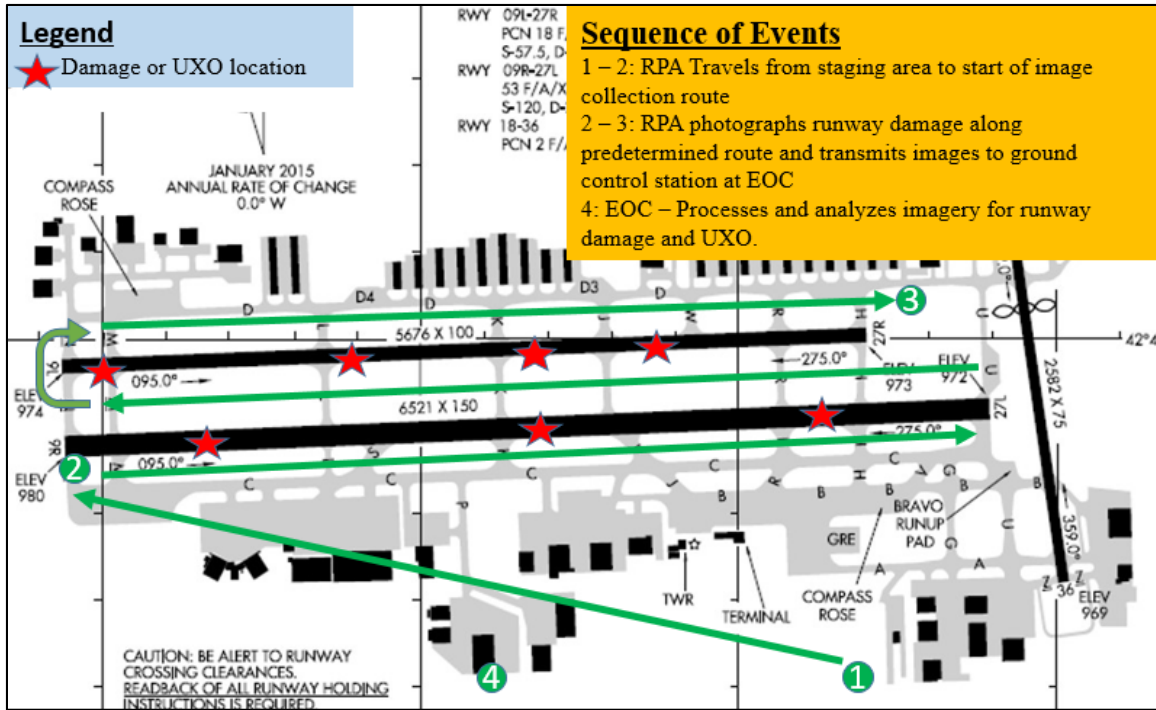

Figure 32. IADAS I Sequence of Events. Adapted from Aircraft Owners and Pilots Association (2017).

The quantity and location of damage and UXO incorporated into the model was based on the DRM outlined previously and is summarized in Table 23.

Table 23. IADAS I Model Inputs: DRM Damage and UXO Types and Quantities

Damage/UXO Type	Quantity
Small Craters	15
Large Craters	4
Spall Fields	1
UXO Bomblets	13

The model as built allowed for the input of different types of damage, RPA flight characteristics, camera characteristics, detection probabilities, and estimated activity times as shown in Tables 24 through 27. The camera specifications and imagery

collection parameters were chosen based on achieving a ground sampling distance of 5 cm/pixel in order to maximize the probability of detecting very small UXO bomblets.

Table 24. IADAS I Model Inputs: RPA Camera Specifications

RPA Camera Specifications	
Image (Pixel Width)	5280
Image – (Pixel Height)	3956
Focal Plane Width (mm)	18
Focal Plane Height (mm)	13.5
Lens Focal Length (mm)	10

Table 25. IADAS I Model Inputs: RPA Imagery Collection

Imagery Collection	
RPA Ground Speed (mph)	30
Flight Height (m)	30
Area Survey Length (m) per run	2134
Area Survey Width (m) per run	305
Forward Image Overlap (%)	60
Side Image Overlap (%)	40

Table 26. IADAS I Model Inputs: Activity/Parameters

Activity/Parameter	Distribution	Mean	SD
RPA Launch and Transit Parameters			
RPA Prep and Launch Time (minutes)	Normal	5	1
Distance - Staging Area to Start of Run (meters)	Constant	2000	N/A
RPA Transit Speed from Staging Area (miles per hour)	Constant	30	N/A
Automated Software Processing Times			
Orthomosaic Creation (minutes)	Normal	15	2
Auto detection of Damage/UXO (minutes)	Normal	5	1
Verification of Auto Detection Result Timelines			
Large Crater (minutes)	Normal	0.08	0.02
Small Crater (minutes)	Normal	0.08	0.02
Camouflets (minutes))	Normal	0.33	0.04
Craterfield (minutes)	Normal	0.16	0.02
Spallfield (minutes)	Normal	0.16	0.02
UXO - Bomb (minutes)	Normal	0.33	0.04
UXO - Bomblet (minutes)	Normal	0.5	0.1
UXO - Round (minutes)	Normal	0.33	0.04
Spall (minutes)	Normal	10	0.02
Manual Review of Imagery			
Review of Imagery (minutes)	Normal	5	1
Individual Damage/UXO Location Classification Time (minutes)	Normal	0.5	0.1
Individual Damage/UXO Location Measurement Time (minutes)	Normal	0.5	0.5

Table 27. IADAS I Model Inputs: Automated and Manual Detection Probabilities

Damage/UXO Type	Description	Automated	Manual
Small Crater	< 3 m (10 ft) diameter	0.8	0.8
Large Crater	> 3 m (10 ft) diameter	0.9	0.8 ¹
Spall	Spall type damage	0.85	0.8
Camouflets	Camouflets type damage	0.7	0.8
Crater Field	Field of 20+ craters located in close proximity	0.95	0.9
Spall Field	Field of 20+ spalls located in close proximity	0.95	0.9
UXO - Bomblet	Submunition	0.7	0.8
UXO - Bomb	Large aircraft type bomb	0.6	0.6
UXO - Round	Mortar/Artillery Round	0.7	0.8
NOTE: Probabilities associated with manual review of imagery reflect the operator performing a quick review of the imagery versus a detailed assessment.			

Outputs from the simulation model were utilized to evaluate the effectiveness of the IADAS I system. The selected measures used throughout the simulation and analysis are presented in Table 28 and described in detail.

Table 28. IADAS I Simulation Outputs

MOEs	Metrics
% Damage Assessed*	Airfield Damage Detected/Total Airfield Damage
% UXO Assessed*	UXO Detected/Total Airfield UXO
Airfield Damage Assessment Time*	Time from end of airfield attack to completion of airfield damage assessment
Staging Transit Time (minutes)	Time from end of airfield attack to time RPA arrives at start of survey route
Survey Time (minutes)	Total RPA time spent collecting imagery data
Image Processing Time (minutes)	Total software runtime processing images into orthomosaic
Auto detection Run Time (minutes)	Total Software runtime for auto detection of damage/UXO
Verification Time (minutes)	Total time verifying auto detection results and elimination of false detections
Manual Scan Time (minutes)	Total time for operator to review orthomosaic for damage not identified by auto detection software.
Manual Classification Time (minutes)	Total time for manual classification of damage/UXO
Manual Measurement Time (minutes)	Total time for measurement of damage/UXO
Note: * Measure of Effectiveness as described in Table 9	

The model was run 500 times for statistical significance and to also model system variability. The collected simulation data was analyzed at the conclusion of the simulation and the results are shown in Table 29.

Table 29. IADAS I Simulation Output Results

Output	Average	95% Confidence Interval	Min	Max
% Damage Assessed*	96.8%	[96.5 , 97.1]	80.00%	100.00%
% UXO Assessed*	83.9%	[83 , 84.8]	46.15%	100.00%
Airfield Damage Assessment Time*	52.07	[51.8 , 52.3]	41.9	60.9
Staging Transit Time (minutes)	7.5	[7.4 , 7.6]	4.4	9.9
Survey Time (minutes)	8.4	[8.4 , 8.4]	7.8	8.7
Image Processing Time (Minutes)	15.1	[14.9 , 15.2]	8.6	19.9
Autodetection Run Time (minutes)	5.0	[4.9 , 5.1]	1.7	7.9
Verification Time (minutes)	5.3	[5.3 , 5.4]	2.8	8.3
Manual Scan Time (minutes)	5.0	[4.9 , 5.1]	2.3	8.1
Manual Classification Time (minutes)	2.9	[2.8 , 3]	0.5	6.5
Manual Measurement Time (minutes)	2.9	[2.8 , 3]	0.4	6.6
NOTE: * Measure of Effectiveness as described in Table 9				

The effectiveness of the IADAS I system in assessing UXO and damage was greater than 80%. A lower percentage of total UXO was detected when compared to damage, which was expected due to the much smaller size of the UXO bomblet dud munitions (less than 6 in) in the DRM.

2. Cost Analysis

The cost analysis for the first IADAS alternative was broken down into four components: R&D, SE, Personnel, and O&S costs. Each cost component contributed to the overall cost of designing, developing, and maintaining the system through ten years of maintenance and operations. The summation of those costs provided the stakeholders with an understanding of the 10-year system life cycle cost. The R&D, along with the SE cost analysis, was performed using COSYSMO. A Person-Month of \$10K/month was used. For the software cost model, an analogous model to other academic exercises using RPAs was used. An estimate of 11,000 new Source Lines of Code (SLOC) 4,000 reused SLOC, 25% integration required, and 3% Assessment and Assimilation values were used.

The detailed description for each category is captured in Table 30. Screenshots of the COSYSMO tool are shown in Appendix C, [Figures C-10 through C-13](#).

Table 30. IADAS I COSYSMO SE Inputs/Assumptions

# Requirements =	11 Functional Requirements
	Three Easy
	Six Nominal
	Two Difficult-Detect Camouflet, ID UXO
# System Interfaces =	Three System Interfaces
	Difficult-ADAT to RPA via remote control
	Nominal-RPA to CPU via wireless
	Nominal-CPU to EOC via wireless
# Algorithms =	Seven Algorithms
	Easy-Flight operations
	Nominal-Image Capture
	Nominal-Data Transfer
	Nominal-Crater Size Determination
	Nominal-Crater Location Determination
	Difficult-UXO Type Determination
	Nominal-UXO Location Determination
# Operational Scenarios =	Two Operational Scenarios
	Difficult-UXO Classification
	Nominal-Damage Determination

The Software Cost Drivers were set to “Nominal” with the following exceptions:

- the Requirements Understanding, Architecture Understanding, and Stakeholder Team Cohesion parameters were set to “High,”
- the # of Recursive Levels in the Design parameter was set to “Low,” and
- the Multisite Coordination parameter was set to “Very Low.”

The resulting cost estimate for the first two components of IADAS I (Systems Engineering and Software Development) is shown in Figure 33.

Components		
RPA		
Day Camera		
Wireless Communication		
CPU		
System Engineering Cost		
Effort	21.7	Person-Months
Schedule	4.1	Months
Cost	\$216,926	
Maintenance Cost		
Annual Maintenance Effort	1.9	Person-Months
Annual Maintenance Cost	\$18,893	
Total Maintenance Cost (10 Yr)	\$188,935	
Software Costs		
Effort	42.8	Person-months
Schedule	12.7	Months
Cost	\$428,018	
Software Maintenance Cost		
Annual Maintenance Effort	3.2	Person-months
Annual Maintenance Cost	\$38,813	
Total Maintenance Cost (10 Yr)	\$388,137	
Total Cost, Option 2		
System Engineering + Software Cost + All Maintenance =		\$1,222,016

Figure 33. IADAS I Cost Modeling Summary

The next cost that was defined in the cost model was for personnel. A two-man crew is needed to operate a Puma. The other component requiring personnel support would be the manual confirmation of the analysis performed by the software. This would add an additional two resources to the personnel total, which brought it to a total of four personnel.

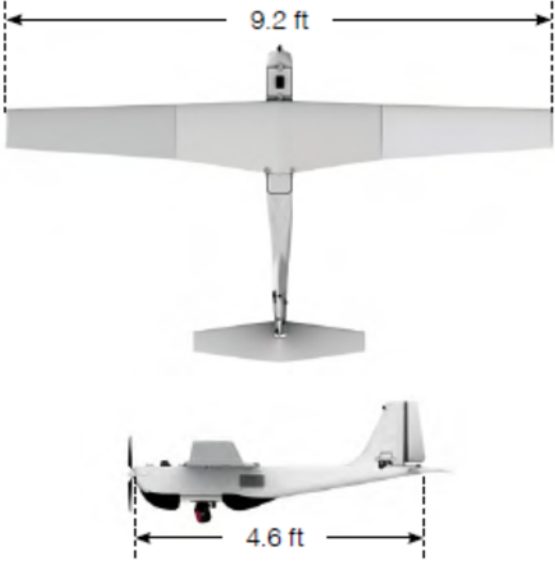

The final component for the cost analysis was the O&S costs. Table 31 contains the results of the search for the necessary components.

Table 31. IADAS I O&S Costs

Item	Cost	Picture
RPA (Puma AE RQ-20B)	<p>\$250,000 (AeroVironment 2017)</p> <p>Complete air system includes three air vehicles, two ground control stations, and support equipment</p>	

Continued next page.

Table 31. Continued from previous page.

Item	Cost	Picture
Zenmuse Camera	\$6,000 (DJI 2017c) For three units	
CPU (laptop)	\$7,278 (Hewlett Packard 2017) For two units	
Maintenance (RPA – 10 years – three units) (CPU – 10 year – two units) (Camera – 10 year – three units)	\$125,000 \$4,163 \$10,000	
Total	\$2,944K	

Using a similar table from the total costs for the ADAS system, IADAS I costs have been summarized in the Table 32.

Table 32. IADAS I Cost Estimate

Type of Cost	Description	Cost
R&D	Software to perform automated analysis	\$428K
SE	System Engineering expenses for defining the system	\$217K
Personnel	Barracks = \$1.2M, 10% for ADAT	\$120K
	Salary = \$400K/yr, 20% for ADAT over 10 yrs	\$800K
O&S		
Hardware	PUMA and Laptop	\$257K
Maintenance	Annual Training = \$400K, since same for all three options for personnel (\$10K/year/ADAT team member – four personnel per team)	\$400K
	RPA 10 Year Maintenance	\$125K
	CPU 10 Year Maintenance	\$4K
	SW 10 Year Maintenance	\$388K
	SE 10 Year Maintenance	\$189K

The total expense for IADAS I was \$2,928,000.

D. IADAS II

1. ExtendSim Model Analysis

Discrete event simulation and analysis of the collected simulation data was used to evaluate the estimated effectiveness of the second IADAS alternative system. The system alternative was modeled using ExtendSim Software (see Figure 34 and [Figures C-14 through C-16](#)) and was based on the process outlined from the functional analysis and CONOPS found in Chapter III.

The model simulated imagery being collected by static cameras mounted on 32 observation towers to collect imagery of the runway surfaces that was then transmitted over a wireless network to the ADAT processing computer for subsequent analysis by the ADAT. The ExtendSim model incorporated the follow activities and sequence:

- thirty-two cameras mounted on 50 ft. towers would take an image of a given length of runway (400 ft. per camera)
- image data from each cameras was transmitted via wireless network to the ADAT processing computer
- imagery was processed by the computer to allow geospatial data to be extracted from image
- the imagery was analyzed by the ADAT using software that automatically detected, classified, and measured damage
- verification of the automated damage assessment was performed manually by ADAT personnel to verify results and eliminate false detections
- manual review of the imagery was conducted by ADAT personnel to identify damage that was missed by the automated damage assessment

The damage and UXO incorporated into the model was based on the DRM outlined previously and is summarized in Table 33.

Table 33. IADAS II Model Inputs: DRM Damage and UXO Types and Quantities

Damage/UXO Type	Quantity
Small Craters	15
Large Craters	4
Spall Fields	1
UXO Bomblets	13

The model as built allowed for the input of different types of damage, image size of 12 mega pixels, detection probabilities, and estimated activity times as shown in Tables 34 and 35. Some activity times and probabilities of detection vary between the IADAS I and IADAS II systems. The imagery taken by the IADAS I system is of higher quality due to better camera image resolution and benefits from an optimal camera viewing angle as the RPA flies directly over the target and captures imagery orthogonally. In contrast, the IADAS II system utilized a camera with less image resolution and is mounted on a tower at a 30–45 degree viewing angle.

Table 34. IADAS II Model Inputs: Activity/Parameters

Activity/Parameter	Distribution	Mean	SD
Wireless Network			
Average Wireless Data Speed (Mb/S)	Uniform	10	20
Automated Software Processing Times			
Geospatial Processing (minutes)	Normal	15	2
Auto detection of Damage/UXO (min)	Normal	10	1
Verification of Auto Detection Result Timelines			
Large Crater (min)	Normal	0.08	0.02
Small Crater (min)	Normal	0.08	0.02
Camouflet (min)	Normal	0.33	0.04
Craterfield (min)	Normal	0.16	0.02
Spallfield (min)	Normal	0.16	0.02
UXO - Bomb (min)	Normal	0.33	0.04
UXO - Bomblet (min)	Normal	0.5	0.1
UXO - Round (min)	Normal	0.33	0.04
Spall (min)	Normal	10	0.02
Manual Review of Imagery			
Review of Imagery (min)	Normal	10	1
Individual Damage/UXO Location Classification Time (min)	Normal	0.5	.05
Individual Damage/UXO Location Measurement Time (min)	Normal	0.5	0.1

Table 35. IADAS II Model Inputs: Automated and Manual Detection Probabilities

Damage/UXO Type	Description	Automated	Manual
Small Crater	< 3 m (10 ft) diameter	0.7	0.75
Large Crater	> 3 m (10 ft) diameter	0.8	0.75
Spall	Spall type damage	0.5	0.6
Camouflets	Camouflets type damage	0.5	0.5
Crater Field	Field of 20+ craters located in close proximity	0.8	0.8
Spall Field	Field of 20+ spalls located in close proximity	0.8	0.8
UXO - Bomblet	Submunition	0.6	0.7
UXO - Bomb	Large aircraft type bomb	0.4	0.5
UXO - Round	Mortar/Artillery Round	0.5	0.6
NOTE: The probabilities are lower with IADAS II when compared to IADAS I due to lower quality imagery with respect to resolution and angle.			

Outputs from the simulation model were utilized to evaluate the effectiveness of the IADAS II system. The selected measures used throughout the simulation and analysis are presented in Table 36 and described in detail.

Table 36. IADAS II Simulation Outputs

MOEs	Metrics
% Damage Assessed	Airfield Damage Detected/Total Airfield Damage
% UXO Assessed	UXO Detected/Total Airfield UXO
Airfield Damage Assessment Time (minutes)	Time from end of airfield attack to completion of airfield damage assessment
Image Data Transmit Time (Minutes)	Time to transmit all camera images
Image Processing Time (Minutes)	Total software runtime processing images to extract geospatial data
Auto detection Run Time (minutes)	Total Software runtime for auto detection of damage/UXO
Verification Time (minutes)	Total time verifying auto detection results and elimination of false detections
Manual Scan Time (minutes)	Total time for operator to review imagery for damage not identified by auto detection software.
Manual Classification Time (minutes)	Total time for manual classification of damage/UXO
Manual Measurement Time (minutes)	Total time for measurement of damage/UXO
NOTE: * Measure of Effectiveness as described in Table 9	

The model was run 500 times for statistical significance and to also model system variability. The collected simulation data was analyzed at the conclusion of the simulation and the results are shown in Table 37.

Table 37. IADAS II Simulation Output Results

MOEs	Average	95% Confidence Interval	Min	Max
% Damage Assessed*	93.0	[92.5 , 93.5]	75.0	100.0
% UXO Assessed*	70.3	[69.2 , 71.5]	23.1	100.0
Airfield Damage Assessment Time (minutes)	47.2	[46.9 , 47.5]	37.8	56.2
Image Data Transmit Time (minutes)	0.3	[0.3 , 0.3]	0.2	0.4
Image Processing Time (Minutes)	15.0	[14.8 , 15.2]	8.2	22.2
Autodetection Run Time (minutes)	10.0	[9.9 , 10.1]	7.1	12.6
Verification Time (minutes)	3.9	[3.8 , 4]	1.3	6.8
Manual Scan Time (minutes)	10.0	[9.9 , 10.1]	6.9	12.6
Manual Classification Time (minutes)	4.0	[3.9 , 4.1]	0.4	8.0
Manual Measurement Time (minutes)	4.0	[3.9 , 4.1]	0.4	7.6
NOTE: *Measure of Effectiveness as described in Table 9				

2. Cost Analysis

The cost analysis for the second IADAS alternative was broken down into the same four components: R&D, SE, personnel, and O&S costs. The SE effort was performed using COSYSMO. The inputs and assumptions entered into the model were as shown in Table 38. Screenshots of the COSYSMO tool are shown in Appendix C, [Figures C-17 through C-19](#). The number of personnel necessary to support the IADAS II concept was reduced, as compared to both ADAS and IADAS I. In the IADAS II concept, there were only two ADAT personnel needed. The reasoning was that the system was nearly completely automated, and that there was only the requirement for manual validation of the damage size, damage location, UXO identification, and UXO location after the software performed its function.

Table 38. IADAS II COSYSMO SE Inputs/Assumptions

# Requirements =	11 Functional Requirements
	Three Easy
	Six Nominal
	Two Difficult-Detect camouflaged, ID UXO
# System Interfaces =	Two System Interfaces
	Nominal-Stationary Tower to CPU via Wireless
	Nominal-CPU to EOC via wireless
# Algorithms =	Six Algorithms
	Nominal-Image Capture
	Nominal-Data Transfer
	Nominal-Crater Size Determination
	Nominal-Crater Location Determination
	Difficult-UXO Type Determination
	Nominal-UXO Location Determination
# Operational Scenarios =	Two Operational Scenarios
	Difficult-UXO Classification
	Nominal-Damage Determination

A Person-Month of \$10K/month was used. For the software cost model, an estimate of 4,000 new SLOC 2,000 reused SLOC, 25% integration required, and 3% Assessment and Assimilation values were used with all software scale drivers set to “Nominal.” The Software Cost Drivers were set to “Nominal” with the following exceptions:

- the Required Software Reliability, Developed for Reusability, and Use for Software Tools parameters were set to “High,”
- the Database Size, Product Complexity, and Platform Volatility parameters were set to “Low,” and
- the Multisite Development parameter was set to “Very Low.”

Maintenance considerations included annual change size of 300 Equivalent SLOC (ESLOC)/year, software understanding set to 35%, and software unfamiliarity set to 0.2. The resulting cost estimate for IADAS II is shown in Figure 35.

Components		
Stationary Towers		
Day Camera		
Wireless Communication		
CPU		
System Engineering Cost		
Effort	13.3	Person-Months
Schedule	3.5	Months
Cost	\$133,085	
Maintenance Cost		
Annual Maintenance Effort	1.2	Person-Months
Annual Maintenance Cost	\$11,591	
Total Maintenance Cost (10 Yr)	\$115,912	
Software Costs		
Effort	12.6	Person-months
Schedule	8.5	Months
Cost	\$125,726	
Software Maintenance Cost		
Annual Maintenance Effort	0.7	Person-months
Annual Maintenance Cost	\$7,418	
Total Maintenance Cost (10 yr)	\$74,184	
Total Cost, Option 1		
System Engineering + Software Cost + All Maintenance =		\$448,907

Figure 35. IADAS Option II Cost Modeling Summary

The final cost component for IADAS II was the summary of hardware components which were brought together to reflect those costs. Table 39 summarizes the costs. The use of stationary towers required assumptions on the quantity. After reviewing the requirements, towers were specified to be 121.9 m (400 ft) apart, at a height of 15.2 m, (50 ft), so that the color cameras had an adequate view of the area to be inspected. With the DRM specifying a 1730 m (5,676 ft) runway and 1987.6 m (6,521 ft) runway, this required a total of 32 towers to cover the necessary surface area. The all-weather day camera would then be suspended from the height of 15.2 m, (50 ft). One additional component was added from a maintenance perspective, and that was a motorized cherry picker so that a crew could access those cameras for repair and/or replacement. The total expense for IADAS II was \$1,436,000. [Table 40](#) provides the IADAS II Cost Estimate.

Table 39. IADAS II O&S Costs

Item	Cost	Picture
Stationary Towers (\$880 each) (Solid Signal, Signal Group LLC & Affiliates n.d.)	\$29,920 32 towers with two spares	
Tower Installation (\$1,600 each, 8 hours assembly, four personnel, guy-wire attachment, and securing)	\$51,200	

Continued next page.

Talbe 39. Continued from previous page.



Item	Cost	Picture
Cherry Picker (maintenance) (Aerial Titans n.d.)	\$62,900	
Day Cameras (\$1,196 each) (CCTV Camera World Inc. 2015)	\$47,838 with eight spares	
CPU (Hewlett Packard 2017)	\$7,278 with one spare	
Maintenance (Towers, 10 yr) (Day Cameras, 10 Yr) (CPU, 10 yr)	\$11,968 \$47,838 \$7,278	
Total	\$224,834	

Table 40. IADAS II Cost Estimate

Type of Cost	Description	Cost
R&D	Software to perform automated analysis	\$126K
SE	System Engineering expenses for defining the system	\$133K
Personnel	Barracks = \$1.2M, 10% for ADAT	\$120K
	Salary = \$200K/yr, 20% for ADAT over 10 yrs	\$400K
O&S		
Hardware	Towers & Installation	\$81K
	Cherry Picker	\$63K
	Day Cameras	\$48K
	CPU	\$7K
Maintenance	Annual Training = \$200K, since same for all three options for personnel (\$10K/year/ADAT team member – two personnel per team)	\$200K
	Tower 10 Year Maintenance	\$12K
	Camera 10 Year Maintenance	\$48K
	CPU 10 Year Maintenance	\$7K
	SW 10 Year Maintenance	\$75K
	SE 10 Year Maintenance	\$116K
Total IADAS II Cost		\$1436K

The previous set of data compared the capabilities and cost structure for ADAS, IADAS I, and IADAS II. The next section of the report contains the conclusions drawn from the overall analysis of those resulting data points, and provides a recommendation for which system should be pursued for future consideration.

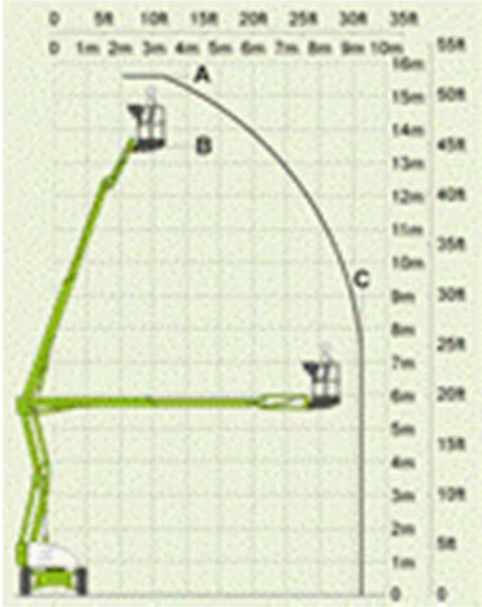
THIS PAGE INTENTIONALLY LEFT BLANK

V. CONCLUSIONS AND RECOMMENDATIONS

A. PROJECT SUMMARY

The overall goal of this report was to investigate the subsystem components that could be brought together in order to meet the requirements for an ADA, build the cost model relevant to the system as a whole, and model the performance to determine the timeframe necessary to complete the mission for a specific DRM. The first step was to define the requirements necessary to meet the needs of an ADAT during the course of executing their mission. The ADAT mission was decomposed into a few simple steps: travel to the site of interest, assess damage site size and location, assess UXO location and identification, and complete the mission by reporting the data to the EOC.

Once the requirements were determined, the next step was to investigate the physical components that could be utilized to create an autonomous system. A morphological box was used to create a table of the elements that would be necessary to complete the system concept. This resulted in 72 different possible combinations. Through a down select procedure using rationale like “a satellite will not be hardwired for communications” and “it is unlikely to replace every runway with embedded sensors,” the possibilities were reduced to 20 options. Using the Pugh matrix, comparing certain options against a known baseline, the top two ranked system configurations were selected.

Several aspects for each system description were defined: functional analysis, physical architecture, and CONOPS. The functional analysis was the most detailed, since several artifacts were necessary to model the system behavior in a later stage of the project. Sequence diagrams, EFFBDs, and IDEF0 diagrams were developed in order to visually describe each system.

The system evaluation for the current ADAS, Alternative #1, and Alternative #2 was next. A model was developed in the ExtendSim tool for each system concept. Input data and variables were set for each condition so that after a statistically significant number of runs (500) in order to generate relevant data to estimate performance of each system alternative. Each model was run against a single DRM, which contained the

parameters such as number and placement of ordinance dropped on the runway of interest, spread of bomblets, and probability of either detonating or becoming classified as UXO in the area of interest.

Cost analysis was done in order to provide the stakeholders with information relevant to each design choice. The development costs were the R&D and SE costs, which went into the design and construction of the systems. The remaining costs, personnel and O&S, were the life cycle cost to keep the systems operational for a 10-year time period. This data provided the one-time cost for developing the system of interest, and then provided the cost to support the system over a 10-year operational period. Although these are not considered significant cost drivers, the loss of a soldier cannot be viewed in the same way. It was estimated by an article in the *New York Times* (Marsh 2007) that the price for a military life was in the order of \$1.7M. This was further broken down into \$500K for the deceased, and \$1.2M for the survivor benefits. Besides the military benefits of restoring sortie operations directly after an attack, the additional benefit of the IADAS system would be to minimize the risk to personnel performing the ADAT role.

The results of all of the cost modeling and simulation runs can be found summarized in Table 41. The values shown reflect the key MOEs for the system and how each solution performed against those measures.

Table 41. Comparison of Results of Cost Modeling and Simulation Runs

MOE	Threshold	Objective	Current System	IADAS I RPA	IADAS II Tower
Percent Damage Assessed	90%	90%	95%	97%	93%
Percent UXO assessed	80%	90%	95%	84%	70%
Damage Assessment Time	45 min	30 min	174 min	52 min	47 min
	Total Cost		\$1782K	\$2944K	\$1426K

Table 42 describes the overall conditions, comparing the current manual operation with those alternatives described in the previous sections of the report. The IADAS Alternative Assessment was provided for the stakeholders to have a high-level view of the performance differences between the three systems performing ADA activities. The merits of each system can be evaluated against each other, and the metrics used to determine “success” against a known DRM. A full Doctrine, Organization, Training, Materiel, Leadership and Education, Personnel, Facilities and Policy analysis for both alternative systems could not be conducted within the time limitations of the project. In order to make as complete a comparison as possible, focus was placed on the development costs (software, systems engineering, and 10-year maintenance) and instantiation costs (hardware, installation, and 10-year maintenance), which could be readily accessed in the timeframe for this report.

Table 42. IADAS Alternative Assessment

Reference	Stakeholder Needs	Met/Not Met		
		Current System	Alternative 1	Alternative 2
1.0	Damage Assessment	95.3%	96.8%	93%
1.1	IADAS shall detect where an airfield has been damaged.	MET	MET	MET
1.2	IADAS shall classify the type of airfield damage.	MET	MET	MET
1.3	IADAS shall locate and measure airfield damage.	MET	MET	MET
2.0	UXO Assessment	95.4%	83.9%	70.3%
2.1	IADAS shall detect UXO on airfield surfaces.	MET	MET	NOT MET
2.2	IADAS shall classify the type of UXO on airfield surfaces.	MET	MET	NOT MET

Continued next page.

Table 42. Continued from previous page.

Reference	Stakeholder Needs	Met/Not Met		
		Current System	Alternative 1	Alternative 2
2.3	IADAS shall provide a location of UXO on airfield surfaces.	MET	MET	NOT MET
2.4	IADAS shall automatically transmit damage and UXO data into GeoExPT.	NOT MET	MET	MET
2.5	IADAS shall not expose personnel to explosive hazards during UXO and damage assessment activities.	NOT MET	MET	MET
3.0	Time Assessment	174.2 minutes	52.1 minutes	47.2 minutes
3.1	IADAS shall complete damage and UXO assessment and reporting in less than 30 minutes (objective)/45 minutes (threshold).	NOT MET	NOT MET*	NOT MET*
*Although neither alternative met the threshold time requirement of 45 minutes, both alternatives were close and significantly better than the current methodology of the current system. The slight differences could be attributed to the resolution of the ExtendSim model.				

B. PROJECT CONCLUSIONS

IADAS I was the clear recommendation to the stakeholders. The system met, or exceeded, the threshold values for both assessing the percent damage and UXO mission parameters. The assessment time did not meet the threshold value (45 minutes) for completing the assessment time, but the overall capability of the system delivers to the intent of significantly reducing the ADA timeframe. For the DRM scenario studied in this project, the current ADAT time was estimated at 174 minutes. The IADAS I completed the simulation in just 52 minutes. The implementation cost for IADAS I was higher than

IADAS II, but the capability and modularity of IADAS I were projected to be significantly more valuable.

IADAS I has a significantly smaller footprint on the airfield of interest and it was easily portable to other airfields as required. This would include a small hardened storage container for the RPA and spares, along with the ground control station. The IADAS II would be significantly larger, having towers placed at fixed intervals along the area of interest. The development cost of IADAS I was significantly larger than that of IADAS II, but once the software product has been completed, the system can be adapted rather easily to a new set of airfield parameters. This was one of the key benefits of the IADAS I alternative.

Further discussion of the value for IADAS I to both the DOD and industry will be continued in the next section of the report.

C. RECOMMENDATIONS FOR FUTURE STUDIES

The complete story for both IADAS I and IADAS II were not able to be fully developed during the timeframe of this report. There are hundreds of different RPA options, and dozens of tower elements that could have been considered. Another complicated variable was the day camera system for either system alternative. Each of these hardware components could have been a separate investigation in its own right. A single alternative was selected and data presented for stakeholder consideration. Future studies may want to vary the camera systems and compare image quality vs. system effectiveness vs. system cost. As the quality of day camera imagery continues to improve, one of the benefits to either IADAS alternatives would be automatic system performance improvement as the current cameras are replaced. In addition, as the processing speed of computers continues to improve, and network communications continue to speed-up, the IADAS alternatives could take advantage of both of these factors. As noted in the computations for IADAS I and IADAS II, communication and processing were significant contributors to the time spent on the overall mission. Without any modifications to the system software, and just migrating to new hardware and communication components, the system may meet/exceed the current threshold values set in this report.

THIS PAGE INTENTIONALLY LEFT BLANK

APPENDIX A. PROGRAMS AND TOOLS

A. EXTENDSIM

ExtendSim is a computer-based mathematical modeling and simulation tool that is used to help predict the behavior or performance on new systems or predict the effect of changes on existing systems. Through ExtendSim, any system or process can be simulated using a scalable, logical, and easy-to-use format (Imagine That Inc. 2016).

According to the manufacturer's website, ExtendSim can perform the following functions:

1. Predict the course and results of certain actions
2. Gain insight and stimulate creative thinking
3. Visualize your processes logically or in a virtual environment
4. Identify problem areas before implementation
5. Explore potential effects of modifications
6. Confirm that all variables are known
7. Optimize operations
8. Evaluate ideas and identify inefficiencies
9. Understand why observed events occur
10. Communicate the integrity and feasibility of your plans (Imagine That Inc. 2016)

B. INNOSLATE

Innoslate is a collaborative online SE tool that provides integrated solutions and is capable of providing full life cycle support from requirements definition and management

to operations and support (SPEC Innovations 2016). Innoslate supports the following SE processes:

- the Model-Based Systems Engineering (MBSE) using industry standards such as systems modeling language (SysML) and IDEF0 thus allowing for end-to-end design, modeling, and traceability.
- the Requirements Management by keeping the whole SE team working on a centralized version of the document
- the Department of Defense Architecture Framework (DoDAF) with an easy to use interface, Innoslate will generate the diagrams, matrix, or reports.
- the Configuration Management is established through full version control of every entity within the model.

C. COSYSMO/COCOMO II

COSYSMO is a model used to estimate the SE effort for large-scale systems and includes both hardware and software. COSYSMO identifies many standard SE tasks and supports the different life cycle phases. COSYSMO is generally used to support the following SE functions: (Massachusetts Institute of Technology 2017)

- reuse in SE
- risk modeling in SE
- the SE schedule estimation
- the SE sizing
- cost modeling

COCOMO II is a model that aids in estimating cost, effort, and schedule for software development. COCOMO II is generally used to support the following decision points:

- making investment or other financial decisions involving a software development effort
- setting project budgets and schedules as a basis for planning and control
- deciding on or negotiating tradeoffs among software cost, schedule, functionality, performance or quality factors
- making software cost and schedule risk management decisions
- deciding which parts of a software system to develop, reuse, lease, or purchase
- making legacy software decisions such as what parts to modify, phase out, or outsource. (Center for Systems and Software Engineering 2017)

THIS PAGE INTENTIONALLY LEFT BLANK

APPENDIX B. INSTITUTIONAL REVIEW BOARD QUESTIONS

Personnel to be interviewed: Subject matter experts (military and DOD civilians) who are responsible for conducting airfield damage assessments as well as personnel working on improving current ADA methodology and techniques may be interviewed. This may include personnel from Air Damage Assessment Teams (ADATs), Military Research Centers, and program personnel familiar with the Rapid Airfield Damage Assessment System (RADAS) or other systems in development.

Questions:

1. What airfield damage assessment techniques are currently being used by your group?
2. What techniques provide the most accurate results when compared to actual airfield damage?
3. What technique provides the least accurate results when compared to actual airfield damage?
4. What are the tasks which initiate airfield damage assessment and conclude airfield damage assessment?
5. How many personnel are planned for each sub-activity for airfield damage assessment?
6. Are the sub-activities all performed in serial, parallel, or a mix of both?
7. Are any of the sub-activities prioritized over the other?
8. What factors increase the time required to conduct airfield damage sub activities?

9. Does the current airfield assessment methodology allow for flexibility in the approach for completing tasks during airfield damage assessment? If so, which component of the Damage Assessment Team would make that call?
10. How does the risk of UXO complicate an airfield damage assessment?
11. Are there any documents which detail the baseline requirements and/or methods for airfield damage assessment?
12. What is the average time spent conducting the airfield damage assessment? What factors affect the time required to complete an airfield damage assessment.
13. What are the baseline (threshold and objective) metrics for airfield damage assessment?
14. In what areas can airfield damage assessment be improved?
15. Can you describe how the RADAS system differs from the manual method currently being used?
16. Are there any documents outlining the current RADAS system and its capabilities?
17. Is the RADAS system currently fielded and type classified or still in R&D?
18. What are the baseline (threshold and objective) metrics for the RADAS system? How were these derived?
19. What technologies are being developed that will benefit airfield damage assessment?
20. What factors increase or decrease the difficulty in performing an airfield damage assessment?
21. Has the focus been on improving runway repair time more than improving assessment time? If so, why?

22. Are the manual assessment procedures similar to what they have been since the 1950s? Airfield damage repair has gone through some improvements since the 1950s.
23. What are the main obstacles preventing the Air Force from modernizing the assessment procedures?
24. What is the measure (definition of success) of improvement for airfield damage assessment?

Responses from Airfield Damage Repair Program Manager

1. What is the average time spent conducting the airfield damage assessment? What factors affect the time required to complete an airfield damage assessment. Today with ADAT it takes 2–3 hours. [The] RADAS is expected to get it down to 30–45 minutes.
2. What are the baseline (threshold and objective) metrics for airfield damage assessment? See accompanying slide deck.
3. In what areas can airfield damage assessment be improved? The automated damage declaration.
4. Can you describe how the RADAS system differs from the manual method currently being used? RADAS is intended to eliminate the need for Airman on the ground. It should be an automated system that can feed damage inputs to GeoExPT for the MAOS selection.
5. Are there any documents outlining the current RADAS system and its capabilities? See accompanying slide deck.
6. Is the RADAS system currently fielded and type classified or still in R&D? Still in RDT&E. However, GeoExPT is fielded.
7. What are the baseline (threshold and objective) metrics for the RADAS system? How were these derived? See accompanying slide deck. The requirements started with PACAF, but were validated with an HPT.
8. What technologies are being developed that will benefit airfield damage assessment? Sensors, platforms, and declaration software.
9. What factors increase or decrease the difficulty in performing an airfield damage assessment? Depends on sensor; but thermal cross over, rain, fog, smoke, brass flake.

10. Has the focus been on improving runway repair time more than improving assessment time? If so, why? We've been looking at the holistic problem. Just happened that repair was easier to solve. Although it's A solution, not the THE solution. We are still working to implement efficiencies, and ease the logistics burden.
11. Are the manual assessment procedures similar to what they have been since the 1950s? Airfield damage repair has gone through some improvements since the 1950s. No ADAT is essentially unchanged. We did transition from a simple alpha/numeric grid to MGRS.
12. What are the main obstacles preventing the Air Force from modernizing the assessment procedures? Training, frequencies, who can fly an RPA, data movement, implementing something on the AF GIG.
13. What is the measure (definition of success) of improvement for airfield damage assessment? Making incremental improvements; see accompanying slide deck.

Responses from AFCEC/CXD

1. What airfield damage assessment techniques are currently being used by your group? The current methods include visual observation from the air traffic control tower and employing an airfield damage assessment team comprised of Explosive Ordnance Disposal (EOD) and an Engineering Assistant (EA) personnel. Currently we are testing use of Small Unmanned Aerial Systems (SUAS) to conduct airfield assessments.
2. What techniques provide the most accurate results when compared to actual airfield damage? The physical run of the airfield provides us the most accurate data at this time. However, developing SUAS technologies are proving effective. The downside of having EOD/EA personnel run the airfield is the amount of time required and the exposure of these personnel to the hazards of Unexploded Ordnance (UXO), crater, further enemy attacks.
3. What technique provides the least accurate results when compared to actual airfield damage? The visual observation from the tower or other stand-off method from stationary towers using some form of high speed laser rangefinder devices.
4. What are the tasks which initiate airfield damage assessment and conclude airfield damage assessment? The tasks associated are to rapidly ascertain the amount of damage on the airfield operating surfaces following an enemy attack. This damage includes craters, spall fields, surface and buried (holes of entry) UXO. The final step is using this data to select the best candidate for a Minimum Airfield Operating Strip (MAOS).
5. How many personnel are planned for each sub-activity for airfield damage assessment? The minimum using current methods would be (2) EOD technicians, and (1) EA doing the physical Damage Assessment Team (DAT) run on the airfield (physical size of airfield may warrant employment of additional DAT capability), and another EOD/EA technician in the

Emergency Operations Center (EOC) to assist in plotting the damage and selecting a MAOS. Note: The final selection is a C2 function.

6. Are the sub-activities all performed in serial, parallel, or a mix of both? The sub-activities are performed in parallel.
7. Are any of the sub-activities prioritized over the other? The most critical ADR function (sub-activity) following an attack is completion of the actual airfield assessment. The UXO mitigation and repair activities normally do not start until the MAOS is determined. Note: This could change if the entire 10,000' X 150' runway must be cleared based on mission and CONOPs.
8. What factors increase the time required to conduct airfield damage sub activities? The factors that increase the amount of time is physical size of airfield, amount of damage on the airfield, weather conditions (night/day), smoke clouds from fires/explosions, and number of trained personnel to perform sub activities. (Note: The ability to conduct realistic home-station training and periodic capstone events is paramount).
9. Does the current airfield assessment methodology allow for flexibility in the approach for completing tasks during airfield damage assessment? If so, which component of the Damage Assessment Team would make that call? Under current methods, the call would either be made from the ADAT Team Lead, normally the senior EOD person, or the EOC function.
10. How does the risk of UXO complicate an airfield damage assessment? Depending on the type of ordnance, and growing threat of Anti-Access/Area Denial (A2/AD), the ADAT team is in close proximity to these hazards. This drives the need for an armor platform, and remaining undercover, which has potential to challenge accurate data collection (size of crater, width/depth without physical measurements).
11. Are there any documents which detail the baseline requirements and/or methods for airfield damage assessment? There are baseline documents from

large scale exercises such as Salty Demo in 1985, Spangdahlem Air Base in Germany. There are other Air Force CE Playbooks, and Tactics, Techniques, and Procedures (TTPs) that further define existing baseline requirements. The biggest one is establishing a timeline to complete assessment function, normally 30-minutes from alarm condition BLACK, and initial release of specialized team as directed by EOC C2.

12. What are the baseline (threshold and objective) metrics for airfield damage assessment? The only current base-line I am aware of is the 30-minute time requirement.
13. In what areas can airfield damage assessment be improved? The areas for improvement are using advanced technologies to perform this function versus physical runs of the airfield operating surfaces. This has great potential to reduce time/improve accuracy of collected data.
14. Can you describe how the RADAS system differs from the manual method currently being used? The RADAS incorporates either SUAS platforms or use of fixed sensors on the airfield to collect and report damage information.
15. Are there any documents outlining the current RADAS system and its capabilities? These would be maintained within or Acquisition and Requirements Division (CXA) within the Air Force Civil Engineer Center (AFCEC) Tyndall location. I am unsure if these would be releasable.
16. Is the RADAS system currently fielded and type classified or still in R&D? I believe the system is in RDT&E (use of 3600 dollars), but testing of Commercial off the Shelve (COTS) solutions is in progress. The software piece is the bigger challenge in my opinion. This includes building a 3D digital library of UXO that the software would be able to identify ordnance type to some level of accuracy.
17. What are the baseline (threshold and objective) metrics for the RADAS system? How were these derived? I am uncertain of the specific metrics and

baselines for RADAS besides the time-line. We have been feeding some specific requirements for UXO mitigation. For the immediate solution, the goal is to get ordnance type (similar to information in the Airman's Manual on UXO identification charts) and overall numbers. The future developments could include color and markings, fuze type by function, etc.

18. What technologies are being developed that will benefit airfield damage assessment? The use of SUAS, reducing exposure of personnel. The use of software to assist in the identification of UXO, holes of entry, and surface damage to the airfield. Once information is collected, the system will suggest MAOS based collected data, and mission need (type of aircraft), ultimate selection will still be from a human C2 element.
19. What factors increase or decrease the difficulty in performing an airfield damage assessment? The factors that increase future challenges are cyber threats, and jamming, will our SUAS platforms be capable of operating without interference, and will we have secure communications between RADAS, EOC, UXO mitigation, and repair teams, all of which are critical users of this information. In regards to decreasing difficulty, the emerging technologies in SUAS, delivering high speed cameras, and innovative software that can identify ordnance type, and approximate width/depth of craters and spall fields. The ability to run multiple platforms simultaneous on the airfield will reduce amount of time to complete assessment function.
20. Has the focus been on improving runway repair time more than improving assessment time? If so, why? The previous focus was more on the repair piece of RADR, this was primarily due to the PACAF Advanced Concept and Technologies Demonstration (ACTD), which focused on repair, assessment and UXO mitigation were not included in this initial ACTD. Due to this, repair is several years ahead of assessment/UXO mitigation on development of future technologies for the 2035 threat.

21. Are the manual assessment procedures similar to what they have been since the 1950s? Airfield damage repair has gone through some improvements since the 1950s. Although, the manual assessment procedures are somewhat similar to legacy methods. The differences is using new technologies such as laser range finders, better secure communications with EOC and other ADR teams, and increased protection of teams using improved armor vehicle platforms such as MRAPs and MATVs.
22. What are the main obstacles preventing the Air Force from modernizing the assessment procedures? The main obstacle is technology (although this gap is rapidly closing), and future training requirements. The current SUAS program requires stringent “pilot” certification and robust licensing requirements. I believe we still need to answer if this is an inherent CE capability, or is it a broader Air Force requirement that could be performed by rated pilots. The bottom line is we are users of the collected data ~ who is responsible for that collection is another matter.
23. What is the measure (definition of success) of improvement for airfield damage assessment? The speed and accuracy of the data being collected ~ everything under RADR is based on amount of time to recover the airfield and begin sortie generation, hence the name “Rapid.”

Responses from Executive Officer to the Director of Civil Engineers, Deputy Chief of Staff for Logistics, Engineering and Force Protection, Headquarters U.S. Air Force, Washington, D.C

1. What airfield damage assessment techniques are currently being used by your group? Our units use two methods in concert 1) Counter Rocket and Mortar (CRAM) or similar technology is used to identify the Point of Origin (POO) and Point of Impact (POI); and 2) EOD responds to perform a visual inspection of the POI. Following visual inspection, the EOD team will generally immediately transition to UXO mitigation phase (recon, identify, render-safe and dispose of UXO) and provide real-time feedback to Engineers on any airfield pavement damage that requires repair.
2. What techniques provide the most accurate results when compared to actual airfield damage? Visual inspection of suspected POI using location data obtained by CRAM output.
3. What technique provides the least accurate results when compared to actual airfield damage? Visual inspection without POI data.
4. What are the tasks which initiate airfield damage assessment and conclude airfield damage assessment? Airfield Damage Assessment is initiated when the CRAM alerts incoming Indirect Fire (IDF.) Following impact, EOD takes POI data and responds to impact location. The team conducts a visual inspection to recon, identify, render-safe and dispose of ordnance item. Following UXO mitigation, engineers respond to conduct expedient repair (whether cold asphalt or quick-set concrete patch).
5. How many personnel are planned for each sub-activity for airfield damage assessment? We don't have a standard sub-activity team size. Typically, two EOD technicians (US Army standard team size) respond during damage assessment and UXO mitigation phase; 1–5 military or contractor Engineers participate in the damage repair phase.

6. Are the sub-activities all performed in serial, parallel, or a mix of both? The sub-activities (damage assessment, UXO mitigation and damage repair phases) occur sequentially. Mobilization can occur at the same time, but the steps are performed in serial.
7. Are any of the sub-activities prioritized over the other? None.
8. What factors increase the time required to conduct airfield damage sub activities? Incomplete or no CRAM data. Additional IDF during the process. Darkness. Extreme hot or cold temperatures.
9. Does the current airfield assessment methodology allow for flexibility in the approach for completing tasks during airfield damage assessment? If so, which component of the Damage Assessment Team would make that call? The current methodology used at airbases in Afghanistan is a flexible and well-rehearsed process. Following CRAM output of POI, base recovery decision makers (Senior Airfield Authority or designee) can make assessments of whether to shut down the airfield.
10. How does the risk of UXO complicate an airfield damage assessment? Because of the risk of UXO, EOD always participates in airfield damage assessment. This is not a complicating factor unless multiple events require prioritization of EOD teams to multiple locations on and off the airfield.
11. Are there any documents which detail the baseline requirements and/or methods for airfield damage assessment? Unknown whether our subordinate units use specific documents to detail baseline requirements and/or methods. I assume that TOC/BDOCs are using checklists.
12. What is the average time spent conducting the airfield damage assessment? What factors affect the time required to complete an airfield damage assessment. With reliable CRAM data, airfield damage assessment phase can be done relatively quickly (15 minutes +/-). [The] UXO mitigation phase is depending on the type of UXO and condition it's found. Likewise, airfield

repair phase is depending on the type and severity of damage to pavements and underlying soil structures.

13. What are the baseline (threshold and objective) metrics for airfield damage assessment? Unknown whether our subordinate units use threshold and objective metrics for airfield damage assessment. Because they are conducting real world combat missions from the airfields, the objective is likely to minimize runway down time to limit/eliminate effects on ATO sortie generation.
14. In what areas can airfield damage assessment be improved? Outside of threats commonly found in CJOA-A (primarily IDF), I believe airfield damage assessment needs to be improved in order to combine multiple real time data sources (CRAM or other radar, visual, tower cameras, UAVs, etc.) to identify multiple points of impact. This real time data can be combined with remote assessment techniques (CROWs, tower cameras, UAVs) to build a UXO mitigation phase plan of attack.
15. Can you describe how the RADAS system differs from the manual method currently being used? RADAS aims to combine many of the real time data sources I referred to above to provide situational awareness following an attack. This is different than the current manual method in that it does not require a manual approach to build initial situational awareness of UXO and damage locations.
16. Are there any documents outlining the current RADAS system and its capabilities? Refer you to AFCEC/CX for more information.
17. Is the RADAS system currently fielded and type classified or still in R&D? Refer you to AFCEC/CX for more information.
18. What are the baseline (threshold and objective) metrics for the RADAS system? How were these derived? Refer you to AFCEC/CX for more information.

19. What technologies are being developed that will benefit airfield damage assessment? Refer you to AFCEC/CX, IHEODTD and sister-service research efforts for more information. Anecdotally I have heard that U.S. Navy engineers are also doing research in the area of airfield damage assessment and repair.
20. What factors increase or decrease the difficulty in performing an airfield damage assessment? Incomplete real-time data (remote visual, radar, etc.). Repeat attacks halting/delaying efforts. Weather. Equipment malfunctions. Low visibility/hours of darkness.
21. Has the focus been on improving runway repair time more than improving assessment time? If so, why? Refer question to AFCEC/CX. I don't have a complete sight picture on how AFCEC has expended time and resources in the runway repair phase vs. the assessment or UXO mitigation phase.
22. Are the manual assessment procedures similar to what they have been since the 1950s? Airfield damage repair has gone through some improvements since the 1950s. Refer question to AFCEC/CX. I don't have a complete historical sight picture on TTPs currently taught in SILVER FLAG when compared to those techniques taught in the 1950s.
23. What are the main obstacles preventing the Air Force from modernizing the assessment procedures? I do not have current and firsthand knowledge to answer definitively, but I assume technology readiness levels and resourcing present challenges to modernization of the overall Airfield Damage Assessment program.
24. What is the measure (definition of success) of improvement for airfield damage assessment? In my opinion, the definition of success should be the proven capability to conduct Airfield Damage Repair (of which airfield damage assessment is a sub-task) in the time frames established by combatant commanders, joint force commanders and combined/joint force air component

commanders. These time frames are aggressive but not publically releasable due to classification level.

THIS PAGE INTENTIONALLY LEFT BLANK

APPENDIX C. ADDITIONAL DATA

Graphical representations of the DRM weapons are shown in Figures C-1 through C-3.

DRM Weapon Information

- Russian RBK-500 BetAB Cluster Bomb
- Anti-runway Cluster-Bomb Unit (CBU) intended to penetrate and damage concrete structures and runways
- Characteristics:
 - Carries 12 BetAB sub munitions (fragmentation)
 - Each BetAB has a crater size of 4 m²
 - Maximum BetAB dispersal diameter = 40 m
 - Assumed dud rate of 16% (based upon UXO reports)



Figure C-1. Russian RBK-500 BetAB Cluster Bomb. Sources: Jane's Air Launched Weapons (2007) and Flankers Site (2017).

DRM Weapon Information

- Russian RBK-500RTM AO Cluster Bomb
- Anti-personnel Cluster-Bomb Unit (CBU) intended to spread multiple sub-munitions over a wide area in order to prevent the use of an area
- Characteristics:
 - Carries 108 AO-2.5RT sub munitions (fragmentation)
 - Has a footprint of 224,000 sq feet (267 foot radius)
 - Assumed dud rate of 16% (based upon UXO reports)



Figure C-2. Russian RBK-500RTM AO Cluster Bomb.
Sources: International Campaign to Ban Landmines (2012) and
The Fighter Collection & Eagle Dynamics (2013)

DRM Weapon Information

- Russian FAB-500 T General Purpose Bomb
- Air-dropped bomb intended to inflict damage to the runway through blast, fragmentation, and penetration through the runway.
- Effects:
 - Crater Depth = 13 m (43 feet)
 - Crater Diameter = 22.5 m (74 feet)
 - Clean up/Spalling Diameter = 430 m (1411 feet)



Figure C-3. Russian FAB-500T. Source: Global Security.org (2016)

Table C-1. DRM RBK-500 BetAB (1) Pattern

	X	Y			X			27R/9L	9R/27L	
CBU Target	3260.5	700		Radius	65		Total Hits	12	0	
							Total UXO	4	0	
Bomblet	UXO	X location	Y location	Hit 27R/ 9L	Hit 9R/ 27L	27R/9L UXO	9L/27R UXO		Radius	Angle
1	FALSE	3252.26	692.34	TRUE	FALSE	FALSE	FALSE		11.25	3.89
2	TRUE	3252.55	687.78	TRUE	FALSE	TRUE	FALSE		14.58	4.14
3	FALSE	3252.07	704.17	TRUE	FALSE	FALSE	FALSE		9.41	2.68
4	FALSE	3261.89	710.38	TRUE	FALSE	FALSE	FALSE		10.47	1.44
5	FALSE	3306.73	694.67	TRUE	FALSE	FALSE	FALSE		46.53	6.17
6	TRUE	3236.80	692.55	TRUE	FALSE	TRUE	FALSE		24.85	3.45
7	FALSE	3255.50	655.04	TRUE	FALSE	FALSE	FALSE		45.23	4.60
8	TRUE	3259.95	693.96	TRUE	FALSE	TRUE	FALSE		6.07	4.62
9	FALSE	3268.00	692.00	TRUE	FALSE	FALSE	FALSE		10.97	5.47
10	FALSE	3302.93	719.51	TRUE	FALSE	FALSE	FALSE		46.70	0.43
11	FALSE	3270.92	710.41	TRUE	FALSE	FALSE	FALSE		14.73	0.79
12	TRUE	3261.97	717.67	TRUE	FALSE	TRUE	FALSE		17.73	1.49

Table C-2. DRM RBK-500 BetAB (2) Pattern

	X	Y			X			27R/9L	9R/27L	
CBU Target	1000	75		Radius	65		Total Hits	0	12	
							Total UXO	0	5	
Bomblet	UXO	X location	Y location	Hit 27R/ 9L	Hit 9R/ 27L	27R/9L UXO	9L/27R UXO		Radius	Angle
1	FALSE	1000.44	74.81	FALSE	TRUE	FALSE	FALSE		0.48	5.88
2	FALSE	953.02	72.45	FALSE	TRUE	FALSE	FALSE		47.05	3.20
3	FALSE	979.24	128.38	FALSE	TRUE	FALSE	FALSE		57.27	1.94
4	FALSE	970.28	115.30	FALSE	TRUE	FALSE	FALSE		50.07	2.21
5	TRUE	997.13	72.58	FALSE	TRUE	FALSE	TRUE		3.76	3.84
6	FALSE	1012.61	123.41	FALSE	TRUE	FALSE	FALSE		50.03	1.32
7	TRUE	988.16	82.63	FALSE	TRUE	FALSE	TRUE		14.09	2.57
8	TRUE	992.42	53.89	FALSE	TRUE	FALSE	TRUE		22.43	4.37
9	TRUE	978.44	64.64	FALSE	TRUE	FALSE	TRUE		23.92	3.59
10	FALSE	985.21	81.10	FALSE	TRUE	FALSE	FALSE		16.00	2.75
11	TRUE	1057.03	77.03	FALSE	TRUE	FALSE	TRUE		57.06	0.04
12	FALSE	1015.43	45.23	FALSE	TRUE	FALSE	FALSE		33.53	5.19

Table C-3. DRM RBK-500 AO-2.5.RT

	X	Y			X	Y					27R/9L	9R/27L
CBU Target	500	700		Radius	267					Total Hits	43	0
										Total UXO	4	0
Bomblet	UXO	X location	Y location	Hit 27R/9L	Hit 9R/27L	27R/9L UXO	9L/27R UXO		Radius	Angle		
1	FALSE	501.8957	735.3605	TRUE	FALSE	FALSE	FALSE		35.4112	1.51726		
2	FALSE	482.6544	731.2462	TRUE	FALSE	FALSE	FALSE		35.7378	2.0776		
3	FALSE	580.6993	686.38194	TRUE	FALSE	FALSE	FALSE		81.84023	6.1160		
4	FALSE	444.2820	768.9314	FALSE	FALSE	FALSE	FALSE		88.6343	2.2506		
5	FALSE	415.3308	634.4573	FALSE	FALSE	FALSE	FALSE		107.0734	3.8003		
6	FALSE	348.3067	484.21889	FALSE	FALSE	FALSE	FALSE		263.7657	4.0997		
7	FALSE	697.6822	614.3782	FALSE	FALSE	FALSE	FALSE		215.42831	5.8744		
8	FALSE	482.8694	495.7018	FALSE	FALSE	FALSE	FALSE		205.0151	4.6287		
9	FALSE	486.4539	688.4423	TRUE	FALSE	FALSE	FALSE		17.8067	3.8479		
10	FALSE	335.1401	748.2649	TRUE	FALSE	FALSE	FALSE		171.7797	2.8568		
11	FALSE	445.8302	725.8789	TRUE	FALSE	FALSE	FALSE		60.0341	2.6959		
12	FALSE	476.4532	710.1315	TRUE	FALSE	FALSE	FALSE		25.6339	2.7353		
13	FALSE	496.8794	703.9253	TRUE	FALSE	FALSE	FALSE		5.0146	2.2425		
14	FALSE	480.4017	706.4275	TRUE	FALSE	FALSE	FALSE		20.6254	2.8247		
15	FALSE	530.6377	719.7591	TRUE	FALSE	FALSE	FALSE		36.4567	0.5728		
16	FALSE	383.2987	819.0994	FALSE	FALSE	FALSE	FALSE		166.7449	2.3460		
17	FALSE	600.2355	513.8571	FALSE	FALSE	FALSE	FALSE		211.4151	5.20635		
18	FALSE	458.2637	614.3516	FALSE	FALSE	FALSE	FALSE		95.2763	4.25896		
19	FALSE	536.3748	925.92	FALSE	FALSE	FALSE	FALSE		228.8296	1.41116		
20	FALSE	499.9493	702.0313	TRUE	FALSE	FALSE	FALSE		2.032	1.5957		
21	FALSE	369.5659	496.5683	FALSE	FALSE	FALSE	FALSE		241.6558	4.14225		

Continued next page.

Table C-3. Continued from previous page.

22	FALSE	500.7656	690.9322	TRUE	FALSE	FALSE	FALSE		9.1001	4.7966		
23	FALSE	427.1609	661.6576	TRUE	FALSE	FALSE	FALSE		82.31449	3.6261		
24	FALSE	396.5942	682.5180	TRUE	FALSE	FALSE	FALSE		104.8732	3.3091		
25	FALSE	513.5728	823.4536	FALSE	FALSE	FALSE	FALSE		124.1975	1.4613		
26	FALSE	554.5636	497.2172	FALSE	FALSE	FALSE	FALSE		209.9954	4.9752		
27	FALSE	500.9947	896.752	FALSE	FALSE	FALSE	FALSE		196.7545	1.5657		
28	FALSE	454.3521	791.4894	FALSE	FALSE	FALSE	FALSE		102.245	2.0336		
29	FALSE	601.0013	540.2267	FALSE	FALSE	FALSE	FALSE		189.0205	5.2761		
30	TRUE	545.7199	730.4717	TRUE	FALSE	TRUE	FALSE		54.944	0.5879		
31	FALSE	519.7072	818.5168	FALSE	FALSE	FALSE	FALSE		120.1441	1.4060		
32	FALSE	239.4548	710.7863	TRUE	FALSE	FALSE	FALSE		260.7684	3.1002		
33	FALSE	653.2224	832.1566	FALSE	FALSE	FALSE	FALSE		202.3424	0.7117		
34	FALSE	403.5577	789.8885	FALSE	FALSE	FALSE	FALSE		131.8372	2.3914		
35	FALSE	425.4041	736.8119	TRUE	FALSE	FALSE	FALSE		83.1845	2.6832		
36	TRUE	499.5708	941.8778	FALSE	FALSE	FALSE	FALSE		241.8782	1.5726		
37	FALSE	595.7699	678.1226	TRUE	FALSE	FALSE	FALSE		98.2369	6.0586		
38	FALSE	564.225	838.5785	FALSE	FALSE	FALSE	FALSE		152.7378	1.1369		
39	FALSE	442.04	719.1564	TRUE	FALSE	FALSE	FALSE		61.0375	2.8224		
40	FALSE	352.472	614.2428	FALSE	FALSE	FALSE	FALSE		170.6424	3.6681		
41	FALSE	459.7746	771.5350	FALSE	FALSE	FALSE	FALSE		82.0692	2.0830		
42	TRUE	534.9869	704.9717	TRUE	FALSE	TRUE	FALSE		35.3384	0.1412		
43	FALSE	556.6560	618.5961	FALSE	FALSE	FALSE	FALSE		99.1791	5.3204		
44	FALSE	597.3418	643.8385	FALSE	FALSE	FALSE	FALSE		112.3812	5.7599		
45	FALSE	403.6056	747.0471	TRUE	FALSE	FALSE	FALSE		107.2629	2.6876		
46	FALSE	504.8777	775.1587	FALSE	FALSE	FALSE	FALSE		75.3168	1.50684		
47	FALSE	498.4391	835.0429	FALSE	FALSE	FALSE	FALSE		135.0519	1.5824		
48	FALSE	544.6467	547.5593	FALSE	FALSE	FALSE	FALSE		158.8442	4.9973		
49	TRUE	726.0692	750.1483	FALSE	FALSE	FALSE	FALSE		231.5645	0.2183		

Continued next page.

Table C-3. Continued from previous page.

50	FALSE	478.1377	757.3886	FALSE	FALSE	FALSE	FALSE		61.4118	1.9348		
51	FALSE	532.1559	668.8036	TRUE	FALSE	FALSE	FALSE		44.8021	5.5129		
52	FALSE	441.1467	461.5787	FALSE	FALSE	FALSE	FALSE		245.5778	4.4704		
53	FALSE	303.7576	671.9258	TRUE	FALSE	FALSE	FALSE		198.2404	3.2837		
54	TRUE	490.0124	459.9954	FALSE	FALSE	FALSE	FALSE		240.2123	4.6708		
55	FALSE	739.2747	672.5469	TRUE	FALSE	FALSE	FALSE		240.8445	6.169		
56	FALSE	471.8054	726.3382	TRUE	FALSE	FALSE	FALSE		38.5828	2.3902		
57	FALSE	470.1147	803.6697	FALSE	FALSE	FALSE	FALSE		107.8913	1.8515		
58	TRUE	505.2713	699.2755	TRUE	FALSE	TRUE	FALSE		5.3208	6.1466		
59	FALSE	551.9340	704.4523	TRUE	FALSE	FALSE	FALSE		52.1245	0.0855		
60	TRUE	607.2198	535.1757	FALSE	FALSE	FALSE	FALSE		196.6295	5.2891		
61	FALSE	383.1199	822.2814	FALSE	FALSE	FALSE	FALSE		169.1559	2.3336		
62	FALSE	669.1246	656.1017	TRUE	FALSE	FALSE	FALSE		174.729	6.0292		
63	FALSE	429.7875	676.3861	TRUE	FALSE	FALSE	FALSE		74.07711	3.4660		
64	FALSE	487.1729	685.2889	TRUE	FALSE	FALSE	FALSE		19.5179	3.9953		
65	FALSE	476.8386	677.7383	TRUE	FALSE	FALSE	FALSE		32.1253	3.9072		
66	FALSE	468.7925	799.2154	FALSE	FALSE	FALSE	FALSE		104.0077	1.87554		
67	TRUE	393.1081	821.8579	FALSE	FALSE	FALSE	FALSE		162.0964	2.2909		
68	TRUE	571.9861	621.9643	FALSE	FALSE	FALSE	FALSE		106.1677	5.4575		
69	FALSE	511.2804	442.0496	FALSE	FALSE	FALSE	FALSE		258.1969	4.7561		
70	FALSE	558.9692	586.9819	FALSE	FALSE	FALSE	FALSE		127.4773	5.1933		
71	FALSE	488.9730	620.9322	FALSE	FALSE	FALSE	FALSE		79.8331	4.5738		
72	FALSE	557.8391	760.1503	FALSE	FALSE	FALSE	FALSE		83.4472	0.805		
73	FALSE	434.3834	903.8431	FALSE	FALSE	FALSE	FALSE		214.1438	1.8822		
74	FALSE	644.9380	501.71634	FALSE	FALSE	FALSE	FALSE		245.6083	5.3436		
75	FALSE	346.5076	844.8829	FALSE	FALSE	FALSE	FALSE		211.0710	2.3850		
76	FALSE	510.7632	478.66504	FALSE	FALSE	FALSE	FALSE		221.5965	4.761		

Continued next page.

Table C-3. Continued from previous page.

77	FALSE	443.3549	681.0922	TRUE	FALSE	FALSE	FALSE		59.7174	3.4638		
78	FALSE	653.7993	805.1358	FALSE	FALSE	FALSE	FALSE		186.3002	0.5997		
79	TRUE	444.0708	699.2562	TRUE	FALSE	TRUE	FALSE		55.9342	3.1549		
80	FALSE	428.8799	694.7451	TRUE	FALSE	FALSE	FALSE		71.314	3.2153		
81	FALSE	701.7690	838.5802	FALSE	FALSE	FALSE	FALSE		244.7758	0.6018		
82	FALSE	355.2583	809.5912	FALSE	FALSE	FALSE	FALSE		181.55	2.4935		
83	FALSE	583.2062	732.6377	TRUE	FALSE	FALSE	FALSE		89.3784	0.3738		
84	FALSE	644.8251	819.4775	FALSE	FALSE	FALSE	FALSE		187.7476	0.6898		
85	FALSE	391.6471	465.8855	FALSE	FALSE	FALSE	FALSE		257.97278	4.2789		
86	FALSE	577.3118	665.4725	TRUE	FALSE	FALSE	FALSE		84.6714	5.8632		
87	FALSE	558.1704	800.8978	FALSE	FALSE	FALSE	FALSE		116.4653	1.0478		
88	FALSE	562.8236	764.0383	FALSE	FALSE	FALSE	FALSE		89.7091	0.795		
89	FALSE	513.9656	741.4113	TRUE	FALSE	FALSE	FALSE		43.70281	1.2455		
90	FALSE	610.3964	738.6799	TRUE	FALSE	FALSE	FALSE		116.9765	0.3370		
91	FALSE	492.5226	757.4785	FALSE	FALSE	FALSE	FALSE		57.9628	1.7002		
92	FALSE	483.4872	748.5778	TRUE	FALSE	FALSE	FALSE		51.3077	1.8985		
93	FALSE	630.9781	735.4820	TRUE	FALSE	FALSE	FALSE		135.6990	0.2646		
94	FALSE	624.3331	478.6027	FALSE	FALSE	FALSE	FALSE		253.9202	5.2241		
95	FALSE	457.4431	779.4127	FALSE	FALSE	FALSE	FALSE		90.0970	2.0627		
96	FALSE	463.5419	815.69845	FALSE	FALSE	FALSE	FALSE		121.3068	1.8761		
97	FALSE	499.306	705.0742	TRUE	FALSE	FALSE	FALSE		5.1215	1.7067		
98	FALSE	475.0920	596.9489	FALSE	FALSE	FALSE	FALSE		106.0187	4.4752		
99	FALSE	386.1351	812.7207	FALSE	FALSE	FALSE	FALSE		160.2222	2.3612		
100	FALSE	519.5824	459.0308	FALSE	FALSE	FALSE	FALSE		241.7636	4.7935		
101	FALSE	345.4347	579.0331	FALSE	FALSE	FALSE	FALSE		196.2739	3.8056		
102	FALSE	625.1924	688.6215	TRUE	FALSE	FALSE	FALSE		125.7085	6.1925		
103	TRUE	461.7902	831.6925	FALSE	FALSE	FALSE	FALSE		137.1237	1.8532		

Continued next page.

Table C-3. Continued from previous page.

104	FALSE	504.4389	465.2151	FALSE	FALSE	FALSE	FALSE	234.8269	4.7313		
105	FALSE	243.5919	634.9461	FALSE	FALSE	FALSE	FALSE	264.5319	3.39001		
106	FALSE	361.1039	887.0751	FALSE	FALSE	FALSE	FALSE	233.0005	2.20945		
107	FALSE	325.638	714.0523	TRUE	FALSE	FALSE	FALSE	174.9273	3.0612		
108	FALSE	394.9736	851.7969	FALSE	FALSE	FALSE	FALSE	184.5883	2.1761		

Figures C-4 through C-6 show the ADAS ExtendSim model, simulation inputs and outputs in more detail.

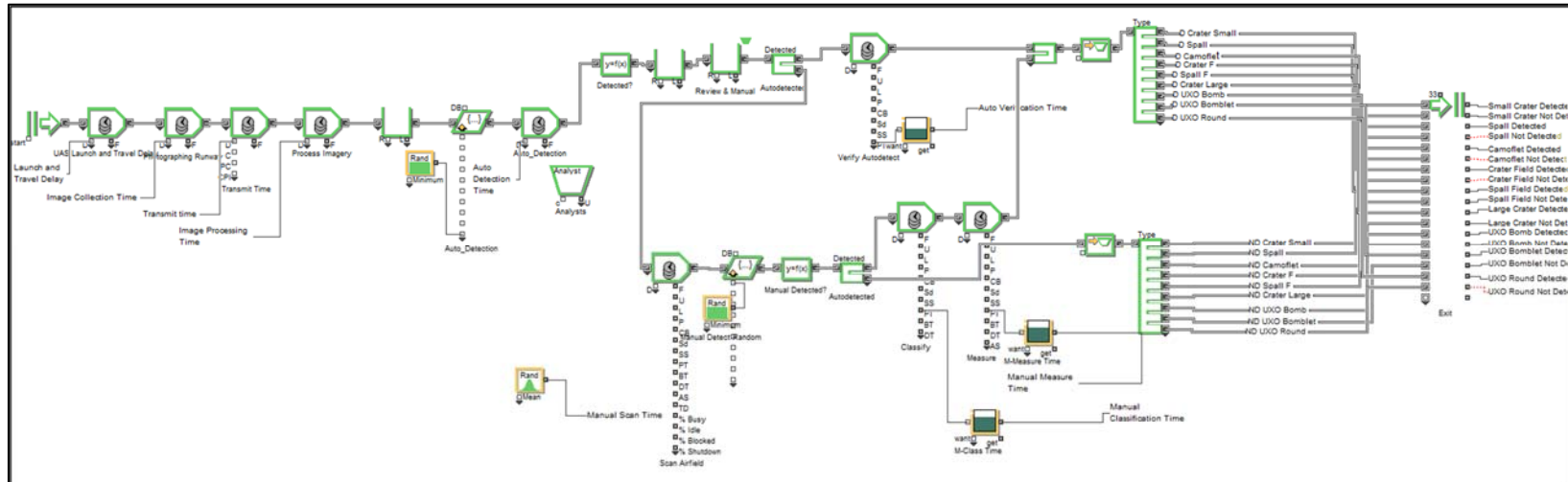



Figure C-4. ADAS ExtendSim Model



Simulation Inputs

Launch Parameters

Prep and Launch:

Time of UAS (min): Mean: Std Dev:

Distance - Launch Point to start of survey (meters):

Average Ground Speed of UAS - Transit (mph):

RPA Camera & UAS Parameters

Width in Pixels	5280
Height in Pixels	3956
Focal Plane Width (mm)	18
Focal Plane Height (mm)	13.5
Lens Focal Length (mm)	10
UAS Datalink Speed (Mbs)	4.5

UAS Ground Speed (mph)	30
Flight Height (m)	152.4
Forward Overlap (%)	60
Side Overlap (%)	40
Survey Length (m)	2133.6
Survey Width (m)	304.8

Automated Detection Probabilities

Property Name	Value
4 Pcraterfield	0.95
5 Pspallfield	0.95
6 Puxo_bomb	0.7
7 Puxo_bomblet	0.6
8 Puxo_round	0.6
9 Drandom	0.422110397761

Manual Detection Probabilities

Property Name	Value
5 MPCamoflet	0.8
6 MPcraterfield	0.9
7 MPspallfield	0.9
8 MPuxo_bomb	0.8
9 MPuxo_bomblet	0.6
10 Puxo_round	0.8

Figure C-5. ADAS Simulation Inputs

Simulation Outputs (Last Run Only)

% Damage Detected	1
% UXO Detected	1
ADA Time	54.47
Launch and Travel time to Start of Survey (min)	7.478
Image Collecton Time (min)	8.525
Imagery Processing (min)	15.244
Automatic Detection/Classification/Measurement (min)	4.4734
Auto Detect Verification (min)	4.00744
Manual Review of Imagery (min)	4.9351
Manual Classification (time)	4.868
Manual Measurment (time)	4.937

Figure C-6. ADAS Simulation Outputs (Last Run Only)

Figures C-7 through C-9 show the IADAS I ExtendSim model, simulation inputs and outputs in more detail.

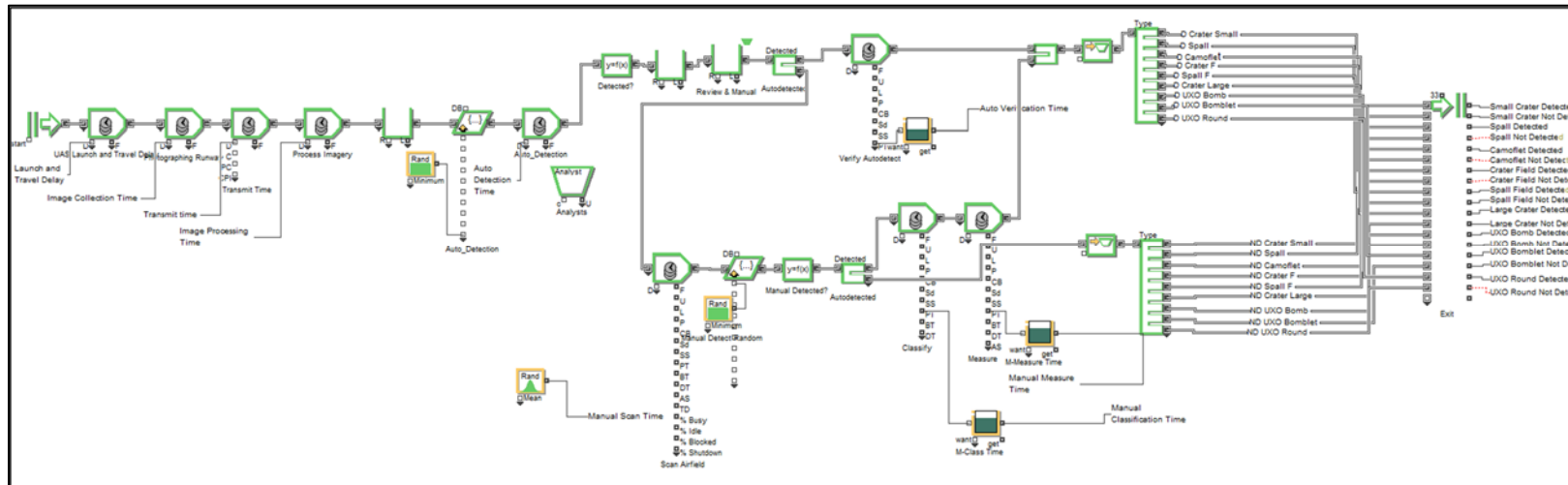

Figure C-7. IADAS I ExtendSim Model

Simulation Inputs

Launch Parameters

Prep and Launch:

Time of UAS (min): Mean: Std Dev:

Distance - Launch Point to start of survey (meters):

Average Ground Speed of UAS - Transit (mph):

RPA Camera & UAS Parameters

Width in Pixels	5280
Height in Pixels	3956
Focal Plane Width (mm)	18
Focal Plane Height (mm)	13.5
Lens Focal Length (mm)	10
UAS Datalink Speed (Mbs)	4.5

UAS Ground Speed (mph)	30
Flight Height (m)	152.4
Forward Overlap (%)	60
Side Overlap (%)	40
Survey Length (m)	2133.6
Survey Width (m)	304.8

Automated Detection Probabilities

Property Name	Value
4 Pcraterfield	0.95
5 Pspallfield	0.95
6 Puxo_bomb	0.7
7 Puxo_bomblet	0.6
8 Puxo_round	0.6
9 Drandom	0.422110397761

Manual Detection Probabilities

Property Name	Value
5 MPCamoflet	0.8
6 MPcraterfield	0.9
7 MPspallfield	0.9
8 MPuxo_bomb	0.8
9 MPuxo_bomblet	0.6
10 Puxo_round	0.8

Figure C-8. IADAS I Simulation Inputs

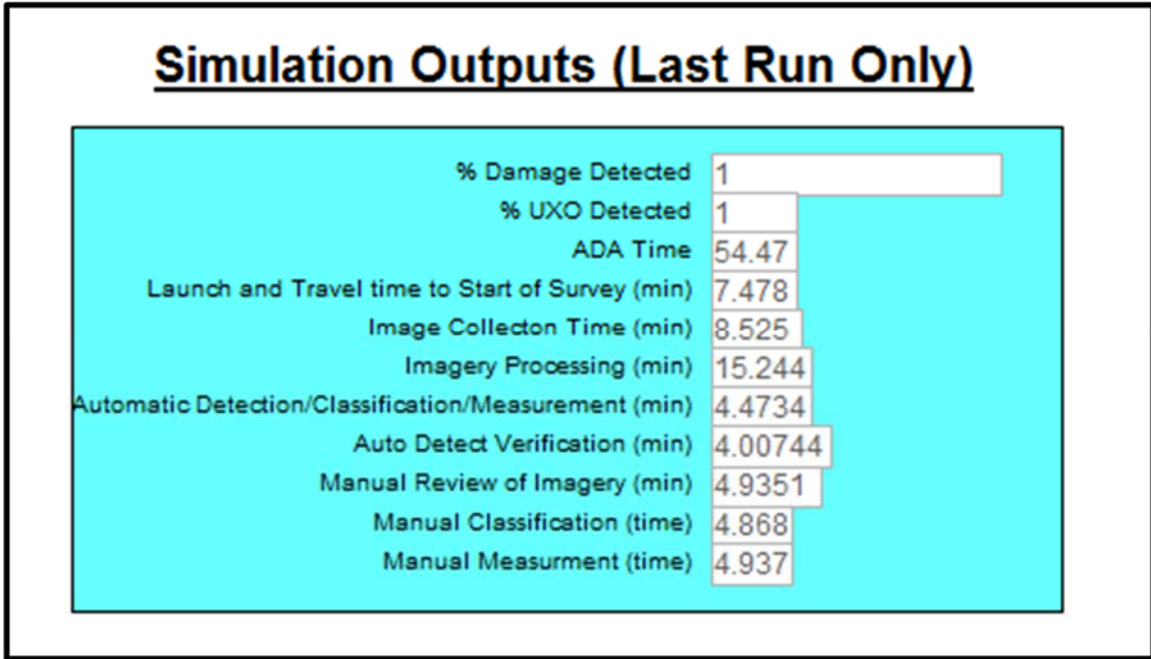



Figure C-9. IADAS I Simulation Outputs (Last Run Only)

Some of the screen shots for IADAS I & IADAS II alternatives are provided below. The first image is from the systems engineering estimate for IADAS I in Figures C-10 and C-11.



System Cost Model Suite

Options
 Monte Carlo Risk

Systems Engineering

Software

Hardware

Summary

Constructive Systems Engineering Cost Model (COSYSMO)

System Size

	Easy	Nominal	Difficult
# of System Requirements	3	6	2
# of System Interfaces		2	1
# of Algorithms	1	5	1
# of Operational Scenarios		1	1

System Cost Drivers

Requirements Understanding	<input type="text" value="High"/>	Documentation	<input type="text" value="Nominal"/>	Personnel Experience/Continuity	<input type="text" value="Nominal"/>
Architecture Understanding	<input type="text" value="High"/>	# and Diversity of Installations/Platforms	<input type="text" value="Nominal"/>	Process Capability	<input type="text" value="Nominal"/>
Level of Service Requirements	<input type="text" value="Nominal"/>	# of Recursive Levels in the Design	<input type="text" value="Low"/>	Multisite Coordination	<input type="text" value="Very Low"/>
Migration Complexity	<input type="text" value="Nominal"/>	Stakeholder Team Cohesion	<input type="text" value="High"/>	Tool Support	<input type="text" value="Nominal"/>
Technology Risk	<input type="text" value="Nominal"/>	Personnel/Team Capability	<input type="text" value="Nominal"/>		

Maintenance Annual Change % Maintenance Duration (Years)

System Labor Rates

Cost per Person-Month (Dollars)

Figure C-10. IADAS I Systems Engineering Costs, Page 1

Results
Systems Engineering
Effort = 21.7 Person-months
Schedule = 4.1 Months
Cost = \$216926

Total Size = 108 Equivalent Nominal Requirements

Acquisition Effort Distribution (Person-Months)

Phase / Activity	Conceptualize	Develop	Operational Test and Evaluation	Transition to Operation
Acquisition and Supply	0.4	0.8	0.2	0.1
Technical Management	0.8	1.4	0.9	0.6
System Design	2.2	2.6	1.1	0.6
Product Realization	0.4	1.0	1.0	0.8
Product Evaluation	1.2	1.8	2.7	1.0

Maintenance
Annual Maintenance Effort = 1.9 Person-Months
Annual Maintenance Cost = \$18893
Total Maintenance Cost = \$188935

Figure C-11. IADAS I Systems Engineering Costs, Page 2

The next image is from the software engineering estimate for IADAS I in Figures C-12 and C-13.



System Cost Model Suite

Options
 Monte Carlo Risk

Systems Engineering
Software
Hardware
Summary

Constructive Cost Model (COCOMO II)

Software Size Sizing Method

SLOC

	SLOC	% Design Modified	% Code Modified	% Integration Required	Assessment and Assimilation (0% - 8%)	Software Understanding (0% - 50%)	Unfamiliarity (0-1)
New	<input type="text" value="4000"/>						
Reused	<input type="text" value="2000"/>	<input type="text" value="0"/>	<input type="text" value="0"/>	<input type="text" value="25"/>	<input type="text" value="3"/>		
Modified	<input type="text"/>	<input type="text"/>	<input type="text"/>	<input type="text"/>	<input type="text"/>	<input type="text"/>	<input type="text"/>

Software Scale Drivers

Precedentedness	<input type="button" value="Nominal"/>	Architecture / Risk Resolution	<input type="button" value="Nominal"/>	Process Maturity	<input type="button" value="Nominal"/>
Development Flexibility	<input type="button" value="Nominal"/>	Team Cohesion	<input type="button" value="Nominal"/>		

Software Cost Drivers

Product		Personnel		Platform	
Required Software Reliability	<input type="button" value="High"/>	Analyst Capability	<input type="button" value="Nominal"/>	Time Constraint	<input type="button" value="Nominal"/>
Data Base Size	<input type="button" value="Low"/>	Programmer Capability	<input type="button" value="Nominal"/>	Storage Constraint	<input type="button" value="Nominal"/>
Product Complexity	<input type="button" value="Low"/>	Personnel Continuity	<input type="button" value="Nominal"/>	Platform Volatility	<input type="button" value="Low"/>
Developed for Reusability	<input type="button" value="High"/>	Application Experience	<input type="button" value="Nominal"/>	Project	
Documentation Match to Lifecycle Needs	<input type="button" value="Nominal"/>	Platform Experience	<input type="button" value="Nominal"/>	Use of Software Tools	<input type="button" value="High"/>
		Language and Toolset Experience	<input type="button" value="Nominal"/>	Multisite Development	<input type="button" value="Very Low"/>
				Required Development Schedule	<input type="button" value="Nominal"/>

Figure C-12. IADAS I Software Engineering Cost, Page 1

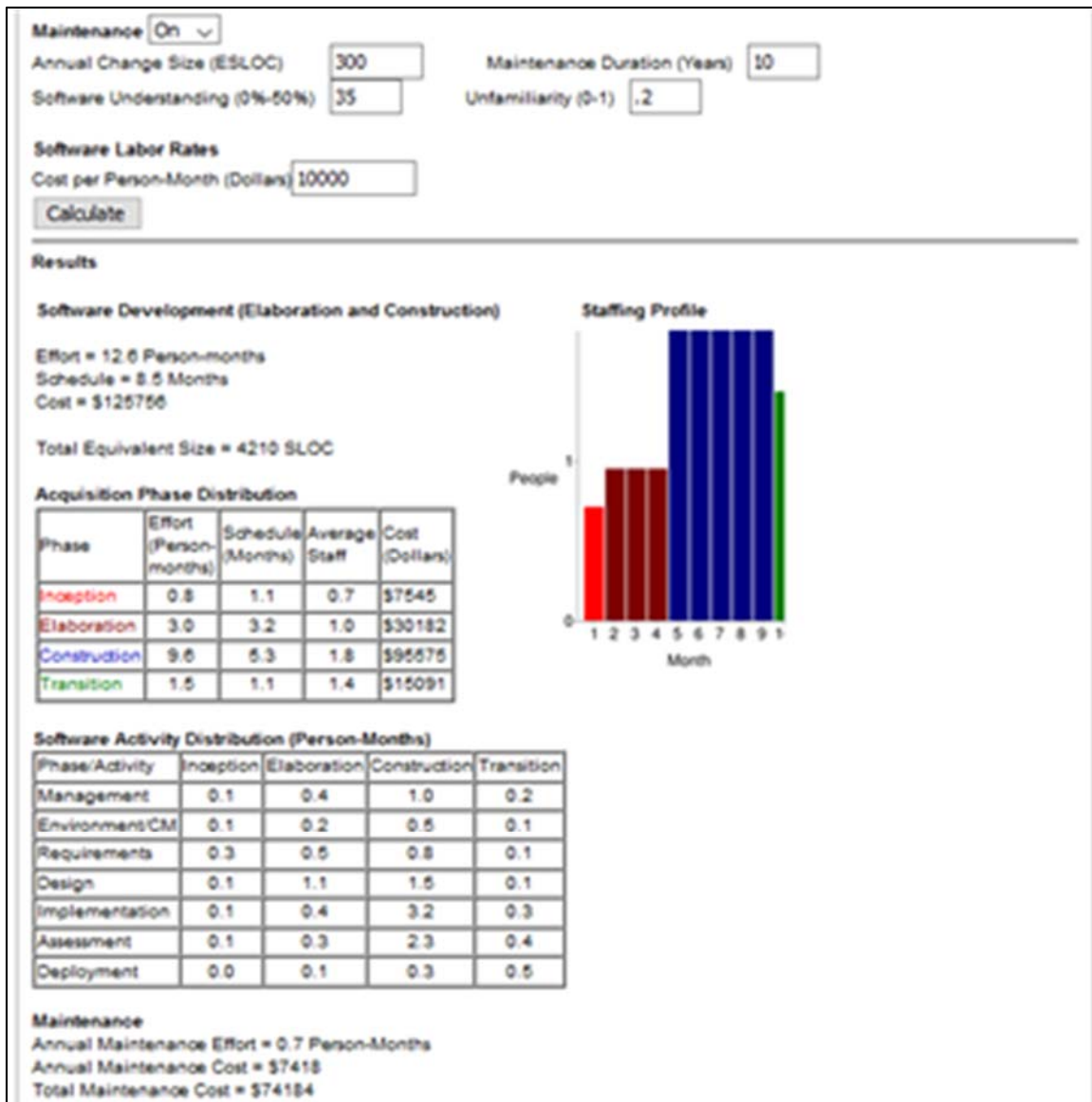

Figure C-13. IADAS I Software Engineering Cost, Page 2

Figures C-14 through C-16 show the IADAS II ExtendSim model, simulation inputs and outputs in more detail.

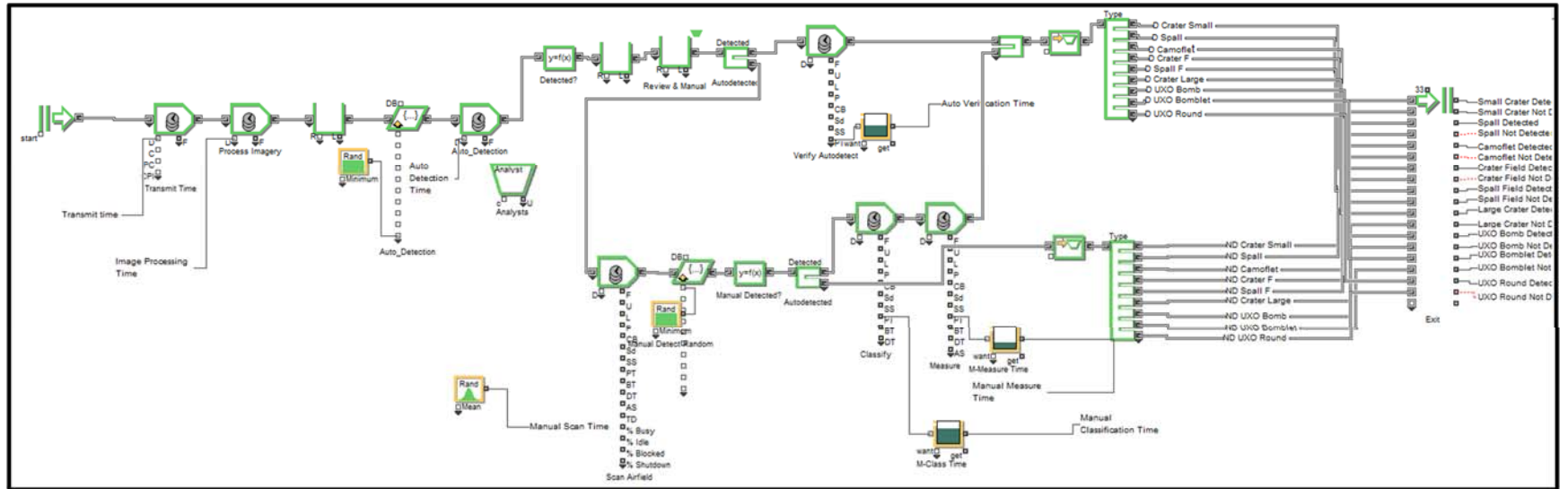



Figure C-14. IADAS II ExtendSim Model



Simulation Inputs

Number of Towers (Pictures):

Size of Pictures (Mb):

Wireless Network Speed: (Mbps) Minimum:
 Maximum:

Estimated Image Processing Time (min): Mean:
 Std Dev:

Estimated Autodetect Software Time (min): Mean:
 Std Dev:

Automated Detection Probabilities

	Property Name	Value	
0	PCrater_Small	0.7	▲
1	PCrater_Large	0.8	
2	Pspall	0.5	
3	Pcamoflat	0.5	
4	Poraterfield	0.8	
5	Pspallfield	0.8	▼

Manual Detection Probabilities

	Property Name	Value	
0	Drandom	0.3604588833326	▲
1	MPCrater_Small	0.75	
2	MPCrater_Large	0.75	
3	MPSpall	0.6	
4	MPCamoflat	0.5	
5	MPCraterfield	0.8	▼

Figure C-15. IADAS II Simulation Inputs

Simulation Outputs (Last Run Only)

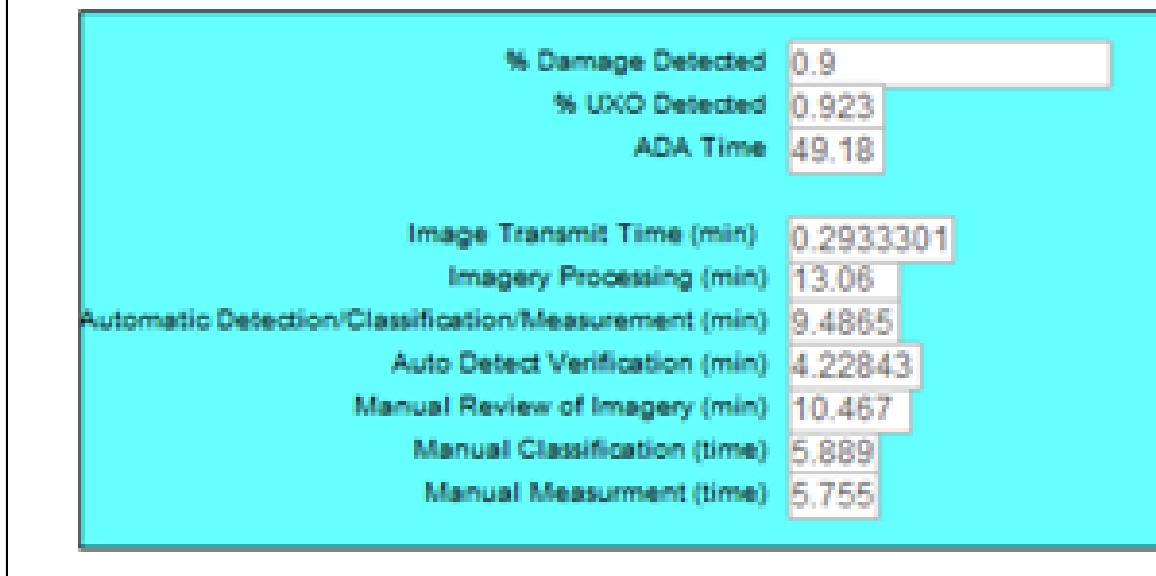



Figure C-16. IADAS II Simulation Outputs (Last Run Only)

Moving to the IADAS II alternative, the next image is from the Systems Engineering estimate in Figure C-17.



System Cost Model Suite

Options
 Monte Carlo Risk

Systems Engineering
Software
Hardware
Summary

Constructive Systems Engineering Cost Model (COSYSMO)

System Size

	Easy	Nominal	Difficult
# of System Requirements	3	6	2
# of System Interfaces		2	
# of Algorithms		5	1
# of Operational Scenarios		1	1

System Cost Drivers

Requirements Understanding	<input type="button" value="High"/>	Documentation	<input type="button" value="Low"/>	Personnel Experience/Continuity	<input type="button" value="Nominal"/>
Architecture Understanding	<input type="button" value="Very High"/>	# and Diversity of Installations/Platforms	<input type="button" value="Nominal"/>	Process Capability	<input type="button" value="Nominal"/>
Level of Service Requirements	<input type="button" value="Low"/>	# of Recursive Levels in the Design	<input type="button" value="Low"/>	Multisite Coordination	<input type="button" value="Very Low"/>
Migration Complexity	<input type="button" value="Nominal"/>	Stakeholder Team Cohesion	<input type="button" value="High"/>	Tool Support	<input type="button" value="Low"/>
Technology Risk	<input type="button" value="Nominal"/>	Personnel/Team Capability	<input type="button" value="Nominal"/>		

Maintenance Annual Change % Maintenance Duration (Years)

System Labor Rates

Cost per Person-Month (Dollars)

Results

Systems Engineering
 Effort = 13.3 Person-months
 Schedule = 3.5 Months
 Cost = \$133085

Total Size = 99 Equivalent Nominal Requirements

Acquisition Effort Distribution (Person-Months)

Phase / Activity	Conceptualize	Develop	Operational Test and Evaluation	Transition to Operation
Acquisition and Supply	0.3	0.5	0.1	0.1
Technical Management	0.5	0.9	0.6	0.3
System Design	1.4	1.6	0.7	0.4
Product Realization	0.3	0.6	0.6	0.5
Product Evaluation	0.7	1.1	1.7	0.6

Maintenance
 Annual Maintenance Effort = 1.2 Person-Months
 Annual Maintenance Cost = \$11591
 Total Maintenance Cost = \$115912

Figure C-17. IADAS II Systems Engineering Cost

The final COCOMO model for IADAS II is the software engineering costs in Figures C-18 and C-19.

The screenshot displays the 'System Cost Model Suite' interface. At the top, there is a logo for NPS and the title 'System Cost Model Suite'. On the right, there are 'Options' with 'Monte Carlo Risk' set to 'Off'. Below this is a navigation bar with tabs for 'Systems Engineering', 'Software' (which is selected), 'Hardware', and 'Summary'. The main content area is titled 'Constructive Cost Model (COCOMO II)'. It includes a 'Software Size' section with a 'Sizing Method' dropdown set to 'Source Lines of Code'. Below this is a table for software size parameters:

	SLOC	% Design Modified	% Code Modified	% Integration Required	Assessment and Assimilation (0% - 8%)	Software Understanding (0% - 50%)	Unfamiliarity (0-1)
New	4000						
Reused	2000	0	0	25	3		
Modified							

Below the table are several sections of drivers, each with a dropdown menu:

- Software Scale Drivers:** Precedentedness (Nominal), Development Flexibility (Nominal), Architecture / Risk Resolution (Nominal), Team Cohesion (Nominal), Process Maturity (Nominal).
- Software Cost Drivers - Product:** Required Software Reliability (High), Data Base Size (Low), Product Complexity (Low), Developed for Reusability (High), Documentation Match to Lifecycle Needs (Nominal).
- Personnel:** Analyst Capability (Nominal), Programmer Capability (Nominal), Personnel Continuity (Nominal), Application Experience (Nominal), Platform Experience (Nominal), Language and Toolset Experience (Nominal).
- Platform:** Time Constraint (Nominal), Storage Constraint (Nominal), Platform Volatility (Low).
- Project:** Use of Software Tools (High), Multisite Development (Very Low), Required Development Schedule (Nominal).

At the bottom, there is a 'Maintenance' section with 'On' selected, and input fields for 'Annual Change Size (ESLOC)' (300), 'Maintenance Duration (Years)' (10), 'Software Understanding (0%-50%)' (35), and 'Unfamiliarity (0-1)' (.2).

Figure C-18. IADAS II Software Engineering Costs, Page 1

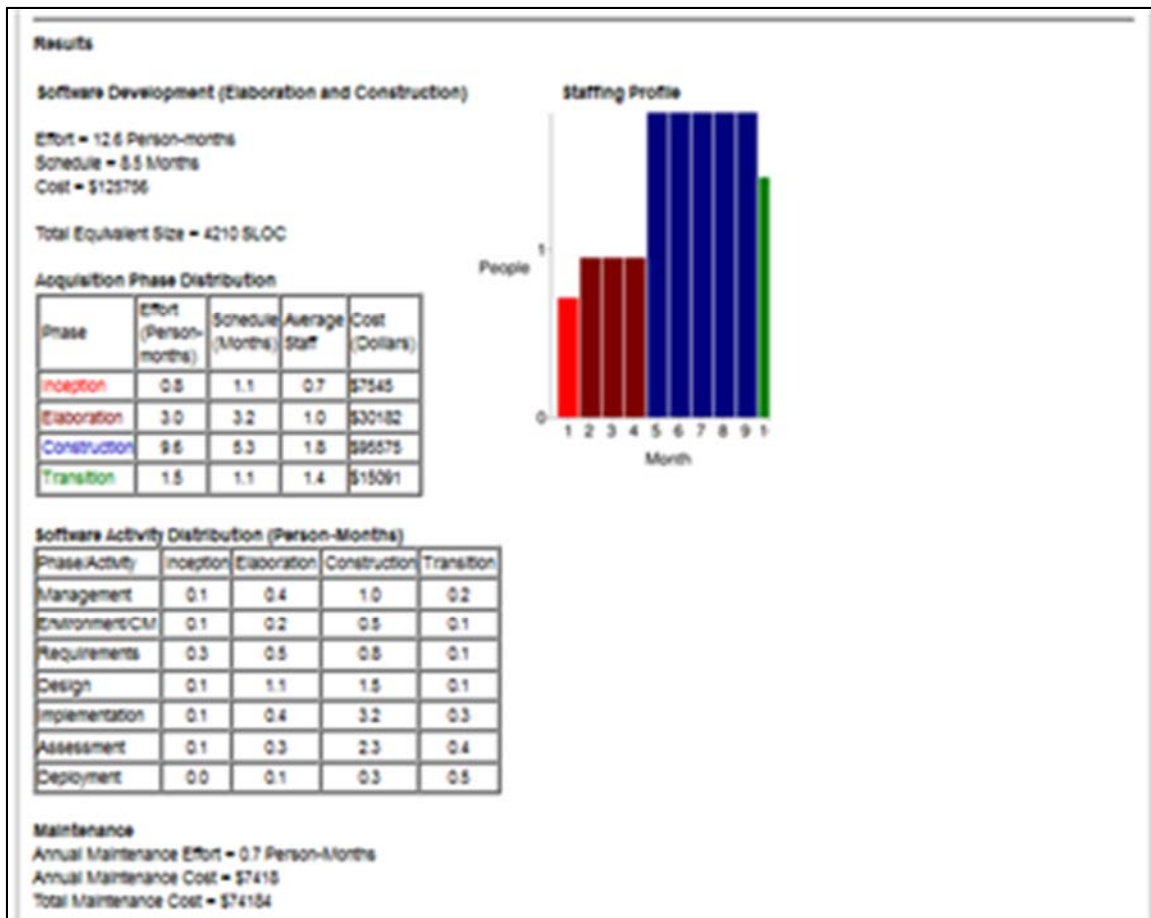

Figure C-19. IADAS II Software Engineering Costs, Page 2

THIS PAGE INTENTIONALLY LEFT BLANK

LIST OF REFERENCES

- Aerial Titans. 2017. "Towable Boom Lifts." Accessed March 25.
<http://www.towbehindboomlifts.com/new-nifty-lift-tracked>.
- AeroVironment. 2017. "Puma AE RQ-20B." Accessed March 23.
https://www.avinc.com/images/uploads/product_docs/PumaAE_Datasheet_2016_web_v1.2.pdf.
- Air Force Material Command. 2010. "Analysis of Alternatives (AoA) Handbook."
http://www.prim.osd.mil/Documents/AoA_Handbook.pdf.
- Aircraft Owners and Pilots Association. 2017. "Oakland County International Airport."
<https://www.aopa.org/airports/KPTK>.
- Blanchard, Benjamin, and Wolter Fabrycky. 2011. *Systems Engineering and Analysis Fifth Edition*. Upper Saddle River, NJ: Prentice Hall.
- CCTV Camera World Inc. 2015. "12MP 4K Ultra HD IP Camera 4X Zoom."
<http://www.cctvcameraworld.com/12mp-4k-ip-camera-varifocal-zoom-lens.html>.
- Center for Systems and Software Engineering. 2017 "COCOMO® II." Accessed February 13. http://sunset.usc.edu/csse/research/cocomoii/cocomo_main.html.
- Chandler, Tyler. 2016. "Hydra Fusion Tools for Rapid Airfield Damage Assessment System." Joint Interagency Field Experimentation. Camp Roberts, CA.
<https://my.nps.edu/documents/104517539/107618189/A-05.pdf/aa12cb6f-4895-4e56-ac74-2a1536b06b33>.
- Defense Acquisition University. 2001. "Systems Engineering Fundamentals." Defense Acquisition University Press. https://ocw.mit.edu/courses/aeronautics-and-astronautics/16-885j-aircraft-systems-engineering-fall-2005/readings/sefguide_01_01.pdf.
- . 2017. "System Acquisition Framework." Defense Acquisition Portal. Accessed April 02. <https://dap.dau.mil/aphome/das/Pages/Default.aspx>.
- Department of the Air Force. 2008. *Contingency and Disaster Planning (AFPAM 10-219)*. Washington, D.C.: Department of the Air Force. <https://www.wbdg.org/ffc/af-afcec/pamphlets-afp-and-afpam/afpam-10-219-v1.pdf>.
- . 2012a. *Red Horse Program*. Air Force Instruction 10–209. Washington, D.C.: Department of the Air Force. May 8. http://static.e-publishing.af.mil/production/1/af_a3_5/publication/afi10-209/afi10-209.pdf.

- . 2012b. *Request for Information: Rapid Airfield Damage Assessment System (RADAS) - Sensor & Data Processing*. June 07. Washington, D.C.: Air Force Materiel Command, Electronic Systems Center.
- . 2016. *Air Force Tactics, Techniques, and Procedures (AFTTP 3–23.11)*. Washington, D.C.: Department of the Air Force.
- Department of Defense. 2012. *Human Engineering Design Criteria Standard*. MIL-STD-1472 Revision G. Washington, D.C.: Department of Defense.
- Department of the Navy. 2001. *Aviation Ground Support*. (MCWP 3–21.1). Washington, D.C.: Department of the Navy.
- DJI. 2017a. “Inspire 2.” <http://www.dji.com/inspire-2>.
- . 2017b. “Zenmuse X5S Specification.” <http://www.dji.com/zenmuse-x5s/info#specs>.
- . 2017c. “Zenmuse X5S.” http://store.dji.com/product/zenmuse-x5s?site=brandsite&from=buy_now_bar.
- Drone Mapper. 2015a. “Drone Mapper’s RAPID for DJI.” https://dronemapper.com/software_downloads.
- . 2015b. “Sensors Characteristics.” April 01. https://dronemapper.com/uas_photogrammetry_processing.
- . 2017. “Red Rocks, Colorado Oblique.” https://dronemapper.com/sample_data%20.
- Dynamic Software Solutions. 2017. “GeoExPT.” <http://www.geoexpt.com>.
- Earth Imaging Journal. 2015. “Sensing Challenge: Airfield Damage Assessment.” <http://ejournal.com/print/articles/sensing-challenge-airfield-damage-assessment>.
- Echerri, Jess. 2015. “New Sensors Expected to Speed Up ADR Process.” U.S. Air Force Civil Engineering Center. <http://www.afcec.af.mil/News/Article-Display/Article/871470/new-sensors-expected-to-speed-up-adr-process>.
- The Fighter Collection & Eagle Dynamics, Inc. 2013. “SU-25: DCS Flaming Cliffs Flight Manual, Revision 2.” DCS World. <http://cdn.akamai.steamstatic.com/steam/apps/245580/manuals/Su-25%20Flight%20Manual%20EN.pdf>.
- Filler, Lance. 2014. “Rapid Airfield Damage Assessment System (RADAS).” USAF Airfield Damage Repair (ADR) Program Manager. U.S. Air Force.

- Flankers Site. 2017. "Modelling Russian Aircraft." Accessed May 31.
http://www.flankers-site.co.uk/modl_home.htm.
- Global Security.org. 2016. "FAB-250 General Purpose Bomb." Last modified March 04.
<http://www.globalsecurity.org/military/world/russia/fab-250.htm>.
- Handicap International. 2007. "Circle of Impact: The Fatal Footprint of Cluster Munitions on People and Communities." http://reliefweb.int/sites/reliefweb.int/files/resources/948D323F9A5BA883852572DF00674624-HI_ClusterMunitions_2007.pdf.
- Hewlett Packard. 2017. "HP Store Laptops, Desktops." <http://store.hp.com>.
- Imagine That, Inc. 2016. "ExtendSim Power Tools for Simulation."
http://www.extendsim.com/prods_overview.html.
- International Campaign to Ban Landmines. 2012. "Cluster Munition Ban Policy." Land and Cluster Munition Monitor. http://archives.the-monitor.org/index.php/cp/display/region_profiles/theme/2146.
- Jane's Air Launched Weapons. 2007. "RBK-500 BetAB Cluster Bomb."
- Mallerski, R. Craig. 2009. *Airfield Damage Repair-The Future Now*. Airforce Research Lab. DTIC Report AFRL-RX-TY-2009-4560. Panama City, FL: Tyndall Airforce Base. <http://www.dtic.mil/dtic/tr/fulltext/u2/a506165.pdf>.
- Marsh, Bill. 2007. "Putting a Price on the Priceless: One Life." *New York Times* (September 09). <http://www.nytimes.com/2007/09/09/weekinreview/09marsh.html>.
- Massachusetts Institute of Technology. 2017. "COSYSMO." <http://cosysmo.mit.edu>.
- Pierce, Jeffrey. 2015. "Seabees Conduct ADR Training to Challenge 21st Century Threats." U.S. Navy Seabees. <http://seabeemagazine.navylive.dodlive.mil/2016/06/06/seabees-conduct-adr-training-to-challenge-21st-century-threats>.
- Pint, Ellen, Lisa Colabella, Justin Adams, and Sally Sleeper. 2008. "Improving Recapitalization Planning." http://www.rand.org/content/dam/rand/pubs/technical_reports/2008/RAND_TR464.sum.pdf.
- Richard, Michael Graham. 2008. "Treehugger Driving Sustainability Mainstream." <https://www.treehugger.com/cars/7-gas-guzzling-military-combat-vehicles.html>.
- Satnews Daily. 2009. "Damage Assessment of the Rapid Kind for UAVs."
<http://www.satnews.com/story.php?number=1868392077>.

Schmidt, R. F. 2002. IEEE Xplore Digital Library. Digital Avionics Systems Conference.

Solid Signal, Signal Group LLC & Affiliates. 2017. "Rohn Products LLC – 25G – 25G 40 ft Freestanding Tower Kit (25SS040)." http://www.solidsignal.com/pview.asp?p=25SS040&utm_campaign=site_crosspromo&utm_medium=cart&utm_source=inhouse.

SPEC Innovations. 2016. "Innoslate." www.innoslate.com.

SU-27 Flanker. 2017. "RBK-500 Cluster Bomb (Razovaya Bombovaya Kasseta)." Accessed April 24. <http://su-27flanker.com/weapon/rbk-500/#>.

Tomkins, Richard. 2016. "RE2 Robotics Contracted To Support USAF Airfield Damage Repair Program." RoboDaily. http://www.robodaily.com/reports/RE2_Robotics_contracted_to_support_USAF_airfield_damage_repair_program_999.html.

U.S. Air Force Civil Engineer Center. 2017. <http://www.afcec.af.mil/Home/Readiness.aspx>.

Under Secretary of Defense (AT&L). 2003. *Operation of the Defense Acquisition System*. DOD Directive 5000.2. Washington, D.C: Under Secretary of Defense (AT&L). May 12. <http://www.acq.osd.mil/dpap/Docs/new/5000.2%2005-12-06.pdf>.

INITIAL DISTRIBUTION LIST

1. Defense Technical Information Center
Ft. Belvoir, Virginia
2. Dudley Knox Library
Naval Postgraduate School
Monterey, California