



Scanned from the collections of
The Library of Congress



Packard Campus
for Audio Visual Conservation
www.loc.gov/avconservation

Motion Picture and Television Reading Room
www.loc.gov/rr/mopic

Recorded Sound Reference Center
www.loc.gov/rr/record

HOME MOVIES



20th Century-Fox Photo

January • 1940

Hollywood's Magazine for the Amateur

... bring the stars of Hollywood into your home

with the finest home movie of them all that shows top notch stars of Hollywood at work and play!

"HOLLYWOOD PERSONALITIES ON PARADE"

2 Reels — Sound on Film — \$25 Per Reel

An invaluable record of Filmdom's greatest names compiled by Jimmy Fidler, ace Hollywood columnist and radio commentator. This high quality film made by direct reduction of master 35mm negative used to make 35mm theatre prints. Some of the 72 stars shown in their best known character parts are: Charlie Chaplin, Harold Lloyd, Mary Pickford and Doug Fairbanks, Ronald Colman, Ben Turpin, Colleen Moore, Rin Tin Tin, Jean Harlow, Marie Dressler, Rudolph Valentino, etc.

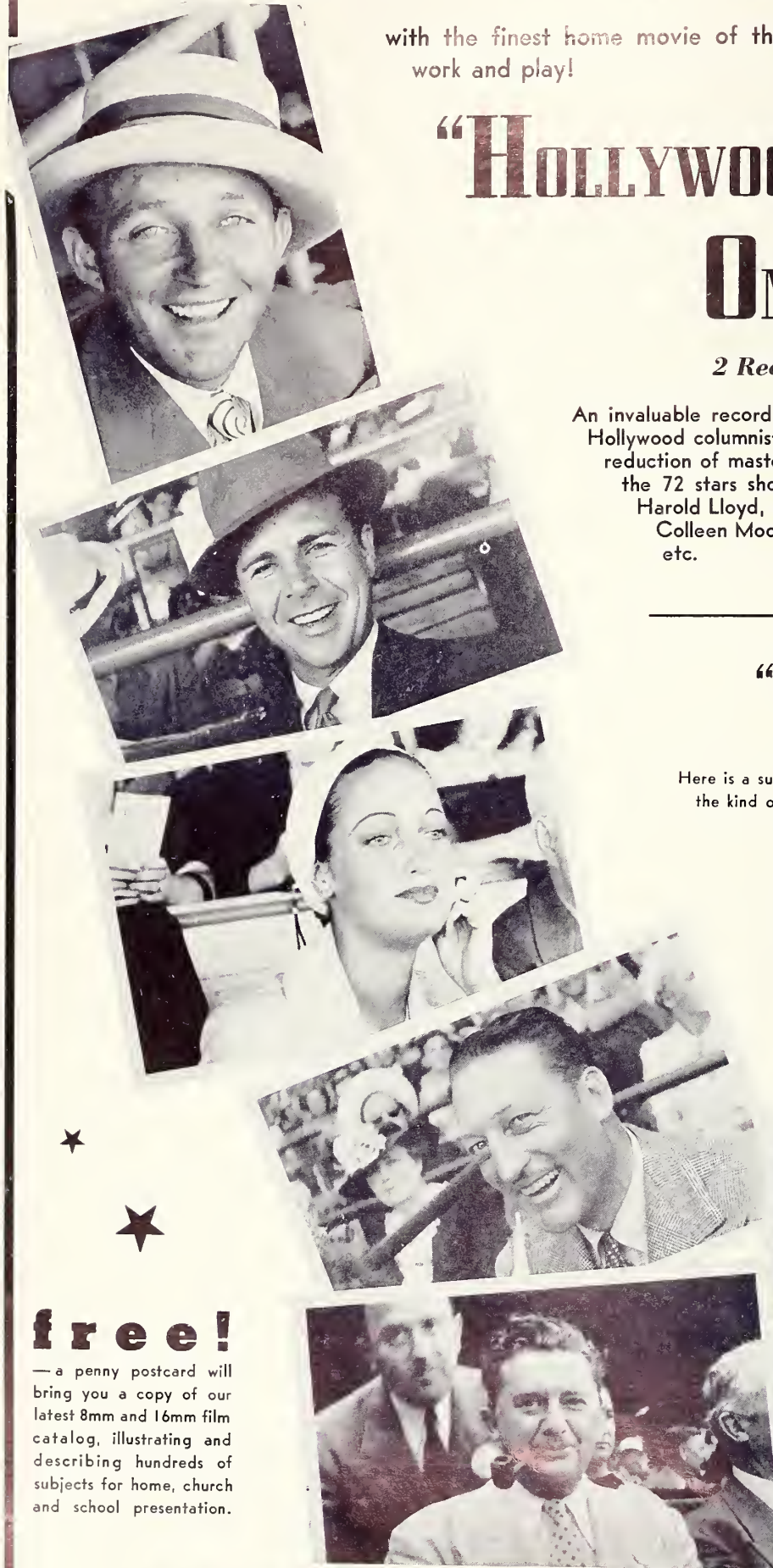

"HOLLYWOOD STARS"

In 8mm and 16mm Home Movies!

Here is a subject that every home movie fan wants! Forty currently popular stars in just the kind of shots you'd like to make of them yourself! Scenes include such players as:

- | | | |
|----------------|----------------|---------------------|
| Shirley Temple | Warren William | Jimmie Durante |
| Ann Shirley | Patricia Ellis | Richard Arlen |
| Hugh Herbert | Lucille Ball | Marian Marsh |
| Joan Blondell | Dick Powell | Charles Butterworth |
| Bob Burns | Deanna Durbin | Claudette Colbert |
| Joe E. Brown | Gary Cooper | Tom Mix |
| Mary Pickford | George Arliss | Greta Garbo |
- and many, many others!

AVAILABLE IN ONE OR TWO SINGLE-REEL UNITS

Reel No. 1—621-A	100-foot 16mm, \$2.50	50-foot 8mm, \$1.50
Reel No. 2—622-A	100-foot 16mm, 2.50	50-foot 8mm, 1.50
Reel No. 3—623-B*	200-foot 16mm, 5.00	100-foot 8mm, 2.50

*Composed of Reels 1 and 2

free!

— a penny postcard will bring you a copy of our latest 8mm and 16mm film catalog, illustrating and describing hundreds of subjects for home, church and school presentation.

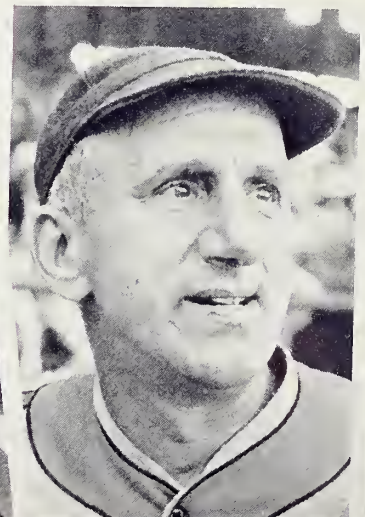

Shirley Temple

Grand Marshal Shirley Temple greets the Queen and presides over the 1939 Tournament of Roses parade; Leo Carrillo on his horse. Specify No. 1050-A.

100-foot	16mm	\$2.00
50-foot	8mm	1.00

Tournament of Roses Parade

Showing the most beautiful and interesting floats in the nation's foremost floral parade in Pasadena, January 1, 1939.

100-foot	16mm	\$2.00
50-foot	8mm	1.00

HOLLYWOOD FILM ENTERPRISES, INC.
6060 SUNSET BLVD. • HOLLYWOOD, CALIF

JAN 16 1940



VP

ADVISORY EDITORS

- ROBERT B. GRIFFITH
Sunkist Movie Club
- ARTHUR E. GIBBS
Portland Cine Club
- LEON S. DVORAK
Suburban Amateur Movie Club
- TIMOTHY P. WALSH
St. Louis Amateur Movie Club
- WALTER A. HOOK
Seattle 8mm Club
- FRANKLIN W. MULLISON
Amateur Cinema Club of Norristown
- ROBERT MERSON CLYMA
Detroit Society of Cinematographers
- ALBERT S. SISSEL
Austin Movie Club
- THEODORE ROTH
Sherman Clay Movie Club
- EDWARD E. SNYDER
Des Moines Y. M. C. A. Movie Club
- CHARLES E. ENION SMITH
Metro Movie Club of Chicago
- FRANK TUART BUSSEY
Super-Art Movie Club
- FRANKLIN SKEELE
Los Angeles Cinema Club
- ALBERT DURAND
3H Camera Club (Movie Division)
- ALBERT D. LEMON
Boise Camera Club
- WARD D. ELLIOTT
Tacoma Movie Club
- ROSS BROWN
Dallas Cinema Club
- FRANK BEZEK
Chicago Cinema Club
- GRANZOW
Greater Oakland Cinema Club
- PHILIP H. GAWLER
Washington 8mm Movie Club
- VIN SWANSICK
Bay Empire 8mm Club
- ALBERT GENDERS
Indianapolis Movie Club
- WILLIAM A. DIXON
Pittsburgh Amateur Cinema Club

home MOVIES

Copyright 1940 by Ver Halen Publications. No part of magazine may be reprinted without specific permission.

CONTENTS FOR JANUARY, 1940

THE READER SPEAKS.....	2
I'VE GOT A PROBLEM.....	4
BACKYARD MOVIES.....	6
DON'T LET EXPOSURE THROW YOU..... <i>By Advisory Editors</i>	9
HOLLYWOOD EDITORS CUT FOR COLOR CONTINUITY..... <i>By James Newcom</i>	10
FOUR "HOWS" FOR MAKING GOOD HOME MOVIES <i>By Chas. W. Herbert</i>	12
MY FRIENDS LIKE MY FILMS..... <i>By Ralph C. Davis</i>	14
16MM CAMERA GROWS UP..... <i>By John Wentworth</i>	16
MOVIE OF THE MONTH..... <i>Reported by J. H. Schoen</i>	18
TELL ME—HOW CAN I IMPROVE MY FILM..... <i>By The Editors</i>	19
EVEN BEGINNERS CAN SHOOT INDOOR MOVIES.... <i>By R. E. Worstell</i>	20
TITLES ARE IMPORTANT AND EASY TO MAKE.. <i>By Geo. W. Cushman</i>	22
STILL PHOTOGRAPHY SECTION.....	23
SPEED OFTEN LEADS BEGINNERS ASTRAY..... <i>W. L. Morgan</i>	24
INTERESTING ITEMS ON STILL PHOTOGRAPHY.....	26
KINKS AND GADGETS FOR THE STILL PHOTOGRAPHER.....	28
IT'S NEW TO ME.....	29
EXPERIMENTAL WORKSHOP.....	30

JANUARY
1940
NUMBER 1
VOLUME VII



- CHAS. J. Ver HALEN
PUBLISHER
- C. J. Ver HALEN, JR.
ASSOCIATE PUBLISHER
- ARTHUR E. GAVIN
EDITOR
- RAY FERNSTROM
TECHNICAL EDITOR
- GEORGE W. CUSHMAN
R. E. MERVILLE
J. H. SCHOEN
ASSOCIATE EDITORS
- COUNT H. C. A. von SCHOENFELDT
A. R. P. S.
PHOTOGRAPHIC EDITOR
- L. C. BUSCHER
ART DIRECTOR

OFFICE OF PUBLICATION
6060 Sunset Boulevard, Los Angeles, Calif.
Phone GRanite 6414

NEW YORK OFFICE
Everett Gellert, 62 West 45th Street
Vanderbilt 6-5254

CHICAGO OFFICE
C. N. Burris, 362 Wrigley Building
Whitehall 7784

as Second-Class Matter, May 6, 1938, at
Postoffice at Los Angeles, California, under
the Act of March 3, 1879.
Subscription rates—U. S. \$2.00 a year. Canada
\$2.50 a year. Foreign \$2.50 a year. Single copies
foreign single copies 35c. Copyright, 1940,
Ver Halen Publications. Advertising Rates on
Application.

The Reader



SPEAKS

See History Being Made!

OWN THE
MIGHTIEST MOVIE
OF THEM ALL!

"NEWS
PARADE
OF THE
YEAR"

Produced by Castle Films in 16
and 8 mm for home projection!

CONTENTS:

U. S. SUBMARINE SINKS
MONTREAL'S LOVE PARADE
PARIS' GREATEST BASTILLE DAY
TENSION AT TIENTSIN
U. S. CRUISERS 'ROUND CAPE HORN
FRANCO'S VICTORY
WINGS OVER ATLANTIC
HURRICANE OVER EUROPE
LONDON'S BIG DAY
GRAIN ELEVATOR DISASTER
CHINA'S FLOODS
EARTHQUAKE IN CHILE



CHINA... Tientsin
Foreign Settlement be-
comes center of great
unrest.



LONDON'S GREAT
DAY... Millions hail
return of Britain's
King and Queen.



SUBMARINE DIS-
ASTER!... 26 perish in
tragic sinking of U. S.
S. Squalus.



WINGS OVER THE
ATLANTIC!... Amer-
ica-Europe air service
becomes reality.

ORDER NEWS PARADE of the Year
From Your Photo Dealer Today
8 mm 50 ft., \$1.75—180 ft., \$5.50
16 mm 100 ft., \$3.50—360 ft., \$8.75
Sound-on-film 350 ft., \$17.50

CASTLE FILMS
30 Rockefeller Plaza • New York City

NEW Castle Films New 1940 il-
lustrated catalog. Send for
your FREE copy today.
Name.....
Address..... B

Seconds The Motion!

In the November issue of HOME MOVIES we published John Derville's letter in which he suggested that all amateur cine clubs acquire prints of each "Movie of the Month" for their club libraries. This reader seconds the motion.

Gentlemen: What a very fine idea is that of John Derville, Jr., who suggests that clubs and movie makers have the privilege of buying copies of the "Movies of the Month." What a grand thought that was! We read of these prize pictures and yet never are given an opportunity to see them, both for their entertainment value and for the wealth of ideas they must contain. It is my hope that you will seriously consider Mr. Derville's suggestion, and that we cinefilmmers may have the pleasure of seeing these pictures in our own homes in the near future.

—Miss Bette Band

Another Vote!

Reader Freres also read John Derville's letter and casts his vote, along with others, on the yes! side.

Dear Sirs: I read with interest the idea expressed by John Derville in regard to having prints made of the "Movies of the Month" for club libraries. I am heartily in accord with the idea, as the obsolete films available from most film libraries are not worth the time to look at. In connection with this, would also suggest that the prints be made available in both 8mm and 16mm width. I'm sure your 8mm prints would be of much higher quality than many I have seen of commercial productions. Hurry the idea along!

—Carl Freres

Swappers

Here are a few cinefilm-ers who would like to do a bit of swapping with other amateurs. One wants shots of the New York World's Fair; the other of Glacier National Park.

Sirs: I would appreciate it if you would tell your readers that I will swap footage of Memphis, Tenn., for shots of Glacier National Park and Blackfoot Indians. Thanks!—Billy Gal-
loway, 229 E. Winchester, Memphis, Tenn.

Sirs: I would like to contact some of HOME MOVIES' readers with 16mm Kodachrome shots of the New York World's Fair to exchange.—E. A. Stark-
weather, 411 N. Spring St., Beaver Dam, Wisc.

Negative and Positive

Here's an interesting phase of movie laboratory work that has eluded the Home Movie Maker. It is using the negative-positive method. It has not been in so great favor because the results are often grainy; but some argue that if the mini-camera users can get fine grain development, why can't the cine-filmer?

Sirs: You may do me and possibly others a great favor by requesting all the followers of the neg-positive method to call for consideration in the columns of HOME MOVIES.

I would be interested in knowing the methods and developers used by others. What they consider the best fine-grain cine film developer for this type of work. In view of the fact there are practically no reversal panchromatic emulsions available here for home development, I would like to work with neg-pos film.

—JAMES H. MOORE.

Color Movies
successfully
taken with

GOERZ

KINO-HYPAR LENSES
f:2.7 and f:3

on Kodachrome, Dufaycolor and other color films. The high chromatic correction of these lenses will yield results which will be a revelation to you and your friends. Clear-cut images, undistorted, of microscopic definition and wonderful, crisp brilliance. Focal lengths 15mm to 100mm — can be fitted in suitable focusing mounts to Amateur and Professional Movie Cameras.

GOERZ REFLEX FOCUSER
— Patented —

A BOON to 16mm Movie Camera users — eliminates PARALLAX between finder and lens — provides full-size ground-glass image magnified 10 times. Adaptable to lenses 3" and up. Also useful as extension tube for shorter focus lenses for close-ups. Extensively used in shooting surgical operations, small animal life, etc.

Address Dept. H.M.I

C.P.GOERZ AMERICAN OPTICAL CO.

317 E. 34th St., New York, N. Y.
American Lens Makers Since 1899

FINE MACHINE WORK



Factory Built Turrets with Focuser.
For Filmo 8\$28.75
For other cameras at proportionate prices.
Backwinds from \$18.50 depending on type of camera.
Automatic Shutter with Frame Counter Victor 16mm\$55.00
Footage and Frame Counters for Editing\$5.50
The Efectograph, a titler that has everything\$12.50 up, depending on accessories included.
Univex Telephoto Lenses remounted for 8 or 16mm cameras from\$4.50
Focusing mounts on any lens from.....\$11.50
Reperforating 16mm film. Extension tubes and other items.

Direct or Through Your Dealer

MacVan Manufacturing Company
(Formerly MacVan Elect. Co.)
3829 El Cajon Blvd. San Diego, Calif.

New 8mm. Projector Gives you *Everything!*

Ampro Offers for the First Time All the Features 8 mm. Users Have Wanted

Yes, every feature that good 8 mm. films deserve — brilliance of illumination, reverse pictures, ease of operation, gentle treatment of precious film, in short a smooth, satisfying performance — is now available through the new Ampro 8 mm. projector.

For years 8 mm. fans have said "give us a projector that does not penalize us for the economy of 8 mm. film." In this new model, Ampro now makes it possible to show 8 mm. film under ideal conditions.

Full 16 mm. QUALITY in an 8 mm. Projector

Still Picture Lever, Automatic Safety Shutter, Reverse Picture Operation, Fast Automatic Rewind, Full 400-Foot Reel Capacity if Desired, 500-Watt Illumination, Flickerless Pictures at Slow Speed, Efficient Cooling for Forward or Reverse Projection, Cool Air Intake Across Aperture Insures Longest Film Life, Automatic Fire Shutter, Automatic Reel-Locking Device, Micrometric Tilting Knob, Automatic Pilot Light, Centralized Controls, Complete Range of Film Speeds, Easy Threading, Quiet Operation, Has 1-Inch F 1.6 Objective Lens, Optical System Corrected for Color Films, Operates on Both AC or DC 100-125 Volts. Priced at

\$98

COMPLETE

SEND FOR CATALOG

of Ampro Precision
8 mm. and 16 mm.
Silent and Sound
Projectors

The latest Ampro Catalog will give you full details on this remarkable new 8 mm. projector and the full story on the complete line of Ampro "precision" 16 mm. silent and sound projectors.

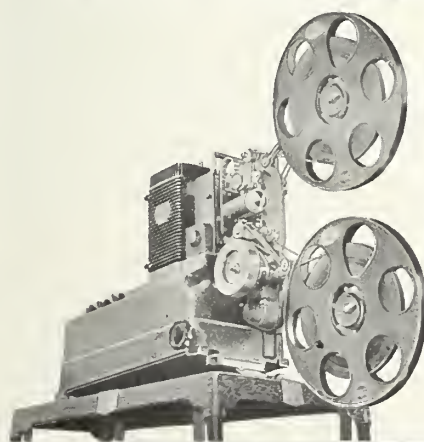
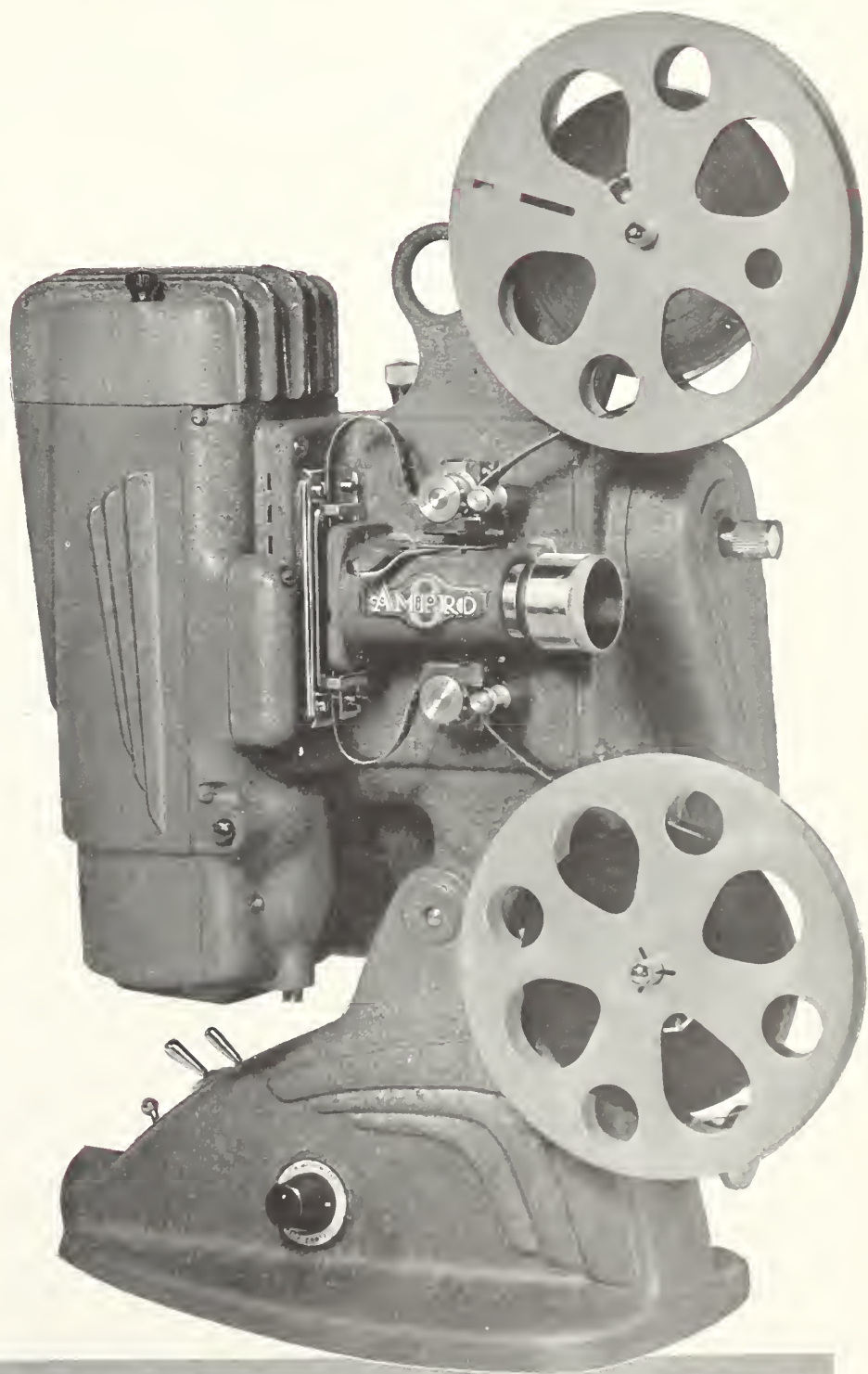

AMPRO

PRECISION CINE EQUIPMENT

Ampro Corp., 2839 N. Western Ave., Chicago, Ill.

Ampro Corporation, 2839 N. Western Ave., Chicago, Ill. HM 140

Please send me full details on the new 8 mm. Ampro Projector. Also the complete Ampro 1940 Catalog of 8 and 16 mm. Projectors.

Name

Address

City State



You'll Like This
KODAK BANTAM (f/4.5)
for Your "Stills"

KODAK BANTAM'S small size recommends it as a handy-to-carry second camera for "stills" on your movie-making jaunts.

Despite its tiny dimensions, however—through modern photofinishing methods—Kodak Bantam leads to black-and-white pictures $2\frac{3}{4} \times 4$ inches.

This novel camera is precisely constructed... has a fine quality Kodak Anastigmat Special f/4.5 lens, accurate 1/200 shutter with four speeds, and body shutter release. Pictures may be made under a variety of conditions and may, if desired, be enlarged far beyond the standard $2\frac{3}{4} \times 4$ -inch size.

Kodak Bantam f/4.5 also takes Kodachrome Film for full-color transparencies. \$22.50... at your dealer's.

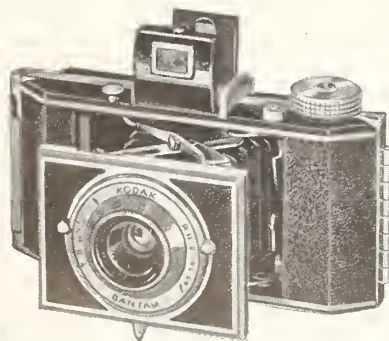

Only Eastman Makes the Kodak

EASTMAN KODAK COMPANY
Rochester, N. Y.

I've Got a PROBLEM

Heads Cut Off (J. H. Newcastle, Chicago)

Why is it that all of my closeup shots are not as I saw them in my viewfinder? In closeups of people, part of their heads are above the frame line, and they are more to the right than as I focused them through my viewfinder. I've just received my second roll of film from the processors and this same fault prevails. Could it be that my viewfinder is not accurately set for my camera?

You have failed to take into consideration that while your viewfinder is corrected to a certain degree for parallax—that is, for the difference in relative position of viewfinder and lens—this correction is limited to scenes filmed at distances of about eight feet from the camera and beyond. In order to insure getting all of your subject into a closeup as you see it in the viewfinder, you should make allowance for parallax by raising your camera slightly so that there is more space between the head of your subject and the top frame line of your viewfinder; also, if your viewfinder is to the right of your lens, move your camera slightly to the right in lining up your subject in the viewfinder, so that there will be more space between the right edge of viewfinder frame and your subject.

Exposure for 8 Frames

(Harry Widener, Cincinnati, Ohio)

I plan to shoot several scenes at a camera speed of 8 frames per second instead of the regular 16. How do I determine my exposure for this slower-speed?

If normal exposure for your camera at 16 frames per second is 1/30th of a

• READERS: This department is for your benefit. Send in your problems and our technical board of professional cameramen will answer your question in these columns. If an answer by mail is desired, enclose addressed stamped envelope.

second, the shutter speed or exposure at 8 frames per second would be twice as great or 1/15th of a second. Therefore, if you are using an exposure meter you will take your reading from the 1/15th of a second marking instead of the 1/30th—indicated on some exposure meters as the 16 frames per second exposure point. If your normal 16 F.P.S. camera speed is 1/40th of a second, then the 8-frame speed exposure rating would be 1/20th of a second.

Soft Focus (James H. Daley, Seattle, Wash.)

What simple expedient would you suggest that would enable me to produce soft focus effects?

While there are excellent glass diffusion discs on the market for cine camera lenses, you can make your own diffusion matte just as the professional cinematographers of the old silent days used to do. Visit your dry-goods store and purchase a small piece of black silk gauze with an even mesh. Possibly you can pick up several remnants of assorted grades. Stretch the gauze tightly over a cardboard disc in which a hole has been cut to fit the lens, or a better method is to make a tube of cardboard about 1 in. long that will slip over the front of your lens. Stretch the gauze over one end. Place the tube over the lens so that the gauze is about $\frac{3}{4}$ in. to 1 in. ahead of the front lens element. The distance of the gauze from the lens governs the degree of softness that will be obtained.

Filmo
Movie Equipment

**Does Not Limit
Your Skill!**

FILMO movie equipment imposes no restrictions upon your skill. The more advanced you become, the better the basically complete Filmo serves you. There are no limits to quality or variety of movies it lets you make. That's why Filmo owners are satisfied owners.

Make your next movie purchase a Filmo. Write today for free literature describing cameras, 8 mm., 16 mm., or 35 mm.; projectors, sound or silent; or any particular accessory in which you are interested. Most literature is in interesting, illustrated booklet form. Write for information today. Bell & Howell Company, 1825 Larchmont Ave., Chicago; New York; Hollywood; London. Since 1907 the largest manufacturer of precision equipment for motion picture studios of Hollywood and the world.

PRECISION-MADE BY

BELL & HOWELL

IT'S HERE...

*A High Speed Fine Grain
Panchromatic Double
Eight Film*

Film those treasured indoor shots without elaborate lighting equipment.

Texan Type 100 is four times faster than any other 8mm film available, Weston 100 and priced at \$2.85 per roll including precision automatic processing. One-day service. If you haven't tried any of this new film there is a pleasant surprise in store for you.

Texan Type 100 is also available for 16mm cameras. Write for prices on other Texan Reversal Films.

*Specialized processing by reversal or negative-positive method using modern automatic developing machines is now available to all.
Prices on request.*

The film laboratory devoted entirely to the Amateur Cinematographer:

Texas Film Laboratory
Liggett Building Dallas, Texas

Give Your New Christmas Projector "a Break!"

THAT'S COOPERATION!

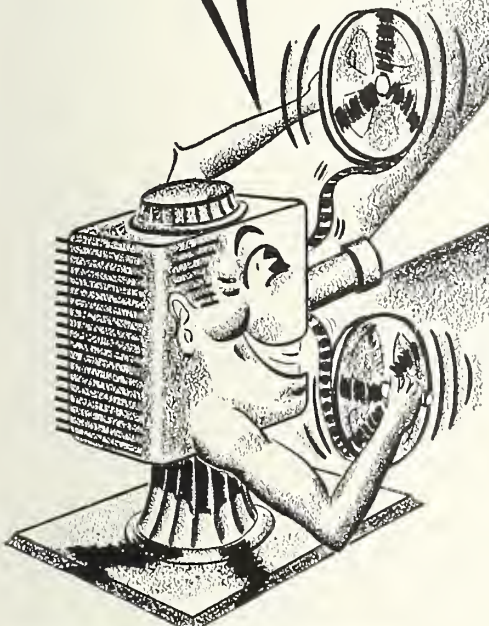

The DA-LITE CHALLENGER, illustrated above, is the most popular of portable screens. It can be set up anywhere in 15 seconds, is the only screen with square tubing to hold the case in perfect alignment and the entire picture in perfect focus. Twelve sizes from 30 x 40 inches to 70 x 94 inches inclusive, from \$12.50* up.

Show Your Pictures on a DA-LITE GLASS-BEADED SCREEN



(Reg. U. S. Pat. Off.)

For full enjoyment of projected still pictures or home movies, you need an efficient screen as well as a good projector. Experienced amateurs will tell you that for brilliant images and sharp details the Da-Lite Glass-Beaded surface is "tops." Its millions of tiny glass beads are super-imposed on the carefully selected white fabric by a special process — the result of 30 years of leadership in screen manufacture. The result is a screen which reflects maximum light and does not sparkle or glare. The beads are guaranteed not to shatter off. The fabric stays white longer than any other white screen surface. Da-Lite makes screens with Silver and White surfaces, but recommends the Glass-Beaded surface as the most efficient for average home requirements. Ask your dealer for a demonstration. See how much brighter pictures are on the Da-Lite Glass-Beaded Screen. Styles for all requirements in a broad range of sizes from \$2.00* up.

*Prices slightly higher on Pacific coast.

DA-LITE SCREEN COMPANY, INC.
Dept. 1HM 2723 North Crawford Avenue Chicago, Ill.

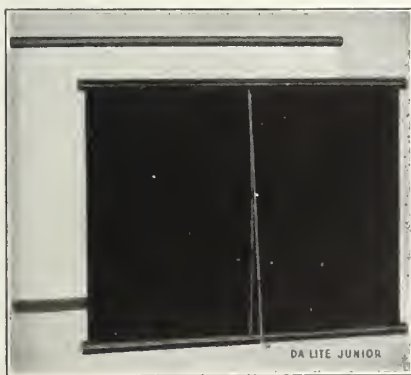

The DA-LITE JUNIOR SCREEN provides the finest in screen surfaces at lowest cost. It has the same efficient glass-beaded fabric as the highest priced Da-Lite Screen. It can be hung against a wall or set up on a table. Ideal for owners of low wattage projectors. Four sizes from \$2.00* up.

Look for the Name  When You Buy!

REG. U.S. PAT. OFF.

BACKYARD MOVIES

Ideas for Random Filming



(They're easy to take with G-E Photofloods)

"Look at these shots from my swell birthday movie," says Mollie. "Daddy's as proud as can be. Says he's going to take lots of indoor scenes now that he knows how easy it is to get such good clear shots with G-E Photofloods."



These are the same high efficiency type bulbs that professional studios use. Their brighter, whiter light gets crisp, clear shots you'll love to show.



Made to fit your needs by the folks who make the lamps Hollywood uses. Simple to operate. Good for hundreds of feet of filming. Two sizes, No. 1 and No. 2, are especially good on home lighting circuits. Buy them where you buy film.

Be sure of better shots... be sure your lamps are "G-E"

New low prices



No. 1
20c
LIST

No. 2
40c
LIST

NOW G-E Reflector Photoflood No. R-2

A No. 2 G-E Photoflood lamp and reflector combined in one unit.

The new G-E MAZDA Photoflood Reflector Lamp No. R-2 provides a smooth beam of light with uniform spread over a 60° angle. The aluminum reflector, hermetically sealed to the glass, is highly efficient and cannot tarnish. Handy for general lighting or special effects. . . . list \$1.10



GENERAL ELECTRIC MAZDA PHOTO LAMPS

The Family Car

Following is a backyard filming idea which is timely, now that the 1940 model automobiles are making their appearance everywhere, and which affords filming all members of the family with a semblance of continuity. This skit could be titled "We Bought a New Car" or "Buying Our New Car," etc., and concerns the trading of the old family "bus" for a new model. You can film shots showing incidents leading up to the purchase, such as the old car failing to start, tire trouble, dented fenders; then close-ups of repair bills, gasoline bills, etc.

Be sure to get shots of the members of your family comparing your car with the neighbors' new one; a family discussion, with close-ups of you or your wife looking over new car catalogs, etc. Follow this with shots of your visit to the showroom, looking over the cars, the try-out spin, with a close-up or two showing your wife's or son's expression as he handles the wheel during the picture, etc. Close the picture with shots of signing the contract, kissing the old bus good-bye, and driving the bright new car away from the salesroom.

—Harvey Schapanski

A Dollar Day-Dream

Here is an idea for a "homey" type of home movie especially adapted for kid actors that may be filmed at this time of year around almost any home. It calls for one or two fades—so be prepared to make these, as they are important to the story.

A DOLLAR DAY-DREAM

Scene 1. Mother picks up pile of papers from davenport.

Scene 2. Mother picks up papers and magazines from small table.

Scene 3. Picks up more papers and magazines from the floor.

Scene 4. She tries to get door open with armful of papers to take them to the garage. Door will not open.

Scene 5. Finds trash on porch against door (outside).

Scene 6. Mother still trying to open door, finally drops papers and magazines and forces door open. Acts very disgustedly and goes outside.

Scene 7. Views trash against door.

Scene 8. Also views trash, leaves and other articles scattered around the yard.

Scene 9. Mother looks off scene and calls to young son.

Title: "Oh, Verne, come here."

Scene 10. Cut to son, Verne, who is playing with the neighbor children. He stops playing, looks off scene and leaves.

Scene 11. Verne enters scene with mother.

Title: "What do you want, mother?"

Scene 12. Mother surveys yard with young son, pointing out trash.

Title: "I'll give you a dollar bill to spend as you like if you will clean up the yard."

Scene 13. Verne, eyes wide open, repeating, "One whole dollar" (close-up). Nods acceptance and dashes off scene.

Scene 14. Verne laboriously cleaning up yard.

Scene 15. Panorama from Verne wiping perspiration from his brow, to yard all cleaned up.

Scene 16. Verne rushes into the house to claim his dollar bill.

Scene 17. Verne rushes up to mother.

Title: "Mother, I'm all

SPOTLIGHT NEWS!

For the Wide-Awake Amateur Photographer Who Desires Clear Pictures With "Professional" Highlighting

A REAL SPOTLIGHT

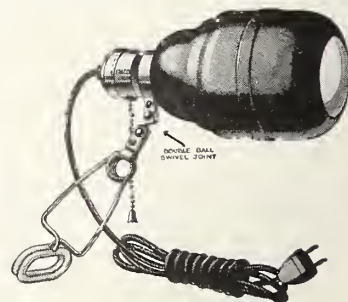

WILLO NO. 88

Low Priced! Efficient!

It's sensational! Equips the amateur to do a really professional lighting job. Spotlight unit completely enclosed. Condensing Lens eliminates all light "spill" . . . giving high intensity to desired spot. Ideal with Dufaycolor and Kodachrome and black and whites.

Has all steel body construction to withstand extreme high heat of No. 1 Photoflood Bulb or No. 212 General Electric photo enlarging bulb, in an enclosure and is finished in heat proof black crackle with a chromium plated pull chain socket. Complete with rubber cord, rubber plug and \$1.35 heavy duty clamp

CHROMASCOPE METAL VIEWER

For Kodachrome Stills



The CHROMASCOPE viewer has a magnification that enlarges your picture so you can enjoy every detail. It is light and compact, and handsomely finished.

Supplied complete with a magnifying or enlarging glass, lamp, automatic switch and six feet of rubberized cord with bakelite socket. It is 6" wide, 5" high and will prove an ornament for either your desk or library table. \$3.00

MAIL ORDERS FILLED

Write Dept. H.M.

Willoughbys

110 West 32nd Street, New York
World's Largest Exclusive
Camera Supply House

through. Where's my dollar?"

Scene 18. Mother presents him with dollar bill.

Scene 19. Close-up of Verne with dollar bill. Eyes wide open, staring straight ahead. Here the scene fades out slowly and into the following to give the impression that the scenes which follow are his thoughts while day-dreaming of what he might do with the dollar bill.

Scene 20. Fade-in. Verne buying malted milk at soda fountain.

Scene 21. Verne buying candy.

Scene 22. Verne buying soda pop.

Scene 23. Verne buying ice cream.

Scene 24. Buying popcorn.

Scene 25. Buys ice cream cone.

Scene 26. Buys more candy.

Scene 27. Verne coming home with expression of not feeling too well.

Scene 28. Verne comes walking into the house doubled up with a pain in his stomach.

Scene 29. Mother views situation. Takes Verne by the hand and leads him off scene.

Scene 30. In bathroom, mother has Verne by one hand and is exploring medicine cabinet with the other.

Scene 31. Close-up of mother reaching for a bottle which reads "castor oil."

Scene 32. Mother administers several spoonfuls to young son, who is making terrible faces.

Scene 33. Mother leads him from the bathroom.

Scene 34. Mother starts to undress him in bedroom.

Scene 35. Verne is put to bed. Here scene fades out slowly.

Scene 36. Fade in slowly, to same scene as the end of scene 19. Verne turns head slightly and notices something in distance off scene.

Scene 37. Close-up of little pig bank on the shelf.

Scene 38. With a grin on his face, he goes over to his bank, carefully deposits his dollar bill. Fade out.—The end. —*B. Lloyd Folger.*

Own it and Cheer!
**A WORLD OLYMPIC
 OF
 THRILLING SPORTS ACTION!**
**SPORT PARADE
 OF THE YEAR!**

In 8mm and 16mm Home Movies



Johnstown Thrills Racing Fans



Britain and U.S. War on Polo Field



Indianapolis Speedway Smash-up



World's Biggest Outboard Race

CASTLE GIVES YOU THE FILM OF THE CHAMPIONS...THE BIG-TIME SPORTS MOVIE PACKED WITH HEADLINE EVENTS OF THE YEAR!

YOU'LL see records topple—new marks set—right on your own home movie screen! You'll have a "front-seat" view of the fatal Indianapolis Auto Race smash-up—your pulse will race while Johnstown wins the Kentucky Derby—John Cobb tears over the Utah flats at 353 m.p.h.! You will be right there while Britain's Sydney Wooderson clashes with Rideout in the Race of the

Century. You'll see the World Series—Ski Winners—Polo Champs—Harvard beating Yale on the Thames—Golf Kings—Speed Kings—Sport Kings—and The Sport Parade's All-American football team in the gridiron season's most spectacular runs... all these and more in ACTION CLOSE-UPS! Expertly photographed—edited by professionals—it's a CASTLE CLASSIC!

EXCITING PROGRAM OF EVENTS!

RECORD REGATTA—Daring skippers stage world's biggest outboard race at Long Beach, Cal.

HARVARD SWEEPS YALE OARSMEN—Sturdy Crimson crew outpulls Eli by length-and-half on Thames.

SPORT PARADE'S ALL-AMERICAN—Spectacular gridiron heroes and plays of 1939.

N. Y. YANKEES AGAIN CHAMPIONS—Conquer Cincinnati, 4 straight, in World Series.

WOMEN SKI CHAMPIONS—Canada stages thrilling winter meet at Quebec.

U. S. RETAINS POLO CUP—Americans defeat British, 2 straight, in International series.

THE KENTUCKY DERBY—"Johnstown" thrills thousands as he outruns "El Chico" at Churchill Downs.

RACE OF CENTURY!—Princeton Mile won by fleet-footed Chuck Fenske against top-notch field.

GOLF CROWN WINNER—The putt that won the championship.

353 MILES AN HOUR!—British sportsman, John Cobb, attempts record run on Utah's salt flats.

AUTO SPEED CLASSIC—Sensational smash-ups in 500-mile Indianapolis marathon of dare-devil drivers.

ANOTHER HOME MOVIE HIT "SKI REVELS"

Fastest growing winter sport in the world! Beginners and champions in the smart lands of snow and ski! St. Moritz, Banff, Lake Placid. Amazing shots that completely cover this exhilarating sport! A film sports lovers will treasure for years.

ORDER Sport Parade Of The Year from your photo supply dealer TODAY!

8mm: 50'—\$1.75 180'—\$5.50 • 16mm: 100'—\$3.50 360'—\$8.75
 Sound-on-Film: 350'—\$17.50

CASTLE FILMS
 30 Rockefeller Plaza • New York City

Send me free copy of Castle Films 1940 illustrated catalogue covering News, Sports, Entertainment, and Novelty Subjects.

Name.....
 Address..... B-1



Ten Timely Title Backgrounds For Typewriter Titlers

by EDMUND TURNER

Here are ten new title backgrounds that will enable you to start out right your 1940 home movie titling. An added innovation is the series of supplemental title captions which appear below and which may be cut out and pasted in the space provided in title backgrounds No. 2, 3, and 10.

One reader recently advised that he took some of these backgrounds to a local printer who imprinted the necessary wording on them with a proof press at very little expense.

Possibly you can use some of the captions that follow:

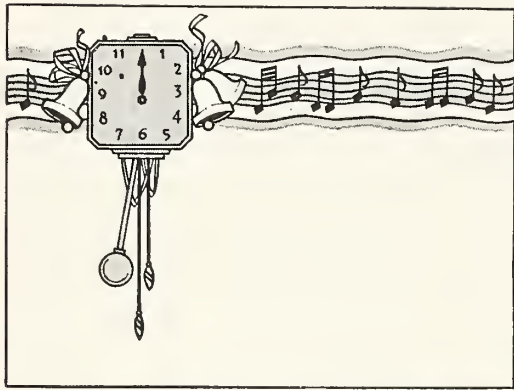

OUR NEW YEAR'S PARTY

1940
Tournament of Roses



OUR DAUGHTER

OUR SON

OUR CHILDREN

OUR 1939
VACATION



PHOTOGRAPHED BY

Readers are invited to submit suggestions for other supplemental title captions that we can publish in next month's and subsequent issues of HOME MOVIES. Such captions should be general in character — such as would be applicable to the greatest number of amateur movie makers. Perhaps you have a suggestion or two for other title backgrounds. If so, send them along too!





Home Movies

MAGAZINE



**Subscription
Order Form**



*Reported by
Advisory Editors
REED E. SNYDER
RUSSELL A. DIXON
and W. E. CLYMA*

don't let EXPOSURE throw you . . . !

THREE of our advisory editors, each an amateur cinefilmer of considerable experience and selected by their respective clubs to serve on our advisory staff, give you the benefit of their many years' experience in telling you about exposure this month.

Editor Snyder writes about the fundamental idea of exposure and its relation to lens markings. Editor Dixon tells you how to use an exposure meter to solve your exposure problems, and Editor Clyma covers the use of lighting equipment indoors and its relation to Kodachrome as well as black and white films.

Reed E. Snyder believes the beginning amateur movie maker should at once fully understand the fundamentals of exposure and particularly the exposure markings of the camera lens. He writes:

"To very quickly allay any fears the beginner may have concerning exposure, I would like to make the statement that exposures with a movie camera are much less difficult than with a still camera, in inexperienced hands.

"First of all, there are just *two* very important things to fix in one's mind so that they will never be forgotten.

"1. Amount of light entering lens is not increased as the stop numbers (or diaphragm settings) are increased. In fact, the result is directly opposite. For example an f/3.5 lens, with stop wide open, will allow more light (about twice as much) to pass through the lens than will the numerically larger stop setting of f/4.5, and so on down the line to f/16. We always say stop down to f 8, f 11 and f/16, and we must remember that this will always mean less light through the lens.

"2. Always remember that you will have more light entering your lens when taking pictures of objects or scenes at a distance from the camera. This is because you are receiving light reflected from a great area. Then, if this is true, there will be less light enter the lens from close objects (close-ups) because the object reflecting the light, in this instance, is much smaller. So we learn from this that we stop down for distant shots and open the lens for close-ups. Of course, I'm speaking now of light conditions being equal. An exam-

ple will illustrate: Suppose we take a scene of a home with a child coming out the door, a long shot, and we use stop f 11. To get a close-up of the child's head and shoulders at, say, 3 feet, we will probably have to open the diaphragm to f 5.6 or f/4.5 to keep our exposure correct.

"And now that we have these two things firmly fixed in our minds, we will discuss briefly this thing called exposure. 'Correct exposure' means that our film emulsion has received exactly the right amount of light to produce a lifelike, clean-cut reproduction of the object photographed. So, exposure is a function of time (shutter speed) and aperture (stop opening). In movie cameras the time of our exposures is fixed, the average being about 1/32 sec. for 16 frames per sec., which is the speed the amateur will use about 95% of the time. You see, really all we have to consider is that diaphragm setting or stop number we discussed previously. You can get a better idea of how this operates by looking into your

• *Continued on page 35*

• Shirley Temple's excellent knowledge of exposure is attributable to the guidance she received from ace cinematographer Arthur C. Miller, shown here schooling Shirley in the whys and where-fors of the "f" stop.

20th Century Fox Photo



Authored by
 JAMES E. NEWCOM*

ONE would think that a studio film editor, through whose hands had passed countless miles of motion picture film and whose routine included the task of reviewing several reels of projected pictures each day, would be the last person to choose home movies as a hobby. But, honestly, I get as much downright enjoyment from shooting, editing, and projecting my home movies as any rabid amateur. Possibly this is because when I shoot my movies, I'm the whole production staff—cameraman, director, scenario-writer, and edi-



HOLLYWOOD EDITORS *cut for color continuity*

tor. I can do my shooting with an eye towards the final and all-important task of editing.

If you have gone hook, line and sinker for color movies—and who has not—you can make your pictures far more interesting and professional-like if you will pay special attention to matching your scenes for color tones both when shooting and editing.

**Film Editor, Selznick International Pictures: Newcom's exceptionally fine job of editing the year's biggest film hit, "Gone With The Wind," practically assures him of the 1939 Academy Award for motion picture editing.*

• Above—Chief film editor, Jimmy Newcom, (left) reviews the final sequence of "Gone With the Wind," with Hal Kern, supervising editor of Selznick International. Below—reproductions from a sequence in the same picture, the editing of which is described in the accompanying article.

Let me tell you of a new filming technique of the cinematographers of Hollywood's studios that is fast being recognized by serious amateur movie makers—a technique that greatly simplifies the task of editing. Director Victor Fleming has given it widest latitude in the current Selznick International production, "Gone With The Wind." It was especially developed for color movies, and is adaptable to black and white films with equal success. It has as its basis, the essential of reducing the number of cuts in a picture to the minimum in order to maintain maximum color continuity in a sequence.

Soon after the advent of Technicolor pictures, it was noted that the cuts in color film were definitely more obvious than in black and white. In the latter, the tones are pretty consistent throughout the picture, but in early color productions the masses of color varied in area and intensity with each scene. And with each change of scene on the

• Continued on page 42



FINE DETAIL

(right)

in the interesting night shot on opposite page resulted from photographer's knowledge of exposure values and wise choice of proper film for job. It's a fine title background for a documentary movie of city or industrial life.

Photo by

Ross W. Madden

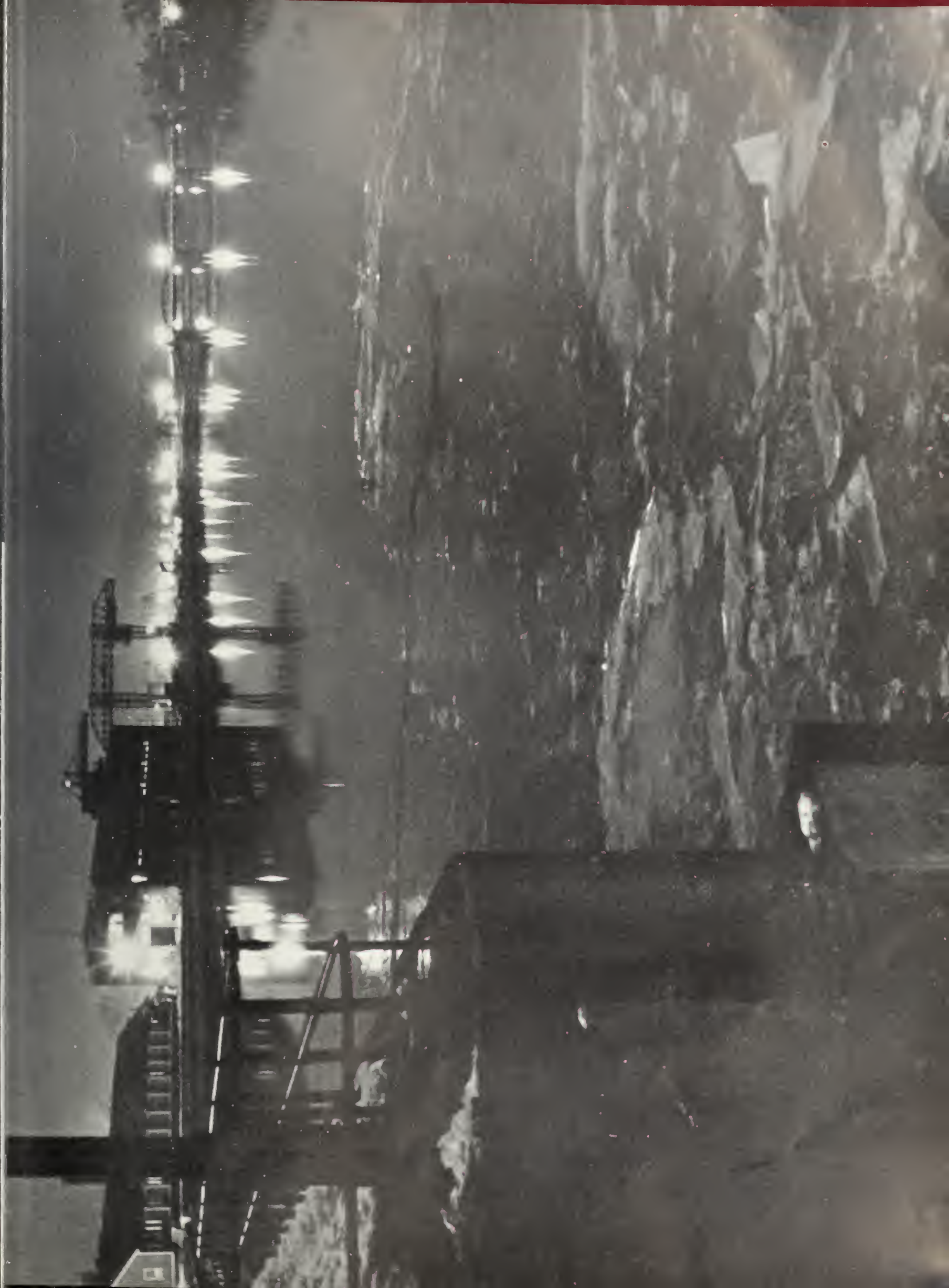

Authored by
CHAS. W. HERBERT

FOUR "HOWS" *for making good home movies . . .*

THE first rule for the successful use of your camera is to have confidence in its ability to make pictures you want.

It is just about safe to say that any narrow gauge camera which is offered for sale by any reputable concern today is capable of making perfect pictures—that is, if you learn its operation, treat it well and give it a chance to click in front of worth-while subjects while it is properly adjusted.

Without question, this same rule applies to professionals entrusted with the most complicated, delicate or important work. No production cameraman, newsman or commercial photographer would think of starting a job with a new camera without first trying it out. Just as a hunter learns the feel of his gun or an aviator senses how a plane responds to the controls, you should learn

• If you've never used a cine camera before, it's a wise idea first to practice loading and unloading it, according to Charles Herbert. This chop seems to be having a little difficulty — obviously too much loop!

Photo by G. W. Cushman



the feel of your camera. You must know just how to load it, just where to set the focus, just when and where to change the speed, just what touch to use on the trigger and just how it sounds in true operation.

If you have never used a camera before, it is a wise idea to spend enough time practicing how to load and unload it, how to set the focus, how to set the exposure and speed, and how to hold and operate the camera.

Use a blank strip of film to practice loading and make all kinds of imaginary set-ups and scenes before you put in a load of real film. Make a general view, follow it with medium shots and close-ups and try to work out a sequence of shots that tell a story. Two hours spent in this manner will be of immeasurable value to you after you actually start to make pictures.

A serious-minded aviator-to-be would not be allowed to, nor would he want to, take a plane into the air until he had practice on the ground. Don't take off on a picture taking spree until you are sure of your controls and know when, what and where to do and what not to do. A plane can be cracked up by one false move, and a camera can be ruined with mistreatment in loading and operating. Besides, a lot of film can be spoiled, time and effort lost merely by making the wrong settings on your camera dials.

Loading the camera and setting the control dials is purely mechanical and can be mastered easily. Practice until you can load with ease and put your fingers on the right place without fumbling. If the camera is loaded properly, it has a definite, recognizable sound in operation. When trouble develops, due to some mistake on your

• Continued on page 44

A WINTER SCENE

(right)

in which an Aero-2 filter was wisely used to render proper tonal values in sky, snow, and ice-covered lake. This makes a nice main-title background for any winter-filmed home movie.

Photo by

Ross W. Madden



Authored by
RALPH C. DAVIS

My friends LIKE MY FILMS — here's why!

FEW, if any, of us make movies just to show to ourselves. Much of the fun comes from watching the various groups of people we know reacting to our efforts.

These groups, relatives and friends, seem peculiarly to enjoy seeing themselves on the screen; and, unless they are unnaturally polite, it's notice-

able they're not quite so enthusiastic about the other folks.

I think it's wise to please them. After all, that's the surest way of pleasing ourselves. And at the same time we are achieving a desirable unity. So, the obvious conclusion would seem to be to place on one reel those who are naturally or often together.

In fact, this might be carried further. Surely it should be in the case of Junior, who by all means deserves a reel of his own. I think it would be safe to say that Grandmother would go for a reel exclusively Junior's practically as heartily as for one of her own, or one in which she played a part.

The changes in all of us, from episode to episode, and in youngsters particularly, is more easily observed without irrelevant material. We may feel we're taking care of both present and future when we arrange in this fashion.

Episodes other than personal or family can be classified on the same principle. Your hunting and fishing friends are going to enjoy nothing more than your reels on sport — and not less so because they themselves appear from time to time.

The same goes for friends who play tennis, golf, and other games. Or who watch football and baseball; while they wouldn't be participating, they get a thrill out of seeing themselves in the vicinity.

However, the subject is too broad to be examined item by item, in full. And perhaps a concrete example would be more helpful. Following is my own. Not as perfection or pattern; indeed, my apology is that it fits only what happens to be my special interests. But that's exactly the point. This real-life classification, with explanations, comments, and, where useful, examples of actual scenes, will suggest similar — or dissimilar — items for you.

• Continued on page 38

Chas. W. Herbert Photo



GOOD COMPOSITION

(right)

and intelligent use of proper filter is clearly evident in the fine photo on the opposite page. It's a swell title background, too!

Photo by

Ross W. Madden





16mm CAMERA



YES—16MM IS growing up! The amateur camera that has found such a beloved place in filming the activities of our families, our vacations and our homes, now is stretching out into business and industry.

16mm movies have literally vaulted over the back fence and are penetrating into factories and invading business offices. And the eager faces that once looked forward to seeing the doings of little Edgar on the home screen, are now tilting the venetian blinds of sales rooms to darken them for screening fascinating sales messages in color and sound.

The projectors that once were magic portrayers of our daily doings and flickered away at 16 frames per second, are now whizzing film through the gate at 24 frames and amplifying surprisingly adequate sound track into convincing sales messages and persuasive advertising to literally millions in America's business concerns, and audiences comprising of clubs, organizations, conventions, sales meetings and fairs of all kinds.

Marvelous, isn't it, when you realize that advertised products now can be dramatized, and their processes of manufacture, otherwise visible only by an actual trip through a plant, now may be pictured in natural color movies. Vitally intimate pictures of uses of products and machinery can be enlarged to a closeup and shown to large audiences. Scenes that could only be observed by a few people at close range now are shown with exact detail in color and with sound. Products or ser-

vice are thus dramatized for greater sales appeal.

The recent rise in popularity of 16mm films in business is due chiefly to business executives becoming suddenly aware of this little brother of the theater film, its power, adaptability, convenience, and economy. No small measure of their success is due to the pioneering efforts of small groups of enterprising amateurs, turned professional overnight by the realization of the unbelievable field ahead of them for interpreting, by moving pictures in intelligent continuity, a selling message infinitely better, surer and packing a greater selling force than other existing forms of advertising.

Manufacturers of 16mm cameras and projectors have been slow to realize the inevitable advance of 16mm movies to the business and professional field, with the result that amateur experiment has brought development of home-made tanks, drums, and processing equipment. And those very tireless, hobby-inflamed souls are the discoverers of the new trends. They have developed new short-cuts to simulate theater quality in amateur movies, by establishing trick fade effects, wipes, windbacks, lens devices and innovations that heretofore have not been available on the 16mm camera and projector market.

These home technicians are comparable to the radio bug of a few years back, who startled the world by setting up home broadcasting sets that were able to penetrate the ether into foreign lands and receive messages that were almost hailed as spiritual accomplishments and their creators looked upon as electrical magicians by their friends and neighbors. Those energetic experimenters are now the pioneers of present radio and the pathfinders of television.

So, too, the garage workshop of the 16mm camera fan is becoming the anticipation of the ultimate perfection and future development of the business film, and that same energetic and far-visioned lad is laying the groundwork for what I firmly believe to be one of the greatest mediums of education and sales America has ever known.

**Former amateur movie maker and Four-Star winner in Home Movies' annual contest, now producing business and educational films.*

• Above—Lighting set-up for scene in 16mm documentary picture now being filmed depicting activities of U. S. Mail service. Below—another fine shot from the same production being shot on 16mm film. Note enhanced detail from use of a filter.



Authored by
JOHN WENTWORTH*

grows up, goes professional!

It is established that over 100,000,000 people witnessed sponsored non-theatrical film performances in 1938. While many of these were 35mm films, in 1939 an ever greater audience viewed business motion pictures and an increasing number of these were 16mm productions, due to the recent advance in camera and projector equipment and technique. A product, to be truly professional, utilizing lap dissolves, fades and double exposures, formerly had to be produced in 35mm film. But now with such effects available in 16mm and in reasonably professional hands, attention is rapidly turning to the narrow gauge film; and the layman audience finds it hard to distinguish between the product that is shot on 35mm film and reduced, and the product made direct on 16mm for 16mm projection.

Recently, a 16mm short was projected from the theater booth at Rockefeller Center in New York, utilizing a high intensity arc projector to bridge the distance to the full size theater screen. Following a 35mm studio feature, as it did, the audience was entirely unaware that they were seeing a 16mm picture; and only the trained eye of a professional could distinguish that a change had been made.

The recent World's Fairs, with their attendant 16mm showings at advertisers' concessions, went a long way toward showing businessmen the immense possibilities of 16mm film and the terrific audience reaction and attentiveness to their interesting sales message in picture form. The miniature auditoriums were constantly packed,

and applause was not uncommon at the conclusion of a performance.

For example, at the San Francisco Fair, one advertiser announced an authenticated report of the attendance of 10,000 persons per week to a 40-minute picture. In New York, another recorded a verified audience of 10,000 persons per day, with an increase to 12,000 on Saturdays and Sundays.

There are many favorable advantages that the business man is beginning to realize in considering production of his motion pictures direct on 16mm film. The least of these is the economy involved. He finds the safety of 16mm film from fire hazards a very welcome consideration. He can mail his picture safely by air or carrier. He can show it without regard to insurance underwriter limitations. He can project it on practically any amateur equipment without a regulation fire-proof booth and professional operator. He can carry an hour's show under his arm with a portable projector in the other, and show his message in a small office intimately to a few and, within a few moments, transport it to an auditorium with adequate results. He can

• Continued on page 40



• Above—An historical scene showing recipient of mail paying postage to carrier, as was the custom in early Colonial days; and—below—showing camera and lighting set-up to make the shot. Bottom of page—Scenes from 16mm Kodachrome business film produced for well known swim-suit manufacturer. Film was distributed nationally and credited with greatly increasing sales volume.



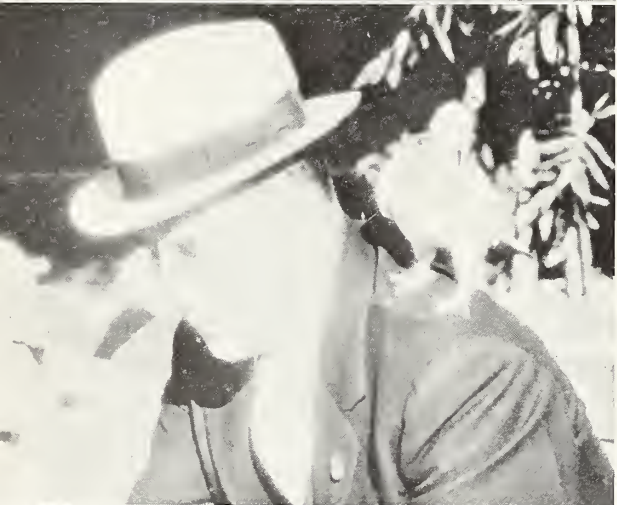

MOVIE of the MONTH

Reported by
J. H. SCHOEN

• Just a few of the many fine scenes from "The Cauldron" which so realistically depicts a slice of life typical of the average city "square." Fine composition, needle sharp exposure, and the unobtrusive manner in which it was filmed make this movie "tops"!

EVERY city, town, and hamlet has its public "square"—lounge of the perennially idle; rest haven of the weary; and forum of itinerant rabble-rousers—a simmering cauldron into which one might casually dip and expose interesting cross-sections of human nature.

It was as a human cauldron that Dr. R. E. Gerstenkorn saw one of these interesting squares through the viewfinder of his cine camera. It was "The Cauldron" which Dr. Gerstenkorn so aptly titled the fine 400-foot 16mm documentary record of his countless days of patient, unobtrusive filming and which the editors of HOME MOVIES have selected as the "Movie of the Month" for January.

The success of a documentary film depends entirely upon the skill of the man behind the camera. Other types of films receive much of their dressing at the editing table, but the documentary film's success often rises or falls upon the camera-editing art of the filmer.

Dr. Gerstenkorn excels in most all of the departments of amateur movie making; but his film "The Cauldron" definitely shows his flair for editing as he shoots—his ability to spot an interesting shot or composition, and to get that shot safely tucked away on the take-up spool of his camera regardless of obstacles.

And there are obstacles in filming just such a picture as "The Cauldron," you may be sure of that. To get the many fine shots of interesting characters loitering in the square without arousing the slightest trace of consciousness that they were being filmed, was indeed a difficult thing to accomplish. But Dr. Gerstenkorn did it, as evidenced by the illustrations on this page, and this is what makes the picture a success.

Next, but by no means less important, is Dr. Gerstenkorn's ability to get his exposures "right on the nose" every time. Never have we reviewed an amateur film where exposure of shot after shot was so consistent. Rarely is such consistency in filming ever achieved, even by the professionals who have the laboratories to fall back on to correct for over- or under-exposure in the final print.

"The Cauldron" opens with a fine introductory title. The early shots serve to establish the locale, but they are far from ordinary. This filmer saw to it that such shots were different. He employed unusual camera angles. He shot panoramas through the veil of water spilling over the rim of the fountain in the center of the square that gave an effect of rain; and he worked right into the heart of his subject—the people—with excellent close-ups.

It is hardly necessary to say that most of these shots were made with the aid of a telephoto lens and with the camera set at some distance from the subjects. To have tried to film these people with the camera set up within the range of their vision would have meant securing "posed" shots with expressions clearly indicating consciousness of the camera before them. Once or twice a character—some wanted vagrant, perhaps—is seen suddenly ducking out of range as he discovers the camera focused in his direction.

• Continued on page 33

Reviews by
THE EDITORS

TELL ME — *how can I improve my film?*

NOT all the letters accompanying films submitted for review are worded exactly this way, but in substance they carry the same request: "Tell me—how can I improve my film?" Two things indicate increasing interest in the amateur film reviews published by HOME MOVIES each month. More and more films are being submitted for review, and the films submitted are rating in the higher brackets. In this review, for instance, all of the films qualified for three stars, and were returned to their producers with attractive animated three-star leaders, indicative of this recognition by the editors of HOME MOVIES magazine.

Every amateur is invited to submit his films for review and criticism—a service that may enable you to improve your home movie filming, editing, and titling. As an added service, all films are subjected to a special safety cleaning process

before returned. Following are reviews of some of the interesting films submitted during December:

"BUILDING A HOME"

★★★

400-foot 16mm — by G. D. T.

This is a documentary account of the building of the home of this filmer, from the time of purchasing the lot to the long awaited day when he moved in. This idea is not at all new, and with the great activity in home building today it furnishes incentive for a great deal of amateur filming. But this film rises above the ordinary because of the very thorough manner in which it was executed.

We are shown this filmer and his wife selecting the lot, signing the contract for its purchase, and

• *Continued on page 33*

• Reproduced here are enlargements of scenes from pictures reviewed by the editors this month. Top row: Interesting shots from "Building a Home." Middle row: Three scenes from "Holland in Color," and a nice close-up from "Towze Tyke." Bottom row: More fine close-ups from "Towze Tyke" and two nicely composed scenes from "Weather Moods."





FIG. 1



FIG. 2

even beginners can shoot **INDOOR MOVIES**

Authored by
R. E. WORSTELL

• FIG. 1: Light intensity at noon on average summer day may average as high as 10,000 foot candles. FIG. 2: Small powerful light sources and high-sensitivity films make indoor filming practicable and easy. FIG. 3: Reflectors collect and concentrate rays of photoflood lamps. FIG. 4: Indoors or out, the essentials of good photography remain the same.

LIGHTS! Camera! Action! Magic words those in the great movie studios. And no less than magical are the products of these studios.

Today one does not have to be a cinematographic magician or even a skilled technician to produce good movies. Films of high sensitivity, color films, together with small, powerful, inexpensive light sources place at our fingertips a ready means of creating priceless, living records of those near and dear to us.

There are three essential elements in photography (Illustration No. 4): camera and film, light, and subject. Light may be divided into two classifications, the sun or daylight, and man-made light. With nature's light there is, relatively speaking, an abundance of illumination (Illustration No. 1)). With artificial light the illumination is as an average far less than with daylight (Illustration No. 2), but is controllable to an infinitely greater degree than daylight. Because artificial light is so flexible, it can be mishandled, and, therefore, serious thought should be given to lighting in indoor cinematography if disappointing results are to be avoided.

The most common light source today for home movies is the tungsten filament lamp. Of the thousands of types available, the Photoflood lamp is the most widely used. The reason for this is that the Photoflood lamp emits a maximum amount of photographically effective light for a minimum of current consumed. Low current consumption is important for the reason that home lighting circuits are not generally designed to carry large loads. Because it is operating nearly at maximum efficiency for tungsten wire, the life of Photoflood lamps is

relatively short. However, it is sufficiently long so that thousands of feet of film may be exposed.

Photoflood lamps are available in three wattage sizes and are designed No. 1, No. 2 and No. R 2, and No. 4. Essential characteristics are as follows:

Lamp	Volts	Watts	Amperes at 115 Volts	Base	Life (Hrs.)
No. 1	105-120	250	2.17	Medium Screw	2
No. 2	105-120	500	4.35	Medium Screw	6
No. R 2	105-120	500	4.35	Medium Screw	6
No. 4	105-120	1000	8.7	Mogul Screw	10

The No. 1 lamp is about the same in size and appearance as a 60-watt house-lighting bulb. Photoflood No. 2, to all outward appearances, looks like a 150-watt general service lamp. The R 2 lamp has somewhat the shape of a large door-knob and has its own reflector as an integral part of the bulb. It is equivalent to a No. 2 Photoflood in a good reflector. The No. 4 Photoflood, since it employs the mogul base is not generally used for home movies.

With no other load on the circuit as many as six Photoflood lamps No. 1 and three Photoflood No. 2's may be used on a circuit fused for 15 amperes. When adding up the load on a circuit it is well not to forget any house lighting lamps, appliances, etc., which may be turned on at any time. Otherwise, blown fuses may result, and blown fuses can be very embarrassing.

Nos. 1, 2, and 4 Photofloods are also available in blue bulbs. These are recommended for supplementing daylight either outdoors or indoors with color film of the daylight type.

Another tungsten filament lamp which has been employed occasionally for home movies is the 500-watt T-20 bulb projection lamp. It has a life of 50 hours and is available either in a clear bulb or in an inside frosted photographic

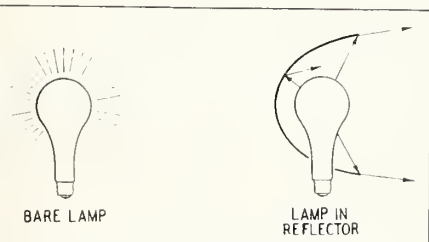

FIG. 3

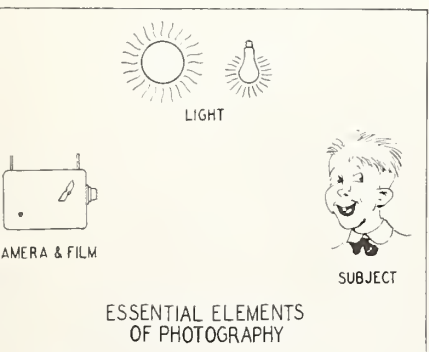

FIG. 4

blue bulb. Unlike the Photoflood lamps which may be burned in any position, the 500-watt T-20 must be operated within 25° of vertically base down. While the first cost of this lamp is high, its operation over the period of its life is quite economical.

There are many other tungsten filament lamps available for use in special equipment for creating certain lighting effects, for example, spotlight lamps. So from the standpoint of light sources the home movie technician is well endowed.

Light sources are seldom, if ever, used without some type of reflecting equipment. There is a threefold purpose in using a good reflector—efficiency, quality and shielding.

Light from a bare lamp is emitted in all directions (Illustration No. 3). If bare lamps were used the same amount of light would fall on the subject as on other objects in the room. Since only the subject need be illuminated, and since none too much light can be secured at best, it is in the interests of efficiency to redirect at the subject the light from the lamp which would normally be largely wasted around the room.

The sharpness of a shadow for a given distance is a function of the size of the light source. Therefore, a bare lamp casts a fairly sharp shadow. When a well designed reflector is employed, the diameter of the reflector becomes the diameter of the light source and shadows are softened accordingly. In general, the larger the reflector the softer will be the shadows. Although harsh shadow effects on occasion may be desirable, the average general service lighting unit for home movies should create reasonably soft shadows.

With any camera it is necessary that direct light from light sources be kept from entering the lens. Otherwise, this "negative" light will expose all or a part of the frame and thus obscure the subject being photographed. A reflector, of course, is an excellent means of accomplishing this shielding.

For all-around use, a "floodlight" type of reflector is recommended. This should have a beam spread of from 50 to 60 degrees. By beam spread is meant the angle of the cone of light which is emitted by the reflector. It is desirable, too, that the pattern or outline of this cone be not too sharply defined.

Most reflectors are made of aluminum and are generally furnished with the reflecting surface slightly depolished, although there is some excellent equipment on the market with polished aluminum reflectors. Small size lamps such as the No. 1 Photoflood are, as a rule, provided with reflectors of 8 to 12 inches in diameter; the No. 2 Photoflood with reflectors 10 to 16 inches in diameter. Inexpensive paper reflectors may be obtained which, although they have a somewhat wider beam spread than is necessary, are nevertheless fairly satisfactory.

Reflectors may be obtained with clamp-on sockets for quick attachment to chairs, doors, etc., by means of a large spring clamp. They are also available with telescoping stands which are light in weight, small in bulk, and exceedingly portable.

For the more advanced cine enthusiast, there are spotlights and other special units for creating unusual lighting effects.

There are certain basic lighting arrangements that would be well for the beginner to follow.

• Continued on page 37

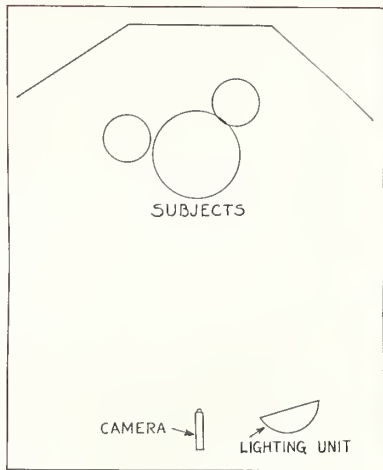

FIG. 5

• Above chart shows placement of light source in making photo at right — a single unit placed near camera.



FIG. 6

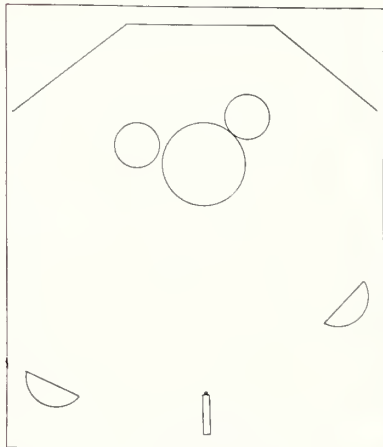

FIG. 7

• Above chart shows position of light sources in making photo at right — two units, one at a greater distance than the other, do an effective lighting job and provide modeling effect.



FIG. 8

• Chart and photo below show effect of adding a third light unit, to the same arrangement, for lighting the heads and shoulders of subjects. Note sparkle and greater depth of scene.

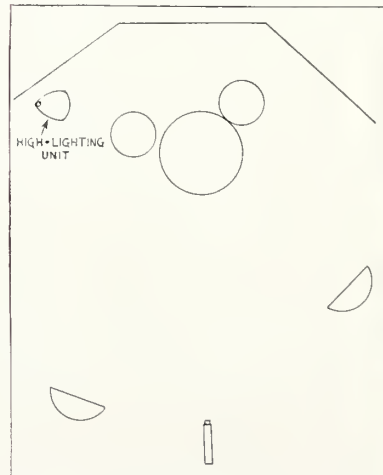

FIG. 9



FIG. 10

Authored by
GEO. W. CUSHMAN



TITLES *are important and easy to make*

IF SANTA left a new movie camera in your stocking Christmas eve, no doubt you have already shot your first roll of film, survived the terrible anxiety of awaiting its return from the processors, and have screened it several times on your home movie screen.

If you had the average luck with your first roll, you had good luck; for the beginner usually does have a pretty well exposed roll for his first attempt. In case you wonder why, it's because you followed your instruction book carefully. And let us add that as long as you do follow instructions, you will have surprisingly good results.

You're pretty proud of that first roll. You'd probably like to title it. Now a title, as we all know, is a bit of printing spliced into the film here and there to explain it. Of course we movie fans don't like our reels all full of titles, yet on the other hand we do like enough to explain the film to the audience. Then too, we like a title at the beginning to tell the audience the name of the picture, and a "the end" title at the end to tell them it has finished.

Before long you will want to put these titles into your film, but first you'll probably want a lot of questions answered as to just how to go about it. First, let us say, these titles are nothing more than just plain, lettered cards, white letters on black backgrounds being preferred since they are easier on our eyes than white backgrounds and black letters.

I use the typewriter size title for 90 per cent of my titles. This is the most economical method and the easiest to use of the many title-making processes. With my typewriter titler, I set my lights well to the side, about nine inches away, and, using positive film, I set my exposure between $f.5/6$ and $f.6/3$.

Some amateurs prefer to use small, white pin letters on a large piece of black composition board. Others like wood block letters. Then there is a magnetic kind which sticks to a metal background. But whatever the type the amateur prefers, the process remains virtually the same.

After the wording has been made on the background, the title cards are photographed just the same as any close-up or "ultra" or extra close close-up. But before we go any further, let us explain just what is meant by a "close-up." Although it's rather a relative term, a close-up usually means a shot where the subject is not more than a few feet from the camera. Such shots would include any small object, such as a flower, a person's head or hands, a small emblem, and so on. And so, in making a title, we merely make a close-up shot of the lettered card we have made.

But before you make your first title, let us caution you about three adjustments you must carefully make if you want your title to be clear and sharp. The first of these is the exposure. A black background with white letters doesn't need quite as much exposure as an average scene. This means that you may close down your lens one stop. If, for instance, you are shooting a scene out of doors in the sun at $f/8$, you can shoot the title in the same light at $f/11$. The same decrease in exposure also holds true when shooting titles under artificial light.

The second obstacle you are likely to encounter is getting your title centered on the film. When shooting at such close distances, you cannot line up your title card through the finder on the camera because, on subjects less than 6 feet away, the finder due to its displacement from the lens takes in a slightly different field than the camera lens.

• *Continued on page 45*

© Home made titlers are easy to construct and to use and give perfect results when adjusted for accurate title card alignment.

STILL PHOTOGRAPHY *section*

- Speed Often Leads the Beginner Astray 24
- Portraits With 100-Watt Spotlights 26
- Taking the Developer Apart 26
- Infra-Red Photography 27
- Selecting the Right Filter 27
- Kinks and Gadgets 28
- When to Use Tripod 28
- Reducing Negatives 28
- Negative Density Range 28
- Camera Into Action 28
- Other articles helpful to Still Photographer will be found on pages 9 and 20.

• Photo by Chas. W. Herbert.



Authored by
W. M. LEE MORGAN



A "fast lens" on a cheap camera is likely to have all the ills that a lens is heir to: lack of definition, chromatic and spherical aberration, and so on. Even the maker of the very finest lenses has to make many adjustments and compromises to limit the fuzziness in his fast lenses to an allowable "circle of confusion."

When a fast lens is used wide open, the depth of field—or area which is in sharp focus—is quite shallow. It increases as the lens is stopped down, however, so it is desirable whenever possible to shoot at stops smaller than wide open. A good f/1.9 lens stopped down to f/5.6 is identical in use and results with a good f/5.6 lens wide open.

Only under extremely adverse lighting conditions, where action is to be stopped also, will the full speed of an extremely fast lens be required.

SPEED often leads the beginner astray . . .

THE beginner in still photography is likely to be misled as to the value and correct use of present-day extra fast lenses, super-super-sensitive film, and very fast shutter speeds. Certainly these remarkable achievements in photographic engineering have opened up undreamed-of possibilities, and, correctly used, they are of untold value to the worker.

It is the misapplication of these essentials that frequently shows up in lack of quality and definition in the beginner's photographs.

There was a time (not so very long ago!) when f/4.5 was considered quite a fast lens. Today lenses are made with speeds that would have astounded the photographer of a few years back: f/2.8, f/1.9, f/1.5! Lens-makers had claimed that such speeds were impossible to achieve. Now there is even an f/.9 lens made—the diameter of the lens is greater than its focal length!

The beginner is often under the impression that the faster lens he can get on his camera, the better pictures he will make. Such a belief is a mistake. Fast lenses are of extremely intricate design, made up not of one piece of glass, but of several of different hardness and kind. These elements must be carefully ground and cemented together.

• Film, lens and shutter speeds are photographic essentials requiring the beginner's careful study, if good pictures are expected.

Don't make the mistake of shooting everything wide open just because the lens is "fast" and expensive.

At the other extreme is the "pin-hole" amateur who always shoots everything at f/22 to get the greatest possible depth of field. There are several objections to this. For one thing, when shooting under below-average light conditions, he will have to use slow shutter speeds, with the danger of the subject or the camera moving, causing blur.

Then, too, it is not always desirable to have everything in the picture in sharp focus. If the subject in the foreground is the center of inter-

• *Continued on page 46.*

IT'S THE PATTERN

(right)

that makes the picture on the opposite page of a dude ranch maid starting her daily round of bed-making. Interesting and novel patterns are always good picture material.

Photo by

Ross W. Madden



Portraits with 100-watt Spotlights

There is, of course, no "correct" way to light any subject—there are as many ways as there are photographers. Balance is the important thing, and what we are trying to do is to reproduce lighting effects which will be natural, balanced, and real.

It is interesting to analyze light sources in the average living room. Windows, doors, artificial light from chandeliers, floor lamps or other sources, combine with reflections from walls, furniture and other bric-a-brac, to form a light-pattern. Your eyes will see a different light-pattern than mine or the other fellow's, but we must all admit the most interesting portraits and the most interesting scenes which we actually see have many light sources.

This source of light is one of the reasons why spotlights lend themselves so readily to portrait work. They are so easily shifted from one position to another, and, with the use of "snoots," "barn doors" or other shades, together with proper diffusers, lights and shadows are so much more easily controlled than when using Broads or a strong one-source light.

To analyze light sources and to reproduce them in portrait work—even approximately—spotlights, in my opinion, should be used.

The new fast films, which we are all using, enable us to photograph in a much lower key. How far we are going in this direction is still a question.

In close-up work, the problem of lights is often very trying, and, in common with most of you, I am constantly using new ideas and methods to obtain lighting effects with balance, depth and composition.

Recently, I made some very interesting portraits using only small 100-watt lamps called "Dinky Inkies." My subject for these tests was Miss Adele Pearce, RKO starlet.

The full face portrait with the smile was made with only two "Dinky Inkies"—the profile shot was made with three, and the close-up, with four.

On previous occasions, I have tried to use low-wattage lights, but most of those tried have been little furnaces—unhandy and offering burned fingers every time you touched them. The light delivery was inadequate, and to change the focus was impossible once you had turned them on and set them in position.

The great advantage of the "Dinky Inkie" is that it has the instant focusing device which you can spread from a small spot to probably a 40 degree flood simply by moving a small lever. With this device, you can set the light close

to the subject and vary its intensity or spread to properly balance the light and shadow.

In these pictures of Miss Pearce, no diffusing materials were used, and I found that I had to be careful not to over-expose the negatives. Of course, one of the principal advantages of a small light—such as the "Dinky Inkie."—is that it is so small you can hide it behind a book, set it close to your subject without discomfort, or back it up in a corner to dig into those places which have, on many occasions, spoiled the composition of an otherwise perfect picture.

—Ernest Bachrach, of the
RKO Portrait Gallery.

Taking the Developer Apart

For many years developing formulas were considered somewhat standardized. Then along came new developers to combat grain size—developers containing unheard-of compounds. Some of these fancy-named concoctions passed quickly out of the picture, while others have achieved a definite popularity with darkroom workers.

In order to understand the actual workings of a developer, it will be interesting to examine the essential component parts which go to make it up. From this we will also know what to expect from a given formula.

The chemical that really does the work of changing the exposed silver bromide into black silver grains is known as the *developing agent*. Those well-known in developing formulas are: pyro (pyro-gallol); metol (sold often as Elon or Pictol), and hydroquinone. These last two are usually used together in a solution, as metol alone would produce a completely developed but rather flat negative, while hydroquinone has the property of building up contrast. Other developing agents now in use are: glycin, paraphenylene-diamine, rubinol, amidol, and others.

In most cases, the developing agent alone cannot act on the silver bromide, but requires the presence of an alkali known as the *accelerator*. The most common compound used for this is sodium carbonate, although borax is also used. Caustic soda (sodium hydroxide) is used when great contrast is desired,



as in copying. Time of development is controlled by the quantity of the accelerator.

While developing agent and accelerator alone will bring out the image on a film, the solution would rapidly oxidize in the air and lose its developing power. For that reason a *preservative*, or compound that itself oxidizes readily, is added. Usually this is sodium sulphite. This chemical also has a very slight developing action on the film.

One other chemical needs to go into the developer. An active developer may tend to develop too fast on the strong highlights, causing them to "block up." Potassium bromide is therefore added as a *retarder*. In a print developer, a high potassium bromide content produces warm tones, while a low content

gives cold, blue-black tones.

There are, then, four essential compounds to replace the conventional component parts to a developer: developing agent, accelerator, preservative, and retarder. New developers introduce new formulas, but basically the parts remain the same.

Putting the developer back together again, we add the chemicals in the order given in the formula, dissolving each completely before adding the next. There is good reason for this, as otherwise we might find a chemical insoluble. Warm water (about 125° F.) is used to facilitate dissolving. For critical, fine grain work, or when dyeing or toning, distilled water should be used. Rain water, filtered, is a satisfactory substitute.

Infra-Red Photography—How To Use It

AMONG the newer negative materials now available to the amateur photographer is Infra-red film. The emulsion of this film is sensitive to the invisible radiations above red on the spectrum. The rays have properties similar to light; that is, they are absorbed or reflected by the objects on which they fall. However, this absorption and reflection is considerably different from that of visual light. Quite startling effects are observed in infra-red photography.

As the film is also sensitive to the blues and violet portion of the visible spectrum, it is necessary to use a filter to admit only infra-red rays. Orange (such as Wratten G), red (A), or deep red (F) filters can be used.

The haze-cutting properties of this film are quite remarkable. A distant landscape which appears flat and indistinct when photographed with usual panchromatic material will show sharpness of detail and almost complete absence of haze when taken with Infra-red film. This makes it an invaluable aid to the aerial-photographer, the geodesist who maps the earth's surface, and the astronomer. Infra-red film is also used professionally in photomicrography, and in medical, documentary, and other scientific fields.

The photo-amateur, however, will want to know what results to expect of Infra-red film used pictorially.

The sky absorbs infra-red rays and appears almost black (if the recommended filter is used). Clouds, which reflect the rays, stand out in dramatic relief against the dark sky.

Trees, lawns, and shrubbery reflect

infra-red rays to a surprising degree, appearing almost white in the picture. On the other hand, water absorbs the rays almost completely, and so appears black.

Skin tones are rendered a chalky white, with every slightest wrinkle accentuated as a dark line. The eyes become two black dots. Infra-red film, then, is obviously not suitable for portraits.

Another property to be noted is lack of detail in the shadows. The film should not be used for contrasty street scenes or where rendition of shadow detail is important.

Your best subject-matter for infra-red photography is a wooded lake, or the waterfront, or trees on a cliff overlooking the sea, or even the city park. Until you are well familiar with the results obtainable, it is best to follow the old advice of your snapshot days: "Keep the sun at your back." The peculiar absorption and reflective qualities of infra-red will supply the contrast you need to make a dramatic photograph.

A recommended exposure when the film is used with a Wratten A filter is 1/25 second at f/5.6. On hazy, cloudy days, this exposure would remain basically the same, even though an exposure meter might show a substantial drop in visual light. As the average amateur has no means of measuring the intensity of the infra-red rays, he must learn through experience which conditions call for less, or more, exposure.

Infra-red film is sold in 35mm and 120 sizes, as well as in standard cut film sizes.

Selecting the Right Filter

THE proper use of filters adds quality and definition to your pictures, while a filter which is incorrectly applied can ruin them.

The average amateur photographer uses filters for one or two purposes: correction or contrast.

Filters correct when they give a rendition in black-and-white values as the eye sees them. Although panchromatic films are sensitive to all colors, they do not render these colors in their true relative gray tones. Thus, blue will be recorded as lighter than green, while the eye sees it darker. All films are somewhat over-sensitive to blue and ultra-violet rays, so in order to give a true rendition, a filter that absorbs some of these rays is used. Some panchromatic film has added red sensitivity, so a filter must be found that will absorb some of the red rays as well as the ultra-violet and blue, for a true monochromatic representation.

The yellow K-2*, yellow CK-3 (for movies), and deep yellow G filters absorb all ultra-violet light and provide the correction required for some types of panchromatic material (for example, those designated by Eastman as "Type B"). The G filter over-corrects somewhat, rendering a blue sky darker than the eye sees it.

Panchromatic emulsions (those called "Type C" by Eastman) which have extra red sensitivity are corrected by a light green filter (X-1). This, besides absorbing all ultra-violet rays and some blue, transmits only part of the red rays, rendering correctly related tones in black and white.

Filters are often used to produce contrasts different from those seen by the eye. Frequently it is desired to photograph an object which has a background of objects of different color, but of approximately the same tonal value. In order to make it stand out, a filter is used which will transmit the color of the object, causing it to photograph lighter than the background.

Often detail within the subject can be brought out vividly, as for example, the grain in mahogany furniture when photographed through a red (A) filter on panchromatic film. This same filter will produce greater contrast in the copying of a blueprint by recording the blue much darker than it appears to the eye. Yellow stains on objects or papers to be photo-copied are eliminated

*Designation of Wratten filter only. Many other makes of filters are available.

Bring Your Camera Into Action

Most amateur cameramen have had this experience when some notable event, worth picturing, has occurred: Perhaps it's a visiting celebrity; perhaps it's a plane crash or a fire — or it may be only an expression on the baby's face or something the cat is doing. But you fuss and fidget with your camera until the subject is gone—and you have no picture.

Get into the habit of bringing your camera into shooting position with the first inkling of a possible good subject. Don't waste time debating whether you really want to take it or not — decide that while you are getting ready.

Note quickly the type of light you are dealing with, set the shutter, estimate the lens stop, and get in focus swiftly. Don't try to take a light reading if there

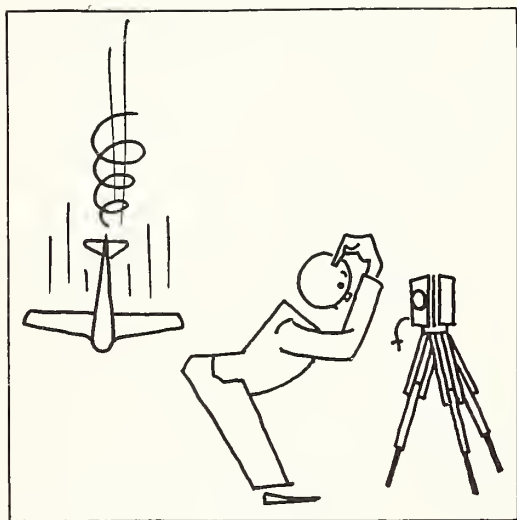

is danger of your subject getting away. Get a picture first — then make a few a little more slowly if you like. Wait, of course, for a good expression or the best action. But don't wait too long. Get one picture of the subject safe in your camera — and you won't feel too sorry if Fate makes you lose some others.

When to Use a Tripod

A tripod is a clumsy piece of equipment at best. It is bulky to carry around — along with a camera and accessories. When you take it on a street-car, someone sits on it. When you set it up, you pinch your finger. And when you are finally set up, someone will surely trip over one of the legs. Why, then, use a tripod?

Amateurs who have really worked with them know the answer — to get good pictures. Some amateurs always use a tripod, even at shutter speeds where the camera held in hand is "safe" for sharp negatives. But the serious amateur would rather make sure. And

KINKS and GADGETS

he has the full range of his camera's potentialities, whereas the amateur shooting from a hand-held position has already limited his. He can't stop down for greater depth of field if it takes him below 1/50 second shutter speed.

In subdued light, in night shots, in interior shots — anywhere that calls for the slower shutter speeds — the amateur with the tripod has the advantage. In making copies, in photographing small objects, the tripod is invaluable. Getting used to the tripod is something the beginning amateur must learn, but once he has, its many possibilities begin to unfold.

Reducing Negatives

There are two entirely different situations when reduction of density is desired in a negative. One is in the case of over-exposure, the other when the film has been over-developed. Often the amateur will wish to rescue a negative which has had a bad overdose — either in the camera or in the darkroom.

A badly *over-exposed* negative tends to be dense all over. The problem is to reduce it and, at the same time, to increase contrast between highlights and darks. The following formula (Farmer's) is recommended for this:

Solution A: Water, 1 ounce; potassium ferricyanide, 15 grains.

Solution B: Water, 1 quart; sodium thiosulfate (hypo), 1 ounce.

Before mixing the solutions together, the negative should be inspected to see that it is free from dust. If it has just been developed, fixing and washing should be carried out as usual before it is reduced. Only one negative should be handled at a time.

The negative is placed in a white tray. The two solutions, A and B, are mixed together and immediately poured over the negative. This mixed solution decomposes rapidly.

When the negative has been reduced to the desired density, wash it thoroughly and dry carefully. Local areas

can be reduced by washing the negative and applying reducer with a wad of cotton.

This reduction method can be carried out under white light.

Over-developed negatives have also a high average density but are considerably more contrasty than a normal negative. That is, highlights and high middle tones are "blocked up" almost to maximum, whereas low middle tones and darks have built up much slower, causing great contrast between highlight and shadow and a lack of good middle tones.

Negatives of this type must be reduced in such a way that *both* density and contrast are lessened. The following formula is designed for this purpose:

Flattening Reducer (Agfa): Potassium ferricyanide, 1 ounce, 75 grains; potassium bromide, 1/4 ounce, 40 grains; add cold water to make 32 ounces.

Bleach the negative in this solution. Then wash it thoroughly and *re-develop* in an average negative developer, as Agfa 47 or Eastman D-76. (Do not use a fine-grain developer.) The negative is then fixed and washed in the usual manner. Reduction by this method should be done in subdued light.

Gamma and Negative Density Range

Photographers often speak of developing a negative to a certain "gamma." As generally used, gamma refers to the range of density, or contrast, in a film, which increases with development time. However, two negatives, each correctly exposed, may be developed to the same gamma, and still be widely varying in contrast. We see this when we compare two negatives on the same roll of film, one taken on a foggy day, the other in brilliant sunlight with strong contrasty shadows.

So, then, another factor determines

SCENE BRIGHTNESS RANGE	CONTRAST GRADE OF PAPER			
	SOFT	MEDIUM	HARD	VERY HARD
4			1.2 or 1.3	1.0 or 1.1
8	1.2 or 1.3	1.0 or 1.1	.8 or .9	.7
16	1.0 or 1.1	.8 or .9	.6 or .7	.5
32	.8 or .9	.6 or .7	.5	.4
64	.7	.5 or .6	.4	
128	.6	.5	.4	
256	.5	.4		

SHOWING GAMMA AT WHICH TO DEVELOP FOR GIVEN "SCENE BRIGHTNESS RANGE" AND PAPER CONTRAST

contrast besides development time, and that is the scene brightness range. This is the ratio of the darkest shadow to the brightest highlight, and it can be

• Continued on page 46.

"IT'S NEW TO ME"

By CINEBUG SHOPPER

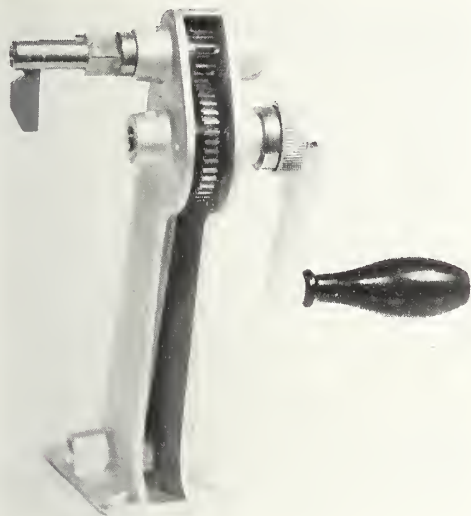

Cinea Winder

To the line of film equipment which they distribute, American Bolex Company has added the Cinea Winder, reputed to be the only rewind in the 8 and 16mm field that has adjustable tension and drag.

One of the features of the Winder is an unique braking device which allows the operator to adjust the tension on both feed and take-up reels to the exact degree needed to provide ease and speed of winding and at the same time obviate spinning and backlashing.

Another feature is that the Cinea Winder takes both 8 and 16mm reels, of either 400 or 800 feet capacity. An easily attached auxiliary base increases capacity to 1600 feet.

New Castle "Sport" Film Ready

Not only for sport lovers all over the world, but for every lover of sport and action, Castle Films has produced The Sport Parade of the Year, by far the most elaborate and outstanding subject of its kind ever compiled for home movie enthusiasts. Added to this year's film compilation of champions of the past twelve months in record-breaking events, Castle Films offers for the first time its own All-American football team selection as a feature of this release.

The Sport Parade's All-American has been selected by Don Hancock, associate editor of Football Thrills of 1939, and who in selecting the ten headline games for that release, reviewed on the screen, practically every major game played

during the current season. Other record events included in the new Sport Parade of the Year are: the world's biggest outboard race in California, Harvard oarsmen triumphing over Yale in the season's rowing classic, the New York Yankees winning the world's series for the fourth straight time, champion women ski events in Canada, the United States polo team defeating Britain in the finals of the international polo games, "Johnstown" outrunning "Chico" in the famed Kentucky Derby, the putt that won the national championship in the national golf finals, fleet-footed Chuck Fenske winning the race of the century at Princeton, John Cobb of England crashing over Utah's salt flats at 350 miles per hour, and sensational full screen shots of the fatal smashups in the 500-mile Indianapolis marathon of dare-devil drivers.

Colored
Titles

A to Z Title Outfit

Jacob Stein, 175 Fifth Ave., New York City, offers a simple title making outfit with which any amateur may produce beautifully lettered title cards of professional quality simply by tracing the outline of any of the several styles of letters illustrated in the "A to Z" Titling Outfit. For Kodachrome titles, the tracing may be done with water colors or crayon to produce interesting, colorful titles as illustrated here. Although so simple any one may use this titling kit, complete instructions and illustrations of a variety of titles are included with each.

Fade-O-Mask for Titles

Western Movie Supply Co., of San Francisco, remind that their recently introduced home movie accessory, the Fade-O-Mask, is especially adaptable for making fades and special effects in

titles. Titles may be framed in a variety of designs including binocular, heart, diamond, oval, circle, and keyhole — masks for which effects are included with the Fade-O-Mask.

"Dinky Inkie" Spotlight

A powerful, yet small-sized, light weight, inexpensive, all-purpose spotlight to highlight portrait subjects, and for greater flexibility in modeling close-ups; to eliminate shadows and dark corners in indoor movies; for table-top photography, and hundreds of other photographic purposes, is the "Dinky Inkie" spotlight.

It is easy to carry and set up on your tripod; locks in any position; operates in absolute silence; will not heat up excessively, even after hours of use. Light output will focus from an eight-degree spot to a forty-four-degree flood. Lever arm, protruding from both front and rear, is moved from side to side for instant focusing from spot to flood. Numbered graduations enable duplicating of given focus position.

The "Dinky Inkie" is manufactured by Bardwell & McAllister, Inc., Hollywood, California, who supply incandescent equipment used in the Hollywood motion picture studios.

Besbee Titlescope

For movie amateurs who indulge in title making, as well as making ultra closeups of any kind with their movie cameras, the new Besbee Titlescope will come as a long-awaited boon.

This new device is a compact, pocket



size, easily operated dial, which gives all the information necessary for successful results in the shooting of closeup objects with the movie camera. This

• Continued on page 46.

THE EXPERIMENTAL

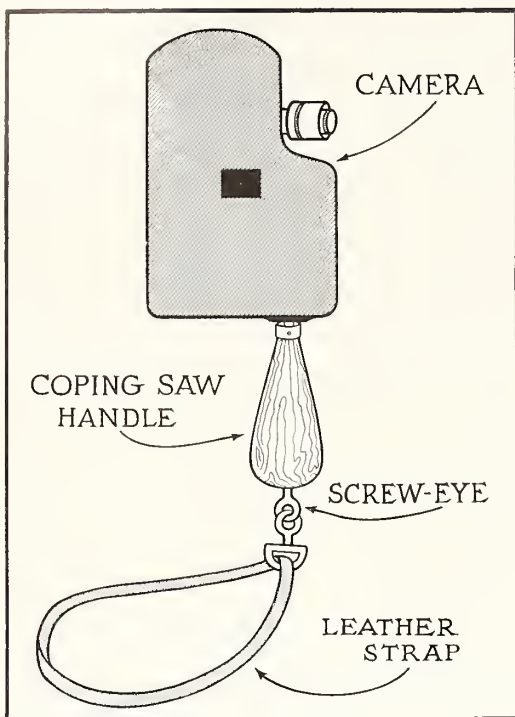

Camera Handle

The use of a handle attached to any cine camera permits a firmer grip to be taken on it and makes for steadier pictures. I found the wooden handle of a popular priced coping saw had a threaded screw that fitted perfectly the threaded opening in the base of my camera. At the bottom of the handle I fitted an ordinary screw-eye to which I attached a wrist loop of leather.

Keeping the camera-holding hand away from the front of the camera in this way solved my problem of inadvertently placing my fingers or hand before the lens while shooting.

—O. A. Kimbrough

Tripod Head

Cinebugs who wish to make a strong and efficient tilt-pan tripod head may do so at very little cost. The necessary parts are obtainable from a plumbing

shop or hardware store. Secure a 1-in. pipe union of the "ground joint" type in either iron or brass, and a floor flange to take the same size pipe as the union. Have the threads in the male end of the union machined off except for the last $\frac{3}{8}$ in. This is joined to the floor flange by means of a very short nipple screwed into the flange as far as possible.

The upper half of the assembly carries the swivel and camera support. The tilting arrangement of the head in the photo was made from a section of an old electric fan standard which was forced into the other end of the union as shown. The tilting element was drilled and tapped to take a $\frac{3}{8}$ -in. rod to be used as the handle rod. A turned wood-

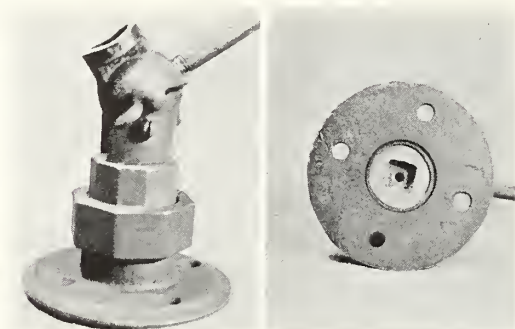

en handle—a wood-chisel handle will do—is fitted on the end of the rod.

The large octagonal nut of the union is used to lock the panoram movement or to regulate tension of the panning motion. Second photo shows bottom of head—or the flange, in this case—into which a pipe plug has been screwed, sawed off, and tapped to take the tripod screw.

O. C. Smith

tached at either end. When rewinding film, place cardboard over splicer as shown, holding it in place against baseboard with the tape.

—Wm. J. McGloughlin

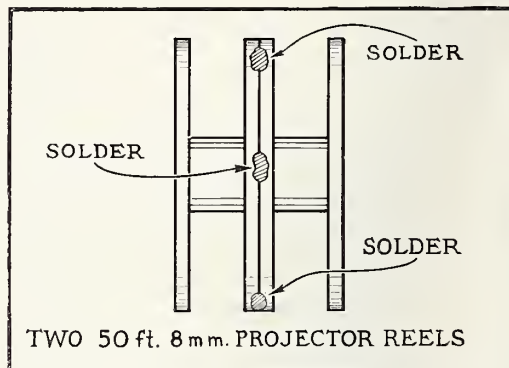

Film Slitting Aid

By soldering two 50-ft. single 8mm projector spools together as shown, the spooling of slit double 8mm film can be accomplished much easier and with greater protection against damaging film emulsion. To solder, remove with a file or other abrasive the enamel from edge of reels at point to be soldered—just a drop of solder at three or four points along the edges will do. File off any rough edges at soldered points. Make sure rewind spindle holes are lined up accurately before soldering.

The "twin" reel will then fit your re-winds and both sections of the slit film may be wound at one time. In transferring unexposed slit film to camera spools, a rubber band slipped over the film on one reel will keep it from unraveling.

—Thomas Schickle

Film Cabinet

The film cabinet illustrated here will not only protect your films from light and dust but will enable you to carry them safely and comfortably when showing pictures outside your home. The cabinet was built from $\frac{1}{2}$ -in. ply-



CINEBUGS!

• If you have an idea for a gadget, trick, or shortcut in filming, titling, editing or processing home movies, pass it on to your fellow Cinebugs through these columns. If your idea is published you will receive two reels for your efforts. Extraordinary ideas will net you a roll of film.

Ideas not published will be held for future publication unless they duplicate ideas previously received. Endeavor also to send along photos or rough sketches illustrating your suggestions. There is no limit to number of suggestions you may submit.

Names and addresses of contributors of published ideas are furnished a prominent manufacturer interested in acquiring rights to saleable gadgets on a royalty basis.

Important: When submitting ideas, be sure to mention whether equipment you use is 8mm or 16mm, enabling us to promptly forward awards adaptable to your use.

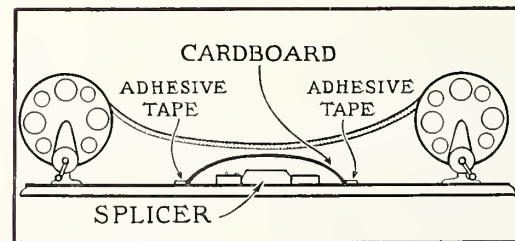

Editing Safeguard

In rewinding film during and after editing, there is often possibility of scratching the emulsion if the film is allowed to run slack against the splicer, most of which have projections of some sort on the surface.

A simple preventative is to keep a square of cardboard handy with strips of adhesive plaster or scotch tape at-

C I N E W O R K S H O P

wood. Outside dimensions are: Length, 11 in.; width, 7½ in., and height 7½ in. Four small rubber "buttons" provide scratch-proof legs on the bottom of cabinet. The streamlined carrying handle was obtained from the dime store.

The individual film containers were made of cigar box material, and the hinges and catches were salvaged from some fancy cigar boxes, obtained from a local smoke shop. Regular brads were used in putting the film boxes together. Inside the cover of each, a piece of ruled paper is pasted for use in listing the contents of the film. The pictorial decorations are colored illustrations clipped from magazines and pasted on the boxes to brighten them up a bit.

The larger box shown in the illustration is intended to hold miscellaneous film scraps, splicer and film cement.

—R. C. Crichton

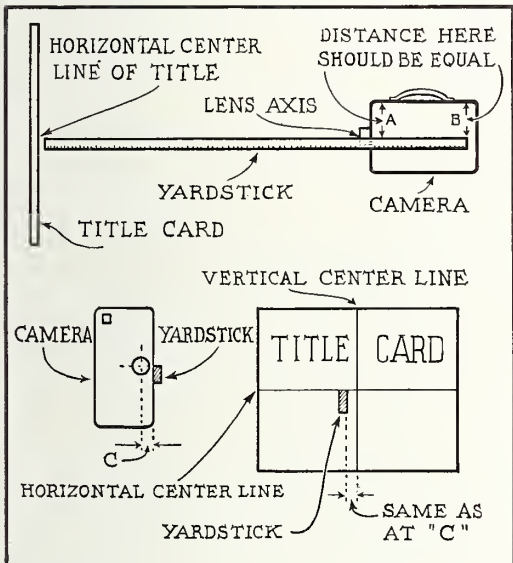

Title Centering

Cinefilmmakers who prefer to shoot titles on cards from distances of 2 to 4 feet may find this "yardstick" idea of value in centering titles. It works especially well with Eastman cine cameras. As shown here, clamp a straight yardstick to the left side of the camera, using small clamps or heavy rubber bands, so that one edge is parallel with the lens axis. Exact parallel may be insured by equal measurements at "A" and "B" as shown.

The yardstick protrudes in front of the camera toward the title board. The edge in line with the lens axis should point to the horizontal center line of title card. The vertical center line will be to the right of the yardstick edge the same fractions of an inch in measurement as the dimension secured at

"C"—or the difference between the center of the lens of your camera and the edge of the yardstick.

If you wish to shoot at distances beyond the reach of the yardstick, sight along the edge as you would along the barrel of a rifle. Lock your camera in position, making sure it is level with title board, and go ahead and shoot.

—R. E. Murphy

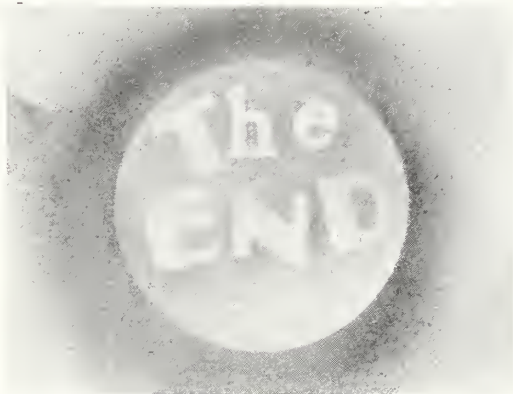

Air-Brush Backgrounds

To produce titles and title-card backgrounds with professional "air-brushed" effects, I purchased a "touch-up" spray-gun for less than 50 cents in a popular auto supply store that gave me the desired results. This spray-gun operates from an ordinary "spare tire" or inner tube for its compressed air supply.

While I haven't had much time as yet to experiment with this gadget, I have found that ordinary water colors are a little too thin to work satisfactorily through this gun. I tried some of my wife's nail polish and it works fine. One of the titles made with this material is illustrated here. Regular lacquers made especially for use with these spray-guns can be used in making air-brushed titles and are obtainable from the same source as the spray-guns.

—J. Mendelson

Wipe-off and Mask Device

Illustrated here is a simple mask device that will also make wipe-offs. Purchasing an aluminum liquor "jigger" or measuring cup, I severed the small cup as shown and filed the small opening so that it would fit snugly over my camera lens barrel.

With a small coping saw, I cut slots 1¼ in. deep on either side, making sure they were cut exactly in the center of the cup. These were finished absolutely smooth to insure free passage of the wipe-off and other masks. Two pieces of

gadgets, tricks and short cuts contributed by Cinebugs

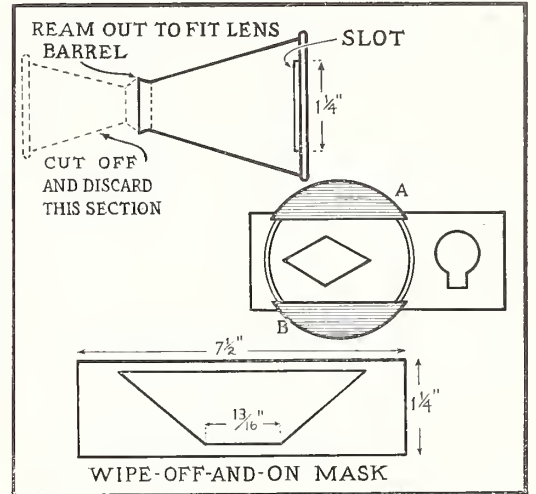

cardboard were then glued to the front of the device, as shown at "A" and "B" to prevent any stray light reaching the lens.

The effect masks and the wipe-off strip were cut from stout black "cover" paper, obtainable from most any stationery or paper house.

Reaming out the small end of this device and cementing a small strip of felt around the edge will make it fit more firmly over the camera lens.

—Harold Grundy

Indoor Light Standard

A support or a stand to hold an extra photoflood unit may easily be rigged up by using an ordinary ladder-back or rail-back chair, a broom stick, and two or

• Continued on page 46.

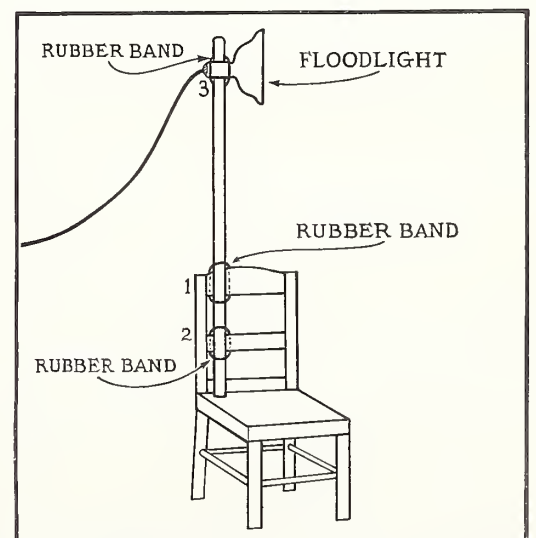

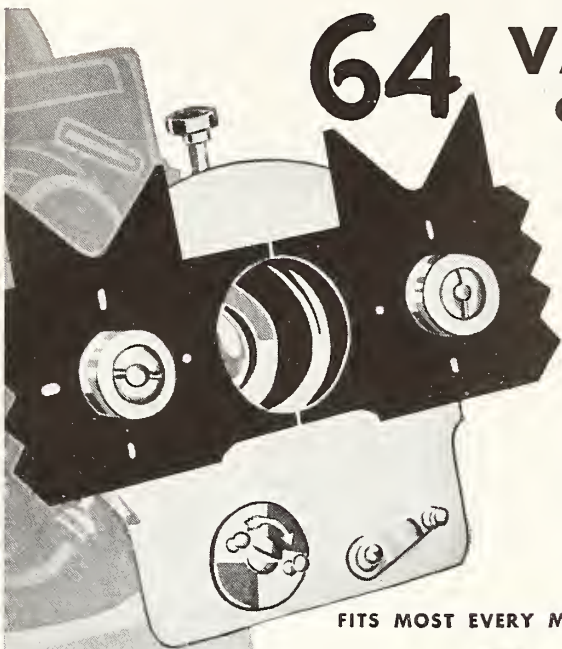

64 VARIETIES OF FADES AND DISSOLVES

Fades are made by the two leaves moving simultaneously either to open or to close the aperture in front of the camera lens. The duration is timed by clockwork mechanism. Sixty-four different basic effects are possible. Does not interfere in field of most viewfinders. Fades can be made with either sharp or soft edges. The **BOOL** holds filters and vignette masks. Smartly finished—all metal—compact—light-weight. Complete with extension tube, cable release and instructions \$17.50

Write for 12-page illustrated folder.

FITS MOST EVERY MOVIE CAMERA

A MIRACULOUS DEVICE

Personal movies need novel techniques to make them more interesting. Good scene and title transitions add to the easy flow and story value of a film. Why not make your fades and lap-dissolves "as you go" with the handy **BOOL**. The **CINE-FADER** can also be used effectively over the lens of any projector.

THE Bool

THE CINE-FADER

EVERY AMATEUR MOVIE PRODUCER NEEDS ONE!

AMERICAN BOLEX COMPANY, 155 E. 44th ST., NEW YORK

Selecting right filter . . .

• Continued from page 27.

through use of the deep yellow G filter.

Dramatic water and sky effects are achieved through use of deep yellow and red filters. They also bring out the textures of outdoor subjects, darkening the small blue shadows which reveal the surface roughness of sand, fabrics, building materials, etc.

The deep yellow G and red A filters have the valuable property of haze penetration. Slight under-exposure through the red A filter produces a moonlight effect.

It should be remembered that since a filter absorbs part of the light that would ordinarily reach the film, greater exposure is necessary. This increase in ex-

posure is represented by the "filter factor." For example, the yellow K-2 filter has a filter factor of 2 with "Type B" and "Type C" panchromatic emulsions, which means that double normal exposure must be given either by opening up one stop or halving the shutter speed. Filter factors vary for different makes of filters, for the film used, and the type of light when the picture is taken. Most films give filter factors for the common filters, both in daylight and under artificial light.

The filters mentioned are for use with black-and-white emulsions only. Never use filters with color film except those recommended by the manufacturer.

STEADY... Get Better Shots with a ROYAL TRIPOD WITH PAN HEAD

Rock-steady support for the camera on a Royal Tripod gives a professional firmness to pictures on the screen.

Made of tubular rustless steel and brass, the legs of the Royal are adjustable instantly by the new "Quick-Lock" friction control. A quick turn and the

legs slide in or out to the height you want; another quick turn and they lock immovably.

Automatic leg stops prevent the legs from sliding out too far. Rubber tips protect rugs and polished floors. Opens to 56 inches; folds to 30 inches. Weight, 6 pounds. Shipping weight, 8 pounds.

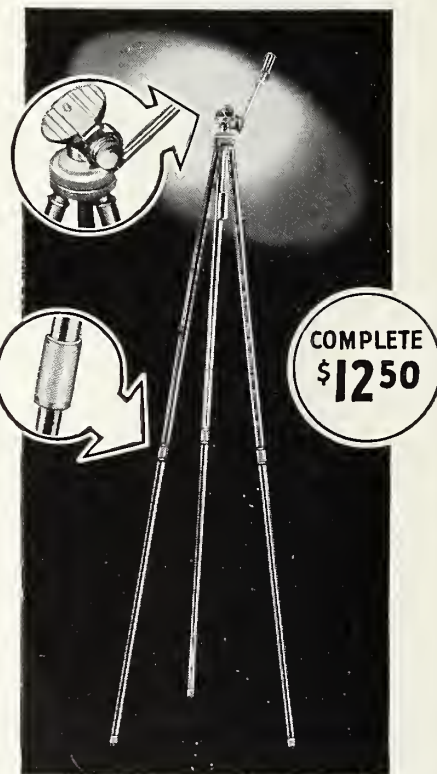

COMPLETE \$1250

and the ALBERT UNIPOD

Sensational new 33-inch walking stick with leather thong extends and attaches to camera as a single-legged support — satisfactorily firm for many shots. Especially convenient in a crowd or in a corner. Famous Royal Quick-Lock secures it with a turn at any height (to 59 inches). The Unipod is attractively finished in rustless chrome over lightweight tubular steel with black plastic handle and rubber tip.



Albert

ALBERT SPECIALTY COMPANY,
231 S. Green St., Dept. A-6, Chicago, Ill.
Please send descriptive circular on Albert Royal Tripods; also, if checked , on the Albert Unipod.

Name.....
Address.....
City..... State.....

Movie of the month

• Continued from page 18.

Most interesting is the sequence of shots of the soap box orators in action, and the silent listeners with drab, almost disinterested expressions, surrounding them. We are shown the whole gamut of life that unravels in a day in a public square. The artist sketching. An itinerant bootblack, busy as a bee. A shop-girl stopping to rest on a bench reserved for women and reading a freshly-opened letter. We can almost sense its contents from her expression. There are bewhiskered old-timers slouched comfortably on the benches, silent, unmindful of those about them. Old women, munching questionable edibles from wrinkled paper bags. All of these, and more, are vividly recorded by the patient, artful Dr. Gerstenkorn.

As this interesting film draws to a close, it is climaxed by finely edited shots of those inevitable park-bench reformers, ringed by a score of frozen-faced onlookers, warming up their pet peeves or theories. In clever contrast is

the closing shot of a flock of doves perched peacefully on a tree branch overlooking the frothing orators below.

Just as the artist, pictured by Dr. Gerstenkorn in the early part of his picture, came to the square to record, with sketching pencil, the interesting faces he saw there, so did this filmer choose the same locale to unlimber his artistry in picturing a slice of life with a home movie camera. The vivid results he obtained are attributable to his keen sense of knowing good filming material when he sees it; to the fact that he has mastered his camera thoroughly; and to his flair for obtaining needle-sharp focus and consistently accurate exposure on every camera set-up.

"The Cauldron" from the viewpoint of general interest is the equal of almost any of the documentary "shorts" currently seen in theatres. Nor could the professionals have improved upon "The Cauldron" except, perhaps, by adding sound.

Can I improve my film?

• Continued from page 19.

then poring over countless folders and architectural booklets in quest of the "ideal" floor plan. There are shots of the man on his knees, yardstick in hand, measuring his living room floor, and of he and his wife sketching floor plans in the midst of countless drawings which fill the table.

The day finally arrives when an acceptable plan is found, and construction gets under way. There follows shots of every phase of home construction, most in semi-close-up, from laying of the foundation to shingling the roof, applying the siding, fitting the sink tile, painting and papering

clear up to the time the contractor hands them the "Notice of Completion" for signatures. Indeed, this film might well go into the library of some enterprising school as an instructive reel on modern home building.

Only a few under-exposed shots marred the quality of this otherwise excellent film, but exceptions must be made considering the circumstances under which it was filmed. In view of the limitations of the f/3.5 lens on this filmer's camera, he did remarkably well in shooting many shots of the interior of the home during its construction, where no reflected or auxiliary light

PROFESSIONAL OR AMATEUR
EDITING
"MAKES" THE PICTURE

CRAIG

ALWAYS SPECIFY FOR YOUR EDITING NEEDS

MANUFACTURERS OF FINE EDITING EQUIPMENT SINCE 1929



CRAIG 16MM SENIOR SPLICER

Operates in the professional manner... only four easy operations needed to make perfect, straight splices—quickly, accurately, and without wetting the film.

For Sound or Silent film . . . \$10.00

New Junior Splicer — adaptable to 8 or 16mm film \$2.50



CRAIG PROJECTO-EDITOR

Action-edit your movies the Hollywood Studio way — transform random "shots" into interesting continuities that everyone will enjoy seeing. The Projecto-Editor provides a unique viewing method — allows careful inspection, slow motion if desired, of actual movement on its brilliant miniature screen. Complete with Splicer, Rewinds, and film cement. 8mm model . \$27.50
16mm model . \$49.50



CRAIG SPLICER AND REWIND COMBINATION

A complete editing and repair outfit. Essential equipment for all cinematographers.

8mm model with Junior Splicer and Rewinds \$7.25

16mm model with Senior Splicer and Rewinds for sound or silent films \$19.50

With extension bases for 1600-foot reels \$22.00



BUY WITH CONFIDENCE—USE WITH SATISFACTION
AT ALL DEALERS

CRAIG MOVIE SUPPLY CO.

1053 S. OLIVE STREET 149 NEW MONTGOMERY ST.
LOS ANGELES, CALIF. SAN FRANCISCO, CALIF.

are reminded that he has "come of age" when we see him smoking his master's pipe.

There's an extra leaf or two in the four-star laurel wreath for Mrs. H. L. T. for the very complete tit-

ling job done on this film. It's as near a 100% titling job as we have seen in a long time.

Only a little excess footage here and there kept this picture out of the four-star class.

Exposure for beginners

• Continued from page 9.

camera lens. Move the stop setting to f/3.5, then to f/16 and you will see at once how this 'light valve' works, always remembering that there is approximately 100% difference in amount of light allowed to enter lens from one opening to the next."

And now Russell Dixon tells why he believes a good exposure meter is imperative to best photographic results.

"Exposure is a matter of recording an action on a film in such a way that it will appear natural and pleasing on the screen. It involves the choice of the right type of shots and the selection of the thing or action to be emphasized as well as the correct setting of the lens. No one should attempt to take movies without using a good photoelectric meter, preferably one with a narrow angle of vision such as those made especially for movie work. First, study the simple mechanics of the meter and learn to use it correctly. With the meter set for the emulsion speed of the film in the camera, the conversion of a given reading into the 'f' stop is simply a matter of becoming familiar with the instrument. The more important matter is to learn how to take a reading. All movie subjects fall into two broad classes: the general or 'long-shot' and the specific or 'close-up.'

"The first is a scene in which objects over a wide area and from a few feet to infinity are viewed through the finder of the camera. Such scenes are seldom satisfactory and should be

used merely to create a locale for what is to follow. Often when reaching a hill-top we shade our eyes from the intense skylight so that we can more clearly see and appreciate the view. Similarly, we should shade the 'eye' of the exposure meter so that the light it records comes mainly from the lower half or two-thirds of a general view. Tilting the meter so that it 'sees' only the objects below the horizon is a good practical rule. Then set the camera to the 'f' reading computed on the meter and shoot the scene while holding the camera rock steady. Remember the action must occur in the scene and never in the camera, since a movie camera can only record a series of still pictures.

"The second type of shot, the 'close-up,' simplifies the exposure problem and makes your movies interesting. Proceed as you do with your eye. After you have seen the general situation, select a part of it for more detailed study. Pick out objects and move up to them for critical examination. If the first scene is a yard full of playing children, the next scene should be of a given child and his actions, or a small group and their actions. Here the light reaching your eye comes from only a small part of the first scene. Take a reading by pointing the meter directly at the group or child from the exact position you have selected by sighting through the camera finder. Usually this will be somewhat downward and the sky will not be visible. Such a scene is a semi close-up.

"Now take numerous

The New SEEMANN TITLER

America's Outstanding Titler Value!

MODEL B
With
Lights

\$9.95

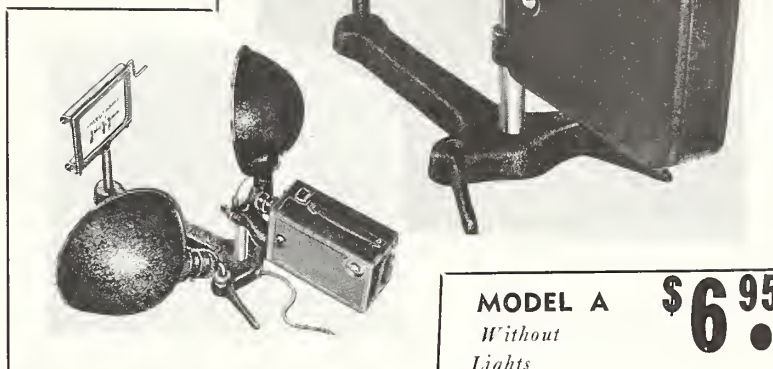

MODEL A \$6.95
Without
Lights

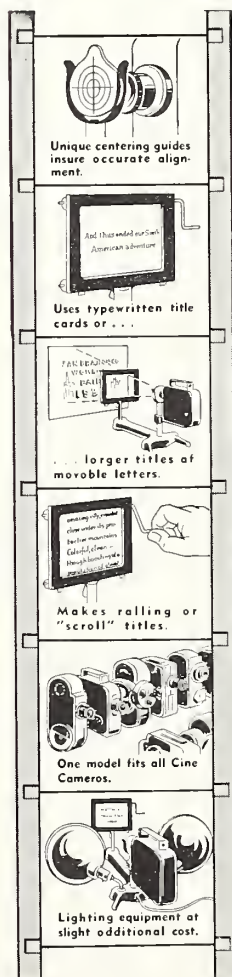

★ ALIGNMENT GUIDE

The camera is raised or lowered, moved forwards or backwards until the camera lens is flush and centered on a celluloid disc marked with circles. The auxiliary lens is then substituted for the celluloid alignment guide and the camera is accurately centered.

★ TITLE CARDS

Standard typewritten or hand lettered title cards may be used. A large square celluloid guide fits over the card holder frame which clearly shows the true title area covered by the camera lens.

★ LARGE SIZE TITLES

In addition to the regular title lens, an auxiliary lens of 30 inch focal length is supplied which enables the user to photograph the large size title cards with the many types of movable letters now on the market.

★ SCROLL OR ROLLING TITLES

Two rollers, with hand cranks, are attached to the upper and lower part of the title holder frame. These enable the user to make the professional type scroll or rolling titles.

★ UNIVERSAL

Practically all 16mm, 8mm and 9½mm cine cameras will fit on the new Seemann Titler. This is accomplished by the unique and flexible camera base and alignment guide.

★ LIGHTING EQUIPMENT

The Model B is equipped with two reflectors, adjustable to practically any angle desired. Each light has a separate switch. The lighting equipment may be added to the Model A at a small additional cost.

EACH TITLER COMPLETE WITH TWO LENSES, TITLE CARDS AND INSTRUCTIONS

At Your Dealer's or Write

SEEMANN, Inc.

6628 SANTA MONICA BLVD. - HOLLYWOOD, CALIFORNIA
★ In SAN FRANCISCO - at 420 MARKET STREET

**PEERLESS
"PLUS + VIOLET"
REVERSIBLE MOVIE FILM**

**ASSURES YOU OF
BETTER MOVIES**

"PLUS + VIOLET" is the kind of film you have often wanted but have been unable to find in its class price.

"PLUS + VIOLET" is a medium speed (Weston 12 Scheiner 20), fine grained outdoor type film with wide latitude, anti-halo backing and a special base which filters out all of the low frequency rays of the projection lamp, giving upon the screen a more brilliant and pleasing picture.

"PLUS + VIOLET" is not just another cheap film at a low price, but is a SUPERIOR film in the low price class. It is offered as a splendid film for those who wish to get good results on a limited film budget.

A trial will convince you that "PLUS + VIOLET" will enable you to take more and better shots for less money. Order today one or more trial rolls of "PLUS + VIOLET" at these attractive prices:

25 ft. double 8mm on daylight loading spool, including processing and return transportation, \$1.00 per roll postpaid to you.

4 ROLLS FOR \$3.50

A 200 ft. reel FREE if all 4 rolls processed at one time.

100 ft. 16mm on daylight loading spool, including processing and return transportation, \$2.35 per roll postpaid to you.

4 ROLLS FOR \$8.00

A 400 ft. reel FREE if all 4 rolls processed at one time.

Sold Only by
PEERLESS OF HOLLYWOOD
P. O. BOX 1310-H
HOLLYWOOD, CALIFORNIA

shots of the faces, the hands, and the feet of the playing children. Hold your meter a few feet from the object to be taken and expose in terms of that. Many beginners make the mistake of taking the average reading of bright objects (highlights) and shadow or dark colors (low-lights) in the belief that only in this way will the whole scene be correctly exposed. Forget the average and concentrate on the specific. Take your reading on the object you want your future audience to notice most on the screen. If the scene is a child combing a doll's hair, take the reading by holding the meter within a foot or so of the child's hands. Forget the doll's dress, or the flowers on a bush just behind the child. You want your audience to see the small hands endeavoring to execute the act of combing. The doll's dress and the flowers may be underexposed, but this does not matter.

"Correct exposure should make the most interesting part of the picture sharp and clear so that it stands out from the background. Exposure is just a matter of careful shot analysis and the regular and correct use of an exposure meter. Monotone films of the panchromatic type have the greatest latitude and will generally give the most satisfactory results in the beginner's camera, but even color films will be sparkling and sharp if these simple rules are followed. When someone tells you that he never bothers with an exposure meter you can be sure that he either throws away a lot of film or bores his friends with poor pictures."

Often a bugaboo to hesitant beginners who wish to make movies indoors, indoor lighting exposures are clarified by W. E. Clyma, who writes:

"To understand exposure, the beginner must realize that the light reflected from the subject is what registers on the film, not

the light shining on the subject. Therefore, the illumination must be balanced so that it will be evenly distributed on the film, and later on the screen itself.

"There is nothing difficult about lighting any scene, no matter how large it may be, provided enough lights and enough illumination are employed. In Kodachrome work the lighting must be balanced or even. Front lighting is preferable with additional illumination from the top-front to highlight the hair of feminine subjects, etc.

"It would be well for the beginner to do a little experimenting before actually exposing any film. Place two inanimate objects (such as large vases or boxes) on a soft or davenport; place one reflector containing a No. 2 photo-flood to the right of the camera, which should be in front center of the objects, focused on them. Then place another reflector in the same relative position to the left of the camera. Thirdly, another reflector should be held or fastened three feet above the camera, aimed directly at both subjects. Now, turn on the right light, noticing the bright illumination on one side of the set only. Turn on the left light and observe the comparative balanced effect. The center or third light source will then round out the illumination by eliminating any upper shadows or poorly lighted areas. Of course, variations of this may be used, such as throwing a strong light on the background, providing it is neutral in tone and will not detract from the objects of interest. Above all, illuminate a large enough area either in back of him or to his side to avoid the appearance that the subject is sitting on the edge of a precipice, which uneven lighting may cause.

"In using the lighting charts, such as packed with Kodachrome film, be sure to follow the instructions concerning the superimposing of lights. This means

SOLAR ENLARGERS



Perfect prize winning enlargements are easy with a Solar.

Five models for negatives from 35mm. to 5x7 in.—with or without condensers—with baseboard or special wall mounting brackets.

Dustless type negative carriers—wide span bellows—micrometric focusing—counter balanced head, plus a host of added refinements make Solar the choice of amateur and professional alike.

Write for the Solar book on Enlarging. Page after page is loaded with valuable hints and instructions on projection printing. Ask for Enlarging Treatise \$1. It's FREE!

WRITE TODAY

BURKE & JAMES, Inc.
223 W. MADISON ST. CHICAGO, ILLINOIS

MADE IN U.S.A.
PAT. PEND.

8M RAINBOW 16M

The following prices include processing and are for daylight loading films:

	25'	100'
No. 1	Double 8mm 1.00	16mm 1.85
No. 1 Anti-Halo	1.25	2.15
No. 2 S S Pan Halo	2.00	4.40
No. 3 Pan Halo	1.50	3.50

The following prices are for laboratory packed films without processing:

	100'	100'
No. 1	Double 8mm 1.25	16mm 1.20
No. 1 Anti-Halo	1.50	1.50
No. 2 S S Pan Halo	3.50	3.50
No. 3 Pan Halo	3.00	3.00

RATINGS:

	Weston	Scheiner
No. 1 Both Types	12-4	20-15
No. 2 S S Pan	50-32	26-23
No. 3 Pan	16-12	21-20

We Pay Postage on All Orders Except C.O.D.

RAINBOW LABORATORIES
STATEN ISLAND, N. Y.

USE METAL LETTERS FOR MAKING TITLES



Ask for Samples of the Most Beautiful Capital and Lower Case Letters Made

Assortment 222 pieces in wood case. \$7.16 postpaid in U. S. Outside add \$1.00. 126 caps and figures in box, \$1.28. Order white or black letters.

YOUR FILMS are not COMPLETE until you TITLE them; adding real interest value for you and your friends.

P. O. BOX B
Knight & Son, Inc., Seneca Falls, N. Y.

GENERA PROCESSING POWDERS for Motion Picture Films

Process Your Own Movies—Easy and Thrilling Saves you money. Anyone can do it. Make movies and show them same day.

No. 1 Set—1/2 gal.; PD12 developer 65c; Bleach, 15c; Clearing, 30c; Hardening, 25c. Com. set ptpd., \$1.35.
No. 2 Set—One gal.; PD12 developer, 95c; Bleach, 25c; Clearing, 40c; Hardening, 25c; Com. set ptpd., \$1.85.

Processing instructions furnished with each order.

REDUCING POWDER for all makes of processed films that are too dense for brilliant projection. Gallon size, 35c; postpaid. Write for FREE circulars, etc.

FROMADER GENERA CO., Davenport, Iowa
PIONEERS IN PREPARED PROCESSING POWDERS

FOTOSHOP ALMANAC CATALOG

The best reference guide to every motion picture product and operation, in color or black and white. Send for a copy—25c if you decide to keep it. If not, return it (postage guaranteed). FREE with \$2 order.

FOTOSHOP, Inc. DEPT. A8 18 East 42nd St., N. Y. C.
Branch—136 West 32nd Street

DO FILTER FACTORS FLOOR YOU?



...then ask about the new HARRISON Durafine FILTER SET—4 Filters, a Holder and Shade to meet 99% of all your requirements. With compact leather case—Easy instructions. New low prices. See them at your dealer today! ... Or write for folder.

HARRISON & HARRISON
Optical Engineers
8351 SANTA MONICA BLVD. HOLLYWOOD, CALIF.

8M TITLES 16M

- Business Film Titles
- Positive Film for Title Making
- Service Manual Available on Request

CINE SHOP
1812 Piedmont Charleston, W. Va.

SHOOT THE WHOLE FAMILY! HOME MOVIES—Only 10¢ a Day



Nationally Advertised! 10-Day Trial! Entertain with real movies of children, sporting events, trips, etc. Latest model Movie Cameras and Projectors, 8MM and 16MM sizes. For homes, business, churches, schools and clubs. All accessories. Satisfied Customers throughout the World. MONEY BACK 10-DAY TRIAL on all Cameras and Projectors. SMALL DOWN PAYMENT. Balance AS LOW AS 10¢ A DAY. FREE details, write: **QON ENTERTAINMENT HOME MOVIES**, 739 BOYLSTON ST., Dept. HMI, BOSTON, MASS.

that the Eastman figures prevail only when all lights are aimed at the same subject—not one light on one area and others on other places. Of course, a reliable meter will eliminate most of the guesswork, provided it is used in accordance with its manufacturer's instructions.

"In outdoor filming, do your shooting at any time other than noon, if possible. At noon, when the sun is directly overhead, harsh shadows appear under eyes and nose, giving a weird effect. If the exposures are made before 11:00 a.m. and after 2:00 p.m., the longer rays of the sun will give a better and more mellow appearance.

"Many amateurs feel that better exposures can be made in diffused light as on overcast days or when no direct and bright sunlight is used. It is true that this acts as an overall experience, I prefer direct

fuser. From my own sunlight, however.

"In taking meter readings, it is essential that the filmer get close enough to take in only that area he wishes to film. The old illustration of the girl with white dress against a black background, or vice versa, demonstrates that if the exposure is made on the girl and the background, the meter will compensate automatically, giving average exposure, unless the special reading (such as noted on the Weston meter) is used. Very few amateurs really get their money's worth out of a meter, because of failure to read and understand just all that the meter will do. It will solve many difficult problems for you if you let it.

"Before gauging exposure, with or without meter, look into your finder so that you will know just what your lens will cover. Then take the exposure for that area only."

Shoot indoor movies!

• Continued from page 21.

The simplest, of course, is obtained through the use of only one light source placed near the camera. (Illustrations 5 and 6.) It will be noted, however, that the shadows cast by the subjects and objects in the scene give it a somewhat gloomy appearance and the whole picture is lacking in depth, or as it is usually described, "flat." Note, too, that it is difficult to separate some portions of the subjects from the background.

Where only one light source is used, the quality of the photography can be improved with the use of a large white cloth or paper, so held as to illuminate the shadow side of the subjects. This reduces the density of the shadows and directs some soft, diffused light at the subjects on the shadow side.

Another means of accomplishing this result is by the use of two light sources,

placed as is shown in Illustrations 7 and 8, on each side of the camera. One light source should be at least twice as strong as the other in order to obtain the proper degree of unbalance of light to give modeling and form to the subjects. This may be done by using, for example, a No. 1 Photoflood in one unit and a No. 2 Photoflood in the other. Where the lamps are of the same size, then one reflector should be placed at least 30 per cent closer to the subject than the other.

Observe that the scene has an overall brighter appearance, due to the absence of heavy shadows cast by the subjects. The subjects, too, have acquired more "form" and the whole scene more depth.

A variation of this arrangement is given in Illustrations 9 and 10. A third lighting unit is employed to direct light down on the subjects from above and

Cinea EDICABINET

AMERICA'S FINEST
EDITING EQUIPMENT



PAT. APPLIED FOR

LOOKS LIKE A MILLION—
WORKS LIKE A CHARM

Designed for utility and finished in red, black, and chrome the new CINEA EDICABINET adds tremendously to the fun of editing your movies. The never-stick drawer has everything—numbered pegs for organizing and filing clipped film scenes and sequences, a perpetual carbon memo pad for indexing, and a removable enamel tray which catches the small film ends that fall from the splicer through a hole in the top. The EDICABINET is 30 x 14 x 2 inches and the construction is of the finest—a black Temperprest Masonite top, which is hard, does not scar, and cleans easily—a frame of kiln-dried hard wood—and a metal drawer of durable porcelain enamel. Red lacquer with chrome handles sets off the

front of the drawer. A receptacle for a cement bottle is provided in the top. The EDICABINET, with a famous CINEA 30 SPLICER and a pair of CINEA-WINDERS attached, complete. \$33.75

Watch for announcement of the brand new CINEA-VIEWER—it'll be the very best.

As shown by dotted line in illustration, provision has been made on the EDICABINET for a viewer to be placed behind the splicer. If you have some editing equipment now, why not stop at your dealer and see the EDICABINET. It can be purchased alone and your present equipment easily attached. EDICABINET complete, but without CINEA 30 SPLICER and CINEA-WINDERS\$14.75



FILM CEMENT

The only cement for both acetate and nitrate base film—CINEA CEMENT has no odor—will not rust splicer—does not bleach color in Kodachrome. At all dealers...25¢

SEE YOUR DEALER OR
WRITE DIRECT TO:

ANY TYPE AND MAKE OF VIEWER, SPLICER, OR
REWIND CAN BE MOUNTED ON THE EDICABINET.

CINEA 30 FILM SPLICER—For both 8 mm and 16 mm sound and silent film. Fast and efficient—fewer movements necessary—no wasted motion. A CINEA-made splice is always good.....\$10.00



CINEA-WINDERS—The only rewinds that have adjustable tension and drag—prevents backlashing—leaves one hand free. Takes both 8 and 16 mm reels. Large, easy-grip handles. Right and left, per pair. \$9.00

AMERICAN BOLEX COMPANY
155 EAST 44TH STREET • NEW YORK, N. Y.

"HOW TO REVERSE MOVIE FILM"

- The only comprehensive book on the market that fully covers this fascinating subject.
- It gives four tried formulas. Some of them were furnished by such film manufacturers as Agfa, Dupont, and Gevaert.
- It has brief instructions on developing positive film for titles and also formulas for reducing and intensifying film.
- And the price is only . . .

50c Copy

VERHALEN PUBLICATIONS

6060 SUNSET BLVD.

HOLLYWOOD, CALIF.

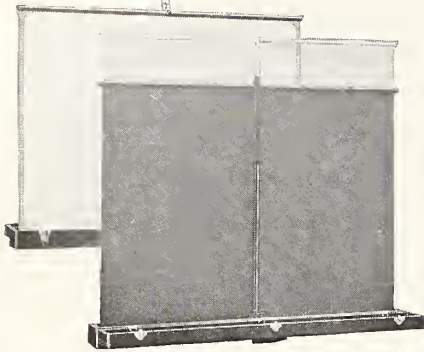

**RAVEN
Duplex
SCREEN**

• A versatile two-in-one screen constructed with typical "Raven" thoroughness. The rectangular adjustment serves the screen's customary function while the square format is adapted for the projection of Kodachrome "stills." In handsome carrying cases and in all Raven fabrics — and in all sizes from 22 x 30" to 72 x 96".

Investigate the Unique, High Qualities of
RAVEN Haftone SCREENS

• Unexcelled for durability, perfect diffusion and wide-angle. Best suited for color projection because of the elimination of harsh glare.

At All Photo-graphic Dealers

Literature on Request



CUT YOUR FILM COSTS

— GET BETTER PICTURES —

American Film Corporation offers you over 28 years of experience in professional laboratory processing. We operate one of the most complete and finely equipped laboratories in the Middle West to serve you. Processing not included.

**FILM —8mm and 16mm
GUARANTEED FRESH**

An approved orthochromatic emulsion that covers the full tone scale — gets maximum shadow detail. Gives pictures of perfect gradation. Laboratory packed for darkroom loading.

Double 8mm, 100 ft. Not scored, Weston 8	\$1.25
Double 8mm, 400 ft. Not scored, Weston 8	4.00
Straight 8mm, 100 ft. Weston 875
Straight 8mm, 400 ft. Weston 8	2.50
16mm, 100 ft. Weston 8	1.10
16mm, 400 ft. Weston 8	4.00

REVERSAL PROCESSING

	Ortho.	Panchro.
16mm, 100 ft.	\$1.00	\$1.25
Double 8mm, 25 ft. or less50	.75
Single 8mm, 50 ft. or less50	.75

NEGATIVE-POSITIVE DEVELOPING

	Ortho.	Panchro.
16mm, per ft. 1½c. Min. chge.	\$1.25	\$1.50
16mm, Positive Print		Per ft. 2c
50 ft. or less. Minimum charge	1.00	1.00

Our modernly equipped laboratory assures finest processing. If you get it in the exposure, we will give it to you in the finished picture. Prompt service guaranteed.

AMERICAN FILM CORPORATION
6227 North Broadway Chicago, Ill.

The ECONOMY FILM for Home Movies

DU PONT 16 mm
Regular Pan Motion Picture
FILM \$ **4.50**
100 ft. Roll
INCLUDING REVERSAL PROCESSING

Standard speed, FULL PANCHROMATIC sensitivity, wide latitude, fine grain. Has all qualities of costlier black and white films except extreme speed. Excellent for normal outdoor shooting or indoors with photo-floods. Can be used with filters. Calif. buyers include sales tax.

Write for Free Bulk Film Catalogue
HOLLYWOODLAND STUDIOS
SOUTH GATE CALIFORNIA

slightly to the rear. The hair and shoulders of the children are more highly illuminated, and, with the reading lamp placed as it is, this scheme gives a very natural appearance. At the same time it adds even more to the illusion of depth in the picture. When taking a scene in which floor or table lamps are included, always be sure that they are turned on.

Correct exposures for the uninitiated can be obtained only through the use of an exposure meter or exposure table or guide. Measure distances carefully, don't estimate them. Remember that light varies inversely as the square of the distance from the source, and not directly. This means that if one light source is 10 feet from a subject and another 7 feet, assuming both lamps are of equal wattage and in similar reflectors, the lamp 7 feet away is contributing approximately twice as much light at the subject as the unit 10 feet away.

Another important consideration is the background in front of which

the action is taken. In making home movies it is not possible to choose backgrounds as can be done in a studio. However, dark or highly ornamental or intricate backgrounds should be avoided wherever possible. Where action must be located in front of such surfaces, the use of a highlighting or backlighting unit on the subjects is strongly recommended.

The preceding remarks apply particularly to black-and-white films since the beginner should logically start with this type. However, should he feel the color urge, and he will sooner or later, some revision in lighting technique will be required. Color itself gives depth to a scene and therefore but little modeling or highlighting is necessary and for most shots should be avoided. Balanced lighting, i.e., approximately the same amount from each side or only slightly unbalanced lighting seems to give highly satisfactory results with color film.

Friends like my films . .

• Continued from page 14.

My library, once 106 rolls, is now on 28 reels. Each roll is listed as taken: the date of each episode, its title or description, and length. The episode is listed again, when edited, then spliced into one of fifteen classifications, which fall into three general groups: "Everyday Affairs," "Feature Pictures" and "General." First group, four clas-

sifications:
1. "Family Affairs" (Blackwell Edition—my wife's family).
2. "Family Affairs" (Davis Edition—my family). These are, of course, divisions related to the two family sides. Contents: excursions, dinners, visiting relatives, birthdays, anniversaries, family pets, etc. These episodes are unhearsed, or staged, or a

combination of both, depending on the circumstances at the time. Unhearsed are better, provided the subjects are given, or have taken up, activity natural to them. Even then, it is sometimes desirable, for the sake of continuity, to stage a bit of action.

Here is a real example: My niece, brought to visit, wants to get the hammock out of the tool-house. I have taken the others quite naturally, for they have been sitting and talking. But to explain the appearance of a hammock—also, to catch Mary in a bit of typical and continuous action—I show her, in a number of separate scenes, leaving the group, entering the tool-house, leaving with hammock from another angle, crossing the yard with

BUY THE BEST

Guaranteed Perfect

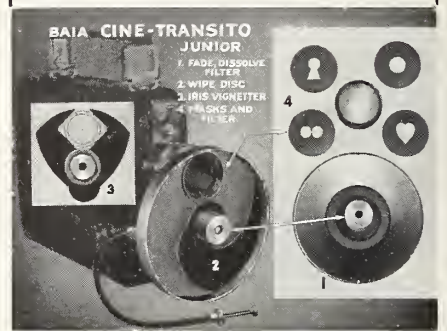

The CINE-TRANSITO Jr.

For Any 8 or 16 Camera

Easy to control and simple to operate. Produces smooth FADES, LAP-DISSOLVES, WIPEs, and IRIS-IN and-OUT. (VIGNETTER) Holder for MASKS and FILTER. Can be placed in any position on camera. Operated by cable release; **\$ 5.95** price

Includes cable release and one disc. Choice of fade, wipe or vignetter. Discs, \$1.95 each.

Automatic Timer\$2.95
Controls the length of time of iris-in and-out, of fade, and speed of wipe. Masks, 25c each.

Specify for What Camera and Lens
The AUTOMATIC, SYNCHRONIZED CINE-TRANSITO is \$32.50. FOR BOLEX 8 and 16 (Dist. American Bolex Co. Inc.), BELL & HOWELL 70 series, VICTOR No. 5 and EASTMAN, MODEL K.

**WHEN YOU BUY BAIA,
YOU BUY THE BEST**
From Your Dealer or Direct
BAIA MOTION PICTURE ENGINEERING
8044 Hardyke Detroit, Mich.

A NEW FASTER (Weston 12)

8 MM GENERA MOVETONE 16 MM

Takes Clear and Sharp, Theatre Quality Movies Has Non-Halation Safety Base, fine grain, greater latitude, tonal gradation and TWICE the speed of ordinary semi-ornos. You will be delighted with the amazing results that can be had with this new and faster film. No more dark and underexposed pictures.

- 200 ft.** 8 in dbl. **\$1.95** post- Spools with 8 width **paid** order!
- Keystone 35c each; Eastman and Filmo 40c; Univex 20c
- 100 ft. 16mm on Safelight Loading Spool, ptpd. \$1.45
- 4 100 ft. rolls 16mm GENERA MOVETONE on four Economy Safelight Loading Spools. **\$4.95**
- Fits all 16mm cameras. Postpaid
- 1 100 ft. 16mm GENERA MOVETONE on daylight loading spool. Price including processing **\$2.89**
- 4 25 ft. rolls double 8mm GENERA MOVETONE on four Aluminum Daylight Loading Spools. All double 8 cameras. Postpaid **\$3.55**
- 1 25 ft. double 8 MOVETONE on daylight loading spool. Price including processing **\$1.48**
- 100 ft. single 8 MOVETONE for Univex, etc. **\$1.15**
- 100 ft. Single 8 Pan. **\$2.10**; Fast Pan. **\$2.20** postpaid.
- 100 ft. Dble. 8 Pan. **\$3.45**; Fast Pan. **\$3.60** postpaid.
- 100 ft. 16mm Super Pan. (West 24) Dev. Pd. **\$3.25** pd.
- Simplified Processing Outfits incl. Prepared Powders For 30 ft. single 8, **\$3.35**, ptpd; Dbl. 8 and 16, **\$4.95**
- Write for Big Bargain Catalog, our processing prices.
- FROMADER GENERA CO., Davenport, Iowa**

NOTICE TO MOVIE FANS

If you take movies (8mm or 16mm) you simply cannot afford to be without a Free copy of the latest Photo Bargain Book now being distributed throughout the U. S. Lists all the best moving picture equipment from all the leading manufacturers, describes them. The prices save you money in many cases. You'll find the latest in lenses, screens, meters, projectors, cameras, film, titlers, editing outfits, tripods, books on editing, titling, etc. This Bargain Book is invaluable to you as an equipment REFERENCE book. Don't wait a day longer to send for your Free copy. Write us now.

CENTRAL CAMERA COMPANY
230 S. Wabash, Dent. A-9 Chicago, Ill.

HOT OFF THE PRESS!!

New Seasonal Catalog of the "NATIONAL" 16MM. RENTAL LIBRARY Large Selection — Shipped Anywhere — Enclose Postage.

Also Special Line of New Screens for Sale

NATIONAL CINEMA SERVICE
71 Dey Street New York City

others foreground, entering the proper spot, and, with closeups, some of hands, hooking the hammock onto ropes, then reclining. Last shot shows her, background, the others foreground, still talking, as she swings happily.

3. "Personal Affairs." What happens to us, alone or with friends, excluding relatives. Contents: similar to above plus parties, gardening, club outings and the like. Here is one sequence: We wander through the woods near a river. She takes pictures with a still camera. I offer suggestions. Closeup of her. Shot of scene she is taking. Another closeup, she presses the release. We continue. Here is Henry wandering along. (He has taken the scenes in which we both appear.) We are seated by the river, look up in surprise. From another angle, Henry locks the camera-button and enters to greet us. The sequence ends with a series of closeups.

We are often with a couple with a growing youngster, which long ago called for:

4. "Personal Affairs." (MacRoberts Version.) This led us to the zoo, and so on. Children are a delightful problem. I think best results came in the episode where I simply took him running along naturally, beside his parents. Variety was obtained by such methods as coaxing him to stop long enough to smell a flower in a closeup.

The second group has no subdivisions in the ultimate fifteen:

5. Feature Pictures." The four sections: "San Antonio," one reel; a lengthy excursion, half-reel; "Mexico," four reels; "Three Mexican Towns," half-reel. Here comes the fun of relating groups of episodes.

The third group, a general one, begins with:

6. "Star at Noon." Twelve episodes taken noontime at work. The company has "Star" in its name. Lately, we've made

plays exclusively; and, by a slight adjustment, the first reel now contains six factual items (such as journey to, lunch in, return from a near-by cemetery), and the second all the plays (including one, with a nice plot, in which a pie is applied impartially to three of us).

7. "Plays." Here, it seems to me, is the most appropriate place to use old, and experiment with new, titling and camera effects.

8. "Animation." As a camera-lacking adolescent, I drew 265 feet on strips of 35mm, salvaged from a film-exchange floor, cleaned of emulsion, and cemented. Now, a long-hampered interest is being satisfied.

9. "Experiments." Tests made to find out things useful later. Example: What happens when the titler lens, the title-holder, or both together, are raised, lowered? Useful for mystery-plays — titles or extreme closeups — I should say. The first experiment deals with photographs made on an European trip. I've learned that glossy prints are extremely reflective.

10. "Friends." This is self-explanatory — it contains those short lengths of friends that are in so many reels.

11. "Family Portraits." Short, rather static episodes, or single shots. Classifications 10 and 11 can be used at beginning and end of a reel. When shooting, usually you can start a fraction before, and run past, the start and stop marks, assured both that you're not wasting film and that no valuable continuity is endangered. And the result on the screen is an extraordinary compression of time.

12. "Compositions." This furnishes excuse to get out week-ends and shoot rivers, lakes, forests, parks, monuments, cemeteries, the coming of Spring. As a practicing artist, I find this pleasant exercise.

13. "Events." May fetes, games, parades, exposi-

THESE 7 KEYS TO BETTER PICTURES

GIVE PERSONAL MOVIES

Professional Quality



BOLEX is famous for its precision mechanism. Built by E. PAILLARD & Co., internationally recognized craftsmen, **BOLEX** possesses all the quality of a custom-built camera — that's why critical amateurs choose **BOLEX**.

ROCK-STEADY PICTURES are assured by lateral spring tension in the gate, a spring-operated single claw of stainless steel that does not wear, and properly sized, automatically formed loops.

PICTURES OF FINEST QUALITY are possible because **BOLEX** has 90° rotary disc, focal plane shutter and provides critical, through-the-lens focusing with a luminous, magnified image on groundglass.

CENTERED, WELL-COMPOSED PICTURES are easy by virtue of a trifocal, parallax-correcting viewfinder which gives exact field for 1", 15 mm, and 3" lenses with proper magnification through optically corrected glass.

EXCEPTIONAL VERSATILITY is provided through semi-circular 3-lens turret which provides a clear field for use of wide-angle lens while telephoto lenses up to 4 inches remain in place. Interchangeability permits use of lenses of all focal lengths.

EASY OPERATION is assured by automatic threading, with loops formed mechanically — by finger-tip controls — and by positive "starts" and "stops".

REVERSE ACTION, SUPER-IMPOSITIONS AND LAP-DISSOLVES are provided for through reverse filming by handcrank; clutch to disengage spring motor; and adding and subtracting footage counter.

ANIMATIONS AND STILLS may be made by means of the single-frame release, with shutter speeds from 1/20 to 1/80 second and time exposure.

BOLEX SIXTEEN Camera — with Meyer Primoplan 1" F/1.5 lens \$275.00 — with Leitz Hektor Rapid 27 mm F/1.4 lens \$295.00. **BOLEX DOUBLE-EIGHT** (8mm) Camera — with Meyer Kino Plasmal 12.5mm F/1.5 lens \$275.00. Hand made carrying case \$25.00 additional

Bolex
paillard
THE WORLD'S FINEST

COMBINATION 8 and 16 mm PROJECTOR

BOLEX offers the only projector available in America today for projecting both 8mm and 16mm film. Like **BOLEX** cameras, **BOLEX** projectors are precision-built to give the finest performance at all times. All models are beautifully finished and range in price from \$210.00 to \$250.00.

WRITE TODAY FOR ILLUSTRATED 36-PAGE CATALOGUE

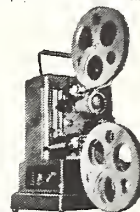

AMERICAN BOLEX COMPANY, 155 E. 44th ST., NEW YORK

It is cheaper to buy a **BOLEX** at the start — so see a **BOLEX** before you buy

Headquarters for

BOLEX CAMERAS

Come in for demonstration of these popular cameras. Our Easy Payment Plan makes their purchase easy!

WINTER, Inc.

529 West Sixth Street

Los Angeles, California

HOLLYWOOD
a word please!

Haven't you something with a little more "oomph" than colossal? A word we can pass along to the hundreds of enthusiastic home-movie makers who have received our **FREE** camera catalog, and are plumb lost for words! You see, this book is so complete—a cavalcade of cameras and equipment, all latest type and all nationally advertised—that the home movie fan doesn't have to go any further than the mailbox. He can order at home. But the main attraction is really the low prices. Send for this book today... see what we're driving at. It's **FREE!**

LAFAYETTE CAMERA
Dept. 80A—100 Sixth Ave., New York, N. Y.

Use **THRIFTY** 16MM **FILMS**

You'll Get

BETTER PICTURES AT LESS COST

16mm quality film at amazingly low prices — permitting YOU to shoot more than TWICE as much footage at LESS COST.

THRIFTY ORTHOTYPE
For OUTDOOR... non-halation base, fine grain, fast, Weston 8 — the film you've been wanting to find at an unheard of low price. Machine processed. Per 100 ft. rolls **\$1.60**

THRIFTY PANCHROMATIC
Use for all types of shooting. High-speed Weston 16 daylight — 10 photofloods, machine processed. Per 100 ft. rolls **\$3.75**

THRIFTY SUPER-PANCHROMATIC
Super-fast; high sensitivity requiring minimum of light. Weston 50 daylight — 32 photofloods, machine processed. Per 100 ft. rolls **\$4.25**

California Buyers Include Sales Tax

10% DISCOUNT IF YOU ORDER ONE ROLL OF EACH OF THE ABOVE FILM AT ONE TIME. Regular cost, \$9.60. Special discount price, \$8.64.

THRIFTY FILMS
Drawer 98, Watts Station, Los Angeles, California

MOVIE CANDID

CAMERA CASES

Finest Genuine Top-Grain Cowhide for All Popular Cameras. Postcard Brings FREE Literature.

OUR PRICES WILL SAVE YOU MONEY

Cameracraft Division, 1305 South Union Ave. Mail Order Dept. Los Angeles, Calif.

The BIG Lamp Values for 1940 are

WONDERLITE Photo Lamps

Write for Current Price List

WONDERLITE COMPANY, West Orange, N. J.

When You Buy **BAIA** You Buy the Best

Precision Made; Guaranteed Perfect

\$2.50

From Your Dealer or Direct

BAIA MOTION PICTURE ENG.
8044 Hardyke, Detroit, Mich.

DAYLITE LOADING

BULK FILM FDR ALL 8mm and 16mm CINE CAMERAS. SPDDLED READY FDR CAMERA USE FREE.

State Make of Camera Please

ESO-S CINEFILMS
3975 Menlo Los Angeles, California

tions, happenings that are ritualistic or programmed. I think of the graduation of Henry as a good example. I show him, then his family, emerging from home that particular morning. Several shots of the beautiful campus follow. Then the gathering candidates are discovered from a distance. Moving up, we discover Henry among them, and some of his best friends. The Academic Procession passes; when Henry appears, we follow him to the outdoor site of the ceremonies. Among the audi-

ence, we single out Henry's parents, relatives, friends. A long scene shows Henry receiving his diploma. After, his parents warmly congratulate him.

14. "Miscellany." Proof that this system is right—for me—is that it contains only five sequences.

15. "Scrap." Scenes, removed for reasons of continuity, too good, sentimental, or humorous to discard. It supplies the courage necessary for ruthless editing. If the real junk is tossed away, even your friends will like it.

16mm Camera grows up!

• Continued from page 17.

install his film in a continuous projector, where it can run for hours without attention, to be viewed many times and often by countless hundreds.

Only 400 feet of 16mm film will supply a show previously possible on 1000 feet of 35mm film. A 44-minute sound show can be projected from a single 1600-foot reel of 16mm film, where previously many bulky cans had to be accommodated with heavier equipment for a similar show.

Print costs are comparably less and the convenience of operation makes motion picture selling now within the range of personal and intimate contact.

An example of how merchandising can be accomplished by a 16mm film is entailed in a picture made for a Los Angeles swim suit manufacturer. The picture was made in Kodachrome and displayed the merchandise for the forthcoming season's line. Five prints were mailed to trade centers in this country and exhibited to buyers at Trade Shows early in the season. They were thus unforgettably introduced to the product, and increased buying resulted, not only from the novelty of the presentation in color film, but in being able actually to see the forthcoming product in true life and color in a set-

ting of its ultimate use. Then, later on, the film was shown individually to store buyers who were able to purchase articles of the line from a living catalog in a veritable portable style show.

From that point, the manufacturer furnished the film free as sales-building accessory to retail stores. It was shown nationally throughout the entire season in store windows, at clubs, schools and even in the sportswear departments to actual customers who purchased their swim suit from the picture at the point of sale.

The manufacturer enthusiastically endorsed the film as having definitely been a factor in increasing his sales for the season; and, like many others who are being initiated into motion picture selling through 16mm, he is making place on his advertising budget for more sales films.

Only recently, we were overjoyed to see little Edgar take his first step and amble through his first "patty-cake," but now we are breathless to hear him recite on sound-film his priceless recitations, recorded forever for posterity.

Sound-on-film is here. It's expensive to own and operate for the amateur home cameraman and enthusiast, but for the pro-

WEAR

Shortens the life of your film... VapOrate lubricates your film externally to ease projection and reduce wear.

AVOID

EYE STRAINING PUNISHMENT FROM SCRATCHES, SPOTS and STAINS. Looking at your pictures should be a pleasure for yourself and your friends.

VAPORATE

FOR BETTER PROTECTION AND LONGER FILM LIFE

VAPDRATE CO., INC. 130 W. 46th St. New York City, N. Y.

BELL & HOWELL CO. Chicago 1801 Larchmont

Hollywood 716 No. La Brea

Better Movies with BLACK and WHITE FILM

Reversible Film 25 ft. Dbl. 8mm 98¢ Includes Processing

Rating Weston 12 Scheiner 18

At your dealer or direct. Fast service processing same day included at no additional cost.

VISUAL INSTR. SUPPLY CO.
1757 B'way Box H9 B'klyn, N. Y.

TITLES Add Lasting Interest

to your personal movies. Da owoy with vacol explanations between scenes by adding to your movies crisp, neat titles made with PIN LETTERS.

Write for descriptive literature of **Pin Letter Titling Sets**

MITTENS LETTER CO.
Redlands, California

Editing Makes the Film ED-I-TOR Makes It Easy!

A compact, lightweight, dustproof, and scratch-proof editing aid with felt protected clips for holding 27 separate film scenes coiled, ready for splicing. Size 10" x 15." De-Luxe leatherette. \$3.75 — postpaid.

MOVIE PRODUCTS COMPANY
233 Louise Avenue Highland Park, Mich.

Bass says:

If your horizon includes STILL Cameras you will want to be on our mailing list, so drop everything and indite us an epistle starting: Send immediately your **BASS STILL BARGAINGRAM NO. 242**

72 luscious pages that will make your mouth water, listing thousands of new and used items.

BASS CAMERA CO.
179 W. MADISON ST. CHICAGO, ILL.

Dept. H. M.

REDUCTIONS

ENLARGEMENTS DUPLICATES

GEO. W. COLBURN LABORATORY
1197 MERCHANDISE MART CHICAGO

ORDER FOR SUBSCRIPTION

Home Movies Magazine

12 MONTHS FOR \$2.00 IN U. S.

In Canada, \$2.00; Foreign—\$3.00

SPECIAL OFFER: 3 Years for \$5.00 in the U. S.

HOME MOVIES
60 Sunset Blvd.
Hollywood, Calif.



Send to.....

Address

City..... State.....

New Renewal Gift

Send to.....

Address

City..... State.....

New Renewal Gift



Enclosed find \$..... Date.....19.....

Sent in by.....

Address

City..... State.....

NO SUBSCRIPTIONS ACCEPTED FOR LESS THAN ONE YEAR

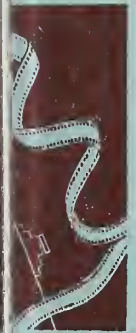



essional 16mm producer, equipment is available which may, in the not too distant future, also be available for home use. In hands that are acquainted with sound recording principles, a result that is surprisingly adequate, is now possible.

Another factor is establishing 16mm motion pictures in business use is the rapid development of distributing chains for showing of these pictures nationally to guaranteed groups. A business man when approached for making a picture would say—"Sure—I'd like a motion picture, but where could I show it." Theaters were not receptive and mechanically, it was impossible.

Now, the producer of a sales or business film can be assured of a nation-wide audience of over 5,000,000 people within a few months' time. He can have an accurate check reported to him of that audience, and even cards circulated giving him return opinions on his picture and his product. He can pick his audience by states, sales territories and even sex!

School showings for pictures of suitable nature are demanded and welcome. More and more churches are being equipped with 16mm projectors, and many clubs and organizations are fitted with projectors for showings as are hotels, camps and a myriad of other groups.

There are traveling 16mm show units anxious for pictures. One chap that had an open air theater in the fruit picking country was in my office a day or so ago and stated he was showing 16mm pictures to an average audience of 450 people every night and needed more films. Advertising pictures, scenic pictures, even amateur dramas were welcome.

Another was making a profitable run of one-night stands through small towns and communities who did not boast of a theater. His audiences were eager for pictures of any sort.

Visual education, too, is a fast developing field, and is already established in the regular curriculum of enterprising institutions of learning. Many schools have their own producing units and are conscious of the value of pictorial learning and the indelible picture gained by actually SEEING facts before their eyes.

The 16mm screen is now, and will be more so in the future, one of the greatest mediums of education—not only in the ability to relive again in the future the historical happenings of today, but in bringing before classrooms, enviable and informative closeups of botanical life, scientific research in actuality, and the miracles of nature that we cannot ordinarily observe in our daily life.

We are now engaged in preparing a film depicting the functioning of the United States Post Office. It is being sponsored for free public showing by the National Federation of Post Office Clerks of Washington, D. C. The picture begins with the Continental Congress and the inception of the Post Office of the United States as a means of communication of the Colonies during the Revolutionary War. It follows, in historical sequence, the establishment of carrier service: Post riders over hard and dangerous roads; the Pony Express, and shows how the Post Office followed each pioneer settlement and connected the Nation in news and comment as it progressed. It carries through to a very comprehensive presentation of what goes on behind the grills of the Post Office today in following your letter to its destination efficiently and safely. The Railway Mail, the Foreign Mail, and the Air Mail are shown in detail, and it will carry a priceless message of appreciation and education to the American public of one of the greatest public services in existence—and the story of the men behind it.

Start that new Camera on its career of Perfect Movie Making with

PANCHRO SUPER REVERSAL FILM

16mm. 9.5mm. double 8mm.



Plenty of speed for interior shots (Weston 16) as well as outdoor shots (Weston 24) on dull days with heavy overcast sky. Panchro's high color sensitivity, fine graininess and wide latitude contribute to the production of brilliant pictures of theatre quality. And for processing—Gevaert laboratories located throughout the world are organized to give you the fastest and at the same time the most efficient service—at no additional cost—purchase price includes this service—films are returned postage prepaid. For convenience to the user—when 400 ft. Gevaert Reversal Films are received for processing, Gevaert laboratories will return your films spliced on a 400 ft. spool ready for projection. You owe it to yourself and that new camera to provide this film for perfect movies.

Ask your dealer for Panchro Super Reversal or write to:

The GEVAERT COMPANY of AMERICA Inc
 423 West 55th Street, New York
 Philadelphia · Boston · Chicago · Los Angeles · San Francisco
 In Canada: GEVAERT (CANADA) LIMITED · Toronto · Montreal · Winnipeg

MOVIE TRICKS AND GADGETS

A booklet containing valuable data for the beginner as well as advanced cine amateur. Price 75c postpaid.

VerHALEN PUBLICATIONS 6060 SUNSET BOULEVARD HOLLYWOOD, CALIFORNIA

in a person it's the heart!
In movie projection IT'S THE SCREEN

PROVE IT TO YOURSELF

Write for your FREE 5"x7" sample of this amazing test fabric and test chart. Test it in your own home as a projection engineer would. We challenge any other screen to give you the projection qualities of the BRITELITE-TRUVISION Wide Angle Crystal Beaded Screen Fabric.

The unique surface of the WIDE ANGLE FABRIC spreads and reflects light in a perfect, fan-shaped area, eliminating the great difference in brightness when the screen is viewed at different angles. It provides a better all-over definition . . . no glare, no halation, no distortion . . . no matter where spectators sit. Your best bet, then, for black-and-white or color movies is a Britelite-Truvison WIDE ANGLE CRYSTAL BEADED SCREEN

Britelite-Truvison

WIDE ANGLE CRYSTAL BEADED SCREENS

Whether you prefer a Tripod, DeLuxe or Nu-Matic Box Type, get a Britelite-Truvison Wide Angle Crystal Beaded Screen at no greater cost.

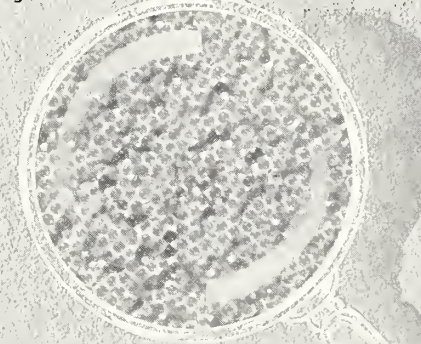

See the complete Britelite-Truvison Line of Screens, Reflectors, Spoilights, Paper Sales, Projector Cases, etc. at your dealer, or write for complete catalogue, FREE Sample and Test Chart. Made in U.S.A.

MOTION PICTURE SCREEN & ACCESSORIES CO., INC.

351 WEST 52nd STREET

NEW YORK CITY

It's a Sensation! . . .
16MM
AMBERTINT
Quality Film
 Gives you clear, fine quality pictures. Plenty of speed for OUTDOOR shooting. AMBER tint of film "different" and pleasing.
Amazing Outdoor Results
 Fine grain, semi-ortho, large latitude—half stop either way—the OUTDOOR sensation film of the age. The astounding low price, including machine processing, permits you to shoot twice the footage at no extra cost.
\$2.00 per 100 ft. Roll
 California Buyers Include Sales Tax
Shoot More Outdoor Action Film at Less Cost
 AMBERTINT not sold at dealers—order several rolls direct—save. Not made in 8mm nor sold in bulk.
 WRITE FOR BIG FREE BULK FILM CATALOG
HOLLYWOODLAND STUDIOS
 SOUTH GATE CALIFORNIA

Do as Hollywood Does— **Hand-letter your TITLES**
"A to Z" TITLING OUTFIT
TITLE IN COLOR or BLACK AND WHITE
 The Easy "A to Z" Way It's Fun—Save Money with the "A to Z" TITLING OUTFIT Complete... Only \$2.00. It's so easy to use this simple tracing method that titles can be made with Pencil, Ink, Crayon, or Colors, in a few minutes. Sold at Leading Dealers or send \$2. Free Demonstration Outfit-H9
JACOB STEIN (MFR.)
 173 5th Ave. New York, N. Y.
COMPLETE OUTFIT \$2
Robert Taylor in Lucky Night

FREE! 5 x 7 Enlargement with 36 Exp. 35mm. Fine grain developed and printed 3 x 4 size. All for \$1.75
 Write for price list other sizes. We can save you money.
Save Dollars With Onyx Film
WESTON SPEED DAY. 8
 100 feet 16mm. \$2.60
 25 feet double 8 mm. 1.20
 30 foot Univex reload .65
 No additional charge for processing daylight loading spoils.
Immediate Service by Return Mail
KENWOOD FILMS 1238 E. 46TH ST. CHICAGO, ILL.

EDITING-TITLES
 Genuine Kodachrome Titles \$1.25 Up
 Black and White and Tinted Titles .25c Up
 World's Fair Kodachrome Main Title \$1.00
 World's Fair Kodachrome The End Title .75c
 Send Us Your Next Title Order!
HORNE MOVIE SERVICE
 342 Madison Ave. New York, N. Y.

EQUIPPED to Serve You...
 with a comprehensive line of **CAMERAS & ACCESSORIES**
KLEIN & GOODMAN
 18 S. 10th Street, Philadelphia, Pa.

PHILADELPHIA
LEARN PHOTOGRAPHY from Experts
 Practical training in Commercial, News, Portrait, Advertising, Natural Color and Motion Picture Photography. For pleasure or career. Famous experts will be your teachers. Personal Attendance and Home Study courses. 30th year. Send for Free Booklet.
NEW YORK INSTITUTE OF PHOTOGRAPHY
 10 West 33 St. (Dept. 114) New York City

Cut for Color Continuity

• Continued from page 10.

screen there was a sharp, momentary distraction caused by the re-location of color masses or change in color intensities.

At once, the professional film producers set about to correct this. It meant changing the technique of scenario construction as applied to Technicolor productions. It means a new method must be employed in laying out sets in order to allow greater freedom in the movement of the camera during shooting. It meant, instead of shooting a scene and then setting up the camera in another position for a closeup or an angle shot, that the camera should be free and mobile at all times, permitting—when most desirable—moving in or away with utmost freedom during a take. Thus, one scene would virtually "flow" into another, resulting in a gradual, unbroken transition in which a long-shot became a medium-shot and ultimately a closeup.

It also brought a change in editing technique. There were fewer cuts necessary in breaking down a color film—fewer splices in the editing. More attention could be given to important details of editing because, to some extent, a great deal of the editing had already been done at the camera. In many instances, complete sequences now come out of the cutting room just as they are filmed, requiring no cuts whatever.

Of course, the amateur movie maker hasn't the equipment available to the studio cameraman, nor is he always shooting the kind of movies that would require mobile equipment. But he can take a cue from the professional and adapt the principle, just described, to shooting and editing his color pictures. If you are one of the many gadget-minded cinebugs, you'll have little trouble

building a camera dolly that will enable you at times to shoot, as the studio cinematographer does, by moving in or away from your subject without stopping the camera.

On the other hand, editing of your color pictures with an eye to continuity in color as well as in the story, can be accomplished fairly successfully without the necessity of follow-shot photography. The essential, of course, is that care be taken in editing so that a normally toned scene, for example, is not followed by an overly-brilliant one and vice-versa. If a sequence starts out with a mass of blue color predominating in the scenes, this color should remain fairly dominant throughout the sequence and not be abruptly broken by the injection of a shot in which a preponderance of vivid red color exists. The continuity of colors should remain unbroken in the sequence, or the transition to another should be gradual.

While this new editing principle applies particularly to scenarized movies, the essence of it can often be applied to simpler forms of amateur movie making. If a scenic or travel film consists of a series of unrelated shots of a number of subjects, little of what has been written here can be applied to its editing. On the other hand, if a scenic film was properly shot in a series of short sequences, it can, undoubtedly, be edited in such an order as to keep predominating color tones from clashing at the point of cutting.

It follows that in order to successfully apply this color film editing technique, more and more attention must be given to planning our pictures before shooting. It should be remembered that regardless of how simple a home movie we are making—even the

Something NEW

A smooth running geared panoraming device at a reasonable price!

KIN-O-PAN

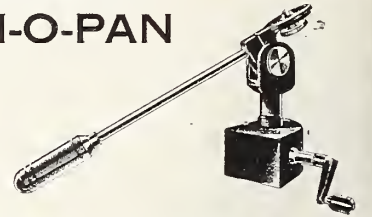

360° horizontal swing—approximately 180° vertical; sturdy, precision construction hitherto available only to the 35mm man.

\$12.50

Write for Booklet H-15

KIN-O-LUX, INC.

105 W. 40th St.

New York

AMERICA'S FOREMOST ECONOMY MOVIE FILM

8mm as low as \$1.39



16mm as low as \$2.25

Not just another "cheap" film but a quality product 100% American made, guaranteed to give customer satisfaction, processed free at either of our laboratories.

You owe it to your customers to acquaint yourself with this popular low priced film!

WRITE FOR CIRCULAR AND DEALER DISCOUNT SCHEDULE

SOLAR FILM CO.

MAIN OFFICE: 3827 Archer Ave., Dept. P1, Chicago, Ill.
 WEST COAST BRANCH: Box 45, Dept. P2, Arlington, Calif.

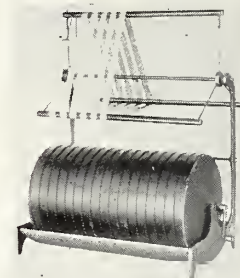

SAVE! Develop

Your Own MOVIE FILM Now Sold for \$18.75

Capacity: 33 feet of Double 8mm or 16mm Film
 At Your Dealer or Direct

GRAHAM & EDISON CO.
 Indianapolis, Ind. Box 5413

TEAMMATES

DeJUR Model 5A

Photo-Electric Exposure Meter . . \$11.50

With Sling

(Pigskin Zipper Carrying Case . . \$1.00)



DeJUR Superimposed Image Range Finder . . . \$5.50
 With Sling and Genuine Leather Case

Made in America for All the World by

DeJUR-ANSKO CORPN.
 SHELTON, CONNECTICUT

NO CHARGE

If you'd like to make your own professional-looking titles, write immediately for your free copy of the New Title Making Tips. Give make of camera and name of dealer.

BESBEE PRODUCTS CORP. Trenton, N. J.

shooting of just a few scenes of the baby—we are seeking to tell a story. Any story must have a beginning, a climax, and an end. Invariably then an opening shot, medium shots, and closeups are necessary for a successful continuity, and they should, when filmed in color, be planned with an eye toward color continuity as well.

More than ever, this shooting for color continuity calls for flexibility in filming plans, allowing for more latitude in camera-editing. In spite of very careful advanced planning, it is not always possible to visualize the opportunities for improving continuity that comes to a filmer at the time of shooting. Making an extra closeup or an angle shot, or altering the camera set-up for improved color composition invariably provides valuable material for building greater emphasis and rhythm in a sequence.

Rhythm is the essence of successful film editing, just as it is in music and poetry. It is imparted to a sequence by proper cutting of each

shot, by the length of time that one scene plays on the screen in relation to the other scenes in the sequence. The long shot plays for a longer time than does the closer shots. As we work into the closer shots—as we approach the high-spot—the cutting becomes faster and the point of interest is shown in brief scenes from different angles. After the climax is reached the succeeding scenes are generally of equal length in order to sustain the tempo and interest desired at this point.

In editing "Gone With The Wind," the climaxing shots of one sequence were trimmed to nine frames each! These appear in a sequence where a group of the leading women characters are seated about a table sewing while they await the return of their menfolk—knowing that outside, a detachment of Yankee soldiers also await them. Suddenly, they hear the voices of their loved ones raised in song, and we attempt, in a series of rapid cuts—each shorter than the previous one—to show their anxiety and apprehension. The climax is emphasized in a succession of nine-frame cuts showing the women leaving the table when they hear the challenge of the enemy captain—all nine-frame flashes of highly dramatic action—the suspense peak of the sequence.

The two most common methods of beginning a sequence is either to open with a long shot and gradually move in closer, or to open with an insert and gradually move away. The reproductions shown here are from the production, "Gone With The Wind," which illustrate the opening of a sequence with a medium shot and the series of closeups that follow. The latter shots were made in the manner described in the beginning of this article—by moving in closer with the camera mounted on a mobile base. There is no break whatever in the sequence nor in its continuity of color. This enables

• All Amateurs, whether subscribers of HOME MOVIES or not, are invited to submit their films to the editors for review and helpful criticism. Unless otherwise requested, reviews of some of the films which we believe would benefit other amateurs will be published each month.

Reviewed films will be rated one, two, three, and four stars, and films qualifying for two or more stars will receive free, on animated leader indicative of such award. Detailed reviews, with suggestions for improvement—if any—will be mailed to amateurs submitting their films.

Exceptional films qualifying for the distinction of the "Movie of the Month" will be treated in detail in a feature length article in a following issue of HOME MOVIES. In addition, a certificate evidencing the award of "Movie of the Month" and a special animated "Movie of the Month" leader will be returned with such films after review.

When submitting films for review and analysis, please advise make of camera, speed of lens, whether or not tripod was used, or if you used filters, exposure meter, or other accessories. While this information is not essential to obtain analysis of your film, we would like to pass it on for the benefit of other amateurs.

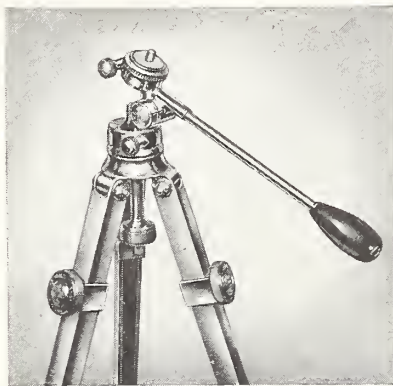

New
and
Different

THALMETAL TRIPOD

To the many owners of 8mm movie cameras and miniature cameras who have asked for a metal tripod we offer the new and unique Thalmetal tripod. The upper leg section is a rigid channel of polished metal while the lower section is tough black hardwood. It is completely Rigidized and fitted with Sure Foot Points. The Precision-built Pan-Tilt Head has full panorama sweeps, Instant-On Plug and chromium finish. This tripod is outstanding in appearance—in serviceability—in dollar value.

Thalmetal tripod, complete with head, \$14



SURE FOOT POINTS

A shoe of soft tough rubber for smooth hard surfaces instantly interchangeable with a double-pointed spur for rough crumbly surfaces.



Two Valuable Books Now Available ABSOLUTELY FREE

1. Our Twentieth Anniversary Catalog of Rental Films, listing:

16mm TALKING PICTURES
16mm SILENT PICTURES
8mm PICTURES

2. Catalog of Religious Films:

16mm TALKING AND SILENT

•
Our Gigantic Library Contains Over 4000 Motion Picture Subjects—We Have Suitable Films for Every Occasion—Get These Catalogs Today

•
IDEAL PICTURES CORP.

28 East Eighth Street
Chicago, Illinois

IDEAL PICTURES CORP.

and
2402 West Seventh Street
Los Angeles, California

GRAPHICHOME BULK MOVIE FILM**AT LAST! 8mm BULK MOVIE FILM** with Daylight Leaders and Trailers

- Easy to Load, Notched, Reversible
- Also 16mm Film Measured and Notched

Here it is! The New GRAPHICHOME film perfected to make it easy for you to load your own spools. A top grade, ORTHO type, medium speed film adaptable to any 8mm or 16mm camera (excepting mag. loading type). Takes professional quality shots, clean, clear, sharp. Saves you 66 per cent.

200 ft. 8mm—notched in four 25 ft. scored double 8 rolls, including DAYLIGHT LEADERS between each load (Weston 8) \$1.75

400 ft. 16mm—measured and notched in convenient 100 ft. lengths \$4.00

GUARANTEED PROFESSIONAL PROCESSING at new low prices.

100 ft. 16mm 85c 25 ft. dbl. 8mm 50c

Send today for your GRAPHICHOME FILM. All film sent postpaid. If C.O.D., postpaid extra. FREE literature. Write to SUPERIOR BULK FILM COMPANY, Dept. HMI 188 W. Randolph St. Chicago, Ill.

the action to flow smoothly, uninterrupted by any abrupt change of color-pattern on the screen that might otherwise occur were these shots filmed and edited by earlier methods.

The amateur striving for perfection in his color filming will seize upon this improved editing technique

and adapt it to his future movie making. In shooting shots of the baby, for example, keep the background colors uniform in each shot of the sequence. If it's a travel movie you are about to shoot, film it in sequences rather than by making random pot-shots, and keep an eye on your colors in com-

position. And when you are plotting a scenarized movie, plan your sequences so they may be shot with a minimum of abrupt color change in each scene. When this isn't possible, then more ordinary attention should be given to editing for color harmony at the editing board.

4 "hows" for making movies . . .

• Continued from page 12.

part, the sound will be different and you should be automatically trained to take your finger off the trigger and look for the trouble.

When you have completed your ground practice, get some film, load your camera and be prepared for another practice. Since film manufacturers have developed so many different emulsions today, be sure that you select the film that is best suited for the particular job on hand—then be sure that you familiarize yourself with the emulsion speed of this particular film. It is wise for the beginner to select an all-purpose film for his first work and not try to use the super fast films until he has mastered average work and is ready to tackle more difficult and complicated problems that can only be handled with special films. When you buy film, try to get it from a dealer who can give you intelligent advice as to its speed and definite information as to the average lens stop to use for objects in bright sun in your particular part of the country.

With your camera loaded, and with the proper lens stop setting for ideal conditions clearly set in your mind, you are ready for actual photographic tests. If it is at all possible to make these tests under ideal lighting conditions, this is the most perfect starting point and will serve as a true basis for figuring exposures under all other con-

ditions. While a perfectly adjusted exposure meter is of undisputed aid in figuring the exact exposure, I believe it is advisable to first develop an ability to figure the exposure yourself by merely knowing your film emulsion and recognizing the light intensity on your subject. If you start to depend upon an exposure meter you will be helpless without it and you will not have the instinct to know when your exposure meter might be out of adjustment. After you have mastered the fundamentals of exposures, then you can use an exposure meter to advantage, especially when the value of the light is off-standard and uncertain.

You have determined your proper exposure in advance for normal good light and you know what scenes you want to make, so your only worry is the focus. For your general view that shows the whole house, set your focus on infinity and for each succeeding scene determine just how far your objects are from the camera and set the focus dial at that distance. If you are not adept at estimating distances, then the safest way is to measure the distance with a tape measure. All professional cameramen have their camera-subject distance measured with a tape measure and then set their focus accordingly. They, however, have the advantage of examining the image on the ground glass in their cameras to check up the focus.

If the day is a bad one

and the light is poor and you cannot wait for good conditions, then you have three alternatives. Consult the exposure guide which comes with your camera, ask advice from someone experienced in camera work, or use an exposure meter. Practically all cameras are accompanied by an exposure guide which gives the average setting for a wide variety of conditions such as:

Intense light, snow, sand or seascapes.

Bright sun.

Dark objects in bright sun.

In shade on bright day.

Cloudy but light.

Dark light.

Very poor light.

Interiors.

Camera manufacturers through extensive tests have worked out these guides and they are as nearly accurate as possible. It's up to you to interpret the condition which faces your camera.

After you do this you will have a definite feeling of

• We want suggestions and ideas for random "backyard" filming; also for simple home movie scenarios. Those which are published will bring the contributors either a 100-ft. 16mm or a 50-ft. 8mm film subject selected from the advertisements or catalogues of any library or producer-advertiser in HOME MOVIES magazine.

For ideas that can be adapted to a feature length article we will reward the contributor with two rolls of panchromatic film. Address your suggestions to BACKYARD MOVIES, care of HOME MOVIES, 6060 Sunset Boulevard, Hollywood, Calif.

Your Yuletide Pictures

will furnish your Audience with a real **HAPPY NEW YEAR** if they contain **TITLES BY PARK CINE**

CATALOG FREE ON REQUEST

PARK CINE LABORATORY
120 West 41st St. New York City

16MM World's Greatest Variety
Titles: Trailers **5,000 BACKGROUNDS**
Complete Music Library!

WORLDS LARGEST TITLE SERVICE
Now you can have the same deluxe 16 mm titles and trailers that Filmack supplies to thousands of theatres. Smart professional work either silent or sound. Filmack's nation-wide service includes titling, editing, developing & scoring. Send your trial order today and be convinced. Write for catalog

FILMACK LABORATORIES
845 S. Wabash Chicago

16 MM TITLES - TRAILERS - DEVELOPING - ETC.

Better Movies with BLACK and WHITE FILM

Black-White
100 FOOT SAFETY FILM ON DAYLIGHT LOADING SPOOL FOR 16 MM CAMERAS

16 MM, 100 Ft. \$1.98 Includes Reversible Film Processing Rating Weston 12 Scheiner 18
At your dealer or direct. Fast service processing same day included at no additional cost.

VISUAL INSTR. SUPPLY CO.
1757 B'way Box H9 B'klyn, N. Y.

Kodachrome
MAPS • Charts • FINE TITLES
Geo. W. Colburn Laboratory
Special Motion Picture Printing
1197 Merchandise Mart, Chicago

Harvest Festival! Photo Equipment at Low Monthly Terms

PERFEX "44" or 9x12 FILMPACK, \$3.33 per mo.; B & H FILMO, \$1.30; Cine Kodak 8, Model 20, \$2.64; Leica G, f:2, Chrome, ER Case, \$7.73; Ikonta B, f:2.8, ER Case, \$7.47; Reflex Korolle, \$6.11; Elwood, 2 1/4 x 3 1/4, f:4.5, \$5.70; Solar 35mm to 2 1/4 x 3 1/4, f:4.5, \$5.70; Ideal 35mm to 4x4cm, f:4.5, \$5.70; Leitz Valoy 35mm for Leica, \$5.70; Simmon Omega A, 35mm, f:4.5, \$6.03; Omega B (2 1/4 x 2 1/4), f:4.5, \$6.37; Super-Multifax to 2 1/4 x 3 1/4, f:4.5, \$6.37; and many others in NEW BARGAININGS — on request. Nationwide payment plan.

MOGULL'S 55 WEST FORTY-EIGHTH ST. at Radio City, New York, N. Y.

.. TITLES .. **16MM**
BACKGROUNDS FREE
Reducing ★ Enlarging
ILLUSTRATED CATALOGUE
GENERAL CINE SERVICE
204th East 18th St., New York

confidence and you will be ready to go ahead with the real job of making pictures that are not only technically perfect but which will hold the interest of your audience.

An experienced cameraman adjusts his camera au-

tOMATICALLY, thereby reserving his energy and ability for the more difficult task of moving around for strategic camera angles and directing the action which, after all, is the most vital factor in convincing motion pictures.

Titles are easy to make

• Continued from page 22.

And so if you center your title in the finder, you cannot expect it to be centered on the film.

Since this is such an important factor in title making, we believe the typewriter-titler is the best for the beginning amateur because it provides for accurate alignment of camera with title card. Also, it is fitted with a supplementary lens necessary for photographing the title card at the relatively close distance to the camera.

Focusing is the third and most important adjustment you must make for any close-up photography of titles when a typewriter-type titler is not used. Some lenses may be focused for distances from 2 feet on to infinity, while others are of the "fixed focus" type, which means they are reasonably sharp for all distances beyond 6 or 7 feet. Let us assume your title is 4 feet away from the lens. With the focusing lens, you can set the lens at 4 feet, but with the "fixed focus" model, your letters will be slightly fuzzy, or out of focus as we prefer to call them. In such an instance you will need to use a supplementary lens in front of your camera lens. Your dealer has them, and you will find them easy to use. The supplementary lens changes the focusing distance of your lens (depending upon its "dioptré" rating) so be sure to follow directions carefully. If there is any doubt in your mind, your dealer will gladly help you.

These supplementary lenses are built right into

most of the smaller titling devices on the market, so that once the "titler" is bought, there is no focusing worry.

Now that you've set up your camera and title, you might wonder just how long to run the exposure. Probably the easiest way is to set the camera on normal running speed (16 frames per second), start the camera, read the title through slowly, then stop the camera. In case of doubt, it is a good idea to run the camera a bit too long. Any extra frames can be cut out when the title is spliced into the finished film.

If you make any error at all in titling your film, it will be that you will make too many titles. Perhaps this would be best explained by first analyzing a movie title and finding out why we use them. The only reason titles are put into a film is to explain the film if it doesn't explain itself. So, then, if a scene is self-explanatory, there is no need to title it.

For example, let us suppose the scene in question is of two kids rolling huge snow balls. One might title the scene with the words, "Rolling snow balls." Now for a main title, that is, one which is to do for the entire reel, that would be acceptable, providing the whole reel were of rolling snow balls. But for just an ordinary scene, that title is, indeed, superfluous. Why? Because it does not tell us anything the scene does not tell us. We can see the snow balls being rolled, so why the title? But if we should say "Bob and Helen spend Christmas morning rolling

Hollywood's Latest . . . For Better Pictures

NEW "DINKY INKIE" LIGHT

Powerful All Purpose

100-150 WATT SPOTLIGHT

For Only \$15.00



\$15 Ht. 7½", Diam. 5½"
Wt. 2¾ lbs.
With 15 ft. of cord.

Here at last is a powerful yet small-sized, light-weight, inexpensive, all-purpose light—to high-light portrait subjects and for greater flexibility in modeling close-ups; to eliminate shadows and dark corners in indoor movies. Easy to carry and set up on your tripod; locks in any position. Operates in absolute silence. Will not heat up excessively even after hours of use. Light output will focus from an 8-degree spot to a 44-degree flood. Lever arm, protruding from both front and rear, is moved from side to side for instant focusing spot to flood. Numbered graduations enable duplicating a given focus position. The "DINKY INKIE" is the "rave" of Hollywood cameramen because it supplies so many lighting needs. At only \$15.00—how can you do without it?

ASK YOUR DEALER FOR DEMONSTRATION

Distributed by

EASTMAN KODAK STORES

Manufactured by

BARDWELL & McALISTER, INC.

7636 SANTA MONICA BLVD.

HOLLYWOOD

CALIFORNIA

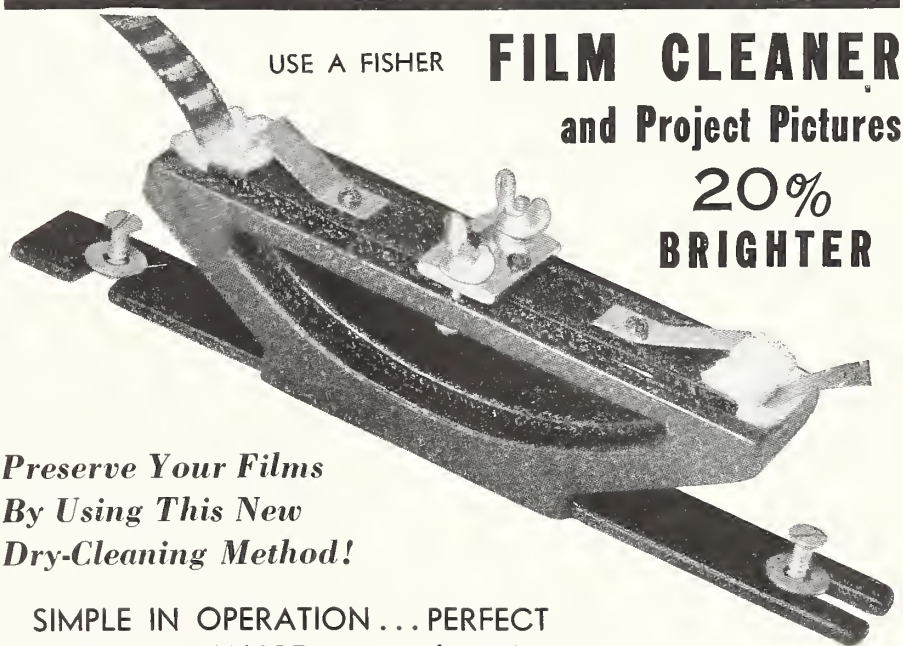

USE A FISHER

FILM CLEANER

and Project Pictures

**20%
BRIGHTER**

**Preserve Your Films
By Using This New
Dry-Cleaning Method!**

**SIMPLE IN OPERATION... PERFECT
IN PERFORMANCE... 8 and 16MM**

Clean films last longer, and project 20% more brilliantly! Mount this Fisher Film Cleaner on your re-wind board and clean and re-wind your film in one easy operation.

Send a Money Order Now... We Pay Postage

MARKS & FULLER, Inc.

DEPT. HM-1

ROCHESTER, N. Y.

In the Heart of the Photographic Industry Since 1860

\$6.50 COMPLETE
WITH 12 EXTRA
CLEANING PADS

At Your
Dealer's or
Direct

16mm COLOR MOVIES*For Outright Sale***EUROPE**Germany
Switzerland
Czechoslovakia
Hungary
Austria
ItalyLuxembourg
France**BRITISH COLUMBIA****AND ALBERTA**Lake Louise and
BanffVictoria
Vancouver Island

Vancouver, B. C.

WESTERN U. S. A.

Colorado

Mesa Verde

Grand Canyon, Ariz.

Bryce Canyon, Utah

Lake Tahoe

Yosemite National Park

Los Angeles

Monterey

San Francisco

San Francisco Fair—1939

Yellowstone Nat'l Park

Teton National Forest

Rodeo at Worland, Wyo.

Devils Tower

Black Hills, S. D.

SEND FOR FULL DETAILS on these fine subjects. Beautifully photographed—superbly edited. Every one a valuable addition to your library.

RENTAL SERVICE—Our fine rental library contains over 350,000 ft. of 8mm and 16mm silent and 16mm sound subjects in black and white. Send 5c for film rental catalogue to cover postage. Rental films shipped only within a radius of 500 miles from Chicago.

ZENITH CINEMA SERVICE

5011 N. SAWYER AVE., CHICAGO, ILL.

*Fine Movies Since 1924***Save ON PHOTOGRAPHIC EQUIPMENT***Write for our FREE CATALOG no obligation!*

Everything you need for the enjoyment of your camera hobby, "Still" or "Movie."

WRITETODAY!

SUNNY SCHICK*National Brokers*

403 W. WASHINGTON BLVD.

FORT WAYNE, INDIANA

MODERNIZE—Trade in Your Equipment!**8mm SLITTER**

Slits perfectly 16mm width film to exact 8mm width. Die cast body with hardened steel cutting wheels. New price, each, \$2.50.

DEVELOPING RACKS

Stainless steel, take 30 feet 16mm or 8mm width film. Can be used in 11x14 or 8x10 flat trays respectively. Complete with loading stand, each, \$6.75. Specify type wanted.

*At Your Dealer's or Direct***J. C. Haile & Sons***Motion Picture Dept.*

215 Walnut Street Cincinnati, Ohio

**24-HR. FINISHING GUARANTEED****45c**30 ft. of double 8mm.....
Genera, Pellex, Etc., Processed 25c
30 ft. single 8mm.....15c
30 ft. Univex Standard & U. P.....15c**ESO PICTURES***Quality 8mm Service*

3945 Central Kansas City Mo.

**GIBBS FLOOD-GUNS**

The ONLY flood-light that follows the camera. Models for either still or movie cameras.

ARTHUR E. GIBBS

1925 N. E. Knott St. Portland, Oregon

BETTER

Write for our price list.

WONDERLITE CO. 14-H Northfield Ave.
WEST ORANGE, NEW JERSEY**Home Movies**when you use
Wonderlite Photo Lamps

snow balls," then we have an informative title, because it tells us the names of the persons in the picture, and also fixes the time the picture was taken. The picture alone fails to tell us either of these things.

Perhaps you ask why we don't just say "Bob and

Helen on Christmas morning." The answer is that we do not have a complete sentence, and all good subtitles are complete with subject and verb. Yes, and the verb is nearly always written in the present tense, too, just like a good newspaper headline.

Speed deceives beginner• *Continued from page 24.*

est, certainly it would be distracting to have all the detail in the background clearly defined also. The human eyes do not see things that way; they focus on one object, and all other objects are subordinated—out of focus.

Finally, contrary to general belief, definition is lost, not gained, as the lens is stopped down. That is, all objects within and outside the sharp focal area become slightly fuzzier as the stop becomes smaller.

Films have become faster and faster with recent years. The new emulsions have given photography a great boost, and they have made it possible to take pictures under conditions of

extremely poor light.

The mistake the beginner often makes is to attempt to use these fast films universally. It should be explained that as a film becomes faster, grain structure increases considerably. This means that such negatives cannot be enlarged to the same proportions as those made with a slower emulsion. There is not as much latitude, either, in the faster films, so you will have to hit the exposure on the nose in order to get a negative of good quality. The beginner should select one of the slower panchromatic or orthochromatic films for general use, taking advantage of the super-fast emulsions when the occasion calls for it.

"It's new to me . . ."• *Continued from page 29.*

data, formerly so uncertain and so difficult to calculate, is thus made available at one's fingertips by the simple movement of the Title-scope dial. A few of the important factors which the instrument shows are: exact height and width of the included field at any closeup distance, using the 15mm, 20mm, one-inch, two-inch, three and four-inch lenses for 16mm cameras, for 12.5mm or 25mm lenses with 8mm cameras; exact distance at which to place and object so that it will fill up the included field of the lens; exposure on various types of film—color and

monochrome—when using two flood type bulbs for standard title illumination; distance at which to place bulbs for even lighting of the surface with various sizes of title cards; a handy conversion table to read from inches-feet to millimeters-centimeters and other features.

The Titlescope is constructed entirely of metal and can never wear out. It is attractively engraved in two colors for easy reading, and comes in a protective leather container which is handy to carry in the pocket or keep in the desk.

Workshop• *Continued from page 31.*

three stout rubber bands, as shown here. When assembled, this lighting standard may be tilted, raised, or lowered as required.

In assembling, insert broom stick through rubber band at position No. 1 first; then push stick down and pass it through rubber band No. 2. Attach the reflector to top of stick in a similar manner. If lamp is to be burned for any length of time, use stout cord or wire in lashing reflector to stick.

I find this type of lamp support more rigid than the usual reflector tripod. Where the reflector is to be elevated to a considerable height, there is less danger of lamp toppling over.

—Rocco Rotundo.

Kinks• *Continued from page 28.*

measured and computed directly with an exposure meter. Simply take direct readings of the darkest and lightest part, dividing the former into the latter. This gives you scene brightness range, which, with gamma of development, controls *negative density range*, which is the actual contrast designation of the negative.

A practical application of this is found in the adjoining chart. Having measured the scene of brightness range of a particular scene, it is possible to determine at what gamma the film should be developed to make the best print on the most suitable paper. For example, if the scene brightness range is 16 (the strongest highlight giving a reading sixteen times that of the darkest dark), in order to print the negative on medium paper, you will develop to a gamma of .8 or .9. Tables which tell you how long a develop a film to achieve a certain gamma are usually furnished by the film manufacturer or included with developers.

The **BOOK** of the **Year**

... ready January Tenth!

The latest, most complete book on titling home movies which includes, in addition to plans for building the Home Movies Titler —

- Title Area Chart
- Diopter Lens Chart
- Data on Shims for Ultra Closeups
- Lighting Chart for Titles
- How To Make Trick Titles

— in all, approximately 100 pages jam-packed with vital information for the amateur movie maker!

\$1.00

PER COPY

**Reserve
Yours
NOW!**



VER HALEN PUBLICATIONS
6060 SUNSET BOULEVARD • HOLLYWOOD, CALIF.

WHEN IT'S *Speed* **YOU WANT...**

SUPER-XX (16 mm.)
SUPER-X (8 mm.)

IF YOU really wanted to film that proverbial, "black cat in a coal bin at midnight," you'd undoubtedly load with Ciné-Kodak Super-XX Film (or Super-X, if you're an "Eight" enthusiast).

Chances are, you're more interested in getting really good, usable shots of casual indoor scenes, or records of indoor sports events, or night street scenes, or outdoor shots in poor light.

Ciné-Kodak Super-XX is your 16 mm. film. It has speed, abundant speed. But it also has brilliance, excellent tonal gradation, minimized grain, and true panchromatism. Super-XX is the easy answer to tough movie-making problems.

For users of 8 mm. equipment, Ciné-Kodak Super-X is the speed film. But its speed is balanced by truly fine grain—an essential in successful 8 mm. movies. Add thoroughgoing photographic quality, and the success of Super-X is easy to understand. For speed plus quality, rely on Super-XX (16 mm.) and Super-X (8 mm.). Be sure you have a roll or two on hand, so that the shots that only speed films can achieve can be yours—beautifully and with the ease that signifies mastery.

EASTMAN KODAK COMPANY, ROCHESTER, N. Y.

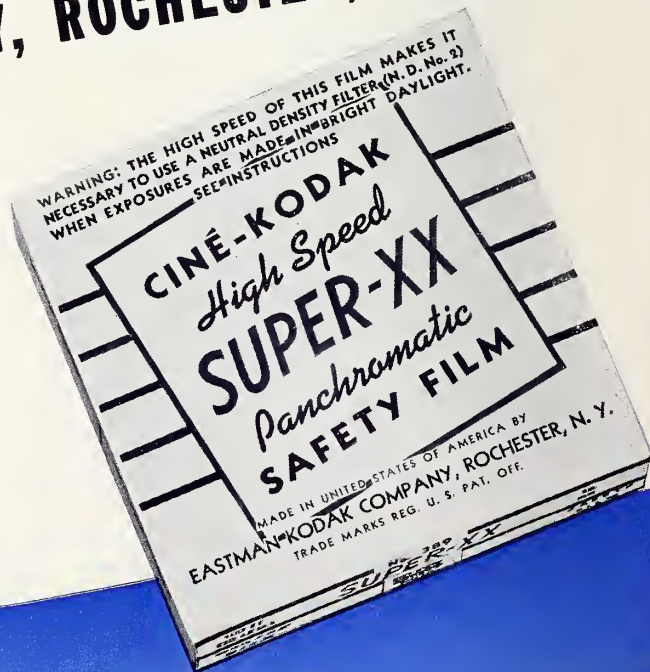
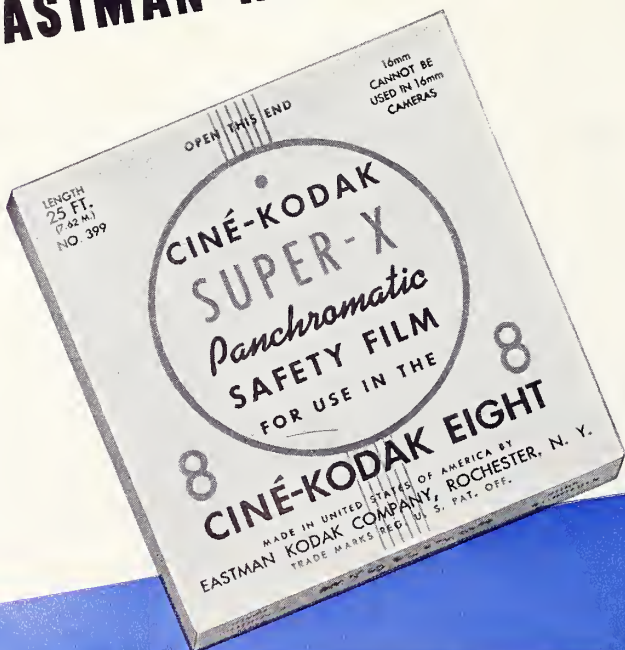

Price 25c

HOME MOVIES



February • 1940

Hollywood's Magazine for the Amateur

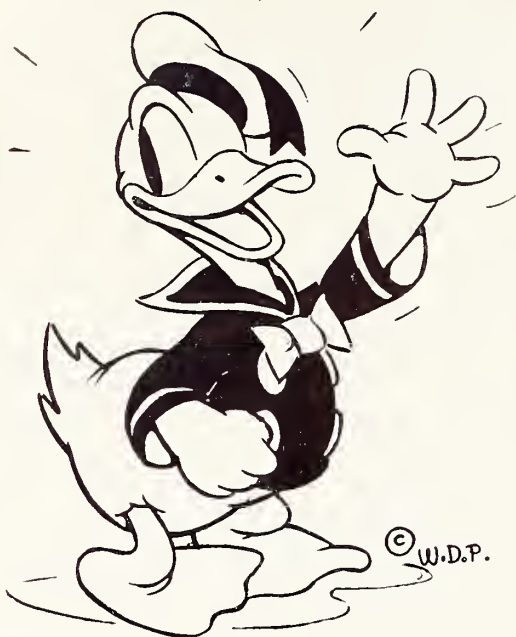

Animated cartoons are the real life of home movie shows. Hollywood Home Movies feature, exclusively, all of the popular Walt Disney characters; also Oswald Rabbit, and Meany, Miny and Moe. Long the spice of the nation's theatre programs, these rollicking comedies are now available to you in either 8mm or 16mm.

Write for the new 80-page catalog listing all of our 8mm and 16mm home movie films; it's free!

TRAVEL FILMS

Added to our extensive list of travel and educational films are the following subjects, available in both 8mm and 16mm:

PRIMITIVE MAORI (Part 4) No. 1108-A

Depicts primitive village life, including many of the native games filmed by special permission of the native chieftains. A rare and valuable subject, adaptable to all types of audiences.

50-ft. 8mm — \$1.00
100-ft. 16mm — 2.25

BREATHLESS MOMENTS . . . No. 1109-B

A fair mountain climber and her guide scale Mount Sebastopol, in New Zealand's Southern Alps, pulling themselves over ledge after ledge up to the snow line and to the very pinnacle; a thrilling and beautiful picture.

50-ft. 8mm — \$2.00
100-ft. 16mm — 5.00

HAWAII No. 474-C

If you missed filming the beauties of Hawaii on your visit there, you'll want this film. If you've never been there, you'll want the film all the more! Scene after scene depicts the rare beauty and charm of these fabled islands — shows the volcanoes, gay hotels, and intimate views of Hawaii's people.

200-ft. 8mm — \$3.75
400-ft. 16mm — 9.00

"If You Want A Good Laugh"

Screen these "hit" Cartoon Films!

MICKEY MOUSE, Minnie, and Pluto appear in almost all of the animated cartoons. Pictured here are Walt Disney's three popular characters after their laugh-provoking escape from Peg-Leg Pete in "Mickey's Big Slide," available in both 8mm and 16mm.

50-ft. 8mm — \$1.75
100-ft. 16mm — 3.50

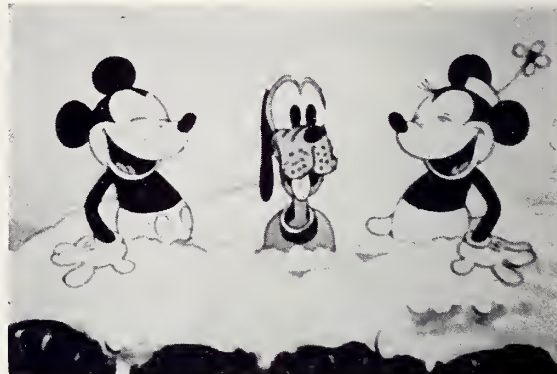

DONALD DUCK in his customary fit of exasperation virtually wrecks a car piece by piece as he seeks to repair it in his garage with the assistance of Mickey Mouse and Goofy. There's a bit of comedy by Goofy in this film that will "roll 'em in the aisles"! It's a "must have" for your film library.

50-ft. 8mm — \$1.75
100-ft. 16mm — 3.50



OSWALD RABBIT turns cop in "G-Man Oswald," a rollicking cartoon packed with laughs from start to finish. Oswald and his assistant pick up a radio call flashed from police headquarters that send them in search of two truant "lambs." They finally catch them — also a barrage of pies!

50-ft. 8mm — \$1.75
100-ft. 16mm — 3.50

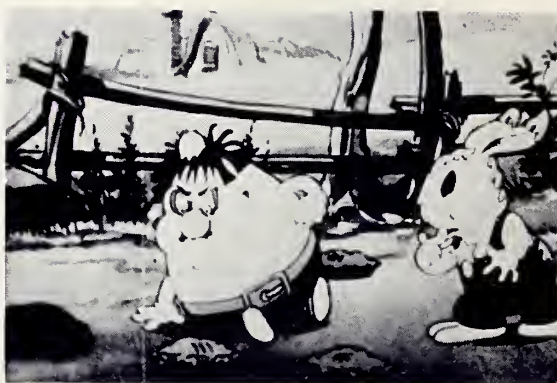

MEANY, MINY and MOE are the funniest animated cartoon characters to appear on the screen in some time. "Pickled Herring," a scene of which is reproduced here, involves Moe and a tough sea captain. Moe pursues a pickled herring, gets pickled himself. Then, follows some highly amusing antics.

50-ft. 8mm — \$1.75
100-ft. 16mm — 3.50



HOLLYWOOD FILM ENTERPRISES, INC.

6060 SUNSET BLVD. • • HOLLYWOOD, CALIF



Home Movies

MAGAZINE



**Subscription
Order Form**



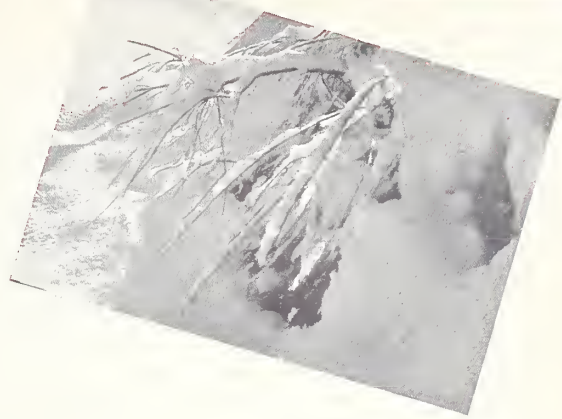

home MOVIES

Copyright 1940 by Ver Halen Publications. No part of magazine may be reprinted without specific permission.

CONTENTS FOR FEBRUARY, 1940

I'VE GOT A PROBLEM..... 56

THE READER SPEAKS..... 58

BACKYARD MOVIES..... 60

TITLE TROUBLES..... 62

BONERS TO AVOID IN SHOOTING HOME MOVIES..... 64

WHEN A BEGINNER, I MADE MISTAKES, TOO!.....By Eddie Collins 65

AMATEUR MOVIES CLICK IN THEATERS.....By the Editors 66

DAYLIGHT CAN LOOK BRIGHT, YET BE WEAK.....By Chas. W. Herbert, A.S.C. 68

"WHISTLING WINGS"—MOVIE OF THE MONTH...By J. H. Schoen 70

SIX THINGS A MOVIE NEEDS TO GIVE IT "OOMP"..... 71

HOLLYWOOD'S LIGHTING SECRETS ARE YOURS...By Howard Souther 72

THERE'S FILMING TO DO IN WINTER, TOO!.....By Peter S. Bezek and E. Moss Brown 74

TELL ME — HOW CAN I IMPROVE MY FILM?...Reviews by the Editors 76

THESE NOVEL EFFECTS ARE FUN TO MAKE...By Geo. W. Cushman 77

A TIP OR TWO ON FILMING TRICKS AND EFFECTS.....By Eugene M. Liebscher 78

YOU CAN BUILD THIS 16MM CONTINUOUS PRINTER.....By Walter W. Light 79

IT'S NEW TO ME!.....By Cinebug Shopper 80

EXPERIMENTAL CINE WORKSHOP.....82-83

TITLE BACKGROUNDS.....By Edmund Turner 86

INDOOR LIGHTING CHART..... 97

DIRECTORY OF AMATEUR CINE CLUBS..... 99

FEBRUARY
1940
NUMBER 2
VOLUME VII



CHAS. J. Ver HALEN
PUBLISHER

C. J. Ver HALEN, JR.
ASSOCIATE PUBLISHER

ARTHUR E. GAVIN
EDITOR

RAY FERNSTROM
TECHNICAL EDITOR

GEORGE W. CUSHMAN
R. E. MERVILLE
J. H. SCHOEN
ASSOCIATE EDITORS

COUNT H. C. A. von SCHOENFELDT
PHOTOGRAPHIC EDITOR

L. C. BUSCHER
ART DIRECTOR

OFFICE OF PUBLICATION
6060 Sunset Boulevard, Los Angeles, Calif.
Phone GRanite 6414

NEW YORK OFFICE
Everett Gellert, 62 West 45th Street
Vanderbilt 6-5254

CHICAGO OFFICE
C. N. Burris, 362 Wrigley Building
Whitehall 7784

ADVISORY EDITORS

B. GRIFFITH
Sunkist Movie Club

R. E. GIBBS
Portland Cine Club

S. DVORAK
Suburban Amateur Movie Club

N. P. WALSH
St. Louis Amateur Movie Club

A. HOOK
Seattle 8mm Club

W. MULLISON
Amateur Cinema Club of Norristown

PERSON CLYMA
Detroit Society of Cinematographers

SISSEL
Austin Movie Club

O. ROTH
Sherman Clay Movie Club

E. SNYDER
Des Moines Y. M. C. A. Movie Club

ENION SMITH
Metro Movie Club of Chicago

JART BUSSEY
Super-Art Movie Club

KLIN SKEELE
Los Angeles Cinema Club

GE DURAND
3H Camera Club (Movie Division)

LEMON
Boise Camera Club

R. D. ELLIOTT
Tacoma Movie Club

SS BROWN
Dallas Cinema Club

BEZEK
Chicago Cinema Club

GRANZOW
Greater Oakland Cinema Club

H. H. GAWLER
Washington 8mm Movie Club

N. SWANSICK
Bay Empire 8mm Club

GENDERS
Indianapolis Movie Club

L. A. DIXON
Pittsburgh Amateur Cinema Club

Second-Class Matter, May 6, 1938, at
office at Los Angeles, California, under
the Act of March 3, 1879.

on rates—U. S. \$2.00 a year. Canada
ar. Foreign \$2.50 a year. Single copies
ign single copies 35c. Copyright, 1940,
alen Publications. Advertising Rates on
Application.

Own Actual Movies of Naval

WAR

BATTLESHIP GRAF

**CASTLE FILMS EXCLUSIVE! THE ONLY
16mm AND 8mm MOVIES OF SEA EPIC
THAT ASTOUNDED ENTIRE WORLD!**



History Filmed as it Happened!

AT SEA!

SPEE SCUTTLED!

ON YOUR OWN SCREEN SEE:

Actual motion pictures of the most exciting sea episode of the war...all in one startling home movie reel! Dramatic sea-raiding career of German pocket-battleship and world-arresting events leading up to sensational end of \$19,000,000 warcraft in Montevideo Harbor.

Only tremendous volume enables us to maintain Castle Films regular low prices!

8 mm: 50' — \$1.75 180' — \$5.50
 16 mm: 100' — \$3.50 360' — \$8.75
 Sound-on-film: 350' — \$17.50

Delivery cannot be guaranteed unless you place your order with your photographic dealer today!

CASTLE FILMS

NEW YORK, RCA Building • CHICAGO, Wrigley Building • SAN FRANCISCO, Russ Building

GOOD NEWS!

Professionalize Your Movies! Save 15%!

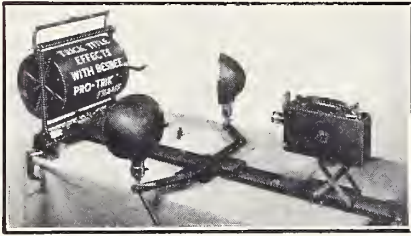

Here's the news you've been waiting for. Sensational price reductions on three important Besbee accessories. Now you can give your home movies the same titles and trick effects you have seen on the professional screen. Enjoy better and more attractive movies, and save money on the following Besbee products:

BESBEE UNIVERSAL TITLE MAKER, with 12 accessories . . .

Now Only \$12.50

BESBEE IMPROVED TITLE ILLUMINATOR, adjustable arms . . .

Now Only \$5.50

BESBEE PRO-TRIK TITLE FRAME, with 14 accessories and 150 title letters . . .

Now Only \$14.50

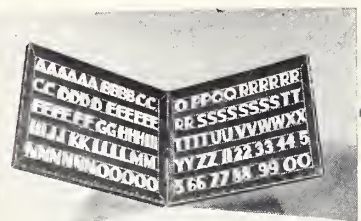

BESBEE PLASTIC TITLE LETTER SET

Clean-cut, all white plastic letters in a grooved panelled case. Sharp outlines produce striking shadow effects. Letters easily cleaned; may be used indefinitely. The most beautiful letters ever produced. **\$5.50**



TITLE-SCOPE

Handy device for every movie amateur. Gives heights, widths, distances, exposures, etc. . . . for close-up work and title making. Complete with leather case.

Only \$1.50

Ask your dealer to show you the complete Besbee equipment which gives you more thrills to your movies. Write for NEW TITLE-MAKING TIPS, a fascinating folder which will be sent to you at NO CHARGE. Give make of camera and name of dealer. Besbee products are made in U. S. A.

BESBEE PRODUCTS CORP.

Trenton, New Jersey

I've Got a PROBLEM

Bonfire Filming (Larry Robinson, Boston, Mass.)

During a coming moonlight skating party, I want to make some shots of the gang around a bonfire. Will the light of the bonfire be ample to enable me to get good shots of those sitting around it with my f/3.5 lens?

A shot of this kind calls for use of one of the new fast films. Also, you could plant a "flare" in the bonfire which would burn sufficiently long to allow you to make the shots you want. Such flares are obtainable from leading photographic stores; also from fireworks distributors. They give off a good deal of smoke, so be sure to set up your camera with the wind blowing away from you and off the scene entirely.

Exposure Chart (Harry E. Wooster, Atlanta, Ga.)

Well, I've just looked at my first reel of movie film, returned to me from the processors this afternoon, and I can't say it's so hot. I followed the exposure chart attached to my camera to the letter, but some of my shots are under and over-exposed. I trusted the camera chart, as I have no exposure meter. Can you tell me why these bum shots turned out this way?

You say you read the camera exposure chart. But did you carefully read the instruction booklet that came with your camera? If you did, you found that while the exposure chart on your camera is correct for normal filming during the brightest hours of the day and in seasons other than late fall and winter, that some compensation must be made for filming under these latter conditions. Also, if the subject filmed is of darker than average

• READERS: This department is for your benefit. Send in your problems and our technical board of professional cameramen will answer your question in these columns. If an answer by mail is desired, enclose addressed stamped envelope.

tones, you may have to open up one stop.

A shot of the baby several feet distant on the garden lawn, for example, can safely be made by following the exposure guide on your camera, provided the sunlight is playing full upon the scene. If, however, under the same prevailing sunlight conditions, you wanted to make a shot of a group of children in the garden with tall trees and a preponderance of foliage in the scene and with the light striking them from the side instead of from the direction of the camera, it would be necessary to open up your lens about one stop for best results.

Closeups Fuzzy (Harry Edwards, Denver, Colo.)

All I hear or read about is "closeups." Make more "closeups"! I've tried it and mine are not so good. They are not half as sharp as my regular shots—sort of fuzzy.

• Continued on Page 89.

Whatsa

DEPTH OF FOCUS

This term is used to indicate the area or distance—near or far—over which a lens will render sharp definition. Depth of focus decreases as the size of aperture or the focal length increases.

Depth is governed by diaphragm aperture, focal length, and distance of object. With a given focus and object distance, the smaller the stop, the greater the depth. At a given distance and diaphragm opening, the sharper the focus, the greater the depth. With a given focal length and stop, the greater the object distance, the greater the depth.

LAW PHOTO PRINT DRYER

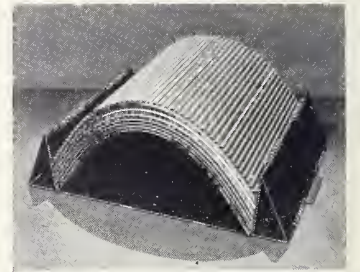

An efficient apparatus for those who demand flat and dry prints in a hurry. The materials used in the assembly of the Law Photo Print Dryer are not harmed with heat of 350° or less. Therefore the Dryer will withstand forced drying if desired.

Compact — yet has a capacity of
6 prints 11 x 14. 48 prints 4 x 5.
12 prints 8 x 10. 60 prints 3 1/4 x 4 1/4.
24 prints 5 x 7. 96 prints 2 1/4 x 3 1/4.

\$2.25

NOW AT A REDUCED PRICE! 3 TYPES OF VIEWING FILTERS



No. 1 — MONOTONE VIEWING FILTER shows the graduation of shadows that will register on panchromatic film — determines proper degree of lighting. Particularly important indoors.

No. 2 — ORTHO VIEWING FILTER completely absorbs all red color. Permits best arrangement of shadows and lighting with orthochromatic film. Indispensable in determining proper lens filter.

No. 3 — COBALT BLUE VIEWING FILTER gives correct middle tones and luminous shadows for all purposes and all types of film. Most important aid to proper outdoor photography.

Increased Production Results in New, Lower Price

75¢ each

Mail Orders Filled

Willoughbys

World's Largest Camera Store
110 West 32d St., New York

FOR
HOME
MOVIES



The Da-Lite Electrol Screen in Mr. Smart's home at Glenview, Illinois, is 12 feet wide and 10 feet high. It is placed just above the dining room windows and is out of the way when not in use. It can be instantly lowered by electrical control.

AS BRILLIANT
AS HIS *Esquire*
AND CORONET

Publisher DAVID A. SMART
Chose the Electrically Operated



Reg. U. S. Pat. Off.

ELECTROL SCREEN

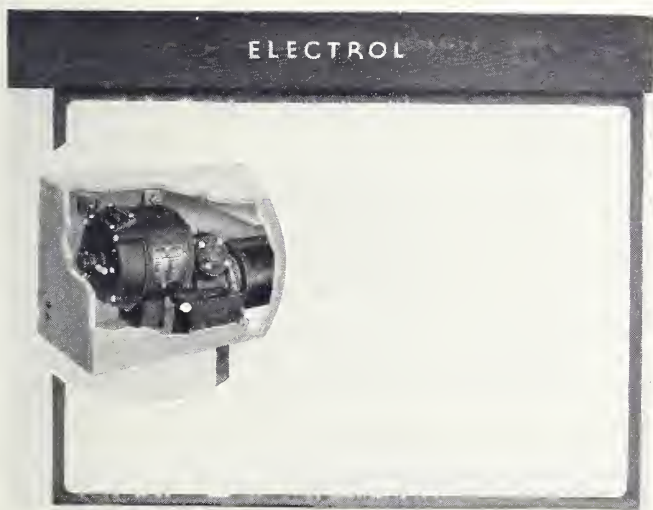

The DA-LITE ELECTROL SCREEN is available with Da-Lite Glass-Beaded or Mat White Surface in 14 standard sizes up to 20 ft. x 20 ft. inclusive. It is ideal for use in auditoriums as well as in homes and is used in the James Simpson Memorial Theater, Field Museum, Chicago, the Mellon Institute, Pittsburgh, and the recreational theaters of the Johnson Wax Co., Racine, Wis., and the Studenaker Corp., South Bend, Ind.

*

The DA-LITE CHALLENGER, consisting of screen, metal case, and tripod all in one unit, can be set up instantly anywhere yet folds compactly for easy carrying. The only screen with square tubing to hold the case in perfect alignment. Twelve sizes from 30" x 40" to 70" x 94" from \$12.50* up.

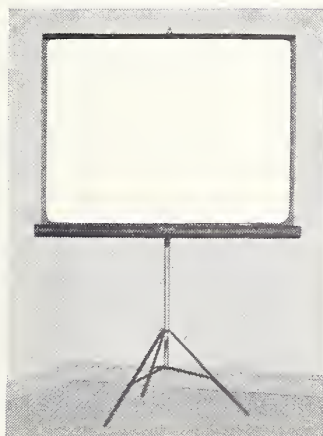

At the touch of a button, Mr. David A. Smart can lower his Da-Lite Electrol Screen for showing home movies. Pictures of theater brilliance are assured by the efficient Da-Lite Glass-Beaded surface which reflects maximum light without sparkle or glare. A motor and gear drive unrolls the screen from its case and just as easily re-rolls it. The screen stops automatically when fully lowered or re-wound.

Wherever a permanent installation is desired, the Da-Lite Electrol Screen offers maximum convenience. Da-Lite also makes spring operated hanging screens in two styles and a broad range of sizes. For portable equipment the Da-Lite Challenger is "tops." It requires no table or stand but has its own tripod and can be set up anywhere. Other portable models include the handsome box type Model D and the economical Junior Model ranging in price from \$2.00. All have the same quality craftsmanship that has distinguished Da-Lite Screens for more than 30 years. See these screens at your dealer's. Write for illustrated literature.

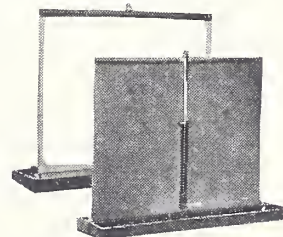

DA-LITE MODEL D houses the Glass-Beaded Screen in a streamlined leatherette covered box. Ten sizes from 22" x 30" to 72" x 96" from \$14.00* up.

The DA-LITE SCREEN CO., INC.
Dept. 2HM, 2723 North Crawford, Chicago, Ill.

*Prices Slightly Higher on Pacific Coast

DA-LITE SCREENS AND MOVIE ACCESSORIES

THE MOVIE



PANCHRO SUPER REVERSAL has these qualities—1: Brilliance—because the contrast developed renders each tone distinctly. 2: Naturalness—because of its high color sensitivity which renders colored objects in their proper monochromatic tones. 3: Large Projection—due to the fine-graininess of the film. Detail is sharp and pleasing. 4: Simplicity in use—for its speed is proper for shooting either under artificial light or outdoors on dull winter days.

Panchro Super Reversal Film is the logical film for your camera. Its superior performance will demonstrate to you why leading movie makers all over the world prefer to use Gevaert movie films.

Prices in Canada Slightly Higher

The GEVAERT COMPANY of AMERICA Inc

423 West 55th Street, New York

Philadelphia • Boston • Chicago • Los Angeles • San Francisco

In Canada: GEVAERT (CANADA) LIMITED • Toronto • Montreal • Winnipeg

THE FILM



SIZES AND LIST PRICES

Daylight loading rolls, 16 mm. 50 ft., \$3.25; 100 ft., \$6.00. Double 8 mm. these films are 25 ft. long, 16 mm. wide and prescored, enabling the user to separate into two 8 mm. lengths. 25 ft., \$2.25, 9.5 mm. Laboratory packed in containers each holding 3 thirty-foot lengths. \$3.30 per container tin.

Gevaert processing laboratories are located all over the world. This service is speedy and efficient. Rolls of 400 ft. received for processing are returned spliced on a 400 ft. roll ready for projection. Price of film includes processing service—and films are returned postage prepaid. If your dealer does not supply you write to:

Two Valuable Books Now Available ABSOLUTELY FREE

1. Our Twentieth Anniversary Catalog of Rental Films, listing:

16mm TALKING PICTURES
16mm SILENT PICTURES
8mm PICTURES

2. Catalog of Religious Films:

16mm TALKING AND SILENT

Our Gigantic Library Contains Over 4000 Motion Picture Subjects—We Have Suitable Films for Every Occasion—Get These Catalogs Today

IDEAL PICTURES CORP.

28 East Eighth Street
Chicago, Illinois

IDEAL PICTURES CORP.

2402 West Seventh Street
Los Angeles, California

The Reader



SPEAKS

Speedy Developer

The following item is of interest to those amateur cinebugs who process their own films.

Sirs: In "doing my own" I've tried many developing formulas; but I've found that Eastman's D. K. 60-A developer gives me additional speed in my faster films, particularly with the DuPont No. 314 emulsion. When using this developer, film speed is increased from one to one and one-half stops. I use it in both the first and second development. I have not tried it with any other negative stock or in the reversal process; but it undoubtedly would do the same for other negative emulsions. Also, it seems to give me a bit more contrast.

— D. R. Dixon

Swappers

Following are additional film-swapping requests and opportunities. Amateurs are delighted with this special HOME MOVIES' service, which is open to all readers. When sending in your requests be sure to mention whether 8mm or 16mm film is desired.

Gentlemen: I would like to get in touch with some 8mm fan living in Florida who has some surplus shots in 8mm Kodachrome of Miami Beach, Coral Gables, The Venetian Pools, The Keys, etc. I need about 50 feet to complete my Florida films.—G. P. Kreutzer, 1723 State St., New Albany, Ind.

Dear Sirs: I would like to swap 8mm film taken here in Akron, Ohio—"The Rubber City"—for equal footage made in any other state. I am interested in scenes taken in Florida and would prefer these, although scenes made in other states will be acceptable.—

Fred A. Hager, 1241 Girard St., Akron, Ohio.

The Editors: I'd like to obtain about 150 to 200 feet of 16mm Kodachrome movies of Hollywood high spots, plus a few shots of some of the movie stars. My home is in the beautiful Black Hills—the "Switzerland" of America. I can supply in exchange shots of Mt. Rushmore, the Needles, and of buffalo herds.—Maurice Francis, Box 404, Rapid City, South Dakota.

Sirs: I would like to contact an 8mm movie maker residing in Chicago, preferably Austin or the West Side, who would like to swap scenes of Los Angeles, Hollywood and vicinity for those I need.—T. H. Totten, 407 East Ave. 28, Los Angeles, Calif.

Dear Sirs: I would like to trade 25 feet of 8mm Kodachrome scenes made in Pennsylvania for an equal amount of 8mm Kodachrome footage of scenes made in Muir Woods, California.—G. Edward Fisher.

A Needed Service

The following suggestion is a timely one and worthy of the consideration of cine film processors throughout the country.

Editor: Why doesn't some one offer us amateurs a

• Continued on Page 94.

Frost On Lens

• When filming out of doors in severe cold weather, do not start shooting immediately after bringing camera out of doors from a warm room or on automobile, otherwise frost or fog will immediately form on the lens, just as it does on spectacle lenses. Allow time for the camera lens to become cold so that fog will not form on it and spoil your shots.

— C. R. Corlson, O. D.

INVARIABLY THE CHOICE OF THE PHOTOGRAPHER WHO KNOWS

BOLEX CAMERAS • BOLEX PROJECTORS • CINEA EDIQUIPMENT • AND BOOL FADERS

FOR CRITICAL

Amateur Movie Makers



BOLEX CAMERAS—The double-8 and 16mm models embody the custom-built, precise mechanical, and exclusive features which have made BOLEX famous. Only the BOLEX has automatic threading with loops formed mechanically...lateral spring tension in gate...clutch for forward or reverse filming by hand crank...focal-plane type, 90° rotary disc shutter...semi-circular, 3-lens turret with clear field for use of wide-angle lens...tri-focal, parallax-correcting optical viewfinder...single-frame mechanism and time exposure. BOLEX also has practically every other good feature—but ask

Bolex
pailard
THE WORLD'S FINEST

the man who knows—he'll tell you it's cheaper to get a BOLEX at the start—so see a BOLEX before you buy. MODEL SIXTEEN—with Meyer 1" F/1.5 lens \$275—with Leitz 27mm F/1.4 lens \$295. MODEL DOUBLE-EIGHT (8mm)—with Meyer 12.5mm F/1.5 lens \$275.

COMBINATION 8 and 16mm PROJECTOR—BOLEX offers the only "two-in-one" projector sold in America today. It projects both 8mm and 16mm film. Like BOLEX cameras, it is precision-built to give the finest performance at all times. MODEL G-816 \$235.

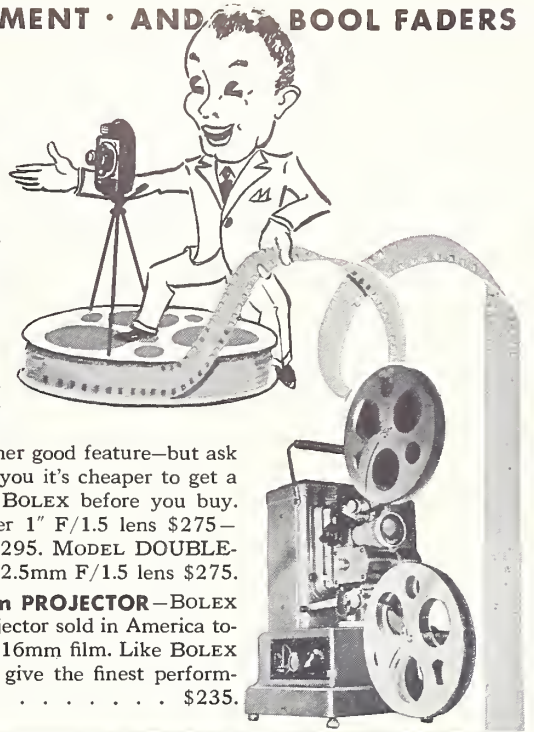

LOOKS LIKE A MILLION—WORKS LIKE A CHARM
NOTHING ELSE LIKE IT! Handles
both 8 and 16mm film equally well

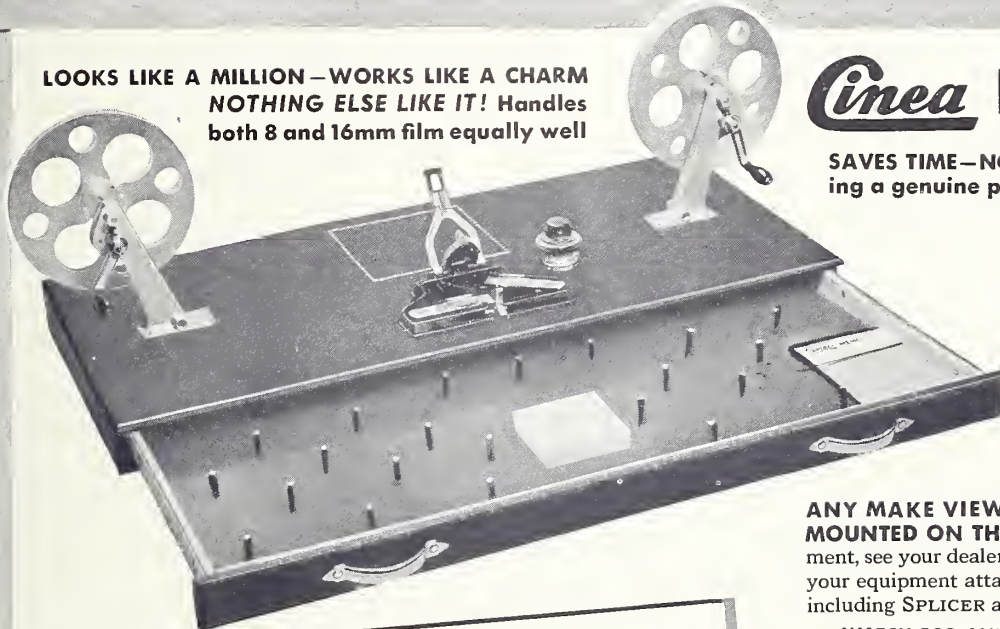

Cinea EDICABINET

SAVES TIME—NO FUSS—NO MUSS! Makes film editing a genuine pleasure. The new CINEA EDICABINET is beautifully designed for complete utility. The Temperprest Masonite top is hard, will not scar, and cleans easily. The frame is made of kiln-dried hard wood. And most important—the never-stick drawer is heavy porcelain enamel . . . numbered pegs for filing clipped film scenes and sequences . . . a tray to catch film ends that fall from splicer above. Finished in black, red, and chrome (30x14x2"). Complete with CINEA 30 SPLICER and CINEA-WINDERS . \$33.75

ANY MAKE VIEWER, SPLICER, OR REWIND CAN BE MOUNTED ON THE EDICABINET. If you now have equipment, see your dealer—the cabinet itself may be purchased and your equipment attached. The EDICABINET complete, but not including SPLICER and WINDERS \$14.75

WATCH FOR ANNOUNCEMENT OF NEW CINEA-VIEWER

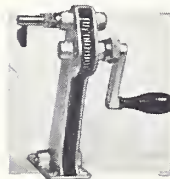

CINEA-WINDERS—The only rewind that has adjustable drag—prevents backlashing—leaves one hand free. Fine-cut gears and large, easy-grip wooden handle make operation smooth and quiet. WINDERS take both 8 and 16mm reels up to 800-foot. (Auxiliary bases available.) Per pair . . \$9.00

CINEA 30 SPLICER—Precise design assures greatest speed of operation with absolute accuracy. Handles both 8mm and 16mm sound and silent film without any changes necessary. It's a joy to make splices with the efficient CINEA 30 for they are neat and when properly made—stronger than the film itself . . \$10.00



THE HANDY Boole CINÉ-FADER

FITS MOST EVERY CAMERA
EVERY AMATEUR MOVIE PRODUCER NEEDS ONE OF THESE MIRACULOUS DEVICES

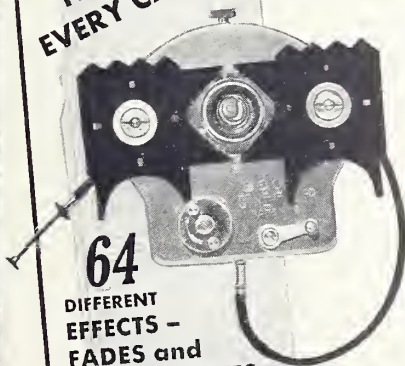

64 DIFFERENT EFFECTS — FADES and LAP-DISSOLVES

Pep up your personal movies—make them more interesting with novel scene and title transitions. They add to the easy flow and story value of any film. Fades and lap-dissolves give a professional touch and can be made easily "as you go" with the tricky Boole. Fades are made by the two leaves of the device moving automatically either to open or to close the aperture in front of camera lens. Duration of fade is timed by clock-work mechanism. The FADER can be controlled without removing the eye from the viewfinder. Fades can be made with soft or sharp edges.

Boole also acts as filter or mask holder. Light weight (6 oz.) and always handy the Boole works equally well on the lens of a projector. Complete, with extension tube, cable release, and instructions \$17.50

AMERICAN BOLEX COMPANY • 155 EAST 44th ST. • NEW YORK

MAIL TODAY!

AMERICAN BOLEX CO., 155 EAST 44th ST., NEW YORK, N. Y.

Please send me, without obligation, illustrated literature and prices on the following equipment (checked) in which I am interested.

- Bolex Cameras
- Bolex Projectors
- Cinea Edicabinet
- Cinea 30 Splicer
- Cinea-Winders
- Boole Cine-Fader
- Cinelac Film Protector
- Send name of nearest dealer

NAME

ADDRESS

CITY

STATE

GOERZ

KINO-HYPAR LENSES

f:2.7 and f:3
High chromatic correction, for taking color movies of surprising quality...



Focal lengths 15mm to 100mm — can be fitted in suitable focusing mounts to Amateur and Professional Movie Cameras.

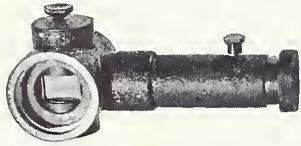

GOERZ Reflex FOCUSER

— Patented —

A BOON to 16mm Movie Camera users—eliminates PARALLAX between finder and lens—provides full-size ground-glass image magnified 10 times. Adaptable to lenses 3" and up. Also useful as extension tube for shorter focus lenses for close-ups. Extensively used in shooting surgical operations, small animal life, etc.

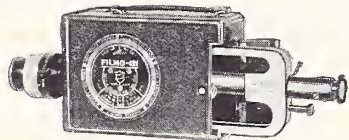

GOERZ Parallax-Free FOCUSER and FIELD FINDER CONTROL

for the same purpose, for Filmo 121 and Simplex-Pockette, magnifies 4 and 8x.

For Detailed Information Address
Dept. HM-2

C. P. Goerz American Optical Co.
317 East 34th St., New York

American Lens Makers Since 1899

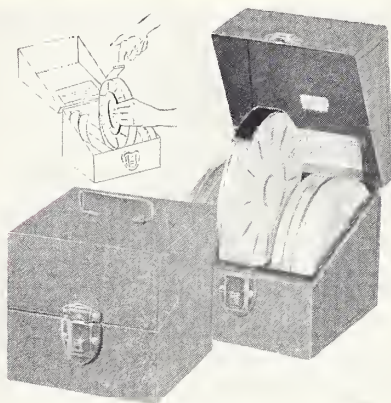

Give your films this "BETTER PROTECTION"

Compro Film Storage Cases give your films the "perfect protection" they deserve. Well-constructed and sturdy, they provide an ideal condition of humidity—a practical means for keeping your films in proper order—and only in Compro Storage Cases do you find the

Exclusive Pick-A-Reel FILM SELECTOR

Individual dividers are provided to form separate compartments for each reel. Each compartment is fitted with a cradle arm, facilitating the insertion or removal of reels when the case is filled. For 8 and 16mm reels, 6 and 12 reel capacity.

FREE CATALOG

Just off the press. Loaded with fine values in modern lighting equipment—filters—sunshades and supplies for both still and movie work. Write today.

COMMERCIAL
METAL PRODUCTS COMPANY
2251 W. St. Paul Ave. Chicago, Ill.

BACKYARD MOVIES

Ideas for Random Filming

"Surprise" Idea

Here is an idea for a Backyard Movie which I recently filmed. The scene opens with a man sitting in a chair, studying two snapshots. He looks first at one, then the other, scratches his head, indicating indecision. Suddenly he gets an idea. A title follows, "Ah, I have it!" He gets up and walks out of scene. Returns in a moment with pen and ink and proceeds to write a letter. The letter is shown by filming it in a "scroll" titler:

Dear Mrs. Post:

I'm in a pickle! Enclosed are pictures of myself and a couple of "nifties." I can't sleep nights figuring which one I like best.

Very truly yours,

Joe Doakes.

After signing the letter, he picks up the two snapshots which he is about to enclose with it, and the snapshots are shown individually in close-ups. These can be of the man with a girl at the beach, a picnic, picking flowers, etc. Then the other—with a different girl, playing tennis, handball, etc.

We cut back to the man, showing him placing the photos in the letter and sealing it. He pauses a moment, thinks—tapping the letter on hand—and appears to have thought of something else to add to letter. He decides to open it. Taking out the letter, he proceeds to write the following, a close-up of which should also be photographed with your titler:

"P. S.—My wife took pictures."

Fade out.—The end.

—Edith Thompson.

Family Filming Skit

The following is a shooting script suitable for filming on 100 feet of 16mm film or 50 feet of 8mm film. The cast of three people may be selected from among

members of the family. I have filmed this story myself, and my friends attest to its entertainment value.

Main title: "OFF AGAIN—HOME AGAIN."

Scene 1. Closeup of alarm clock, showing time—7:15.

Scene 2. Wife rouses husband from bed. The husband leisurely stretches and yawns, then jumps out of bed, dressed in his pajamas.

Scene 3. Closeup of alarm clock, showing time—7:20.

Scene 4. View of husband partly dressed and hurriedly shaving.

Scene 5. Closeup of alarm clock, showing time—7:30.

Scene 6. View of wife rocking baby in rocking chair, when husband walks in, just putting on his coat, and expostulating, presumably, because of his haste to get to work. He speaks:

Title: "You Cook and I'll Rock."

Scene 7. Wife rises and transfers baby to husband's arms, who takes her place in rocking chair and proceeds to rock baby.

Scene 8. Closeup of alarm clock showing time—7:40.

Scene 9. Wife preparing breakfast and placing various articles on breakfast table.

Scene 10. View of family eating breakfast very hurriedly, with wife assisting husband as much as possible and urging him to hurry. Her lips move to make the following statement:

Title: "Hurry, Dear, or You Will Be Late for Work."

Scene 11. Closeup of alarm clock showing time—7:50.

Scene 12. Husband appears wearing wife's hat by mistake and hurriedly grabs his wife to kiss her goodbye.

Wife laughingly points to his head. Exasperated, he snatches hat from head and

• Continued on page 96.



with the G-E METER



YOU'VE a new treat in store when you show your first movies made with the help of the G-E exposure meter. Their uniform, correct exposure will give a screen brilliance and clarity that will be more pleasing scene by scene. And friends, too, will enjoy your shows more when your movies are correctly exposed.

Here's one reason why the G-E exposure meter gives you correct exposure. The hood excludes stray light, admits only the light from the scene. Check this feature by noting the sharp cutoff—indicated by the needle movement—as you turn the meter from dim to bright light. This effectively narrow viewing angle of the G-E meter is particularly important in motion-picture work.

Your dealer will be glad to explain the many other features of the G-E exposure meter. Why not stop today and let him show you this valuable aid to better movies. Or mail the coupon for descriptive literature. General Electric, Schenectady, New York.

GENERAL ELECTRIC

General Electric Co.
Section 430-136K4, Schenectady, N.Y.

Please send me a copy of Bulletin GED-678A entitled "How to Use the General Electric Exposure Meter."

Name

Address

City.....State.....

430-136K

Why This Sound Projector Is *Leading the Field*

Check these AMPRO features!

NEW sound loop synchronizer — Permits perfect synchronization of picture and sound by the exact forming of sound loop. Guesswork is eliminated. Re-setting of sound loop accomplished without stopping projector when loop is lost through faulty film and without damage to the film.

EXTREME quietness of operation — Runs so silently that no "blimp" or covering case is required.

EASE of operation — All operating controls centralized on one illuminated panel.

MAXIMUM film protection — A triple claw is used for moving film, engaging three sprocket holes simultaneously. Film with two adjacent torn holes can be successfully used. Ampro patented "kick-back" movement lifts the claws from the sprocket holes, before withdrawing, eliminating film wear. Take-up compensator prevents starting strain.

IMPROVED sound optical system — The light from the exciter lamp is projected directly and optically onto the photo cell without the losses or distortions normally encountered when mirror, prism, or mechanical slit is used.

IMPROVED light optical system — In perfect alignment at all times, pre-set by the factory. Projection lamp base adjustable so that filament can be moved manually into perfect alignment with optical system. The Reflector and Condenser lenses are mounted on front cover for quick cleaning without the necessity of using tools.

1000 WATT illumination provided — AMPRO SOUND Models "X" and "Y" are approved by the Underwriters' Laboratories for 1000 watt lamps. A 750 watt lamp is normally furnished as standard equipment but can be interchanged with 1000 watt lamps.

PERMANENTLY attached reel arms — For quick set-up — Reel arms are permanently attached; merely swivel into position for instant use. Accompanying belts, always attached, swing directly into position.

SMOOTH sound — Entirely free from waver and distortion due to its finely balanced flywheel, mounted on airplane type grease sealed ball bearings, and Ampro's patented film guides. Curved film guides placed before and after the sound drum and sound sprocket prevent the film from flapping.

IMPROVED sound drum and filter — Mounted on precision ball bearings, the rotating type of sound drum avoids sliding action between the drum and film — prolongs film life and maintains high quality sound. Curved film guides before and after sound drum eliminates weaving and "belt action."

SIMPLIFIED threading — Same as threading silent projector, with exception that film also loops around sound drum, eliminating looping film over a third sprocket. Film guides assure correct, easy threading.

FAST automatic rewind — 400 ft. reel rewinds in 35 seconds — 1600 ft. reel in 75 seconds without damage to the film. *No transferring of reels or belts.*

USES standard lamps — Standard prefocused lamps, up to 1000 watts. "Special" high priced lamps not required.

Schools and colleges all over the country are ordering and re-ordering the new AMPRO SOUNDS in ever increasing numbers. Behind this amazing success of the new Ampro Sound Models "X" and "Y" lies a story of numerous superior features that have set new standards of performance for 16 mm. sound-on-film projection.

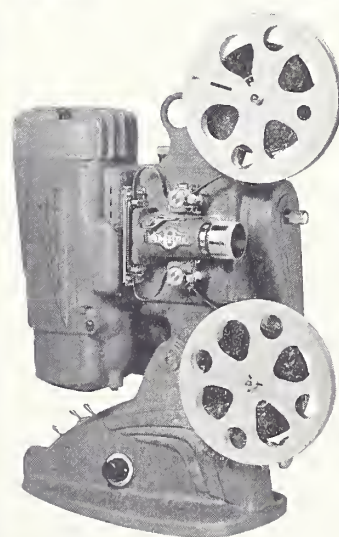
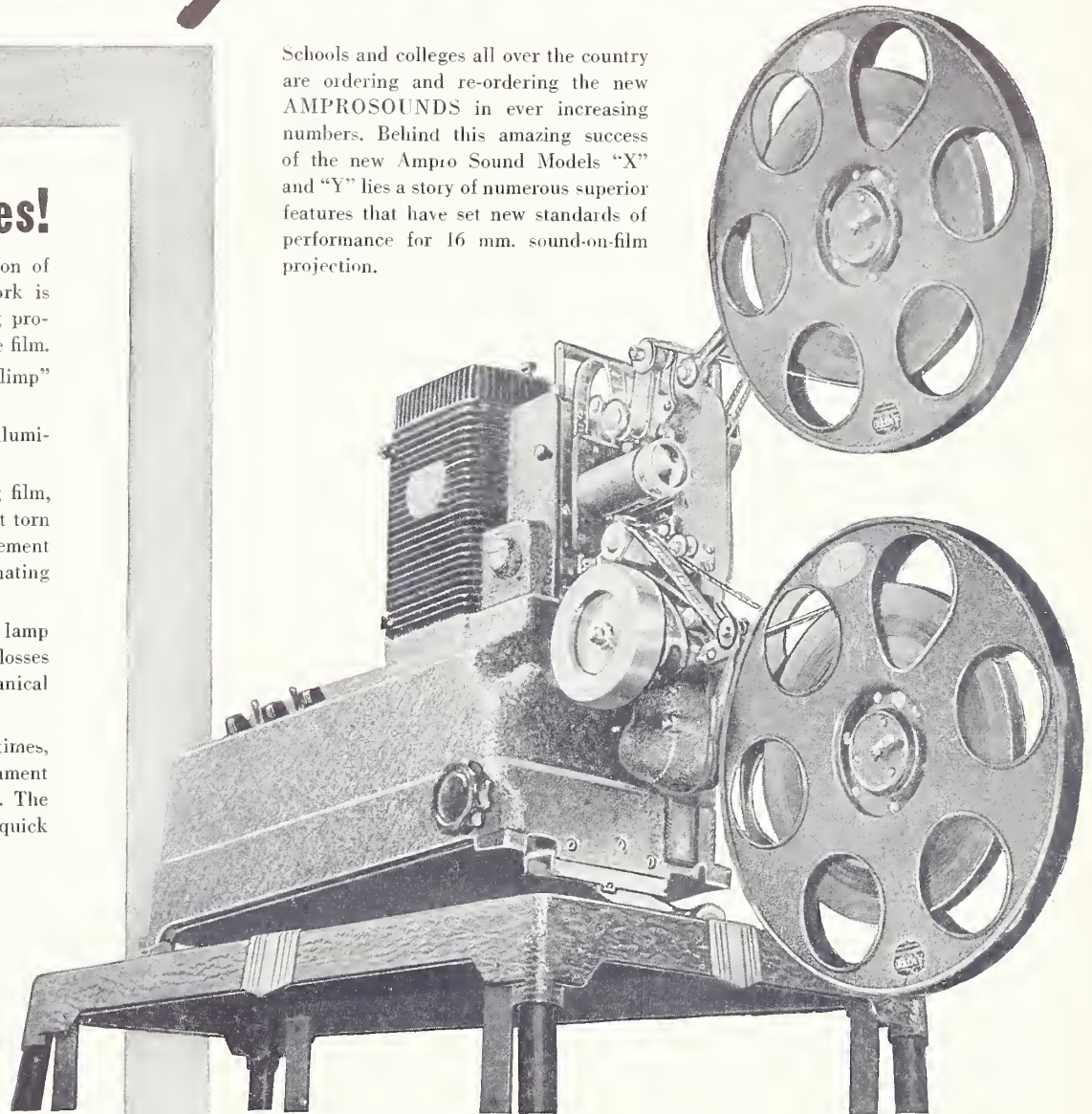

NOW Ampro 16mm. quality in an 8mm. Projector

Still picture lever, automatic safety shutter, reverse picture operation, fast automatic rewind, full 400 ft. reel capacity if desired, 500 watt illumination, automatic fire shutter, automatic reel-locking device, micrometric tilting knob, automatic pilot light, centralized controls, complete range of film speeds, easy threading, quiet operation; has 1 in. F 1.6 objective lens. Optical system corrected for color films. Operates on both AC or DC 100-125 volts. Priced at \$98.00 complete. The latest Ampro catalog will give you full details on this remarkable new 8 mm. projector and the full story on the complete line of Ampro "precision" 16 mm. silent and sound projectors **\$98⁰⁰**

AMPRO

PRECISION CINE EQUIPMENT
2839 N. WESTERN AVENUE
CHICAGO, ILLINOIS

Please send me the new 1940 Ampro Catalog. I am particularly interested in:

- New Amprosound Models "X" and "Y."
- New Ampro Public Address System.
- Ampro 16 mm. Silent and Convertible to Sound Projectors.

Name.....

Address.....

City.....State.....HM-240

• TITLE TROUBLES •

By GEORGE W. CUSHMAN

PROFESSIONAL OR AMATEUR
EDITING
 "MAKES" THE
 PICTURE
CRAIG
 ALWAYS SPECIFY FOR YOUR EDITING NEEDS
 MANUFACTURERS OF FINE EDITING EQUIPMENT SINCE 1929



CRAIG 16MM SENIOR SPLICER

Operates in the professional manner... only four easy operations needed to make perfect, straight splices—quickly, accurately, and without wetting the film.
 For Sound or Silent film . . . \$10.00
 New Junior Splicer—adaptable to 8 or 16mm film \$2.50



CRAIG PROJECTO-EDITOR

Action-edit your movies the Hollywood Studio way—transform random "shots" into interesting continuities that everyone will enjoy seeing. The Projecto-Editor provides a unique viewing method—allows careful inspection, slow motion if desired, of actual movement on its brilliant miniature screen. Complete with Splicer, Rewinds, and film cement, 8mm model. \$27.50
 16mm model. \$49.50

CRAIG SPLICER AND REWIND COMBINATION

A complete editing and repair outfit. Essential equipment for all cinematographers.
 8mm model with Junior Splicer and Rewinds \$7.25
 16mm model with Senior Splicer and Rewinds for sound or silent films \$19.50
 With extension bases for 1600-foot reels \$22.00

BUY WITH CONFIDENCE—USE WITH SATISFACTION
 AT ALL DEALERS

CRAIG MOVIE SUPPLY CO.

1053 S. OLIVE STREET LOS ANGELES, CALIF. 149 NEW MONTGOMERY ST. SAN FRANCISCO, CALIF.

If you have any questions concerning titles or title making, Mr. Cushman will be glad to help you. You can address him in care of this magazine or direct to his home address, 3425 Witmer Parkway, Des Moines, Iowa. Include all the information you can such as type of film used, illumination, developer, etc. Don't forget to enclose a self-addressed stamped envelope for your reply.

Q. In making several titles the other evening, I find a dark spot near the center of them for which I cannot account. Have been making positive titles for years, but this is the first time this has happened.—C. D. A., Troy, N. Y.

A. My guess is that somewhere near your titler was a third light, perhaps in the ceiling or lamp close by which was magnified by your auxiliary lens onto the title card, thus resulting in the dark spot you mention. This often happens, and for this reason it is best to turn out all the lights in the room except your floodlights when making titles. This explains why you never had this trouble before, and probably never will again.

Q. In trying a typewriter shot recently it was my intention to have the typewriter type out the letters as the camera made the exposure. However, the paper was so badly over-exposed that the letters could not be seen. But when I exposed less, the typewriter was under-exposed. I've seen such shots, so know it is possible. How is it done?—Dr. D. F. M., Ashland, Kan.

A. Besides placing your lights more carefully, so that the concentration falls on the typewriter instead of

the paper, I would suggest you use colored paper in the typewriter, either blue or yellow, and more important than either of these, a new, heavily inked, black ribbon. But the colored paper, I am sure, will end that glare.

Q. I have noticed several of the professional films using black letters on a white background, yet in many of your articles you state that white letters on a dark background are the only thing. Are the professionals wrong?—W. W. C., Battle Creek, Mich.

A. The professionals are not wrong, neither are dark backgrounds. Either are a matter of opinion. What you think are white backgrounds are in reality gray backgrounds. Also, there are main title sequences, and they fade in and out. For this reason they are not jumpy on the eyes. You misunderstand me when you think I do not like light backgrounds and dark letters, for that is not true. They are fine for lead and end titles, where they fade in gradually, but I would never use them for sub-titles, and neither should you. The sudden jump between average scene and title with white background is too hard on the eyes. But try it if you are skeptical.

Q. In making fades with my Cine Special and using positive film, I notice the fades aren't smooth. Instead, the letters seem to disappear with a jerk. I am trying for a two-second fade and am careful to close the shutter very evenly. What am I doing wrong?

A. Although you did not say in your letter, I suppose you are completing the fade by lap dissolving with a

• Continued on page 98.

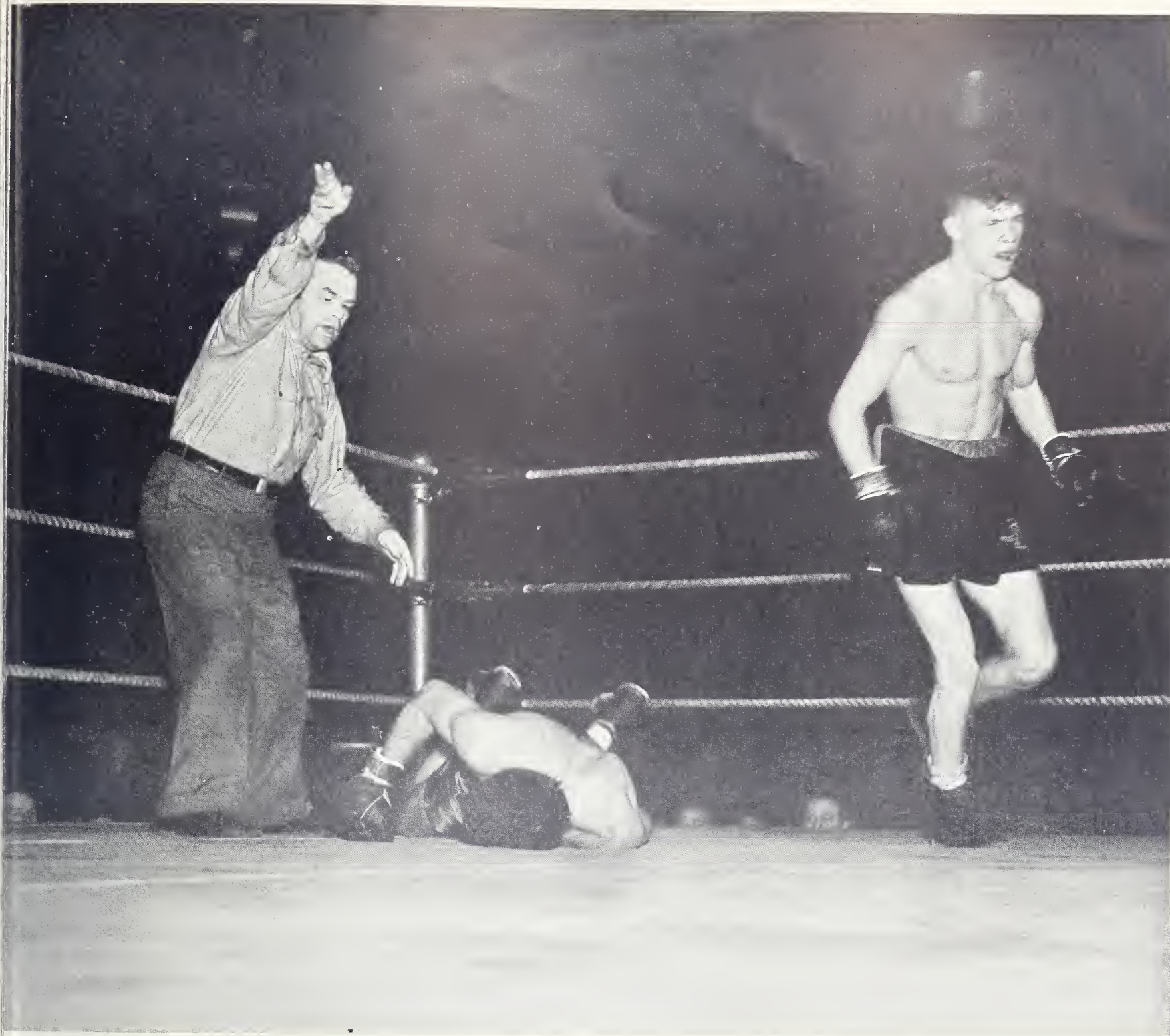

A Question of Exposure

THE gentleman on the floor made the obvious mistake of leaving his chin exposed too long. His only recollection of the fight will be a whoozy blur.

On the other hand, the man who took this picture will have an uncommonly vivid document of the entire proceedings.

For indoor movies, for slow-motion pictures under poor light conditions, you can use no more satisfactory film than Agfa 16 mm. Triple S Superpan Reversible Film. It is extremely fast, fine-grained, and fully sensitive to all

colors. Your projected pictures are exceptionally deep and clear, showing the minutest details.

Ask your dealer for Agfa 16 mm. Triple S Superpan Reversible Film today. It

comes in 100-foot rolls (at \$6.00) and 50-foot rolls (at \$3.25). These prices include processing and return postage.

Made in U.S.A. by Agfa Ansco, Binghamton, New York.

Agfa

16 mm. TRIPLE S SUPERPAN FILM



BONERS *to avoid in shooting home movies*

EDDIE COLLINS, top-flight screen comedian of 20th Century-Fox Pictures and an ardent home movie maker, demonstrates here with his Revere camera especially for HOME MOVIES, some of the most common mistakes of the beginning amateur filmer. Eddie admits making these mistakes himself the first time he used a movie camera — a statement hard to believe were you to see some of the swell home movies he has made.



It may be easier to load your camera in bright sunlight, but what a lot of light-struck film will result! Camera should always be loaded in subdued light — indoors or in the shade.



Eddie demonstrates the "Goodyear Filter" shot — made with the little rubber cap on the lens! Don't try it unless you want perfectly blank film. Cap lens only when storing camera after use.



If you want pictures that will appear as though taken during an earthquake, then shoot 'em while walking! Otherwise, never walk while shooting. Silly? You bet. But it's done every day!



"Spraying" the scenery with your camera is no way to make panorama shots. Besides, the stress from twisting one's figure stiffens the joints! If you must pan — do it slowly.



Fingers have a way of straying before the lens during filming our most important shots, obliterating part, if not all, of the scene. Keep hands well toward back of camera — always.

HOME MOVIES

... Published in Hollywood

FEBRUARY

1940

Authored by
EDDIE COLLINS

When a beginner I MADE MISTAKES too . . . !

WE ALL make mistakes! Yes—as we wise-cracked in the old days of vaudeville—“That’s why they put erasers on lead pencils!” But making mistakes in shooting home movies is often downright carelessness. When I first got my movie camera, I was so eager to start shooting pictures, I loaded my new camera with film right away—and out in bright sunlight, too!—then started shooting! I shot anything and everything; upwards, downwards—yes, even while I walked. You see, I hadn’t bothered to read the little instruction book that came with my camera, and unfortunately, I had not yet discovered HOME MOVIES magazine.

Well, when the postman brought my first roll of film back from the processors, he found me waiting for it at the door. In fact, I had been watching the mail box pretty close’y every day since sending the film away—waiting for it to come back so I could screen it. After unraveling about 15 feet and finding nothing but clear, blank celluloid, I suddenly remembered something that one of the boys at the studio had said about the time he shot a roll of film without removing his lens-cap. Then I recalled that Mrs. Collins had called attention to the cap on my camera lens—after I had already made several shots. Yes—this nice, crystal-clear strip of film was it. My “Goodyear filter” shots!

I continued to unroll the spool of film. Soon I found pictures—nice ones, too—except that some of the scenes seemed to have large dark areas, as though part of the scene had been masked off. I found out later that dark spot was the shadow of one of my fingertips which inadvertently had strayed before the lens while I was shooting. Now I hold my camera with hands gripping it as far toward the back as possible, and I haven’t made this mistake since.

There was another fault which showed up at intervals—periodical flashes of light on each frame. As my film was projected on the screen, flashes—like heat-lightning—would appear. I thought perhaps I had forgotten to close my camera case tightly or that my camera leaked light. I examined the camera carefully and it appeared to be O. K. So I blamed the laboratory. The next

day I related my troubles to Art Miller, cameraman on our picture at Fox Studios. After listening to my story, he advised me to load my camera indoors or at least out of bright sunlight in the future. I needn’t tell you, of course, that this remedied the trouble. Later, in thumbing through the instruction book, sure enough—that same precaution was printed in bold letters!

Is there a beginner who has never shot movies while walking? I hardly think so. I am one of them. You should see the swell “earthquake” effects I got in some of my first shots. I know now—and I guess you do, too—that successful “follow” shots can only be made with the camera securely mounted on a camera dolly, truck, camera-crane, or an automobile.

Next to shooting while “strolling,” perhaps my biggest mistake was panning my camera too much or too fast. When I wasn’t moving my camera much the same as a painter would handle a spray-gun, I would stand in one position, camera trained on some particularly lovely vista; and with one

• Continued on Page 89.

• Dismayed, but not downhearted, Eddie Collins examines his first roll of film, just returned from the processors. The errors made on this initial roll served as a guide for his later home movie making efforts.



Reported by
THE EDITORS

AMATEUR MOVIES “click” in Theaters . . !

• A high-intensity 16mm arc-projector set up in the theater's projection booth screens 16mm movies full size at the Regina Theater in Beverly Hills, Calif. Harry Umann reads the commentary.

ALL 16mm cinefilmmakers and hobbyists are cordially invited to join with us in dancing in the street, and in shouting huzzahs and hoorays to the housetops —

Such fiesta and frolicking would, indeed, be fitting celebration of the fact that one of the newest and largest motion picture theaters in Beverly

Hills, Calif., has inaugurated a policy of showing advanced and outstanding 16mm amateur film productions as a featured part of its regular weekly programs.

But there is still another reason for rejoicing, particularly on the part of 16mm amateurs who are readers of HOME MOVIES, and who strive throughout the year to win the honor of producing the “Movie of the Month.” Winners of this coveted accolade each month will be accorded the prideful opportunity of having their efforts—whether documentary or homespun drama or comedy—presented at this Beverly Hills theater, as the result of a special arrangement made by HOME MOVIES magazine with the management of the theater.

The Regina Theater, on swank Wilshire Boulevard, and right in the heart of the habitat of Hollywood's most famous personalities, is the theater which has given this recognition to the 16mm amateur.

Manager Hilbert Smith put his 16mm presentation policy into effect on January 1 of this year. First offering was a 250-foot all-color documentary, showing the famous Tournament of Roses Parade at Pasadena, Calif., on New Year's Day. For two weeks—one of these by popular request of Beverly Hills movie-goers—this Rose Parade documentary was shown!

This 16mm attraction was given as careful and successful presentation on the screen as would have been accorded any 35mm super feature from the Hollywood studios.

By means of a high-intensity 16mm arc projector, the 100 feet from the theater's projection booth to its screen was bridged beautifully. Shown on the full size professional screen, with none of its pictorial or color values reduced, it is safe to

• Continued on page 91.

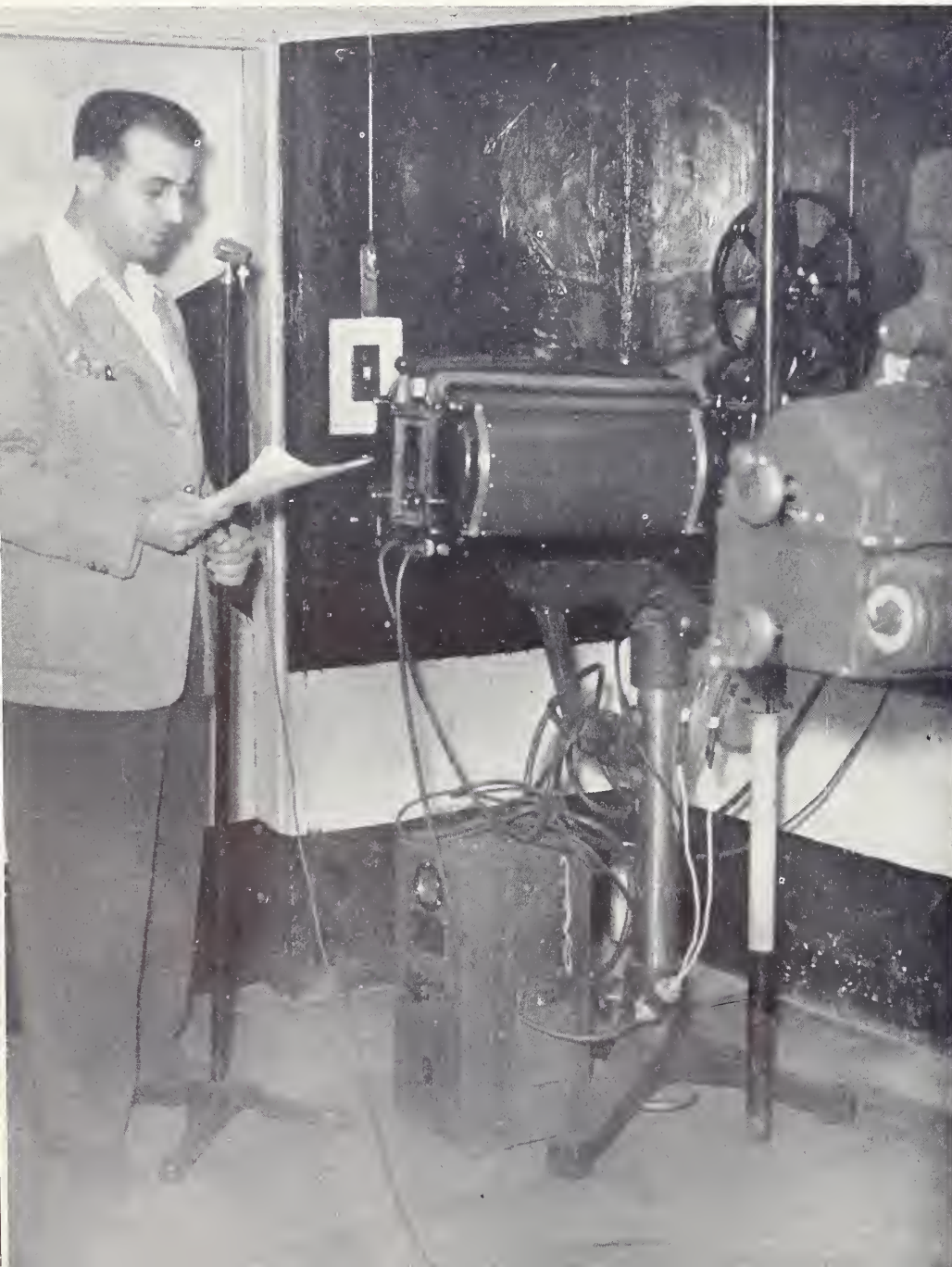

NIGHT SNOW SCENES

(right)

are easily filmed out of doors. The snow reflects and spreads the light, making for brilliance and clarity of detail in the scene. Note fine texture of snow in this picture.

Photo courtesy Union Pacific



Authored by

CHAS. W. HERBERT, A. S. C.

DAYLIGHT *can look bright, yet be weak . . .*

DAYLIGHT can be too bright or too hazy. It can look bright to the eye, yet actually be weak in its action on the film. Light can appear weak and still be packed with actinic rays. Exposure meters are a great aid in these instances but not a foolproof solution.

There are sections of the country which have a reputation for being difficult to work in, and old-timers will tell you to watch out because the light is tricky. Key West, Florida, is surrounded by this bugaboo—so are the plains of Kansas, Alaska and Death Valley. It is true problems do exist in these taboo locations but they can be overcome. Generally speaking, it is inadvisable to accept the advice of the local photographer in such a region. Often he is inclined to over-emphasize the difficulties and he might succeed in discouraging you.

Down in Key West, the sun rides high; there is sea all around; vacant lots are merely glaring patches of coral rock; buildings are light colored and there is a scarcity of green grass and trees.

• "You'll find it wise to make most of your closeups from a low angle, so that you will have blue sky for a backdrop."

Ross Madden Photo



Avoid mid-day shots, particularly of people, because the vertical light casts deep shadows. It is best to work in the early morning and late afternoon and well worth the effort of searching for locations that have some green foliage.

When making street scenes where one side is in bright sunlight and the other in deep shadow, use the graduated filter. Set it in position vertically so that the dense area covers the bright side of the street, and the thin area covers the shaded side. When your set-ups are such that you cannot avoid glaring coral rock formations in the foreground and around your subject, you will need the neutral density filter to soften this harshness. However, if your scene includes blue sky, you will want to darken the sky by using the 23A filter at the same time.

For the best pictorial effects, try to confine your shooting to early morning and later afternoon, so that you will have pleasant shadows. Generally speaking, you will be able to work much earlier and much later in Key West than in many other sections.

Most parts of Alaska visited by the tourist, especially near the coast, are perpetually enveloped in a thin fog. At first thought it seems that this would decrease the value of the light. On the contrary, the kick-back of the light of the sun's rays striking these myriad, microscopic particles of moisture intensifies it. You will find that Aero Filters No. 1 and No. 2 are best suited to overcome this condition.

• Continued on page 88.

SNOW DRAPED SCENES

(right)

offer grand picture possibilities! The secret of successful snow pictures is in getting fine tone gradation and texture, as in the picture at the right. Use this photo for your winter picture title background.

Photo courtesy Union Pacific



Reported by
J. H. SCHOEN

"WHISTLING WINGS" *Movie of the Month . .*

"WHISTLING WINGS" is so entrancing, you at once forget you are viewing a motion picture. And when a home movie does that, there can be no doubt about the wisdom of HOME MOVIES' editors in acclaiming it the Movie of the Month.

Skillfully filmed by W. H. Nordin of Austin, Minn., "Whistling Wings" is notable for its beautiful color, striking titles, and exceptional editing. It is a pictorial saga of a duck hunt which, if screened before any group of avid duck hunters, would cause the correspondence of the Minnesota State Chamber of Commerce to swell perceptibly overnight. For this picture presents the sport in a most intriguing and picturesque setting—presumably somewhere in Minnesota.

The picture opens with a prelude of "theme" scenes of wild ducks in flight before the main title appears. And this is indeed a work of art. The words "Whistling Wings" are superimposed over an artistic color shot of the lake filmed through the reeds. The reproduction on this page scarcely does it justice.

Next we see some fine shots of ducks in flight, and although from an editor's viewpoint this sequence is a little too long, it can be appreciated

that a dyed-in-the-wool duck hunter-cinefilmer could hardly be persuaded to delete any of it even for the sake of cinematic art.

Then follows a closeup of a man seated comfortably in his club chair scanning a sportsman's magazine profusely illustrated with pictures of wild ducks. This man decides to call his pal and arrange for a duck hunt. There follows shots of the two men on the telephone in which they complete their plans. These conversational scenes are still somewhat lengthy in spite of the fact that Nordin wisely intercut shots of wild ducks in flight between them.

Another nicely worded and photographed title introduces the next sequence which shows the men starting out on the trip with their guns and dog, and dressed in the full regalia of top-flight duckshooters. We see them place their decoys on the lake and then, paddling their duckboat, retreat to the blind to await their quarry. There, hidden by a mat prepared of woven reeds, they wait patiently with guns ready, occasionally scanning the sky or blowing the duck-call.

Whether premeditated or not, Nordin's filming

• *Continued on page 91.*

• Pictured below are enlargements from W. H. Nordin's sparkling 16mm color film, "Whistling Wings." Equally clever as its title is the manner in which this picture was filmed, edited, and titled.

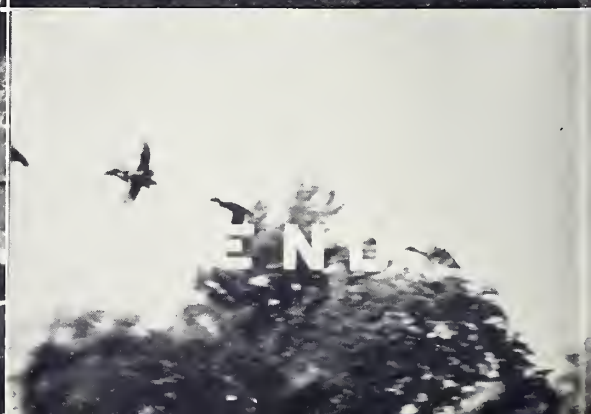

Six things a movie needs to give it "OOMPH"

1 CORRECT EXPOSURE

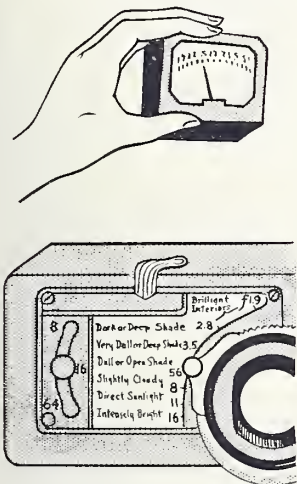

What the camera sees with its lens, it records on the film. If the scene is bright, it will be over-exposed; or if it is dark, it may hardly register on the film at all **unless** correct exposure is determined and the lens diaphragm adjusted accordingly. Correct exposure may be insured by consistent use of a reliable exposure meter. However, almost every modern cine camera is equipped with an exposure chart which may be relied upon for filming out-of-doors under all lighting conditions.

2 SHARP FOCUS

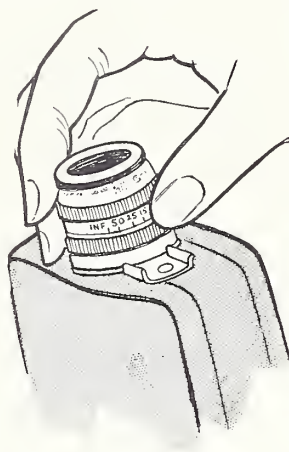

Cine camera lenses are either fixed-focus or in focusing mount. With the former, the lens is always in focus on objects from a few feet distant to infinity. Lenses in focusing mount must be adjusted—**focused**—for each shot. This is done merely by turning the lens barrel which moves the lens nearer or farther away from the film. Usually this type of lens provides for filming objects as close as two feet. Needle-sharp focus is essential to good movie making. It pays to "double check" this important factor before shooting each time.

3 CAREFUL FRAMING

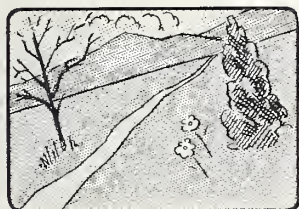

Careless framing often spoils a great many otherwise excellently composed shots. In lining up our scene in the viewfinder, we must watch the horizon line to make sure it is parallel with the top or bottom of the viewfinder. Next important is **composition** of the scene. Remember—what you see in your viewfinder we get on our film. In filming distant scenic vistas, try to get a bit of foliage in the foreground or a tree branch cutting into the scene at an angle in the foreground.

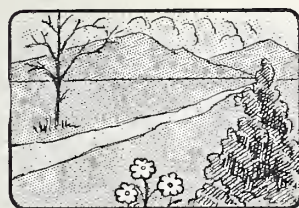

4 CONTINUITY

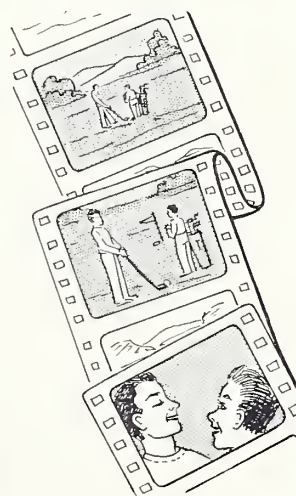

One shot alone does not make a movie. It requires sequences of long, medium, and close-up shots joined together in continuity. For example: We wish to make movies of our golfing friends. Let's make a long shot of them as they stand on the tee in the distance. Then we move in closer and make another—a medium shot—as one of them starts to tee off. Next, we move right up and make a close-up as they congratulate each other on their drives. This is continuity—cinematography planned in advance.

5 GOOD EDITING



Editing is simply the art of proper arrangement of scenes and titles to best convey the thought at hand. Every movie—if it is to be a **movie**—requires editing. Scenes must be trimmed to required length; badly exposed footage must be deleted; and of course there is the placement of scenes in proper order or cutting in of close-ups. Your story may be good and your photography above par, but it's your editing that really makes the picture.

6 TITLING

**World's
FAIR**

Main Title

•At the conclusion of the exposition, the Island will revert to the Government...

Sub-Title

It's been said before—no movie is really ever complete until it is titled. Titling consists of more than merely splicing on a main or the beginning title. It should be titled **throughout** in order to aid in telling the story and knitting closer the various scenes. If you can write a letter, you can compose your own titles—but keep them brief! Titles may be photographed by any cine camera. You can even develop the titling film yourself.



There are three general methods of applying light to a photographic subject: Flat or General Lighting, Streak or Model Lighting, and Spot or Effect Lighting.

Flat lighting is exactly what the name implies. An even flat distribution of light as applied in the intensity required, with a minimum of under-emphasized areas apparent from the camera position. Flat lighting is used in interiors, to light white backings, pictures of large area, etc. Form and depth, when required, must be painted or be present in the actual coloring of the backing itself, when this type of lighting is used. The types of lights in general use today for still photography (floods, flash bulbs, etc.) adapt themselves to this type of lighting.

Streak lighting is the most common of all types of lighting. It consists in lighting the subject, or set, with lights *from an angle*, and in such a manner that they may appear to be originating from a common source. This type of lighting begins to achieve a spirit of three-dimensionality—the goal of good photography. In still pictures, this

Hollywood's LIGHTING SECRETS are yours!

ORIGINALLY, lighting in photography concerned itself almost entirely with the simple idea of illumination. This term, illumination, is used advisedly, as opposed to the idea of lighting. This last term expresses the thought of modeling with actual masses of light. Modeling tends to effect an illusion of roundness and three-dimensionality. The idea that we must use an illusion to make a thing look real is somewhat foreign to logic. However, we must bear in mind that we have only a two-dimensional tool in the camera.

Flat general lighting persists to a very marked degree in common practice. This prevents the proper attention which should be given to details. Shadows are haphazard; in some cases double shadows from improper lighting destroy the value of a shot. Lighting technique causes the cameraman to become an artist instead of an artisan.

© The photos on these two pages, made during actual film production at Paramount Studios, illustrate the lighting set-ups used by the professionals. Note that bulk of lighting comes from overhead. Streak and special effect lighting is accomplished by "spots" placed about the sets. Amateurs can achieve professional lighting in their scenes by proper placement of lighting units.

feeling of perspective may at times be enhanced by retouching, stopping down the lens to an extreme point, and precise regulation of the development. In motion pictures, greater care must be exercised because retouching is impossible, the shutter speed of the camera is constant (one-fiftieth second approximately) and development must compromise for an entire series of individual pictures. Motion picture lighting with this technique becomes difficult because of lack of equipment. For amateur use, the type of equipment available in most cases does not adapt itself to intensity regulation, or to the control of light spilling around the edges of the lighting unit. This suggests the need for experiment with reflectors enclosed in a barrel of some kind, which will allow the globe itself to be moved along its length and change its focus with respect to the reflector.

Spot or effect lighting is especially good in ef-

Authored by
HOWARD SOUTHER

Photos courtesy Paramount Pictures Corp.

fecting the idea of light emanating from a wall fixture. It consists in lighting the object head-on with the circle of light from the spotlight, such as was described in the previous paragraph. The light, however, must be very soft, and the edges diffused considerably.

Everything, in order to be well built, must have a foundation. In lighting the scene, the background is the first consideration. It must be determined first whether the action is to be intense and fast, or of slow and even tempo. The mood must be considered. Is it comedy or drama? If the former, the lighting must be more brilliant. The general lighting of the set must be in a "high key." If it is drama, a subdued, suggestive type of light treatment termed "low key" lighting must be employed. The reason for this discrimination is twofold. In the fast action, accurate lighting is very difficult. The entire scene must be flooded in order that the actors do not at any time "go black" or go out of the spotlights set upon them so as to appear unnaturally dark. In slow action, of course, a more accurate method of lighting may be used. More depth may be achieved by careful focusing of the camera. The actors move slowly, if at all, and the lights set upon them may be very closely adjusted and properly diffused for maximum effect.

The walls of the set are first streaked at an angle from above, or from "up high." This is done by starting from one point and working completely around the set. At the same time, the important objects in the room are picked out and given individual lighting, generally, slightly from the rear. This makes that particular edge of the object away from the camera limn, or appear to be edged with light. This procedure prevents the object from appearing to be flat against the background, and furthers the illusion of three dimensions. Large or important objects in the room may be given additional lights. These are called crosslights and backlights. Backlights are used on objects and the actors whenever possible. Crosslights (also called "liners" or "line-lights," because they line the object with an edge of light) are very frequently used, particularly on dark objects or clothing.

The upper portion of the walls should be lit less brilliantly than the lower portion in order that the composition of the picture may appear not to be top-heavy. Large flat surfaces or walls should be streaked with masses of light and semi-darkness. This tends to prevent the appearance

• Continued on page 90.



There's **FILMING** to do IN **WINTER** too . . .

OFTEN the descent of winter over the land has a dampening effect upon the enthusiasm of some cinefilmmers. This is especially true of many color film addicts who feel their filming time comes to an end with the first snowfall. Others, preferring the warmth of the fireside during the chill months from November to March, allow their cine cameras to go into hibernation, too.

These fellows are passing up the greatest filming season of the year. Some of the finest amateur films that have passed in review before the editors have been made during winter months. So we know the majority of cinebugs continue active long after the first frost is on the pumpkin.

To bring our readers a close-up account of how some amateurs continue to make cinematic hay while the sun doesn't shine, we've asked two of our advisory editors—Peter S. Bezek of Chicago and E. Moss Brown of Dallas, Texas—to report on how cinebugs in their localities keep their cameras busy in the winter. Bezek muses:

"IT FEELS kind of nice these long winter evenings to settle down a little further into the easy chair in warm robe and comfortable house slippers, while the cold chilling wind blows around the corner of the house in mournful plaint and the snow flurries pile up into drifts. Yes, sir, it sure is cozy indoors these cold winter days.

"Take my camera out of the closet where it's gone for its annual hibernation? No, sir, it's too comfy here to even think of going out!

"No, sir, I'm not going to drag my camera out and tramp through those icy drifts to get any beautiful snow scenes. Let others who like the cold weather get them!

"Let others capture onto movie film the beckoning, snow-filled woods; the cozy-looking farmsteads, the meadow with that meandering brook down in the south forty; the traffic-snarled streets with 1940 autos helplessly stalled, their hundred-

horsepower motors futilely spinning the wheels. Let others capture the signs of harsh, yet appealing, winter with people leaning against the wind, snow blowing down their closely buttoned collars, cheeks rosy for Kodachrome, eyes glistening brightly. Let others capture the youngsters using their Christmas sleds for the first time in happy glee; or tiny tots trying out those new skates by the sit-down route. Perhaps, too, capture the lovers skating together, arm in arm, or the fancy skater doing his flashing routine to an admiring audience with a possible spill lurking ever present to satisfy our sadistic nature. All these mean winter, of course, but I'll let the other fellow get them.

"Of course, come to think of it, those winter movies that my pal Dick showed in the heat of summer last July did look awfully good, and everyone talked about them for a long time. I know that we all were envious then and resolved not to let another chance slip by next winter to do as well.

"Br-r-r, maybe some other time. I'll compromise this time and do all that inside stuff I've promised for so long. That's right, I was going to try some new trick titles; something different and original, so that all that footage I took this summer would look better. And I was going to try some experiments in animation, just in case Walt Disney asked me to help out some day. Too, I've always intended to try some of those 'catastrophe' shots in miniature just like they say are 'faked' out west. And I was going to build that little stage and have it ready for pictures of insects, caterpillars and other bugs next summer. Friend wife has also been after me to film that little bridge story that I've promised our friends for so long. Sure enough, I've got plenty of work for my camera right here indoors!

"Br-r-r, listen to that wind outside. Say, that beautiful Jack Frost painting on the window would make a nice background for a title, I wonder if it would work. There comes friend wife with her arms full of groceries, her breath coming

Reported by
PETER S. BEZEK
and
E. MOSS BROWN



in short, quick blasts of cloudy vapor. And there's neighbor Jim shoveling off the sidewalk, and Fran taking a surprise shot of him with that new 8mm camera he got for Christmas. I'll just sneak around the corner and surprise them both, and see who has the laugh. Could do it with my telephoto, I bet.

"What's all that noise over in the next block? Why, the kids are having a snowball fight, real snow fort and everything. Guess I'll just film that and show those 'generals' why they didn't win that last battle.

"This wind feels kind of good, sure makes my blood tingle, and it isn't as cold as it looked from inside. Guess I'll mosey over to the skating rink and see what's going on there and finish this roll!"

—Peter S. Bezek

WE OF the Southwest find the winter season one of our busiest for cinematographers.

"True, we do not have the beautiful scenics of

the snow-covered Adirondacks or the thrilling action of the winter sports to furnish our cameras with scenarios, but most of us look forward with a definite expectancy toward the coming of the winter months.

"There are our summer films which have been shot at such a rapid rate that they are entirely unedited or very poorly edited and the o'd camera spends one of its busiest seasons during the winter on the editing board!

"There is the vacation film which has not half enough titles because our friends just couldn't wait to see our 'Vacation Pictures.' By now we have had the advantage of reviewing the picture enough to know just what it needs! There are too many distant scenic shots following each other in unbroken sequence. A little work and the corner of the bedroom looks like the interior of the hotel room where you stayed, and before the camera appears the comical scene of two road-weary travelers unpacking. The bags are switched and Hub-

• Continued on page 93.

• There's glamour in the mantle of snow that covers everything in winter, when filmed through a filter and in interesting composition as in the scene above.

Reviews by
THE EDITORS

ALTHOUGH space necessarily limits the number of reviews of amateur films which appear in this department each month, the number of films reviewed by HOME MOVIES staff has increased steadily. The reviews printed here are selected for the timely suggestions they contain which might be of interest to other amateurs.

Every reader is invited to submit his films to us for review and criticism without any obligation whatever. Through this service, hundreds of HOME MOVIES readers have been helped in improving their filming technique. Moreover, each film reviewed is returned with an attractive animated HOME MOVIES leader, lending prestige to the amateur's filming accomplishment.

The following reviews have been selected for

TELL ME — *how can I improve my film?*

publication this month. Study the reviewer's remarks. Perhaps there's a suggestion or two in these reviews that may help you too!

"BEGINNER'S LUCK"
525-foot 8mm — by C. O. T.

★★

Continuity: This is a vacation picture. In order to give it a central theme, the introduction shows a husband and wife poring over travel folders; discussing the merits of the various places; and the husband ultimately convincing his wife they should go to some place affording good fishing. The wife consents, with the proviso that the one who catches the smallest fish each day would have to cook dinner.

We are shown them fishing; then sightseeing — and fishing again. The first episode shows the man catching his hook in the trees in his first fishing attempt. To this reviewer, this suggests a good "running gag" sequence that could have been cut into this picture. The wife could have been shown pulling in one fish after another while the husband, in frantic mood, was trying to untangle his line from the tree, and ultimately — having to cook dinner as per their agreement.

The next sequence consists of scenery, the interest of which could have been greatly increased if one of the party had appeared in the foreground of each scene seemingly gazing at the scenery.

The last sequence shows them fishing again. This time the man catches the smallest fish, and

• Continued on page 94.



• Reproduced here are enlargements from the 16mm Kodachrome film, "Bullfighting" in Mexico—remarkable for its consistently even exposure.





Fig. 1



Fig. 2



Fig. 3

These NOVEL EFFECTS are fun to make . . .

Authored by
GEO. W. CUSHMAN

IMAGINE the Ohs and Ahs that would come from your audience if any of the scenes pictured on this page were suddenly to flash before them on the screen—in motion! Wouldn't that be a new and different treat? You bet it would; but think of the fun you'd have in producing them.

Too bad we can't just tear this page out and go thread it in the projector. Then we could show you exactly the effects we are trying to describe. But let's take figure 1, for instance. The idea here is to show the page of a book, newspaper, or magazine, and framed in the center is the scene, actually in motion.

Many an amateur has used the front page of a newspaper for his title, for such reels as cyclone shots, wrecks and other disasters, important news events, or just anything which is written up in big, bold type on the first page. After a shot of the paper, he cuts in his scenes.

One variation of this is to paste onto the first page a frame enlargement from the first frame of the scene which is to follow. After sufficient film

has been exposed on the newspaper page, the camera zooms up to the frame enlargement (which is supposed to resemble a newspaper picture), and as the zooming stops, so does the exposure. By splicing the first scene next to the newspaper shot thus made, the effect will be that the camera zooms to the newspaper picture which suddenly comes to life.

Another way to do this would be to set up the newspaper (as far from the camera as possible) and cut out whatever portion is desired to form the frame or mask. Behind this opening the action takes place, and the illusion, as we have tried to picture it in Fig. 1, is complete. Since there will no doubt be quite a distance between the newspaper mask and the subject in action, a small diaphragm opening is necessary so that both paper and subject will be as sharp as possible.

Still another method, but one which is recommended with reservation, is by rear projection. With this method the newspaper or bookprint is placed in the title easel and right in back of it the ground or opal glass. The picture is then projected onto the glass from the rear and the camera exposed in the usual manner as when making a title. Care must be taken to see that the newspaper is not overexposed and also that light from the illumination does not fall on the glass itself. Even when such an elaborate set-up is completed, the projected picture will probably flicker slightly in the finished film, since camera and projector are not running in synchronization.

The best method is with the use of a film printer and film masks, and we're going to explain that shortly. But first, let's look a moment at figures 2 and 3. Both of them show a calendar with the center of action in a circle. Of course, without motion, a picture can be cut in any shape and pasted onto a calendar, page of a book, newspaper, and so on. This is merely copied the same as any title. But to get the motion in these circles, and also a soft diffused line around the circle as in figure 3, we must resort to careful and painstaking procedure. There are two or three ways this can be accomplished and we shall describe each of them briefly.

We shall assume the worker has the two film strips he wishes incorporated into the final shot. That is, he has the shot of the baby and another of the calendar. His next job is to make two more strips, one of figure 4 and another of figure 5. These can be made either on reversal film or positive, but no doubt if the worker uses this method, he will prefer positive film. These strips can be made by either copying both figures 4 and 5, or by copying one and then making a print of this copy on another piece of positive film. These, which we shall call the film masks, should be developed to high contrast.

If a definite edge is desired around the center, as in figure 2, the camera should be focused carefully when figure 4 is photographed. If a softer,

• Continued on page 96.

• The trick compositions shown above will put plenty of snap into your home movies—lend a professional touch. Author Cushman tells you how to use the mottos below to obtain these effects.

Figs. 4 and 5

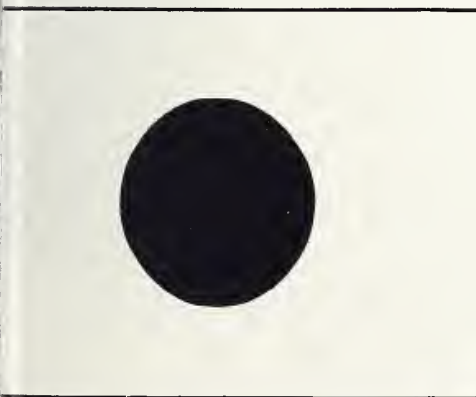

Authored by
EUGENE M. LIEBSCHER*

COMPARATIVE DEPTH OF FOCUS OF VARIOUS CINE CAMERA LENSES

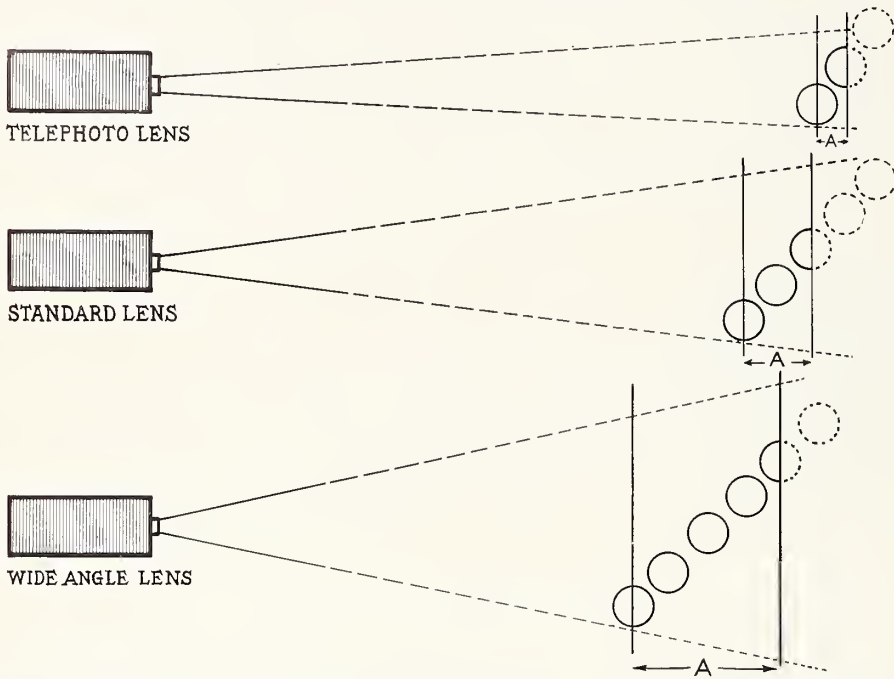

AREA OF SHARPEST FOCUS INDICATED AT "A"

Fig. 1.

A tip or two on filming TRICKS and EFFECTS

IN PREVIOUS articles I have stressed the point that although you may see a great many trick shots and special effects on the theater screen which may appear to be beyond the scope of your achievement, a great many of them are really comparatively easy for you to duplicate.

Special effects are those cinematic embellishments that attract and hold interest in your picture. Such effects, however, should have a direct bearing on the story. It is unwise to introduce trick shots and special effects just for the novelty alone.

In preparing to make these trick shots and special effects, the use of the right lens is all-important. If proper attention is not given this detail, the special effect may, when projected, be as flat as the proverbial pancake! It is necessary therefore that you become thoroughly familiar with the characteristics of the standard, the wide angle, and the telephoto lens.

Most of us are quite familiar with the capabilities and limitations of the lens which comes as standard equipment with most cine cameras—a one-inch or 25mm lens with 16mm cameras and a one-half-inch or 12½mm lens with the eights.

A wide angle lens is any lens of a shorter focal length than the above. It enables you to photo-

graph a wider area from the same camera position. Also it has a greater depth of focus than lenses of greater focal length.

A telephoto lens is greater in focal length than the standard lens. It enables you to photograph an object at a distance and make it appear on the screen as though it were taken close up. The longer the focal length of a lens, the less depth of focus it possesses. Obviously, then, the telephoto lens is the least desirable for special-effect work.

The standard or the wide angle lens is the one to use. Either permits working at close range and the increased depth of focus insures a more natural effect in special effect shots. Especially in miniature shots, this element of depth imparts a semblance of solidity to the subject—a certain "roundness" that we call three-dimensional.

As the angle of view is identical for both 8mm and 16mm cameras, the chart below can be used as a guide for lining up closeups in making miniature or special-effect shots with your home movie camera:

Distance from Camera	Area or Field of View
10 inches	3 in. x 4 in.
20 inches	6 in. x 8 in.
40 inches	12 in. x 16 in.
80 inches	24 in. x 32 in.
10 feet	3 ft. x 4 ft.
20 feet	6 ft. x 8 ft.

Beyond the distance of 20 feet, your camera finder may be used in lining up your shots. It is advisable always to measure, with tape line or yard-

• Continued on page 92.

• Illustrations on this page show the comparative depth of focus inherent in cine camera lenses of various focal length as well as depth of focus obtainable through increasing or decreasing diaphragm opening. Depth of focus is a most important factor in the filming of special effect and miniature shots.

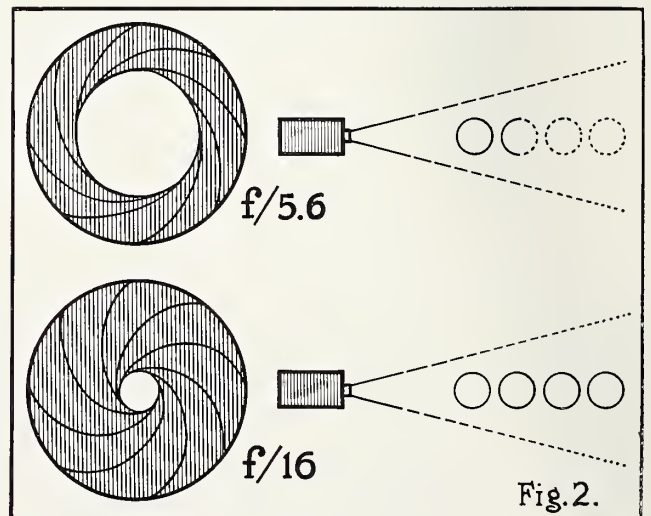
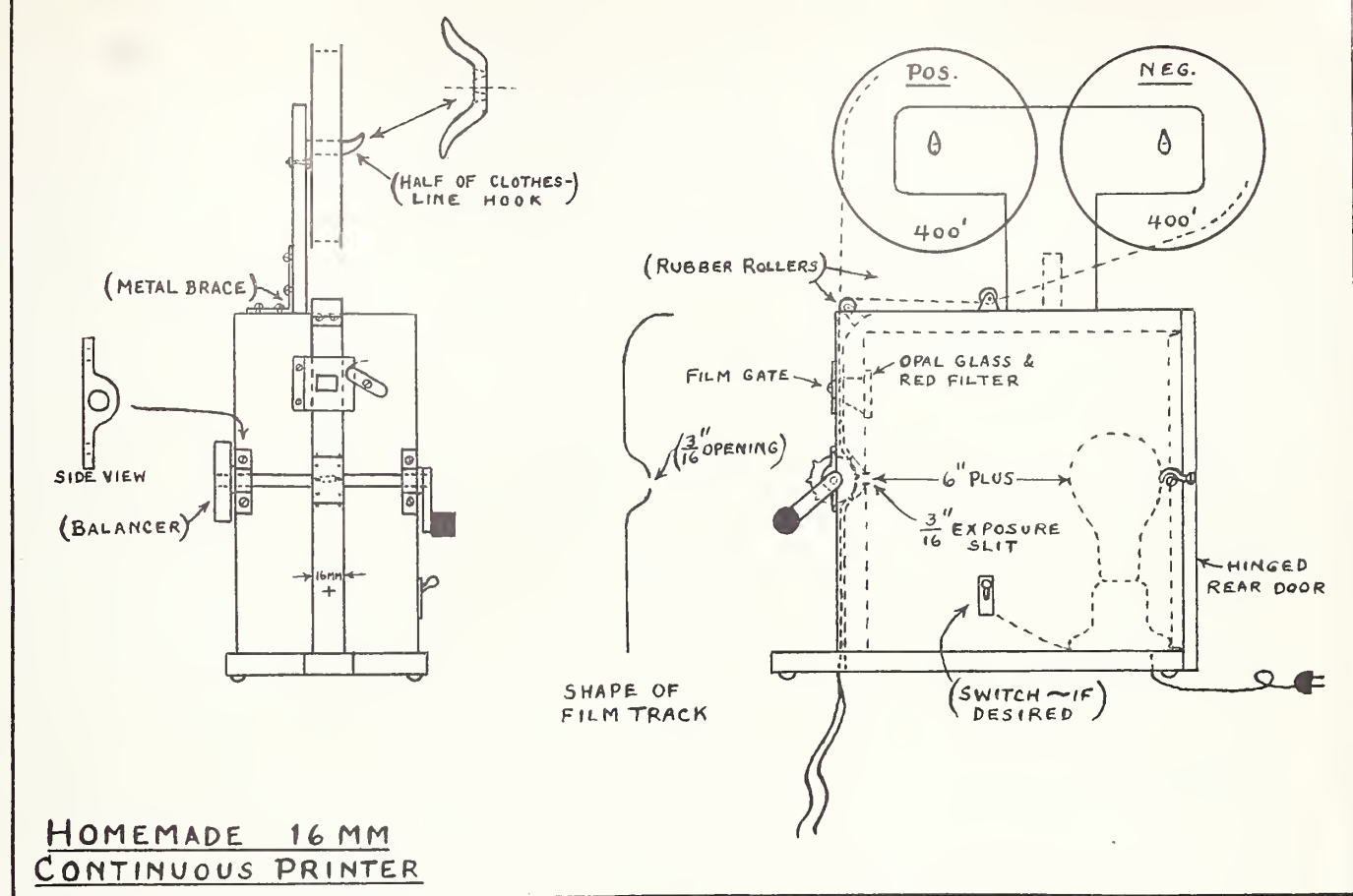

Fig. 2.

*Cine-optical specialist for many Hollywood film studios.

Authored by
WALTER W. LIGHT



HOMEMADE 16 MM
CONTINUOUS PRINTER

YOU CAN BUILD *this 16mm continuous printer..!*

THE writer recently made a 16mm continuous printer similar to the one illustrated. Results have been very good and, since professional printers are usually expensive, the writer thought others might be interested in the construction details. Very few dimensions are given, as they may be varied quite a lot. Only a few are fixed—based on the size of the reels, film, etc.

The main body of the printer is composed of sheet metal or heavy plywood. It should be painted flat black inside—the outside, optional. The film track is of 1/32" polished brass, curved to fit around the sprocket, about 1/16" (or slightly more) clearance being allowed. The track is *very slightly* over 16 millimeters wide, is set back about 1/16" and has a small opening (exposure slit) at the center. This slit should be at least 1/8" to 3/16" high and the width is the full 16mm *picture width*. (For sound films, extend it to the edge on one side. A motor would be required for good sound printing.) If dark edges to the finished prints are not objectionable, the slit can be made the entire width of the film. The film track would then be made in two pieces and the exposure slit could be made very accurate.

The two 400-ft. reel holders are made from a 5 and 10 cent store clothesline hook sawed in half and bent at the proper angle. These halves are screwed or bolted to a large "T" made of 1/2" plywood or hardwood.

The negative and positive films are brought (emulsions together) over a small, smooth roller, then run through a small film gate which has

moderate spring tension and a small window for viewing the negative density just before exposing. Opal glass and a light red or orange filter are placed at the rear of this window. The films then pass to a sprocket at least one inch in diameter and of the solid type—that is, the entire central section of the sprocket should be smooth and high enough to press the two films together in perfect contact. Also, the sprocket must be set into the body of the printer far enough so that the films are held by several sprocket teeth during exposure. This insures steadiness and good contact. In threading, the films are curved a little at the ends so that they will follow the sprocket around. The sprocket teeth must not be too long.

The sprocket shaft holders should be a close fit. The weight, or balancer, is not necessary, but makes turning smoother and steadier. Keep the moving parts oiled, but keep oil away from the film.

A 25 to 50 watt frosted bulb is used for exposing the positive. The center of the bulb should be on a straight line with the exposure slit. No ventilation is needed, as the bulb need not be on long enough to overheat. A hinged rear door is provided. This should be reasonably light-tight.

Change in exposure can be accomplished by rheostat light control or by changing the cranking speed. A variable aperture slit would also work, but the *quality* of definition would vary. Fast types of positive stock such as Gevaert are best for dense negatives and require less wattage. Duplicate negatives can be made from worn-out prints,

• Here's a 16mm printer that is a real "baaper-duper"—one that any cinebug can easily build and with which he can make duplicate prints or positives.

• Continued on Page 93.

“IT'S NEW TO ME”

By CINEBUG SHOPPER

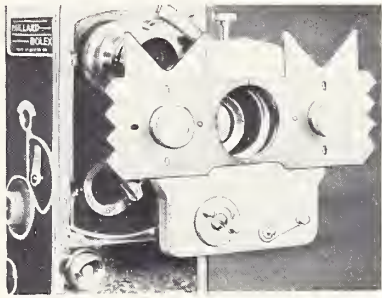

Bool Cine-Fader

A new 12-page folder describing how to make fades and lap-dissolves has just been prepared by the American Bolex Co., Inc., 155 East 44th St., New York, and will be sent upon request to all those interested in improving the flow and continuity of their personal movies. The pamphlet explains the technique of making many interesting and novel scene transitions by means of the Bool Ciné-Fader, a unique device which fits practically every make of motion picture camera, and which is capable of producing as many as 64 different basic effects.

Besbee “Plaston” Letters

The new Besbee Plaston title letters are the last word in a specially created design for making neat, professional-looking movie titles. Made of a new kind of plastic that will not chip, crack or break, Plaston letters are pressure molded into clear, clean-cut outlines and make it easy to produce titles of attractive design and high legibility.

The Plaston letter set comes in a special grooved panel case which provides a neat and compact method of storage. The letters may be placed on any matte black, white or colored background. Also, any photographic or other design background may be used.

Sports Film

Official Films, Inc., 1441 Broadway, New York City, announce a new release in 8mm and 16mm—“Monarchs of the Ring”—a thrilling reel of punch-packed action. It features the ring's greatest fighters in a cavalcade of eight championship fights that made boxing history, according to the producer.

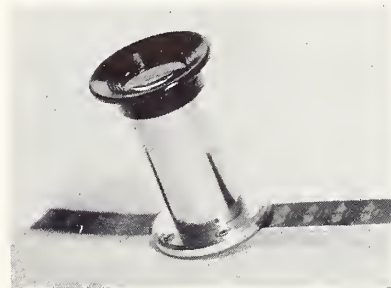

Cine-Scope

Camera Specialties of Hollywood, Calif., announces the “Cine-Scope”—a new pocket film viewer, designed by E. M. Liebscher. This handy device fills a need for a viewing device for inspecting 8mm and 16mm film away from the editing board. It is also adaptable for editing board, etc.

Neat, efficient and low-priced, the “Cine-Scope” shows a large, clear image. The film is merely slipped in at the side and held in place by a grooved track.

New Viewfinder For Films

The “positive” type viewfinder on Filmo 141 and Turret 8 cameras has proved such a popular feature, says the Bell & Howell Company, that it is now being made available as an accessory to all owners of Filmo 70 and Double 8 cameras. The viewfinder, known to Hollywood technicians as “positive,” has two great advantages, it is said. First, the image remains fixed on the viewfinder glass regardless of

how the operator's eye may shift around the eye-piece. In other words, eye-parallax is said to be entirely eliminated—very important in close-up filming.

Secondly, the full image always fills the entire viewfinder glass, no matter how long a telephoto or how short a wide-angle lens may be used. There is no masking of the field for the longer lenses.

Kodachrome Prices Drop

Welcome news to every amateur cinefilmer is the recently announced drop in both 8mm and 16mm Kodachrome film. Prices now in effect are as follows: Regular and type “A” Kodachrome is priced at \$4.30 for the 50-foot 16mm roll, and \$8.00 for 100 feet. The 50-foot magazine now sells for \$4.65. The 25-foot double 8mm roll has been reduced to \$3.40.

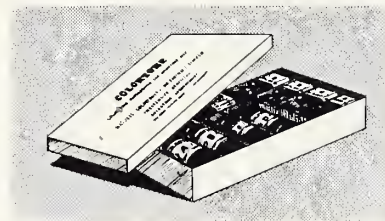

Colortone Process

The Colortone Process Co. announces a radically new and simple process for multi-coloring still pictures from black and white prints.

Essentially it is a toning process by which various colors may be obtained by brush application of Colortone on a specially prepared bromide print. Prints may be multi-colored at an average cost of less than 10 cents per print, according to the makers. For further information write Colortone Process Inc., Dept. H, 315 West Venice Blvd., Los Angeles, Calif.



Castle's Graf Spee Film Ready

By means of its authentic prologue and its extremely vivid closeups of the flame-crackling wreck, Castle Films' latest News Parade featuring “Battleship Graf Spee Scuttled” gives home movie enthusiasts and librarians scenes and effects that were not present in the theatrical news reel releases. This timely and interesting film is available in both 8mm and 16mm widths at photographic dealers, and shows the British Navy convoying merchant ships, helpless vessels sinking, the crippled Graf Spee limping into Montevideo harbor, and many, many other exciting scenes.

Actual scenes of the flaming ruin are made more spectacular in this Castle release by zooming closeups that bring the spectator so near that he can almost feel the scorching heat!

Photolamp Guide

Camera fans who take flash pictures, photo-flood pictures or home movies will welcome

• *Continued on page 98.*

SKI TRAILS

(right)

and skiers offer fine winter filming material in many parts of the country. Excellent composition and good use of red filter is evident in this picture. Use it as a title background with dark letters for your ski or snow film.

Photo Courtesy Union Pacific

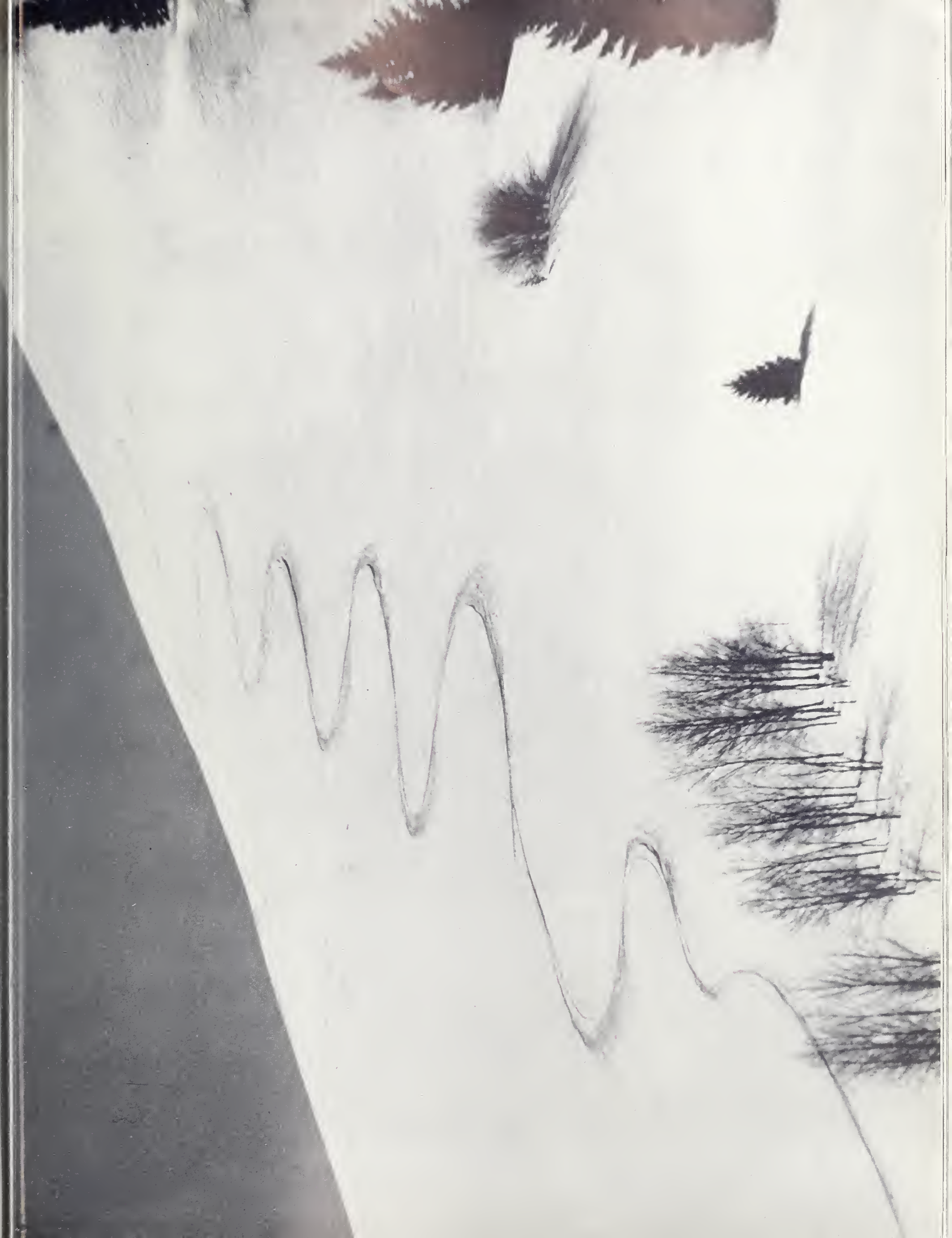

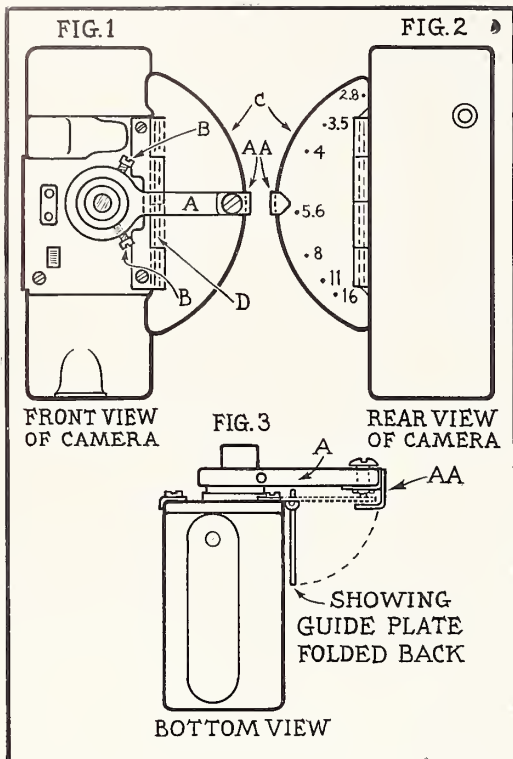

Fading Device

The accompanying illustration shows a development of the commonly used "iris control" as a means of creating fades which I designed for my Filmo eight. It can be adapted, with slight change in design, to almost any 8mm or 16mm cine camera. The improvement provides for more accurate control of the lens diaphragm without the necessity of keeping an eye on the "F" stop markings on the lens barrel.

A feature of this gadget is that it may be left permanently attached to the camera. It may be folded up as shown in figure 3, to permit placing camera in camera case when not in use.

The gadget consists of two parts: I call the part that fastens to the iris control ring on the lens, the diaphragm handle (A). This I have made of red fiber although it could also be made of metal or wood. The two set screws (B)

THE EXPERIMENTAL

secure it firmly to the lens. As can be seen from the illustration, I have fastened to the end of the handle a pointer (AA) which serves as an indicator showing exact setting of lens. This pointer is made of 23-gauge metal, bent as required to fit over edge of the plate, and screwed into the handle end.

The second part of this gadget (C) I call the guide plate. It is made of a piece of 23-gauge metal and soldered to a section of piano hinge (D). The "f" numbers are stamped or painted on the back of the plate according to positions established by the pointer on the diaphragm handle. The screws necessary to fasten the hinge to the camera replace those already in the camera case and are $\frac{1}{8}$ " longer. These are obtainable from almost any hardware store.

To assemble for use, open hinged plate (C) parallel with front of camera. Fit diaphragm handle over lens barrel, engaging pointer over edge of plate. Set iris ring or diaphragm to correspond with markings on dial or guide plate as indicated by pointer. To make a fade, open or close diaphragm during filming by moving the diaphragm handle to desired "f" stop as indicated on guide plate.

—W. R. Kalberg



Extra Lens Holder

A unique holder for extra lens, portrait attachment, or filter for small cine cameras may be made from the screw spout and cap from one of the many metal containers available. Simply cut spout from can and attach it inside camera carrying case with liquid cement, as shown here.

—B. E. Stevens

8mm Re-inforcements

In anchoring the ends of 8mm film on my processing drum, I had great trouble with the rubber bands pulling out. The film would break in spite of everything I could do. Finally, I hit upon the idea of re-inforcing the ends with adhesive tape—a short section folded over the end of the film. A hole was then punched through the taped end and the rubber

band inserted and knotted. After processing, the taped ends are clipped off.

—R. W. Seichrest

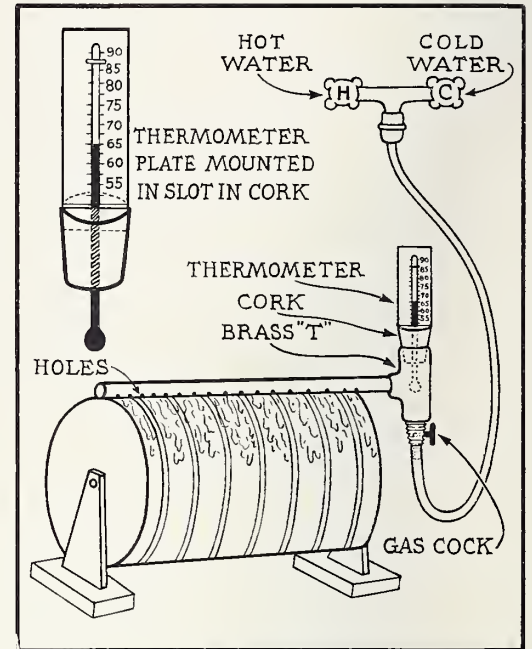

Temperature Control

To facilitate washing my films in home processing, I made the outfit illustrated here which provides perfect control of wash water temperature and also makes the washing task simple. The entire assembly is set up near the film rack so that the water flows over the film.

Take a piece of $\frac{3}{8}$ " brass pipe and drill small holes every $\frac{3}{8}$ of an inch its entire length. At one end put a brass cap and at the other, a "T" which should have a $\frac{3}{8}$ " opening and two $\frac{1}{2}$ " openings.

In the opening at the top of the "T" is fitted a thermometer such as may be found in any five and ten. Get one with a metal thermometer plate. Also, get a cork to fit the opening in the "T" and drill a hole through it that will accommodate the thermometer tube.

After carefully marking the position of the tube on the plate, remove it temporarily and cut off the plate sufficiently to allow the thermometer tube to extend far enough through the cork and into the "T" so that it will come in contact with the water. Fit the plate to the tube and cement firmly in place in the cork.

In the bottom hole of the "T" attach an ordinary gas cock. To this, connect a rubber tube such as supplied for shower purposes. These have a snug fitting connection for the water faucet.

This outfit, connected to a twin hydrant, as shown, will enable you to maintain your washing temperature at the proper level at all times.

—Arthur M. Sharp

CINEBUGS!

• If you have an idea for a gadget, trick, or shortcut in filming, titling, editing or processing home movies, pass it on to your fellow Cinebugs through these columns. If your idea is published you will receive two reels for your efforts. Extraordinary ideas will net you a roll of film.

Ideas not published will be held for future publication unless they duplicate ideas previously received. Endeavor also to send along photos or rough sketches illustrating your suggestions. There is no limit to number of suggestions you may submit.

Names and addresses of contributors of published ideas are furnished a prominent manufacturer interested in acquiring rights to saleable gadgets on a royalty basis.

Important: When submitting ideas, be sure to mention whether equipment you use is 8mm or 16mm, enabling us to promptly forward onwards adoptable to your use.

C I N E W O R K S H O P

gadgets, tricks and short cuts contributed by Cinebugs

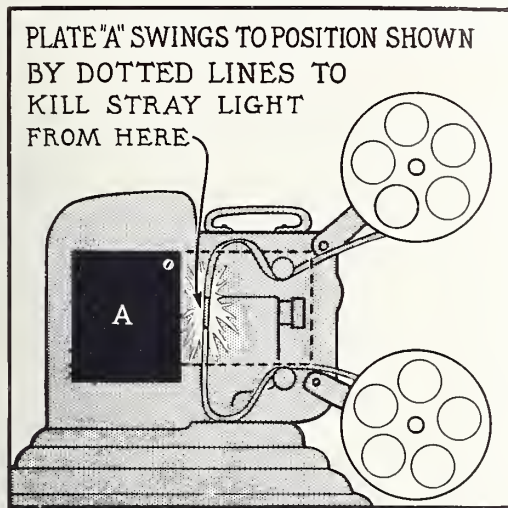

No-Glare Projector Shield

One fault I find with most 8mm and 16 mm projectors is that no provision has been made for shielding the stray light that is emitted during projection—usually into the operator's eyes—from the opening between the condenser and lens.

To remedy this on my projector, I cut a piece of sheet metal and bolted it to my projector lamp housing, as shown. During projection, it is swung into position to shield the stray light from my eyes. During threading operations, it swung back against the lamphouse.

—H. D. Wilson

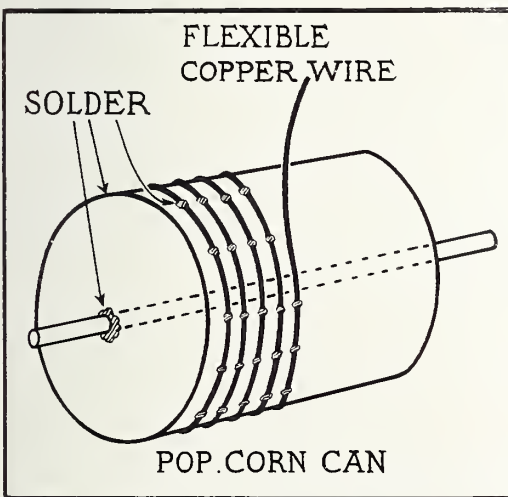

Popcorn Can Film Drum

The all-metal bulk popcorn cans, now available from most grocers, make excellent developing drums. The lid should be carefully soldered to insure against leakage of water into inside of can. A metal rod of suitable size and length should be run through the exact center of the can and soldered at either end. To this may be attached a handle for turning or a pulley for motor driving as required.

As a guide for the film, solder flexible copper wire in a spiral around the drum in bands about $\frac{5}{8}$ " apart. Apply two or three coats of red acid-proof paint. The red color will show up as white under a red safe-light, facilitating easier viewing of the film image during processing.

—Elmer Wilson

Film Marker

When it becomes necessary for me to change from one roll of film in the camera to another, before the first roll is fully exposed, I have found it convenient to mark the spot for re-threading with a small safety pin inserted in one of the perforations instead of marking the film with pencil. The pin is inserted in a perforation near the supply spool, which insures threading film in camera with the last exposed frame near the film gate and allows for running a few frames to check for accurate threading before closing the camera.

—Milton E. Linhardt



Projector Case

Unable to find a projector case to suit my needs, I made one from an apple box. The inside of the box was lined with fabric which was tacked and glued in place. The outside covering is fabrikoid or imitation leather. A couple of hinges, a hasp, and a handle from the dime store completes the case. The section for holding reels is made of quarter-inch ply-wood.

—Thomas Rahn

Projector-Spotlight

Your projector will serve as an excellent spotlight for special effects, backlighting, title making and so forth. Simply remove the belt that operates the shutter mechanism and direct the light beam as required. For circular spot beams, cut a round hole in a piece of cardboard and place before the projector light beam.

—George Burnwood

Simple Range Finder

A highly effective range finder for determining distance between camera and subject may be made for a few cents from a small block of wood, an old alarm clock hand, a nail, and a small wire spring. Its function consists of sighting through the hole, bored lengthwise in the block, on the base of the object to be photographed. By pressing on the nailhead "C" the clock hand swings free by gravity, pointing downward to the footage mark on the dial, according to the angle at which the range finder is held during sighting. When nailhead is released, the clock hand is held firmly in position indicating the footage on the dial. It is effective only when used in

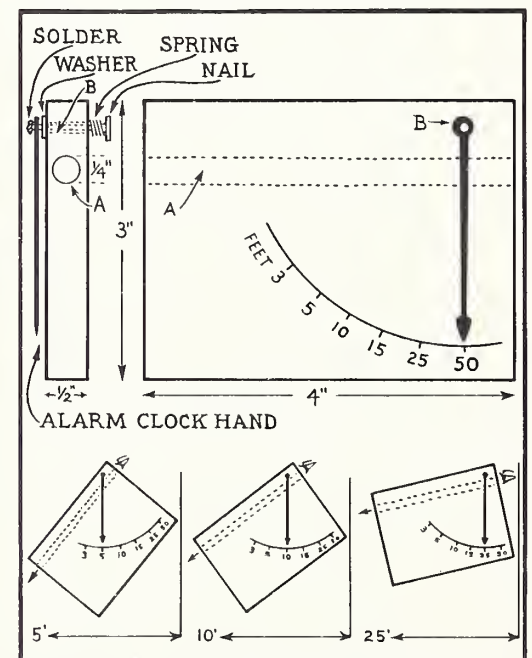

sighting on objects on the same ground level as the user.

The block may be a piece of soft pine, 3"x4"x $\frac{1}{2}$ ". Bore the hole as shown at "A", making sure same is parallel with top of block. Drill another small hole, as shown at "B", to take the nail. This hole must be large enough to allow nail to move freely within it. With the small spring in place next to the nailhead, insert nail in hole, slip a small washer over the other end and then the clock hand. The washer acts as bearing between clock hand and block. The hand should swing freely on the nail.

Clip nail to proper length and apply

• Continued on page 98.

AWARDS WORTH

Prepare Your

HOME

1940

AMATEUR

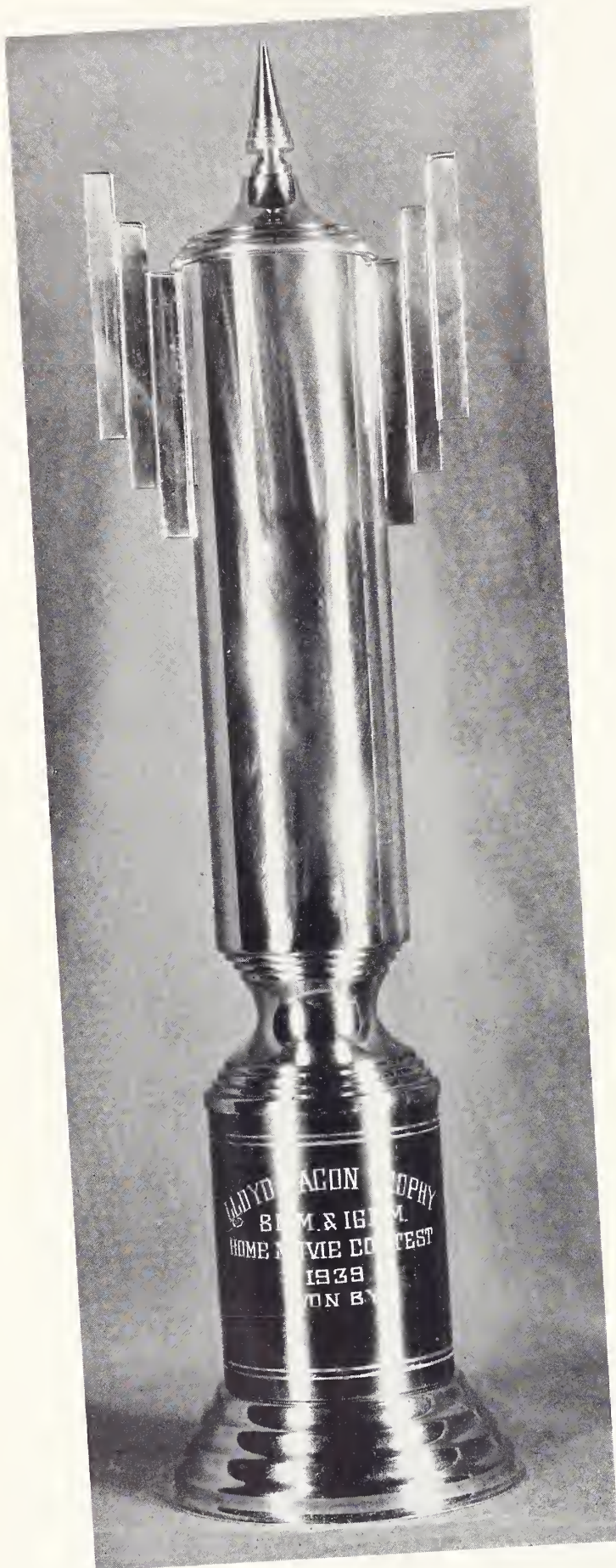

• **FIRST AWARD**—The Lloyd Bacon Trophy, comparable in the amateur field with achievement awards of the Academy of Motion Picture Arts & Sciences in professional motion pictures, and probably the greatest distinction that can come to an amateur cinefilmer. Also 12 rolls Agfa Hy-Pan Film.

HUNDREDS of home movie cameras are pointing toward the most important amateur contest of them all—HOME MOVIES' 1940 Annual Amateur Contest now in full swing!

At the top of the list of awards is the Trophy sponsored by Warner Brothers' ace director, Lloyd Bacon. Following this is an imposing list of merchandise awards — every one worthy of the finest in amateur movie making achievement and destined to attract the widest array of contestants of any strictly amateur contest.

Home Movies' 1940 Annual Amateur Contest affords every amateur cinefilmer the opportunity to attain nation-wide recognition; to match individual artistic and movie making talents with other amateurs.

Every amateur movie maker is eligible to compete. Entries must have been produced on either 8mm or 16mm film; no 35mm reductions will be eligible. There are no restrictions as to length or subject. Particular attention should be given to editing and titling, as these two factors contribute a great deal to a successful motion picture and add up considerably in the final judging.

Wise amateurs will prepare to enter this contest now. Contest closes June 30th, 1940!

SHOOTING FOR!

Entries Now For

MOVIES

ANNUAL

CONTEST

RULES

- Entries limited to 16mm and 8mm films. No 35mm reductions eligible. No restriction as to length or subject. You may submit as many entries as you wish.
- Transportation on entries must be paid both ways by contestant. Where return postage is omitted, film will be returned via express, collect. All entries will be promptly returned after review by judges.
- Don't wait until final week to submit your films. Send them in as soon as ready. They will be reviewed, judged, and graded and a full report of same filed for consideration at time of final judgment. Films should be available for a second review by judges at close of contest if necessary.
- All entries should be titled at least to the extent of a main title. Adequately titled films improve their standing in the contest. Professional or laboratory produced titles are permissible.
- Be sure to label your film reels and containers, giving your name and address and the title of your production.
- No entry blanks are necessary. Enclose data with entry as to camera, lens, and film used; also, state whether filters, tripod, exposure meter, and any other equipment was used. This information has no bearing on the judging, but is of interest to the editors.

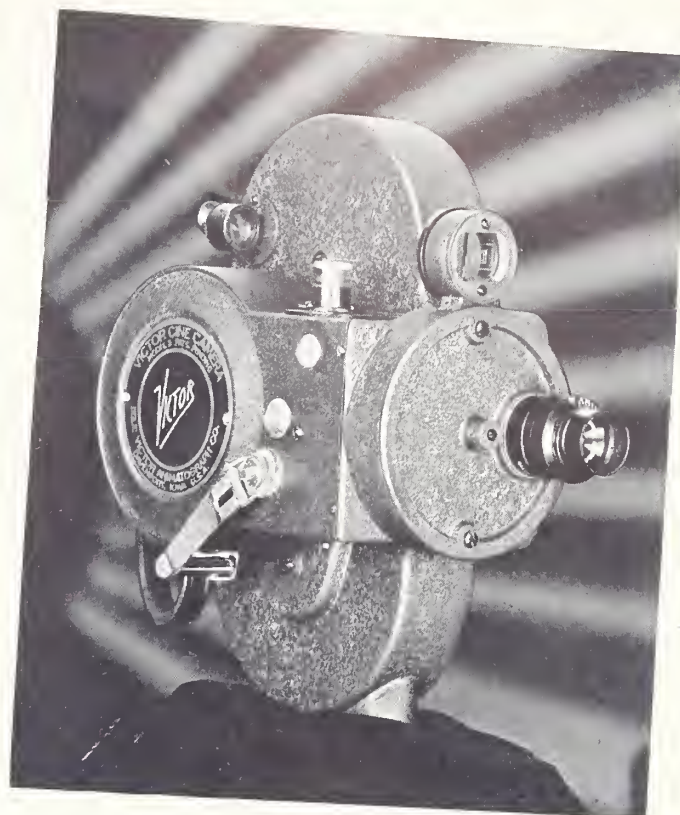

- VICTOR 16MM CAMERA—This model 3 Victor with f/2.7 lens will go to some lucky amateur in Home Movies' 1940 Annual Amateur Contest.

OTHER AWARDS

In addition to the awards already described, the following prizes go together to make Home Movies' 1940 Annual Amateur Contest something really worth shooting for!

- Thal-metal Tripod and Tilt-Pan Head
- Seemann Titler
- Kemp "Commander" Electric Exposure Meter
- Besbee Effectograph
- Besbee Ediscope
- Besbee Titlescope
- Twelve rolls Agfa "Hy-Pan" Film

These are only a few of the major awards. Other prizes will be announced later.

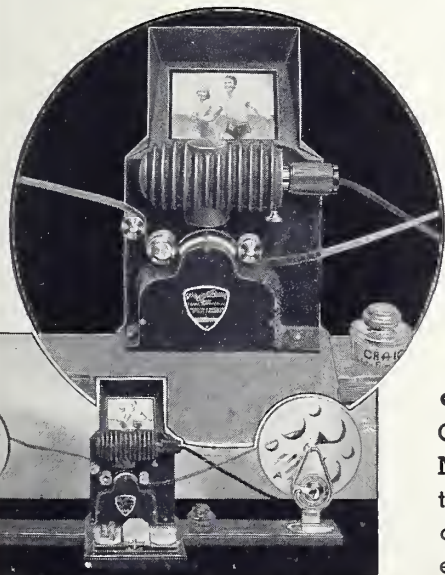

- CRAIG PROJECT-O-EDITOR—One of the major awards in Home Movies' 1940 Annual Amateur Contest, and one of the finest accessories of its kind for 8mm and 16mm film editing.

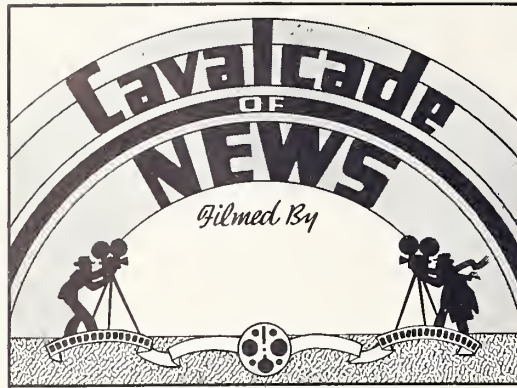

TITLE Backgrounds

By EDMUND TURNER

Although the title backgrounds which appear on this page are designed to fit the average 8mm and 16mm "typewriter" style titler, they are adaptable for use with any size and make of titler simply by having the illustrations copied and enlarged to the required size. You can do this yourself with your still camera, or you can have it done by photostat process by any blueprinting firm. This also applies where reduction in size is desired.

Where only a slight enlargement in size of title card over the size of these backgrounds is required, you will find it expedient to paste the backgrounds over cards cut to desired size from *colored, tinted, or patterned stock*. This will give you a border of an additional tone which will prove very pleasing in appearance, and will solve that problem of white space around title where title background fails to fit your titler exactly.

Again this month, we are printing below some additional captions, which, if they suit your needs, may be pasted in the lettering area of several of the backgrounds in this as well as other issues.

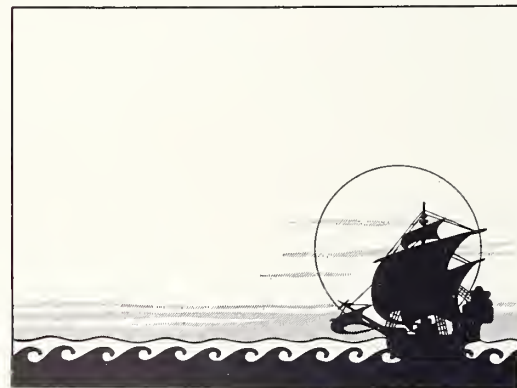
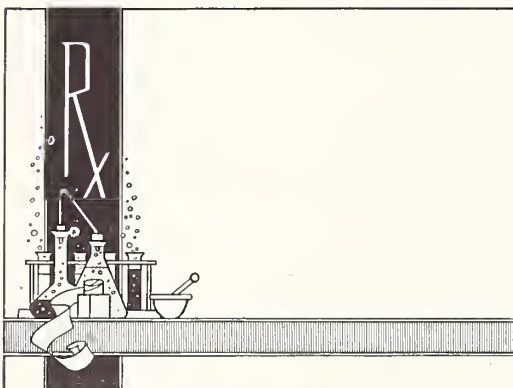
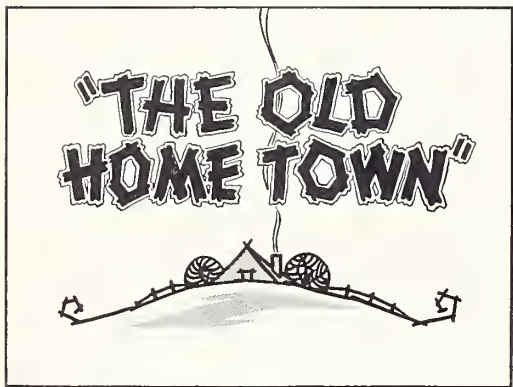
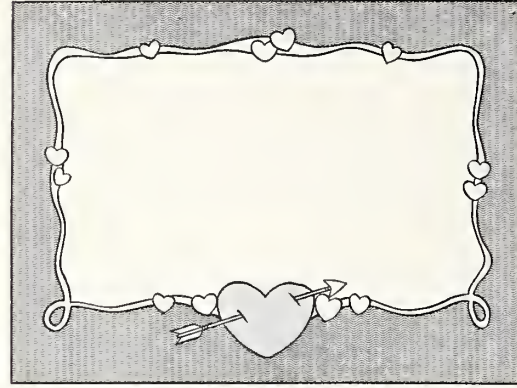
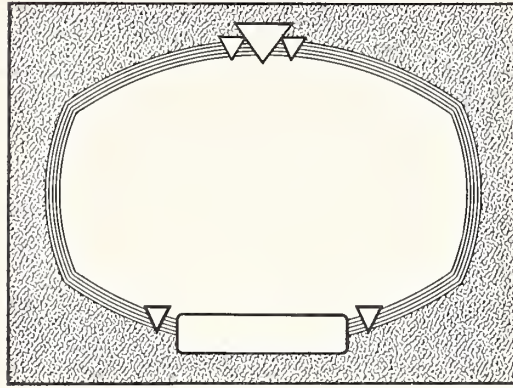

REEL NEWS

CINE SCRAPBOOK

PRODUCED BY

END OF PART

WELCOME 1940!

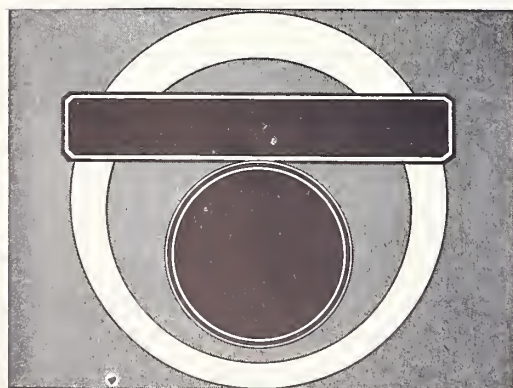

HOME MOVIES welcomes suggestions from readers for title backgrounds and supplemental title captions. Send us your ideas.

YOU'LL LIKE THE PATENTED LOCK-TITE CONSTRUCTION of REALITE

AMERICA'S QUALITY LIGHTING EQUIPMENT

For the best results, use the best equipment. Albert's REALITE is recognized by photographic authorities as the best lighting equipment. Here's why:

5 EXCLUSIVE FEATURES

LONG RANGE—from floor to 96" elevation. **BALL JOINT REFLECTORS**—swing through complete arc. **LOCK-TITE CONSTRUCTION**—locks instantly at any height. No bolts, nuts, or clamps. **TWIN-SWING ARMS** that "stay put" at any angle. **COMPACT**—folds to 38½" for carrying. Weighs only 10 pounds.

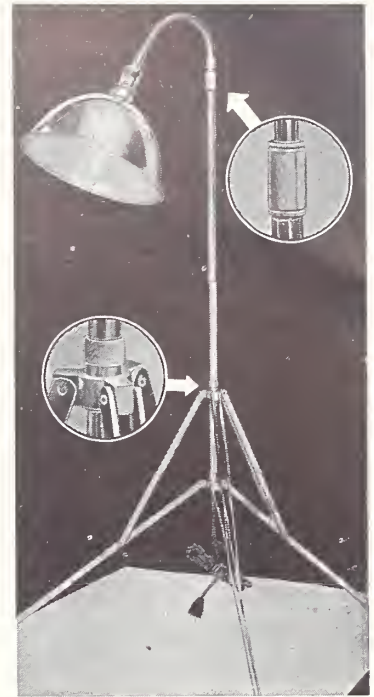

MOVIE MAKERS REPORT: "Can't Fall Down on the Job"

You, too, will be a REALITE fan, once you've used one of these remarkable reflectors.

You'll like the way it sets up instantly at any height . . . the way a simple twist of the patented lock holds it securely in place. No more fumbling with bolts or nuts, no more wasting of precious time to get lights to stay put.

You'll appreciate its rigidity and firmness, too. No more wobbling or shaking, no more wasted film and upset nerves just because the lights folded up in the middle of an exciting, wanted sequence.

You'll like this reflector even better as you get acquainted with its many other features—the scientifically correct brilliant flood of light it provides, the easy-to-direct reflectors, the 8-foot height, etc., etc.—and wonder how you ever got along without it.

For perfect, dependable lighting at a surprisingly low price, insist on the REALITE Reflector.

Write Dept. B-6
for Further Data

TWINLITE		SINGLE	
No. 1-A	\$9	No. 1	\$5.50
No. 2-A	\$12	No. 2	\$7.50

Albert



SPECIALTY COMPANY

231 S. GREEN STREET, CHICAGO, ILL.

ORIGINATORS OF DEPENDABLE PHOTOGRAPHIC EQUIPMENT

An Outstanding Value! SEEMANN EDITEER

Check these
special
EDITEER
features!

- Illuminated Optical Film-viewer shows magnified 8mm or 16mm film image in VERTICAL position.
- Seemann Splicer features dry emulsion scraper—makes quick, accurate splices that won't come apart.
- Splices 16mm sound film, too!
- Geared rewinds permit quick winding of film in either direction. Fits all 8mm and 16mm reels.
- Editing board provides recesses for holding film scenes coiled and in order, ready for splicing.

All Accessories Available Separately; Write for Circular H-2

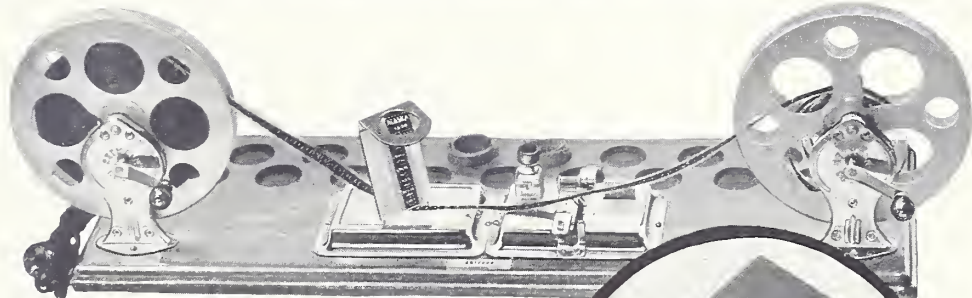

for Quick, Easy Editing Of 8mm and 16mm Silent and 16mm Sound Films

The **EDITEER** makes film editing and splicing a pleasure—not a task. Every necessary accessory is provided to make this phase of home movie making easy, interesting, and successful! Your films are easy to inspect, quickly and safely spliced, and the individual film-section receptacles are an innovation that will delight every amateur. Ask for a demonstration at your dealer's!

\$12⁵⁰



Distributed by
RAYGRAM, New York City
HORNSTEIN, Chicago and Dallas

SEEMANN'S Inc.

6628 SANTA MONICA BLVD. HOLLYWOOD
420 MARKET ST. SAN FRANCISCO

PEERLESS
"PLUS+VIOLET"
 REVERSIBLE MOVIE FILM

ASSURES YOU OF

BETTER MOVIES

"PLUS+VIOLET" is the kind of film you have often wanted but have been unable to find in its class price.

"PLUS+VIOLET" is a medium speed (Weston 12, Scheiner 20), fine grained outdoor type film with wide latitude anti-halo backing and a special base which filters out all of the low frequency rays of the projection lamp, giving upon the screen a more brilliant and pleasing picture.

"PLUS+VIOLET" is not just another cheap film at a low price, but is a SUPERIOR film in the low price class. It is offered as a splendid film for those who wish to get good results on a limited film budget.

A trial will convince you that "PLUS+VIOLET" will enable you to take more and better shots for less money. Order today one or more trial rolls of "PLUS+VIOLET" at these attractive prices:

25 ft. double 8mm on daylight loading spool, including processing and return transportation, \$1.00 per roll postpaid to you.

4 ROLLS FOR \$3.50

100 ft. 16mm on daylight loading spool, including processing and return transportation, \$2.35 per roll postpaid to you.

4 ROLLS FOR \$8.00

"PLUS+VIOLET"
 PANCHROMATIC

A high speed fully panchromatic "PLUS+VIOLET" reversible film with a speed rating of Weston Daylight 32 and Mazda 20—Scheiner Daylight 24 and Mazda 22. 100 feet 16mm on daylight loading spool, including processing, \$4.50, or 3 rolls for \$12.00 (8mm not available).

SPECIAL TRIAL OFFER

One 100-foot 16mm roll each of our regular "PLUS+VIOLET" and one roll of our Panchromatic "PLUS+VIOLET"—a \$6.85 value for only \$5.00. Limit two rolls to a customer.

Sold Only by

PEERLESS of HOLLYWOOD

P. O. BOX 1310-H

HOLLYWOOD, CALIFORNIA

8mm SLITTER

Slits perfectly 16mm width film to exact 8mm width. Die cast body with hardened steel cutting wheels. New price, each, \$2.50.

DEVELOPING RACKS

Stainless steel, take 30 feet 16mm or 8mm width film. Can be used in 11x14 or 8x10 flat trays respectively. Complete with loading stand, each, \$6.75. Specify type wanted.

At Your Dealer's or Direct

J. C. Haile & Sons

Motion Picture Dept.

215 Walnut Street Cincinnati, Ohio

Daylight can look bright

• Continued from page 68.

On the Kansas plains, particularly during long, dry periods, there is a heavy pall of dust that hangs over the land. As the terrain is flat and there are no mountains in the distance, this dust area extends to infinity, and for far distance views it is not possible to cut this dust with a filter.

The most effective treatment of such landscapes is to have a narrow foreground and a wide sky area. The sky is bluest directly overhead. By all means, filter the sky so that it will be a deep tone in your print. You will find it wise to make most of your closeups from a low angle, so that you will have blue sky behind them instead of the flat dust area along the horizontal line of sight.

Of all the problem locations, Death Valley is without doubt the most difficult. Key West, Alaska and Kansas each have a single, distinct problem, but Death Valley has a combination of extreme difficulties which will require all of your picture-taking knowledge and resources. If you really want to try a difficult job, tackle Death Valley. But don't try it unless you have plenty of time. Its 8000-foot mountains on either side rise up almost perpendicularly from below sea level. This makes the working day shorter here than elsewhere. Distance is so extensive that it seems to be beyond space.

Light shining against innumerable eroded ridges and across countless valleys in between is ever changing. A vista that is flat and unimpressive at ten can be startlingly interesting at high noon. A background that stands out in relief at 2 o'clock flattens to blankness at 3. It is impossible to start out in the morning with loaded camera and make a tour of the valley, shooting as you go.

In many parts of the United States, it is safe to figure that scenes toward the east are better in the afternoon and shots toward the west better in the morning. Not so with Death Valley! Your first cue to successful coverage is to make a complete survey of the region to select locations and establish the time of day for shooting. This procedure is doubly important if you are working with Kodachrome. During the first and last part of the day, a panorama before you will change from muddy tones or bright, chalky flatness to a barbaric array of colors as the reflected sun rays light up the multi-colored stratas. A haze that envelops a vista before your camera fades away into crisp clearness as the angle of the light moves around. There are points of vantage from which more than one hundred miles lie between you and the horizon.

Usually a haze envelops the most distant mountains and this is just the kind of haze which cannot be cut satisfactorily with a filter. You have heard of Infra Red film and probably have used it for creating special night effects. The peculiar properties of Infra Red film give you the only known photographic medium with which you can penetrate this one hundred mile haze. Use a 25A filter, stop down to about F.4.5 and an image of the distant mountains will appear on your film that you cannot see with your eyes.

Down in the valley, when you find an interesting formation to shoot, you will be conscious immediately of the absence of soft shaded foregrounds that you are accustomed to in country where grass and trees grow. That bright foreground will steal away the interest from

your composition. In addition, it will tend to flatten your whole scene with a general fog on the film. If you don't have a matte box for your camera, it is advisable to get one for just such problems as this. By bringing the lower mask up across the bottom part of the field of view, the glare will be cut down to a pleasing, graduated shadow. The upper mask can be used to tone down a hazy white sky that a filter will not touch. A graduated filter, deep red on one side, yellow on the opposite, gives you partly the same result, but is not as flexible as the matte.

Watch the quality of the light in the afternoon. Due to invisible, suspended particles of red dust in the air, it fades perceptibly as the sun descends. If you are working with black and white film, be sure to select a location where there is a cross light on your subject. This is the only way that you can get contrast into the scenes as otherwise they are flat. Where your selected location has color, light will give life to the scenes, particularly if the coloring is without much variety.

The best general views of the valley are made from Dante's View, Mahogany Flats and Augueberry Point, while Zabriskie Point is by far the most fascinating eroded area formation. Other points of interest for your camera are Badwater, the lowest spot in the United States; Ubehebe Crater, Artists' Drive, the Sand Dunes, Death Valley Scotty's Castle, Devil's Golf Course, the Charcoal Kilns and the abandoned mining towns.

At Badwater, 279.8 feet below sea level, you can stage a punch shot by showing a party climbing up a steep cliff to reach sea level.

Shoot Artists' Drive in the late afternoon for best

effects either in black and white or color.

The Sand Dunes, from some angles, will look as endless as the Sahara. They can be shot effectively with long shadows in the early morning or late afternoon.

Spring is the season for outstanding shots of desert flowers.

For a bit of wild life, little antelope ground squirrels are found in many places, while quail gather around watered spots.

It's a long way between drinks in the valley and it's a long way between shots, and you must have patience.

Here is a summary of tips for your guidance:

1. Don't try to do the valley in a hurry.

2. Decide on the best time of day before you shoot any point of interest.

3. Use some Infra Red film on distant views.

4. Matte out intense bright foregrounds and hazy skies.

5. For black and white, don't shoot scenic or land formation scenes without shadows.

6. For color shots, be sure to find color contrast or use cross light if contrast of color is not impressive.

Any problem location needs knowledge, patience, and conscientious work to master, but there is no greater satisfaction for the cinematographer than to see the first projection of a difficult job well done.

I've got a problem

• Continued from page 56.

zy or soft in focus. What is my trouble? Does my lens need checking? It's an $f/3.5$ lens in fixed focus mount.

Unless you are trying for ultra-closeups you should have good success in making normal medium closeups with your lens. However, if you try to shoot at distances closer than six feet, you may need to use a portrait or supplemental lens placed over the regular lens of your camera. Such lenses are available for photographing objects as close as six to eight inches. When filming closeups, be sure to keep in mind the advice to J. H. Newcastle, above.

Film Grain (H. Wm. Brown, Kenosha, Wis.)

I hear so much about

"grain" in film. Is there anything I can do in shooting my film to reduce grain or keep it at a minimum?

No. Grain cannot be controlled during filming. In fact, unless you are processing your cine films, you need not worry about the grain bugaboo. Only "fast" emulsion films—those with high Weston ratings—are apt to show any appreciable amount of grain; but where such films are processed by the manufacturer or by their authorized laboratories, fine grain processing reduces this condition to a minimum. If you process your own films, particularly panchromatic, you will of course be wise to use a fine grain formula.

I made mistakes too!

• Continued from page 65.

almost 380-degree swing of my body, film the complete scene!

I didn't have to refer to the instruction book on this one; for I knew that swift panning was never done by

studio cameramen. Panning in a theatrical picture is so slow and the panning action so brief as to be almost unnoticeable. Now, when I feel the urge to pan, I "count ten," remember my earlier



Announcing
The Two New

ANNIVERSARY SPEED GRAPHICS

THESE two new cameras— $3\frac{1}{4} \times 4\frac{1}{4}$ and 4×5 —incorporate many of the features initially introduced in the popular $2\frac{1}{4} \times 3\frac{1}{4}$ Miniature Speed Graphic—plus new and valuable additional advantages. With Kodak $f/4.5$ Anastigmat lens in Compur shutter, each size is \$125. With internally-coupled range finder, encircling bracket, and eyepiece, shown, \$153.50. Examine them at your dealer's.

LOOK AT THESE FEATURES

Greater Strength and Precision

- New all-metal drop-bed, locking rigidly for wide angle shots
- New one-piece metal front standard
- New front standard locking lever
- New positive track lock
- New provision for simplified, protected internal coupling of accessory range finder

Greater Smoothness and Convenience

- New two-piece linked track for pinion focusing of wide angle lenses
- New dual control helical rack and pinion focusing for right-hand and left-hand operation
- New lateral shift as well as vertical shift of lensboard
- New wire frame view finder telescoping into front standard

Better Appearance and Durability

- New use of bright and satin chrome
- New chrome protective band on body front

Graphic and Graflex Cameras are made by
Folmer Graflex Corporation

EASTMAN KODAK COMPANY, ROCHESTER, N. Y.



Films Are Memories That Come to Vivid Life on a RAVEN SCREEN

Every step in movie-making, every appliance that is used in the development of your picture, leads inevitably to the projection on a screen . . . Raven Screens afford a luminous, brilliant and needle-sharp image of your subject. Internationally famous among professional and amateur users for their unsurpassed screen performance, Raven Screens are available in a variety of types, sizes and materials—for every condition and requirement of use.

Investigate the superiority of Raven Screens at your local dealer's or send for Folder 39.

RAVEN SCREEN CORPORATION
314 East 35th Street New York



Ry JUMPY PICTURES

Shoot Every Frame With the
Camera Firmly Supported
by the Famous

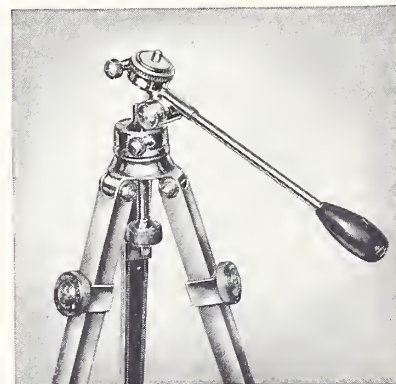

THALMETAL TRIPOD

A handsome, uniquely-styled, metal tripod worthy of the finest camera. The upper leg section is a rigid channel of polished metal, while the lower section is tough black hardwood. It is completely rigidized and fitted with Sure Foot Points. The Precision-built Pan-Tilt Head has full panorama sweeps, Instant-On Plug and is chromium finished. This tripod is outstanding in appearance—in serviceability—in dollar value.

Thalmetal Tripod, complete with Head \$14.00

THALHAMMER
COMPANY
1015 W. Second St. Los Angeles, Calif.

NEW LOW PRICES

GUARANTEED FRESH FILMS

Complete New Reversal and Title Instructions Sent Free; Separately, 25c Each

SUPER CINEPAN REVERSAL

Weston 24-16 — Non-Halation Base

25 ft. Double 8 Not Scored	\$1.10
100 ft. Double 8 Not Scored	3.80
25 ft. Straight 8	.70
100 ft. Straight 8	2.10
100 ft. 16mm	3.35

CINECHROME REVERSAL

Weston 8-2 — Non-Halation Base

25 ft. Double 8 Not Scored	\$.65
100 ft. Double 8 Not Scored	1.85
25 ft. Straight 8	.45
100 ft. Straight 8	1.15

New Super Cinepan and Cinechrome are factory perforated. Will NOT jitter. Fully daylight loading when spooled. Spools and processing extra.

SUPER PANCHRO REVERSAL

Weston 24-16 — Anti-Halo Backing

25 ft. Double 8 Not Scored	\$1.20
100 ft. Double 8 Not Scored	3.90
25 ft. Straight 8	.75
100 ft. Straight 8	2.20
100 ft. 16mm	3.50

Super Panchro is re-perforated. NDT recommended for Keystone or Stewart-Warner 8 Cameras. Works perfectly in all other makes. Fully daylight loading when spooled as colloidal silver backing protects. Spools and processing extra.

WESTON 8 SEMI-ORTHO REVERSAL

Darkroom Loading — Processing Extra

25 ft. Double 8 Scored	\$.50
100 ft. Double 8 Scored	1.50
400 ft. Double 8 Scored	4.50
25 ft. Straight 8	.30
100 ft. Straight 8	1.00
400 ft. Straight 8	2.75
100 ft. 16mm	1.15
400 ft. 16mm	4.00

Clear and lavender, scored. Amber, blue, yellow, re-perforated, NDT scored, NDT recommended for Keystone and Stewart-Warner 8 Cameras. Any film notched upon request. With spliced SUPER-SAFE daylight leaders, 10c per Straight 8 roll; 15c per Double 8 roll; 25c per 16mm roll, extra.

CINE-KODAK POSITIVE TITLE FILM

Darkroom Loading — Processing Extra

25 ft. Double 8 Not Scored	\$.50
100 ft. Double 8 Not Scored	1.35
25 ft. Straight 8	.30
100 ft. Straight 8	.95
100 ft. 16mm	1.10
25 ft. 35mm Safety, Clear or Purple	1.00
100 ft. 35mm Safety, Clear or Purple	3.70
400 ft. Gevaert 16mm and Double 8 Scored	4.00

Clear, purple, yellow, red, amber, special blue. Also lavender and salmon pink not Kodak make.

CAMERA SPOOLS WITH CANS

Double 8	\$.40
Univox	.70
100 ft. 16mm	.65

50 ft. 8 Keystone .40
50 ft. 8 Film .35
Fit all cameras — unlimited quantities.
Extra Cans, 100 ft. and 50 ft. 16mm .10
Extra Cans, Double 8 and Straight 8 .05
400 ft. 16mm Cans, Non-Humidor, .25 ea., 6 for 1.00

Baia Precision 8mm Film Slitters	2.50
Fotofade Dye, per bottle	1.00
Fotofade Wipe-Off Tape, Waterproof	.60
Cin-tints, set of six colors	3.00
DuPont Vicosp Sponges, each	.35
Baia Cine-Transito, Jr., with Fade	5.95
Fade, Wipe or Vignette Disks, each	1.95
Cine-Transito, Jr., Masks, each	.25
Bolex Cinelac, Film Preservative, bottle	1.00
Intensifier, Makes 20 Dz., Long Life	.50
Back Issues Home Movies, 1936-37-38-39, each	.15

(Not all months)
Film Processing: Eastman 8, \$1.00; Other Types, .65; Straight 8, .35; Eastman 16mm, \$2.00; Other Types, \$1.50. Title Developing 16mm, \$1.25 per 100 ft.; Double 8, .75; Straight 8, .40.

A PERSONAL MOVIE SERVICE

Evenings, Sundays, and Holidays, Telephone Lincoln 1207

W. STUART BUSSEY FILM LAB.

17 E. St. Joseph St., Indianapolis, Ind.

experiences, then move my camera with discretion.

My funniest cinefilming experience, though, was when I snatched up my camera in a hurry one day to make a shot of a neighbor's youngster who was just toddling down the front steps and after a pet dog in the yard. Imagine my surprise when this scene was projected, showing the little tot — who could scarcely walk — toddling backwards and up the steps! The laboratory, believing I had purposely filmed the scene this way, reversed the film

and spliced it into the reel in regular order! But this is one mistake I'm glad I made, for if I had not, I probably never would have appreciated the trick effects possible in shooting with my camera upside down.

I recently heard of one amateur who exposed several rolls of film on a vacation trip, with the film threaded into his camera emulsion side away from the lens! I can sympathize with the fellow — I made the same mistake. So now that I'm initiated, move over, fellows! I'm a brother cinebug, too!

as a rule, favor soft background lighting. The camera stop is opened, and a more flat background results. Artistically, perhaps, the soft, uncontrasted background presents an effect not unpleasing to the eye. From the standpoint of production, this method had the advantage of using fewer and cheaper lights, less power, and fewer operators for the lights. The resulting less heat on the stage is an added advantage. Modern practice is demanding more and more depth of field, however.

After "roughing in" the set, the open portions of the backgrounds, such as the windows, arches, doorways, etc., should be backlit. Flat lighting is necessary for backings appearing outside of the windows; streak lighting must be employed for the set visible through doorways.

Vases in wall recesses, enclosed corners or compartments, and furniture, such as divans, which is close to the wall and difficult to light, should have placed behind them small glow-lights, or backlights, of a suitable type, in order to "blow" them out from the background. Care must be exercised in doing this in order that the effect may appear not unnatural.

The relation between lighting for still photography and motion picture photography is very close, and the dividing line between the two is somewhat narrow, if it exists at all. It is possible to get away with a whole lot in still photography because a considerable portion of the creative work is done in the developing and printing. In motion pictures, the creative work is done in the lighting. It would seem that this is the proper place to do it, and that, in conjunction with this attention to the lighting and the use of still frame adjustments to negative and print, still photography will benefit greatly from the application of motion picture lighting technique.

Hollywood's Lighting Secrets

Continued from page 73.

of flatness. Very dark portions of the set should be flooded gently with light in order not to draw undue attention to them by unusual contrasts.

In short, to "rough in" the set, as it is termed, each object and section of the set should be treated as if it were to be an individual picture, and lighted with great care. Yet conformity with the whole must not be overlooked.

The foregoing presents quite a problem where only a few high-power lighting units are used. It becomes apparent that the use of numerous units of lower intensity allows the work of lighting to be done with greater ease and accuracy. These units should have some provision for regulating the light intensity. This may be done in one of two ways: (1) by focusing the light source (moving the light to and from the reflector); (2) by placing transparent diffusing material in front of the light.

In effect lighting, broad, bold usages of light are recommended. Heavy contrast has its place, but calls for a delicate touch. To play safe in lighting of this kind, a judicious amount of general lighting of the flat type is advantageous.

There are two general school's of background light-

ing. One school advocates the use of sharper, more brilliant lights for the background. This allows of a more apparent depth of field in the finished product. However, with 35mm motion picture film, if the laboratory work is not conducted in a very careful manner, the prints resulting from a negative made with this type of lighting are likely to look very grainy and contrasty. This is due to the fact that the laboratory does not have enough latitude in development to take care of the increased exposure. With the faster films and increased lens speeds, stopping down the camera is becoming mandatory. More depth in the picture is the automatic result. This holds true particularly for the backgrounds visible in closeups. Greater detail is possible. Paramount Studio is an exponent of this type of lighting. A very apparent advantage of this lighting method is that the camera may be stopped down because of the increased brilliancy, and a greater depth of field results. It might be of interest to note, none the less, that one of the ace cameramen at this studio uses a generous amount of soft light in his backgrounds.

Metro - Goldwyn - Mayer,

NEW 8-16mm "CINE-SCOPE" POCKET-VIEWER \$1.00

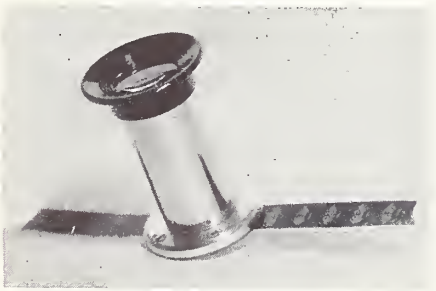

MAGNIFIES OVER 20 TIMES
Optically-ground lenses insure a large, clear-cut image. Adjustable. Film is slipped in, at the side. Groove holds film in position (see photo). A \$3.50 value—GOING FAST at \$1.00.
A REAL NECESSITY—ORDER NOW!
State 8 or 16 mm. Enclose dollar-bill and dime post. (DON'T SEND STAMPS.)
Designed by: **M. LIERSCHER**, Opt. Engr.
157-c, "Moderne" TITLING-SET, \$1.95
3/4 in. high—3/8 in. thick, of cast white DYNAL master. "Third dimension," NO PINS. Regular price, \$4.00 per set. Has letters, figures, etc. 157 nos. Shipped by, exo. (price, approx. 85c). DONT PRINTS SAMPLES—NO STAMPS. FREE!! "Table of sizes" CHART, with ALL orders (while they last). R—\$1. Gives "field-sizes" at various distances.
CAMERA SPECIALTIES
P. O. Box 3182 Hollywood, Calif.

SOLAR ENLARGERS

Perfect prize winning enlargements are easy with a Solar.

Five models from 35mm. to 5x7 in.—with or without condensers—with baseboard or special wall mounting brackets.

Dustless type negative carriers—wide span bellows—micrometric focusing—counter balanced head, plus a host of added refinements, make Solar the choice of amateur and professional alike.

Write for the Solar book on Enlarging. Page after page is loaded with valuable hints and instructions on projection printing. Ask for Enlarging Treatise \$1. It's FREE!

WRITE TODAY

BURKE & JAMES, Inc.

223 W. MADISON ST. • CHICAGO, ILLINOIS



MADE IN U.S.A.

PATS. PEND.

Makes Clear Fine Quality Pictures

Ample Speed For Outdoor Filming

16MM Fans Use AMBERTINT For Outdoor Action Shots

Fine grain, semi-ortho, large latitude—half stop either way—the OUTDOOR sensation film of the 20th century. AMBER tint of film "different" and pleasing. Amazing low price includes machine processing. SHOOT MORE OUTDOOR ACTION FILM AT LESS COST. **\$2.00** 100-ft. roll

California Buyers Include Sales Tax

ORDER DIRECT

AMBERTINT not sold at dealers—order several rolls direct—save money. Not made in 8mm nor sold in bulk.

Write for B'a Free Bulk Film Catalog

HOLLYWOODLAND STUDIOS
SOUTH GATE CALIFORNIA

FINGER MARKS

smudged pictures are unpleasant

VAPORATE

SEALS OUT PERMANENT STAINS FROM ACCIDENTAL FINGERMARKING

AVOID eye straining punishment from SCRATCHES, SPOTS and STAINS. Looking at your pictures should be a pleasure for you and your friends.

Fraction-of-a-cent-per-foot-cost. Better photo finishes offer Vaporate protection for still negatives. Nationwide facilities through your own dealer.

VAPORATE CO., INC. 130 W. 46th St. NEW YORK

BELL & HOWELL CO. 1801 Larchmont CHICAGO 716 No. LaBrea HOLLYWOOD

HARBOR ACTIVITIES

Each Film 400 ft. 16mm silent . . . \$24.00

Subjects: Navigating a Ship Into Harbor, Harbor Safety Measures, Port Commerce, Drydocking Ocean-going Ships, Procedure of United States Customs, Safeguarding Health at the Nation's Gateways, Pacific Coast Fishermen at Sea, etc. Send for Catalogue.

FRITH FILMS Box 565, Hollywood, Calif.

When You Buy BAIA You Buy the Best Precision Made; Guaranteed Perfect

\$2.50

From Your Dealer or Direct

BAIA MOTION PICTURE ENG.
8044 Hardylke, Detroit, Mich.

Movie of the Month

• Continued from page 70.

was done under excellent light conditions. Had the water shots been made with the light from any other angle, all of the beauty inherent in this film would have been lost. Never has this reviewer seen such beautiful color, nor such needle-sharp color photography in any motion picture. The composition of the hunting scenes leaves nothing to be desired.

With the exception of the few instances already referred to, the editing is excellently done—so much so that the picture imparts an illusion of reality mentioned earlier. Each scene is snappily cut—not a frame too much anywhere; and this makes the story move forward in true professional style.

When at last we see the decoys being returned to the boat and the hunters moving toward shore, we realize that a highly entertaining film is about to draw to a close. The boats are moored and the day's bagging of game counted and

divided amid a pastoral setting that would make Rembrandt or Rubeens envious.

Nor does the film's high-lights end here. There is one more—a "honey" of an end title with the words "The End" superimposed over a scene of a covey of ducks rising in an angular line of flight across the scene.

That Nordin is an artist as well as a duck hunter is fully substantiated in this film production. True, his picture has some faults—faults which are easily remedied with shears and splicer; but they are so few and so far overshadowed by the predominance of good points, they are scarcely worth noting except for technical guidance.

Recognition as the Movie of the Month is the second acclaim won by "Whistling Wings." This film but recently won top honors in the Austin Camera Club's 1939 amateur movie contest. It is hardly necessary to predict that still more honors will be heaped upon it—and Cinefilmer Nordin.

"Cines" click in theatres!

• Continued from page 66.

conjecture that had it not been announced as a 16mm film, the majority of those who viewed it would have been unaware they were seeing a 16mm picture.

Furthermore, Manager Smith saw to it that this film made its debut with sound! By means of a public address system, each showing of the picture was accompanied by an interesting commentary. The commentator, Harry Umann, and one of the most enthusiastic champions of 16mm presentations in movie theaters, worked from the projection booth, reading a specially prepared and timed narrative.

Last, but not least, of

those here deserving a bouquet for this advancement of the potential possibilities and popularity of amateur 16mm productions in the theater, is the man who filmed it. He is Johnny Tyler, an advanced and ardent amateur 16mm cameraman. He used a Bell & Howell camera and all the necessary accessories for filming such a huge and colorful pageant as the Rose Parade, including, as stated above, Kodachrome film.

At this writing, another of Tyler's 16mm color productions is being shown at the Regina as a "special added attraction." It is a graphic documentary—really a super news reel

For FINER INDOOR MOVIES...USE THIS LENS



f1.5
CINE VELOSTIGMAT

★WRITE FOR FREE BOOK

WOLLENSAK OPTICAL CO.
505 Hudson Ave. Rochester, N. Y.

WOLLENSAK

8M RAINBOW 16M

The following prices include processing and are for daylight loading films:

	25'	100'
	Double 8mm	16mm
No. 1	1.00	1.85
No. 1 Anti-Halo	1.25	2.15
No. 2 S S Pan Halo	2.00	4.40
No. 3 Pan Halo	1.50	3.50

The following prices are for laboratory packed films without processing:

	100'	100'
	Double 8mm	16mm
No. 1	1.25	1.20
No. 1 Anti-Halo	1.50	1.50
No. 2 S S Pan Halo	3.50	3.50
No. 3 Pan Halo	3.00	3.00

RATINGS: Weston Scheiner

No. 1 Both Types	12-4	20-15
No. 2 S S Pan	50-32	26-23
No. 3 Pan	16-12	21-20

We Pay Postage on All Orders Except C.O.D.

RAINBOW LABORATORIES
STATEN ISLAND, N. Y.

USE METAL LETTERS FOR MAKING TITLES

Ask for Samples of the Most Beautiful Capital and Lower Case Letters Made

...our CRUISE through - The Carribean

Assortment 222 pieces in wood case. \$7.16 postpaid in U. S. Outside add \$1.00. 126 caps and figures in box, \$4.28. Order white or black letters. YOUR FILMS are not COMPLETE until you TITLE them; adding real interest value for you and your friends. P. O. BOX B

Knight & Son, Inc., Seneca Falls, N. Y.

We'll Process PELLEX FILMS

\$1.00 for 100 ft. of 16mm .50c for 25 ft. dbl. 8mm
.75c for 50 ft. of 16mm .01c ft. for straight 8

Price Is for Bulk or Boxed

HOLLYWOODLAND STUDIOS
SOUTH GATE, CALIF.

THE 1 2 3 OF 16 M.M. REVERSAL film

KIN-O-LUX No. 1—An economical high quality film for outdoor use. Renders accurate gradation from black to white, possesses brilliance and wide exposure latitude.

KIN-O-LUX No. 2—An anti-halo film for outdoor use; faster than No. 1.

KIN-O-LUX No. 3—An extremely sensitive panchromatic fine grain film for use indoors or out. Fully sensitive to all colors of the visible spectrum. Compare it in quality with any fast film.

	No. 1 Green Box	No. 2 Red Box	No. 3 Lavender Box
100 ft.	\$3.00	\$3.50	\$6.00
50 ft.	2.00	2.50	3.50

Prices include Scratch-Proofing, Processing and Return Postage. 24-hour return service.

SPEEDS	Scheiner	Weston
No. 1	Day 16°	Day 5
No. 2	18°	12
No. 3	26°	50

WRITE TODAY FOR BOOKLET H-2 GIVING COMPLETE INFORMATION

KIN-O-LUX, INC.

105 West 40th Street
NEW YORK

Congratulations!

are coming in from hundreds of purchasers of the Fotoshop Almanac Catalog. You will congratulate us and yourself when you get a copy of this remarkable book that contains more worth-while photographic information on movie and still methods and materials than was ever before packed between two covers.

Send for a copy today, 25c if you decide to keep it; if not, return it (postage guaranteed). Free with \$2.00 order.

Dept. HM2

18 East 42nd St., N. Y. C.
Branch—136 West 32nd Street

Easy Time Payments can be arranged on Cameras and Equipment.

FOTOSHOP, Inc.

AMERICA'S PROFESSIONAL FILM SERVICE

16MM TITLES

12 WORDS INCLUDING BACKGROUND \$1.00

100 SOUND 50c EXTRA

WORLD'S GREATEST SELECTION
5,000 TITLE BACKGROUNDS

Your movies will be more enjoyable if you use the same deluxe 16 mm. titles and trailers that FILMACK is supplying to thousands of theatres. Smart professional work, either silent or sound. Expert titling, editing, developing and scoring. Send trial order or write for free catalog.

FILMACK LABORATORIES

835 S. Wabash, Chicago, Ill.

50% SAVINGS ON PHOTOFLOODS



\$2.95
POSTPAID

Floodlight bulbs last thousands of hours when used with the GORDON FLOOD-LITE SAVER in the "DIM" position. Gives ample light for preliminary arrangements. Avoids uncomfortable glare and heat. Switch to full intensity only during actual exposure. GORDON FLOOD-LITE SAVER quickly pays for itself. Takes two pairs No. 2's, or two pairs No. 1's, or one pair of each. "OFF-ON" switch gives you complete control. Sent postpaid in U. S. for only \$2.95. Money-back guarantee.

GORDON SPECIALTIES CO.

A. D. — 1104-H So. Wabash Ave. Chicago, U.S.A.

subject — of a recent spectacular oil well fire at El Segundo, Calif.

In the meantime the management of the theater is busy seeking out other 16mm productions for future showings as part of its regular programs. Black or white, in color, either documentary, drama or comedy efforts they may be.

And therewith is the opportunity that presents itself for the inspiration and honor of all 16mm filmmakers who read this. The best films submitted each month in this magazine's "Movie of the Month" competition will be scrutinized carefully, not only by HOME MOVIES' editor-judges but by the managerial staff of the Regina Theater. Each winner of the "Movie of the Month" award will stand the best chance of also winning a professional theater showing, with his or her permission, of course. "The Cauldron," winner of the "Movie of the Month" competition in January, is expected to be given an early showing.

In inaugurating this new policy, it is not the theater management's intent that these amateur film productions shall replace any of their scheduled professional films. They are to be offered as an *added* attraction with the sole purpose of furthering the movement of amateur movies. In order to preserve the amateur stand-

ing of the producers of films thus exhibited, no payment will be made for the use of such films by the theater.

More important to the amateur is the fact that during these amateur film showings, a specially selected committee — including the manager of the Regina Theater — will judge the films and award prizes. There will be awards not only for the producers of the pictures, but also for performances by the cast, where the picture is a dramatic one; and for story treatment, editing, titling, etc. Full account of these awards will be published in HOME MOVIES.

Amateurs desiring to submit their films for "big-time" presentation at the Regina Theater are requested not to ship their films direct to the theater. Instead, all films must first be submitted to the editors of HOME MOVIES, who are working in cooperation with the Regina Theater in its new policy. Films intended for theater exhibition should be shipped — transportation paid both ways — to the Editors of HOME MOVIES.

This sincere venture of the Regina Theater's management to increase the possibilities and prestige of 16mm amateur movies is bound to stimulate the interests of serious amateur movie makers.

Tips on tricks and effects

• Continued from page 78. stick, the exact distance between camera and subject to insure sharpest possible focus.

Another factor, of course, which affects the sharpness of focus is the aperture at which you shoot the scene. Regardless of the established depth of focus of the lens used, the depth of focus is further increased by stopping down the lens diaphragm. Now that faster films are available, you can, with a moderate amount of lighting, shoot most of your scenes at from f/8 to f/16

which should bring out detail of every object in your scene needle-sharp.

To cinefilmmers of several years experience, the foregoing is more or less obvious, but these fundamentals not to be considered lightly are reviewed here for the benefit of those amateurs whose movie-making experiences have been confined more or less to elementary cinefilming. Unless these fundamentals are thoroughly understood, trick shots and special-effect filming will not be successful.

Our cine cameras — just as they come from the factory — are capable of making many of the trick and special-effect shots we yearn for. Those of us planning to make such shots can insure their success by thoroughly studying the mechanism of our camera in order to know what else — in addition to straight shooting — it will do. To some, this may seem trite advice, but I know of several cinebugs, owning cameras blessed with five or six speeds plus a provision for stop-motion filming, who never once have tried these interesting features in the several years they have been shooting home movies.

Many special-effect shots — particularly miniatures — must be filmed at ultra-speed, *i. e.*, at speeds of 24, 32, or 64 frames per second, in order to look fully realistic on the screen. This is particularly true where any objects in the scene must be in motion the movement of which cannot be reduced or minimized in ratio to the reduction of the miniature set, such as water, trees, and grass. No one has yet been able to reduce the consistency of water so that its movement in a miniature scene will appear natural when filmed at standard speed. Therefore, all miniature shots of marine scenes made in the studios of Hollywood are filmed at ultra-speed in order that the movement of the water will appear natural — although in slow motion — on the screen.

Assuming that we now have a rough idea of the characteristics of lenses of various focal length, the angle of view limitations in shooting closeup on miniature sets, and the various effects obtainable through the use of slow motion and ultra-speed photography, we shall be ready to dwell further on this subject of Trick and Effect Shots — the actual construction and filming of same — in the March issue of HOME MOVIES.

Notice To Bulk Film Users

Are you paying excessive premium rates for bulk positive film? The following list is the standard retail schedule on 8mm double perforated and 16mm positive stock, laboratory packing, postpaid:

- DuPONT CLEAR BASE, LAVENDER (DAYLIGHT BLUE), AMBER AND YELLOW:**
 100-foot rolls, each . . . \$1.00
EASTMAN PURPLEHAZE AND INFERNO COLOR BASE:
 100-foot rolls, each . . . \$1.00
 400-foot rolls, Eastman or DuPont . . . 4.00
 100-foot rolls, split into two 100-foot single 8mm sections . . . 1.00
 100-foot rolls, DuPont Sound Recording . . . 1.20

Purchase your movie supplies from the house of fair values, now entering its fifth year of service. Complete literature is available on request.

CINE SHOP

1812 Piedmont Charleston, W. Va.

TITLES MAKE THE PICTURE

. . . and MITTENS PIN LETTERS make superb titles . . . clean-cut plastic letters in a variety of sizes and styles; also decorations.

Complete Sets from \$5.50

MITTENS LETTER CO. Redlands, Calif.

Save ON PHOTOGRAPHIC EQUIPMENT

Write for our **FREE CATALOG** no obligation!

Everything you need for the enjoyment of your camera hobby, "Still" or "Movie."

WRITETODAY!

SUNNY SCHICK
 National Brokers
 403 W. WASHINGTON BLVD.
 FORT WAYNE, INDIANA

MODERNIZE—Trade in Your Equipment!

Kodachrome
MAPS • Charts • FINE TITLES
 Geo. W. Colburn Laboratory
 Special Motion Picture Printing
 1197 Merchandise Mart, Chicago

EQUIPPED to Serve You...
 with a comprehensive line of **CAMERAS & ACCESSORIES**

KLEIN & GOODMAN
 18 S. 10th Street, Philadelphia, Pa.

There's filming in winter too!

• Continued from page 75.
 by is unpacking the Mrs.' bag. My, how the simple touch of comedy and the delightful close-ups improve that vacation picture! It is really surprising how completely different the picture looks as scene after scene is shot and cut in.

"Then there are the Cine Club's winter productions. Each member is shooting all or part of each production, or maybe there is a part of the production you desire to change; hence you call up the cast and arrange for a private shooting on one or two scenes about which you have your own ideas—then compare your results with those of the club's.

"There, too, is your own annual super-super production. How conducive the long winter evenings are to putting that scenario into shooting scrip and getting those interior scenes shot and put in the library to wait for the spring, summer, or fall outdoor shots to complete the production.

"Jack and Alice, Bob and his wife and several other couples are coming over for another of those 'cine' parties and we are going to shoot an impromptu 'quickie' of a shotgun wedding. They certainly enjoyed the last cine party much more than they do the usual bridge party. Heckling the actors in the home 'quickie' is an inexhaustible source of amusement and a good way to obtain those long-to-be

treasured shots of your friends and family. Each production calls for an 'in-cut preview,' and then a 'world premiere' of the production; hence serves nicely for four or five evenings of pleasant entertainment.

"Then there are the usual Christmas, birthday, and 'baby by the fire' shots to be made. Remember that scene of your wife in the flower garden you made on your first roll of film—you have been intending to shoot a scene of her putting the flowers in a vase and arranging them on the table while she waits to greet you home from work for a long time. Well, if you don't get some paper flowers and make that scene and cut it into that old picture, you are surely missing a bet because by adding and changing scenes you actually keep those old pictures alive both to yourself and friends.

"Have you ever tried your hand at table-top photography? If not, you have one of the most interesting and pleasant experiences in store for you. Try your hand on both table top and on animation photography this winter; you will discover a vast field of unlimited possibilities and be surprised to find in the spring that you have shot more footage during the winter season than in any other season of the year."

—E. Moss Brown

Build this 16mm printer

• Continued from Page 79

etc., by the same process as regular printing. Since the printer is built on the continuous principle, film in practically any condition can be printed or copied.

While very simple in design, a printer of this type can give very good results. Threading and operation are very easy; printing can be done at projection speed

and only a few inches of positive are wasted in threading. Hand cranking should be very smooth and even. The exposure slit must not be made too narrow or the variations in electrical current will be recorded on the positive.

Since the motion of the film is continuous, no feed sprockets are required.

Get "Big Studio" Results in your Home Movies . . . with this professional FADE-IN & FADE-OUT and these 6 popular MASKING EFFECTS.

FADETTE combined with **FADE-O-MASK**

now specially priced complete with halder and 3 double masks **\$7.75**

WESCO FADETTE—the only vignetter producing a rectangular fade at ANY desired speed. Gradual Fading—In or Out—Fast or Slow at the will of the operator. NO SUDDEN SHUT OFF. Light weight . . . rugged construction. Fits most all cameras. \$5.95 Comes with cable release and filter holder.

Special adapter for Eastman lenses 75c. When ordering specify make and model of camera.

WESCO FADE-O-MASK—holder of durable tenite, takes the place of filter holder. Attached quickly and easily to the Fadgette. The Wesco Fade-O-Masks of thin flexible pyralin are quickly and easily interchangeable, and give the movie maker on \$250 unlimited range of novel effects. . . .

Ask your dealer for a demonstration

WESTERN MOVIE SUPPLY CO.
 254 SUTTER STREET SAN FRANCISCO

GENERA — FILMS

HIGH QUALITY Motion Picture Films at amazingly low prices—permitting you to shoot more than twice as much footage at less cost, guaranteed. All fresh stock. Order today. Prices postpaid.

PANCHROMATICS	NORMAL	FAST	PAN
100 ft. Single 8mm	\$ 1.90	\$ 1.95	
25 ft. Double 8mm	.90	1.00	
100 ft. Double 8mm	3.25	3.35	
100 ft. 16mm on Spool	1.85	1.95	
100 ft. 16mm on Spool	3.05	3.10	
400 ft. 16mm in Can.	11.75	11.80	

ANTI-HALO — MOVETONE — Weson 12

100 ft. Single 8 for Univex and Keystone	\$1.15
25 ft. Double 8mm "Refil"—not Scored	.60
100 ft. Double 8mm—not Scored	1.95
100 ft. 16mm on Safelight Loading Spool	1.45
400 ft. 16mm, including 400 ft. Reel Can.	4.75

GENERA POSITIVE FILM FOR TITLES

100 ft. Single	\$0.85	100 ft. 16mm	\$1.10
100 ft. Double 8mm	1.35	400 ft. 16mm	4.00

PROFESSIONAL REVERSAL PROCESSING

100 ft. 16mm Ortho	\$1.00	100 ft. 16mm Pan.	\$1.25
25 ft. Dble. 8 Ortho	.50	25 ft. Dble. 8 Pan.	.70

Simplified Processing Outfits including our Prepared Powders: For 30 ft. Single 8. \$3.55, postpaid; Dble. 8 & 16. \$4.95, express collect. Anyone can do it. Send stamp for Film sample, catalog and Bargain List.

FROMADER GENERA COMPANY, Davenport, Ia.

ADHESIVE TITLE LETTERS
 REMOVABLE AND REUSABLE

Will adhere to any clean smooth surface—indoor and outdoor—such as glass, tile, finished wood, metal, photographs, etc. Stylish and fashionable type.

13/16" Gothic (240 letters) . . . \$2.50
 1" Exotic (240 letters) . . . 3.50

8mm SAVE ON FILM 16mm

Save \$8 on Film. Take movies at cost of snapshots. Highest quality film giving full tone gradations—with super speed. Assures perfect picture results. Laboratory packing—Weston 10. Not Positive Film.

100 ft. Double 8mm (200' 8mm)	\$1.25
100 ft. 16mm with Daylight Leaders	\$1.25
100 ft. without daylight leaders	\$1.15
Processing extra - 100 ft. 16mm	.75
25 ft. double 8mm - 50c. 4 rolls 25 ft. double 8mm sent in at one time - \$1.50.	

ACCURATE CINEMA SERVICE
 2609 Morse Ave. Dept. H4 Chicago, Ill.

8mm BULK FILM 16mm

Fine grain. Semi-ortho. Non-halation Weston 8. For titles or reversals. Lab. packed. Free formulas each order. All film guaranteed fresh stock—not re-perforated positive. California buyers include sales tax.

LOAD YOUR OWN AND SAVE MONEY

400 ft. Straight 8mm for Univex, Keystone, etc.	\$3.50
800 ft. 8mm in dbl. 8mm widths for all dbl. 8mm cameras	\$5.00
400 ft. 16mm	\$4.75
SPOOLS:—Univex, 5 for \$1.00 Dble. 8mm, ea. 40c	
50 ft. 16mm, ea. 40c 100 ft. 16mm, ea. 50c	

Write for Big Bulk Film Catalog

HOLLYWOODLAND STUDIOS
 "The West's Greatest Film Mail Order House"
 SOUTH GATE CALIFORNIA

Use THRIFTY

16MM

QUALITY FILM

A Money Saving "Thrifty" Film for Your Every Need

THRIFTY ORTHOTYPE

For OUTDOOR . . . non-halation base, fine grain, fast. Weston 8—the film you've been wanting to find at an unheard of low price. Machine processed. Per 100 ft. rolls. **\$1.60**

THRIFTY PANCHROMATIC	THRIFTY SUPER-PANCHROMATIC
Use for all types of shooting. High-speed Weston 16 daylight—10 photo-floods, machine processed. Per 100 ft. rolls. \$3.75	Super-fast; high sensitivity requiring minimum of light. Weston 50 daylight—32 photo-floods, machine processed. Per 100 ft. rolls. \$4.25

California Buyers Include Sales Tax

10% DISCOUNT IF YOU ORDER ONE ROLL OF EACH OF THE ABOVE FILM AT ONE TIME. Regular cost, \$9.60. Special discount price, \$8.64.

THRIFTY FILMS

Drawer 98, Watts Station Los Angeles, California

DO FILTER FACTORS FLOOR YOU?



...then ask about the new **HARRISON Duraline FILTER SET**—4 Filters, a Holder and Shade to meet 99% of all your requirements. With compact leather case—Easy instructions. New low prices. See them at your dealer today! . . . Or write for folder.

HARRISON & HARRISON
Optical Engineers
8351 SANTA MONICA BLVD. HOLLYWOOD, CALIF.

24-HR. FINISHING GUARANTEED 45c

30 ft. of double 8mm.25c
Genera, Pellex, Etc., Processed
30 ft. single 8mm.15c
30 ft. Univex Standard & U. P.15c

ESO-S PICTURES
Quality 8mm Service
3945 Central Kansas City Mo.

Why Use Anything Else When

TITLES BY PARK CINE

Cost No More Than Ordinary Titles?
Catalog Free on Request

PARK CINE LABORATORY
120 West 41st Street New York

MOGULL'S

at **RADIO CITY**
55 W. 48th Street
New York City

1500 PHOTO-CINE ITEMS

Mogull's BARGAINNEWS, the book to go by, when you go to buy! Time and money savers in every department. Illustrated. A POST CARD BRINGS YOURS! What do YOU need? Trades. Easy monthly terms. Film Rental Library (Sound, silent). Low rates.

Save Dollars with **ONYX FILM**

WESTON SPEED DAY. 8

100 feet 16mm	\$2.60
25 feet double 8mm.	\$1.20
30 feet Univex reload.65 cents

No additional charge for processing. Daylight loading spoils. Immediate service by return mail.

KENWOOD FILMS 1238 E. 46TH ST.
CHICAGO, ILL.

The reader speaks

• Continued from page 58.

"test strip" processing service? There are lots of times when those of us not equipped to do our own processing would like to make a test strip to check for exposure, filter effects, composition, etc.; but in order to do this we have to shoot our test on a full spool of film and are unable to check results until balance of film is used and returned from the processor.

I'd like to see some enterprising firm provide a service for us whereby we could shoot short test shots and get them processed and returned pronto. Perhaps there such firms already among your advertisers who have the facilities but have not as yet exploited this service. Many amateurs would like to hear from them.

— James Rowan

Can I improve my film?

• Continued from page 76.

again he must do the cooking.

Editing: Would suggest breaking up picture into three definite sequences, with titles indicating the division of each—fishing, the scenery jaunt, and then back to fishing. Also, would cut out scene of cat in earlier part of story, as its appearance is irrelevant to the story. Also, tightening scene showing the couple looking at travel folders, inasmuch as the story in the main is about fishing, and the sooner the picture hits the main theme, the more interesting it will become.

Titling: Just a bit loose in wording, jumping from the first to the third person. Subtitles should always be uniform. Last showing of title about "smallest fish" unnecessary, as action in picture explains all title tells.

Photography: Consistent-

Interested in Infra-Red?

If you are, here's your chance to acquire some of the film at reduced cost by pooling purchases with others.

Gentlemen: I would like to get in touch with 16mm movie makers who are interested in experimenting with Infra-Red cine film. As you may know, Eastman makes this film in 100-foot 16mm spools. However, I understanding it can only be purchased in lots of six spools or more and on special order. Six spools are more than I would be able to use, but if I can get in touch with other cinebugs who would take four or more spools, I would like to give this film a try.—Martin Alger, Box 520, Mackinaw City, Mich.

party, sickened by the sight, leave the arena and the men follow. They enter their car and depart for the U.S. The closing shots show the party being stopped at the border for the customary inspection.

Editing: First scene should be cut to fit title which tells about the border guard. The scene of guard should precede the title—or the title should be cut into the middle of this scene. Bullfight scenes should be rearranged to form an orderly continuity of the bullfight, and this should appear in the earlier part of the picture. Scene of little Mexican boy playing guitar could be shortened, as it is purely atmospheric.

Titling: Is good, although a few additional titles would help materially.

Photography: Is good throughout, particularly in the action scenes such as those of the bullfight, where such action is usually hard to follow.

"LITTLE CO-ED" ★★
50-foot 8mm Kodachrome — by A. M.

Continuity: A simple little story that has been packed into 50 feet of 8mm film using as its theme the

ly good throughout. More closeups and semi-closeups would help to relieve long shots.

Highlights: Double exposed titles . . . transition scene showing back of car when leaving mountain and then quick cut to same action of car pulling up to house . . . business of cat waiting for them at door when couple returns . . . high shot of auto in front of house with couple unpacking same.

"BULLFIGHTING IN MEXICO" ★★
400-foot 16mm — by P. R.

Continuity: A car approaches the Mexican border and we see a native guard on duty. A cut to the border city and of the visitors looking over the sights. They attend the Bullfight. We are shown details of this Mexican sport—the baiting and killing of several bul's. Finally, the women in the

• All Amateurs, whether subscribers of HOME MOVIES or not, are invited to submit their films to the editors for review and helpful criticism. Unless otherwise requested, reviews of some of the films which we believe would benefit other amateurs will be published each month.

Reviewed films will be rated one, two, three, and four stars, and films qualifying for two or more stars will receive free, an animated leader indicative of such award. Detailed reviews, with suggestions for improvement—if any—will be mailed to amateurs submitting their films.

Exceptional films qualifying for the distinction of the "Movie of the Month" will be treated in detail in a feature length article in a following issue of HOME MOVIES. In addition, a certificate evidencing the award of "Movie of the Month" and a special animated "Movie of the Month" leader will be returned with such films after review.

When submitting films for review and analysis, please advise make of camera, speed of lens, whether or not tripod was used, or if you used filters, exposure meter, or other accessories. While this information is not essential to obtain analysis of your film, we would like to pass it on for the benefit of other amateurs.

SOLAR FILM

Costs Less!



SPECIAL GET-ACQUAINTED OFFER
 America's foremost economy movie film, Solar Super Outdoor. Ortho, non-halation, wide latitude. Made in U. S. A. Fully guaranteed. Gives clear, sharp, brilliant results. Processing and return postage guaranteed.
 8mm 25 ft. \$2.19 16mm 100 ft. \$4.69
 2 rolls for 2 rolls for
FAST RELIABLE SERVICE—Films received for processing are finished and returned on same day. Our modern laboratories possess every facility to assure top-notch developing of your pictures.
ORDER TODAY DIRECT FROM THIS AD—Films sent C. O. D. when order is accompanied by \$1 deposit. Patrons west of Rockies order from our West Coast Branch, Dept. A2, Box 45, Arlington, California.
DEALERS AND JOBBERS
 Write for interesting exclusive proposition.

SOLAR FILM CO.
 3827 ARCHER AVE. DEPT. A1
 CHICAGO, ILL.
 West Coast Branch, Dept. A2, P. O. Box 45, Arlington, Cal.

GRAPHICHOME BULK MOVIE FILM

FASTER 8mm - 16mm
Movie Film Weston 12
NON-HALATION REVERSIBLE
FINER GRAIN GREATER LATITUDE

Here it is! The NEW GRAPHICHOME PLUS for outdoor or indoor pictures. A top grade ORTHO FILM, FASTER speed, adaptable to any 8mm or 16mm Camera. Takes professional quality shots, clean, clear, sharp!

200' 8mm—GRAPHICHOME PLUS in Double 8 width—Weston 12.....\$1.85
 400' 16mm—GRAPHICHOME PLUS—Weston 12.....\$4.65
 100' Single 8mm—(for Univex)—Weston 12.....\$1.10

GRAPHICHOME REGULAR
 200' 8mm—Daylight Leaders and Trailers.....\$1.75
 400' 16mm—Notched in 100' lengths.....\$4.00

GUARANTEED PROFESSIONAL PROCESSING
 100 ft. 16mm.....85¢ 25 ft. dbl. 8mm.....50¢
 Send today for your GRAPHICHOME Film. All film sent postpaid. If C. O. D., postpaid extra. FREE literature. Write to SUPERIOR BULK FILM COMPANY, Dept. HM2, 188 W. Randolph St., Chicago, Ill.

16MM
DuPont Regular Pan Motion Picture Film
Makes Better Home Movies at Less Cost
 Standard speed, FULL PANCHROMATIC sensitivity, wide latitude, fine grain. Has all qualities of costlier black and white films except extreme speed. Excellent for normal outdoor shooting or indoors with photo-floods. Can be used with filters. Calif. buyers include sales tax. Including Reversal Processing..... 100-ft. roll **\$4.50**

Write for Free Bulk Film Catalogue
HOLLYWOODLAND STUDIOS
 SOUTH GATE CALIFORNIA

Better Movies with BLACK and WHITE FILM

Reversible Film 98¢ Includes 25 ft. Dbl. 8mm Processing Rating Weston 12 Scheiner 18 At your dealer or direct. Fast service processing same day included at no additional cost.

VISUAL INSTR. SUPPLY CO.
 1757 B'way Box H11 B'klyn, N.Y.

SPEND THESE LONG WINTER EVENINGS WITH YOUR FAVORITE HOBBY—TITLE & EDIT YOUR LAST YEAR'S MOVIES
 The Improvement Will Be Worth Many Times Its Cost

CHROMART
 Titles, Title Blanks, Editing
8MM Kodachrome Only 16MM
 Send for Handy-Chart with Samples
 88 Pleasant Street Pawtucket, R. I.

SHOOT THE WHOLE FAMILY! HOME MOVIES—Only 10¢ a Day

Nationally Advertised! 10-Day Trial!
 Entertain with real movies of children, sporting events, trips, etc. Latest model Movie Cameras and Projectors, 8MM and 16MM sizes. For homes, business, churches, schools and clubs. All accessories. Satisfied Customers throughout the World. **NO MONEY BACK 10-DAY TRIAL** on all Cameras and Projectors. **SMALL DOWN PAYMENT, Balance AS LOW AS 10¢ A DAY.** FREE details, write: **DOE ELMER'S HOME MOVIES, 739 BOYLSTON ST., Dept. HM1, BOSTON, MASS.**

preparation of a little girl for school. Opening shot shows a clock with pendulum swinging and indicating a quarter to eight. Then a cut to a little girl of six or seven years in bed. A woman's hand comes into the picture and shakes her. The child awakens and arises. Next we see her washing her hands and brushing her teeth, having her hair curled and eating her breakfast.

As she leaves the house we see her out on the sidewalk asking mother for a nickel, which she receives. She skips off to school, meets other little friends, and all go to store to spend her nickel. The school bell rings, and we are shown the children with licorice-smears faces, and the closing shot shows them running for the school room. It's a clean-cut, simple continuity anyone could make and very well thought out.

Photography: Was consistently good throughout, especially considering that the greater part of it was filmed indoors. Camera was very steady.

Editing: A few simple

cuts and some rearrangement of scenes would help this picture. First shot of clock is too long, and this could be cut into scene of girl sleeping and then back to clock, to use all the footage properly. Scene of wash-hands and of washing teeth is too long. These should be quick flashes, as they merely show activity incidental to the main theme. The scene of the girl skipping to school is a little too long, and we would advise shortening and finishing same with a chemical fade to more clearly indicate a lapse of time between this action and arrival at school.

Titling: Main title very good. Shows little girl holding a card on which the words, "Little Co-Ed" have been lettered in color, and very effective. There are a few well-made subtitles. Novel end title is superimposed over little girl's rear as she swings on trapeze.

Equipment: Bell & Howell model 134-E camera with f/2.5 lens, tripod, exposure meter and remote camera control with foot switch, and auxiliary lens for close-ups.

Movie of the Month

• Each month the Editors of HOME MOVIES select the best picture sent in for analysis and designate it "The Movie of the Month." This movie is given a detailed review and a special leader is awarded the maker.

This award does not affect the eligibility of such films for entry in the annual HOME MOVIES CONTEST. They are automatically entered for rejudging with those films submitted especially for the annual contest. Films awarded the honor of MOVIE OF THE MONTH to date are:

1939
 MARCH: "Today We Die," produced by John Wentworth. A 16mm picture approximately 400 ft. long with musical accompaniment.
 APRIL: "Chicagoland," produced by Theodore Shaw, Chicago, a 16mm picture, approximately 400 ft. long.
 MAY: "Africa," produced by Mrs. Albert Heekin, Cincinnati, 16mm picture approximately 900 ft. long.
 JUNE: "Alaska Cyclorama," produced by R. C. Denny, Fresno, Calif. 16mm picture approximately 800 ft. long.

1940
 JULY: "Behind the Dial," produced by Robert C. Orr, Mt. Kisco, N. Y. 16mm picture approximately 400 ft. long.
 AUGUST: "New England Holiday," produced by Albert Watts, Buffalo, N. Y. 8mm Kodachrome picture, 800 ft.
 SEPTEMBER: "Within the Garden Gates," produced by Murray Beliz, Sacramento, Calif. A 200-ft. 8mm Kodachrome film.
 OCTOBER: "Hummingbirds," filmed by Richard L. Cassell, D.D. S., Los Angeles, Calif. A 16mm Kodachrome film, 400 ft. in length.
 NOVEMBER: "Esquire's Escapade," produced by Clarence M. Aldrich, Long Beach, Calif. A 16mm picture 800 ft. in length.
 DECEMBER: "Souvenir," produced by Harold E. Ramier, Hollywood, Calif. A 100-ft. 8mm Kodachrome film.

1940
 JANUARY: "The Cauldron," produced by Dr. R. E. Gerstenkorn, Beverly Hills, Calif. A 16mm picture 400 ft. in length.
 FEBRUARY: "Whistling Wings," produced by W. H. Nordin, Austin, Minn. A 16mm Kodachrome picture, 400 ft. in length.

PROVE IT TO YOURSELF!

Write for your free 5" x 7" Sample of the BRITELITE-TRUVISION WIDE ANGLE SCREEN FABRIC and Reflection Test Chart.

Whether you like a Box or Tripod Model, we challenge you to find any other SCREEN which will give equal projection quality at all angles... sharper definition. No glare, halation or distortion. Best for black-and-white or color. **NO GREATER COST!**

See the Britelite Line of Screens, Reflectors, Spotlights, Utility Cases, Etc. at your dealer, or write for Catalog and Test Package.

Dept. HM-2. Made in U. S. A.

MOTION PICTURE SCREEN & ACCESSORIES CO., INC.
 351 West 52nd Street, New York City

New FREE CATALOG for better movies

LAFAYETTE CAMERA
 NOW YOU can have all the equipment you need to take expert home movies. For now, with this FREE catalog, you can afford it! It's packed full of nationally advertised home movie cameras and accessories, but prices are remarkably low. And what's more, you can order at home, saving time and trouble. Join the thousands who enjoy the convenience and economy of this complete guide to the buys in home movies. Send a postcard for latest and greatest Lafayette Camera catalog. It's FREE!

CAMERAS SUPPLIES EQUIPMENT

LAFAYETTE CAMERA
 Dept. 808—100 Sixth Ave., New York, N. Y.

A NEW NAME
THE SAME GOOD SERVICE!
 As of February 1, Horne Movie Service becomes Horne Motion Picture Service — at new, larger quarters — 9 East 40th Street.

Editing, Genuine Kodachrome Titles, Tinted and Positive Stock Titles

HORNE MOTION PICTURE SERVICE
 9 East 40th Street New York City

GLASS-BEADED MOVIE SCREENS
Easily Made!

Make your own sparkling beaded screens—at a fraction of their usual cost! Crystal beads can be applied to cloth, cardboard or almost any smooth surface. Complete directions with each pound. (No fractions of pounds sold.)
 Glass Bead to cover 20 sq. ft. (1 lb.), 1 1/2 pound. (No fractions of pounds sold.)
D. GARD, 54 WEST 74TH STREET, NEW YORK CITY

DAYLITE LOADING
 BULK FILM FOR ALL 8mm and 16mm CINE CAMERAS. SPOOLED READY FOR CAMERA USE.
State Make of Camera Please
ESO-S CINEFILMS
 3975 Menlo Los Angeles, California

16mm COLOR MOVIES

For Outright Sale

EUROPEGermany
Switzerland
Czechoslovakia
Hungary
Austria
Italy
Luxembourg
France**BRITISH COLUMBIA
AND ALBERTA**Lake Louise and
Banff
Victoria
Vancouver Island
Vancouver, B. C.**WESTERN U. S. A.**Colorado
Mesa Verde
Grand Canyon, Ariz.
Bryce Canyon, Utah
Lake Tahoe
Yosemite National Park
Los Angeles
Monterey
San Francisco
San Francisco Fair—1939
Yellowstone Nat'l Park
Teton National Forest
Rodeo at Worland, Wyo.
Devils Tower
Black Hills, S. D.

SEND FOR FULL DETAILS on these fine subjects. Beautifully photographed—superbly edited. Every one a valuable addition to your library.

RENTAL SERVICE—Our fine rental library contains over 350,000 ft. of 8mm and 16mm silent and 16mm sound subjects in black and white. Send 5c for film rental catalogue to cover postage. Rental films shipped only within a radius of 500 miles from Chicago.

ZENITH CINEMA SERVICE

5011 N. SAWYER AVE., CHICAGO, ILL.

Fine Movies Since 1924

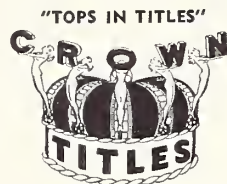
**4**
FOR
\$100

FOR HOME MOVIES 8mm or 16mm

You select from 25 stock backgrounds. Title copy limited to eight words for each title. (Specify 8 or 16 when ordering.)

CROWN STUDIO

1150 La Brea Ave.

Hollywood, Calif.

**SAVE WITH
WHOLESALE'S
AMAZING PRICES**

Keystone 16MM Projector 300 Watt 2" lens	\$22.00
USED 16MM Camera B1 F3-5, GOOD CONDITION	25.00
Keystone 8MM Camera F3-5, used with case	20.00
30x40 Crystal Beaded Screen on Roller	2.95
30x40 DeLuxe Beaded Screen DeLuxe Case Automatic	8.50
DeLuxe Elk Leather Carryall Case	6.00
Canvas Carryall Case Holds All Type Cameras and Accessories	3.50

Complete line of Cameras, Camera Cases, Projectors and Photographic Goods of all types and styles at wholesale prices.

Send for FREE Bargain List

WHOLESALE CAMERA SUPPLY CO.

29 West 34th St. Dept. S-7 New York, N. Y.

**Want a Career
in photography?**

If you are ambitious to become a successful photographer, either for pleasure or career, the N. Y. Institute offers you a thorough, practical training under the personal direction of foremost experts. Commercial, News, Portrait, Advertising, Motion Picture, and Color photography. Personal Attendance and Home Study courses.

Send for Free Booklet

**NEW YORK INSTITUTE
OF PHOTOGRAPHY**

10 West 33rd St. (Dept. 114) New York City

**16MM SEMI-ORTHO
16MM FILM
WES. 8-2
100 FT. SPOOLED \$150**AMBER-GLO—16MM Tinted\$1.75
S. S. PAN—WESTON 50-40—16MM..... 3.75
Above prices include processing. Send for 8MM,
16MM Price List.**AMERICAN FOTOLAB**

Box E, Palms Sta. Los Angeles, Calif.

MOVIE CANDID**CAMERA CASES**

Finest Genuine Top-Grain Cowhide for All Popular Cameras. Postcard Brings FREE Literature.

OUR PRICES WILL SAVE YOU MONEY

Cameracraft Division, 1305 South Union Ave.
Mail Order Only Los Angeles, Calif.**Novel Effects fun to make**

• Continued from page 77.

more blending edge is desired the camera should be thrown out of focus slightly or else some air-brush re-touching should be given figure 4 to soften this hard line.

After these film masks are made, and we recommend that one be printed from the other for best results, they will look like figures 4 and 5. To make the final print, the film mask like figure 4 is placed in the printer together with the calendar strip, and a print made. It would be best to place the calendar strip next to the raw film.

Lastly, take the film mask resembling figure 5 and print it on the same strip of raw film, but with the action shot. When developed, the title is complete. It would also be possible to cut a mask out of black paper and shoot the action scene through this hole. Of course care must be taken to see that the paper is lined up properly and that the hole will produce an image in the

right proportion on the film. (Scene and calendar will be reversed in this procedure, however. Copying the original calendar shot through the shiny side of the film will correct this, as will making a print of a negative calendar shot.)

It is possible to make a variety of effects with figures 2 or 3. For instance, when copying figure 4, the worker could cause it to fade in, or come in piecemeal. When the corresponding film mask is made (by contact printing only), it will be the exact complement to the first. When these are used in the printer in making the final print, care must be taken to see that film mask No. 5 begins exactly where film mask No. 4 did. This can be done by punching a hole in the edge of both masks, and the raw film which is to receive the printing. By starting both masks at the identical spot, no trouble should be experienced.

With the procedure out-

Backyard Movies

• Continued from page 60.

dashes out of scene.

Scene 13. Husband reappears wearing his own hat. Hurriedly kisses wife goodbye, waves to the baby and dashes out the door.

Title: "A Few Minutes Later."

Scene 14. Husband comes back into the house with a disgusted look on his face. He throws his hat on the floor and tears his hair.

Scene 15. Wife and baby look on in surprise.

Scene 16. Husband walks toward wall where calendar is hanging, and points toward same with his index finger, saying at the same time:

Title: "Why Didn't You Tell Me Today is Sunday?"

Scene 17. View of the family laughing. Fade out.

THE END

— T. W. Newberry

Sideshow Shots

If you have some shots of the circus, the sideshow posters, etc., among your reels of unedited film, here is an idea that will enable you to put them to use. Otherwise you can still use this idea of shooting the necessary atmospheric shots the next time the circus is in town.

The necessary starting material will be individual shots of the various sideshow banners illustrating the Fat Lady, the Living Skeleton, the Fire-eater and others. Also, tie-in shots of

lined above, it is possible to have scenes wipe with titles in hundreds of ways. These help "tie in" the thought of the title with the following scene. In figure 3, for instance, if the month of January should flash on the screen first with one of the days encircled, then the head of the baby should slowly fade in with a cute little smile on his face. Nothing more would be needed to tell us it was his birthday.

Besides the circle, such designs which are equally effective are hearts, diamonds, keyholes, squares, ovals, triangles, etc. By doing a bit of animation work when the original film mask is made, these designs can be made to change shape or size, and can be eventually made to wipe off the screen entirely, thus permitting the action scene to continue indefinitely.

These are but a few of the possibilities which are obtainable with this film mask process. It is easy to link your titles with the ensuing shots, and the flow of continuity will have been strengthened. They're fun to watch and fun to make. Try it.

the sideshow barker and the ticket sellers.

Open your story with a shot of the barker, followed

• We want suggestions and ideas for random "backyard" filming; also for simple home movie scenarios. Those which are published will bring the contributors either a 100-ft. 16mm or a 50-ft. 8mm film subject selected from the advertisements or catalogues of any library or producer-advertiser in HOME MOVIES magazine.

For ideas that can be adopted to a feature length article we will reward the contributor with two rolls of panchromatic film. Address your suggestions to BACKYARD MOVIES, care of HOME MOVIES, 6060 Sunset Boulevard, Hollywood, Calif.

For Further Information

—catalogs, literature, etc., on products or services advertised in this issue, just mail coupon below and HOME MOVIES will promptly forward your request to the proper address. Numbers on coupon correspond to key numbers opposite advertisers' names listed here. Simply circle number on coupon corresponding to advertiser in whose products you are interested. Use penny post card for your request if you do not wish to clip coupon.

Key	Advertiser	Page	Key	Advertiser	Page
1	Accurate Cinema Service.....	93	39	J. C. Haile & Sons.....	88
2	Agfa Ansco Corp.....	63	40	Harrison & Harrison.....	94
3	Albert Specialty Co.....	87	41	Hollywoodland Studios.....	91
4	Ampro Corp.....	61	42	Hollywood Film Enterprises.....	52
5	American Bolex Corp.....	59	43	Horne Motion Picture Service.....	95
6	American Fotolab.....	96	44	M. R. Hughson.....	97
7	Baia Engineering Co.....	91	45	Ideal Pictures Corp.....	58
8	Bass Camera Co.....	97	46	Kenwood Films.....	94
9	Bell & Howell.....	101	47	Kin-O-Lux.....	92
10	Besbee Products Corp.....	56	48	Klein & Goodman.....	93
11	Burke & James, Inc.....	91	49	Knight & Son, Inc.....	91
12	W. Stuart Bussey.....	90	50	Lafayette Camera Division.....	95
13	Cameracraft Division.....	96	51	51 MacVan Mfg. Co.....	97
14	Camera Specialties.....	90	52	Mogull's.....	94
15	Castle Films.....	55	53	Motion Pict. Screen & Access.....	95
16	Central Camera Co.....	97	54	Nat'l Cinema Service.....	97
17	Chromart.....	95	55	N. Y. Inst. of Photography.....	93
18	Cine Shop.....	93	56	Park Cine Labs.....	94
19	Geo. W. Colburn.....	93	57	Peerless of Hollywood.....	88
20	Commercial Metal Products.....	60	58	Point Loma Movie Supply.....	97
21	Craig Movie Supply.....	62	59	Rainbow Labs.....	91
22	Crown Studios.....	96	60	Raven Screen Co.....	89
23	Da-Lite Screen Co.....	57	61	Sensational Pictures.....	97
24	DeJur-Amsco Corp.....	97	62	Seemanns, Inc.....	87
25	Dye Research Labs.....	97	63	Solar Film Co.....	95
26	Eastman Kodak Co.....	89	64	Stein Studios.....	97
27	Don Elder's Home Movies.....	95	65	Sunny Schick.....	93
28	Eso-S Cinefilms.....	94	66	Superior Bulk Film Co.....	93
29	Filmack Labs.....	92	67	Thrifty Films.....	94
30	Fotoshop.....	92	68	Thalhammer Co.....	89
31	Frith Films.....	91	69	Vaporate, Inc.....	91
32	Fromader Genera Co.....	93	70	Visual Instr. Supply Co.....	95
33	D. Gard.....	95	71	Western Movie Supply.....	93
34	General Cine Service.....	92	72	Wholesale Camera Supply.....	96
35	General Electric Co.....	60	73	Willoughbys.....	56
36	Gavaert Co. of America.....	58	74	Wollensak Optical Co.....	91
37	C. P. Goerz.....	60	75	Wonderlite Co.....	97
38	Gordon Specialties.....	92	76	Zenith Cinema Service.....	96

Readers Service Department
Home Movies Magazine
6060 Sunset Boulevard
Hollywood, Calif.

Gentlemen:

Will you please forward my request for catalogs and other literature issued by the advertisers whose key numbers I have circled below:

1	2	3	4	5	6	7	8	9	10	11	12	13	14	15	16	17	18	19	20
21	22	23	24	25	26	27	28	29	30	31	32	33	34	35	36	37	38	39	40
41	42	43	44	45	46	47	48	49	50	51	52	53	54	55	57	58	59	60	
61	62	63	64	65	66	67	68	69	70	71	72	73	74	75	76				

Name.....

Address.....

City..... State.....

Title Troubles

• Continued from page 62.

white sheet of paper. As you no doubt know, the latitude of positive film is not great, thus when you reach the point in closing your shutter where the latitude drops the quickest, your exposure also is affected in proportion. Then when you fade in again on the white sheet of paper, the same thing happens, only in the reverse

order, so that as the title suddenly starts to be underexposed, the white paper causes the overexposure, resulting in the effect you describe. All I can suggest is to operate the shutter lever more slowly between the 1/4 open and 1/2 open positions, speeding up as you approach the closed and open ends.

It's New to Me!

• Continued from page 80.

the new Wabash Exposure Guide that has just come off the press. In 16 pages, this little pocket guide lists all popular roll films, film packs, miniature films and cut films, with complete exposure tables on their use with any camera. A special page is devoted to flash with focal plane cameras of either the miniature types or the large 4x5" Speed Graphic or Graflex focal plane camera. All popular home movie films with exposure tables are also listed. Write for your complimentary copy to Wabash Photolamp Corp., Brooklyn, N. Y.

Each splicer is provided with a generous bottle of the famous Seemann "Weld-Tite" film cement, according to the manufacturer.

Spotlight Data

The Lafayette Camera division of Radio Wire Television Inc. is offering to amateurs, without cost or obligation, a brochure which outlines the advantages of the spot light. This brochure also discusses the requirements one should look for in selecting such a light source and then goes on to describe the new Lafayette "Hi-Lite" Spot, a lightweight unit not much bigger than a man's fist but providing the effectiveness of a standard, fully adjustable 500-watt spot plus many refinements not found in any but the higher priced professional equipment. Copies of this treatise can be obtained by addressing a request to Lafayette headquarters at 100 Sixth Avenue, New York City.

Seemann Splicer Improved

Keeping apace with the demands of home movie makers in all branches of the art, Seemanns, Inc., manufacturers of the popular priced Seemann Splicer, announce another improvement on this valuable accessory that facilitates splicing 16mm sound as well as silent film. The Seemann Splicer makes a quick, dry splice on either 8mm or 16mm films.

Experimental Workshop

• Continued from page 83.

small drop of solder at end. When nailhead is released the spring action should hold the clock firmly against the block.

To mark the footage on the dial or the side of the block, measure distances on ground at intervals of from 3 to 25 or

50 feet away. Sight these marks through the range finder, pressing the nailhead and then releasing, and marking the distance on the dial with ink. Repeat this procedure until all footage marks have been indicated on the dial.

—Samuel Kohn.

ORDER FOR SUBSCRIPTION

Home Movies Magazine

12 MONTHS FOR \$2.00 IN U. S.

In Canada, \$2.00; Foreign—\$3.00

SPECIAL OFFER: 3 Years for \$5.00 in the U. S.

HOME MOVIES

Sunset Blvd.
Hollywood, Calif.



Send to.....

Address

City..... State.....

New Renewal Gift

Send to.....

Address

City..... State.....

New Renewal Gift



Enclosed find \$..... Date..... 19.....

Sent in by

Address

City..... State.....

NO SUBSCRIPTIONS ACCEPTED FOR LESS THAN ONE YEAR





Every good shot deserves CINÉ-KODAK FILM



YOU select the scenes you shoot with care; you make the exposures expertly. You have the right to expect results that will do justice to your subjects and to yourself as a cinematographer.

Naturally, you use Ciné-Kodak Film. It is uniformly reliable, completely responsive to your skill. There are five 16 mm. emulsions, four in the 8 mm. size. Whatever the work you have to do, there's a Ciné-Kodak Film to do it—and do it beautifully.

16 MM. KODACHROME—For color, of course, Kodachrome's the film. In two types, one for daylight use and Type A for use with Photo-flood light; both are the same price. 200-ft. rolls (from Rochester only), \$16; 100-ft. rolls, \$8; 50-ft. rolls, \$4.30; 50-ft. magazines or packettes, \$4.65.

16 MM. SUPER-XX—Top speed, plus photographic quality. 200-ft. rolls (from Rochester only), \$13.50; 100-ft. rolls, \$6.75; 50-ft. rolls, \$3.75. 50-ft. magazines, \$4.

16 MM. SUPER-X—A real achievement in film making. It combines adequate speed for most shots, with remarkable brilliance, clarity, and fine grain. 200-ft. rolls (from Rochester only), \$12; 100-ft. rolls, \$6; 50-ft. rolls, \$3.25; 50-ft. magazines, \$3.50.

16 MM. SAFETY "PAN"—A low-cost film of remarkable quality, generally reserved for use

when the special characteristics of the other emulsions are not required. Ciné-Kodak Safety "Pan" is supplied in 100-ft. rolls only, at \$4.50.

8 MM. KODACHROME—Kodachrome has taken command in the 8 mm. field, too. The practically grainless Kodachrome image projects beautifully on even the larger screens. Both the regular (daylight) and Type A emulsions are available at \$3.40 per 25-ft. roll.

8 MM. SUPER-X—This is the black-and-white speed film for all 8 mm. work by artificial light or in poor outdoor light. Remarkably fine in grain, too. An immensely useful and popular film. In 25-ft. rolls, \$2.25.

8 MM. "PAN"—This is the famous film which made 8 mm. movie making first possible, then popular. It is a film of tremendous latitude; its speed is adequate for most movie-making opportunities. In 25-ft. rolls, \$2.

EASTMAN KODAK COMPANY, ROCHESTER, N. Y.

Play Safe with Films You Treasure

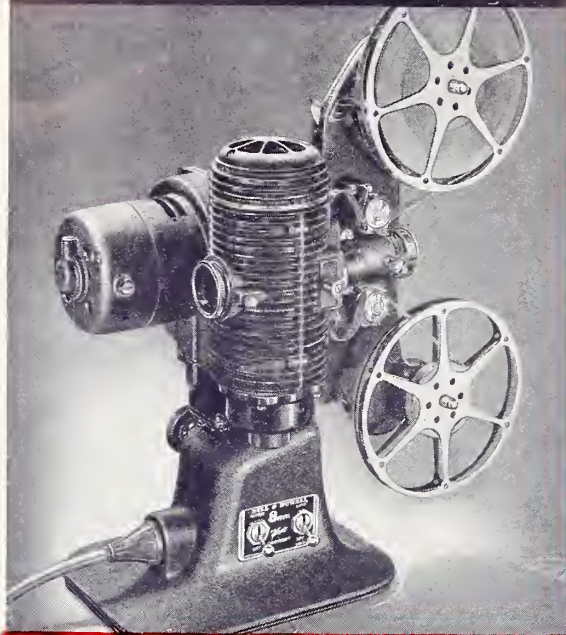

"THANKS TO FILMO,
OUR ADOLESCENTS'
BABY FILMS
ARE STILL IN FINE
CONDITION!"



New Filmo-Master 16 mm. Projector

You can buy no finer moderately priced 16 mm. silent projector than this new Filmo-Master. It includes de luxe features heretofore found only in higher-priced Filmos. It is completely gear-driven and has a speedy power rewind. Brilliant pictures in home or small auditorium are assured by its 750-watt lamp, fast two-inch F 1.6 lens, and Magnilite condenser. With case \$139. Mail coupon.

... SHOW THEM WITH A

Filmo

JUST one passage through an inadequate projector could ruin your most treasured films. No saving in projector price can justify your taking that chance with films that can't be replaced. At the lowest prices in their history, Bell & Howell Filmo Projectors now offer more advantages than ever before, including this complete film protection:

"FLOATING FILM"—at no point does the picture area of your film touch any stationary part. Filmo can't scratch!

NO "SAWING" ACTION—shuttle tooth moves in a rectangular path—straight in, down, and straight out—thus minimizing wear on perforations.

NO JERKING—thanks to positive gear drive and correctly accelerated shuttle.

STRAIGHT LINE FILM TRAVEL—film is not twisted at any point!

Besides film protection, a Filmo Projector also gives uniformly brilliant, flickerless, rock-steady screen pictures. Filmo's scientific design and precise construction assure lasting, dependable service. Write today. Bell & Howell Company, Chicago; New York, Hollywood, London. Established 1907.

New!

Filmo-Master 8 mm. Projector

The Filmo 8 mm. Projector now appears in the new, improved model pictured above. Retained is the basic design which made Filmo the finest of 8 mm. projectors. Added are an improved film moving mechanism, lens focus lock, new two-way tilt, radio interference eliminator, and a threaded socket so that your tripod may be used as a projector stand. Line current and lamp switches are side by side on the cabinet base. The new Filmo-Master 8 is fully gear-driven—no chains or belts inside or out. Uses 400- or 500-watt lamp. Has fast F 1.6 lens. No increase in price—still \$118, case included.



FOR BETTER MOVIES
USE A *Filmo* CAMERA

PALM-SIZE FILMO 8

Only \$49⁵⁰

Filmo 8 is scarcely larger than the palm of your hand and weighs only 24 ounces. It makes movies at snapshot cost; makes color movies, too, indoors and out, even in slow motion. Has single frame device, viewfinder masks for use with telephoto lenses, and can be equipped with film rewinding device for making lap dissolves and double exposures!

With F 3.5 lens, speeds 8, 16, 24, 32, only \$49.50.

With F 2.5 lens, speeds 16 to 64, only \$75.

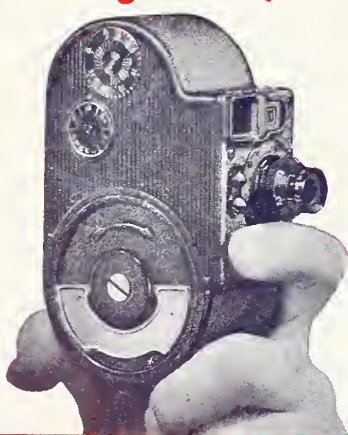

NEW 16 MM. FILMO 141 Eliminates Threading of Film—Permits Mid-reel Changes from Color to Black-and-white Film

Ideal for both beginner and advanced worker. Loads with pre-threaded film magazine. Easy to use, yet designed to keep pace with your cinematic progress. Has four operating speeds including s-l-o-w motion if desired, single-frame exposure control for making animated titles and cartoons, and starting button lock. "Positive" finder eliminates off-center pictures. Lens is instantly interchangeable with telephoto, wide-angle, and speed lenses. With 1-inch F 2.7 lens...\$115.



FREE FILM OFFER! "How Motion Pictures Move and Talk," a new film produced by Bell & Howell, traces the making of a modern Hollywood sound movie from the raw film to the finished picture. You can borrow a print, either sound or silent, for a group showing. No charge. Mail coupon.

See Your Filmo Movie Dealer for demonstration and information about easy time payments. Or mail coupon for full details.

BELL & HOWELL COMPANY HM-2-40
1825 Larchmont Ave., Chicago, Illinois
Please send details on () new Filmo 8 mm. Projector; () 16 mm. Projector; () palm-size Filmo 8 Camera; () new 141.
() I'd like to show a sound silent 16 mm. print of the film "How Motion Pictures Move and Talk."

before.....
(size and nature of group)
on..... OF.....
(date) (alternate date)
Name.....
Address.....
City.....State.....

PRECISION-MADE BY

BELL & HOWELL

Price 25c

HOME MOVIES



Universal Pictures Photo

March • 1940

Hollywood's Magazine for the Amateur

**3
NEW
Hollywood
Home Movie
Films!**



MOVIE STARS' GOLF GAME

Bing Crosby and Paulette Goddard challenge Bob Hope and Ruby Keeler in a charity benefit golf game. This film shows the stars in action on greens and fairways and contains fine closeups of all during presentation of the trophy. In ordering, specify No. 624-A.

8mm: 50-ft. — \$1.25
16mm: 100-ft. — 2.50



OUR NAVY

Our nation's mammoth defenders in action on the high seas! Shows battleships in fighting formation, firing broadside after broadside; loying smoke screens; and close-ups of gun crews in action. Also shows high speed destroyers maneuvering with the Navy's air force. A timely, thrilling film. Specify No. 137-A.

8mm: 50-ft. — \$1.00
16mm: 100-ft. — 2.00



CAMERA THRILLS

Hollywood's daring movie stunt men in action crashing cars, and stunting on horses, motorcycles, etc. Thrilling scenes taken at a recent field day exhibition put on by the men and women who put the punch in Hollywood's movie thrillers! Specify No. 1071-A.

8mm: 50-ft. — \$1.25
16mm: 100-ft. — 2.50

*These
Hollywood
8mm and 16mm
Home Movies are
"Screen-Tested,"
assuring perfect
prints . . .*

. . . your dealer will be glad to screen these films for you. See these and other news, comedy, drama, and cartoon films from the studios of Hollywood's largest producer of home movie films.

HOLLYWOOD FILM ENTERPRISES, INC.
6060 SUNSET BLVD. • • HOLLYWOOD, CALIF

**WRITE
FOR
FREE
CATALOG**



Home Movies

MAGAZINE



**Subscription
Order Form**



MAR 27 1940

©CIB 449232

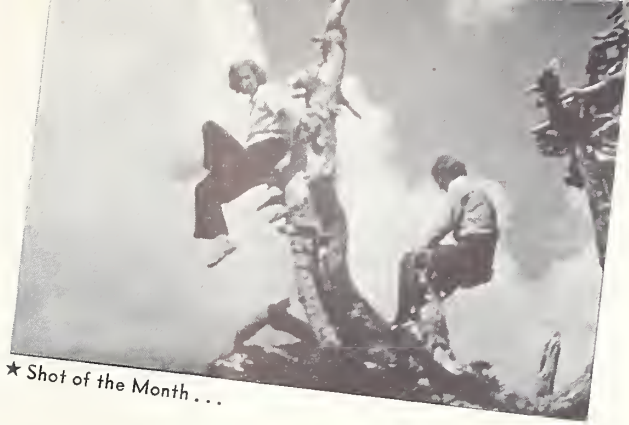

★ Shot of the Month...

home MOVIES

Copyright 1940 by Ver Halen Publications. No part of magazine may be reprinted without specific permission.

CONTENTS FOR MARCH, 1940

I'VE GOT A PROBLEM.....	105
THE READER SPEAKS.....	108
CINE QUIZ.....	108
BACKYARD MOVIES.....	110
TITLE TROUBLES.....	112
<i>By George W. Cushman</i>	
WATCH YOUR FRAMING FOR BETTER COMPOSITION —	
<i>By Melvin Swansick and Dr. C. E. Smith.....</i>	115
AMATEUR'S LOCAL NEWSREEL MAKES GOOD.....	116
<i>By Curtis Randall</i>	
TRY THESE TRICK SHOTS WITH YOUR CAMERA..	
<i>By E. M. Liebscher.....</i>	118
TABLE-TOP MOVIES WITH HAND-MADE CAST OF	
CHARACTERS.....	120
<i>By G. P. Kreutzer</i>	
CONFESSIONS OF A CINEBUG'S WIFE.....	122
<i>By LaNelle Fosholdt</i>	
"OOMPH" LIGHTING FOR SMALL GROUPS.....	124
<i>By R. E. Worstel</i>	
YOU FILMED IT—NOW RECORD IT!.....	125
<i>By Jack Irwin</i>	
NEGATIVE-POSITIVE DEVELOPING KIT EASILY	
BUILT.....	126
<i>By Walter W. Light</i>	
SIMPLE METHODS FOR CENTERING TITLES... <i>By Geo. W. Cushman</i>	127
MOVIE OF THE MONTH.....	128
<i>J. H. Schoen</i>	
TELL ME—HOW CAN I IMPROVE MY FILM?.....	129
<i>By The Editors</i>	
EXPERIMENTAL CINE WORKSHOP.....	130-131
IT'S NEW TO ME.....	132
EXPOSURE METER GUIDE.....	146
DIRECTORY OF AMATEUR CINE CLUBS.....	150
TITLE BACKGROUNDS.....	153
<i>By Edmund Turner</i>	

MARCH
1940
NUMBER 3
VOLUME VII



★ Shot of the Month — Reproduced from Milton L. Dean's 16mm Kodachrome film, "Alaska." Selected for its excellent composition.

CHAS. J. Ver HALEN
PUBLISHER

C. J. Ver HALEN, JR.
ASSOCIATE PUBLISHER

ARTHUR E. GAVIN
EDITOR

RAY FERNSTROM
TECHNICAL EDITOR

GEORGE W. CUSHMAN
R. E. MERVILLE
J. H. SCHOEN
ASSOCIATE EDITORS

COUNT H. C. A. von SCHOENFELDT
PHOTOGRAPHIC EDITOR

C. E. BELL
ASSOCIATE PHOTO EDITOR

L. C. BUSCHER
ART DIRECTOR

OFFICE OF PUBLICATION
6060 Sunset Boulevard, Los Angeles, Calif.
Phone GRanite 6414

NEW YORK OFFICE
Everett Gellert, 62 West 45th Street
Vanderbilt 6-5254

CHICAGO OFFICE
C. N. Burris, 362 Wrigley Building
Whitehall 7784

HOLLYWOOD'S MAGAZINE FOR THE AMATEUR

ADVISORY EDITORS

W. B. GRIFFITH
Sunkist Movie Club

HUR E GIBBS
Portland Cine Club

S. DVORAK
Suburban Amateur Movie Club

TIN P. WALSH
St. Louis Amateur Movie Club

A. HOOK
Seattle 8mm Club

N W. MULLISON
Amateur Cinema Club of Norristown

MERSON CLYMA
Detroit Society of Cinematographers

SISSEL
Austin Movie Club

HEO. ROTH
Sherman Clay Movie Club

E. SNYDER
Des Moines Y. M. C. A. Movie Club

C. ENION SMITH
Metro Movie Club of Chicago

TUART BUSSEY
Super-Art Movie Club

KLIN SKEELE
Los Angeles Cinema Club

RGE DURAND
3H Camera Club (Movie Division)

D. LEMON
Boise Camera Club

HARD D. ELLIOTT
Tacoma Movie Club

ROSS BROWN
Dallas Cinema Club

R BEZEK
Chicago Cinema Club

GRANZOW
Greater Oakland Cinema Club

EPH H. GAWLER
Washington 8mm Movie Club

WIN SWANSICK
Bay Empire 8mm Club

ES GENDERS
Indianapolis Movie Club

SELL A. DIXON
Pittsburgh Amateur Cinema Club

as Second-Class Matter, May 6, 1938, at
postoffice at Los Angeles, California, under
the Act of March 3, 1879.

Subscription rates—U. S. \$2.00 a year. Canada
\$2.50 a year. Foreign \$2.50 a year. Single copies
foreign single copies 35c. Copyright, 1940,
Ver Halen Publications. Advertising Rates on
Application.

**IT'S A
SUPER COLOSSAL
PRODUCTION**

when EDITED with
CRAIG FINE EDITING EQUIPMENT

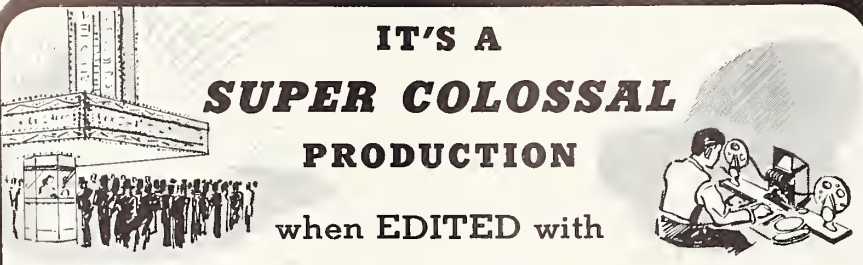

CRAIG 16MM SENIOR SPLICER

Operates in the professional manner... only four easy operations needed to make perfect, straight splices—quickly, accurately, and without wetting the film.

For Sound or Silent film . . . \$10.00

New Junior Splicer—adaptable to 8 or 16mm film \$2.50



CRAIG PROJECTO-EDITOR

Action-edit your movies the Hollywood Studio way—transform random "shots" into interesting continuities that everyone will enjoy seeing. The Projecto-Editor provides a unique viewing method—allows careful inspection, slow motion if desired, of actual movement on its brilliant miniature screen. Complete with Splicer, Rewinds, and film cement. 8mm model . \$27.50
16mm model . \$49.50



CRAIG SPLICER AND REWIND COMBINATION

A complete editing and repair outfit. Essential equipment for all cinematographers.

8mm model with Junior Splicer and Rewinds \$7.25

16mm model with Senior Splicer and Rewinds for sound or silent films \$19.50

With extension bases for 1600-foot reels \$22.00



**BUY WITH CONFIDENCE—USE WITH SATISFACTION
AT ALL DEALERS**

CRAIG MOVIE SUPPLY CO.

1053 S. OLIVE STREET 149 NEW MONTGOMERY ST.
LOS ANGELES, CALIF. SAN FRANCISCO, CALIF.

I've Got a PROBLEM

Brown Stain (Hugh L. Beery, Jr., Memphis, Tenn.)

In processing my films by the home reversal method, I have been getting pretty fair results except for one thing—I notice that the darker areas, instead of being a cold, blue-black tone, are dark brown. What is the cause of this and how may I correct it?

Ans. There are several causes for the condition you complain of in your home processed films. The most prevalent cause is lack of sufficient washing after the bleaching process. Another probable cause is that your chemicals may be too weak. Try more thorough washing and fresh chemicals in your formulas.

Binocular-Tele-lens (J. Conarty, Flushing, Mich.)

In using a pair of binoculars as a telephoto lens, how are the binoculars focused? Should they be opened out full length, or first focused to the eye before placing before the camera lens?

Ans. The binoculars should first be focused on the scene and then placed before the camera lens, which should be set at infinity, if same is in focusing mount. Lenses in fixed-focus or "universal" mount require no setting other than for exposure. There is an item on use of binoculars for telephoto shots in the Experimental Cine Workshop section of this issue.

Frame Lines (August Francesconi, Sacramento, Calif.)

I recently made a shot to project in reverse action by inverting my 8mm camera. On editing the scene, I cut it out and turned it end for end before splicing. Upon projecting it, I find that the frame lines appear on the screen for the length of the scene only; in other words, they are not "in tune" with the frame lines of the rest of my film, although shot with the same camera. Can you explain this?

Ans. The reason for this is that your camera does not provide for the frame line to occur at the exact center of a sprocket hole. If it did, you would not have this

• READERS: This department is for your benefit. Send in your problems and our technical board of professional cameramen will answer your question in these columns. If an answer by mail is desired, enclose addressed stamped envelope.

trouble. The only thing you can do is to re-frame this scene each time during projection.

Lighting the Baby (Mike Benjamin, Chicago, Ill.)

I have an 8mm camera with an f/1.9 lens. Recently I made some movies of a new born baby. Although I used a No. 2 Photoflood for the light source and a bright tin near the camera for a reflector, the pictures are under-exposed. My chief problem was to get sufficient light into the scene and yet not hurt the baby's eyes. I used Super X film.

Ans. We appreciate that you must be extremely careful with bright lights around a new born infant. Best photographic results may be had with diffused light in sufficient quantity. Two No. 2 photofloods with gauze, oiled silk or tracing

• Continued on page 149

Whatsa

AUXILIARY LENS

• An auxiliary lens, also known as a supplemental lens or portrait lens is one used in conjunction with the regular camera lens to facilitate filming closer to a subject than provided by the camera lens alone. In cinefilming it is regularly used in shooting titles at close range, i. e., at a distance of but eight or ten inches, or in making ultra-closeups of flowers, insects, etc. Rightly used, it is held in place no greater than 1 inch from the camera lens, and accurately centered. Camera lens should be focused at infinity, whenever an auxiliary lens is added. Lenses in universal or "fixed focus" mount require no adjustment. The lenses from inexpensive reading spectacles, obtainable at the 5 and 10 cent stores, make satisfactory auxiliary lenses. Their diopter rating (focusing range) and sometimes their actual focusing distance is usually indicated on the lens.

Announcing VOICE TITLES

for SILENT FILMS



8 mm or 16 mm
HIGH FIDELITY RECORDING
INEXPENSIVE
EASY TO OPERATE
 with ANY PROJECTOR

The NEW Voca-TITLER

ADDS PEP
 TO YOUR MOVIES

MAKES TITLING
 EXCITING

MAKES SOUND TITLES
 COST MUCH LESS

The Complete
Voca-TITLER
 IS A
RECORDER

DIRECT
 RADIO
 RECORDER

PHONOGRAPH

RADIO
 LOUDSPEAKER

RADIO
 RECEIVER

THIS is the first and only inexpensive means by which narrated titles with your own voice and sound effects may be easily adapted to 8 mm and 16 mm silent film. While the sound is not synchronized with projection, it is accurately timed with the scenes so that *spoken* titles and sounds are produced at exactly the proper moment—just like the narrative of the professional news reel. The operation of the *Voca-TITLER* is simple. Very small notches are cut at points on the film with a special device supplied for the purpose. The film being projected, first runs through the *Voca-TITLER* head and as it passes through, the notches operate delicate switches which control the turntable and amplified loudspeaker. Speech and sound effects come from behind the projection screen clearly and without lag or distortion. The tone quality is the finest. Voices are recorded faithfully—true in tone and inflection. Music is also recorded with fidelity. Recordings can be made on the *Voca-TITLER* RECORDER by anyone alone—it is so easy and automatic that no assistance is required. The *Voca-TITLER* instrument may

be used in conjunction with any good recorder-phonograph but best with the equipment shown. Instructions for attaching and operating are supplied. The hobby of making personal recordings is sweeping the country and the making and projection of voice titles for movies are becoming a popular hobby in its own right. It's fun, and any good silent film is improved a thousand per cent by the addition of *spoken* titles and *sound effects*—they are *the thing* today—and, don't forget, they cost much less to make than ordinary *lettered* titles.

VOICE TITLES FOR SILENT FILMS

Voca-TITLER

RECORDER • RADIO • PHONOGRAPH

EXCLUSIVE DISTRIBUTORS

AMERICAN BOLEX COMPANY

155 EAST 44th STREET NEW YORK, N. Y.

The Voca-Titler is a precisely built instrument for electrically controlling the phonograph turntable and amplified loudspeaker. Can be used with any recorder-phonograph. 110-125V., 60 cycle, AC. Either 8 mm or 16 mm . . . \$69.50

The Recorder-Microphone-Radio-Phonograph-Loudspeaker Unit closes into an easy-to-carry case. Turntable runs of 78 r.p.m. and Recorder cuts 109 lines to the inch. About 30 titles of 25 words each can be put on either side of a 12-in. record. Included is 25-ft. cable to Loudspeaker \$110. With Voca-Titler \$179.50

BUY ON EASY PAYMENTS

Write today for details

AMERICAN BOLEX CO., INC.
 155 East 44th Street
 New York, N. Y.

I'm interested in the Voca-TITLER. Please send without obligation, your illustrated folder—also tell me where I can see and hear a demonstration.

NAME

ADDRESS

CITY STATE



★ The new 16mm entertainment film that is fascinating and thrilling fun-seekers everywhere . . . It's so new — so modern — so different — so entertaining.

COMEDY!
THRILLS!
MELODIES!
AND A HAIR-RAISING
CONTEST!

Now
YOU CAN HAVE THEM ALL IN

Melody Puzzles

The **LIFE OF YOUR PARTY**

★ Here is a 16mm film that presents a new twist in 16mm film production — drama and comedy that winds up with a colossal musical melody detection contest . . . Declared outstanding entertainment by theater goers, family groups and many critics. . . . A slam bang presentation that thrills young and old; a series that will make your funfest a real treat . . . More than a film, it offers all the entertainment of your favorite movie theater on Bank nite.

Four Subjects Now Available

"The Trial of Eileen Ballew"
"The Secret of the Double Doors"
"Ain't Love Grand?"
"Crime Doesn't Play"

Available Through Your Dealer, or Write

SHORTS INCORPORATED

6362 Hollywood Blvd.

Hollywood, Calif.

The Reader



SPEAKS

Read -- and Heed

Reader Lane is not the first cinebug to make the mistake he describes here—exposing Kodachrome to a darkroom safe (?) light—so we print his letter as a warning to others. Should you ever encounter similar trouble, simply join the broken film together with scotch tape if you are unable to "feel" your way in making a successful splice in total darkness.

Editor: Recently, while shooting Kodachrome, the film broke in the camera — probably due to loss of loop or improper threading—so I took my camera into my darkroom and spliced the film together under a red safelite. Several days later I had the same experience; again I spliced the film in my darkroom. When the film was returned to me and projected, I found there were several sections on which there was no image but that the film was red in color. In discussing this

"phenomena" with my friends, I learned that the red safelite was the cause of my trouble. Kodachrome, being sensitive to all colors, naturally was affected by the red color of the safelite which is intended for use only with orthochromatic film. Now I know that no safelight is really safe for Kodachrome.

—Geo. E. Lane.

Good Idea

Commercially, we believe this idea would be a success. However, until such containers are placed on the market, cinebugs may obtain at little cost from their druggists "ointment tins" of a size that will just take 25 and 50 foot rolls of 8mm and 16mm film.

Dear Sirs: Why doesn't some enterprising photo supply house put on the market humidor cans for 25, 50 and 100 foot reels of 8mm and 16mm film? Most of us amateurs shoot only a

• Continued on page 149

CINE QUIZ

By popular demand, we are continuing HOME MOVIES' Cine Quiz department. Test your skill and knowledge by marking the answers to questions below, then—check page 144 for the correct answers.

- To panorama properly—assuming your scene requires filming in this manner, would you,*
 - Pan from left to right,
 - Pan from right to left, or
 - Pan slowly from left to right, and then back to the left again?
- In home reversal of panchromatic film, what light source should be used when first transferring film from camera spool to developing rack?*
 - A 7-watt frosted mazda lamp,
 - Red safelight,
 - Amber safelight.
- What effect will cold water below the temperature of 50° F. have on cine film when used in the final washing of the home reversal process?*
 - Cause reticulation,
 - Impart an amber tone to film,
 - No effect whatever.
- In tinting or toning cine films this work must be carried on under,*
 - Absolute darkness,
 - A darkroom safelight,
 - Mazda lamp or daylight.
- In order to obtain sharp definition—i. e., sharp outlines of effect masks placed before a camera lens—at what distance from the lens should they be placed?*
 - Against the lens mount,
 - Approximately six inches away,
 - Depends on size of masks in relation to angle of lens used.
- To make a fadeout on positive film with the lens iris when shooting titles, would you,*
 - Gradually close the iris,
 - Gradually open the iris beyond the "taking" point.

FOR *FULL DIVIDENDS*

From Your Investment in Camera and Projector



The Da-Lite Challenger Screen combines superb picture qualities with unmatched convenience. It is the only screen with square tubing in tripod and extension support to hold the case in perfect alignment—the only screen that can be adjusted in height merely by releasing a spring latch and raising the extension rod. 12 sizes, including square sizes from 30" x 40" to 70" x 94" inclusive from \$12.50* up.



You Need The Brighter Light Reflective Quality of a **DA-LITE SCREEN**

In your camera and projector, you may have "the makings" of perfect pictures. But unless you have also an efficient *screen* you are not getting all of the pleasure that movies can bring.

For full dividends from your investment, show your pictures on a Da-Lite Glass-Beaded Screen. Its brighter surface, covered with millions of tiny glass beads, not only makes every scene more brilliant and life-like but reproduces all of the shades of colors and the gradations of black and white film with camera-eye fidelity. It is ideal for color because it is absolutely neutral in character and provides the extra brilliance that the more dense film needs for perfect projection. The beads are guaranteed not to shatter off. The fabric specially selected for its light reflective qualities stays white longer and remains pliable longer than any other white surface. Ask your dealer for a demonstration! See for yourself how much brighter the Da-Lite Glass-Beaded Screen makes your pictures and you, too, like thousands of others will insist on this screen for full dividends from your investment in movie making. Literature on request. Write today.

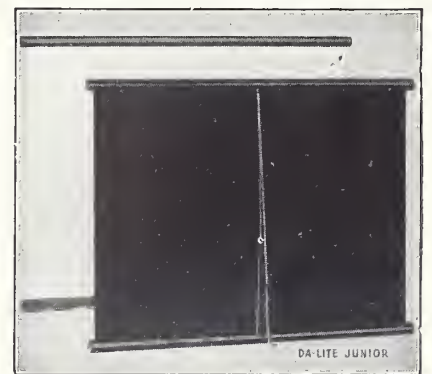

The Da-Lite Junior can be hung from a wall or placed on a table. It has as fine a glass-beaded surface as the highest priced screen in the Da-Lite line. From \$2.00* up.

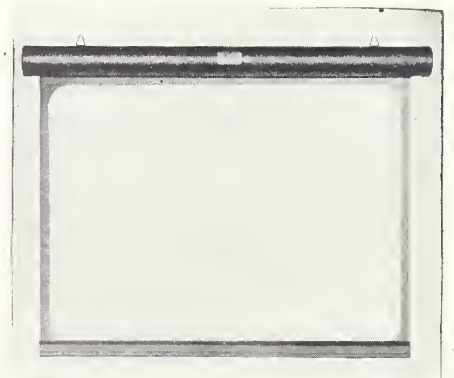

The Model B is the most popular hanging screen in the Da-Lite line. 12 sizes from 22" x 30" to 63" x 84" from \$7.50* up.

**Slightly higher on Pacific Coast.*

DA-LITE SCREEN CO., INC.

Dept. 3 HM 2723 North Crawford Avenue Chicago, Ill.

Look for the Name **DA-LITE** When You Buy!

REG. U.S. PAT. OFF.

BACKYARD MOVIES

Ideas for Short Films

Tip, Tap, Toes

Have you a young tap dancer in the family? Well, why not film his or her various dance routines in a professional manner? Set up your camera with a huge drape in the background that will give the effect of a theater curtain. Start your story with one of your party, chosen to act as master of ceremonies, entering the scene and announcing the next attraction — the youngster who is about to dance. Follow this with a descriptive title of his speech which should describe the dance routine. If you can get a microphone on a standard for the master of ceremonies shot, it will look all the more professional.

Then make a series of shots of the dancer in action executing his or her various steps. Vary your camera set-up from time to time and also make several closeups of the feet in action. After each dance have your actor bow, and back out of the scene. Then have the master of ceremonies enter, applauding, and announce the next dance. Follow this with the necessary spoken title.

Close the series of shots with both the dancer and M. C. in the shot — dancer bowing and acknowledging applause, and the M. C. applauding. If your family group is large enough make one or two shots of them seated in a group, applauding, and cut these shots in immediately after some, not all, of the shots of the youngster bowing after each routine.

—Virginia Fallci.

Instructive Film

A film that could be used to advantage by amateur cine clubs in demonstrating to beginners the right and wrong way to shoot movies as well as illustrating the results of improper focusing, exposure, etc., could be made up from some of the bad shots in the archives of most of its members.

Fast, jerky, pan shots; under- and over-exposed shots; closeups with heads or top of subject cut off;

out-of-focus shots; and others—all could be used in this reel with contrasting shots of similar scenes correctly filmed and with ample titles explaining both.

—Edw. B. Denchie.

A Doggie Idea!

Here is an outline of a backyard movie that well may be titled "Dog Eats Dogs!"

Mary Lou, about four or five years of age, is standing on the porch of her home, where her mother is giving her some money and telling her to get "15 cents worth of frankfurters." She toddles off, and down the street.

She enters a grocery store and presently comes out with a bundle under her arm containing about six frankfurters all joined together. Farther down the street, she stops to look at a window display and drops the package, causing it to break open, exposing the frankfurters. A closeup shows all of this, as Mary Lou stoops down to retrieve the package. As she proceeds down the street, the frankfurters work loose, some of them dangling from the package.

A title, "Our villain, the dirty dog, scents prey from afar . . ." follows. Then a shot of a large dog as he enters the scene where the frankfurters were dropped. He stops and sniffs the ground, then looks up in the direction of Mary Lou and trots off in her direction.

The next is a rear view of Mary Lou walking homeward. The dog catches up with her, sniffs the frankfurters, then takes them in his mouth. Mary Lou, frightened, attempts to stop the dog, who runs out of the scene. Mary Lou starts to cry and runs toward home.

Another title follows: "The Sheriff of Kiddo Kounty forms a posse and a search for the villain is begun." Next we see a small boy of about eight years, talking over a toy telephone — calling members of his gang together. A tin star on his shirt indicates he is

• Continued on page 146

MORE AND MORE AMATEUR
MOVIE MAKERS Say

"SEEMANNS"

Because it means

- ★ BETTER QUALITY
- ★ GREATER VALUE
- ★ EXCLUSIVE FEATURES

NEW SEEMANN TITLER

Fits 8 mm., 9 1/2 mm., 16 mm. cameras. Unique alignment guide insures accurate centering of typewritten or larger size titles. Complete with rolling title attachment and all accessories.

Model A with lights... \$9.95
Model B without lights... \$6.95

SEEMANN EDITEER

For 8 mm., 16 mm. films
Silent or Sound

Optical filmviewer reflects film image in vertical position. Splicer features dry emulsion scraper. Geared rewinds, film rock, nickel accessories. (Without reels)..... \$12.50

SEEMANN SPICE MASTER

For 8 mm., 16 mm. films

Complete editing board, with Seemann splicer and rewinds. Elevates at back, when desired, for easier editing, splicing. Complete. \$6.75

SEEMANN SPLICER

For 8 mm., 16 mm. films
Silent or Sound

All metal, one-unit splicer featuring dry emulsion scraper; scratch-proof film grips; improved cement applicator. Complete.. \$2.95

SEEMANNS

INC.
6628 SANTA MONICA BLVD.
HOLLYWOOD, CAL.
IN SAN FRANCISCO
AT 420 MARKET STREET



Five Agfa Films you should know...

For 16 mm. Cameras

FOR EXTREME SPEED:



TRIPLE S SUPERPAN REVERSIBLE. Designed by Agfa AnSCO especially for indoor movies and for slow-motion work under light conditions requiring great film speed. It has wide latitude and efficient anti-halo protection. A balanced emulsion provides a pleasing contrast outdoors, prevents harsh effects under artificial light. Available in 100 ft. rolls at \$6.00; in 50 ft. rolls at \$3.25.

FOR OUTDOOR WORK:



HYPAN REVERSIBLE. Particularly suited for daylight use where brilliant contrast and clear, sharp results are necessary. Hypan combines high speed with a full panchromatic sensitivity while excellent projection quality is assured by its fine-grain emulsion and the highly effective Agfa anti-halation coating. Available in 100 ft. rolls at \$6.00; in 50 ft. rolls at \$3.25.

FOR GREATER ECONOMY:



PANCHROMATIC REVERSIBLE. You will find this film an ideal selection for a wide variety of subject material. It's fast and sensitive to all colors. In addition, it possesses a carefully balanced gradation that produces a highly satisfying screen brilliance on projection. The low price makes it an exceptional value. Available in 100 ft. rolls at \$4.50; in 50 ft. rolls at \$2.75.

LOW-COST OUTDOOR FILM:



FINE-GRAIN PLENACHROME REVERSIBLE. This film has ample speed, pleasingly brilliant contrast and orthochromatic color sensitivity—providing you with an exceptionally fine outdoor medium at a moderate price. It's extremely fine-grained and possesses wide latitude to minimize exposure errors. Plenachrome is available in 100 ft. rolls at \$4.50; in 50 ft. rolls at \$2.75.

For Double-8 mm. Cameras

FOR EVERY PURPOSE:

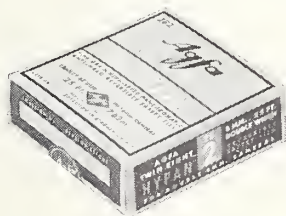

"TWIN EIGHT" HYPAN REVERSIBLE. This new, double-width 8 mm. film gives you finer results with double-8 cameras—having exceptional speed that makes it ideal for indoor as well as outdoor scenes. Its panchromatic emulsion is unusually fine-grained and supplies the high resolving power necessary for the best screen results. "Twin-Eight" Hypan is available in 25 ft. rolls at \$2.25.

AGFA ANSCO, BINGHAMTON, N. Y. MADE IN U. S. A.



THE MOVIE



PANCHRO SUPER REVERSAL has these qualities—1: *Brilliance*—because the contrast developed renders each tone distinctly. 2: *Naturalness*—because of its high color sensitivity which renders colored objects in their proper monochromatic tones. 3: *Large Projection*—due to the fine-graininess of the film. Detail is sharp and pleasing. 4: *Simplicity in use*—for its speed is proper for shooting either under artificial light or outdoors on dull winter days.

Panchro Super Reversal Film is the logical film for your camera. Its superior performance will demonstrate to you why leading movie makers all over the world prefer to use Gevaert movie films.

Prices in Canada Slightly Higher

The GEVAERT COMPANY of AMERICA Inc
 423 West 55th Street, New York
 Philadelphia • Boston • Chicago • Los Angeles • San Francisco
 In Canada: GEVAERT (CANADA) LIMITED • Toronto • Montreal • Winnipeg

THE FILM



SIZES AND LIST PRICES

Daylight loading rolls, 16 mm. 50 ft., \$3.25; 100 ft., \$6.00. Double 8 mm. these films are 25 ft. long, 16 mm. wide and prescored, enabling the user to separate into two 8 mm. lengths. 25 ft., \$2.25, 9.5 mm. Laboratory packed in containers each holding 3 thirty-foot lengths. \$3.30 per container tin.

Gevaert processing laboratories are located all over the world. This service is speedy and efficient. Rolls of 400 ft. received for processing are returned spliced on a 400 ft. roll ready for projection. Price of film includes processing service—and films are returned postage prepaid. If your dealer does not supply you write to:

• TITLE TROUBLES •

By GEORGE W. CUSHMAN

IF you have any questions pertaining to titles or title-making, Mr. Cushman will be glad to answer them for you. You may address him in care of this magazine, or direct to his home address, 3425 Witmer Parkway, Des Moines, Iowa. Be sure to enclose a self-addressed envelope for your reply, as well as complete information concerning the kind of film used, light source, developers, exposure, etc.

Q. I have been experimenting with white letters on moving Kodachrome backgrounds, but the result in the background is a washed-out appearance (sample enclosed). The letters are white paint on black cardboard exposed in sunlight. What causes the gray background and how can it be corrected?—C. N., Trenton, N. J.

A. You are over-exposing your black cardboard. I imagine it is not black or, if it is, you are getting light reflection from it. Light it more carefully, making sure that there is absolutely no reflection. Next, I would suggest less exposure—in fact, cut down your exposure as far as possible, yet still retain enough exposure to give a good white letter. If these fail, you can use white pin or metal letters against black deep pile cotton velvet. This is about the blackest thing there is, and you will get no reflection.

Q. Please explain over- and under-exposure. I have read where one should expose fully to give a black background, while elsewhere I have been told a light film means over-exposure. Which is which?—S. M. P., Madison, Wisc.

A. When speaking of the finished print or, in the amateur movie field, the reversed film, ready for pro-

jection, over-exposure results in a light or clear film, while under-exposure gives a dark or black film. When you read that too much exposure would give a black or dark film, this was referring to the negative. As you know, two systems are available for making motion picture films—one by reversal, in which the film that goes through the camera is chemically changed into a positive and the other called the negative-positive process in which the film is developed to a negative only. From this negative the positive print is made. Since the light and tone values in the negative are just the opposite from the scene photographed, that which was light in the scene is dark on the negative. Thus, on a negative, over-exposure gives a dark film.

Q. Am wondering if I could duplicate a sky banner by trick work of some sort which would look like the real McCoy. Would appreciate any help.—F. K., Austin, Texas.

A. If you had a pull with an aviator and a sign painter as well, you might work it out all right. Seriously, however, I believe you could do this in miniature with not too much trouble. You might precede the sequence with an actual shot of an aeroplane towing one of these sky banners, but have it so far from the camera that the wording can't be read. Next, follow with a closeup of the plane (made with a telephoto or when the plane nears the ground). Third comes the shot of the banner, and since this follows the plane shot, the audience will think it is attached to it. I would suggest a banner about three feet long and as wide as you think it should be. Tie this with strings to an elec-

• Continued on page 145

For ROCK-STEADY

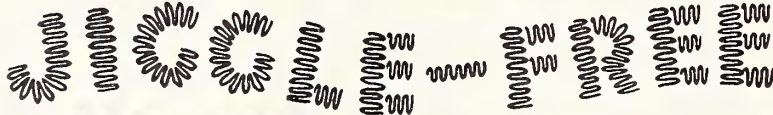

MOVIES

USE THE ALBERT ROYAL TRIPOD

All-Metal—Telescoping—
 Chrome-Plated Steel

ANOTHER **\$750** TILT TOP EXTRA
 ALBERT VALUE AT

• All metal (tubular chrome plated steel and bar) construction gives utmost rigidity and strength to withstand shocks.

• Quick lock adjustment feature instantly and securely locks legs at any desired length (see arrow); with a quarter turn the leg is free to slide to new position—another twist locks it tight.

• Rubber tipped legs prevent sliding and marring floors and prevent slipping on any smooth surface.

• Combination patented panoraming and tilting top. Will tilt full 180 degs. and panoram 360 degs. You can lock the panoraming feature or tilting feature independently. Precision machined parts make the camera movement smooth. The easy grip handle gives you perfect control at all times. Folds conveniently flat against tripod for easy carrying.

COMPLETE \$1250

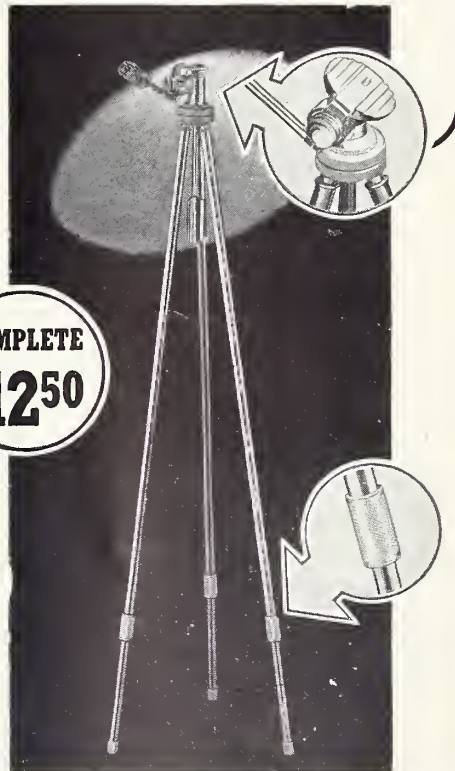

Albert
 SPECIALTY CO.

231 S. Green Street Chicago

See it at your dealer's. Write us for Descriptive Circular. Dept. C-6

4 STAR**Titler**

★ Supplemental lens holder, indicated by arrow, is readily adjustable to all makes of cameras. It is also fitted with unique wipe-off effect device for making popular transition effects. This feature is provided without additional charge.

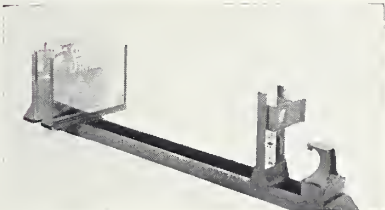

★ Glass Bracket provides means of making novel title effects by lettering title text on panel of glass and superimposing same over art, photo, or movable backgrounds. Readily attached to titler base. Complete with glass panel, \$2.50.



★ Scroll Title Device provides for two types of scroll title effects—the vertical rolling title, as shown here, or the concentrated area effect as illustrated below. The scroll title is probably one of the most practical effects for silent home movies.



★ The extension of the scroll title device shown here is readily attachable and provides for a limited area of the title to be in sharp focus with the balance of title area receding at top and bottom. Produces very effective titles. Scroll Device, complete, \$4.50.

★ *Other Accessories Available Soon!*

RIGHT OUT OF HOLLYWOOD, where movies are made and where the world's finest movie equipment is designed, comes this newest of titlers that will produce every popular cinematic trick and effect in Home Movie titles!

★ ★ ★ ★

Adjustable camera base accommodates every make of 8mm, 9½mm, and 16mm camera. Alignment and centering of titles is simple and accurate. No more guesswork! Title board is readily adjustable to accommodate either small typewritten or large 9"x12" title cards—or cards of any intermediate size.

★ ★ ★ ★

The Four Star Titler, as shown above, will make practically every wanted kind of standard movie title, including zoom titles, wipe-off titles, etc. Additional accessories, available at small cost, make possible scroll titles, flop-over titles, superimposed titles, and others.

★ ★ ★ ★

The Four Star Titler is sturdily built. Its all-metal construction insures accuracy and durability. Price, complete as illustrated above, including two supplemental close-up lenses, but without lights—

\$13⁷⁵

Lights, as shown—\$4.50 extra.

Descriptive Circular FREE!

HOLLYWOOD CINE PRODUCTS Co.

3221 South Figueroa St.

Los Angeles, Calif.

*An Aqua-movie
Masterpiece!*

SWIMMING AND DIVING ACES!

HOME-MOVIE WATER-WONDER 16mm. 8mm.

A stirring aquacade of diving wizards and swimming stars! Finest array of mermaids and mermen ever brought into one film!

A movie gem of grace, beauty and coordination...revealing in superb regular and slow-motion photography most of the compulsory dives that count in championship ratings! Ace swimmers, too!

On your own screen, show amazing shots of:

Half Gainers
Full Gainers
Somersaults
Team Diving

Twists: front;
back; full; half
Armstands
Jack-knives

**Obtain your copy of this newest
Castle film at your photo-dealer's TODAY!**

8 mm: 50'—\$1.75 180'—\$5.50
16 mm: 100'—\$3.50 360'—\$8.75
Sound-on-film: 350'—\$17.50

CASTLE FILMS

30 ROCKEFELLER PLAZA
NEW YORK

WRIGLEY BUILDING
CHICAGO

RUSS BUILDING
SAN FRANCISCO

Please send me your new 32-page catalogue describing "Swimming and Diving Aces" and more than 60 other Castle home-movies.

Name

Address.....

City and State.....

B-3

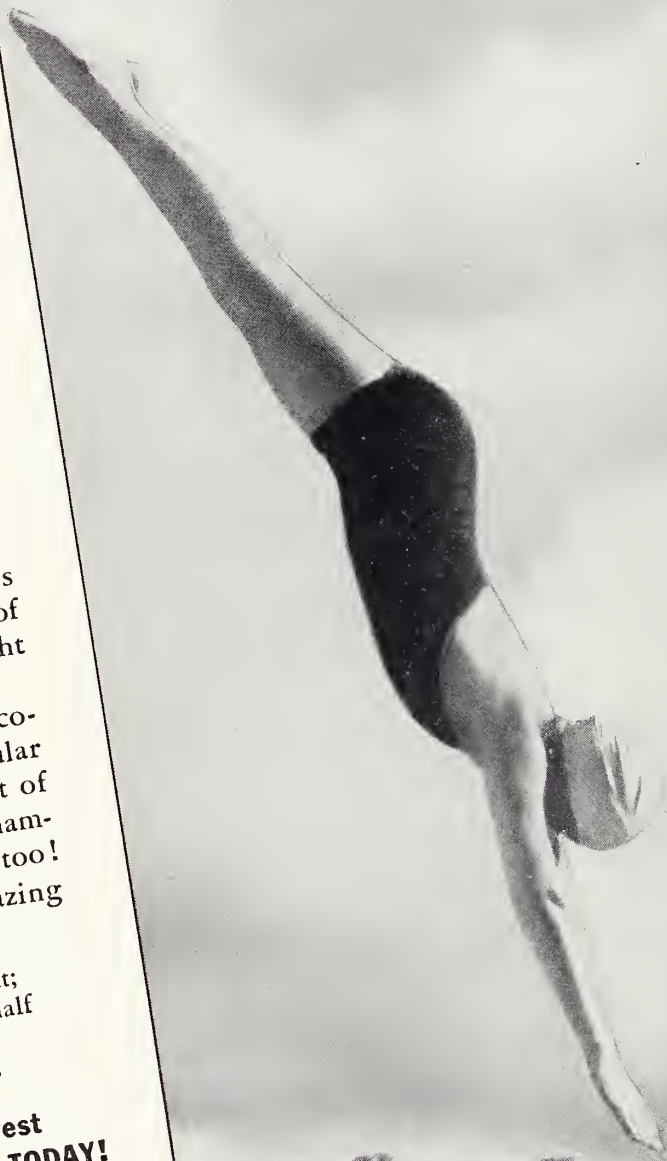

HOME MOVIES

Published in Hollywood

MARCH 1940

SOME amateur cinefilers are inclined to approach the study of composition rather cautiously in the belief that it is something which only artists may tamper with. The truth is, there is composition in every scene, in every shot that we film—some of it good and some bad. When we discuss composition, it is generally with the idea of attaining improved composition—a quality easily within the accomplishments of every amateur. There are certain rules to be followed, of course. So we have asked two of our Advisory Editors, Melvin Swansick of the Bay Empire 8mm Club and Dr. C. Enion Smith of the Metro Movie Club, to report on this subject for our readers.

Melvin Swansick, whose report follows, reiterates our contention that composition need be no stumbling block for the amateur:

Watch your framing for better **COMPOSITION**

LOTS of us amateur movie makers are under the impression that only the serious filers attain composition in their pictures. Well, in a way this might be true; for unless we take our cinefilming seriously we won't pay much attention to the importance of composition. A beginning amateur can also be "serious," and he can get fine composition into his scenes by following a few simple rules.

Basically, composition in your movies means using good judgment in selecting your scenes, and similar good judgment in watching your action. We all have finders on our cameras, and whether it be a built-in, direct viewfinder, or the eye-level, shoulder type, it is in our viewfinder that composition begins.

Of first importance is to bear in mind the "one-third two-thirds" rule of pictorial composition. As an example, one-third foreground and two-thirds sky, or vice versa, depending upon the subject. Let us say, for instance, that we take a stroll out into the country, across hill and dale, with the tall grass shooting skyward, and the sky filled with



Von Schoenfeldt

fleecy white clouds. It is a beautiful sight and we are moved to put our cine camera into action. Here, the one-third two-thirds rule properly applied would enable us to obtain a finely composed shot. With the sky and the clouds the theme of our picture, composition would call for one-third foreground and two-thirds sky for perfect picture balance.

Without picture balance, we cannot expect good composition. Balance hinges on the one-third two-thirds rule in that, whatever we decide is most important in our scene, will, of course, guide us in framing the picture for balance. Let us take, for example, a bit of action involving a fast-moving train. The place—a small town depot. The idea—to impress our audience of the arrival of the local express. In setting up our camera with the one-third two-thirds rule in mind, we would compose our picture through the viewfinder with the rails in the foreground one-third and the station and sky, two-thirds.

Your very garden offers excellent material for

Reported by
MELVIN SWANSICK
and
DR. C. E. SMITH
Advisory Editors

● A picture shot straight at the mountain would have been difficult to balance. By using tree in foreground as counterbalance to large area of rocks, picture was easy to balance and the atmosphere of wildness in the scene was emphasized.

Authored by
CURTIS RANDALL

Amateur's LOCAL NEWSREEL makes good...!

WHEN the fire sirens sound in Warsaw, Ind., one of the town's most aggressive citizens is on the spot—often ahead of the fire-fighting equipment; but instead of playing a hose on the conflagration, he trains his cine camera on the scene, recording the event for the weekly 16mm newsreel of the Strand Theater, of which he is manager.

Few important occurrences in Warsaw escape the camera of J. Ralph Boice, be it a major traffic accident or a drowning; baseball, basketball, or football games; the county fair; annual soap box derby, or a corn husking contest. Boice is always "johnny-on-the-spot," gathering cinematic news with his camera for what is probably the oldest and most successful 16mm theatrical newsreel in the country.

The "Strand News" has been an important feature of Warsaw's Strand Theater programs for more than a year and a half and regarded by many of Warsaw's citizens as the most important part of the program—especially when they appear in

any of its scenes! You see, when Boice films an event—being a smart business man—he sees to it that cards announcing the screening of the event are distributed to everyone present—bystanders as well as those appearing in the scenes. Also, announcements of the newsreel and its contents appear regularly in the daily papers.

Boice uses an Eastman model "K" camera, for which he has both one-inch and three-inch lenses, enabling him to cover every kind of an event successfully without too-frequent change of camera set-up. There's another gadget, too, in Boice's kit of equipment which he designed and made—a "loop" or inverted head for his tripod that enables him to mount his camera upside-down for trick shots. Boice finds that injecting a little comedy into his newsreel by means of slow, fast or reverse motion peps it up considerably.

To screen his 16mm newsreel, Boice has installed in the Strand's projection booth, a 1500-watt projector equipped with three-inch lens that casts an image 11 feet by 14 feet at a distance or "throw" of 110 feet. Although the brilliance is but three-fourths as great as that produced by the theater's regular arc-projectors, the results are highly satisfactory. This is further attributed to the fact that when making his shots, Boice over-exposes approximately one-half stop, purposely "thinning" the image to compensate for large scale projection.

THE "Strand News," which runs from 100 to 200 feet and plays from 4 to 8 minutes, is exhibited a full week in

• Continued on page 137

● Highly professional are the results obtained with ordinary amateur equipment by J. R. Boice, Warsaw, Indiana theater manager, in shooting local material for his 16mm Strand Theater Newsreel.



CLOUDS

(Right)

and exquisite vistas such as this call for use of red filter and pan film. This fine composition is also an excellent background for home movie titles.

Photo by

Jack Treacy



Authored by
E. M. LIEBSCHER



C. E. Bell

ing" or blending objects photographed at different distances from the camera, involving a plurality of focal planes; and, second, by confusing the eye in regard to the relative size of objects.

By superimposing images of objects, photographed separately and at different distances, they can be made to appear as having been photographed at the same time, as in the illustration of the girl in the bottle on this page. In this example the girl appears as having been photographed

Try these **TRICK SHOTS** with your camera!

• The trick shots reproduced on this page may easily be made with your cine camera. It calls for winding back the film, but you can do this without the aid of a "windback" by taking your camera into a darkroom or closet and spooling back the necessary footage.

IN THE February issue of HOME MOVIES, you were given a fundamental working knowledge of lenses in relation to their use in making special-effect and trick shots, and we stressed the importance of avoiding use of telephoto lenses for this kind of work. In the descriptions of trick shots which follow, you will see why this caution was sounded.

In striving for a maximum "depth of focus" we accomplish several things, perhaps the most important of which is the ability to deceive the eye. This may be attained in two ways: First, by "fus-

standing within the bottle, when as a matter of fact the bottle was photographed first, and then the girl; and the two shots superimposed — one printed over the other.

To produce this effect in motion pictures, the bottle would first be photographed at close range in an ultra-closeup shot, with a black backdrop behind it. Some record would have to be made — on the viewfinder if possible — of the exact area covered by the bottle as a guide to placing the girl when photographing her.

The film would then be wound back in the camera to the beginning of this shot, then the girl — standing against a black backdrop — and at the necessary distance from the camera so that her figure fits within the marked area on the viewfinder corresponding to the area of the bottle, would be photographed over the previous shot made of the bottle. This process is termed superimposition or double-exposure.

TRICK effects like these are considered easy to make by the effects specialists of Hollywood's studios where special stages provide ample room for this kind of work. But the amateur's equip-

• Continued on page 144

C. E. Bell



HARBOR LIGHTS

(Right)

Reminiscent of famed pictures of Rio de Janeiro harbor at dusk is this excellent night photo of Laguna Beach, in Southern California. It is also a fine title background for home movies.

Photo by

Jack Treacy



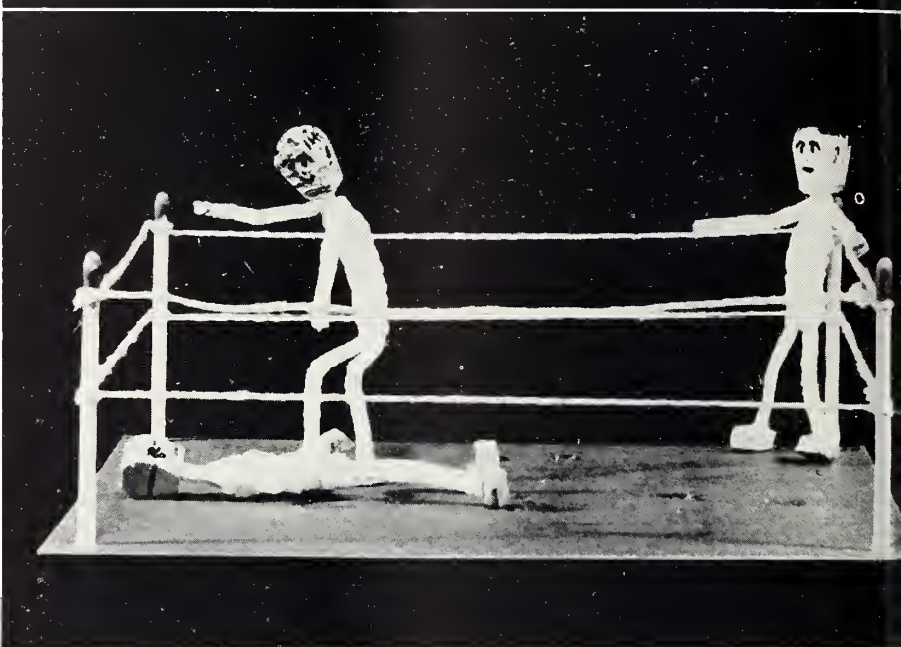
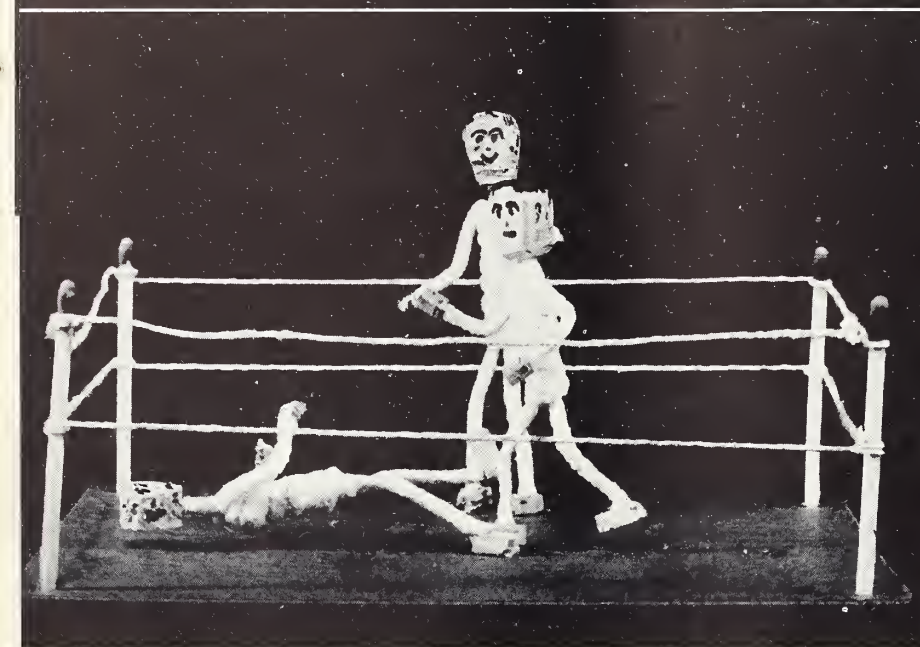
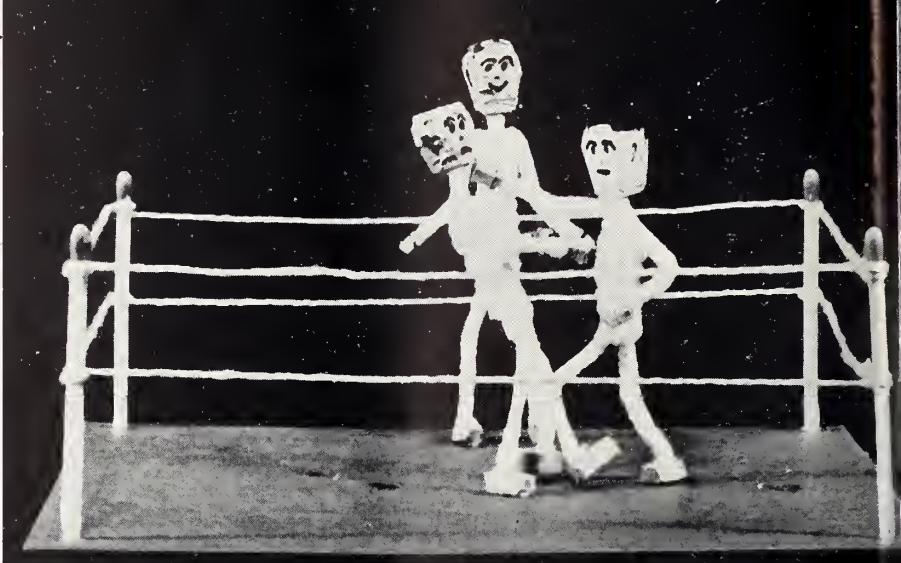
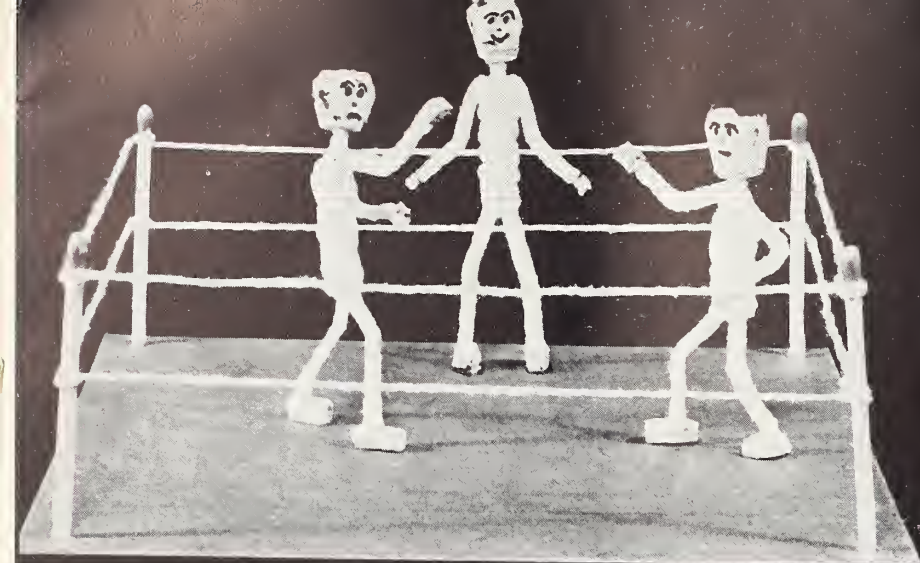

TABLE-TOP MOVIES *with hand-made cast*

CALL it what you will — table-top photography; miniature photography; or animation. To try it means the start of new adventures in cine filming for you.

Table-top movies may be filmed with any cine camera, 8mm or 16. The actors are of your own creation, from bits of cork and pipe cleaners; and if you think making these little characters isn't a fascinating hobby in itself, run down to the drug store right now and buy a pack of those fuzzy little pipestem cleaners and try your hand at turning out a few.

To make one of these pliable characters, so adaptable to stop motion animation, hold three of the cleaners together and wrap another tightly around the center, for a distance of about an inch, to form the body. Of the three stems which protrude from the top, bend two

to form the arms, and trim the center one sufficiently to form the neck. The head may be made from a bottle cork, on which the face and hair have been inked in with a pen. A more elaborate figure may be made with the addition of a dab of wool for hair, and the addition of paper ears and a nose.

Bend two of the lower stems to form the legs and cut the third member at the waist — unless your character is to be an animal, in which case this would be used to form the tail. The feet and hands may also be formed from bits of cork. They may be attached to the cleaners by first piercing them with a large darning needle and forcing the ends of cleaners into them. You need not try to get too much detail into the hands and feet, as the more grotesque they appear the better. After making up several characters, which of course should be

designed to fit your story, you are ready to shoot.

If your camera is not equipped with a single-frame release, practice tapping the exposure button a short, quick tap, so that it will expose from one to three frames at a time — this, of course, with your camera empty. However, it's a good idea to make a few tests of this action on a strip of film, at certain pre-determined exposures, in order to find at what exposure to work in shooting "stop motion." Some amateurs report that when their cameras are operated a frame or two at a time with the camera set at 16-frame speed, that their exposures are not the same. This could be due to the fact the camera mechanism does not attain its full speed when the button is operated so gingerly.

Almost any amateur can work up simple plots for table-top movies. How-

Authored by
G. P. KREUTZER

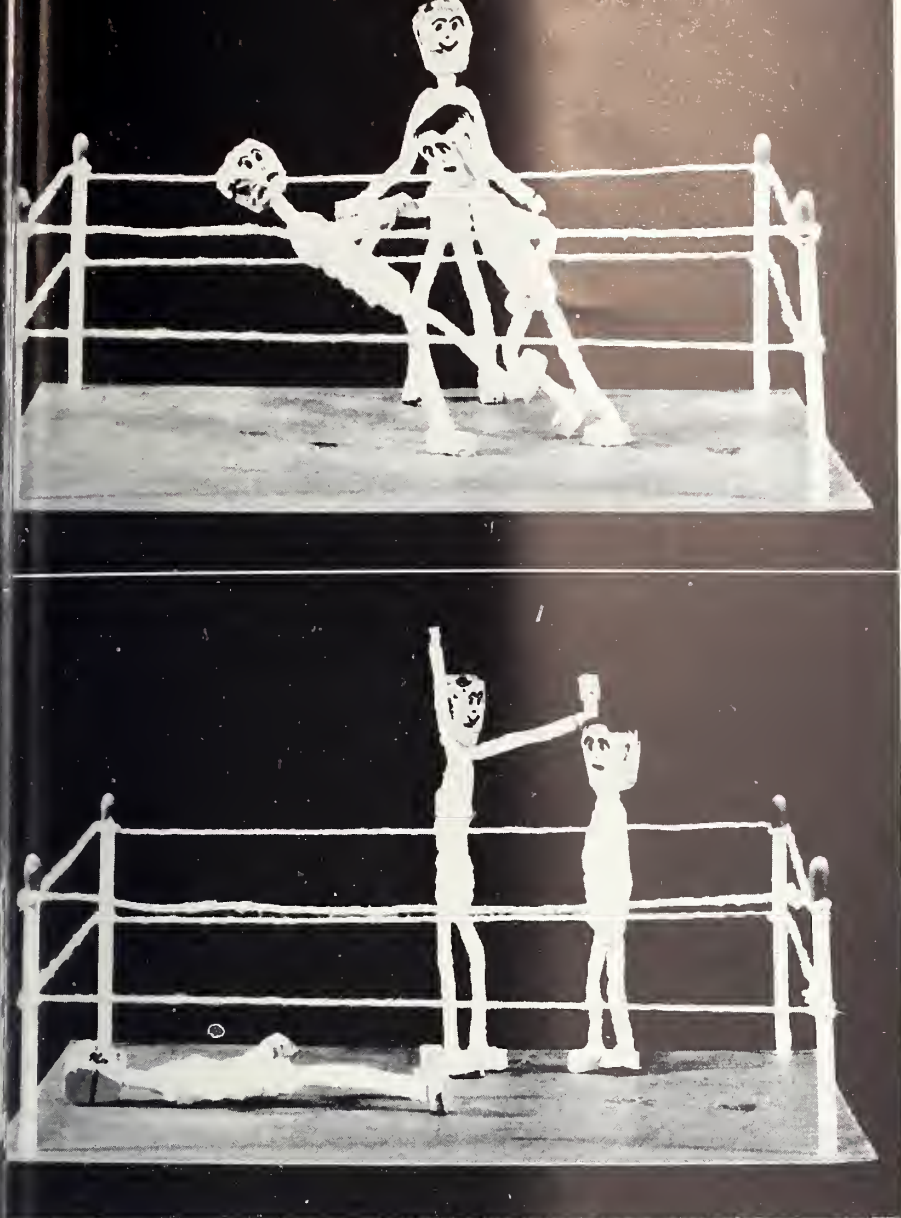

G. E. Bell

⊙ A sequence of shots from "The Champ"—a table top movie anyone can film. The characters were fashioned from pipe-stem cleaners and bits of cork. The "ring"—from match sticks, cardboard and string.

film is about to run out, one of the fighters delivers one straight from the floor, and his opponent kisses the canvas. The referee rushes in, waves the glowering gladiator into a neutral corner and counts out the lad in horizontal position on the "canvas." Fade out, as the new "champeen's" hand is being raised by the referee.

Watch your lighting in this skit. In the prize rings, the light is from a bank of lights directly overhead. Therefore, your strongest light should come from overhead, so that the shadows of your characters are immediately beneath them.

Another table-top movie can be built around the sport of skiing. For the necessary scenery, build a miniature mountain of chunks of crumpled paper, over which is placed a sheet or white cloth. Poke it into the pile of paper here and there to obtain the appearance of hilly terrain. If there is a flour sifter in the house, use it to sprinkle flour over the setting for snow. Bits of grass, shrub, or fine-grained sponge may be placed about for trees and bushes. For my setting, I wanted a bit of sky to show with the sun also in the scene. This was done by stretching a sheet of tissue paper in back of the setting, and placing a small fountain-pen flashlight in back of it which produced the appearance of a hazy winter sun.

THE skiers were fashioned of pipe cleaners, as previously described. The skis were made of strips of medium-weight cardboard. On the bottoms of these were glued small strips of sandpaper which served to hold the skis in place on the "snowy" slopes of the mountains. The pike poles were made of short lengths of wire and small cardboard discs. A short piece of yarn was tied about the neck of one of the skiers and frayed to give the illusion of a scarf fluttering in the breeze.

For action, the skiers may be moved a few steps at a time for climbing action. On the descent, they may be motivated by fine strands of white thread—but very gently to prevent overturning them—and the thread may be further hidden by causing this action to take place during a light "snowstorm"—produced by the flour and the sifter in action directly in front of the camera. Should a skier disappear over a hill, be

• Continued on page 148

Characters

ever, here are a couple of ideas of mine which are simple to film and the characters and settings are not overly elaborate. In short, they are ideal for the beginner:

ON this page are illustrations of a prize-fight sequence of a table-top movie which I recently filmed. The miniature boxing ring, which is about four inches square, was built on a stout piece of cardboard. Ordinary matches were used for the corner posts with white string for the ropes. The two boxers and the referee were constructed as previously described and rubber cement was used on the "soles" of their shoes to hold them in place so they could be bent as required.

It is important to remember that every bit of action must be filmed in several steps to attain the smoothness

that makes for a successful table-top movie. Moreover, every character in the scene must be kept moving. For example, in moving the boxers step by step during the fight, the referee must be animated too; otherwise, in the completed picture, he will remain standing still while the boxers are exchanging punches or moving about the ring. And referees just don't do that in a boxing ring.

As for the action in this "Prize-Fight" skit, the scene opens with the referee introducing one fighter while the other exercises in his corner. Then the other fighter is introduced. The referee calls both fighters to the center of the ring, gives the signal, and the fight is on! The fighters slug at one another, and dance about the ring. There are one or two knockdowns. You can make the fight last as long as you wish. Finally, as your

Authored by
LANELLE FOSHOLODT

Confessions of a CINEBUG'S WIFE...

IT STARTED with a small ad. It said, "Own a Movie Camera, \$1 down, 50c a week." The next day my husband brought it home, acting like a child with a new toy. As he stood there pushing levers and admiring it, I thought to myself, "Ah, another hobby! I certainly picked a husband with a taste for variety!"

Coming events may cast their shadows before them, but the hobbies that had come and gone certainly gave me no indication of what this one would bring. My daily existence began to be different. I had my picture taken while washing dishes, making beds and scrubbing floors. That whirring little camera seemed to be lurking around every corner!

Time passed on and I calmly endured it while one camera was traded in for another, and each projector, accompanied by a few more dollars, was traded in for a more powerful one. I became as

annoyed as any housewife when, one after another, my china shelves were taken over for film spools, lenses, technical books and new equipment. Then my small back porch began to be filled with various shaped bottles of strange developing fluids.

After dinner each night, I stacked the dishes, grabbed the baby's nightie, helped fill the car with vile smelling bottles, and was whisked across the city to the home of another hobbyist who had a darkroom in his attic. I well remember the first night. His wife said most sympathetically, "So you are a movie maker's widow, too," and I regarded her rather wide-eyed and unbelieving as she showed me different lines of art on which she spent her leisure time. I said, "This won't happen to me," and was rewarded with only a disturbing little laugh.

The evenings devoted to home movies became more frequent, the hours longer

and the sleeping child heavier. One night I said, "Honey, couldn't you fix a place at home to work in?" He said, "Well," hopefully, and then, "I just don't know where I could find space," and so I forgot about it. But he didn't.

THE next evening he came in just beaming, holding the biggest package I had ever seen. I mentally whirled through the calendar, wondering what forgotten date was bringing me a present that big. To my excited inquiry, he laughed and squeezed me and the package together. "You little goose," he said, "this is a developing drum. Now I can develop my home movie films at home!" And then to my utter disillusionment he unwrapped a contraption that looked just like a squirrel cage.

First we developed film in the bath tub, but that demanded too much bending, so we moved the drum to the sink until I noticed the brown and yellow

"I had my picture taken while washing dishes, making beds, and scrubbing floors!"

"My husband and his whirring camera seemed to be lurking around every corner."

"He brought home a contraption that looked just like a squirrel cage."



stains appearing on the tile and the side of my electric refrigerator. That was too much, so I told him to take his darned old squirrel cage out of the house and not bring it in again. The next few evenings were spent in heavy silence. And so I gave in and let him use my laundry tub.

Other movie enthusiasts began to drop in, and they talked of forming a club. Shortly afterwards, with the help of the city's photographic dealers, the first meeting of the club was held. After the second meeting my husband came proudly home and announced he was the new vice president. "How will you find time for it all?" I asked.

"Oh, the officers are going to meet here. I won't have to leave the house," he answered enthusiastically.

AFTER the last sandwich and ice-box cookie had disappeared at the first meeting, the members decided to criticize films. Everything from a picture of a mouse in a milk bottle to rattlesnakes on the desert flashed across the screen. I was enjoying it. But not so much that I missed the question, "What are we going to do about a darkroom?" My hopes fell, for I had secretly planned on my small home eventually being relieved of a certain squirrel cage and the bottles that kept it company. The pictures kept unreeling and the voices murmured on. As soon as they turned the lights on I was greeted with, "Honey, Don and I are going to buy material and build a darkroom right here in our back yard!" "Not out where my roses are?" I wailed, but it was no use.

The next three weeks I watched our small yard take on the appearance of a lumber yard and a chemical plant combined. All film activities were suspended in the enthusiasm to get it done. Finally a gray, funny looking building, not as big as the garage, filled the major portion of the yard, and my relief at its finishing touch was exceeded only by the happy looks on the boys' tired faces.

Within a week I could have easily believed I was running a hotel. Before we were up from the dinner table, the phone and doorbell rang, bringing various groups of the fifty club members who were interested in the new darkroom. They didn't go around the house, but calmly walked through the dish-laden kitchen and out the back door. Around 10:30 if the film wasn't drying fast enough they all trooped back into the house; and while I watched rebelliously, they strung it from the curtain rods on one side to those on the other side of the room. No wonder the neighbors asked if I were putting up decorations for a party!

My joy over the house being emptied of all the movie equipment didn't last

Tap—"One after another my china shelves were taken over for developers, fixers, reels, and whatnat." Center—"At first we developed film in the bath tub, but that was taa hard on the back!" Battam—"Then we moved the drum to the sink, and developed our films there—until brown and yellow stains began to appear on the tile." (Photos staged by C. E. Bell. Characterizations by Daris and Fletcher Power.)

long, for by the time my husband and his pal had bought and installed seven tanks, three drums, two titling outfits, a printing machine and dryer, there wasn't room for the original equipment and so to my consternation it all came right back in.

I understood how all this equipment was being paid for as I watched my husband's wardrobe become threadbare. Although I realized he was making progress and was proud of the magazine articles explaining the inventions they happened upon, I secretly resented the money that was going into it all. Finally the power of suggestion or the actual need of more equipment made them speculate upon their ability to earn a little income from their hobby.

Title making seemed to require an awful lot of space for them. The prospect of their making a little money persuaded me to let them use my living room floor. As they sorted various squares of colored paper, the floor took on the appearance of a checkerboard. To complete the picture, they brought in an old black printing press and while I was still gasping over the noise, the doorbell rang. Mrs. V., president of the garden club, was standing there, but she didn't stand there very long. With a quick invitation to tea and a few furtive glances past the half-open door at the strange goings on inside, she was gone before I could say "Thanks." I turned and looked at the boys defiantly. And so they moved into the kitchen.

THEIR cinema club friends were their first customers. Then they received more work making titles to be used in pictures for the schools. They didn't make much money, but their hobby was starting to pay for itself. That was a miracle in itself. Soon all kinds of work came for them to do in their spare time. Certain mothers realizing the advantage of movies over still pictures hired them to come and take pictures of their children. Clubs wanted them to photograph certain of their activities during the year. By the time my husband and I were ready to build a home, the darkroom's small but steady income warranted space for a more up-to-date room for them to work in.

Eventually my husband and his pals undertook work on an 800-foot picture just for the experience. A certain dramatic coach wanted to film a play. It sounded very interesting. Several dif-

• Continued on page 142

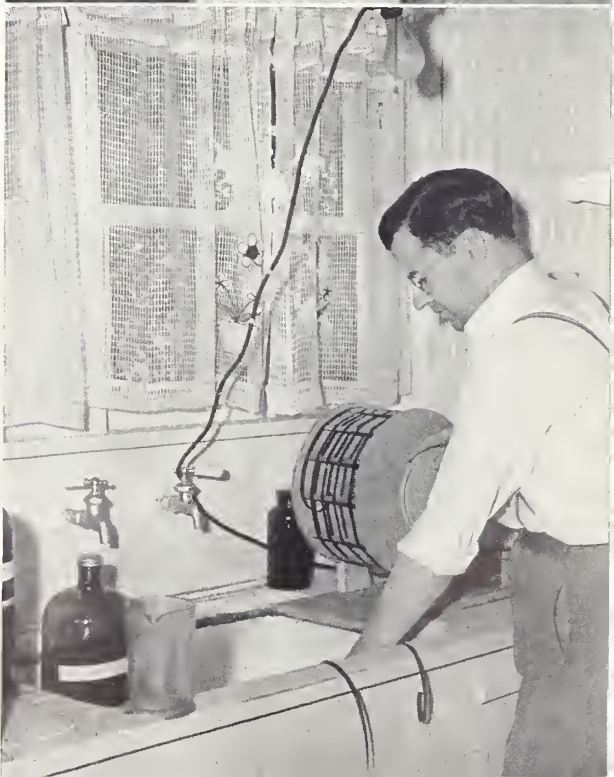

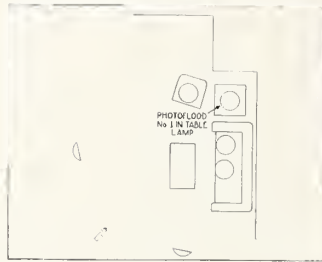
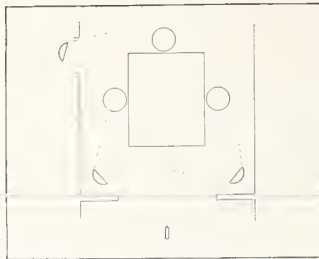

“OOMPH” LIGHTING

for small groups

Authored by
R. E. WORSTEL

Illustrations
courtesy General
Electric Co.

AS THE winter season passes and we look forward to green grass, flowers, sunshine, and life outdoors, we should pause and review the results of our indoor filming. How many feet of film have been wasted due to under-exposure, and to improper and uninteresting lighting? The solution to the first is relatively easy because under-exposure is a mechanical problem — one capable of solution by means of an exposure meter or an exposure guide. The second is more difficult because it is less tangible.

Every scene may be lighted in a number of ways and this is particularly true of small groups. There are two things generally to be avoided, however. One of these is “flat” lighting and the other is “chalk-and-soot” lighting.

If the subjects are illuminated uniformly, facial characteristics disappear. The faces lose “roundness” and form, and the scene appears to have no depth. This is known as “flat” lighting and is due to balanced illumination.

Should the subjects be so lighted that there is excessive contrast between the lighted portions and the shadows, the result is frequently referred to as “chalk-and-soot.” Certain areas in the scene are over-lighted by contrast with the shadows which are dense and in which no detail can be seen. Extreme unbalance

of lighting creates this effect, and one of the principal causes is the use of a single light source.

There are places where balanced or “flat” lighting is desirable, as, for example, in color photography. Likewise, excessive contrasts to create a certain effect may be very useful. For the average condition, however, a compromise between the two extremes gives scenes which sparkle and have an appearance of depth.

The lighting of individual subjects has been “cussed” and discussed many times in this publication. Since movies in the home more frequently than not are made with small groups, it is well to study the more complicated lighting technique of group photography.

Basically, the lighting of groups is the same as for an individual subject. The complexity of the problem arises in the placement of the lighting units and in the disposition of the light so that each subject is well and properly illuminated. Lacking experience, the home movie enthusiast should take advantage of the experience of others. When you go to the movies, keep one eye on the action and plot and the other on the lighting. Take advantage of the opportunity presented in looking at the work of any master photographer, by scrutinizing the print from the standpoint of lighting. Notice the location of highlights and the detail in the shadows. Try to picture in your mind the location and relative strength of the light sources. And above all, remember this, that there must be at least twice the illumination in a highlight or modeling-light as there is in the area surrounding it.

THE accompanying illustrations show the photography of small groups in settings to be found in almost any home. Before you look at the sketches showing where the lights were placed, locate them from a study of the pictures. Notice particularly that the faces and figures all receive a strong modeling light which makes them appear crisp and sets them off from the background. That, in the current vernacular, is “oomph” lighting.

In the dining-room scene three No. 2 photo-flood lamps in reflectors were employed; two for gen-

• Continued on page 141

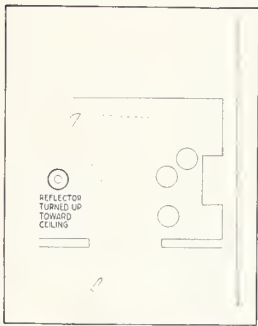

☉ The sketches accompanying the photos on this page show the lighting set-ups with which each scene was photographed. Study them carefully as a guide for your indoor cinefilming.

Authored by
JACK IRWIN

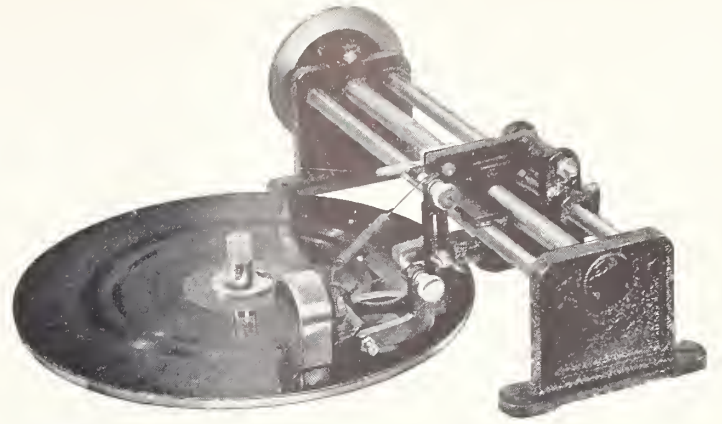

Fig. 1

You filmed it — now RECORD IT...!

PROBABLY the simplest solution to the "Sound with Home Movies" problem is to use disc recordings. This is particularly significant because recordings offer the only practical and inexpensive means whereby the average 8mm cinebug, as well as the 16, may unite sound with his films.

One of two things is necessary: The amateur must have access to a recording service in his vicinity, or the equipment for making his own records. Until recently, home recording equipment was beyond the means of the average amateur. But, just like the automobile, radio, and home movies camera—as its use increased, the cost lessened until today good record cutting equipment is well within the means of most cinebugs.

Moreover, it is now possible to buy the parts with which to assemble a good recorder. Then there are record-cutting heads which may be purchased and used in conjunction with any good electric phonograph. In short, low cost recording is now a reality. Now you can make your own recordings — one or two discs that may be played on a turntable as your film is projected. You can record all the necessary commentary dialogue, background music, and sound effects on one or possibly two records, eliminating the need for cutting and fading a number of separate records during the projection of a film.

This does not mean, of course, that you will be able to obtain what is known as "lip synchronization" in making your records. It is being done, but it's a little too difficult for the average amateur to accomplish.

As to the equipment needed for this fascinating adjunct to movie making, if there is no limit to the bankroll, there are several moderately priced recording outfits on the market, information on which, if not an actual demonstration, may be had from the leading radio supply houses in your city. Then there is a firm in Chicago offering a recording unit at a surprisingly low price, that may be attached to your electric phonograph or public address system for the purpose of cutting records. It is complete with cutting head mounted on a feed screw and carriage that will cut both 12 and 16 inch records.

YOU cinebugs who want to build your own recorder may obtain all the necessary parts from any radio and television supply house. There are several factors, extremely important in the building of a recorder, which insure successful recordings. One of these is the use of a good synchronous motor for turning the record and moving the cutting head at a consistent speed across it. Such motors are available in a variety of sizes and

• Pictured here are "closeups" of a popular recording outfit and its principal mechanism. Fig. 1 shows cutting of disc or record. The cutting stylus is moved across the rotating record by a geared feed screw which governs number of lines cut per inch, also playing time of record. Fig. 2: Method of mounting motor and transmission to insure against transmitting noise to cutting head. Fig. 3: Silent belt-transmission system linking turntable and cutting-head feed screw.

• Continued on page 136

Fig. 2

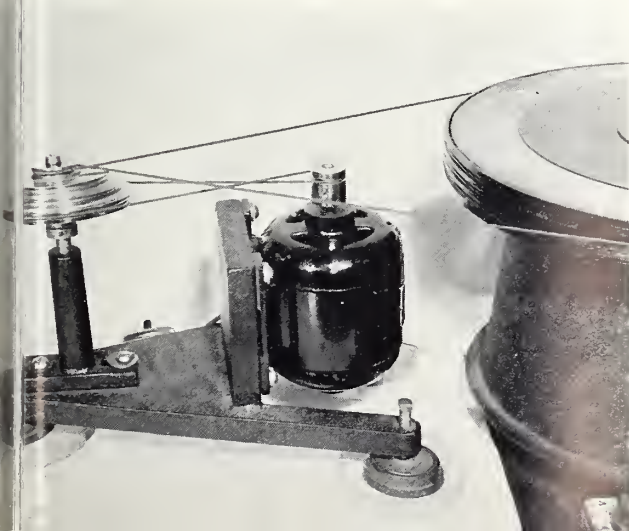
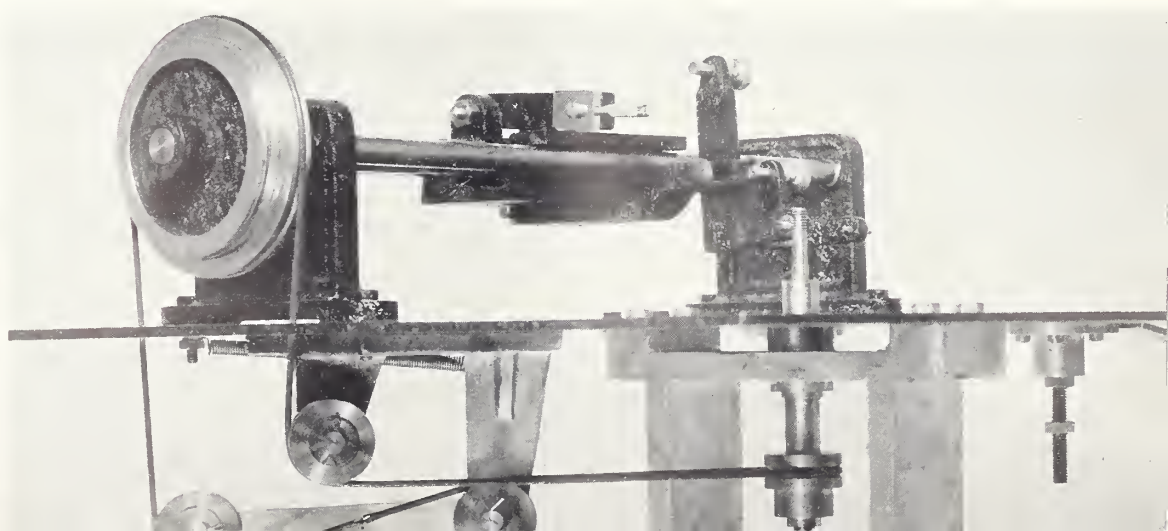
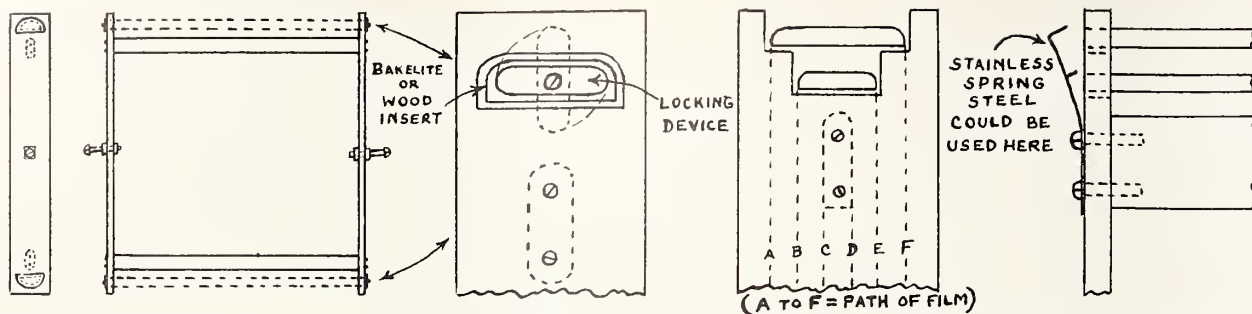

Fig. 3





DOUBLE CAPACITY DEV. RACK

CLOSEUPS OF VARIOUS DEVELOPING RACK ENDS

(DOUBLE & TRIPLE CAPACITY)

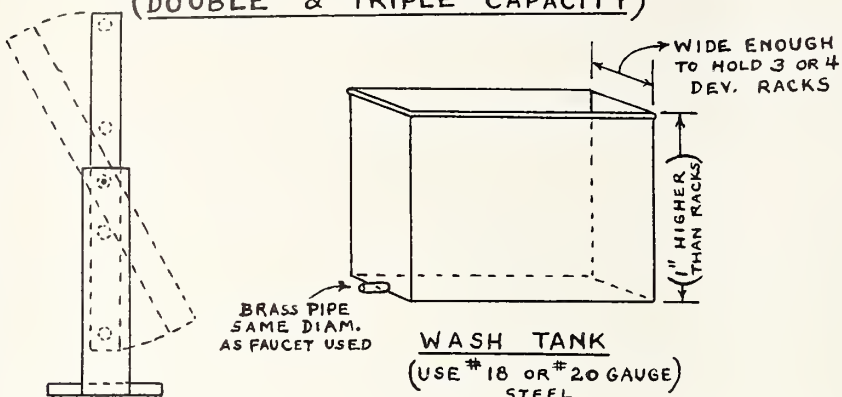
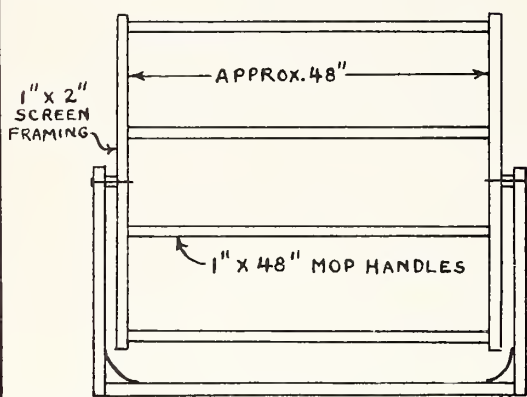

DRYING RACK—4' x 4' ON STAND
(A SMALLER STAND FOR DEV. RACKS IS ALSO NEEDED)

~ W.W.L. '40

NEGATIVE-POSITIVE *developing kit easily built*

Authored by
WALTER W. LIGHT

LAST month I discussed the building of a 16mm continuous printer which would enable any amateur, shooting the negative-positive system, to make an unlimited number of prints or duplicates of his films. The negative-positive system, of course, is that involving the shooting of a picture on negative film—the same as the movie studios do—and then making a duplicate or “print” of it on positive film with the aid of a mechanical printer.

Now, of course, the amateur who wants to do this will also want to do his own developing of both negative and positive films, which is much simpler than processing reversal film. We say “developing” because the term “processing” applies strictly to reversal type films, or, I should say, to the laboratory routine to which they are subjected before they finally become screenable prints.

The sketch on this page contains plans for building simple home developing equipment. Extra large capacity is provided for in a small rack by the unique design which provides for multiple wrapping of film as shown at “A, B, C, D, E, and F” in the sketch. The racks can be made with sheet metal sides and half-round wood inserts waxed or well-coated with acid-proof paint; or

radio bakelite sheets 3/16 inch and 1/4 inch thick can be cut up and used as shown in the upper right-hand detail drawings. The writer has a small bakelite rack on this principle that just fits standard 8x10-inch trays—the capacity is just over 50-foot 16mm. Film ends are fastened with waterproof adhesive tape.

The writer also has several racks similar to those detailed in the upper left-hand corner of the sketch. Film is wrapped on the central section, the two half-round wool inserts are put in place and the second wrapping made, thus giving twice the normal capacity for a given amount of space and chemicals. These racks are nearly 16x20 inches and have a capacity of 125-foot 16mm film. Triple-wrap bakelite racks this size would have a capacity of fully 210-foot 16mm. Standard 16x20-inch trays are used. The film is wrapped tightly, edges just touching, and the rack is turned over several times as soon as placed in developer to make sure of even development. Only half the quantity of chemical required to cover the racks need be used *if* they are turned over constantly.

THIS triple-wrap principle will give a capacity of over 100-foot 16mm, using a rack that just fits a standard 11x14-inch tray. Home-made upright tanks may be used but the writer has not found them very satisfactory, as they often bulge, and pieces of acid-proof paint get on the film.

For direct-positive work only, such as developing home-made titles, a single *solid* rack built for one wrapping of film can be used.

The rack is placed on a small loading stand similar to the drying rack stand illustrated. Small pieces of adhesive tape fastened from the *back* of

● More and more amateurs are going in for negative - positive filming. This month, Walter Light tells how amateurs may develop their own films—gives complete plans for equipment on this page.

● Continued on page 134

Authored by
GEO. W. CUSHMAN

IF THERE'S anything that ruins an otherwise happy evening spent in making a series of titles for your latest reel, it's having those titles come out off-centered.

Really, there's no need for tilted letters, uneven margins, or bottoms showing if a few simple precautions are taken before the titling is begun. For the worker using optical centering devices, off-center titles are rare, but to the majority of us who have ordinary cameras and lenses, we must find simpler means of arriving at the exact field covered by the camera lens.

One method which is used by workers employ-
ing a camera suspended vertically over the title is

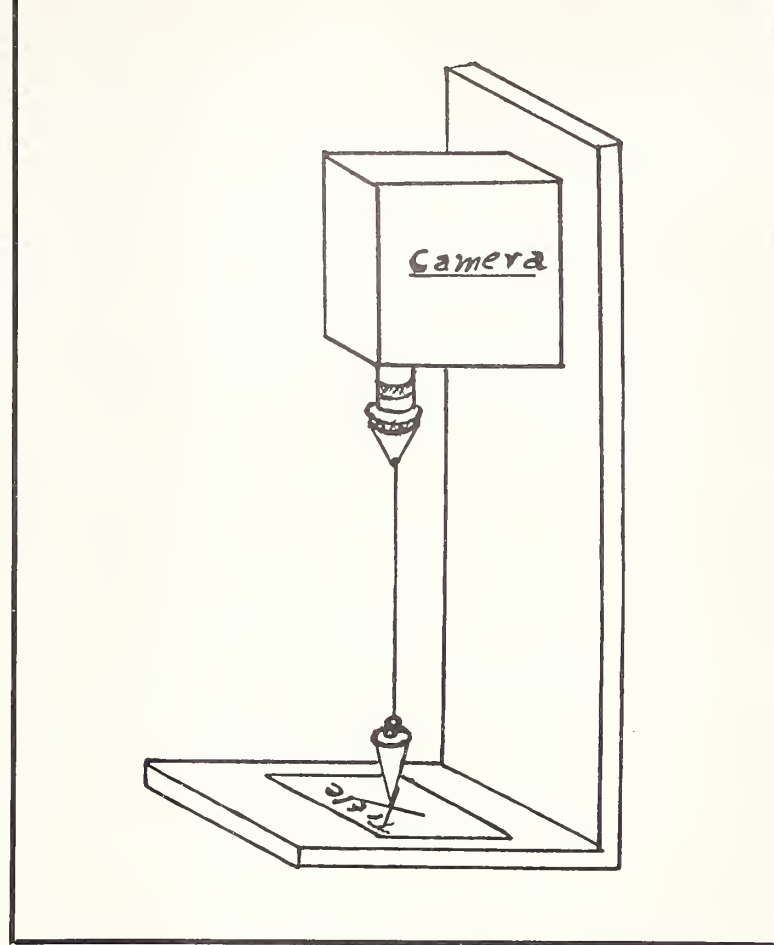

FIG. 1

Simple methods for CENTERING TITLES

illustrated in Fig. 1. The success of this method depends upon the vertical axis of the lens being absolutely perpendicular. It is then but a simple matter to place a plumb line under the lens as shown, and the point will rest over the exact center of the area.

Of course when the camera is resting in a horizontal position, this method cannot be used. Some workers use a flashlight behind the film gate and focus this flashlight beam on the title easel. This really serves better for focusing than field-finding, for unless the rear opening is exactly the same size as the area of the film filled by the lens, the field so illuminated on the title easel will not be correct. Secondly, this method can be accomplished only when the camera is empty.

The finder on the camera does not show the same field as the camera will photograph, due to

its displacement known as parallax. However, there is a very accurate way of using the finder in title centering as shown in Fig. 2. Let us suppose, for example, that we place the camera just 20 inches from the title. (At this distance the field will be 6x8 inches.) Naturally, at this close distance the finder will not disclose the same field as the camera lens. But the field that does show in the finder should be marked with chalk or crayon on the title easel exactly as it is seen through the finder.

NOW, without moving the camera in any way, shoot a few frames of any flat object such as a sheet of newsprint. When developed, this strip will show the exact field covered by the lens. This area is now marked on the title board together with the area shown by the finder. These

● You can insure accurately centered titles at all times by using any of simple methods illustrated here and described further by George Cushman in accompanying article.

• Continued on page 138

FIG. 2

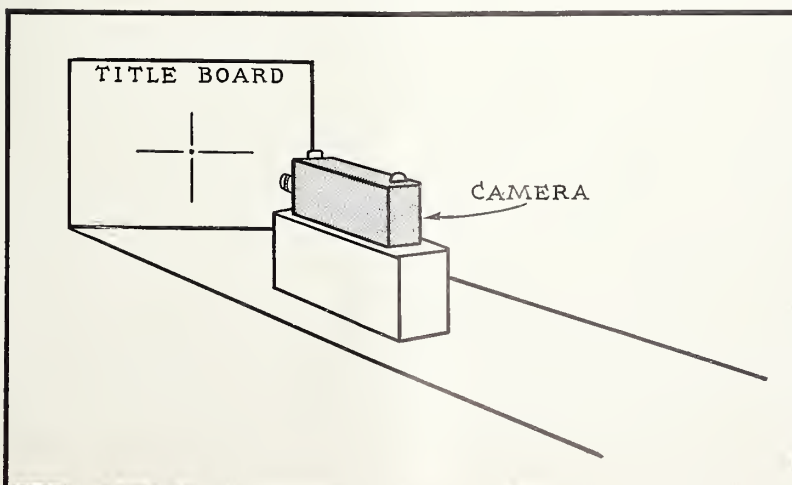
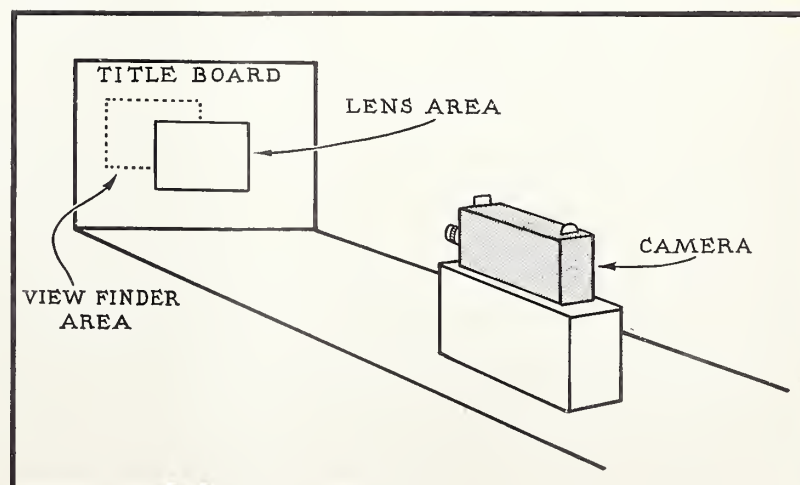

FIG. 3



Reported by
J. H. SCHOEN

"Checking off the Budget" —MOVIE of the MONTH

o The reproductions on this page of enlargements from B. W. Johnson's 8mm film show the "Budgets" planning their vacation trip; scenes along the way in which "Budget's" budget foils him and he resorts to issuing dubious checks; and, in the last scene, the officer comes to hold "Budget" to account for the checks. It's a movie chock full of clever gags — good editing.

IT STARTED merely as a record of a pleasant vacation trip. But before much footage had escaped the camera's clicking shutter, the man with his eye to the viewfinder began to get ideas — ideas for making his vacation movie something more than a succession of pictorial shots. And when, several months later, the last splice had been made at the editing board, there — on five reels of 8mm Kodachrome — was a really swell picture well titled "Checking Off the Budget." It was submitted to the editors of HOME MOVIES for review and promptly acclaimed the "Movie of the Month" for March.

Thousands of cine cameras accompany their owners on vacation trips each year, but few are

maneuvered with the genius and artistry that guided the palm-sized Filmo eight which recorded "Checking Off the Budget." In the hands of B. W. Johnson, who conceived and filmed this picture, a cine camera has few limitations. And although Johnson has only eighteen months of cinefilming behind him, he has acquired the technique of a Hollywood producer.

The opening sequences of the picture were conceived during the shooting of the first roll of film — when filmer Johnson "began to get ideas" — and were shot after the Johnsons returned from their trip. The picture opens with Johnson and his wife, who appear as "Mr. and Mrs. Budget," seated about a table. Mr. Budget is deep in mathematical calculation in an effort to frame a budget for their coming vacation trip. Mrs. Budget, with definite plans for a new fur coat, shows little enthusiasm. After some discussion, both agree they can just about squeeze through on the tentatively budgeted expenses without having to cut into Mrs. Budget's fur coat savings.

Comes the day when they are to start their trip and a surprise package in the form of a telegram arrives, announcing that a relative's son is en route to spend the summer with them. This calls for adjusting the vacation budget to include the boy. The chap arrives, and the Budgets get on their way.

From here on there is a delightful intermingling of gag shots with those of the beautiful scenic spots visited by the Budgets. And although Johnson filmed this entire picture "shooting from the cuff," so to speak, he cleverly conceived "gags" which might be interwoven into his story along the way. Notable among these was the gag about the lad, who accompanied them, having to stop at every rest room along the way! Just as they would get comfortably seated in their car, little "Junior"

• Continued on page 143

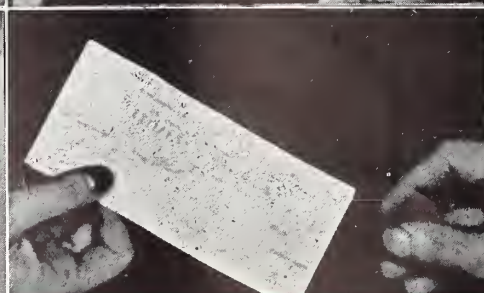
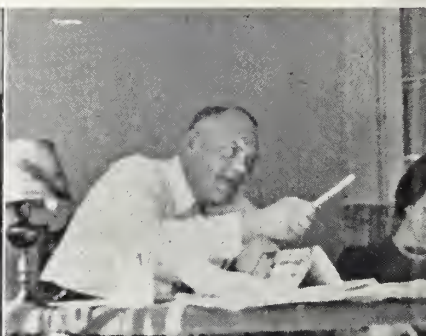
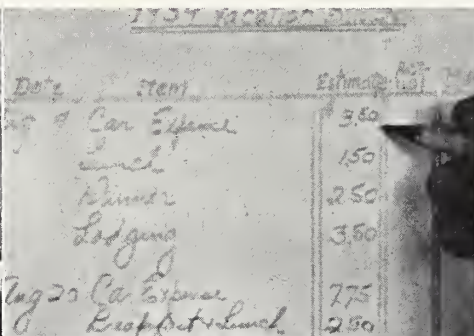
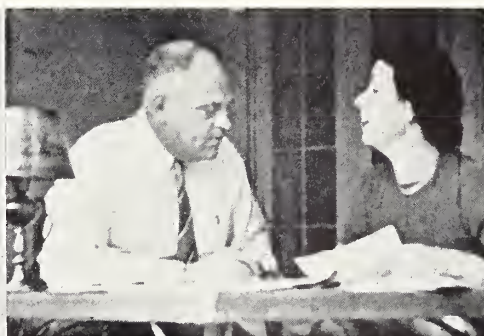
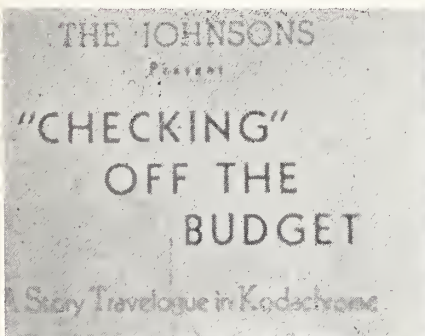



Reviews by
THE EDITORS

TELL ME— *how can I improve my film?*

THE reviews selected for publication this month are especially notable for their ingenious continuity and editing. More and more amateurs are getting the "swing" of this home movie business, judging from the quality of films being received for review. Scenarized pictures show a remarkable flair for originality and the amateur's ability to adapt short stories to motion pictures. Others—the documentary type especially—are abundant in good composition, photography, and editing. Titling, too, is improving.

Every amateur movie maker—whether a reader of HOME MOVIES or not—is invited to submit his filming efforts for review and helpful criticism. Hundreds of amateurs are being aided in bettering their movie-making technique through HOME MOVIES' free review service. Each film reviewed is returned with an attractive animated leader indicative of its rating—one, two, three, or four stars.

We are sure our readers will find beneficial suggestions in the reviews that follow:

"BUNGLE JUNGLE" ★★★
400 ft. 16mm—by P. A. L.

Continuity: An ingenious job. This picture has a number of scenes from library releases (commercially produced films) intercut into it which give the whole story considerable punch. The story is a burlesque on "Tarzan" and opens with scenes in deep jungle, showing a hunting party making their way cautiously through the undergrowth. In the party of several adults is a small boy about six years of age.

As the party comes out into a clearing, they look about them, and there follows a quick cut to a herd of elephants—one of the library scenes. The party decides to go in another direction, and as they do so, they see lions ahead and rush back into the brush. One man remains. He calmly loads his rifle. There's a cut to the lion seemingly charging him. A cut back to the man as he raises his rifle. Then a cut to the lion running in opposite direction. Another cut of the man as he fires his rifle;

and a cut back to the retreating lion as he drops dead.

The rest of the party emerge from the brush, and as they talk among themselves, the little boy roams about picking berries, unmindful of any lurking danger. When he returns to his elders he finds them sprawled about the ground—apparently having been murdered by natives. Nearby is a soap box. The boy reaches into it, brings out a telephone, and calls Sherlock Holmes for assistance! Holmes magically appears on the scene almost instantaneously and advises the lad to go and live among the animals for safety.

Twenty years elapse and we find the boy grown to manhood—a big strapping adonis, clad in a leopard skin and smoking a briar pipe! An expedition of hunters, searching for the party lost 20 years before, emerge from the jungle. Among them is an attractive young lady. As they come upon "Tarzan," they engage him in conversation and he takes a liking to the young lady. He dashes off into the jungle with her, and we are shown them roaming the jung'le together, and the development of their jungle romance.

A TITLE indicates that another twenty years have elapsed. A bent old man emerges from a thicket. It is the "Tarzan" of the early part of our story. He now has quite a family of his own, and we see them step from the thicket one by one and line up alongside of him—about six in all rang-

• Continued on page 135

● At top of page are reproductions from 16mm film, "Bungle Jungle". Below, reproduction of main title and one of many fine closeups from 16mm film, "The School Museum".

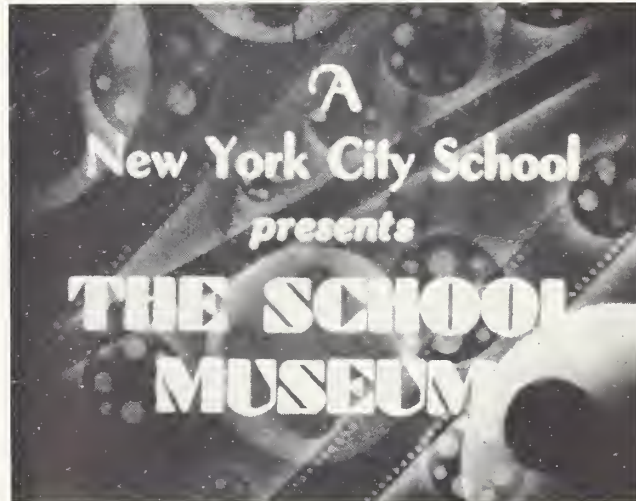

THE EXPERIMENTAL

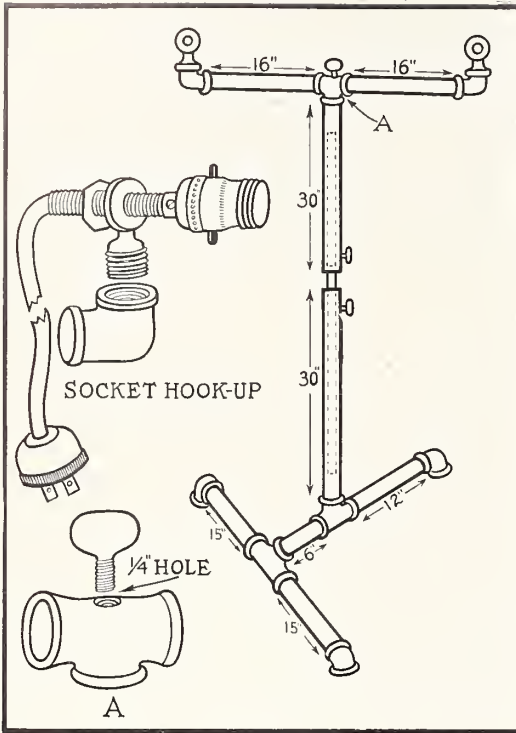

Photoflood Stand

Here is a portable, adjustable stand for photofloods that may be constructed easily and cheaply by any amateur. All of the necessary parts are obtainable from any plumbing shop, and the cutting and threading of pipe and fitting of thumbscrews can be done at little cost by the same source should you not be equipped to do this work yourself. One-half-inch pipe and fittings are used throughout, except for the insert or extension rod which can be made of smaller pipe or solid iron rod. The parts required are summarized as follows:

- 2 pieces 1/2" pipe 15" long
- 1 piece 1/2" pipe 6" long
- 1 piece 1/2" pipe 12" long
- 2 pieces 1/2" pipe 30" long
- 2 pieces 1/2" pipe 16" long
- 3 1/2" iron pipe tees
- 5 1/2" iron pipe elbows
- 3 1/4" iron thumbscrews
- 2 1/2" eye-plugs
- 1 extension rod 48" long

For those who do not already have photoflood reflectors and who wish to

CINEBUGS!

• If you have an idea for a gadget, trick, or shortcut in filming, titling, editing or processing home movies, pass it on to your fellow Cinebugs through these columns. If your idea is published you will receive two reels for your efforts. Extraordinary ideas will net you a roll of film.

Ideas not published will be held for future publication unless they duplicate ideas previously received. Endeavor also to send along photos or rough sketches illustrating your suggestions. There is no limit to number of suggestions you may submit.

Names and addresses of contributors of published ideas are furnished a prominent manufacturer interested in acquiring rights to saleable gadgets on a royalty basis.

Important: When submitting ideas, be sure to mention whether equipment you use is 8mm or 16mm, enabling us to promptly forward owords adaptable to your use.

mount the light sockets on the standard as shown, there will also be required the necessary sockets and fittings necessary to mounting in the eye-plugs as illustrated in detail.

Each pipe length is marked for size in the illustration as a guide for easy assembling. When the stand is completed, apply a coat of black enamel or aluminum paint.

—John Szanco.

Emergency Dark Room

Caught in the not unusual situation of having a jammed camera and no darkroom within forty miles, I opened my car trunk compartment, crawled in, dropped the cover, and thus had a very satisfactory darkroom with ample space to work, although in a prone position. The average modern automobile trunk compartment will accommodate a good-sized person without difficulty. Users of bulk film without leaders will find that changing film by this method will save the extra footage ordinarily wasted by the necessary exposure to light while loading.

—Ivan L. Nelson.

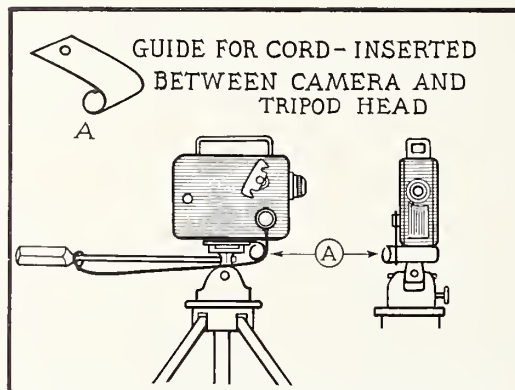

Remote Control

One often finds the need for an extra hand when shooting action scenes with camera mounted on tripod. A camera trigger-control cord on the handle of the tripod head will solve this difficulty for those who use 8mm Eastman Cine Kodaks model 20, 25 or 60, all of which have been vertical action release buttons.

Cord is looped over the release button and then over a guide made from a piece of light metal bent round at one end as shown in the sketch. The cord extends to the tripod head handle and tied at this point. This provides a loop for the finger to control the camera button, allowing the same hand that operates the tripod head to control camera action and leaving the other hand free to operate fading or other effect devices.

—Tom Carr.

Binocular--Telephoto

The increasing practice in converting binoculars and field glasses into auxiliary telephoto lenses prompts me to suggest a simple method of mounting same before the camera lens which does not require dismembering the binoculars and permits use of one of the viewing sections for focusing directly upon the scene or subject.

The accompanying sketches are self-explanatory. The base "A" may be made of light wood or metal. The support "B" is made of wood, and held in place by a screw through the base. The clamp for holding the binoculars may also be of wood, or a piece of metal, drilled and bent as required.

This idea is particularly adaptable to cine cameras with lenses that are not interchangeable and therefore no telephoto lenses are available for them ex-

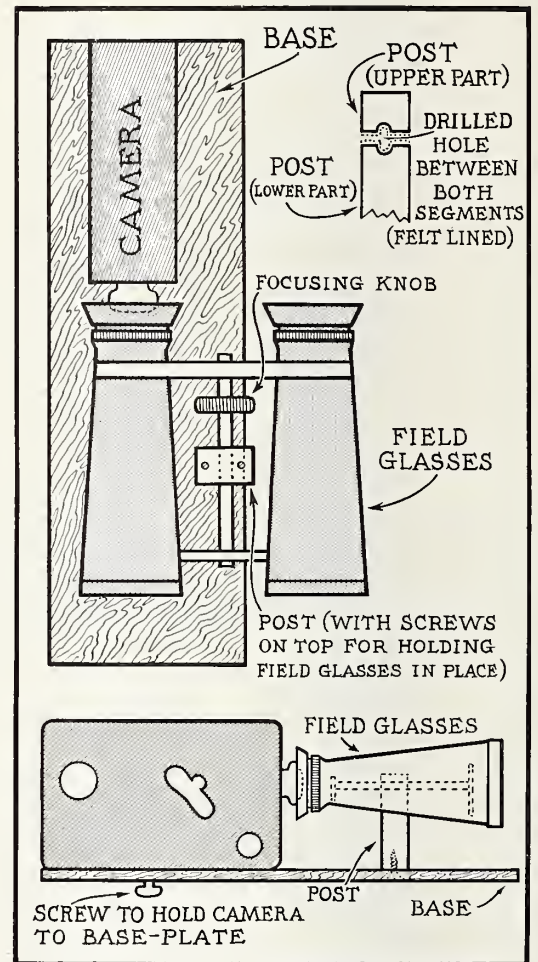

cept in this way. To use, set camera lens at infinity, if lens is in focusing mount. Otherwise, no other compensation is necessary—not even for exposure.

—E. Eugene Leonhart.

Kills Reflections

To eliminate reflections in a glass panel used for shooting moving background titles, as shown in sketch, place

C I N E W O R K S H O P

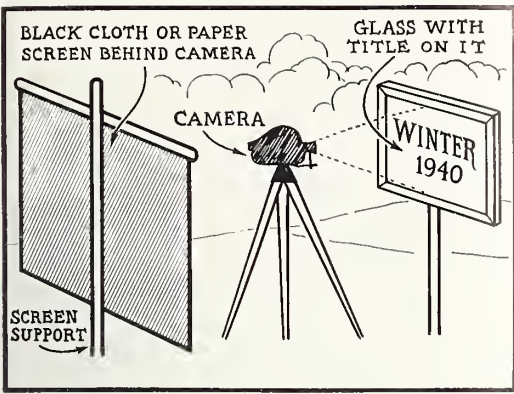

a large dark screen, made of black cloth, immediately behind the camera. Same may be mounted on a wooden frame and held in place by wooden supports or the cloth may be suspended from a rope or wire line stretched immediately back of the camera.

—Owen Wilson.

Complete Film Editor

Illustrated here is detailed plan for building a complete splicing and editing board for 8mm or 16mm films. It can easily be constructed by anyone handy with tools. Only the splicer needs to be added to make the board complete.

The base is made of a semi-hardwood, preferably kiln-dried to safeguard against warping. Dimensions of base: $\frac{3}{4}$ "x7"x26" — not allowing for protruding section that holds splicer. The lamp-house of the film viewer is made of plywood — half-inch material for the top and bottom and quarter-inch for the sides. Back should be hinged to permit free access to light globe for replacement.

The rewinds are, for the most part, constructed of wood. The rest of the details appear in the sketch, as do the details for the remainder of the outfit.

The lens from your projector is used

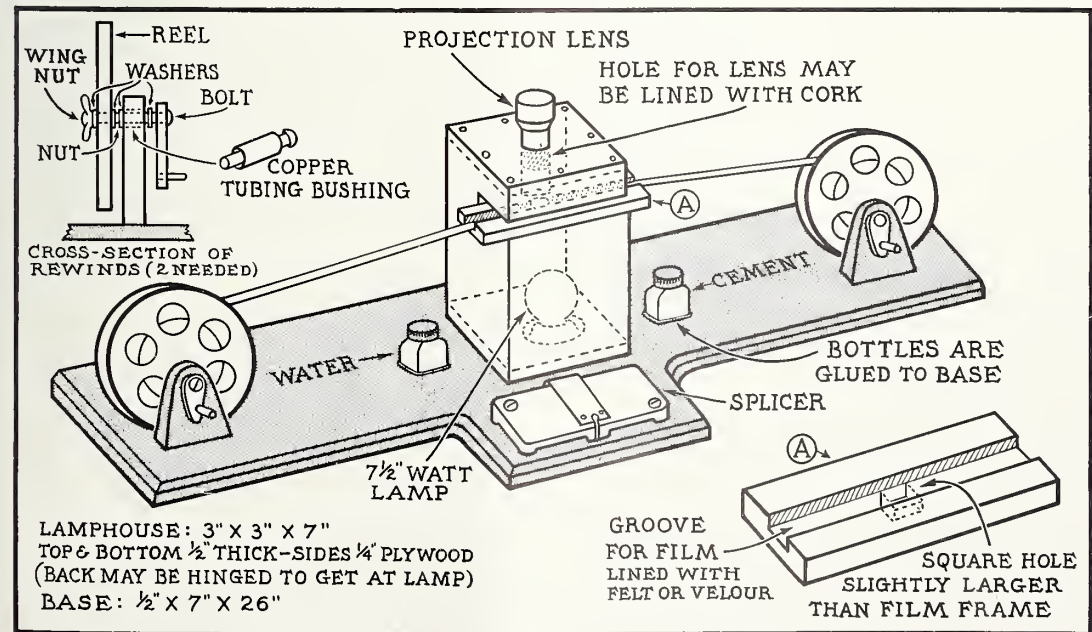

as the focusing for the film viewer, although a permanent optical viewer may be made from a piece of metal or cardboard tubing and a magnifying or spectacle lens of the necessary focal length.

—Russell Meyer.

Making Enlargements

Enlargements of cine film frames which show a surprising amount of detail and absence of grain can be made by any amateur whose projector may be stopped for single frame projection. The picture is projected on the screen and then re-photographed with a still camera, using Super XX film which is developed in the regular manner. I find this method enables me to make fair-sized enlargements with a minimum of grain.

—John A. Hall.

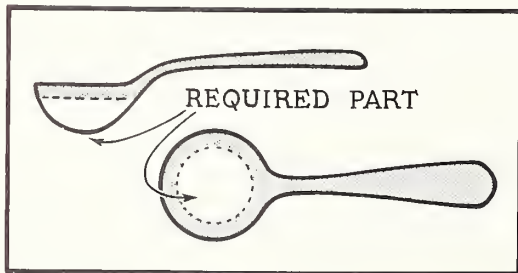

Reflector Replacement

Some time ago I had the misfortune of having the reflector on my projector tarnish so badly that it interfered with the showing of my pictures. As I did not feel I could wait for a replacement from the factory, I scouted about for a substitute and found it — in a 5 and 10 cent store! A bouillon spoon which I purchased for a dime was shorn of the handle, and the spoon trimmed with a hacksaw and file to fit the reflector holder.

—Herman Roth.

gadgets, tricks and short cuts contributed by Cinebugs

Film Tension Control

The accompanying sketch shows a plan for building a cine film developing reel with an automatic, built-in slack take-up that will give fine results. The rods used in the rack are both wooden and glass. The glass rods, which are a part of the slack take-up feature and are spaced between the wooden rods as shown, are the same as those sold as towel racks in the 5 and 10 cent stores. They have knobs on each end which serve admirably for keeping them in place and preventing the rubber bands from slipping off. But the principal reason for their use is the fact they will rotate with the movement of the film as it contracts or expands. Their smooth surface safeguards against scratching the film.

To accommodate the glass rods, slots are cut — as shown — in the reel ends with the bottom of the slots enlarged to allow for passage of the knobs. The rods are held in place by rubber bands suspended from metal hooks, as shown at

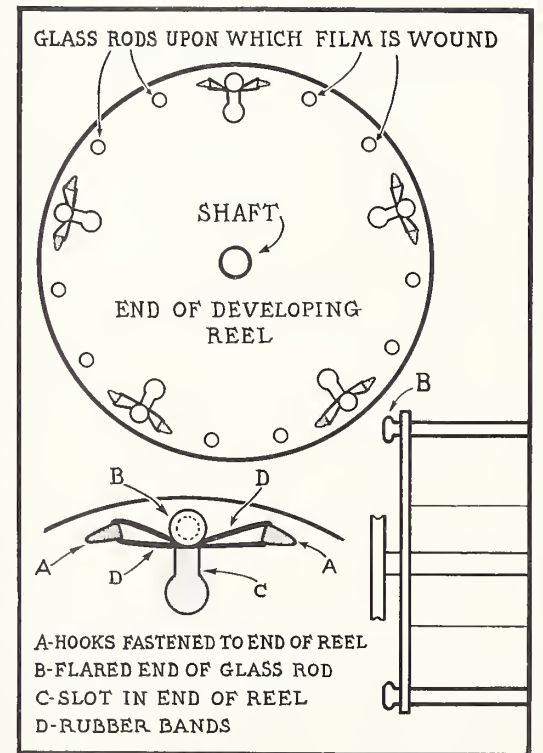

"A," and this arrangement completes the take-up feature. It is advisable to coat, with acid-resistant paint, these hooks as well as any other metal such as nails or screws used in the construction

• Continued on page 148

"IT'S NEW TO ME"

By CINEBUG SHOPPER

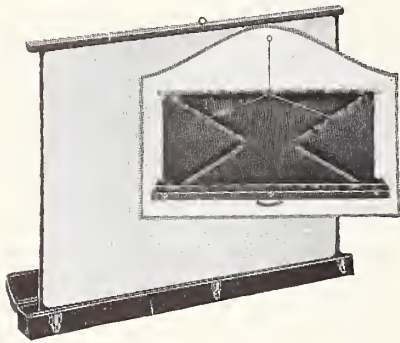

Beaded Screens

Among the several new photographic items recently introduced by the Raygram Corporation of New York City is the new Raygram Box Type Beaded Screen. Made of the finest Dupon screen cloth, carefully surfaced with uniform blue-white glass beads, it features an automatic frame that sets the screen erect ready for use as it is lifted from the case. These new Raygram Beaded Screens are available in a number of sizes at very attractive prices, according to the manufacturer.

Trial Titles Gratis

During the next few months, it is announced, special trial title making outfits will be sent free to readers of HOME MOVIES to provide an opportunity for first-hand demonstration of the Stein "A to Z" Titling Outfit. Write to Jacob Stein, 175 Fifth Ave., New York City.

Lighting Booklet

"Lighting the Stars" is the title of a highly interesting and instructive booklet authored by Gene Kornman, portrait photographer of 20th Century-Fox's west coast studios, and published by Korbar Publishing Company, 1058 N. Stanley Ave., Hollywood, Calif.

This booklet contains reproductions of many outstanding portraits of Hollywood's most famous stars, with lighting diagrams and complete photographic instructions explaining how these portraits were

produced and illustrating the use of Bardwell-McAllister "Foco-Spot" lights. The booklet is said to be of especial value to amateur movie makers interested in sincere indoor cinephotography.

Filmo Viewfinder

The "positive" type viewfinder which has proven such a popular feature on Filmo 141 and Turret 8 cameras, is now available for all Filmo 70 and Double-8 cameras now in use. Chief advantages are: First, the image remains fixed on the finder glass regardless of how operator's eye may



shift position in eye piece. Second: Full image always fills viewfinder, regardless of size of lens used. Masking to fit lens is eliminated.

Make-up Data

Recently Carl Dial, of Hollywood, gave a lecture on panchromatic make-up and portrait lighting, under the auspices of the Penn Camera Exchange, Inc. In order that their friends all over the country may not be deprived of this valuable information, Penn is making available a stenographic transcript of Mr. Dial's lecture. Copies are also available to anyone outside of New York City, but the supply is limited. So write soon if you want a copy to Penn Camera Exchange, Inc., 126 West 32nd St., New York City.

Pan Head

A new Tilt-Pan tripod head just introduced by Herbert George Co., 900 Merchandise Mart, Chicago, features modern streamlined design and precision workmanship that insures smooth panorama or tilting action comparable to professional equipment, according to the manufacturer. The entire device is beautifully chromium plated, making an attractive accessory for any amateur's kit of equipment.

Vaporate Service

Vaporate Company, New York, announces that arrangements have been made with some of the leading photographic dealers and supply houses throughout the country to provide local Vaporate service to home movie makers.

The Vaporate Process is not a physical covering applied to the surface of films, but is a toughening process which the film is subjected to that prolongs its life, and makes it more pliable and resistant to scratching and other effects of handling, according to the Vaporate Company.



Film Storage Case

One of the newest cabinets for storage of larger quantities of cine films is announced by the Neumade Products Corp'n, 431 W. 42nd St., New York City. The model illus-

trated will hold fifty reels in separate double-wall compartments that are complete with individual door, handle, and index card holder. The outer cabinet has a reinforced door equipped with a 3-point locking device and key. It is particularly adaptable for storage of films by schools, film libraries, etc. The complete line of Neumade film storage cabinets are illustrated and described in their catalog No. 16, available upon request.



Film Toning Colors

The popular new Mansfield single solution toners are now available in kits containing four 3-ounce bottles — one of each color — suitable for the amateur cinefilmer who wishes to tone scenes or titles for splicing into color reels. Twelve-ounce amateur size bottles of each color toner are available for those who wish to tone many scenes, and the professional size — the 32-ounce bottle — is recommended for those desiring to tone complete reels of film. Properly diluted, this larger size will make over four gallons of solution — sufficient to tone several 400-foot reels of film, according to the manufacturer. Trial samples are available at 10c each in coin to cover postage, when sent to Mansfield Laboratories, 701 S. La Salle St., Chicago.

Cine Transito, Jr.

Baia Motion Picture Engineering Co., Detroit, announce that the Cine-Transito, Jr. — an effects device for making

• Continued on page 147

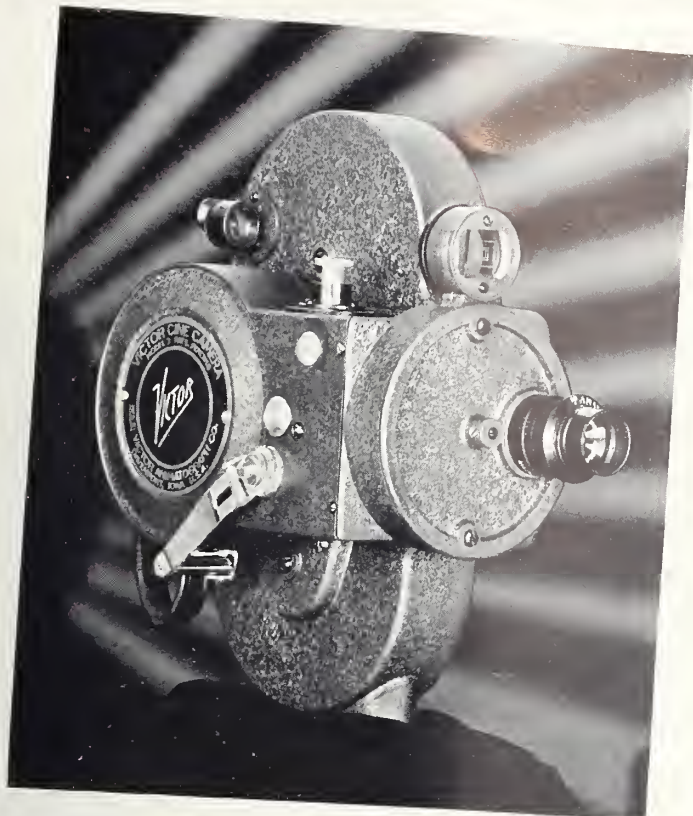

What A Prize!

This Victor Model 3 camera with f 2.7 lens and featuring five speeds will go to some lucky amateur in this contest. One of the finest of cine cameras, it features, in addition to the above, a compensating viewfinder sight, self-setting film footage scale, 205° Rotary Shutter, and beautiful golden bronze and chromium finish.

It takes either 50 or 100 foot spools of film of all kinds and brands. For fine craftsmanship and efficiency, this camera is unsurpassed, and it makes swell contest films!

Additional Awards

In addition to the awards already described, the following prizes go together to make HOME MOVIES' 1940 Annual Amateur Contest something really worth shooting for!

- Thal-metal Tripod and Tilt-Pan Head
- Seemann Titler
- Kemp "Commander" Electric Exposure Meter
- Besbee Effectograph
- Besbee Ediscope
- Besbee Titlescope
- Twelve rolls Agfa "Hy-Pan" Film
- Four Star Titler

These are only a few of the major awards. Other prizes will be announced later.

Home Movies 1940 Annual

AMATEUR CONTEST

—*Now On!*

*Open to all Amateur
Produced 8 and 16mm films*

America's most important Amateur Movie Contest is now in full swing with thousands of Cinebugs pointing their cameras toward the Lloyd Bacon Trophy, the Victor Model 3 16mm Camera, and all of the other swell prizes to be awarded the winners.

Every amateur movie maker is eligible to compete. You do not have to be a reader of HOME MOVIES magazine. You have this grand opportunity to attain nation-wide recognition with your movie-making; to match your artistic cine talents with other amateurs.

Get your camera into action today! Contest closes June 30, 1940—giving you just four months to complete and enter your films!

RULES

- Entries limited to 16mm and 8mm films. No 35mm reductions eligible. No restriction as to length or subject. You may submit as many entries as you wish.
- Transportation on entries must be paid both ways by contestant. Where return postage is omitted, film will be returned via express, collect. All entries will be promptly returned after review by judges.
- All entries should be titled at least to the extent of a main title. Adequately titled films improve their standing in the contest. Professional or laboratory produced titles are permissible.
- Be sure to label your film reels and containers, giving your name and address and the title of your production.
- No entry blanks are necessary. Enclose data with entry as to camera, lens, and film used; also, state whether filters, tripod, exposure meter, and any other equipment was used. This information has no bearing on the judging, but is of interest to the editors.

● Don't wait until final week to submit your films. Send them in as soon as ready. They will be reviewed, judged, and graded and a full report of same filed for consideration at time of final judgment. Films should be available for a second review by judges at close of contest if necessary.

HOME MOVIES

6060 SUNSET BOULEVARD

HOLLYWOOD, CALIFORNIA

Double your fun when you show **PARTY MOVIES**



Use G-E Photofloods when you take them!

Movies of birthday parties and every kind of indoor scene are twice as much fun for you and your friends to look at when they're crisp and clear . . . the kind of shots that G-E MAZDA Photoflood lamps make so easy to take. For these are the same high-efficiency type lamps that the big movie studios use . . . made to fit *your* needs by the folks who make the lamps for Hollywood. Try G-E Photofloods. The results will speak for themselves in color or black and white.



TWO SIZES fit most needs.
No. 1 20c list
No. 2 40c list
Available in Daylight bulbs for use with regular Kodachrome. And for extra lights, try G-E Photoflood R-2, bulb and reflector in one unit.

NEW G-E MAZDA Mighty Midget Photoflash
(Synchro-Press No. 5)
Plenty of light for most pictures. Highly effective in regular equipment—sensational in concentrating reflectors . . . carry as many as 30 midgets in one pocket! 20c list.



GENERAL ELECTRIC
MAZDA PHOTO LAMPS

Negative-Positive developing easy . . .

• Continued from page 126

the film to the rack will keep it tight when putting inserts in place. A few holes drilled in the sides of the racks will help the chemicals to reach the inner wrappings of film quickly.

An efficient wash tank can be made as shown in the illustration. Its dimensions are based on the size of the racks used and also the size of the wash trays or sink available. (Bathtubs are okay too, if the wife is broadminded.) A short rubber hose runs from the faucet to the small brass pipe soldered to the bottom of the tank. The water overflows at the top, thus thoroughly washing the film. Very heavy gauge galvanized steel should be used and the top reinforced. It need not be painted. Small wooden wedges will keep the racks in place. The small loading stand is also used to transfer the film to the drying rack after washing is complete.

THE drying rack illustrated is about 400-foot capacity and can be made for less than one dollar. The cross rods are five-cent round mop handles and the sides are 1x2-inch screen framing. Long nails hold the rack in place on the stand and 35mm positive film spools act as separators and washers. There is enough spring in the sides of the stand to permit the removal of the rack after loading and another rack inserted. Thumb tacks work well with these soft wooden mop handles. The outfit should be bolted or screwed—not nailed—together. Separator pins are optional.

As soon as the film is placed on the drying rack a clean, soft, damp chamois should be used to remove most of the water, and after the film is dry a slightly damp chamois can be used to remove watermarks from the back of the film.

Following are a few pointers:

Syphoning chemicals from large trays or tanks

is easier than pouring them.

Use tinted base stock for professional effects—blue for night scenes, etc. Toning, especially in sepia, can often “rescue” a film.

Before printing a large roll make several 2- or 3-foot tests, *timing everything*, and there need be no waste of positive film. Movie printing soon becomes easier than snapshot work.

Panchromatic film can be developed on the racks described in this article by the “touch and feel” system, but guide pins would help in this case. However, if pins are not used, 35mm film and other sizes can also be processed on these racks.

Don't project any recently developed film until it is thoroughly dry. Drying sometimes takes as long as 24 to 48 hours, depending upon climatic or weather conditions. A film may seem dry after a few minutes on the drying rack, but actually the emulsion will be quite soft and easily damaged by scratching or con-

tact with fingers. A small electric heater, properly rigged, will speed up the drying process, but extreme caution must be exercised, as an excess of heat will shrink or curl the film. A flow of warm air—not hot—should pass over the film.

BE sure to keep the film loose on the rack while drying, otherwise it will bulge out of focus when projected—may even dry, stretched to a point where it will not pass through the projector because the sprocket holes no longer fit the sprockets.

For illumination, during the positive film developing process, a Wratten Safelight Series O-A will give plenty of safe, green-yellow light and is a big improvement over the old-fashioned red Safelight.

As previously intimated, there are only a few simple steps necessary in developing either negative or positive film. The negative, after it is exposed in the camera, must be developed, washed, fixed, washed again

NEGATIVE FILM DEVELOPER

INGREDIENT	AVOIRDUPOIS	METRIC
Elon116 grains	8.0 grams
Sodium sulphite131¼ ozs.	400.0 grams
Hydroquinone290 grains	20.0 grams
Borax116 grains	8.0 grams
Water to make	1 gallon	4.0 liters

POSITIVE FILM DEVELOPER

INGREDIENT	AVOIRDUPOIS	METRIC
Water (125° F. or 52° C.)	64 ounces	2.0 liters
Elon17 grains	1.2 grams
Sodium sulphite desiccated5¼ ounces	160.0 grams
Hydroquinone350 grains	24.0 grams
Sodium carbonate, desiccated2½ ounces	75.0 grams
Potassium bromide50 grains	3.6 grams
Citric acid40 grains	2.8 grams
Potassium metal bisulphide85 grains	6.0 grams
Cold water to make	1 gallon	4.0 liters

Time required for development is 7 to 15 minutes at 65° F. or 18° C.

and then dried thoroughly.

After a positive print is made of the negative, the positive film must be developed, washed, fixed, washed again, and then dried.

The developers required for both films—and each requires a different developer—may be purchased already prepared at most photographic supply stores. Given here is one of the most popular formulas for a negative film developer and data on compounding and using same:

Dissolve the elon in a small volume of water (at about 125° F.—52° C.), and add the solution to tray or developing tank. Then

dissolve approximately one-quarter of the sulphite separately in hot water (at about 160° F.—71° C.); add the hydroquinone, stirring until completely dissolved. Then add this solution to the tank. Now dissolve the remainder of the sulphite in hot water (at temperature previously indicated), add the borax and when dissolved, pour the entire solution into the tank. Dilute to the required volume with cold water.

Time required for development is 10 to 20 minutes at 65° F. (or 18° C.).

The *positive* film developer is also a very popular formula.

Can I improve my Film?

• Continued from page 129

ing from his height down to a little shaver just a few years old. This "gag" shot completes the picture.

Editing: The tempo and life of this picture depended upon good editing. The cutting from the amateur scenes to the professionally made scenes was well done, and these latter scenes were not long enough to make them noticeable as being of different photography. The animal scenes were taken from Castle Films' "Camera Thrills in Wildest Africa." A cartoon shot of a lion was taken from one of the Walt Disney animated cartoon series; and a shot of canoeists shooting the rapids was taken from an Eastman library film.

Because some of these shots were on amber film, this amateur very ingeniously made prints of them on black and white stock by using his camera for a printer. According to his report, the film was exposed by holding a 60-watt lamp against the lens with the aperture set at *f*/8.

Titling: Was very satisfactory, well exposed, and nicely worded. The placement of titles throughout the film was well done and there were a sufficient number to carry the story along.

Photography: It is only natural that there would be some variation in the photography, due to the differ-

ences in density between this filmer's own shots and those of the library subjects. However, the interest in the picture runs so high that this variation is scarce-obvious.

"CONSCIENCE" ★★★

200 ft. 8mm—by P. W. C.

Continuity: This is a simple story involving a counterfeit half-dollar. Two men, walking toward an automobile, stop and chat a moment. One asks the other for the half-dollar owing him. After receiving it, he feels of it suspiciously, and after testing it, discovers it to be counterfeit. With his pen he marks it "No good," puts it into his pocket, and drives away. On the way homeward he stops to buy a newspaper. After reaching home he cannot find the phoney half-dollar, and he believes—to his dismay—that he gave it to the newsboy. This worries the man, and he continues to think about it while reading the newspaper after dinner.

Presently he falls asleep and dreams that the half-dollar—now greatly enlarged—is after him. (For this and other scenes that follow, a replica of the half-dollar was built about three feet in diameter.) In his dream we see him on the street. A policeman grabs him. He breaks away and dashes through a park where children are playing. One of them is the news-

Use a KODAK BANTAM SPECIAL FOR "STILL" SHOOTING

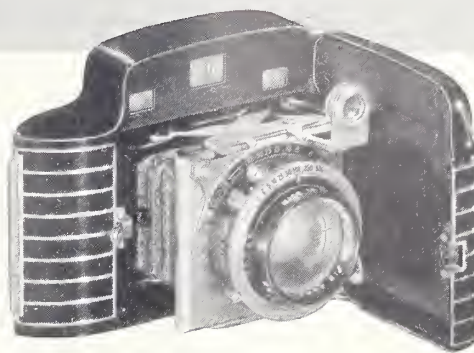

KODAK Bantam Special has every qualification needed to make it the movie maker's ideal fine "still" camera. It is compactly . . . sturdily . . . precisely made. Its lines are smartly beautiful. And its exceptionally fast Kodak Ektar *f*/2.0 lens and accurate 1/500 Compur-Rapid shutter

allow it to handle fast action and

difficult light conditions with ease. Through modern photofinishing methods, Kodak Bantam Special leads to 2¾ x 4-inch black-and-white pictures. Also loads with Kodachrome for lovely full-color transparencies. Has built-in range finder and other important features. With tan leather field case, \$87.50. At your Kodak dealer's.

Only Eastman Makes the Kodak

EASTMAN KODAK COMPANY, ROCHESTER, N. Y.

GET A BOOL AND 64 VARIETIES OF FADES AND DISSOLVES

EVERY MOVIE MAKER NEEDS A BOOL CINE-FADER

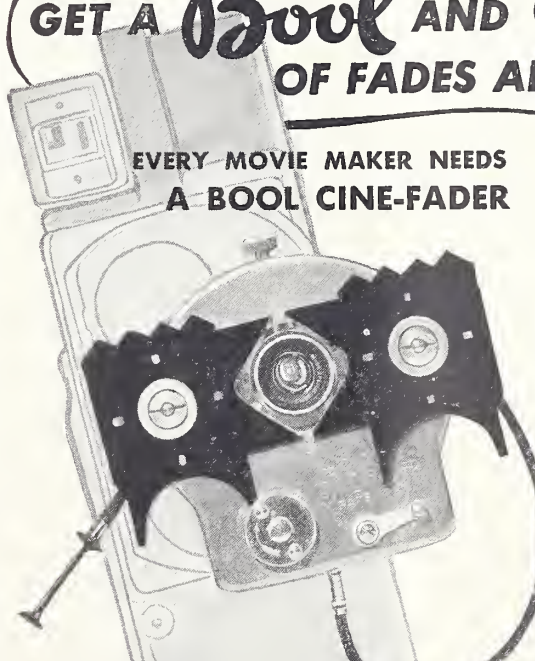

Technique is an overworked word, but it alone conveys the idea of one important difference between interesting movies and just motion pictures. Scene transitions and special effects assist the easy flow and story value of a film. Fades and dissolves—expertly made—and widely varied for novelty are part of good technique. The handy BOOL makes all sorts and kinds of fades and dissolves "as you go," and they are timed and operated by the clockwork mechanism. It is not necessary to remove the eye from the viewfinder when operating the FADER. Yes, the BOOL offers 64 different basic effects—sharp or soft—also serves as filter or mask holder. Get a BOOL today and start making real movies.

FITS MOST EVERY MOVIE CAMERA

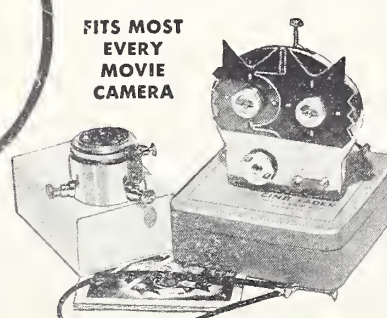

The BOOL CINE-FADER also operates on any projector lens. Fits all lenses of from ½" to 1½" diameter. Weighs only 6 oz. Complete with extension tube, cable release, and instructions. \$17.50

See your dealer or write for illustrated folder

AMERICAN BOLEX COMPANY

155 EAST 44TH STREET NEW YORK, N. Y.

THE IMPERIAL
"Master"
 PRINT DRYER

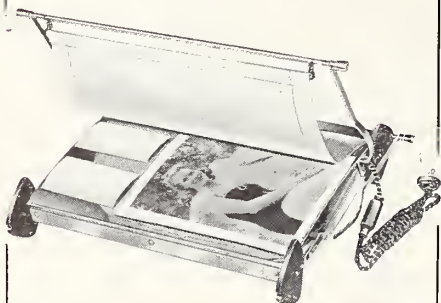

A Quality DRYER
 at a
 Moderate PRICE

•
 Double Faced
 Two Drying Surfaces

THE IMPERIAL MASTER PRINT DRYER is a precision electrical instrument, ruggedly designed to give long and satisfactory use. Heat intensity is thermostatically controlled to prevent overheating and damaging of prints. It is a double-faced unit with a maximum of drying area accommodating two full 11x14" prints at a time or larger quantities of smaller sizes. It has been insulated throughout according to rigid standards and consumes a minimum of current, only 200 watts. Minimum convexity of the drying surfaces insures even heating and uniform drying of prints within the shortest drying time.

\$12.95

Mail Orders Filled, Postage Prepaid
 Write Dept. H. M. I.

Willoughbys

World's Largest Camera Store
 Built on Square Dealing

110 West 32nd St., New York
 Near 6th Avenue

boy to whom he believed he gave the phoney half-dollar. He stumbles, and all of the children pounce upon him, beating him with the large half-dollar.

The next morning he seeks out the newsboy and buys another paper, this time giving the boy a good half-dollar and refusing to accept the change. This clears his conscience. Walking down the street, the man reaches for a cigarette, and while searching his pockets for a match, finds the counterfeit half-dollar. Angrily, he throws it into the street, and a closeup follow-shot shows it rolling along the gutter and ultimately into the sewer.

Editing: Picture was well cut. We would suggest shortening the first scene a little, eliminating some of the footage of the men walking toward the car up to the point where they stop to talk. This would step up the action and set a better pace for the picture at the start.

Titling: Titling was good, well centered, and in keeping with the picture.

Photography: The double exposure, introducing the dream where he sees the newsboy, whenever he looks

about the room, was very well done. Photography was consistent throughout, with good exposure, steady camera, and all scenes well framed.

"THE SCHOOL MUSEUM" ★★★
 400 ft. 16mm—by F. E. G.

Continuity: This is a record of a museum assembled and maintained by a large New York City public school. The picture shows how the materials are prepared, how the museum is used, and other activities. The picture opens with a long shot of the interior of the museum where we find many of the students active in museum duties. Closeups follow showing the children in various activities such as preparing materials for exhibit, etc.

The showing of motion pictures by the pupils is a part of the school museum program and there is a sequence depicting students caring for films, projector, and conducting an exhibition of films.

It is an orderly film. The continuity has been well worked out and a fine document of the school museum activities has resulted.

Editing: The picture is

well edited. As a rule, educational picture scenes run longer than do those of theatrical or entertainment films. This is necessary to give pupils more time to assimilate the subject visually. It appeared, however, that the opening shot could have been cut a bit so as to get into the first closeup sooner. Otherwise there was an even tempo to the editing throughout.

Titling: Consistently good throughout, with the titles well worded, nicely centered and correctly exposed.

Photography: This picture must be credited with a high average of good photography. Most of it was shot indoors and there was fine consistency in lighting, exposure, and focus.

Note: This picture was made by a picked group of boy and girl students of the seventh and eighth grades, and made after school hours and over a period of several months. The actual photography was done by the entrant of this film, but the student camera crew assisted with lighting, exposure, etc. Over 80 per cent of the film exposed was usable for the finished production.

You filmed it -- now record it . . . !

• Continued from page 125

prices from electrical, radio, and hardware supply houses in every large city.

NEXT is the turntable which differs from the ordinary phonograph record turntable in that it is considerably heavier—usually a solid aluminum casting about an inch and a quarter in thickness. It is the "flywheel" of the motor as well as the turntable dynamically balanced to insure smooth, unvarying speed.

Last, but not least, is the drive screw and cutting head which is driven by reduction gear from the same source of power as the turntable. Some are driven directly from the pinion extending through the center of the turntable.

The illustrations which accompany this article show "the works" of the average recording outfit. Note the heavy castings used to hold the motor and drive pulleys,

and the rubber pads which insulate this part of the mechanism from the turntable.

The two-step pulley is for altering the speed of the turntable. With the larger pulley, 110 lines may be cut to the inch. With the smaller, 120 lines. The more lines per inch, the longer the record will play. The belt drive is used throughout to insure against transmission of motor vibration to the recording head.

All bearings are of bronze. Ball or roller bearings are never used in the construction of recorders as a further measure of safety against vibration. So, in constructing your recorder, remember that total elimination of vibration and transmission noises is essential if good clear recordings are desired.

Now, with the recorder either built or purchased, you still need the means for

picking up speech, music, and sound effects and transferring them to the record. This requires a microphone and an amplifier. If you have a good radio, or a radio phonograph, your amplifier is already in your possession and all that you will need to purchase is the microphone. Suitable "mikes" are to be had for as little as \$3, but of course, as with everything else, if you can afford the better kind, it will pay to invest in it for the improved quality of sound and undistorted speech it will insure.

THE dealer from whom you purchase parts and equipment will be glad to show you where and how to connect the lead wires, from the cutting head and your microphone, to your radio in order that all three will operate satisfactorily as a single recording unit.

With your outfit complete the first thing to do is to

make a few test recordings in order to familiarize yourself with its operation; locate and eliminate the "bugs," if any; and to test the various types of discs to determine the kind best suited for your purpose. Recording discs are available in a variety of sizes from six to sixteen inches in diameter and in a number of substances, including acetate, aluminum and flexible plastic. The best discs have an aluminum base with a high quality acetate cutting surface, and can be had for as little as \$1.80 each.

A low priced recording disc well suited for amateur use is the flexible plastic disc with a bristolboard base. Manufacturers claim a remarkable low noise level for this type of disc with excellent frequency response, and the twelve-inch double surface record may be had for as little as 75c.

Another innovation which should not be overlooked in the construction of your recorder is a playback pickup that will enable you to immediately play back what you have recorded.

At 78 revolutions per minute, a twelve-inch record will play between 4½ and 6½ minutes, according to the number of lines per inch at which it was cut. A twelve-inch record cut and played at 33⅓ R. P. M. will play between 7 and 12 minutes, depending upon the number of lines per inch at

which it was cut. Most sixteen-inch records are recorded at 33⅓ R. P. M. and play approximately 15 minutes.

With this data at hand, you are in a position to know how much recording you will require to accompany a reel of film of a given length. 16mm film, running through the projector at 16 F. P. S., or 24 feet per minute, would require a 15-minute 16-inch recording for 360 feet—almost one full reel. The same would apply to a 200-foot reel of 8mm film.

A full reel of 8mm or 16mm film would require the use of two and possibly three separate 12-inch 33⅓ R. P. M. recordings and the use of a double turntable on which to play them so they may be faded or dissolved into one another during projection of the film.

The making of recordings is a fascinating hobby in itself; and between the two—recording and filming—one can be kept pretty busy day and night. And the amateur who will build his own outfit will probably enjoy all the thrills and fun he encountered when first he set out to make his own movies. There is no question but that these two arts, affinity-like, belong together, and that the coming months will see greater activity than ever among amateurs bent upon joining sound with their films.

16mm Newsreel makes good

• Continued from page 116

spite of the fact that the theater's program changes three times a week. It is shown immediately after all other "short" reels and just preceding the main feature. It is accompanied by appropriate background music supplied by records played from the booth on the P. A. system. Otherwise, the newsreel is silent—the necessary commentary being supplied by descriptive titles which Boice also makes himself. When the occasion presents, he uses some of the title backgrounds from HOME MOVIES magazine for lead titles of some news events.

Soon the "Strand News"

will be presented with sound and dialogue accompaniment. Plans are under way for the purchase of a cutting head that will enable Boice to make a recorded narrative for each newsreel. Only lack of time has prevented him from doing this in the past. After all, aside from the arduous duties of managing a bustling moving picture emporium, filming, editing, and titling a 100 to 200 foot newsreel every week is a big job in itself.

BOICE does not process his own films but sends them in to Chicago—a distance

FOR MOVIES OF THE HIGHEST QUALITY



THE WORLD'S FINEST
16MM AND DOUBLE-8MM

BOLEX

Only Bolex has these exclusive features—

- ★ **AUTOMATIC THREADING**, with loops formed mechanically. Assures quick, accurate changing of films, and prevents jamming.
- ★ **LATERAL SPRING TENSION** in gate assures rock-steady pictures.
- ★ **CLUTCH TO DISENGAGE SPRING MOTOR** for forward or reverse filming by handcrank. Simplifies the making of lap-dissolves, super-impositions, and reverse action.
- ★ **FOCAL PLANE SHUTTER**, 190° rotary disc—an important reason why BOLEX pictures are always superior in photographic quality.
- ★ **SEMI-CIRCULAR, 3-LENS TURRET** which provides a clear field for use of the wide-angle lens while telephoto lenses up to 4-inch focal lengths remain in the turret.
- ★ **TRI-FOCAL, PARALLAX-CORRECTING, OPTICAL VIEWFINDER** gives accurate fields covered by each of three different lenses.

★ **SINGLE-FRAME MECHANISM** for making animations and "still" pictures, at speeds of 1/20 to 1/80 second and time exposure.

Besides these exclusive features, Bolex also has of course, practically every other feature found in the best cameras.



Write today FOR THE NEW BOLEX BOOK

AMERICAN BOLEX CO., INC. 7
155 EAST 44TH STREET, NEW YORK, N. Y.

I am interested in making better movies. Please send me your new free book about Bolex.

NAME.....
ADDRESS.....
CITY..... STATE.....

OIL on your film makes your pictures flicker on the screen.

VAPORATE
PEERLESS FILM TREATMENT

Prevents Oil Absorption and Permanent Oil Stains

AVOID eye straining punishment from SCRATCHES, SPOTS and STAINS. Looking at your pictures should be a pleasure for you and your friends.

Fraction-of-a-cent-per-foot-cost.

Nationwide facilities through your dealer.

Better Photo Finishers offer Vaporate protection for still negatives.

VAPORATE CO., INC.
130 W. 46th St.
New York

BELL & HOWELL CO.
1801 Larchmont
Chicago
716 No. La Brea
Hollywood

NOW! A NEW FASTER
8mm - 16mm

GRAPHICHOME BULK MOVIE FILM

Weston 12, Non-Halation - Reversible

FINER GRAIN—GREATER LATITUDE
HERE IT IS—the amazing new GRAPHICHOME PLUS! A top grade ORTHO FILM with FASTER speed for any 8mm or 16mm camera. GUARANTEED professional results for both outdoor or indoor pictures. Clear, clean, sharp. Look at the special prices below. Take advantage of these bargains! 200' 8mm GRAPHICHOME PLUS in double 8mm width..... \$1.85
Weston 12..... 4.65
100' Single 8mm (for Univex), Weston 12..... 1.10
GRAPHICHOME REGULAR! The same low prices on GRAPHICHOME Bulk Film with daylight leaders and trailers. 200' 8mm, \$1.75. 400' 16mm notched in 100' lengths at \$1.00. Professional results GUARANTEED.

GUARANTEED PROFESSIONAL PROCESSING
100' 16mm..... 85c 25' Dbl. 8mm..... 50c
Join the hundreds of other smart movie camera owners and order your film from SUPERIOR BULK FILM CO. We GUARANTEE satisfaction or your money back. All orders shipped same day. If remittance comes with order, WE pay postage. If C. O. D., postage is added. Send your order TODAY.

FREE LITERATURE! MANY BARGAINS!

We have many bargains to offer the camera owner. Write TODAY for FREE literature. No obligation. Address SUPERIOR BULK FILM CO., Dept. HM-3, 188 W. Randolph St., Chicago, Ill.

**YOU CAN'T GO WRONG—
WITH THE EFFICIENT**

Cinea 30 FILM SPLICER



**FAST AND
ACCURATE**

**PERFECT SPLICES FOR BOTH 8mm
AND 16mm SOUND OR SILENT FILM**

You can splice film easier with a Cinea 30—trim—scrape—splice—bing—bing—bing—just like that—no wasted motion. And you make more accurate splices, because five staggered pins and tightly fitting covers hold the film ends in exact alignment. The Cinea 30 is all metal with working parts under steel spring tension assuring clean splices and the pressure plate applies strong even pressure. Splices properly made are stronger than the film itself. You can't go wrong with a Cinea 30..... **\$10.00**

Cinea-WINDERS

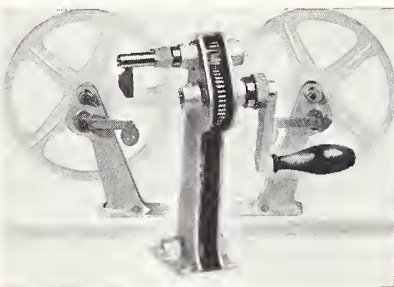

**HANDLE BOTH 8mm and 16mm REELS—
ADJUSTABLE TENSION AND DRAG**

This exclusive feature of adjustable drag on both winders prevents back spinning—leaves one hand free. Fine-cut gears and large, easy-grip wooden handles make operation smooth and quiet. Cinea-Winders take both 8mm and 16mm reels up to 800-foot. (Auxiliary bases which increase capacity to 1,600-foot reels are available.) For the best—insist on Cinea-Winders..... **\$9.00**



Cinea FILM CEMENT

The only film cement for all kinds of film—acetate or nitrate—35mm, 16mm, or 8mm. Cinea Cement is odorless, slow to evaporate from corked bottle, yet it joins film quickly and securely. At all better photographic stores, per bottle..... **25¢**

See your dealer or write to:

**AMERICAN BOLEX CO.
155 EAST 44th STREET • NEW YORK**

of 120 miles. The films, completely processed, are back in his hands within thirty-six hours and are immediately taken to the projection booth, where they are screened. Titles are written, then photographed and immediately shipped to Chicago for processing. Thirty-six hours later they are being edited into the "Strand News." It is not uncommon to find Boice in the Strand's projection booth in the early hours of the morning, sleeves rolled up, putting the finishing touches on the next week's "local" newsreel.

The fact that a theater manager is sufficiently sold on the "local" newsreel idea to go out and make the pictures himself is ample testimony of the box-office success of such a venture. Remember—Boice is strictly an amateur movie maker. He never made professional movies in his life. But in spite of the fact that his business compels him to view motion pictures the greater part of his workaday life, he never tires of movies. Making movies is his hobby and he is particularly fortunate in being able to "cash in" on this hobby through the medium of his

local 16 mm news-reel.

Nor is Boice the only theater manager to recognize the box office potentialities of a local or neighborhood newsreel. The idea is gaining momentum—especially in small cities and communities where pictorialization of a local event and its theatrical presentation assumes greater importance than in large cities where motion-picture houses exist in greater numbers.

ALERT amateur movie-makers in every city interested in expanding the scope of their filming activities may well investigate the possibilities of producing a local newsreel for their home town or neighborhood theater. The surest way to gain a hearing with any theater manager is to be able to show what you can do. Go out and make a newsreel and bring it to his office completely edited and titled and screen it with your projector.

If your work is good and the theater's manager will recognize its box office possibilities, he won't hesitate to lease or buy a high powered arc projector that will be required to screen it.

Title centering easy . . .

• Continued from page 127

areas are shown in Fig. 2. They probably won't coincide, in fact they shouldn't—one will be higher than the other, lower, or further to one side—but that's as it should be.

The fact remains, however, that as long as the camera is just 20 inches from the lens and the finder is aligned with its field, the lens will be covering its own field, and unless the distance between camera and title is changed, this centering idea can be depended upon.

THE amateur who takes his title making seriously will eventually want to construct a titler with which to increase his styles and kinds of titles. We are not interested here in the actual construction of such a titler, since previous articles in past issues of HOME MOVIES have discussed

many good ones; but we would like to point out one rather important detail which should be considered in the building of any titler if well-centered titles are desired. This quality is that of having the camera support so constructed that when the camera is removed and again replaced on the titler *it will return to the identical spot each time.*

Such a feature means, of course, that the entire titler and camera support must be well-made and very rigid. The camera support especially must be strong and so made that the camera will always rest in exactly the same position. Under these conditions the amateur can expect consistently well-centered titles. Once the rigid titler is made, the title fields are next determined.

First of all, place the

PEERLESS "PLUS+VIOLET" REVERSIBLE MOVIE FILM ASSURES YOU OF BETTER MOVIES

"PLUS+VIOLET" is the kind of film you have often wanted but have been unable to find in its class price.

"PLUS+VIOLET" is a medium speed (Weston 12, Scheiner 20), fine grained outdoor type film with wide latitude anti-halo backing and a special base which filters out all of the low frequency rays of the projection lamp, giving upon the screen a more brilliant and pleasing picture.

"PLUS+VIOLET" is not just another cheap film at a low price, but is a SUPERIOR film in the low price class. It is offered as a splendid film for those who wish to get good results on a limited film budget.

A trial will convince you that "PLUS+VIOLET" will enable you to take more and better shots for less money. Order today one or more trial rolls of "PLUS+VIOLET" at these attractive prices:

25 ft. double 8mm on daylight loading spool, including processing and return transportation, \$1.00 per roll postpaid to you.

4 ROLLS FOR \$3.50

100 ft. 16mm on daylight loading spool, including processing and return transportation, \$2.35 per roll postpaid to you.

4 ROLLS FOR \$8.00

"PLUS+VIOLET" PANCHROMATIC

A high speed fully panchromatic "PLUS+VIOLET" reversible film with a speed rating of Weston Daylight 32 and Mazda 20—Scheiner Daylight 24 and Mazda 22. 100 feet 16mm on daylight loading spool, including processing, \$4.50, or 3 rolls for \$12.00 (8mm not available).

SPECIAL TRIAL OFFER

One 100-foot 16mm roll each of our regular "PLUS+VIOLET" and one roll of our Panchromatic "PLUS+VIOLET"—a \$6.85 value for only \$5.00. Limit two rolls to a customer.

Sold Only by

PEERLESS OF HOLLYWOOD

P. O. BOX 1310-H

HOLLYWOOD, CALIFORNIA

USE METAL LETTERS FOR MAKING TITLES

Ask for Samples of the Most Beautiful Capital and Lower Case Letters Made



Assortment 222 pieces in wood case, \$7.16 postpaid in U. S. Outside add \$1.00. 126 caps and figures in box, \$1.28. Order white or black letters. **YOUR FILMS are not COMPLETE until you TITLE them; adding real interest value for you and your friends.** P. O. BOX B

Knight & Son, Inc., Seneca Falls, N. Y.

• We want suggestions and ideas for random "backyard" filming; also for simple home movie scenarios. Those which are published will bring the contributors either a 100-ft. 16mm or a 50-ft. 8mm film subject selected from the advertisements or catalogues of any library or producer-advertiser in HOME MOVIES magazine.

For ideas that can be adopted to a feature length article we will reward the contributor with two rolls of panchromatic film. Address your suggestions to BACKYARD MOVIES, care of HOME MOVIES, 6060 Sunset Boulevard, Hollywood, Calif.

camera in its place and with the lights on a piece of newspaper or similar material, shoot a few frames. With the aid of a magnifying glass, note the exact field shown on the film strip. This field is drawn on the newsprint (which hasn't been removed from the title board yet) and shows the exact field covered by the camera lens. The field should now be transferred to the title board itself, where it remains permanently.

Many amateurs make the mistake of projecting the film strip and using the "projected" area on the title board. This is, of course, incorrect, for as a rule the aperture in the projector is slightly smaller than the same opening in the camera film gate. Consequently the area projected is not the same as the camera lens records. The careful worker will want the exact area photographed and will therefore determine this area by inspection rather than projection. However, it might be wise to mark with a fine dotted line or colored pencil the projected area together with the actual lens field since there are times when the amateur will find such information useful.

If the camera support has been made as previously mentioned, so that the camera is placed in the identical spot each time the titler is used, the field will remain the same until some change is made, either in the distance from camera to title or in some other respect.

And while we're discuss-

ing centering methods, here is another which some workers often find useful. If your titler is of the zooming variety, run the camera up to the title board until the lens touches it. With a pencil mark a light line around the lens on the title board. As the camera is moved back, this circle will be in the center of the area. By marking the center of the circle, the center of the title field is thus determined. To find the field covered with a 1-inch lens on a 16mm camera or a 12 1/2-mm lens on an 8mm camera, one-fifth of the distance from lens to board is marked on each side of this center (Fig. 3).

FOR example: The camera is moved back 20 inches. One-fifth of 20 is 4. A line 4 inches long is marked to the left of the center spot and another the same length to the right. This gives us a line 8 inches long with the center of the field in the center. Our title field is 8 inches wide. Since we know the field's height is three-fourths its width, it is but a simple matter to determine the height of the field, which is 6 inches, and so mark it. We now have the field and we know it is centered. There's one bugaboo lurking here, and that is, that although the exact center and field have been found, the field isn't necessarily level. If the camera sets level in its track, and the horizontal line through the center of the title field is likewise level, the title will not appear tilted. This same precaution holds true for the plumbline method described in Fig. 1. The wise amateur should test all of these methods freely. Tests are much cheaper than a roll or two of film and a wasted evening.

Below is a chart of areas covered by the standard 25mm lens of 16mm cameras and the 12 1/2mm lens of 8mm cameras:

DISTANCE	AREA
8 in.	2 3/8 x 3 1/4 in.
10 in.	3 x 4 in.
12 in.	3 5/8 x 4 7/8 in.
15 in.	4 1/2 x 6 in.
18 in.	5 3/8 x 7 1/4 in.
20 in.	6 x 8 in.
24 in.	7 1/4 x 9 1/2 in.
30 in.	9 x 12 in.
36 in.	10 3/4 x 14 1/4 in.
4 ft.	14 1/2 x 19 in.
5 ft.	18 x 24 in.
6 in.	22 x 29 in.

GO TO THE MOVIES TONIGHT AT HOME

More than **40** big Hollywood stars to entertain you in 8 mm. and 16 mm. films.

Lough of Mickey Mouse, Donald Duck, Oswald the Rabbit and Meony, Miny and Moe, the three monkeys.

See Charlie Chaplin, Shirley Temple, Ann Shirley, Hugh Herbert, Joon Blondell, Deonno Durbin, Gory Cooper and others right in your own home!

Thrill to a trip through far-off lands with the movie cameraman; see the wonders of the microscopic world; have a ringside seat of sports events!

Hundreds OF FILMS TO SELECT FROM FOR YOUR HOME PROJECTOR

Actual reproductions of Hollywood movie companies reduced from their master 35 mm. studio films for 8 mm. and 16 mm. projectors, gathered together into the largest home movie library in America by SEEMANNS.

Only your SEEMANN dealer sells these professionally made films... and at astonishingly low prices.

SEE THESE FILMS AT YOUR NEAREST DEALER OR WRITE FOR CATALOG TO

SEEMANNS INC.

6628 Santa Monica Blvd. Hollywood, California
 In San Francisco — at 420 Market Street
 Sole Sales Representatives for
HOLLYWOOD FILM ENTERPRISES, INC.
 Hollywood, Calif.

"Up" Your Movie Making Skill— with these fine books!

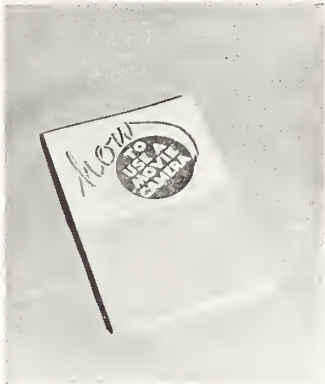

A new handbook for the beginner. Takes up where your camera instruction book leaves off. Contains essential data on fundamentals of making good home movies, boiled down in one small, easy-to-read volume. Makes clear in easy-to-understand terms the use of lenses, threading of camera, setting exposure, correct focusing, etc., and points out mistakes to avoid that will save many dollars in wasted film. Per copy.....

50c



The latest, most complete book on titling home movies which includes, in addition to complete plans for building the renowned Home Movies Titler, such data as Title Area Chart, Lighting Chart, Diopter Lens Chart, How to Make Trick Titles, Data on Use of Shims for ultra-closeups, etc. There's approximately 100 pages jam packed with vital information for every amateur movie maker. Price per copy.....

\$1.00

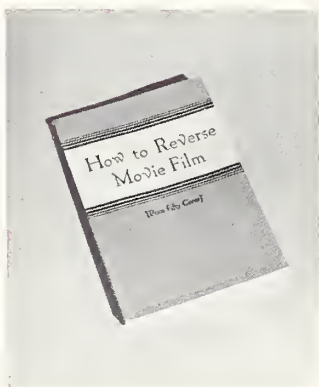

The leading textbook for the amateur on the subject of reversing home movie film. Over 5000 copies sold to date! Illustrates and describes how to build home processing equipment; gives all the popular reversal formulas; and tells how to intensify or reduce over- or under-developed films. Get this book today and start processing your own films for greater economy and pleasure in home movie making. Per copy.....

50c

If your dealer cannot supply you with any of the above books, send your order, together with check or money order, direct to us and same will receive immediate attention.

VER HALEN PUBLICATIONS

6060 Sunset Boulevard

Hollywood, Calif.

Watch framing for composition

• Continued from page 115

pictorial composition. An archway, tall trees and shrubs, all provide material for composition and the effect of depth in your scenes. Depth is the third important factor in composition—a quality which is more often obtained through judicious use or replacement of light. Yet a prominent object in the foreground of a scene, where the important composition is in the background, often lends the necessary quality of depth by virtue of the visual contrast between the two important objects in the picture. The accompanying illustration is an example.

IN exterior scenes, but more often in scenes made indoors under artificial light, proper placement of lights will produce the desired effect of depth. Outdoors, under bright sunlight, we should not have too much trouble seeking depth in our scenes if we watch for shadows. Here is a simple rule to follow: Pictures shot in late afternoon will have more depth than those shot at high noon. It has been found true that where flat lighting prevails, it is almost impossible to obtain depth in a scene unless we shoot the picture with some object in the immediate foreground.

So, if we study the scene carefully in the viewfinder of our camera and check it for the "one-third two-thirds" proportion; picture balance and depth; then composition will come just as naturally to us as threading film into our camera.

—Melvin W. Swansick

And now Dr. Smith's report:

Composition is the arrangement of masses in a given scene. It is of great importance to photograph a scene to best advantage and to make it pleasing to the eye. In travel scenes it is especially important to show the beauty of the scenes.

There are certain rules to follow:

Avoid bisecting a scene with the horizon. A straight line across a scene makes an

unpleasant division. Study your scene to get the best camera angles. After looking the situation over, then study the scene *through your viewfinder*. Often it will look different to you seeing it through your viewfinder but, remember, your viewfinder will give you a true picture of what you will see on the screen. Be sure you have the best possible composition before you push your starter button.

Buildings and statuary should especially be studied for camera angles to bring out the light and shadow effects. Be sure to get good sequences. Establish the subject as a whole if possible, especially waterfalls, mountains, buildings, etc., and then get some interesting closeups of interesting parts of them. Watch your camera angles here.

Make your scenes long enough to tell the story but avoid having them too long to become tiresome. Use extreme care about panning. Often it is much better to take individual scenes rather than to "pan." If you "pan" to show a waterfall, tall building, tree, etc., be sure that you do so slowly. Have your camera rock steady—*use a tripod*. Remember, you are taking scenes of moving things but keep your camera *still*.

IF you are traveling you will find it extremely valuable to purchase and study pictures or post cards of local views. Remember, these scenes are usually taken by a professional photographer who is familiar with the local scenery and has stud-

CORRECTION

- Through typographical error the price of the Eastman Kodascope "G," illustrated and described in HOME MOVIES First Annual Cine Show in the December issue, appeared as \$113.35. The correct price is \$130.00 without lamp. We regret any inconvenience that may have been caused our readers or photographic dealers by this error.

Use THRIFTY

16MM QUALITY FILM

A Money Saving "Thrifty" Film for Your Every Need

THRIFTY ORTHOTYPE

For OUTDOOR . . . non-halation base, fine grain, fast, Weston 8—the film you've been wanting to find at an unheard of low price. Machine processed. Per 100 ft. . . . **\$1.60** rolls.

<p>THRIFTY PANCHROMATIC</p> <p>Use for all types of shooting. High-speed Weston 16 daylight—10 photo-floods, machine processed. Per 100 ft. . . . \$3.75 rolls.</p>	<p>THRIFTY SUPER-PANCHROMATIC</p> <p>Super-fast; high sensitivity requiring minimum of light. Weston 50 daylight—32 photo-floods, machine processed. Per 100 ft. rolls. . . . \$4.25</p>
---	--

California Buyers Include Sales Tax

10% DISCOUNT IF YOU ORDER ONE ROLL OF EACH OF THE ABOVE FILM AT ONE TIME. Regular cost, \$9.60. Special discount price, \$8.64.

THRIFTY FILMS

Drawer 98, Watts Station Los Angeles, California

ied it and given time to composition. Then try to emulate his pictures.

Be sure there is a pleasing foreground in your pictures as well as a pleasing background. An object in the foreground gives depth to your picture. A tree, post or person or car, etc., helps. Usually these are best placed "off center" in your picture. A member of your party will do; or wait until a car or person comes along. Avoid using the same person in all your scenes—that often becomes tiresome to your audience. Also avoid hand waving. If you are on a boat taking a distant scene, a scarf blowing in the foreground is pleasing. Scenery viewed through trees, arches, tunnels or avenue of buildings is very pleasing.

Vary the masking of your scenes. Masking devices to fit most all cameras are available at a nominal cost. Distant ships viewed through a binocular mask is very effective. Your baby, mother or sweetheart masked through a heart is pleasing. Waterfalls, flowers, etc., viewed through oblong, round or hexagonal masks give a different and good effect on the screen. The star of your picture macked through a star is intriguing.

Remember! . . . Use your viewfinder . . . use a tripod, and use an exposure meter. Study your scenes carefully. Compose them effectively and your pictures will always be interesting and please your audiences.

—C. Enion Smith, M.D.

Professional-Looking

FADES LAP-DISSOLVES WIPES VIGNETTES

(Vig. and masks available at later date)

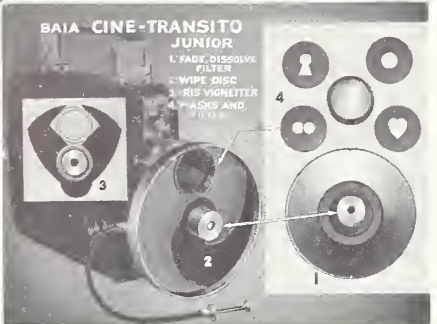

Operated by Clockwork

- ★ 12 Transitions on one winding.
- ★ Warning buzz—stops automatically.
- ★ Weighs only 4 oz.
- ★ Attaches to lens instantly and in exact center.
- ★ Packed in attractive kit.

Price \$7.95

With Wipe Disc Adapter and Cable Release
Accessories

FADE DISC	\$1.95
VIGNETTER	\$1.95
MASKS	25c each
Extra ADAPTERS	95c each

Specify Camera and Lens

From Your Dealer or Direct

WINDBACK: For Model K, has winding key with frame counter; on C-Kodak 8 includes 8 frames hand crank. Price **\$27.50**
Note: Clockwork installed on Cine-Transito, Jr., \$5.95 model.

BAIA MOTION PICTURE ENGINEERING
8044 Hardyke Detroit, Mich.

DO FILTER FACTORS FLOOR YOU?

... then ask about the new HARRISON Duraline FILTER SET—4 Filters, a Holder and Shade to meet 99% of all your requirements. With compact leather case—Easy instructions—New low prices. See them at your dealer today! . . . Or write for folder.

HARRISON & HARRISON
Optical Engineers
8351 SANTA MONICA BLVD. HOLLYWOOD, CALIF

"Oomph" Lighting . . .

• Continued from page 124

eral lighting and one for back lighting. Each girl receives a strong modeling light from the unit nearest her, and a flood of general illumination from the reflector on the opposite side. With the two front units placed as they are, the man at the end of the table was lighted uniformly from both sides. To cause him to stand out from the background and to relieve the flatness of the front light, a third unit was directed across the table from a doorway at one side and toward the rear of the room. With a film having Weston speed 16, a lens diaphragm opening of f/4.5 should give a satisfactory exposure.

No. 1 and that to the left a photoflood No. 2. Again the unbalance so necessary for "oomph." (Film Weston speed 16, lens at f/3.5.)

The fireplace has always been a center of interest in the home, spiritual and sentimental. As such at is a natural setting for home movies. Three photoflood lamps No. 2 were used in this scene; one a bare lamp in the fireplace, another in a reflector placed to one side and to the rear of the group to outline the figures, and the third directed toward the ceiling to create a low level of illumination over the group. The effect of flickering firelight may be achieved through the use of a small electric fan to the guard of which ribbons of cloth have been attached. With the fan properly placed, the strips of cloth blow in front of the lamp in the fireplace and by their movement create the illusion of firelight. Using a film of Weston speed 16, try the lens stopped at f/3.5.

The controllability and portability of modern light sources is a boon to the amateur cinematographer. Pleasure, satisfaction, and pride are the payments for a well-lighted, professional-appearing scene. Outdoors, we are at the mercy of the sun. Indoors, we may create lighting as we wish, including "oomph."

TYPICAL of a thousand shots, the cosy corner of the living room was filmed with photoflood lamps in reflectors and a photoflood No. 1 in the table lamp. Portable lamps are the main and in many homes the only source of light in the living room. Why not, then, create an atmosphere of naturalness by employing those lamps in the field of view as photographic sources? Since modern floor and table lamps are of the semi-indirect diffusing type, they must be supplemented with reflector units to create highlighting and modeling. The unit to the right of the camera used a photoflood

4 'SPOTLIGHT' BARGAINS

MOGULL-DUPLEX Sound Projector—NEW, 15-watt output, 12" speaker (regular \$410). Introductory Special, \$289.50; RCA-VICTOR Sound Projector, like new, \$97.50; VICTOR "5," reconditioned, with f:1.9 lens, \$87.50; AGFA-MOVEX 16mm (originally \$100), \$34.55. Nation-wide Sound-Silent rental library. Monthly Terms Arranged. 1500 Specials in BARGAINNEWS—sent free.

MOGULL'S, 55 West 48th Street, New York, N. Y.

REEL CLIPS FREE!

This special offer is for MOVIE CLUBS ONLY. Send us the names of your club members who use Besbee Editing and Titling Equipment and we will give you a generous FREE supply of Besbee Reel Clips for club use. Specify 8mm or 16mm.

BESBEE PRODUCTS CORP.
TRENTON, N. J.

FOTOFADE

FADES, WIPES Can be added to your Reels after Processing WITH FOTOFADE on black and white or color films. Price \$1.00. Waterproof Wipeoff Tape. 60c per roll. Complete Fotofade Kit. . . . \$1.60

CINETINTS for coloring your 16mm or 8mm film. Set of six colors \$3. At your Dealer or direct.

DYE RESEARCH LABORATORIES
318 Jackson Street Los Angeles, Calif.

A NEW NAME THE SAME GOOD SERVICE

Editing, Genuine Kodachrome Titles, Tinted and Positive Stock Titles

HORNE MOTION PICTURE SERVICE
9 East 40th Street New York City

Better Movies with BLACK and WHITE FILM

Reversible Film 25 ft. Dbl. 8mm **98c** Includes Processing

Rating Weston 12 Scheiner 18

At your dealer or direct. Fast service processing same day included at no additional cost.

VISUAL INSTR. SUPPLY CO.
1757 B'way Box H11 B'klyn, N.Y.



PUT COLOR INTO YOUR BLACK and WHITE REELS

- Color Titles for Kodachrome
- Color Prints, Transparencies, Etc.

MANSFIELD

SINGLE SOLUTION COLOR TONERS
Blue - Brown - Green - Magenta

Add glamour and new life to your motion picture reels with color. Tone those interesting scenes in a suitable color—alternate with colored titles to give your reels a professional quality. Only one solution to use. No dark-room necessary. Anyone can do it. Improves projection quality. Fine for coloring black-and-white titles to be spliced into Kodachrome reels. May also be used on snapshots, enlargements, transparencies, lantern slides, etc. Amateur 12 oz. bottle, any color, 95c. Professional 32 oz. bottle, any color, \$1.25 (enough for thousands of feet). Kit of all four colors, \$1.95.

SEND FOR TRIAL SAMPLES

Test for ease of processing . . . for beauty in projection quality . . . for richness of color. Send 10c (coin) to cover packing, mailing, etc., for trial sample, sufficient to tone several cine titles. Specify color. All four for 35c.



MANSFIELD PHOTO RESEARCH LABS.
701 So. LaSalle St. CHICAGO, ILLINOIS

NEW LOW PRICES GUARANTEED FRESH FILMS

Complete New Reversal and
Title Instructions Sent Free;
Separately, 25c Each

SUPER CINEPAN REVERSAL

Weston 24-16 — Non-Halation Base

25 ft. Double 8 Not Scored	\$1.10
100 ft. Double 8 Not Scored	3.80
25 ft. Straight 8	.70
100 ft. Straight 8	2.10
100 ft. 16mm	3.35

CINECHROME REVERSAL

Weston 8-2 — Non-Halation Base

25 ft. Double 8 Not Scored	\$.65
100 ft. Double 8 Not Scored	1.85
25 ft. Straight 8	.45
100 ft. Straight 8	1.15

New Super Cinepan and Cinechrome are factory perforated. Will NOT jitter. Fully daylight loading when spooled. Spools and processing extra.

SUPER PANCHRO REVERSAL

Weston 24-16 — Anti-Halo Backing

25 ft. Double 8 Not Scored	\$1.20
100 ft. Double 8 Not Scored	3.90
25 ft. Straight 8	.75
100 ft. Straight 8	2.20
100 ft. 16mm	3.50

Super Panchro is reperfected. NOT recommended for Keystone or Stewart-Warner 8 Cameras. Works perfectly in all other makes. Fully daylight loading when spooled, as colloidal silver backing protects. Spools and processing extra.

WESTON 8 SEMI-ORTHO REVERSAL

Darkroom Loading — Processing Extra

25 ft. Double 8 Scored	\$.50
100 ft. Double 8 Scored	1.50
400 ft. Double 8 Scored	4.50
25 ft. Straight 8	.30
100 ft. Straight 8	1.00
400 ft. Straight 8	2.75
100 ft. 16mm	1.15
400 ft. 16mm	4.00

Clear and lavender, scored. Amber, blue, yellow, reperfected. NOT scored. NOT recommended for Keystone and Stewart-Warner 8 Cameras. Any film notched upon request. With spliced SUPER-SAFE daylight leaders, 10c per Straight 8 roll; 15c per Double 8 roll; 25c per 16mm roll, extra.

CINE-KODAK POSITIVE TITLE FILM

Darkroom Loading — Processing Extra

25 ft. Double 8 Not Scored	\$.50
100 ft. Double 8 Not Scored	1.35
25 ft. Straight 8	.30
100 ft. Straight 8	.95
100 ft. 16mm	1.10
25 ft. 35mm Safety, Clear or Purple	1.00
100 ft. 35mm Safety, Clear or Purple	3.00
400 ft. Gevaert 16mm and Double 8 Scored	4.00

Clear, purplehaze, yellow, red, amber, special blue. Also lavender and salmon pink not Kodak make.

CAMERA SPOOLS WITH CANS

Double 8	\$.40	St. 8 Keystone	\$.40
Univex	.20	St. 8 Filmo	.50
100 ft. 16mm	.65	50 ft. 16mm	.35

Fit all cameras — unlimited quantities.
Extra Cans, 100 ft. and 50 ft. 16mm... \$1.10
Extra Cans, Double 8 and Straight 8... .05
400 ft. 16mm Cans, Non-Humidor, .25 ea., 6 for 1.00

Baja Precision 8mm Film Slitters	2.50
Fotofade Dye, per bottle	1.00
Fotofade Wine-Off Tape, Waterproof	.60
Cineprints, set of six colors	3.00
DuPont Viscose Sponges, each	.35
Baja Cine-Transito, Jr., with Fade	5.95
Fade, Wipe or Vignetter Discs, each	1.95
Cine-Transito, Jr., Masks, each	.25
Bolex Cinelac, Film Preservative, bottle	1.00
Intensifier, Makes 20 oz., Long Life	.50
Back Issues of Home Movies, 1936-37-38-39, each	.15

(Not all months.)
Film Processing, Eastman 8, \$1.00; Other Types, .65; Straight 8, .35; Eastman 16mm, \$2.00; Other Types, \$1.50. Title Developing 16mm, \$1.25 per 100 ft.; Double 8, .75; Straight 8, .40.

A PERSONAL MOVIE SERVICE

Evenings, Sundays and Holidays,
Telephone Lincoln 1207

W. STUART BUSSEY FILM LAB.

17 E. St. Joseph St., Indianapolis, Ind.

DeJUR 5A PHOTO-ELECTRIC EXPOSURE METER

\$11.50 With
Slings
(Pigskin Carrying
Case, \$1.00)



Precision made . . . ultra sensitive . . . zero ad-
juster . . . for black-and-white or color . . . still
or movie . . . indoor or outdoor . . . day or night.

At your dealer, or write for complete information.
Made in America for all the world.

DeJur-AMSCO CORPORATION
SHELTON, CONNECTICUT

ASK FOR THE
"CRITIC"
AT YOUR DEALER

Story of a Cinebug's wife . .

• Continued from page 123

ferent homes throughout the city were used for sets. Although I enjoyed seeing the rushes of the picture, which was all in color showing beautiful settings, handsome actors and beautifully gowned girls, I soon had a growing sense of dissatisfaction at being left out of it. This hobby was acting like a wedge prying farther into our home life, making it seem strange and unreal. Disliking the situation was getting me nowhere, so I decided to combat a hobby with a hobby. My husband's interests seemed to be taking him away from me as far as companionship was concerned so I picked something that would relate, in a little way, to his work.

"Photographic tinting is baby stuff," he said when he saw the set. Later I smiled when he became a sudden enthusiast and wanted to plant his feet under the table and try coloring, too. It wasn't technical enough to hold him long, but I was grateful that he should be just a little interested.

There's something about photography when it starts on you, it really gets in your blood. Next I found myself wanting a still camera. My husband was so pleased that he really beamed when he gave one to me for my birthday. Suddenly I found we could talk on mutual subjects such as balance, good shots, etc. Pictures began to hold a fascination for me that I never knew existed. Next I received a small movie camera, and there I was, an amateur moviehound, eating, sleeping and talking over the subjects I had once hated because I couldn't understand them.

FOLLOWING the picture the boys made for the dramatic coach, they received some more interesting work. A business firm, with offices here and in Hollywood, wanted pictures made of their business executives and lines of work they were engaged in. They took two evenings a week to work on this film of 800 feet.

This picture done, they

got an idea they would like to make a scenario type picture for themselves. We decided on a story and went on location the very next Sunday.

We invited four couples to act as our cast, and they were quite enthusiastic about it. In fact, almost too much so, for we had a hard time keeping them in one spot long enough to shoot a scene. Making a small picture all in one day was quite a task, and the sun was sinking into the sea in all its fiery splendor when the hero and heroine finally embraced. That was our first attempt at a scenario type picture and not one of us can keep a straight face when it is run on the screen.

We followed this picture with a 375-foot colored picture which took us five Sundays to make. We studied everything we could find on make-up before this picture was shot, and the result showed that pancake make-up and artificial eyelashes

really can do things for your cast.

OUR cinema club president decided it would be a wise idea to pool our interests and make a picture together. We took a vote to see what phases of picture making the members were most interested in. Some wanted to act, others wanted to direct, another group was interested in taking care of props and picking locations. My husband landed in the make-up group, and I was placed on the scenario committee. By the combination of all our efforts, we were able to make pictures that we couldn't make alone. At first some of the members were rather dubious about the outcome of such a picture. When they found that we all stuck together till we finished it, and that the finished product was quite entertaining, they all turned out for the next one. We all received good experience, had lots of fun and now possess four or five entertaining pictures in our film libraries.

The thrill of helping with these pictures has given me lots of pleasure. In fact it's done more than that—it's taken me out into that uninteresting darkroom. Now

Movie of the Month

• Each month the Editors of HOME MOVIES select the best picture sent in for analysis and designate it "The Movie of the Month." This movie is given a detailed review and a special leader is awarded the maker.

This award does not affect the eligibility of such films for entry in the annual HOME MOVIES CONTEST. They are automatically entered for rejudging with those films submitted especially for the annual contest. Films awarded the honor of MOVIE OF THE MONTH to date are:

1939

APRIL: "Chicagoland," produced by Theodore Shaw, Chicago, a 16mm picture, approximately 400 ft. long.

MAY: "Africa," produced by Mrs. Albert Heekin, Cincinnati, 16mm picture approximately 900 ft. long.

JUNE: "Alaska Cyclorama," produced by R. C. Denny, Fresno, Calif. 16mm picture approximately 800 ft. long.

JULY: "Behind the Dial," produced by Robert C. Orr, Mt. Kisco, N. Y. 16mm picture approximately 400 ft. long.

AUGUST: "New England Holiday," produced by Albert Watts, Buffalo, N. Y. 8mm Kodachrome picture, 800 ft.

SEPTEMBER: "Within the Garden Gates," produced by Murray Beliz, Sacramento, Calif. A 200-ft. 8mm Kodachrome film.

OCTOBER: "Hummingbirds," filmed by Richard L. Cassell, D.D. S., Los Angeles, Calif. A 16mm Kodachrome film, 400 ft. in length.

NOVEMBER: "Esquire's Escape," produced by Clarence M. Aldrich, Long Beach, Calif. A 16mm picture 800 ft. in length.

DECEMBER: "Souvenir," produced by Harold E. Remier, Hollywood, Calif. A 100-ft. 8mm Kodachrome film.

1940

JANUARY: "The Cauldron," produced by Dr. R. E. Gerstenkorn, Beverly Hills, Calif. A 16mm picture 400 ft. in length.

FEBRUARY: "Whistling Wings," produced by W. H. Nordin, Austin, Minn. A 16mm Kodachrome picture, 400 ft. in length.

MARCH: "Checking Off the Budget," produced by B. W. Johnson, Los Angeles, Calif. An 8mm Kodachrome film, 1000 feet in length.

ATTENTION 8MM 16MM
NEW ENGLAND FANS
BULK FILM

	Weston	Double 8mm	16mm
100' No. 1 Pan Anti-Halo	24-16	\$3.50	\$3.50
100' No. 2 Pan Anti-Halo	16-12	\$3.30	\$3.40
100' No. 3 Ortho Anti-Halo	16-6	\$3.25	\$3.30
100' No. 4 Ortho Anti-Halo	8-2	\$1.50	\$1.50
100' No. 5 Ortho Plain	8-2	\$1.25	\$1.25

All the above 16mm film is camera spooled. Write for prices on enlarging and reduction printing.
 Developing 100 ft. 16mm, \$1.00; Double 8, 25 ft., 50c. We carry a complete line of all Movie equipment. All orders prepaid except C. D. D.

MORRISON'S
 43 PROVINCE ST. BOSTON, MASS.

I, too, impatiently wait while the developing drums revolve and the vile smelling liquids are poured, to see how our last scenes are going to look. And once I wondered at my husband's audacity to imagine that complicated formulas and nostril-stinging odors could appeal to a woman!

lieve, have been the most interesting ones of my life. Our pictures are used as entertainment for clubs and socials, and the sincere credit and praise we get from them makes our time and efforts seem very worth while.

Now I know what most women should do whose husbands have such a hobby as making amateur movies. They should get themselves a hobby as closely related to his as possible. The last two years, I be-

Being married to a man with a movie complex has brought compensations for me. After all, variety must be the spice of life. Anyway, there's nothing else like it. Ask the wife of a man who owns a movie camera!

Movie of the Month . . .

• Continued from page 128

would get the "urge," and the Budgets would have to bail out, momentarily delaying their progress.

fellow in action and a little later cut back to him making a telephoto shot. To emphasize this, Johnson followed a closeup of the telephoto equipped camera with a shot taken in the distant redwoods—presumably the view on which the photographer's camera was focused!

The motivating gag of the whole story was, of course, Mr. Budget's constant vigil over his vacation budget sheet. As they proceed on their way, we are occasionally shown Mr. Budget, checking over the schedule of expenses, and dismally substituting a \$3.00 expenditure for an estimated figure of \$2.00, etc.

NOR was the gag about the boy overlooked at this point. With restrooms abundant at the fair grounds, ample opportunity was afforded Johnson to make the best of this gag sequence.

As the days wear on, the ever-increasing expense finally wears down Mr. Budget and, in utter despair, he tears up the budget sheet, decides to enjoy some of the vacation himself, and the devil with the consequences.

The Budgets' vacation trip took them from Los Angeles up the coast highway to Monterey, to San Francisco, and the Redwoods; and then across the state into the desert, and back home. Just before they reach home we are shown a stranger approaching their door and ringing the bell. Receiving no response, he decides to wait around—when the Budgets' car pulls up at the curb. The man goes out to greet them, and Mr. Budget, assuming the man to be a bill collector, waves him away, telling him to "collect next week."

When their cash is exhausted, Mrs. Budget, unmindful of their precarious financial condition, prevails upon her husband to cash a check for a hundred dollars for the balance of their expenses. But this hundred doesn't last long, and before they conclude their trip Mr. Budget has written many checks; and the exchange of checks for cash is cleverly shown in various ultracloseups.

Mrs. Budget speaks up and suggests that Mr. Budget give the man a check. But Mr. Budget has already overworked this idea, according to the man, who turns out to be a detective come to hold Mr. Budget to account for the bum checks already cashed during their trip. As the detective flashes his badge, Budget throws up his hands and goes along



f1.5

FOR COLOR MOVIES

Here's the lens to give you gorgeous full-detail color shots—indoors or out. Also invaluable for black and white movies, when lighting conditions are really tough—indoors, shots in heavy woods, night scenes, etc. The f1.5 speed makes it startlingly fast; fine optical corrections make it record colors truthfully. In 1" and 2" focus, and priced temptingly.

Write for
FREE BOOK!



WOLLENSAK OPTICAL CO.
 506 Hudson Ave. Rochester, N. Y.



GOERZ KINO-HYPAR LENSES



f:2.7 and f:3
 High chromatic correction, for taking color movies of surprising quality . . .
 Focal lengths 15mm to 100mm — can be fitted in suitable focusing mounts to Amateur and Professional Movie Cameras.

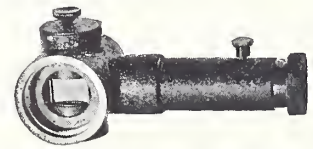

GOERZ Reflex FOCUSER
 — Patented —

A BOON to 16mm Movie Camera users—eliminates PARALLAX between finder and lens—provides full-size ground-glass image magnified 10 times. Adaptable to lenses 3" and up. Also useful as extension tube for shorter focus lenses for close-ups. Extensively used in shooting surgical operations, small animal life, etc.

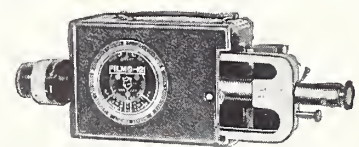

GOERZ Parallax-Free FOCUSER and FIELD FINDER CONTROL

for the same purpose, for Filmo 121 and Simplex-Pocketto, magnifies 4 and 8x.
 For Detailed Information Address Dept. HM-3

C. P. Goerz American Optical Co.
 317 East 34th St., New York

American Lens Makers Since 1899

"IT HAPPENED IN CALIENTE"
 Pssst! IT'S A Sensational Film
 Send for Free List and Special Prices . . . "Her Hollywood Test" and other thrilling films
 Inclose 10c for Sample Film
Sensational Films
 Box 1504 Hollywood, Calif.

ADHESIVE TITLE LETTERS

REMOVABLE and REUSABLE
 Will adhere to any clean smooth surface—indoor and outdoor—such as glass, tile, finished wood, metal, photographs, etc. Stylish and fashionable type.
 13/16" Gothic (240 letters) . . . \$2.50
 1" Exotic (240 letters) . . . 3.50

3mm SAVE ON FILM 16mm

Save \$8 on Film. Take movies at cost of snapshots. Highest quality film giving full tone gradations—with super speed. Assures perfect picture results. Laboratory packing—Weston 10. Not Positive Film.
 100 ft. Double 8mm (200' 8mm) . . . \$1.25
 100 ft. 16mm with Daylight Leaders . . . \$1.25
 100 ft. without daylight leaders . . . \$1.15
 Processing extra - 100 ft. 16mm75
 25 ft. double 8mm - 50c. 4 rolls 25 ft. double 8mm sent in at one time - \$1.50.

ACCURATE CINEMA SERVICE
 2609 Morse Ave. Dept. H4 Chicago, Ill.

FILMS FOR RENT
 16MM SOUND - 16MM SILENT - 8MM SILENT
 Send for Free Gigantic Catalogue
 Listing over 3500 subjects.
IDEAL PICTURES CORPORATION
 28 East Eighth Street, Chicago
 and
 2402 West 7th Street, Los Angeles, Calif.

SHOOTING SCRIPTS

"Shooting" scripts for Home Movie Camera Owners. Each script an exciting, original story, technically accurate, scene footage indicated. NOT SYNOPSIS. Group of five widely varied scripts, each designed for less than 100 feet of film, mailed promptly upon receipt of only \$1.00.
 SPECIAL! "Call the Doctor" 250 feet . . . \$3.00
 "Hold Onto Your Hat!" 400 feet . . . \$5.00

HOME MOVIE SCREEN PLAYS
 944 Little Bldg. Boston, Mass.

FINE MACHINE WORK

Turrets, Backwinds, Titlers, Lens Adaptations, 8mm Frame Enlargers, Focusers, Recorders, Sound Apparatus. Expert remodeling of cameras, lenses and projectors. Special Apparatus.

MacVAN MANUFACTURING CO.
 3829 El Cajon Blvd. San Diego, Calif.
 Courtesy to Dealers

SAVE \$\$\$ ON CASES

Now, prices on Cases for all makes of Cameras and Projectors have been sensationally slashed. Also, all our Screens, Cameras . . . in fact all our Photographic accessories are now being sold at wholesale prices. If it's a case, specify make and type of your camera. Send TODAY for Free Bargain List.
 Buy Direct and Save
WHOLESALE CAMERA SUPPLY CO.
 29 W. 34 St. Dept. S12 New York

DAYLITE LOADING
 BULK FILM FOR ALL 8mm and 16mm CINE CAMERAS. SPOOLED READY FOR CAMERA USE FREE.
 State Make of Camera Please
ESO-S CINEFILMS
 3975 Menlo Los Angeles, California

Filmo Movie Equipment Does Not Limit Your Skill!

FILMO movie equipment imposes no restrictions upon your skill. The more advanced you become, the better the basically complete Filmo serves you. There are no limits to quality or variety of movies it lets you make. That's why Filmo owners are satisfied owners.

Make your next movie purchase a Filmo. Write today for free literature describing cameras, 8 mm., 16 mm., or 35 mm.; projectors, sound or silent; or any particular accessory in which you are interested. Most literature is in interesting, illustrated booklet form. Write for information today. Bell & Howell Company, 1825 Larchmont Ave., Chicago; New York; Hollywood; London. Since 1907 the largest manufacturer of precision equipment for motion picture studios of Hollywood and the world.

PRECISION-MADE BY
BELL & HOWELL

BINDERS for HOME MOVIES
Handsomely bound. Each \$1.25
HOME MOVIES, 6060 Sunset, Hollywood, Calif.

For Only \$8.50
... you get all the facilities to make professional screen titles with the ...
BESBEE TRICK EFFECT EASEL

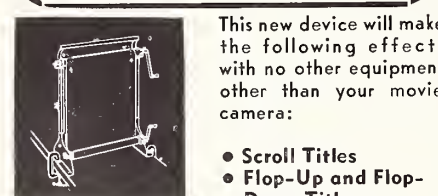

This new device will make the following effects with no other equipment other than your movie camera:

- Scroll Titles
- Flop-Up and Flop-Down Titles
- Turn-Over Titles
- Revolving Turn-Around Titles
- Curtain Titles
- And Many, Many Others



There are no difficult instructions to follow ... no complicated mechanism to work. The Besbee Trick Effect Easel is simple and easy ... yet exactly professional. Complete with various accessories \$8.50

At your dealer or write for details.

BESBEE PRODUCTS CORP.
TRENTON, N. J.

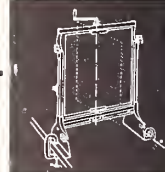
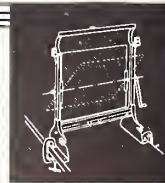

peacefully with the officer. Mrs. Budget bursts into tears and calls reassuringly to her husband that she will "come right down and bail him out." The closing scenes show Mrs. Budget regretfully extracting her fur coat savings from the lining of a club chair as she takes a final look at the magazine illustration of the coat she had planned to buy.

The treatment of this final closing sequence deserves especial commendation. In the hands of some amateurs, this story would have proceeded needlessly, with scenes showing Mrs. Budget bringing the money to the police station and obtaining the release of her husband. But Johnson terminated his story climactically at the right point in the true, modern Hollywood style.

AND there are many other clever bits of technique evident throughout this picture which must be seen on the screen to be fully appreciated. Johnson appreciated that five reels of plain scenic shots would prove tir-

ing to the most tolerant of audiences, and he knew just how to "sweeten up" his travelogue with bits of business and to thread an interesting story through it.

Remember, Johnson started his trip with no idea of filming a story. He just wanted to make movies as they traveled along, recording scenic spots of interest. The continuity idea came to him later and he began to make the necessary shots to tie his story together. Then, when he returned home and his several reels of film were returned from the processors, the film was projected time and again. The continuity idea was polished up, an outline of it written, and then Johnson proceeded to make the necessary additional scenes which comprise most of the first sequence of the story.

Johnson's camera technique is splendid in every department, and no little credit must be given Mrs. Johnson, who handled the camera on many of the scenes and turned in a swell piece of acting in the bargain.

Try these trick shots ...!

• Continued from page 118

ment and facilities are such that he, too, can duplicate these trick effects with remarkable success. The professional cinematographer will use a 2 or 3 inch lens, whereas you will use but a 1/2-inch 8mm or 1-inch 16mm lens, giving you an advantage in that you will require less room to produce trick shots. In other words, where the professional would require a deep enclosed stage to make the shot of the girl, you could probably make the shot in an ordinary living room.

Where adequate room is a problem, you can use a mirror to gain the necessary distance between your camera and object. With your object placed at the maximum distance, or the far end of the room, place a mirror at the other end of the room at right angle and photograph the image reflected in the mirror.

Still another method for making the shot of the girl

doors at night, provided of course no street lamps or other lights would interfere.

It is only necessary to illuminate the two objects—the girl and the bottle—and in each set-up the light should appear as coming from the same direction. Light should be sufficiently strong to enable you to photograph the scene at a relatively small stop—from f/8 to f/16.

The illustration of the insect and the girl is another

ANSWERS TO CINE QUIZ

- 1 A
- 2 None
- 3 C
- 4 C
- 5 C—usually eight inches or more from camera.
- 6 B—Exposure action is reverse with positive film. The more light admitted to film, the darker the emulsion after development.

...A NEW FOTOSHOP CINE FILM!

Lightnin'—Ortho

100-Foot Roll
\$2.79

A faster Ortho film for better outdoor shots. May also be used indoors. Outdoor rating 24—Tungsten 12.

A new inexpensive cine film representative of all the high standards of quality and dependability established by Fotoshop Cine Films over the last ten years.

Other FOTOSHOP Movie Film:

No. 1—Semi Ortho	8mm	\$1.25	16mm (100 ft.)	\$2.19
No. 1—Semi Ortho Express				2.79
No. 2—Rapid Panchromatic				3.50
No. 3—Ultra Speed Pan		1.75		4.25

FOTOSHOP CINE FILM is also available in bulk packing without processing, for those who do their own developing. Write for prices and further information.

Dept. HM-3

FOTOSHOP, Inc.

18 East 42nd St., N. Y. C.
Branch—136 West 32nd Street

FOTOSHOP, INC., Dept. HM-3
18 East 42nd St., N. Y. C.

Please send me _____ Rolls of _____ Fotoshop Cine Film. Enclosed find \$ _____

Send details on bulk film.

NAME _____
Address _____
City and State _____

ESO-S PICTURES

Quality 8mm Service
3945 Central Kansas City Mo.

• 24-HR. FINISHING GUARANTEED **45c**

- 30 ft. of double 8mm General, Pellex, Etc., Processed
- 30 ft. single 8mm 25c
- 30 ft. Univex Standard & U. P. 15c

REDUCTIONS ENLARGEMENTS DUPLICATES

GEO. W. COLBURN LABORATORY
1197 MERCHANDISE MART CHICAGO

is this your problem, too?

Would you like to improve your films . . . acquire that professional touch? With top-notch home movie equipment—complete equipment, chances are, you can. You know equipment you want when you have Lafayette's Camera Catalog? It's all here—and guaranteed—at low, money-saving prices. You can order everything you need at home. Send for free copy of this amazing camera catalog today. See for yourself just what we mean by values. Mail a penny postcard—that's all.

LAFAYETTE CAMERA

Dept. 80C—100 Sixth Ave., New York, N. Y.



THALMETAL TRIPOD

A handsome, uniquely-styled, metal tripod worthy of the finest camera. The upper leg section is a rigid channel of polished metal, while the lower section is tough black hardwood. It is completely rigidized and fitted with Sure Foot Points. The Precision-built Pan-Tilt Head has full panorama sweeps, Instant-On Plug and is chromium finished. This tripod is outstanding in appearance — in serviceability — in dollar value.

Thalmetal Tripod, complete with Head \$14.00

THALHAMMER COMPANY
1015 W. Second St. Los Angeles, Calif.

GLASS-BEADED MOVIE SCREENS
Easily Made!

Make your own sparkling beaded screens—at a fraction of their usual cost! Crystal beads can be applied to cloth, cardboard or almost any smooth surface. Complete directions with each pound. (No fractions of pounds sold.)
D. GARD, 54 WEST 74TH STREET, NEW YORK CITY

Now ALL BOX-SCREEN OWNERS CAN HAVE A TRIPOD SCREEN for only 75¢ complete!

Images in coned quarters. Permits adjustment of screen to eye level. Installed in 5 min. If dealer can not supply send his name and 75c. United Photo Products Co., 63 Franklin St., Boston, Mass.

DOUBLEEE BOX-SCREEN TRIPOD ADAPTER

Buy GENERA in BULK
DOUBLE 8 SCORED
SEPARATES WITHOUT SLITTING
Single 8, Double 8 & 16 M

LOAD YOUR OWN SPOOLS and Save Money!

A High Class Reversible Semi-Ortho Outdoor Film. Used in Cine Kodaks, Keystone, Victor, Filmo and Univex. Also suitable for titles. Processing simplified by use of our Prepared Powders. **FREE** Instructions.

200 ft. 8mm dble. 8 \$1.50 post
100 ft. 16mm on Cardboard Spool for Cameras \$1.25 ptd.
400 ft. roll FAST 16mm, (Western 12), \$4.85 postpaid.

100 ft. Single 8 \$1.00 post
Univex, etc. paid 3 for 60c postpaid
Keystone single 30c

100 ft. single 8 Panchromatic \$1.90; Fast Pan. \$1.95 pp.
100 ft. double 8 Panchromatic \$3.25; Fast Pan. \$3.35 pp.
Our Double 8mm Panchromatic Films are not Scored.
100 ft. 16mm Super Pan (West. 24) day, \$3.15 pp.
Use our Simplified Processing Outfits including our Prepared Powders: For 30 ft. single 8, \$3.55 postpaid; Double 8 and 16, \$4.95, express collect.

Write for a **FREE** Sample of Film—State Size.
Big Bargain Circulars and **OUR** Processing Price List.
FROMADER GENERA CO., Davenport, Iowa

16mm AMBERTINT
FOR OUTDOOR ACTION SHOTS—Fine grain, semi-ortho, large latitude. Amazing low price includes machine processing. Not sold at dealers and none made in bulk or sold in bulk. \$2.00 Calif. buyers include sales tax. 100-ft. roll Write for Big Free Bulk Film Catalog

HOLLYWOODLAND STUDIOS
THE WEST'S GREATEST FILM MAIL ORDER HOUSE
SOUTHGATE, CALIFORNIA

example of what may be accomplished by similar methods. In making such a shot with a cine camera, it would be advisable to keep the background as dark as is consistently possible by shooting the objects against dark backgrounds. The insect would be photographed first at close range. Then the film would be wound back and the girl, standing against a black backdrop and at a distance of about 20 feet from the camera, would be photographed on the same section of film.

ANOTHER method of achieving trick effects is by the "split-stage" method. "Split-stage" is a studio term meaning that the scene although it appears on the screen as having been photographed all at one time, is actually shot in two stages. You have seen many films where one character is shown in a scene with his "double." This effect is obtained by the "split-stage" method. Usually the scene is arranged so that the "doubles" do not touch or move in front of one another. One half of the frame aperture of the camera is masked off and the scene is photographed with the actor doing his stuff. Then the film is wound back to the start of the scene, the actor placed in position on the opposite side of the set, and the scene re-photographed. This last "take" registers on the portion of the film that was masked off or "blacked" out during the first take.

Cameras that do not provide for masking behind the lens can be made to produce "split-stage" shots with the aid of a matte box. This accessory, sometimes

incorporated in the sunshade, provides for holding the mattes necessary in masking off a portion of a scene. Such mattes may be of various designs and provide for masking off anything from a small corner to one-half of the scene.

"Split-stage" effects are easy for any amateur to make and are the real professional means of producing the effect of dreams, visions, etc., in motion pictures.

It is obvious that maximum depth of focus must be obtained in making all two-stage and double exposure shots in order to maintain the illusion of the scene having been completely photographed at one time. The lack of time instant exposure is compensated for by using more light and particularly by concentrating it upon the subjects and not too much on their surroundings. The use of low-key lighting is almost a necessity in making trick shots such as the girl in the bottle and the girl and the insect, for two reasons: It concentrates the attention of the audience upon the objects and away from the rest of the scene, minimizing the possibility of detection of the dividing line between the separately photographed areas should such lines of demarcation exist.

In making "split-stage" shots, the lighting of each stage of the shot must be absolutely the same if the effect is to be successful.

NEXT month we shall try to give you an exposé of some of the popular trick shots such as "the invisible man," ghosts, disappearing objects, and others.

Title troubles . . .

• Continued from page 112

tric fan, place it up rather high and shoot it from a low angle, so that all the background is sky. It may take a little adjustment of the fan to get a realistic ripple in the banner, and if the ripples are too fast, film the shot in slow motion. This will slow them down to where they look more natural. Another realistic

touch would be to fasten the banner securely, then expose the shot frame by frame at intervals of about 5 seconds, if there are any clouds in the sky. This will give the illusion of the banner moving swiftly in the sky—as would be the case if it actually were behind an aeroplane. (But make sure the clouds are moving in the right direction!)



Like a Faithful Mirror That Does Not Distort

Raven Screens

reflect every detail of your film with truly remarkable fidelity. Scientifically designed and painstakingly constructed of carefully tested materials, Raven Screens give a maximum brilliance and detail and are preferred by a constantly growing number of critical movie makers—amateurs and professionals alike. Raven Screens, available in a variety of styles, sizes and materials, are adapted for every requirement of space, usage and the particular demands of modern color photography.

Investigate the superiority of Raven Screens at your local dealer's or send for Folder 43.

Raven Screen Corporation 314 East 35th Street, New York



THE 1 2 3 OF 16 M.M. REVERSAL film

KIN-O-LUX No. 1—An economical high quality film for outdoor use. Renders accurate gradation from black to white, possesses brilliance and wide exposure latitude.

KIN-O-LUX No. 2—An anti-halo film for outdoor use; faster than No. 1.

KIN-O-LUX No. 3—An extremely sensitive panchromatic fine grain film for use indoors or out. Fully sensitive to all colors of the visible spectrum. Compare it in quality with any fast film.

	No. 1	No. 2	No. 3
100 ft.	Green Box \$3.00	Red Box \$3.50	Lavender Box \$6.00
50 ft.	2.00	2.50	3.50
Prices include Scratch-Proofing, Processing and Return Postage. 24-hour return service.			
SPEEDS	Scheiner		Weston
No. 1	Day 16°	Mazda 6	Mazda
No. 2	18°	12	
No. 3	26°	24° 50	40

WRITE FOR BOOKLET H-31

KIN-O-LUX REWIND

Accommodates both 16mm and 8mm reels. Capacity up to 2,000 feet. Well machined with cut steel gears, malleable casting, smooth running, easy drive even with larger reels. Square reel shaft prevents damage to reel cores—\$5.00 each.

Idle spindle for holding reel while rewinding film \$2.50 each. Write for Booklet H-33.

KIN-O-LUX, INC.

105 West 40th Street
NEW YORK



LEARN photography from EXPERTS

If you are ambitious to become a successful photographer, either for pleasure or career, the New York Institute offers you an unusual opportunity to train under the personal direction of some of America's foremost photographic experts. Courses cover **Commercial, News, Portrait, Advertising, Color, and Motion Picture** photography.

RESIDENT COURSES: Conducted in our modern, completely equipped studios. Day or evening sessions. No classes. You are taught individually. Start any time.

HOME STUDY COURSE: For those who are unable to come to New York. Practical, individual training under the close supervision of the N. Y. I. faculty.

Send for Booklet

NEW YORK INSTITUTE OF PHOTOGRAPHY

10 West 33 St. (Dept. 114) New York City
Established 1910

4 Star MOVIE SCREENS ARE ESPECIALLY DESIGNED FOR HOME MOVIE PROJECTION!

★ Surfaced with special grade extremely fine glass beads, assuring intimate in projection quality.

★ Unexcelled for color projection of movie or still films.

★ Special soft felt backing protects beaded surface when screen is rolled up.

★ Both models easily and conveniently assembled. Screens hang "wrinkle-free."

Three wire easel models afford high quality screens at low cost. Screens stand erect, supported by novel wire easels.

- 22" x 30" . . . \$3.95
- 30" x 40" . . . 5.50
- 36" x 48" . . . 8.50

4-Star "Senior" models are mounted on self-erecting frames in sturdy, lightweight, leatherette covered boxes.

- 22" x 30" . . . \$ 9.95
- 30" x 40" . . . 13.95
- 36" x 48" . . . 17.95

See these screens at your dealer's today. If he cannot supply you, send us his name in return for FREE descriptive circular.

Hollywood Cine Products Co.
3221 S. Figueroa • Los Angeles, Calif.

Backyard Movies . . .

• Continued from page 110

the sheriff. There are several kiddies grouped about him—his posse—and after telephoning, he gives each one special instructions, gesticulating the while. Each of the kiddies wears a "detectiff" badge; a toy gun, knife, or dagger. A small dog carries a banner on its back labeled "Bludhound." At a word from the "sheriff" they start on their hunt.

Next follow various shots showing the kiddies using a magnifying glass on a dog's footprints, and stalking about yards, garages, etc., in search of the dog—guns drawn and grim looks on their faces.

A title follows: "Overpowered, the criminal is brought to justice." Then the sheriff is shown leading the villainous dog by a ridiculously large rope. One by one he is joined by the other members of his posse. They enter a scene in which appears a large rural mail box of the old "R. F. D." type. The words "U. S. Mail" have been altered slightly to read "U. S. Jail"—the letter "M" crossed out with black crayon and a childish "J" written above it.

The dog is placed in "jail" amid cheers of his posse and of Mary Lou, who enters the scene to congratulate him. In her hand is a brand new lollypop. She slowly re-

moves the wax paper while talking about the dog's capture and is about to put it in her mouth when she suddenly realizes she should reward the "sheriff" for his feat in capturing the villainous dog. The sheriff is looking goggle-eyed at the lollypop, and then his expression suddenly changes to smiles as Mary Lou gives it to him, saying:

Title: "To you, sheriff of Kiddo Kounty, our hero!"

Fadeout with all of the kiddies cheering the sheriff.

—Rufus James Foster.

Spookie Movie!

This is a very effective filming idea for a "short" which can be made by any amateur whose movie-making equipment includes a few photofloods and reflectors.

The story opens with a shot of boy borrowing a Weird Stories pulp magazine from a friend. He conceals it under his jacket when entering the house, and when inside hides it under the mattress of his bed.

A closeup of a clock indicates it is eleven. A night light is snapped on and we see the boy getting up from bed and removing the Weird Stories book from under the mattress. Another closeup shows the lad snuggling down and starting to read. He should be close against

Exposure Meter Guide

	SCHEINER		WESTON OR GE			SCHEINER		WESTON OR GE	
	Day	Mazda	Day	Mazda		Day	Mazda	Day	Mazda
AGFA									
16mm SSS Pan.	29	27	100	64	GEVAERT				
16mm Superpan (Discon.)	23	20	24	12	Super Reversal	23	21	24	16
16mm Hypan	22	20	20	12	Panchro	20	18	12	8
16mm Panchromatic	21	18	16	8	Ortho	21	17	16	6
16mm Supreme Pan. Neg.	27	25	64	40	GEBERA				
16mm Fine Gr. Pan. Neg.	20	15	12	4	Super Pan.	23	21	24	16
16mm Positive	12	8	3	.3	Panchromatic	20	18	12	8
8mm Twin-8 Hypan	24	21	32	16	Semi-Ortho	18	12	8	2
8mm Sgl-8 Filmopan	19	17	10	6	KIN O LUX				
DUPONT					No. 1	16	6	6	6
Reversal Pan.	21	19	16	10	No. 2	18	16	12	8
Regular Pan Neg.	20	18	12	8	No. 3	26	24	50	40
Superior Pan Neg.	24	21	32	20	PELLEX				
Positive	12		2	1-6	Super	26	25	50	40
EASTMAN					Pan	20	18	12	8
16mm Super XX Pan.	23	22	24	16	Ortho	18	14	8	3
16mm Super X Pan.	23	21	24	16	Super 8mm	25	24	40	32
16mm Safety	20	18	12	8	Ortho 8mm	17	12	6	2
16mm Sound Pan.	23	21	24	16	HOLLYWOOD				
16mm Pan. Negative	23	21	24	16	S. S. Pan.	26	25	50	40
16mm Positive	16	10		6	Pan	21	20	16	12
8mm Super X Pan.	23	21	24	16	Semi-Ortho	18	12	8	2
8mm Regular Pan.	18	16	8	5					
Kodachrome (8 & 16mm)	18	14*	8	3*					
Kodachrome (8 & 16mm)	18*	21	8*	12					

*With filter

PROVE IT TO YOURSELF!

Write for your free 5" x 7" Sample of the BRITELITE-TRUVISION WIDE ANGLE SCREEN FABRIC and Reflection Test Chart.

Whether you like a Box or Tripod Model, we challenge you to find any other SCREEN which will give equal projection quality at all angles . . . sharper definition. No glare, halation or distortion. Best for black-and-white or color. **NO GREATER COST!**

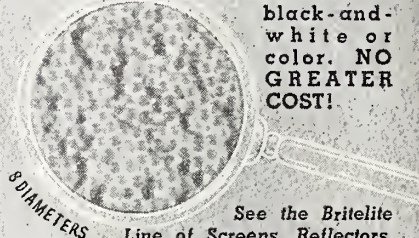

See the Britelite Line of Screens, Reflectors, Spotlights, Utility Cases, Etc. at your dealer, or write for Catalog and Test Package.

Dept. HM-3. Made in U. S. A.

MOTION PICTURE SCREEN & ACCESSORIES CO., INC.
351 West 52nd Street, New York City

Save ON PHOTOGRAPHIC EQUIPMENT

Write for our **FREE CATALOG** no obligation!

Our large turn-over permits us to sell for less! Complete line of "Still" and "Movie" equipment.

SUNNY SCHICK
National Brokers
403 W. WASHINGTON BLVD.
FORT WAYNE, INDIANA

MODERNIZE—Trade in Your Equipment!

8mm BULK FILM 16mm

Fine grain, Semi-ortho, Non-halation Weston S. For titles or reversals. Lab. packed. Free formulas each order. All film guaranteed fresh stock—not re-perforated positive. Calif. buyers include sales tax.

LOAD YOUR OWN—SAVE MONEY
400 ft. Straight 8mm for Univex, Keystone, etc. \$3.50
800 ft. 8mm in dbl. 8mm widths for all dbl. 8mm cameras. \$5.00
400 ft. 16mm. \$4.75

SPOOLS:—Univex, 5 for \$1.00. Dbl. 8mm, ea. 40c. 50 ft. 16mm, ea., 40c. 100 ft. 16mm, ea., 50c.

Write for Big Bulk Film Catalog

HOLLYWOOD STUDIOS
THE WEST'S GREATEST FILM MAIL ORDER HOUSE
SOUTHGATE, CALIFORNIA

Kodachrome
MAPS • Charts • FINE TITLES
Geo. W. Colburn Laboratory
Special Motion Picture Printing
1197 Merchandise Mart, Chicago

MAKE YOUR OWN TITLER!

For all types of titles, close-up and copy work. Complete kit of finished parts—optically ground lens—easy instructions. Assemble in 15 minutes! Money Back Guarantee. State camera model.
Distinctive Titta Card—"Photography by (your name)"—35c

ONLY \$1.65 IN KIT FORM

For All 8 or 16 MM CAMERAS

HOLLYWOOD MOVIE SUPPLY COMPANY
NORTH HOLLYWOOD • CALIFORNIA

NEW 8-16mm "CINE-SCOPE" POCKET-VIEWER **\$1.00**



MAGNIFIES OVER 20 TIMES!

Optically ground lenses insure clear-cut image. Adjustable tube. Film is slipped in at side (see photo). Groove holds film in position. Reg. \$3.50 value, going fast at only \$1 (add dime post.)

A REAL NECESSITY—ORDER YOURS NOW! Designed by E. M. LIEBSCHER, Cine-Optical Eng. Note—State if for 8 or 16mm. (No stamps, please.)

157 "Moderne" Pe. TITLING SET **\$1.95**

157-pc. "Moderne" TITLING SET.....\$1.95 Set includes letters, figures, etc.; mold-cast of durable (white) DENTAL Plaster. NO PINS, flat backs. "THIRD DIMENSIONAL." Size, 3/4 in. high, 3/8 in. thick. Reg. price, \$4 set—NEW LOW PRICE.....\$1.95 Shipped exp. collect (insured) or add 35c prepaid. Send dime for samples of title letters and circulars of extreme close-up devices, aux. lenses, comb. shade and aux. lens holder, etc.

FREE! With all orders—A reg. \$1 value "TABLE OF SIZES" CHART, showing field-sizes at various distances (absolutely accurate).

"CAMERA SPECIALTIES"

P. O. Box 3182 Hollywood, Calif.

Reelotone 16mm 35'

SOUND-ON-FILM RECORDERS • CAMERAS

WHY be satisfied with half the musical range when you can get the full range with a Shook & Pace Reelotone Recorder? Also world's finest recording units adaptable to many makes. Three-year unconditional guarantee.

PRODUCERS SOUND-COLOR PICTURES
SHOOK - PACE & BUTWIN
LABORATORIES
40 FORT STREET • FORTY FORT, PA.

8M RAINBOW 16M

The following prices include processing and are for daylight loading films:

	25'	100'
	Double 8mm	16mm
No. 1	1.00	1.85
No. 1 Anti-Halo	1.25	2.15
No. 2 S S Pan Halo	2.00	4.40
No. 3 Pan Halo	1.50	3.50

The following prices are for laboratory packed films without processing:

	100'	100'
	Double 8mm	16mm
No. 1	1.25	1.20
No. 1 Anti-Halo	1.50	1.50
No. 2 S S Pan Halo	3.50	3.50
No. 3 Pan Halo	3.00	3.00

RATINGS:

	Weston	Scheiner
No. 1 Both Types	12-4	20-15
No. 2 S S Pan	50-32	26-23
No. 3 Pan	16-12	21-20

We Pay Postage on All Orders Except C.O.D.

RAINBOW LABORATORIES
STATEN ISLAND, N. Y.

"How to Title Home Movies"

Send \$1.00 Now for This Latest Book to

HOLLYWOODLAND STUDIOS
9320 California Ave. South Gate, California

PHILADELPHIA

EQUIPPED to Serve You... with a comprehensive line of CAMERAS & ACCESSORIES

KLEIN & GOODMAN
18 S. 10th Street, Philadelphia, Pa.

a bare expanse of light-colored wall. The boy continues to read, stealing an occasional glance at the picture on the cover, and this should be shown in bold closeup.

Now for the spooks! This scene should be lighted by one powerful lamp, such as a Photoflood No. 4 or a Movieflood, and should take in as large an area as the power of the lamp and angle of your lens will permit. In addition, you will need to make two cardboard cutouts of some spookie design such as a bat, skeleton, etc., or perhaps resembling somewhat the grotesque figure on the cover of the magazine.

Hold these cutouts close to the Photoflood lamp and

move them so that their huge shadow will be cast against the wall and over the bed. With a closeup, show the boy staring at the shadows in horror. Show him half afraid to look over his shoulder at the shadows on the wall in back of him. When he does summon up enough courage to do so, the shadows quickly disappear, then reappear as he turns away. This business continues until the boy, thoroughly frightened, throws down the book and crawls under the covers with the room light on. Fadeout.

Fadein to a shot showing clock at 3 a. m., followed by a closeup of the boy, asleep, and in a death struggle with a mass of bedclothes. Fadeout.

—Martin Alger.

It's New to Me . . .

• Continued from page 132

wipe-offs, fades, and dissolves, is now operated by clockwork. This new motive power winds like a watch and enables one to make 12 separate transitions with one winding. The clockwork attachment may be installed on the former cable-release operated models at small cost, according to the manufacturer.

Perfec-Fade

A novel fading device, said to produce smooth, professional-like fades and dissolves, is the recently announced Perfec-Fade which may be attached to most cine cameras. Effects are accomplished by merely moving a small handle, during filming, which operates a disc before the lens. Additional effect discs are available for producing other effects. Mutual Photo Products Co., 403 Loeb Arcade, Minneapolis, are the manufacturers.

Du Pont Agency

The Hollywoodland Studios, 9320 California Ave., Southgate, Calif., have been appointed exclusive distributors and processors for Du Pont 16mm Regular Pan cine film in that area.

Du Pont Regular Pan is a standard speed, fully panchromatic film of wide lati-

tude and fine grain. It has all the qualities of costlier black and white films except extreme speed, according to the new distributor, and is excellent for indoor as well as outdoor filming.

Voca-Titler

With the hobby of making personal movie recordings sweeping the country, the American Bolex Co., of New York City, are introducing the sensational new Voca-Titler, a device that may be used in conjunction with 8mm and 16mm projectors to produce spoken titles and sound effects simultaneously with the projection of Home Movies.

Operation of the Voca-Titler is simple, according to the manufacturers. Very small notches are cut at points on the film with a special device supplied for the purpose. As film passes through the projector, the notches operate switches which control a turntable and amplified loudspeaker. It is said that tone quality is of the finest and that voices are recorded faithfully.

Fisher Film Cleaner

One of the simplest and most effective gadgets for cleaning home movie films quickly and efficiently is the

The Sensational NEW
SOLAR ENLARGER

- ENLARGES
- REDUCES
- May be used as a CAMERA for COPYING, VIEW or PORTRAIT WORK

USE THE SOLAR

VERTICAL or HORIZONTAL
Brings out the finest detail in your negative. Enlarges! Reduces! Projects vertically or horizontally. High efficiency adjustable condenser light system. Dustless patented negative carriers. All adjustments for perfect prize winning "Salon" prints.

INTERCHANGEABLE LENSES
Lens boards interchange instantly—uses standard Speed Graphic sizes, etc.—Long bellows permits use of wide variation of lens sizes.

AS A VIEW CAMERA
Take the lamphouse off the Solar. Put on the special camera back, and presto, you have a perfect, adjustable long bellows view camera for negatives 2 1/4"x3 1/4".

FOR COPYING, ETC.
The Solar baseboard and upright column make a perfect adjustable copy stand for the Solar or your regular camera.

WITH A MICROSCOPE
The Solar as a camera is ideal for use with a microscope—as well as for macrography. Its long bellows enables you to photograph objects larger than actual size.

FREE VALUABLE TREATISE
Experts collaborated in the preparation of this Solar Book to bring you valuable hints on enlarging, dodging, diffusing, etc. Write for Solar Book N-40—it's free.

BURKE & JAMES, Inc.
223 W. MADISON ST. CHICAGO, ILLINOIS

16MM

DuPont Regular Pan Film
Motion Picture
Makes Better Home Movies at Less Cost

Standard speed, FULL PANCHROMATIC sensitivity, wide latitude, fine grain. Hall all qualities of costlier indoors with photo-floods. Can be used black and white films except extreme speed. Excellent for normal outdoor shooting or with filters. Calif. buyers include sales tax. Including Reversal Processing..... **\$4.50** 100-ft. roll

Write for Free Bulk Film Catalogue

HOLLYWOODLAND STUDIOS
SOUTH GATE CALIFORNIA

HOT OFF THE PRESS!

8mm-16mm Movie Equipment
Send for Our Price Lists On:

- SPLICERS
- PROJECTION BULBS
- SCREENS
- MOVIE EDITORS

RENTAL LIBRARY—Silent and Sound—Large Selection—Shipped Everywhere

NATIONAL CINEMA SERVICE
71 Telegram Square New York City

Free Processing UNIVEX FILM
ALL FILMS PROCESSED BY LATEST TYPE MACHINE

"DETAILS FOR STAMP"

HOLLYWOODLAND STUDIOS
9320 California Ave. South Gate, California

IF IT'S TITLES . . .

(A 15-second quiz)

Ques.: Are you a "do your own" fan?

Ans.: Ciné Shop has bulk film for titles at \$1 per 100', double 8mm, single 8mm (two 100' slit sections), and 16mm.

P. S. — A sample kit just out has 25' lengths each of clear, amber, yellow, daylight blue bases, costs \$1.25 postpaid.

Ques.: Are you an artist?

Ans.: The Ciné Shop photographs your titles, drawings and photos on film at a nominal charge.

Ques.: Are you strictly a filmer, without time or equipment to make your own titles?

Ans.: The Ciné Shop makes high grade titles for professional productions and personal films.

Write Now for Complete Information

Ciné Shop

1812 Piedmont Charleston, W. Va. Telephone Capitol 20988

16 MM TITLES

WORLD'S GREATEST TITLE SERVICE!

Make your home movies more enjoyable. Give your pictures that professional touch with FILMACK Titles. Smart professional work... either silent or sound. Complete service, including expert titling, editing, developing and scoring.

5,000 Art Backgrounds
The Largest Library In The World

FREE
ILLUSTRATED CATALOGUE
ON REQUEST

FILMACK LABORATORIES
833 So. Wabash Ave., Chicago

24-HOUR PROCESSING—DOUBLE 8-16mm
100 ft., 60c 50 ft., 45c 25 ft., 40c 3-30 ft. single 8, 50c

Reversal or negative—returned on own spool. You may combine footage to make 100 ft. Price includes splitting and return postage except on C. O. D. for any make or type of film.

8mm—BULK FILM—16mm—Fine grain outdoor film—reversible— Weston 8—Excellent for pictures or titles. 100 ft. double 8, scored, \$1.10 — 100 ft. 16mm, \$1.10 Spooled for daylight loading with FREE PROCESSING. 100 ft. 16mm, \$1.60 25 ft. double 8, \$1.00

BRITE TONE MOVIE SUPPLY
188 W. Randolph St. Chicago, Ill.

HARBOR ACTIVITIES

Each Film 400 ft. 16mm silent . . . \$24.00

Subjects: Navigating a Ship Into Harbor, Harbor Safety Measures, Port Commerce, Drydocking Ocean-going Ships, Procedure of United States Customs, Safeguarding Health at the Nation's Gateways, Pacific Coast Fishermen at Sea, etc. Send for Catalogue.

FRITH FILMS Box 565, Hollywood, Calif.

Better Movies with BLACK and WHITE FILM

Black-White 16 MM. 100 Ft. \$1.98 Includes Reversible Film Processing Rating Weston 12 Scheiner 18 At your dealer or direct. Fast service processing same day included at no additional cost.

VISUAL INSTR. SUPPLY CO.
1757 B'way Box 111 B'klyn, N.Y.

TIRED OF YOUR PRESENT LIBRARY FILMS?
Why not exchange them for newer, different subjects? Large selection — 8 or 16mm — list on request. All films guaranteed in good running condition. Your money refunded if not 100% satisfactory.

EXCHANGE RATE

• 100 ft. 16mm . . . \$1.50	• 400 ft. 16mm . . . \$1.00
• 200 ft. 8mm . . . \$1.00	• 400ft. SOF. . . \$3.00

Send in your present films with the exchange fee and the type picture you desire. **DO IT NOW!**

NATIONAL CINEMA SERVICE
71 Dey Street New York

.. TITLES ..

BACKGROUNDS FREE

Reducing ★ Enlarging

ILLUSTRATED CATALOGUE

GENERAL CINE SERVICE
204H East 18th St., New York

new Fisher Film Cleaner, distributed by Marks & Fuller, of Rochester, N. Y., and on sale by leading photo dealers. This accessory may be attached to table or editing board and the film cleaned while being rewound after projection.

Besbee Prices Cut

Shortly after the removal of Besbee Products Corp'n to their new enlarged quarters, they announced new price reductions on their Universal Title Maker. Title Illuminator, Pro-Trik Title Frame, and the Besbee Effectograph. These reductions have been made possible through lowered production costs made pos-

Table-Top Movies . . .

• Continued from page 121

sure to expose sufficient film to allow for him to reappear again.

Now one more thing! Don't forget your regular cinematic technique — that of altering your camera setups the same as you would

sible in their new manufacturing quarters, according to the Besbee Corporation.

Aquatic Film

An "Aqua-Movie Masterpiece" is the claim made by Castle Films for their latest 8mm and 16mm film release, "Swimming and Diving Aces." According to Castle, this new film is a stirring aquacade of diving wizards and swimming stars, and the finest array of mermaids and mermen ever presented in one movie production. This film is now available from principal home movie and photographic supply dealers, according to Castle Films.

Experimental Workshop . . .

• Continued from page 131

of the reel and developing tank.

In winding film on rack prior to processing, it should be drawn sufficiently tight to depress the glass rods from 1/8" to 1/4". Then as the film begins to stretch or expand in the processing solution, the action of the

rubber bands against the rods will force them out, expanding the circumference of the reel as required to keep film taut. As the film is dried, the "floating" glass rods will contract to allow for shrinkage of film to normal size.

—Norman W. Barnes.

• All Amateurs, whether subscribers of HOME MOVIES or not, are invited to submit their films to the editors for review and helpful criticism. Unless otherwise requested, reviews of some of the films which we believe would benefit other amateurs will be published each month.

Reviewed films will be rotated one, two, three, and four stars, and films qualifying for two or more stars will receive free, an animated leader indicative of such award. Detailed reviews, with suggestions for improvement — if any — will be mailed to amateurs submitting their films.

Exceptional films qualifying for the distinction of the "Movie of the Month" will be treated in detail in a feature length article in a following issue of HOME MOVIES. In addition, a certificate evidencing the award of "Movie of the Month" and a special animated "Movie of the Month" leader will be returned with such films after review.

When submitting films for review and analysis, please advise make of camera, speed of lens, whether or not tripod was used, or if you used filters, exposure meter, or other accessories. While this information is not essential to obtain analysis of your film, we would like to pass it on for the benefit of other amateurs.

PERFEC • FADE

for Smooth... Professional

★ FADE-OUTS
★ FADE-INS

With the PERFEC • FADE you merely move the handle to effect smooth, professional Fade-Outs and Fade-Ins. You control the length of Fade-Out! (Not an Iris.) Easily attached to any size camera. Complete with Universal Adapter and Fade-Out Mask.

\$2.95

★ THE PERFEC • FADE with these ADDITIONAL "NOVELTY" MASKS.

Single wipes, double wipes and vari-mask available at \$1 each. PERFEC • FADE with these additional 3 discs only **\$4.95**

ORDER YOUR PERFEC • FADE NOW!
Place your camera in the professional class with a PERFEC • FADE. Save C.O.D. charges by remitting with order.

MUTUAL PHOTO PRODUCTS CO.
403 LOEB ARCADE MINNEAPOLIS, MINN.

NOTICE TO MOVIE FANS

If you take movies (8mm or 16mm) you simply cannot afford to be without a Free copy of the latest Photo Bargain Book now being distributed throughout the U. S. Lists all the best moving picture equipment from all the leading manufacturers, describes them. The prices save you money in many cases. You'll find the latest in lenses, screens, meters, projectors, cameras, film, titlers, editing outfits, tripods, books on editing, titling, etc. This Bargain Book is invaluable to you as an equipment REFERENCE book. Don't wait a day longer to send for your Free copy. Write us now.

Central Camera Company
Dept. C9
230 S. Wabash Chicago, Ill.

FREE! MOVIE TITLING DEMONSTRATION KIT

- CREATE your own big theatre effects.
- PRODUCE Hollywood titles in black and white or color, with all the fun of doing it yourself.
- NOTHING MECHANICAL. Lasts forever. New effects for a lifetime.
- FREE—Try it yourself—Send Today.
- DEALERS—Write for Literature D11.

THE "A TO Z" MOVIE TITLING OUTFIT
Designed by Professionals for Amateurs

- ONLY \$2.00 COMPLETE •
- at All Leading Dealers or Send Direct to

STEIN STUDIOS
175 Fifth Ave., Dept. H11 New York, N. Y.

MOVIE CAMERA CASES

Finest Genuine Top-Grain Cowhide for All Popular Cameras. Postcard Brings FREE Literature.

OUR PRICES WILL SAVE YOU MONEY
Cameracraft Division, 1305 South Union Ave. Mail Order Only Los Angeles, Calif.

FREE LENS CLEANER

With our lists of 8-16mm Comedy, Travel, News and Novelty Films, including "Hollywood Stars" Film. Complete Univex stocks; Turret Cameras; 500-watt Projectors, all Accessories. Trades accepted.

JENKINS
Box 392, Elmira, N. Y.
Fastest Shipping Service in the United States

Why Use Anything Else When

TITLES BY PARK CINE

Cost No More Than Ordinary Titles?
Catalog Free on Request

PARK CINE LABORATORY
120 West 41st Street New York

Print Your Own Film Titles

Photo titles, stationery, greeting cards, bookplates, advertising, Easy rules furnished. Junior Outfits \$8.25 up. Senior \$17 up. Print for Others, Big Profits. Sold direct from factory only. Write for free catalog and all details. Kelsey Presses, W-94, Meriden, Conn.

EXCELSIOR



Get "Big Studio" Results in your Home Movies ... with this professional FADE-IN & FADE-OUT and these 6 popular MASKING EFFECTS.

FADE-OUT combined with

FADE-O-MASK

now specially priced complete with holder and 3 double masks **\$7.75**

WESCO FADE-OUT—the only vignetter producing a rectangular fade at ANY desired speed. Gradual Fading—In or Out—Fast or Slow at the will of the operator. NO SUDDEN SHUT OFF. Light weight ... rugged construction. Fits most all cameras. \$5.95 Comes with cable release and filter holder.

Special adaptor for Eastman lenses 75c. When ordering specify make and model of camera.

WESCO FADE-O-MASK—holder of durable tenite, takes the place of filter holder. Attached quickly and easily to the Fodette. The Wesco Fade-O-Masks of thin flexible pyralin are quickly and easily interchangeable, and give the movie maker on \$2.50 unlimited range of novel effects.

Ask your dealer for a demonstration
WESTERN MOVIE SUPPLY CO.
 254 SUTTER STREET SAN FRANCISCO

I've got a problem . . .

• Continued from page 106

cloth diffusers in front of them should give you sufficient safe illumination to make closeup and semiclose-up shots.

If possible, place the lights overhead or to one side of the baby so they will not shine directly in its face. Also, for successful shots of this kind, you should use an electric exposure meter.

Extension Tubes (Herbert E. Hillbrink, Redwood City, Calif.)

I would like to know if, by putting an extension tube

between my 8mm camera and its lens, if the focal length can successfully be increased? In other words, would a 1/2" focal lens plus a 1/2" extension tube convert my lens to one equal to 1" in focal length?

Ans. By adding an extension tube to your regulation half-inch camera lens, you would not increase its focal length. Instead, you would be converting it for use for ultra-closeup work. The extension tube would act as a sort of extra-large shim.

The Reader Speaks . . .

• Continued from page 108

single roll of film at a time or purchase commercially made short subjects for which we have no proper containers for safe storage. Smaller humidor cans should sell like hot cakes.

—*Geo. M. Grening.*

Swappers

Since the inception of this Swappers' service for our readers, the number of requests for exchange of filming is growing daily. We invite your requests. Be sure to specify size of film wanted—either 8mm or 16mm—and whether black and white or Kodachrome.

Gentlemen: There are some 8mm shots I would like to get of San Antonio, Texas. I wonder if any of your readers, living there, would care to make such shots for me in exchange for footage they would like made in and around Chicago?—O. J. Roberts, 1910 So. 4th Ave., Maywood, Ill.

Dear Sirs: I would like to make contact with some 8mm filers in Washington, D. C., and Charlottesville, Va., in order that I get some scenes to fill out movies I made during a vacation trip taken through that part of the country several months ago.—Ralph F. Spiker, 759 Ray Ave., N. W., New Philadelphia, Ohio.

Editor: I am interested in trading 8mm footage

made in the vicinity of Knoxville, Tenn. Any 8mm movie fan anxious to trade films, please contact me.—Bill Ferguson, 46 Taunton Pl., Buffalo, N. Y.

Gentlemen: I will swap 8mm footage of places of historical interest in Old Vincennes for shots of either the New York or San Francisco World's Fairs.—Robert M. Johnson, Vincennes, Ind.

Offers Services

Several readers have already written in commending HOME MOVIES for sponsoring and encouraging the "Shows for Shut-ins" movement. Reader Witmond is anxious and willing to do his bit if only adequate suitable films are made available to him.

Gentlemen: The December issue of HOME MOVIES contained an article on a subject I have been interested in for some time—that of showing movies to invalids and shut-ins. My point in writing is to offer my services with the use of my Filmo "8" projector one night a week for the showing of movies in hospitals or other such places, if only I can get the use of suitable film subjects which some film library or club may care to loan for this purpose.—Ernest F. Witmond, 5111 Delaware Ave., Eagle Rock, Calif.

FOR BETTER MOVIES

ZENITH CINEMA SERVICE offers you over 16 years experience in supplying amateur movie makers.

KODACHROME DUPLICATES—16mm—For outright sale. Eight different EUROPEAN countries, including Austria and Czechoslovakia—BRITISH COLUMBIA and ALBERTA—and 15 of the most colorful parts of WESTERN U. S. A. SEND FOR FULL DETAILS on these fine subjects. Beautifully photographed—superbly edited. Every one a valuable addition to your library.

CASTLE FILMS—We carry a full line of the popular black and white Castle Film Subjects.

USED EQUIPMENT BARGAINS—Write us for specials in cameras, projectors, screens, meters, lenses, tripods, splicers, film subjects, and titling outfits.

KODACHROME TITLES with picture backgrounds and fine lettering or from your own 2"x2" Kodachrome slides—fade ins—fade outs—and cross dissolves. We specialize in complete laboratory work of every description, including editing, duplicating, reductions, and enlargements.

RENTAL SERVICE—Our fine rental library contains over 350,000 ft. of 8mm and 16mm silent and 16mm sound subjects in black and white. Send 5c for film rental catalogue to cover postage. Rental films shipped only within a radius of 500 miles from Chicago.

ZENITH CAMERA SERVICE

5011 N. SAWYER AVE., CHICAGO, ILL.

Fine Movies Since 1924

Bass says:

Every Day is Bargain Day at My Shoppe for the **VICTOR 5** But forget the \$60 saving . . . think only of the 1" F:1.5 lens, the 5 speeds, adjustable parallax, geared motor, interchangeable lens mount, hand cranks, the 3-yr. factory warranty and the many other features. Yes, sir, formerly \$197.50 but at BASS only \$137.50

Thousands of items, bargains, values, in the new **CINE BARGAINING** No. 240. FREE, so write

Bass CAMERA CO.
 179 W. MADISON ST. CHICAGO, ILL. Dept. H. M.

8mm SLITTER

Slits perfectly 16mm width film to exact 8mm width. Die cast body with hardened steel cutting wheels. New price, each, \$2.50.

DEVELOPING RACKS

Stainless steel, take 30 feet 16mm or 8mm width film. Can be used in 11x14 or 8x10 flat trays respectively. Complete with loading stand, each, \$6.75. Specify type wanted.

At Your Dealer's or Direct

J. C. Haile & Sons

Motion Picture Dept.
 215 Walnut Street Cincinnati, Ohio

"REVELATION" 8mm MOVIE FILM 16mm

Top quality movie film at bargain prices. A DuPont Product. Packed and processed by Pacific Coast Film Company. Prices include reversal processing, SPECIAL INTRODUCTORY

GET ACQUAINTED

REVELATION No. 1—Weston 12, Scheiner 2D

A better grade outdoor film, non-halation, that provides wide latitude and softness of detail, takes sharp, clear, clean pictures of professional quality.

30 ft. single 8mm on daylight loading spools	\$.75 each
2 or more	.60 each
25 ft. double 8mm on daylight loading spools	1.50 each
2 or more	1.25 each
50 ft. 16mm on daylight loading spools	1.75 each
2 or more	1.50 each
100 ft. 16mm on daylight loading spools	3.00 each
2 or more	2.75 each

Ample leader footage.

REVELATION No. 2—Weston 50, Scheiner 26

A super-sensitive, non-halation film, fine grain, extremely high speed. Clear, beautiful pictures, either indoors or out.

30 ft. single 8mm	\$1.00 each	2 or more	\$.85 each
25 ft. double 8mm	2.00 each	2 or more	1.75 each
50 ft. 16mm	\$2.75 each	2 or more	2.50 each
100 ft. 16mm	4.50 each	2 or more	4.25 each

Ample leader footage.

All orders POSTPAID. C.O.D. orders postage extra. Save on your movie film—make more pictures at less cost by buying direct by mail from the Pacific Coast Film Company. Prompt, reliable service. Order now! Calif. buyers include tax.

PACIFIC COAST FILM COMPANY
 1510 North Sierra Bonita Hollywood, California
 ALSO 35MM FILMS FOR CANDID CAMERAS

SOLAR FILM

Costs Less!



SAVE MONEY without SACRIFICING QUALITY

Solar SUPER Outdoor Film. Full ortho, non-halation, wide latitude, Weston 12. Double 8mm, 25 ft. (each \$1.39) **2 rolls \$2.19**

16mm, 100 feet (each \$2.95) **2 rolls \$4.69**

Solar ECONOMY Outdoor (semi-ortho, Weston 8). 16mm, 100 feet. **\$1.98**

*** FAST RELIABLE SERVICE.** Processing and return postage included. Order today direct from this ad. Send only \$1 and we ship C. O. D. for balance. Or remit in full and save postal fees. Patrons west of Rockies order from West Coast Branch.

Dealers and Jobbers Write for Our Proposition

SOLAR CINE PRODUCTS INC.
 Main Office, 3827 Archer Ave., Dept. A1, Chicago, Ill.
 West Coast Branch, Box 45, Dept. A2, Arlington, Calif.

Kodachrome Duplicates

16mm, 10c per foot—Minimum \$5.00

4 DAYS SERVICE!

Write for Information

HOLLYWOOD STUDIOS
 9320 California Ave. South Gate, California

BETTER Home Movies

Write for our price list. when you use **Wonderlite Photo Lamps**

WONDERLITE CO. 14-H Northfield Ave. WEST ORANGE, NEW JERSEY

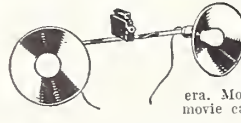

GIBBS FLOOD-GUNS

The ONLY flood-light that follows the camera. Models for either still or movie cameras.

ARTHUR E. GIBBS
 1925 N. E. Knott St. Portland, Oregon

ONYX

FILM SAVES YOU MONEY

100 feet 16mm	\$2.60
25 feet double 8mm	\$1.20
30 foot Univex reload	.65 cents

No additional charge for processing. Daylight loading spools. Immediate service by return mail.

KENWOOD FILMS 1238 E. 46TH ST. CHICAGO, ILL.

CLASSIFIED

ADVERTISING

EQUIPMENT FOR SALE

16MM CAMERAS

Cine Kodak BB F 1.9 Lens and Case, \$32.50.
Cine Kodak M F 3.5 Lens, \$24.50.
Cine Kodak B F 3.5 Lens, \$19.50.
Stewart-Warner F 3.5 Lens and Case, \$20.00.
Agfa Movex F 3.5 Lens, \$15.00.
Ensign Autokinecam F 2.6 Lens and Case, \$35.
Ensign Autokinecam Turret F 2.6 Lens and Case, \$50.00.

Victor 3 Camera, F 1.9 Wirgin Lens and Case, \$57.00.
Victor 3 Camera, F 1.5 Wollensak Lens and Case, \$62.00.

Filmo 75 Camera, F 3.5 B & H Lens and Case, \$25.00.
Filmo 70A Camera, F 3.5 Cooke Lens and Case, \$35.00.

Filmo 70A Camera, F 3.5 Cooke Lens and Case, \$35.00.
Filmo 70A Camera, F 1.5 Wollensak Lens and Case, \$59.50.

Filmo 70D Camera, F 3.5 Cooke Lens and Case, \$80.00.
Filmo 70D Camera, F 2.7 Cooke Lens and Case, \$135.00.

Simplex CC Camera, F 1.9 KA Lens, \$52.50.
Simplex Camera, F 3.5 Ilex Lens, \$17.50.

Filmo 141 Camera, F 2.7 Cooke Lens, \$74.50.
Filmo 121 Camera, F 3.5 Cooke Lens, \$40.00.
Keystone B F 3.5 Wollensak Lens, \$12.50.
Keystone A3 F 3.5 Wollensak Lens, \$22.50.
Keystone A7 F 2.7 Wollensak Lens, \$28.50.

16MM PROJECTORS

Wiloscope Jr. Projector, 200 Watt, \$19.50.
Wiloscope Sr. Projector, 300 Watt, \$22.50.
Keystone A72 Projector, 300 Watt, \$23.50.
Keystone A74 Projector, 300 Watt, \$27.50.
Keystone A75 Projector, 500 Watt, \$38.50.
Keystone A81 Projector, 750 Watt, \$48.50.
Standard S Projector, 500 Watt, \$24.50.
Standard S Deluxe Projector, 750 Watt, \$37.50.

Kodascope E Projector, 250 Watt, \$40.00.
Kodascope EE Projector, 750 Watt, \$45.00.
Kodascope G Projector, 750 Watt, \$85.00.
Kodascope B Projector, 250 Watt, \$34.50.

Ampro A Projector, 200 Watt, \$32.50.
Ampro JS Projector, 750 Watt, \$72.50.

Filmo 57A Projector, 200 Watt, \$27.50.
Filmo 57A Projector, 250 Watt, \$35.00.

Filmo 57 Projector, 400 Watt, \$45.00.
Filmo 57GG Projector, 375 Watt, \$55.00.

Filmo LL Projector, 500 Watt, \$82.50.
Filmo 129C Projector, 750 Watt, \$125.00.

Filmo JS Projector, 750 Watt, \$137.50.
Filmo Filmomaster Projector, 750 Watt, \$100.

8MM CAMERAS

8mm Stewart-Warner F 3.5 Lens, \$15.00.
8mm Keystone, F 1.9 Lens, \$35.00.
Cine Kodak 8-20, F 3.5 Lens, \$19.50.
Cine Kodak 8-25, F 2.7 Lens, \$28.50.
Filmo Sportster, F 2.5 Lens, \$51.50.

8MM PROJECTORS

Keystone M8 Projector, 300 Watt, \$23.50.
Keystone R8 Projector, 500 Watt, \$38.50.
Kodascope 8-25 Projector, 100 Watt, \$16.00.
Kodascope 8-40 Projector, 200 Watt, \$16.50.
Kodascope 8-50 Projector, 300 Watt, \$18.50.
Filmo 122B Projector, 500 Watt, \$97.50.
Keystone G8 Projector, 200 Watt, \$18.00.

ACCESSORIES

15mm F 2.7 Wollensak Stand Mount, \$18.50.
15mm F 2.9 Dallmeyer Stand Mount, \$22.50.
1" F 3.5 Cooke Stand Mount, \$7.50.
20mm F 3.5 K A Lens Stand Mount, \$10.00.
1" F 1.5 Plasmat Stand Mount, \$40.00.
1" F 1.9 Wirgin Lens Stand Mount, \$25.00.
1" F 1.5 Wollensak Stand Mount, \$34.50.
1" F 2.7 C Z Tessar Stand Mount, \$25.00.
1" F 1.4 C Z Biotar Stand Mount, \$55.00.
2" F 3.5 Wollensak Telephoto Stand Mount, \$22.00.
2" F 3.5 Wollensak Verito Telephoto Stand Mount, \$12.00.
2" F 3.5 Goerz Hypar Telephoto Stand Mount, \$27.50.
3" F 4 Tele Megor Telephoto Stand Mount, \$37.50.
3" F 4.5 Kodak Telephoto Cine Kodak K, \$32.50.
3" F 4 Trioplan for Simplex Stand Mount, \$20.00.
4" F 4.5 Cooke Telephoto Standard Mount, \$40.00.

Eastman Universal Splicer, \$8.50.
Bell & Howell Rewinder and Splicer, \$7.00.
Seeman Editor for 8mm or 16mm, \$7.95.
Keystone 835 Editor, 16mm, \$7.25.
Craig Sr. Rewind and Splicer, \$12.75.
Bell & Howell Continuous Attachment, \$20.00.
Besbee Universal Titler, \$7.95.
Besbee Pro Trik Titler Frame, \$10.00.
Wrico Lettering Set, \$5.95.
Filmo Character Titler, \$22.50.
30x40 Box Type Beaded Screen, \$9.85.
36x40 Box Type Beaded Screen, \$12.00.
30x40 Tripod Model Beaded Screen, \$9.00.
Thalhammer Jr. Tripod with Pan and Tilt Head, \$14.50.
Thalhammer Sr. Tripod with Pan and Tilt Head, \$19.00.
Testrigh Tripod with Pan and Tilt Head, \$10.50.
WILLUGHBY'S, 110 W. 32nd St., New York

• Ten cents per word; minimum charge, \$2.00 cash with order. Closing date, tenth of preceding month. • HOME MOVIES does not guarantee goods advertised.
• Send ads to 6060 Sunset Boulevard, Hollywood, California.

EQUIPMENT FOR SALE

• BASS SAYS: Beware the Ides of March, but not a Bass bargain. Money-back guarantee.

USED CAMERAS

Keystone 8, F:3.5 lens, \$16.75.
8mm Cine-Kodak Model 20, F:3.5 lens, \$19.75.
8mm Univex, F:1.9 lens, telescopic finder, \$24.50.

16mm Cine-Kodak Model B, F:3.5 lens, \$24.50.
Simplex Pockette Magazine, F:3.5 lens, \$25.00.
16mm Cine-Kodak Model E, F:3.5 lens, \$27.50.
Filmo 70-A, F:3.5 Cooke and case, \$37.50.
16mm Filmo 75, Cooke F:1.8 lens, focusing mount, \$52.50.

Filmo 141-A Magazine, Cooke F:2.7, \$87.50.
Filmo 70-D, with 1" Wollensak F:1.5, 2" Carl Zeiss Tessar F:2.7, 1" Cooke F:3.5 and case, \$175.00.
Cine-Kodak Special, latest model, Kodak F:1.9 lens, \$307.50.

USED PROJECTORS

16mm Kodascope B, 750 watt bulb, \$42.50.
Ampro Model A, 400 watt, case, \$47.50.
Keystone A-81, 750 watt, \$47.50.

USED SOUND ON FILM PROJECTORS

Victor Model 25, S.O.F., 500 watt bulb, \$125.
Victor Model 38, S.O.F., 750 watt bulb, \$245.
New Boole four-way Fader, spring driven, complete, fits all cameras, \$17.50.

UP-TO-THE-MINUTE TEXT BOOKS

American Cinematographer Handbook and Reference Guide, invaluable. Special at 97c, postpaid.
Trick Effects With the Cine Camera, \$1.00 postpaid.

Home Processing, includes all necessary information, by Harris, \$2.00, postpaid.

Be sure to get your copy of our great 66-page Cine Catalog No. 240. It is free. Also 72-page Still Camera Catalog No. 242.

BASS CAMERA COMPANY

Dept. HC 179 W. Madison St., Chicago, Ill.

• LIKE NEW, Bell & Howell 16mm Filmo 70-DA, f/2.7, 15mm and 4" telephoto lens, Mayfair case, 2 filters, editing and splicing outfit—\$300.00. Like new, Bell & Howell gear-driven 16mm projector, cost \$139.00. Price, \$100.00. J. C. BUNTON, M. D., 2815 Central Ave., Cheyenne, Wyo.

• NEW KODAK "8" Model 60, f/1.9 lens, \$49.95. Titler, \$4.50. Yellow Filter, \$1.50.
FLANAGAN, 5 Richardson St., Providence, R. I.

• AMPROSOUND in good condition, list \$415.00, will exchange for silent Filmo 129-D or 130 model projector. JOSEPH MANDELA, 114 Krakow St., Elizabeth, New Jersey.

TITLING SERVICE

• HOLLYWOOD PROFESSIONAL Title Service. Colored Films, Backgrounds, Special Effects—16mm or 8mm, low as 25c. FREE Main and End Titles. Write for particulars. ORBIT, 5437 $\frac{1}{2}$ Hollywood Blvd., Hollywood, Calif.

• TITLES that will give your films a professional touch. 16mm or 8mm. Free samples and catalog. Editing—Titling—Processing. CINECO LABORATORIES, 209 Mass. Ave., Boston, Mass. Loew's Theatre Bldg.

• ANY TITLE published in Home Movies, 8mm—15c. Eight for \$1.00. Mail only. HANGER, 1616 S. Spaulding, Los Angeles.

• TITLE YOUR Home Movie Films with artistic title backgrounds, same as appear Home Movies Magazine. Pkg. 25 titles, 50c. Specify for color or black and white. VER HALEN PUBLICATIONS, 6060 Sunset Blvd., Hollywood, Calif.



For Future Reference-

File your copies of HOME MOVIES Magazine in one of these attractive gold-stamped leatherette binders.

Price
\$1.25
Each

VER HALEN PUBLICATIONS
6060 Sunset Blvd. • Hollywood, Calif.

ACCESSORIES

• TELEPHOTO for Keystone or Filmo 8mm 1" f/3.5 Wollensak Velostigmat, \$19.95. CUSTOM-BUILT CAMERA ACCESSORIES CO., 4124 Rawlins St., Dallas, Texas.

• SCREENS—Make Your Own! Glass beads \$1.00 pound. Sound recording. Slightly used Wilcox-Gay Recordio, \$60.00. ROY HAYES, 34 N. Washington Ave., Battle Creek, Mich.

• SAVE! Catalog! News Bulletin! Bulk Films! 8mm-16mm Film Subjects galore! Cameras! Projectors! Accessories! Send Postal! PENNCRAFT, 423 Williamsport, Pa.

• MOVIE CAMERAS, Films, Projectors, etc., bought, sold, and exchanged. Big lists Free. Art samples, 25c. PEERLESS, Box 1310-H, Hollywood, Calif.

FILM RELEASES (8 and 16mm)

THE ABBE FILMS

1265 Broadway N. Y. City
invites you to mail in your 8mm or 16mm film subjects and will be glad to advise and quote best exchange rates. Large variety Castles, Arts, Chas. Chases, Chaplins, Snub Polards on hand.

• CASTLE FILMS Library, Sales—Exchanges. Offering finest exchange services. Keystone sales—service—parts. RIEDEL FILMS, 2221 West 67th St., Cleveland, Ohio.

• FIVE CHILD health, training and character building films. Prenatal, Child's First Year, One to Six, Grade School, High School. 16 and 8mm silent and sound, sale or rent. Write DAVID B. HILL, Salem, Oregon, or Bell & Howell Company, Chicago, Illinois, or local dealers everywhere.

• HANIK 16mm FILM RENTAL CLUB Comedies—Art Features
1225 Stowe Ave. McKees Rocks, Pa.
JOIN NOW! FREE CATALOG!

• NEW VARIETY 8-16mm unusual subjects. Western, Comedy, Travel. Send 10c for sample and list. RIO FILMS, Box 421-C, Hornell, N. Y.

FILM

• IT'S SENSATIONAL! Semi-Ortho film, Weston 8, 100 ft. double 8mm or 16mm, \$1.50 postpaid. Use for reversal, titles, copies, etc. Unusual Art Film catalog—send 10c for sample and catalog. ERWINE'S CINE LABORATORIES, 143 N. 9th St., Allentown, Pa.

• FREE FILM—8-16mm, Scheiner 18. Send your order today. We process. MGM PHOTO SERVICE, 1485 Oak, San Francisco, Calif.

WANTED

• R.C.A. NEWSREEL Camera wanted, with or without equipment. State details. H. BERESFORD SMITH, Coscob, Conn.

• SPORT FILM negatives wanted—original 16mm and 8mm—particularly on Jui Juitsu, boxing, and similar subjects. Any length. Positives o.k. if negatives not available. STONE, Box 16, Station W, Brooklyn, N. Y.

• WE WILL PAY \$ \$ \$ for new Movie Kinks and Gadgets that we can use for resale purposes. MIROTEX PRODUCTS, 6241 Southwood Ave., St. Louis, Mo.

• USED VICTOR 5 with windback. State condition. Will pay cash. Have Eastman model "B." f/3.5. J. DeLAURENTIS, 98 Gordon Hill Rd., Waterbury, Conn.

MISCELLANEOUS

• PUMP SHOTGUNS, target pistols, binoculars and medical microscopes accepted in trade on everything photographic, such as Leicas, Contaxes, Eastman and Bell & Howell motion picture equipment, Da-Lite Screens and Webster sound equipment, including public address systems, amplifiers, etc. Write for catalog. NATIONAL CAMERA EXCHANGE, established in 1914, 11 S. 5th St., Minneapolis, Minn.

• YOUR DOG can become your most willing actor. Let me educate him. Courses in obedience, tricks, and special movie work. Cost depends upon what you want him to learn. Free details. JOHN KLOK, Lyons, Michigan.

• DON'T FAIL to title those personal films. Make them a complete record. Any 8mm or 16mm movie maker can make professional looking titles with the PIN LETTER TITLING SET. Basic set of 150 white block 3/4-inch letters is priced at \$5.50. A dozen other size and style letters are available as well as many interesting title decorations. Write for pamphlet or ask your camera store for demonstration. Nittens Letter Company, Redlands, Calif.

• MOVIE TRICKS AND GADGETS containing paragraph after paragraph of interesting data for the Cine Amateur. Price 75c, postpaid to you. VER HALEN PUBLICATIONS, 6060 Sunset Blvd., Hollywood, Calif.

ORDER FOR SUBSCRIPTION

Home Movies Magazine

12 MONTHS FOR \$2.00 IN U. S.

In Canada, \$2.00; Foreign—\$3.00

SPECIAL OFFER: 3 Years for \$5.00 in the U. S.

HOME MOVIES

Sunset Blvd.

Hollywood, Calif.



Send to.....

Address

City..... State.....

New Renewal Gift

Send to.....

Address

City..... State.....

New Renewal Gift



Enclosed find \$..... Date..... 19.....

Sent in by.....

Address

City..... State.....

NO SUBSCRIPTIONS ACCEPTED FOR LESS THAN ONE YEAR





TITLE Backgrounds

By EDMUND TURNER

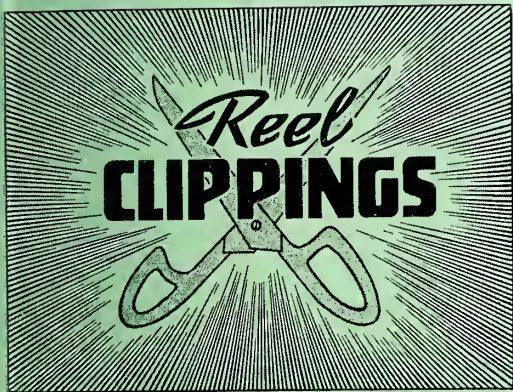

This month — for the benefit of Kodachrome filers — we present our art title backgrounds in color! This does not mean these backgrounds cannot be used with black and white film — they can! With reversal or positive films, the green color will photograph a pleasing grey — just the same as though tinted or mottled titled cards were used.

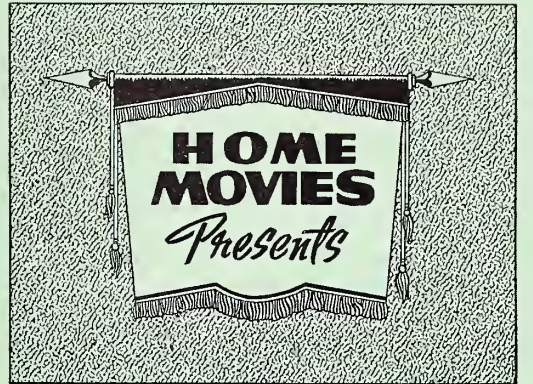

Also, this month, we start the first of our series of title backgrounds for states and popular points of interest, with cards for New York, Florida, Alaska, and "Mardi Gras" for New Orleans.

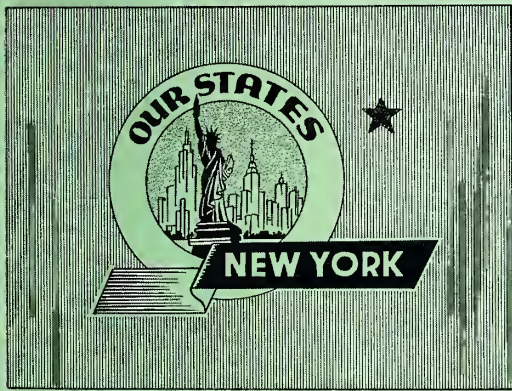

One of the most novel and useful backgrounds is that, second from the top, in the right-hand column. By cutting out the white area bearing the inscription "Home Movies presents . . ." this background may be used as a frame for scroll titles. The strip of paper carrying the scroll lettering would be moved vertically behind the background.

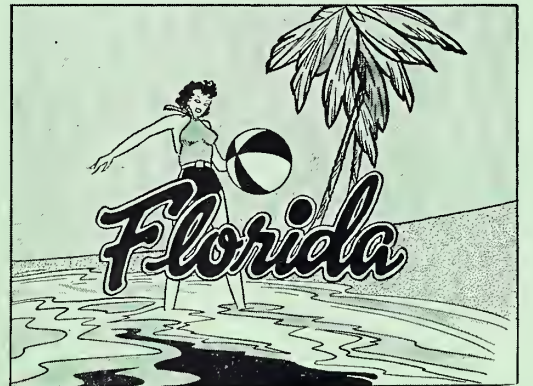

These backgrounds are reduced in size to fit the average typewriter titler. However, they may easily be enlarged to fit the title card holders of all other titlers by photostat or photographic process. Where only a slight overall enlargement is necessary, you will find it very effective as well as convenient to simply paste the background over a card of the required size cut from tinted or figured material. Wallpaper will give good results.

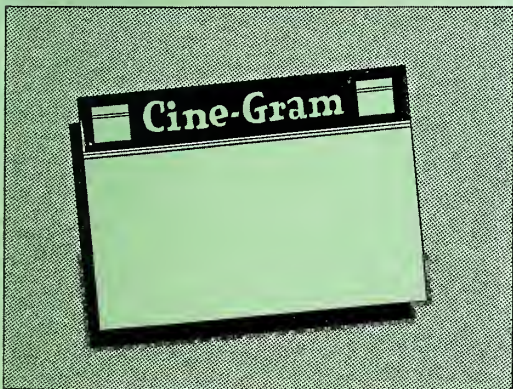

Here is an additional, timely caption that may be cut out and pasted in the lettering area of the fourth or eighth title background on this page:

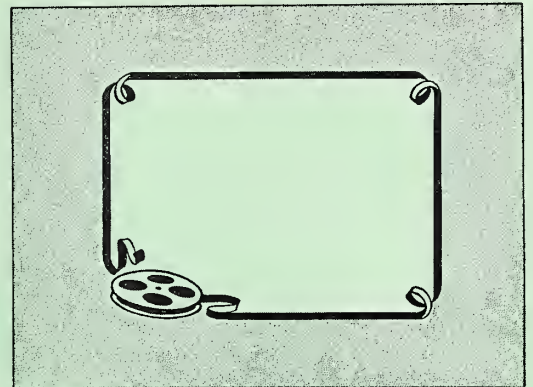

EASTER—1940

The Editors welcome suggestions from readers for title backgrounds and supplemental title captions. Send us your ideas.

HOME MOVIES title backgrounds are now available in packets of 25 assorted cards for either black and white or Kodachrome films. The Kodachrome assortment is printed in colored inks on a variety of tinted papers, offering the amateur a splendid series of multi-colored art backgrounds for his titles. Order direct from HOME MOVIES, enclosing 50 cents for each set desired.



It Really is Special

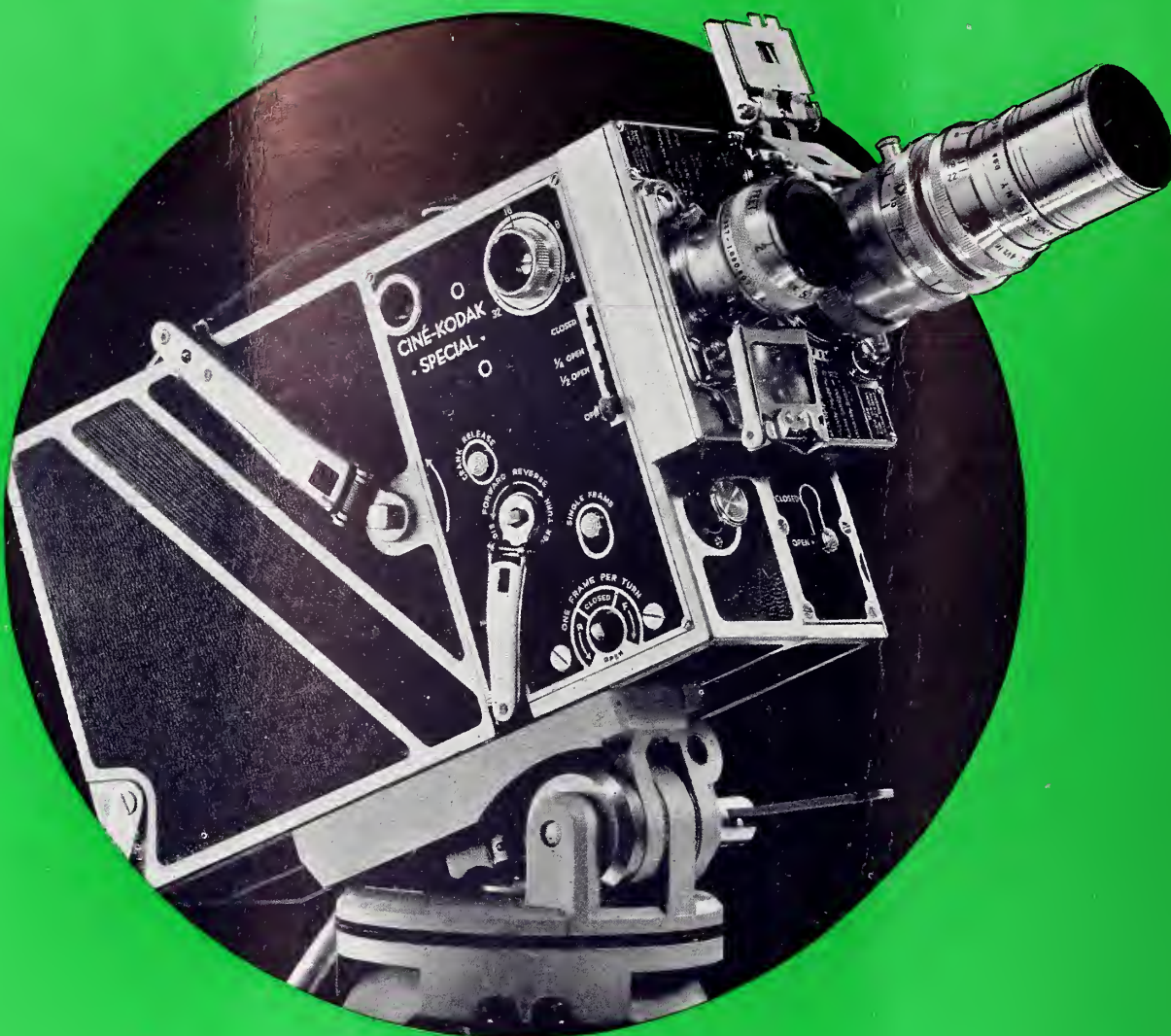

CINÉ-KODAK SPECIAL

IT'S a superb 16 mm. motion picture camera, of course. But the quality that sets Ciné-Kodak Special apart is the fact that it is truly special, in every sense of the word.

Designed by men with specialized experience in cinematography and built in a special shop devoted exclusively to work of the highest precision, Ciné-Kodak Special is the logical camera not only for advanced 16 mm. cinematographers, but also for specialists in such fields as medicine, biology, physics, engineering, athletics, and drama.

A copy of the book, "The Story of the World's Finest 16 mm. Movie Camera," may be obtained, free, from your dealer or direct from Rochester.

Some of the features of Ciné-Kodak Special, basic model: adjustable shutter opening . . . variable camera speeds, 8 to 64 frames per second . . . reflex finder, functioning with all lenses . . . interchangeable film chambers (200-ft. cham-

bers available as extras) . . . capacity for fades, dissolves, mask shots, animations, and many other "professional" effects . . . may be fitted with eight instantly interchangeable accessory lenses, ranging from a 15 mm. $f/2.7$ wide angle to a 6-inch $f/4.5$ telephoto lens, each with its own front view finder element . . . regularly equipped with the Kodak Anastigmat 25 mm. $f/1.9$ lens . . . film footage meters on both mechanism and film chamber . . . frame counter . . . masks for double and multiple exposures.

ACCESSORIES EXTEND USEFULNESS

Among the many accessories available are several types of electric motor drive . . . optical finder . . . reflex finder image magnifier . . . lens extension tubes for semi-microscopic work . . . electric time lapse outfit for studies involving single frame exposures at fixed intervals, from $\frac{1}{4}$ second to 24 hours. The price of the basic model is \$417.50.

EASTMAN KODAK COMPANY, ROCHESTER, N. Y.

Price 25c

HOME MOVIES

Register of Copyrights
Washington, D. C.



FILE

LIBRARY OF CONGRESS
APR 23 1942
PERIODICAL DIVISION

FILE

THE LIBRARY OF CONGRESS
APR 28 1942
COPY.....
CENTRAL SERIAL RECORD

Fred J. Roth

April • 1940

Hollywood's Magazine for the Amateur

**3
NEW
Hollywood
Home Movie
Films!**



MOVIE STARS' GOLF GAME

Bing Crosby and Paulette Goddard challenge Bob Hope and Ruby Keeler in a charity benefit golf game. This film shows the stars in action on greens and fairways and contains fine closeups of all during presentation of the trophy. In ordering, specify No. 624-A.

8mm: 50-ft. — \$1.25
16mm: 100-ft. — 2.50



OUR NAVY

Our nation's mammoth defenders in action on the high seas! Shows battleships in fighting formation, firing broadside after broadside; laying smoke screens; and close-ups of gun crews in action. Also shows high speed destroyers maneuvering with the Navy's air force. A timely, thrilling film. Specify No. 137-A.

8mm: 50-ft. — \$1.00
16mm: 100-ft. — 2.00



CAMERA THRILLS

Hollywood's daring movie stunt men in action crashing cars, and stunting on horses, motorcycles, etc. Thrilling scenes taken at a recent field day exhibition put on by the men and women who put the punch in Hollywood's movie thrillers! Specify No. 1071-A.

8mm: 50-ft. — \$1.25
16mm: 100-ft. — 2.50

*These
Hollywood
8mm and 16mm
Home Movies are
"Screen-Tested,"
assuring perfect
prints. Ask your
dealer for a dem-
onstration screen-
ing of these films!*

Distributed Exclusively by

SEEMANNS, INC.
HOLLYWOOD, CALIF.

HOLLYWOOD FILM ENTERPRISES, INC.

6060 SUNSET BLVD. • • HOLLYWOOD, CALIF

**WRITE
FOR
FREE
CATALOG!**

APR 3 1940

©CIB 451445 92



★ Shot of the Month . . .

VP

home MOVIES

Copyright 1940 by Ver Halen Publications. No part of magazine may be reprinted without specific permission.

CONTENTS FOR APRIL, 1940

THE READER SPEAKS	160
BACKYARD MOVIES	162
INFORMATION PLEASE	164
PRACTICE PERFECTS HOME REVERSAL RESULTS. <i>By G. W. Cushman</i>	167
"PRO'S" EFFECT TRICKS NO LONGER SECRET. <i>By Ralph S. Wilshin</i>	168
SPOTLIGHTS LIGHT WAY FOR BETTER FILMING. . . <i>By Curtis Randall</i>	170
THE "MAGIC WAND"—SCRIPT, TITLES AND ALL! <i>By Walter Bergman</i>	172-3
HERE'S THE 1940 "DREAM" CAMERA! <i>By Ray E. Merville</i>	174-5
THIS NEW DEVICE SPEAKS YOUR TITLES. <i>By Ray Fernstrom</i>	176
HERE'S TIP FOR FILMING TRICK "GHOST" SHOTS <i>By E. M. Liebscher</i>	177
"FINLAND FIGHTS" FILMED AT 40 BELOW ZERO! . . . <i>By Jack Irwin</i>	178
MOVIE OF THE MONTH. <i>By J. H. Schoen</i>	179
IF IT'S COLOR YOU WANT, TRY TONING! <i>By F. C. Moultrie</i>	180
TELL ME — HOW CAN I IMPROVE MY FILM? . <i>Reviews by the Editors</i>	181
EXPERIMENTAL CINE WORKSHOP.	182-3
IT'S NEW TO ME.	184
EXPOSURE METER GUIDE.	196
INDOOR LIGHTING CHART.	200
TITLE BACKGROUNDS	201
DIRECTORY OF AMATEUR CINE CLUBS.	202

A P R I L
1940
NUMBER 4
VOLUME VII



★ Shot of the Month—Enlargement reproduction from H. H. Wijnblad's 16mm movie, "Storm." A fine study in silhouette composition.

CHAS. J. Ver HALEN
PUBLISHER

C. J. Ver HALEN, JR.
ASSOCIATE PUBLISHER

ARTHUR E. GAVIN
EDITOR

OFFICE OF PUBLICATION
6060 Sunset Boulevard, Los Angeles, Calif.
Phone GRanite 5149

NEW YORK OFFICE
Everett Gellert, 62 West 45th Street
Vanderbilt 6-5254

CHICAGO OFFICE
C. N. Burris, 712 Wrigley Building
Whitehall 7784

RAY FERNSTROM
Technical Editor
GEORGE W. CUSHMAN
R. E. MERVILLE
J. H. SCHOEN
Associate Editors
COUNT H. von SCHOENFELDT
Photographic Editor
C. E. BELL
Associate Photo Editor
L. C. BUSCHER
Art Director
SEYMOUR B. AGINS
Asst. Art Director

HOLLYWOOD'S MAGAZINE FOR THE AMATEUR

Registered as Second-Class Matter, May 6, 1938, at Postoffice at Los Angeles, California, under the Act of March 3, 1879.
Subscription rates—U. S. \$2.00 a year. Canada 1 year. Foreign \$2.50 a year. Single copies 10c. Foreign single copies 35c. Copyright, 1940, Ver Halen Publications. Advertising Rates on Application.

AUTHENTIC HOME

FINLAND



MOVIE RECORD OF RUSSO-FINNISH WAR!

FIGHTS!

First 16 MM • 8 MM Movies of Red Invasion in the Arctic... filmed at 40 below zero!

NOW own a permanent record and review the whole fantastic spectacle as bravely filmed by twelve ace cameramen under land and sky fire in 40-below zero weather.

See the ruthless bombing of Helsinki and the flight of its terrorized citizens. See the Reds dropping troops from the sky by parachutes. See the famous Finnish ski troops in thrilling action. See the heroic Finns destroy their own

homes to impede the enemy advance. See dramatic actual fighting on the famed Mannerheim Line. Thrill to scene after scene of Finland's great heroes defending their homeland against overwhelming odds.

Castle Films brings this saga of bravery right into your own home in a startling film that features some of the most amazing scenes ever pictured.

NO ADVANCE IN PRICES FOR THIS SPECTACULAR CASTLE FILM

Order from your Photo Dealer Today:

8 mm. 50 ft. \$1.75—180 ft. \$5.50 16 mm. 100 ft. \$3.50—360 ft. \$8.75

Sound-on-film 350 ft.—\$17.50

CASTLE FILMS

30 ROCKEFELLER PLAZA
NEW YORK

WRIGLEY BUILDING
CHICAGO

RUSS BUILDING
SAN FRANCISCO

PERSONAL ORDER BLANK

Mail This to Your Photo Dealer Today!
Reserve for earliest delivery

"FINLAND FIGHTS"

.....mm. size foot length

Name.....

Address.....

City and State.....

Announcing



THE NEW MODEL 88 Revere Double 8 CAMERA

Licensed Under Eastman Double 8
Spool and Spindle Patents

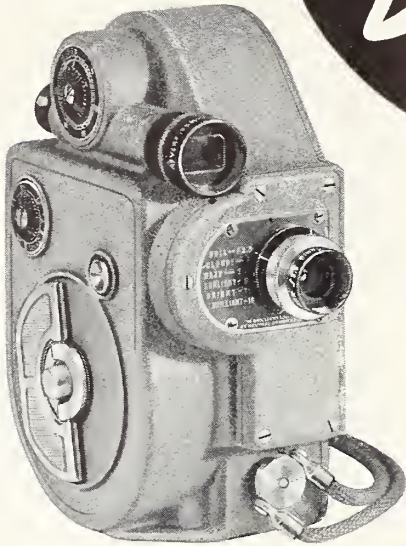

**For Brighter COLOR or
Black and White Movies**

The new Revere Model 88 Double 8 Camera sets a new standard for ease of operation, steadiness, brilliance of pictures and beauty of appearance. It takes any Double 8mm film—color or black and

white. Important improvements, combined only in this camera, include automatic loop-forming feature that prevents film jamming; sprocket control to eliminate strain on film gate and insure rock-steady pictures; Eastman type spindles to insure correct placing of spools for both sides of Double 8 film. An exceptionally fine optical viewfinder, parallax-corrected. You take what you see. 5 speeds, 8, 12, 16, 24, 32 frames per second for ultra fast or slow motion and trick Hollywood effects. See this precision camera at your dealer's today! COMPLETE WITH WOLLENSAK F 3.5 LENS \$29.50. Interchangeable lenses available, F 2.7, F 1.9, 1½" Telephoto. Write for literature. Use the coupon.



New Sprocket Control forms loop automatically ... an exclusive REVERE feature.

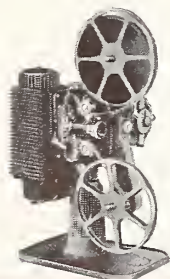

**Snap Up Your Movies With the
Revere Standard 8 Projector!**

The Model 80 Series B with its 500-watt optical system, F L.6 lens, high ratio duplex shuttle film movement, double blower cooling system, AC-DC motor, and other advanced features challenges the entire field for perfect projection and maximum film protection. Complete with 500-watt lamp and F-1.6 lens, \$59.50.

Revere Double 8 Camera
AND OTHER STANDARD CINE EQUIPMENT

REVERE CAMERA COMPANY • CHICAGO
PHILADELPHIA • KANSAS CITY • MINNEAPOLIS • LOS ANGELES • DALLAS

REVERE CAMERA COMPANY
Dept. 4HM, 326 E. 21st St.
Chicago, Ill.

Please send latest literature on the
new Revere Double 8 Camera and
Revere Standard 8 Projector.

Name.....
Address.....
City..... State.....

The Reader



SPEAKS

Reader Speaks Testimony

Comes here a reply to a reader's query which appeared in an earlier issue of HOME MOVIES magazine anent the effect of age on cine films.

Dear Sirs: In the October issue of HOME MOVIES there appeared an excerpt from a letter from one of your readers asking for data on the permanency or probability of deterioration of cine films. I have been a movie amateur fan since 1924, and it is my privilege to have some personal films taken during that year and later which are still in perfect condition. The fact that all of my films have been given good care—storage in a cool, dark and somewhat moist location—is no doubt entitled to much of the credit for their present perfect condition.

— O. F. Long.

Swappers

Here are more opportunities for film swappers. In sending in notices of film to swap or footage wanted, be

sure to specify whether 8mm or 16mm.

Dear Sirs: I would like to swap good 8mm Kodachrome shots of Miami, Fla., and vicinity for 8mm Kodachrome footage of almost any locality, but particularly am I interested in shots made in Texas, Arizona, New Mexico and snow scenes.—Felix Zelinka, c/o The Fleischer Studios, Miami, Fla.

Gentlemen: I would like to get in touch with some 8mm fan living in Springfield, Mass., who either has some surplus shots or would be willing to make some of the town for me. Springfield is the former home of my grandparents for whom I would like these pictures.—H. R. Hilt, 5343 S. E. 44th Ave., Portland, Ore.

Gentlemen: I should like to obtain 20 to 30 feet of well-exposed 8mm Kodachrome to splice into my reel of the 1939 New York World's Fair.—R. H. Swartzwelder, 225 So. 4th St., Philadelphia, Pa.

Play Safe

That the glove compartment
• Continued on page 199

CINE QUIZ

Test your knowledge of cinefilming by answering the questions that follow. Correct answers will be found on page 188.

- Which process affects only the emulsion of cine film?
 - Toning.
 - Tinting.
- What is the advantage of using ultra fast films in bright sunlight?
 - Better tonal values.
 - Increased definition from use of smaller stop which film permits.
 - No halation effects.
- Which of the following lens markings is not a "full" stop in relation to the other markings?
 - f/2, f/2.8, f/3.5, f/4, f/5.6.
- To shoot a scene in which a number of different objects at varying distances from the camera are to be kept in sharp focus, which lens should be used?
 - Wide angle?
 - Telephoto?
 - Standard?
- How many light sources are required to obtain a three-dimensional effect in lighting interior scenes?
 -
- What is the principal cleansing agent used in cleaning cine film?
 - Cold distilled water.
 - Carbon tetrachloride.
 - Highly refined gasoline.



The **DA-LITE MODEL B SCREEN** is ideal for semi-permanent installations in school classrooms or game or projection rooms in homes. Twelve sizes from \$7.50 up. Prices slightly higher on Pacific coast.

You Need all Three



The most convenient of all portable screens is the **DA-LITE CHALLENGER** shown here. The Glass-Beaded surface is spring-roller-mounted in a metal case to which a tripod is pivotally and permanently attached. It can be set up anywhere in 15 seconds, yet folds compactly for easy carrying. The only screen with **square tubing** in the tripod and extension rod. Twelve sizes from 30" x 40" to 70" x 91" inclusive. From \$12.50 up. Slightly higher on the Pacific coast.

The **DA-LITE PROJECTOR STAND** can be adjusted in height to suit any requirements. It permits projecting pictures above the heads of the audience. With a tilting platform for silent projectors or a non-tilting platform for sound projectors.

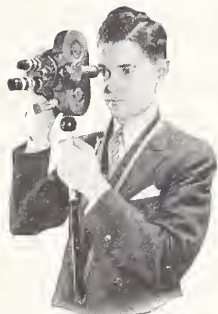

The **DA-LITE UNIPOD** weighs only one pound. Available in two styles: No. 2, which rests against the body as shown here; No. 1, which rests upon the ground and extends to eye level.



1. **DA-LITE UNIPOD CAMERA SUPPORT**
To Keep Movies Free from Wobble
2. **DA-LITE PROJECTOR STAND**
To Simplify Projection
3. **DA-LITE GLASS-BEADED SCREEN**
For Brighter, Clearer Pictures

The Da-Lite Glass-Beaded Screen produces a brighter picture than the ordinary white screen when viewed from any angle up to 45 degrees. At 45 degrees and observation angles greater than this, the Da-Lite Glass-Beaded Screen produces a picture equal in brightness to that of any white screen. Since these extreme viewing angles (45 degrees or greater) cause undue distortion on any screen, they should be avoided wherever possible. That is why Da-Lite, though making White, Silver and Glass-Beaded Screens, recommends the Beaded surface as the *most efficient* and practical for all average projection requirements. Send for literature. See Da-Lite Screens at your dealer's! Ask for a demonstration!

DA-LITE SCREEN COMPANY, INC.
DEPT. 4HM, 2723 N. CRAWFORD AVE. CHICAGO, ILL.

Look for the Name **DA-LITE** When You Buy!
REG. U.S. PAT. OFF.

Announcing

BACKYARD MOVIES

Ideas for Short Films



FADE-O-SCOPE*
CAMERA DISSOLVE
with POLAROID* Lenses.
*T. M. Reg. U. S. Pat. Off.

FADES DISSOLVES

GIVE YOUR PICTURES A PROFESSIONAL TOUCH!

FADE-O-SCOPE is the accessory *sensation of 1940!* Entirely NEW, different patented— it provides the amateur with a highly scientific, yet *extremely easy and simple means* to make true, PROFESSIONAL fades and lap dissolves* without resorting to expensive laboratory technique or the use of cumbersome apparatus.

OPERATES SIMPLY by moving small lever up or down without removing eye from view-finder.

FADES or DISSOLVES with the *identical* smooth, continuous action of professional moving pictures.

GENUINE POLAROID LENSES (high transmission, neutral-density discs of light-control glass) permit uniform intensity control without slightest loss of detail.

FITS ANY CAMERA . . . firmly, *securely*, yet slips on or off in a minute. Performs perfectly on 16 mm. or 8 mm.

SMALL, COMPACT. No large apparatus to carry. Fits into vest pocket as easily as a watch.

ONE OF THE GREATEST AIDS yet devised for the amateur! The accessory long needed to lift amateur pictures into the professional class.

(*Camera must be equipped with back wind.)

FADE-O-SCOPE is furnished in a genuine cowhide carrying case complete with instructions. Each fully guaranteed against defects.

ASK YOUR DEALER TO SHOW YOU DEMONSTRATION FILM

Illustrated Descriptive Folder Sent on Request

FADE-O-SCOPE, Inc.
3 HANSON PLACE, BROOKLYN, N. Y.



"My Dog"

Here is a shooting script for a short home movie of your dog that will be a permanent, living record of your pet to love and cherish long after he is gone:

Main title: (Your name) presents "MY DOG"

(Fade out and into—)

Title:
In sunshine or shadow
In rain or in fog
He always stands by me
I love him — my Dog.

Scene 1: Open with a shot of your doghouse. Cut to—

Scene 2: Closeup of doghouse door. Dog sticks his head out. (If you have no doghouse, substitute a large closeup of your dog.)

Title:
He does tricks
Like chasing sticks.

Scene 3: Long shot of you or some member of your family or friend throwing a stick which the dog retrieves. Repeat two or three times. Cut to—

Scene 4: Closeup as dog proudly returns the stick.

Title:
And it's so grand
When he licks your hand.

Scene 5: Closeup of dog licking the hand of person also in the scene.

Title:
On his hind legs
He sits and begs.

Scene 6: Closeup of dog sitting up and begging.

Title:
Another cute caper
He carries the paper.

Scene 7: Shot of dog with rolled newspaper in mouth. He walks up the street and into the house.

Title:
All through the day
He's ready for play.

Scene 8: Long shot or informal scene of dog at play.

Scene 9: Medium closeup of same action as scene 8.

Title:
When it's time for bed
He always plays dead.

Scene 10: Medium shot of dog playing "dead." If he cannot do this trick, just make him lie down on his

back or side and when he is perfectly still, start your camera.

Title:
Before I go upstairs
He must say his prayers.

Scene 11: Medium shot. Place your dog's front paws on a chair ledge with his head resting on them. Start camera when he is quiet.

Title:
When prayers are said
He's off to bed.

Scene 12: Same as scene 11. Dog finishes prayers, then trots away out of the scene.

Scene 13: Dog enters scene and curls up on his "bed."

Scene 14: Closeup of dog asleep.

Title:
And so—to dreamland we go
That's the end of the show.
—Filmack Laboratories.

Cinderella

When we were children, we used to put a few caterpillars into a box and feed them the necessary greens until they would spin their cocoons, and later emerge as butterflies. Any amateur can make this a very pleasing home movie in the following manner:

Likening the humble, ugly green caterpillar to Cinderella of storybook fame, we see her living among her sisters until one day her fairy Godmother begins to make for her the familiar

• Continued on page 200

• We want suggestions and ideas for random "backyard" filming; also for simple home movie scenarios. Those which are published will bring the contributors either a 100-ft. 16mm or a 50-ft. 8mm film subject selected from the advertisements or cuttings of any library or producer-advertiser in HOME MOVIES magazine.

For ideas that can be adapted to a feature length article we will reward the contributor with two rolls of panchromatic film. Address your suggestions to BACKYARD MOVIES, care of HOME MOVIES, 6060 Sunset Boulevard, Hollywood, Calif.

Nation-Wide Recognition

plus the renowned
Lloyd Bacon Trophy

are the awards awaiting
the lucky winner of

HOME MOVIES

1940 ANNUAL

AMATEUR CONTEST



• Keenly interested in the encouragement of ambitious amateur movie makers, Lloyd Bacon, famed director of Warner Brothers Pictures, believes HOME MOVIES' Annual Contest contributes more to the betterment of serious amateur movie making than any other medium. Lloyd Bacon is sponsor of the magnificent trophy which is to be awarded the 1st Place winner in this year's contest which closes June 30th.

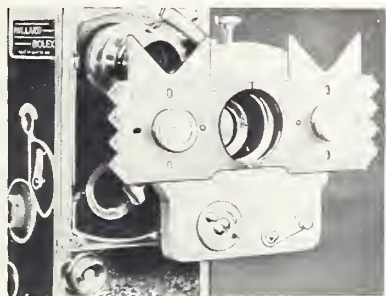

A Prize Worth Shooting For!

BOOL CINE FADER

Fades and dissolves—expertly made and widely varied for novelty—are part of good movie-making technique. The handy BOOL CINE FADER makes all sorts and kinds of fades and dissolves "as you go," and they are timed and operated by the clockwork mechanism. Some lucky amateur cinefilmer will win this prize in HOME MOVIES' 1940 Annual Amateur Contest. Have you submitted your entry yet?

Additional Awards

These are only a few of the major awards; other prizes will be announced later.

- | | |
|--|---|
| <ul style="list-style-type: none"> ● Thal-metal Tripod and Tilt-Pan Head ● Seemann Titler ● Kemp "Commander" Electric Exposure Meter ● Besbee Effectograph | <ul style="list-style-type: none"> ● Besbee Ediscope ● Besbee Titlescope ● Twelve rolls Agfa "Hy-Pan" Film ● Four Star Titler |
|--|---|

RULES

- | | |
|---|--|
| <ul style="list-style-type: none"> ● Entries limited to 16mm and 8mm films. No 35mm reductions eligible. No restriction as to length or subject. Submit as many entries as you wish. ● Transportation on entries must be paid both ways. Where return postage is omitted, film will be returned via express, collect. All entries will be promptly returned after review by judges. ● All entries should be titled at least to the extent of a main title. Professional or laboratory produced titles are permissible. | <ul style="list-style-type: none"> ● Be sure to label your film reels and containers, giving your name and address and the title of your production. ● No entry blanks are necessary. Enclose data with entry as to camera, lens, and film used; also, state whether filters, tripod, exposure meter, and any other equipment was used. This information has no bearing on the judging, but is of interest to the editors. ● Don't wait until final week to submit your films. Send them in as soon as ready. |
|---|--|

HOME MOVIES

H O L L Y W O O D ' S M A G A Z I N E F O R T H E A M A T E U R

For ROCK-STEADY

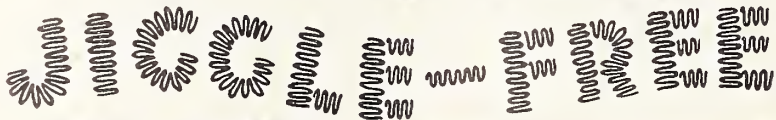

MOVIES USE THE ALBERT ROYAL TRIPOD

All-Metal—Telescoping—
Chrome-Plated Steel

ANOTHER **\$750** TILT
ALBERT VALUE AT TOP
EXTRA

● All metal (tubular chrome plated steel and bar) construction gives utmost rigidity and strength to withstand shocks.

● Quick lock adjustment feature instantly and securely locks legs at any desired length (see arrow); with a quarter turn the leg is free to slide to new position—another twist locks it tight.

● Rubber tipped legs prevent sliding and marring floors and prevent slipping on any smooth surface.

● Combination patented panoraming and tilting top. Will tilt full 180 degs. and panoram 360 degs. You can lock the panoraming feature or tilting feature independently. Precision machined parts make the camera movement smooth. The easy grip handle gives you perfect control at all times. Folds conveniently flat against tripod for easy carrying.

COMPLETE
\$1250

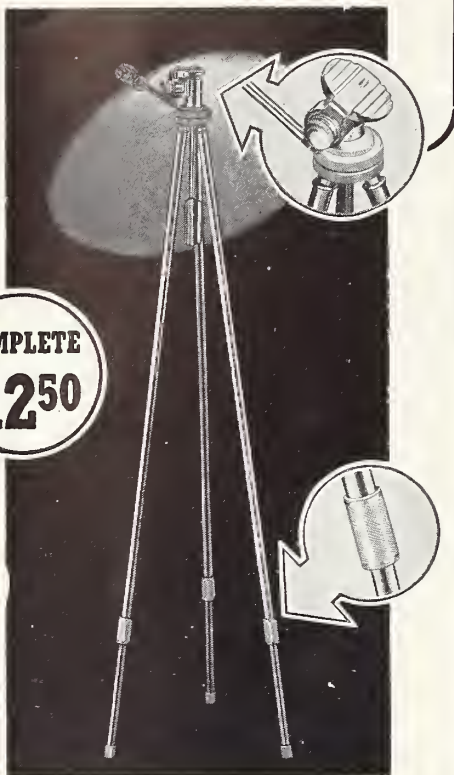

Albert

SPECIALTY CO.

231 S. Green Street Chicago

See it at your dealer's. Write us for Descriptive Circular, Dept. D-6.

Information PLEASE

Splice Life (E. H. Witt, Jamaica, N. Y.)

Is it advisable, from the standpoint of durability, to put a lot of splices in a film which I hope to keep for a good number of years? In other words, will a splice hold as long as the rest of the film, or will it dry up and break within a few years?

Ans. If splices are well made and a good quality of cement used, they will last indefinitely. You see, in splicing safety film, each section of film is virtually welded together. The cement momentarily dissolves the base of the film, causing a "fusing" of the two sections.

Processing Limit (H. N. Roamer, San Diego, Calif.)

Is there any limit as to the time I must have a film processed after shooting? I like to keep my camera loaded at all times so that I'm prepared to shoot pictures on a moment's notice. Naturally, I don't use the entire roll for some time in shooting this way, and it may be two or three months before I'll send it to the laboratory.

Ans. The only limitation on your film is that placed on it by the manufacturer, and that is the expiration date printed on the outside of the box. Just as long as the film is developed or processed on or before that date the results will be o.k., even though you may have taken a year in which to expose the roll. Exposure has no deteriorating effect whatever on either the emulsion or base of black and white film. Color films, on the other hand, are said to require reasonably early processing after exposure.

Trick Effect (James Bowers, Sydney, Australia)

I want to make a shot of calendar pages dropping off one by one but do not seem to get this action as smoothly as I've seen it done in Hollywood movies. Can you

● READERS: This department is for your benefit. Send in your problems and our technical board of professional cameramen will answer your question in these columns. If an answer by mail is desired, enclose addressed stamped envelope.

advise me how to do this?

Ans. One way to secure this effect is to hang a "day by day" looseleaf calendar on the wall. Using bits of scotch tape, attach a piece of thread under each of the calendar pages you wish removed. Start the camera, then, one by one, pull each page off by the thread. Pulling the thread from a slightly different angle will vary the manner in which each page falls from the calendar, imparting a more natural effect. The thread should match the background to prevent detection.

Customs Requirements

(Paul Nosek, Iowa City, Iowa)

I am planning on a trip to Canada this summer and am wondering about the regulations governing my bringing in my camera and film. Would the film have to be processed in Canada? What dope can you give me on this?

Ans. We are in receipt of a letter from the Customs

● Continued on Page 198

Whatsa

DEFINITION

● The photographic term, "Definition," is applied to the sharp, sparkling detail so desirable in our films. This result is obtained only with good lenses. By using an anistigmat of high quality, vertical and horizontal lines are brought to a focus—sharply—at the same time. Details stand out, and marginal definition is well maintained. In inexpensive lenses, definition is improved somewhat by using the smaller openings.

THERE'S A REAL SATISFACTION IN PROJECTING MOVIES THAT LOOK PROFESSIONAL, THAT HAVE THEATRE QUALITY!

This satisfaction is the regular experience of Gevaert Reversal Film movie makers. They know that whatever scene they shoot, Gevaert film will reproduce it faithfully—beautifully—will aid their carefully worked out movie technique. Listed below are the three popular brands of Reversal Film used by amateurs all over the world. They are supplied both in daylight loading and laboratory packing.



LIST PRICES AND SIZES

Price includes processing	Panchro Super Reversal	Panchro Microgran Reversal	Ortho Reversal
16 mm. 100 ft. DAYLIGHT SPOOLS	\$6.00	\$4.50	\$4.50
16 mm. 50 ft. DAYLIGHT SPOOLS	3.25	2.50	2.50
Double 8 mm. 25 ft. DAYLIGHT SPOOLS	2.25	2.00	2.00
Sold without processing			
16 mm. 200 ft. LABORATORY PACKED	6.60	6.00	6.00
Double 8 mm. 100 ft. LABORATORY PACKED	3.60	3.30	3.30



Gevaert Processing Laboratories are located at convenient centers all over the world. Prompt reversal service is thus assured the movie maker everywhere.

THE GEVAERT COMPANY OF AMERICA, INC.

423 WEST 55th STREET, NEW YORK

Boston • Philadelphia • Chicago • Las Angeles • San Francisco • Seattle

Gevaert (Canada) Limited — Toronto • Montreal • Winnipeg

4 STAR ★★☆☆

Home Movie Screens

“For brighter movies Today and years hence!”

What has a 4-Star Screen that other screens haven't got? Well, when you buy a 4-Star Screen you buy a screen only once — a brilliant screen of extra fine crystal beads that improves your projected movies 100%. A special soft felt backing—an exclusive feature of 4-Star Screens—prevents loosening of beads by friction, protects the finely beaded surface when screen is rolled up. 4-Star "Senior" Model Screens are mounted on self-erecting frames in sturdy, lightweight, leatherette covered boxes. Prices are especially attractive:

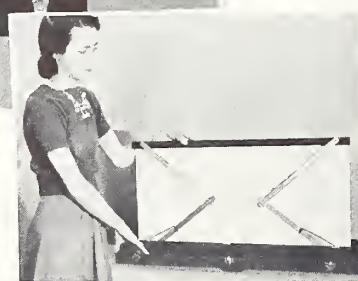
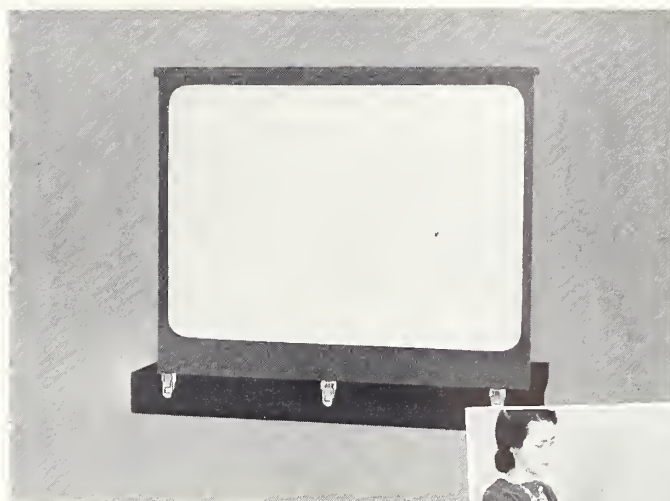

● Senior Models are instantly self-erecting. Exclusive principle insures against wrinkle-damage—holds screen sag-free.

22" x 30"	\$ 9.95
30" x 40"	13.95
36" x 48"	17.95

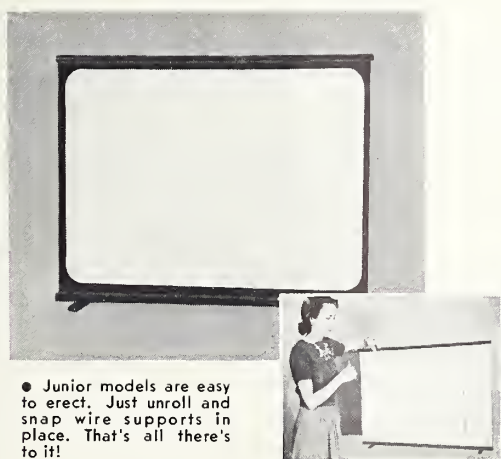

● Junior models are easy to erect. Just unroll and snap wire supports in place. That's all there's to it!

JUNIOR WIRE EASEL MODELS

... have all the special features of the "Senior" models except they are mounted on two battens and are made to stand erect on a table by two wire easels and small wooden legs that fold out of the way when screen is not in use. Probably the only low-priced home movie screen whose features insure a smooth non-sagging surface. Ideal for still-film as well as home movie film projection.

22" x 30"	\$3.95
30" x 40"	5.50
36" x 48"	8.50

See these screens at your dealer's today. If he is unable to supply you at this time, order direct, or send us your dealer's name and address in return for FREE descriptive circular on 4-Star Screens.

HOLLYWOOD CINE PRODUCTS Co.

3221 South Figueroa St.

Los Angeles, Calif.

Five Agfa Films you should know...

For 16 mm. Cameras

FOR EXTREME SPEED:



TRIPLE S SUPERPAN REVERSIBLE. Designed by Agfa Ansco especially for indoor movies and for slow-motion work under light conditions requiring great film speed. It has wide latitude and efficient anti-halo protection. A balanced emulsion provides a pleasing contrast outdoors, prevents harsh effects under artificial light. Available in 100 ft. rolls at \$6.00; in 50 ft. rolls at \$3.25.

FOR OUTDOOR WORK:



HYPAN REVERSIBLE. Particularly suited for daylight use where brilliant contrast and clear, sharp results are necessary. Hypan combines high speed with a full panchromatic sensitivity while excellent projection quality is assured by its fine-grain emulsion and the highly effective Agfa anti-halation coating. Available in 100 ft. rolls at \$6.00; in 50 ft. rolls at \$3.25.

FOR GREATER ECONOMY:



PANCHROMATIC REVERSIBLE. You will find this film an ideal selection for a wide variety of subject material. It's fast and sensitive to all colors. In addition, it possesses a carefully balanced gradation that produces a highly satisfying screen brilliance on projection. The low price makes it an exceptional value. Available in 100 ft. rolls at \$4.50; in 50 ft. rolls at \$2.75.

LOW-COST OUTDOOR FILM:



FINE-GRAIN PLENACHROME REVERSIBLE. This film has ample speed, pleasingly brilliant contrast and orthochromatic color sensitivity—providing you with an exceptionally fine outdoor medium at a moderate price. It's extremely fine-grained and possesses wide latitude to minimize exposure errors. Plenachrome is available in 100 ft. rolls at \$4.50; in 50 ft. rolls at \$2.75.

For Double-8 mm. Cameras

FOR EVERY PURPOSE:

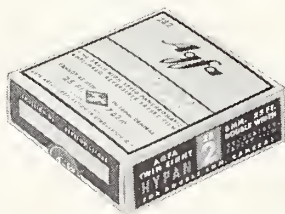

"TWIN EIGHT" HYPAN REVERSIBLE. This new, double-width 8 mm. film gives you finer results with double-8 cameras—having exceptional speed that makes it ideal for indoor as well as outdoor scenes. Its panchromatic emulsion is unusually fine-grained and supplies the high resolving power necessary for the best screen results. "Twin-Eight" Hypan is available in 25 ft. rolls at \$2.25.

AGFA ANSCO, BINGHAMTON, N. Y. MADE IN U. S. A.



HOME MOVIES

... Published in Hollywood

APRIL

1940

Authored by
GEO. W. CUSHMAN

PRACTICE perfects home reversal results...!

THE first time you sat down to a piano you didn't play Paderewski's Minuet, yet the music was before you. Nor did you paint a decent landscape when you first took paints and brush in hand. Yet the first time you try home reversing you expect professional results!

The average amateur trying home reversal blames the developer he is using, or the film, or some other cause. He seldom wants to believe the trouble is with himself. Usually, however, that is exactly the trouble. Good formulas and equipment are now available for everyone; so if the results are not satisfactory, only the technique is at fault.

What I am about to say is not to be taken as the last word in home reversal methods. Merely because I say I do not prefer light flashing to constant light does not mean that light flashing will not give good results, nor that it is bad practice. Rather, I'm going to give you, as best I can, my experiences and observations gained from home reversal of positive film during the past six years. My methods may or may not be good technique, but I do say that they give me highly pleasing results. And since I have nothing to hide, I give them to anyone who may be interested.

First of all, I want to blow up the developer theory. Most workers sooner or later blame the developing formula for their troubles and seek another. If this gives no better results, they try another, and so on. You may be interested in knowing that in the past six years I have used only two formulas—and I can't see any difference in either. Consequently I went back to the original formula I started using, and am using it today. I'll give it to you presently.

The first time I used this formula I had miserable results. Since the formula had been printed in various magazines, I knew that it must be a good one and that the trouble must be with me. I kept using the same formula, watching my results carefully, and finally learned the little things that go towards making a better finished result.

This, then, is my first bit of advice to those who are not getting good results with home processing: Get a good developer and stick to it. Watch

your results carefully, and profit by your own mistakes.

The developer formula I use is as follows:

Water (about 125°), 40 oz.; elon, 200 gr.; sodium sulphite (Des.), 3½ oz.; hydroquinone, 62 gr.; potassium bromide, 85 gr.; cold water to make, 64 oz.

THIS is known as the old Arlin formula and can be well recommended as highly satisfactory. The stock solution keeps well. For use, take 16 ounces of developer and 16 ounces of water and, just before immersing the film, add 128 minims of stronger ammonia. (This is 4 minims per ounce of prepared solution.) At 65 degrees the developing is complete in 4 minutes.

Since the entire process of home reversal from exposure to projection has so many variables, I believe it best to reduce as many of these variables to constants as possible. Such variables would in-

• Continued on page 190

• "I believe that, for best results, the developing drum must be solid . . ."

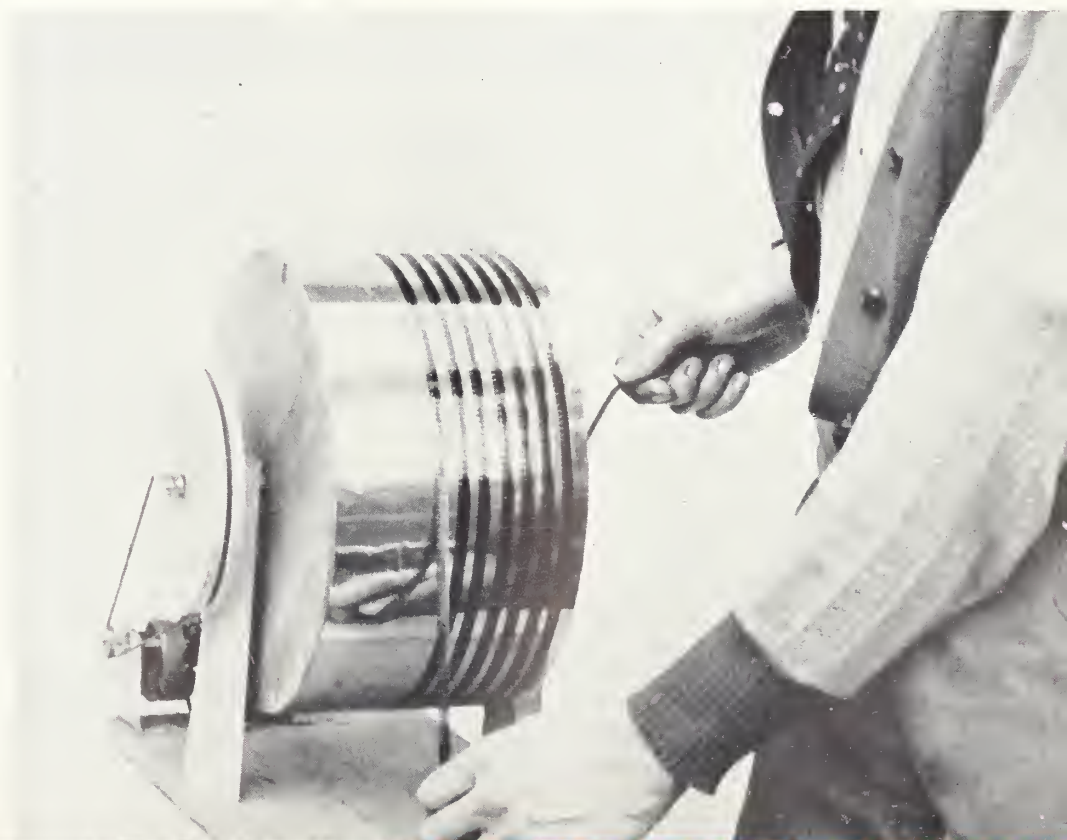

Authored by
RALPH S. WILSHIN
National Screen Service



Fig. 1

sitions by the producers of the "trailers" which advertise coming attractions in theaters. The wipe-off is quicker and more spectacular than such conventional transitions as fades, dissolves, etc., and they play an important part in enabling the trailer to put across its message forcibly and interestingly in the two brief minutes it appears on the screen.

Most of the transitions we use in making trailers are made in an optical printer because the commercial production of trailers requires the speed, accuracy, and flexibility of the optical printer. Nevertheless, some mighty fine cinematic effects are being accomplished every day by

"Pro's" EFFECT TRICKS no longer secret . . . !

IT IS only natural that most amateur movie makers should be keenly interested in the methods employed by professionals in attaining certain effects in their filming and title making, such as zooming, making wipe-offs, etc. Their continued requests to the editors of HOME MOVIES for more articles illustrating and describing the professional's methods should not go unheeded, as, indeed, they won't.

Certainly, most amateurs appreciate how extensively some of Hollywood's most effective cinematic devices must necessarily be kept "under wraps." Yet many of the best professional effects are being imitated, if not duplicated, by many amateurs.

Most of us are familiar with the extensive use made of the wipe-off and similar cinematic tran-

amateurs—some with home-made optical printers and some by various other methods.

Most optical printers are mounted for rigidity on a lathe-bed, on one end of which is, to all practical purposes, a lensless projector-head; and instead of the usual condensers between lamp and film, ground or opal glass diffusers are used.

At the other end, facing the projector-head, is a standard camera, usually a Bell & Howell. These two mechanisms are mechanically interlocked, so that their two films move together. In use, the camera re-photographs the positive film passing through the projector-head, making a duplicate negative. To make "wipes," a third film, upon which is photographed the desired matte or mask, is run through the projector-head in contact with the positive being duped.

THESE mattes are always made in pairs, one for each of the two scenes being joined by the wipe so that each is matted off correctly. In making a simple wipe, for instance, in which one scene appears at the left of the screen and, moving toward the right, wipes off the other, the first scene would be printed through a matte which

• Continued on Page 193

• Fig. 1—Filming title for a movie "trailer" on a vertical titler. Fig. 2—Operating the "flap-over" device. The title board is flipped over while the camera is in action, bringing another title card into view on the opposite side. Fig. 3—Projection head of the optical printer, the device on which most of the professional's tricks are made.

Fig. 2



Fig. 3



CLOUD STUDY

The right filter plus "low key" exposure made this an outstanding picture. It's a good pattern for your next "cloud" movie—also a swell background for the title.

Photo by

C. S. Martz, A.R.P.S.

(Right)





C. E. Bell Photos

SPOTLIGHTS *light the way for better filming . . .*

Authored by
CURTIS RANDALL

IF YOU ask a studio cinematographer which piece of lighting equipment is the most important in his work, he will unhesitatingly reply, "the spotlight." If you happen to be one of the rare few lucky outsiders privileged to visit a studio set, you'll notice that seldom are more than two or three lamps of the "broadside" or floodlighting type used in lighting the average scene, while on the same set there may be several dozen spotlights of various sizes, ranging from the huge, 5,000-Watt units down to the tiny 150-Watt "peanut spots". Ninety per cent of the lighting in that movie you saw last night was done by spotlights.

There's a reason for this. The floodlighting unit is not controllable. It spreads a smooth, even flood of light across an angle of about 60° — and that's that. You can't do much about controlling either the spread or the intensity of its beam — and after you've done what little you can, you still have a flat, featureless flood of illumination.

The spotlight, on the other hand, is versatile. You can spread its beam out till it's almost as wide and soft as that of a floodlight. And you can concentrate the same lamp's beam down to an intense, 4° spot. It puts the light exactly where you want it, and with exactly the intensity and quality you want.

This universal use of spotlights in the studios has grown directly in step with successive increases in film speed. With each boost in film-speed, the cameraman found he required less light for exposure. And as he used less light, he learned he had to put that light more precisely where he wanted it. The answer was — spotlights.

The same thing is now happening in the home movie field. Today we have reversal films as fast as the best high-speed negative used in the studios; some, in fact, are even faster. Our lenses are faster. Our average exposures are longer — 1/30 second as compared to the studio's 1/51 second. We can make good movies with less light than the

professional needs — but we've got to make every bit of that light count.

That means we'll find spotlights invaluable. And since several manufacturers are now offering spotlights at a price that doesn't put too bad a crimp in the amateur cinefilmer's bankroll, suppose we give this angle of cinematography a little study from the amateur's angle. Let's see how the "pro" uses his spotlights. Maybe we can pick up a few hints.

In lighting people, one of the most important uses of the spotlight is to provide what the professional calls the "key lighting" — the principal light falling on a player. For this, a spotlight, often fitted with silk or tracing-cloth diffusers, is generally used. The actual placement of the key lighting unit depends, of course, upon the action being filmed, and upon the photographic requirements of the player being photographed. The faces of some stars, for instance, look best with a very soft key light; others, like Marlene Dietrich, to cite an outstanding example, look best with a fairly sharp key light directed down onto the face from a fairly high position above and directly in front of the face.

The modern super-small "peanut spotlights" are also valuable in giving special lighting to faces in close shots. These lamps are so small and light they can be mounted directly on top of the camera, or on top of the sunshade-matte-box over the lens. There they can be directed squarely into the face, putting the light just where it is needed. Used this way, with a diffuser or so, they can do wonders in ironing out wrinkles and filling in eye-circles, or relieving shadows under extremely deep-set eyes.

THIS trick can easily be used with home-movie cameras, for while there's no provision for mounting the light directly on the average 16mm or 8mm camera, it's no trick at all to make a C-shaped bracket of strap-iron, one end of which

• Continued on page 188

• Photos at top of page illustrate versatility of spotlights for backlighting, modeling and highlighting. Increased interest in spotlights by amateurs has resulted in many new, low priced units being placed on the market.

(Right)

"THE BRAT"

is the title of Jane Withers' next picture. We selected this photo of her as an example of excellent lighting technique. Note modeling effect achieved with spotlights.

Photo Courtesy

20th Century-Fox



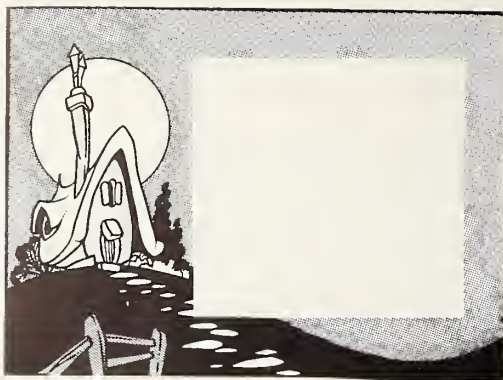

"We're going for a walk in the park; want to come along . . .?"

"Oh! Look what I found!"

"Why, it's a Fairy's magic wand . . .!"

"You must say some magic word as you wave it, like 'Abracadabra' . . ."

"Abracadabra!"

"O-o-oh! I must go and tell Daddy . . .!"

"Oh, why did I ever find this old wand . . .!"

"Mother and sister have disappeared! Come and help me find them . . .!"

"How did it happen . . .?"

"I just waved this wand and they disappeared!"

"—and I said 'Abracadabra' when I waved it . . .!"

"See, Honey; I'm a magician, too . . .!"

"So, you're a magician, too . . .!"

"What is the matter?"

"I guess I must have been dreaming . . ."

The End



Home Movies

MAGAZINE



**Subscription
Order Form**



Authored by
WALTER BERGMAN

WALTER BERGMAN, member of the Mount Vernon Movie Makers of Mount Vernon, New York, has submitted a delightful scenario which we like so we'll, we have decided to publish it together with all the necessary title cards printed and ready to shoot! HOME MOVIES has brought you pages of printed title backgrounds every month, so that it is hardly necessary for us to tell you how to use the title cards which appear on the opposite page. As for the scenario, we'll let Walter Bergman tell you about it.—*Editor.*

LAST summer, after buying a new movie camera, we decided to produce a family movie in which we could all take part. As we have two young daughters, aged 4 and 8, it had to be a simple story, light and entertaining, yet sufficient to allow us to display our histrionic abilities and run through the gamut of emotions from "A" to at least "B."

It was our desire to have the characters register joy, love, laughter, fear and sorrow. How could we make a picture in which the characters could show fear and sorrow without any gang-

For example, in scene 24, where "Mary" disappears, her vanishing is accomplished by "freezing" the other actors in the midst of their action (that is, making them stand perfectly still at a given signal), then stopping the camera momentarily and removing "Mary" from the scene, after



C. E. Bell

The **MAGIC WAND**—*script, titles and all . . . !*

A family movie scenario in which all may take a part—complete with necessary title cards . . . !

which the regular action is resumed. It is important that nothing else be moving in the scene.

MY cine camera does not have a windback feature, but I made satisfactorily dissolves, nevertheless, by gradually closing the lens diaphragm at the end of a scene to make a fadeout. Then, in a dark closet, I opened my camera and wound back about six inches of film. I shot the next scene, beginning with a fadein, by gradually opening the lens to the required stop. My wipe-offs were made with a little home-made gadget similar to that suggested by Harold Grundy in the January issue of HOME MOVIES. It took us three afternoons to shoot the scenes. Here is the complete shooting script, which requires about 200 feet of film (16mm), including titles:

● The title cards on opposite page are necessarily small to accommodate all typewriter titlers. Where larger cards are necessary to fit titler card frame, paste titles over black or patterned cards cut to required size. The unlettered title card is for your credit titles—Cast of Characters, "Photographed by," etc.

sters, war, injuries, deaths or a couple of murders? Well, after seeing "Topper Takes a Trip," the seed of the idea for our picture was sown.

We decided to have the central theme of the picture revolve around the finding of a fairy wand, which, when waved and a magic word spoken, would cause people to disappear and reappear. The story of "The Magic Wand" was the result. The cinematic tricks necessary to filming this story are extremely effective, yet so simple that the veriest beginner can do them with consummate ease.

● Continued on page 186

Authored by
 RAY E. MERVILLE
 Illustrations by Author

Here's the 1940 "DREAM" CAMERA...!

THE development of any engineering activity is usually characterized by improvements over previous models. Application to an idea generally increases efficiency, refinement, and precision.

Amateur cinemechanics have done very well considering the fact that they have had little or no cooperative help. Each has worked independently.

Recently your roving reporter dis-

covered a camera which had gone through an amateur mechanic's shop and come out with its original case and lens, but with many of its factory made parts removed and, replaced with other unproved features. This was a standard Model #60 Eastman camera, but now known as an "O'Dogherty Special."

No doubt many have been waiting for inside information since the first article regarding the "Dream" Camera

appeared in HOME MOVIES magazine. Many have had their cameras remodeled and have had the pleasure of making special effects and duplicating the tricks of the professional screen.

The 8 m/m Cinemechanics are now invited to gather around these pages while a Model 60 Eastman camera is X-rayed, dissected, remodeled and re-assembled.

Photographs No. 1 and 2 show the camera after the remodeling operation. The camera is now electric motor driven direct thru gears, since the spring motor has been removed. The motor used is very efficient; is universal, economical and reversible. It's a 12 Volt A. C. - D. C. motor purchased from a Model shop and was designed for use in a "O" gauge railroad engine. These little power plants develop more horse power than is necessary to run a movie camera efficiently and they draw only 1½ amperes, and cost between \$4.00 and \$6.00.

Since the motor can be operated on both direct and alternating current, it can be supplied by electricity from dry batteries for field use and by electricity from the regular 110 Volt house current, either A. C. or D. C. where this is available. More about the motor adaptation later.

THE camera must be steadied against the whip or torque of the motor therefore a substantial base was constructed. This is shown in photograph No. 3. Duralumin was used for the base as it is light and strong and very easy to work. Aluminum is not recommended. The base is 1/2" thick and the sides pieces are 3/16". If a narrow ledge is milled off of the base it will allow the

• Lives there a cinebug who has not dreamed of "happing up" or streamlining his camera with gadgets sorely needed for serious filming, yet omitted by camera manufacturers? These detailed sketches show construction of and methods for altering an 8mm Cine Kodak.

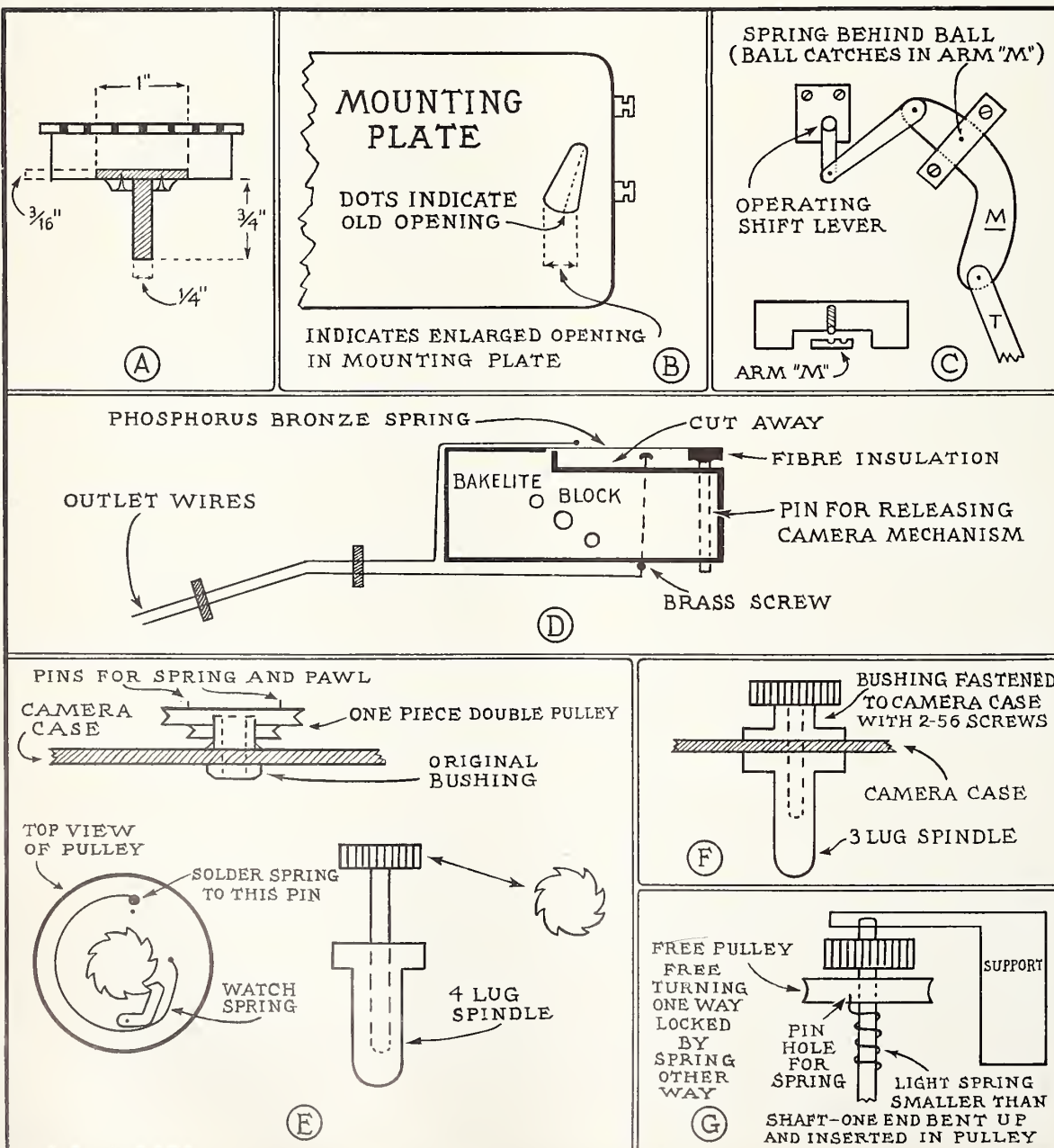

camera door to be removed easily. The sides are doweled to the base and clamp by thumb screws. The camera is held very steadily on this base, and the base serves for attaching other gadgets and was engineered for the first "Dream" camera.

Photograph No. 4 shows the inside of the camera with which you are all familiar, but we are concerned more with the other side of the mounting plate which is shown in photograph No. 5.

IT IS not difficult to remove the mounting plate. Remove the pin from the winding key by driving it out. Remove the four screws from the corners of the case, and also remove the lens. Turn the camera over and the mounting plate will drop down at the rear of the camera. Don't pry on the plate but shake the camera gently and the whole mechanism will come out. When the rear of the plate drops down the front will just naturally back out of the case. It might appear that the two pins which hold the lens will interfere with the plate coming out, but they do not. When you have the mounting plate out and before you, study it carefully so that you know what each part of the mechanism actually does in the operation of the camera, as this will help you in the future in designing an idea which we may have the pleasure of seeing in the pages of this magazine. Using photographs No. 5 and 6, you can now start dismantling the assembly. Strip the mounting plate of all parts with the exception of the governor assembly and the shutter.

Before the first mechanical additions can be made it is necessary to remove the spring. To accomplish this, the spring case should be held in the hand and the spring shaft struck sharply with a hammer which will pop off the spring case cover. Now remove the spring and shaft, being careful in handling the spring as it is alive. A new shaft should now be made with a flange which is fastened inside the spring case with flat headed screws, making use of the three rivet holes which previously held the spacer to the spring case. See sketch "A". The cover to the spring case should be replaced.

Since the motor is reversible and the film can be wound back, several changes in the camera construction are necessary to arrange for winding the film onto the supply spool instead of the take up spool. Also, it is necessary to disengage the claw from the film during the winding-back process. First it is necessary to remove lever "T" shown in photograph No. 6. This is done by driving out the rivet which attaches it to the other mechanism. The slot for the claw must

• These photos of the 1940 "Dream Camera" show the important changes wrought by the skillful hands of its owner, Bill O'Dagherty, and explained in the accompanying article by Ray Merville.

now be enlarged so that the claw arm will clear the film when shifted. This is done by filing. Sketch "B" shows how much metal should be removed, indicating before and after.

Making the shifting mechanism requires a certain amount of mechanical ability and attention to details in order that it will work properly when completed and installed. The unit should be built, completely installed, and tested and adjusted 'til the claw just clears the film when in off position and pulls the film down properly when the claw is engaged, and the film is moving forward. Sketch "C" tells the story. Photographs No. 5 and 6 shows the parts installed.

To make the two film spool spindles reversible, first both spindles should be removed. The lower, or take up spindle, will require a double groove pulley with a ratchet and watch spring. These can be purchased anywhere. See sketch "E". The ratchet and spindle should be fastened as one piece. The watch spring is used to return the pawl. A thin cover holds the spring and pawl from coming off the pins in the pulley. The diameter of the pulleys should be about one inch and 13/16" to the bottom of the groove.

THE upper or supply spindle can best be driven by a gear. Because of the footage meter there is not sufficient space for a ratchet and pawl. The two gears being the same size it matters not what size is used, but this will be governed by the space available. If you have to buy the gears we recommend 3/8". Sketch "F" shows clearly how the spindle and gear are assembled. The driving gear with its spring clutch is very much like the idea used on the governor gear assembly in the camera. See Sketch "G" and photograph 6. The pulley used in connection with the gear should be as large as can be accommodated in this assembly, approximately 5/8".

Looking at the outside of the camera in photograph No. 2 the claw shift knob is clearly shown in the upper left hand corner of the camera.

Next month the motor assembly, the single frame shaft installation to which the motor is attached, and the frame counter will be described in words, photographs and sketches. Letters regarding the modernization of the "Dream" camera by William O'Dogherty will be answered thru these columns, for the benefit of all, as they are received.

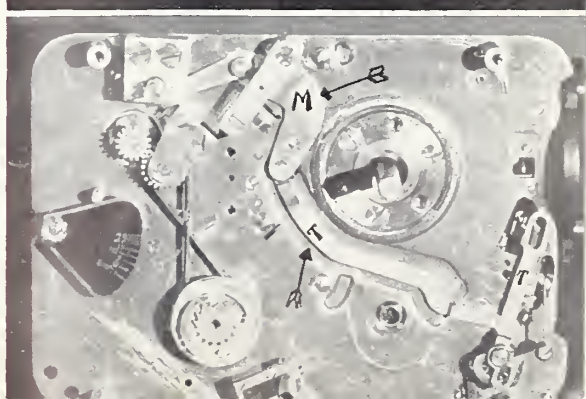
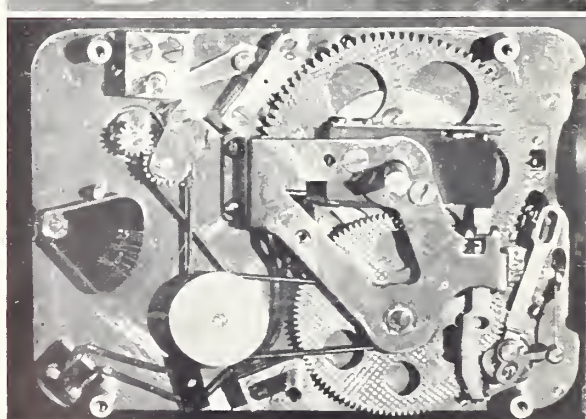
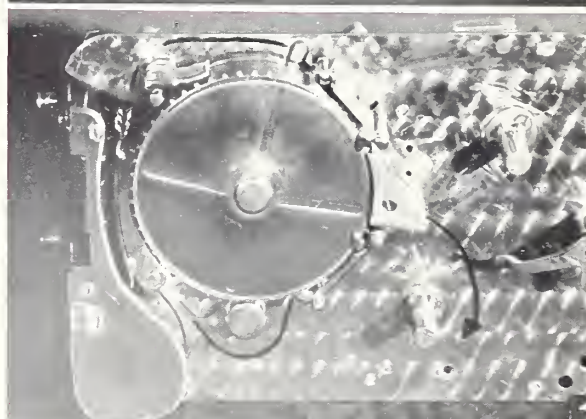
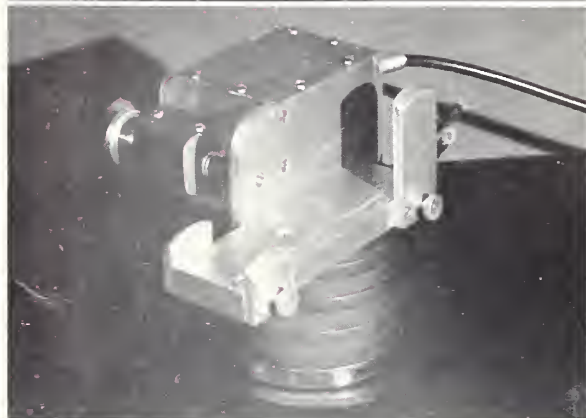
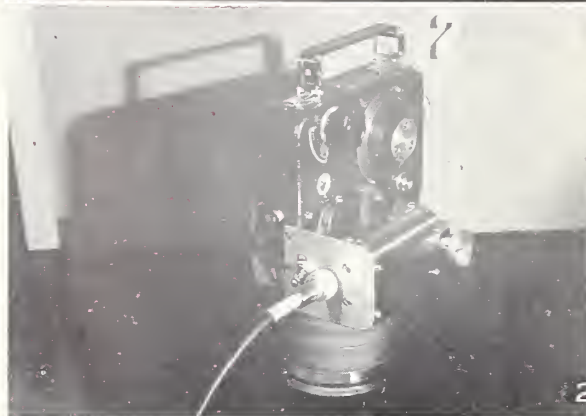

Authored by
RAY FERNSTROM

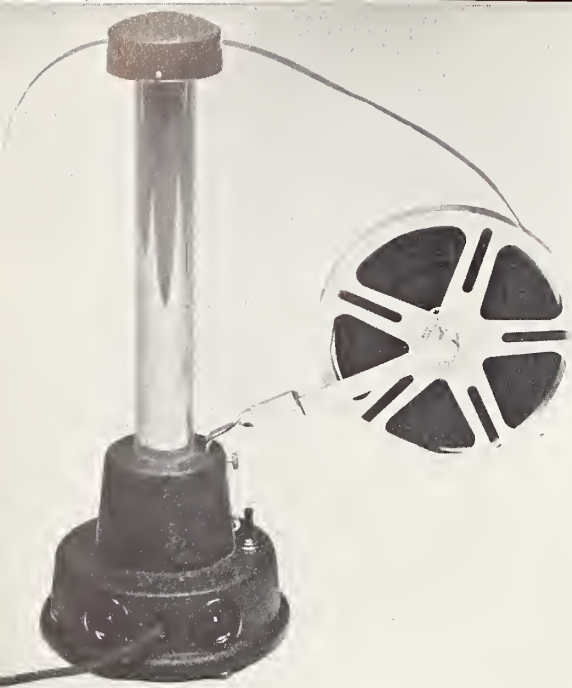

This new device SPEAKS YOUR TITLES

THE newest thing in sound for home movies is a voice that automatically speaks titles at precisely the right time as the scenes appear on the screen. The title is pre-recorded on acetate records by the amateur. The record — instead of turning continuously during projection — plays only at intervals, speaking the necessary lines of the title, and then stops until the next title is spoken.

This sound innovation is the "Voca-Titler," a development of the American Bolex Company. The greatest single interest in home movies at this time is the adding of sound to amateur films in the simplest and least expensive manner. Amateurs who have dabbled consistently with sound during the past year or more have made many discoveries

• Top — The Voca-Titler unit which controls the turntable that operates the title-speaking record. Below — After titles have been composed and edited, they are recorded on an acetate disc. This recording unit is a radio, phonograph, and recorder — all in one.



—have achieved some interesting results in wedding sound to home movies. Yet here is an idea so practical one wonders why some amateur cinebug did not think of it long ago.

Pictured at the top of this page is the Voca-Titler unit — the robot device that controls the operation of the record turntable as the film passes through the projector. It is placed in back of the projector and the reel of film to be projected is placed on the feed spindle of the Voca-Titler instead of the top spindle of the projector. The film is threaded through the top of the Voca-Titler and then through the projector. The film, however, has been prepared with tiny notches at intervals along one edge, as will be described later, and these notches serve to actuate the Voca-Titler, causing it to start the recorder each time a title is to be spoken.

The Voca-Titler is wired to the recording turntable. It may also be used in conjunction with any radio-phonograph or commercial or home-made turntable with slight changing in wiring between the two units. But the makers have brought out a compact radio, recorder, and phonograph to be used in conjunction with the Voca-Titler which enables the amateur to make his own records and then play them on the same instrument. The turntable operates at the standard speed of 78 R. P. M. and the cutting head cuts 109 lines to the inch.

Recording and timing of the record with an 8mm or 16mm film is very simple. After the necessary script is written, the film is threaded into the projector. The operator, by talking through the hand microphone, may record the title as the film is shown or, if desired, the length of the sequences may be measured and the script carefully edited and then recorded on the disc. Between each title there is allowed an interim of seven seconds which provides necessary time required to stop the turntable and start it again.

AFTER the title script has been cut on the record, a small notch—which does not interfere in any way with the film sprocket holes—is cut on the edge of the film fifteen inches in back of the frame where it is desired that the title should be spoken. These small notches accentuate the switches in the Voca-Titler which start the turntable. Due to the fact the amplifier is always on, the sound starts instantly without lag or distortion; and when the title is finished, a warning light flashes on the base of the Voca-Titler as a signal for the operator to press the button that stops the turntable, until it is again started by

• Continued on page 196

Authored by
E. M. LIEBSCHER
Optical Engineer



Field



Steinmetz

Here's tip for filming trick "GHOST" SHOTS

TRICK cine shots, involving the appearance and disappearance of objects or persons within a scene, have always intrigued movie audiences. Amateur cineclickers have been intrigued, too, and speculation continues to ensue as to just how these tricks are accomplished.

The fundamentals governing the making of many of these trick shots are comparatively simple, yet should be carefully studied and followed for complete success. Such popular theatrical movies as "Topper Takes a Trip" and "The Invisible Man" presented many illusion and trick effects which may easily be duplicated by the average amateur by a method involving the mirror-like reflections from a plain, transparent panel of glass.

We are all familiar with images as reflected in shop windows under certain light conditions. Often these reflections are so pronounced, it is difficult to see the merchandise on display behind the glass. Because of the manner in which the light strikes the surrounding objects, the shop window becomes something of a mirror. The intensity of the reflection is dependent upon the critical angle of reflection. The closer angle of the glass approaches 45 degrees in relation to the objects reflected, the more it becomes a mirror.

This "nuisance" effect caused by surface reflection is often detrimental to shopkeepers and photographers alike; but in this instance it becomes the medium by which we may produce some striking trick effects in our home movies. Of course, we're not going to use a shopkeeper's window, but a panel of glass under similar light conditions.

A flat panel of glass does not alter the focus of the camera lens, regardless of the conditions or the angle at which it stands in relation to the object photographed. But, in shooting trick effects through glass you must remember to measure the

full distance between camera and the *reflected* object—the total distance from lens to glass to object—and not from lens to glass window alone. (See Fig. 1.)

Fig. 1 shows a typical set-up for shooting a trick effect with the aid of a glass panel for reflecting the image of an object temporarily into the scene. The glass panel need be no larger than is necessary to reflect the portion of the object or person that is to appear, "ghost-like," in the scene. It may be a small window pane or a panel three feet by six feet or larger, according to the requirements of your trick effect. The usual method for mounting the glass is to drill holes at the top of the panel and suspend it from wires. Smaller panels may be set into a wooden easel that grips the glass firmly at the bottom edge of the panel.

IT IS important that the glass be securely mounted in order to prevent unnecessary movement of it during shooting—unless, of course, the effect requires moving the panel. The edges of the glass should be coated with dull black paint so that they will not reflect stray light and thereby cause a tell-tale definition line to appear in the scene.

Also, under certain conditions, a slight "fringe" or fuzzy effect will appear around the reflected "ghost" due to the double reflection of both surfaces of the glass. But this rather enhances the effect.

With this set-up, as illustrated in Fig. 1, it is intended to produce a trick shot wherein a man, seated

• Continued on page 195

• Above photos are 1st and 2nd prize winners in recent "Ray-Del" photo contest conducted by Raygram Corp. of New York. 1st prize, "Cyclist," by Nathaniel Field—2nd prize, "Balancer," by J. J. Steinmetz. Photos suggest trick shots that may be filmed with a cine camera. The trick cyclist may be photographed first moving across a plank edged with thick rope; then the background filmed by double exposure. The egg balancing may be faked by use of empty egg shells strung on a black thread. Sketch below illustrates plan for making trick shots described in accompanying article.

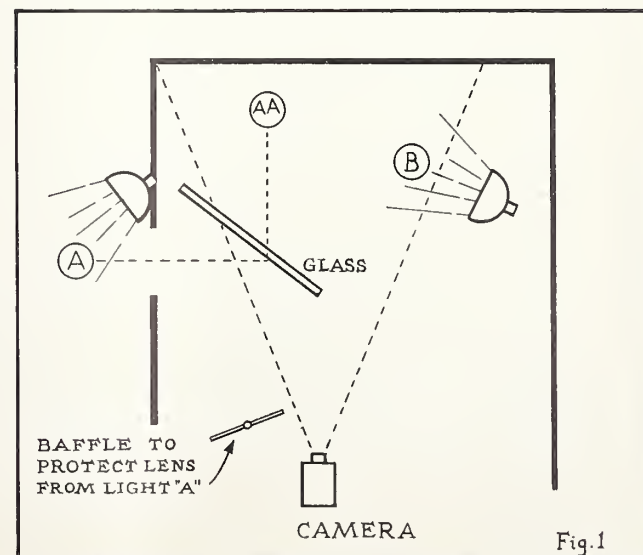

Fig. 1



Wide World

“FINLAND FIGHTS” *filmed at 40 below zero!*

Authored by
JACK IRWIN

THAT there is any kind of a motion picture record of the recently terminated Russo-Finnish war is something of a miracle in itself. Ordinarily, motion picture camera mechanisms “go on strike” when subjected to freezing weather, and even the newsreel cameramen themselves find it difficult to work up any kind of enthusiasm for picture making under zero or sub-zero conditions.

Nevertheless, movies were made at the Finnish front and most of the shots were filmed while temperatures hovered between 40 and 50 degrees below zero! Veteran cameramen are still shaking their heads in bewilderment and almost unbelief that motion picture equipment could be made to function under such weather conditions.

From the most spectacular of the shots made of this war, Castle Films through exclusive arrangements with the newsreel companies, whose daring cameramen obtained the pictures, have compiled “Finland Fights”, probably the most talked-of home movie film ever to be made available in both 8mm and 16mm widths for home movie fans, educational institutions and film libraries.

As in the case of other “headline” world events, this alert producer once more makes available, to the thousands who are building substantial personal home movie libraries, a picture of their own that covers the most important phases of a subject that will continue to be front page news long after the peace treaty announcement will be forgotten. This latest addition to chronicles of world-rocking incidents is finding nation-wide demand among movie fans who are collecting and maintaining a complete home movie war chronology from the formation of the Rome-Berlin axis, the Munich Pact, and on through succeeding invasions of Austria, Czechoslovakia, Poland and more recently — Finland.

To witness a screening of “Finland Fights” is to see a direct and hence highly dramatic presentation of facts involved in the Finnish struggle against tremendous odds. The commentary of the

film in both the silent and sound versions matches the sequences of scenes in leading the spectator simply but stirringly from the troubled days of hopeless negotiations late last November, right up to the most recent defense action on the Mannerheim line.

RUSSIA’S first swift stroke in the wake of her ultimatum is shown as Red bombers drop destruction upon Helsinki. The scurrying of innocents in this capital city to hastily-constructed shelters while bombs still fall around them and while buildings burn on all sides is shown in factual detail. Women and children, their faces drawn

• Continued on page 194

• Castle Films’ “Finland Fights” gives one a closer understanding of the strategy so successfully employed by Field Marshal Mannerheim. The filming of most of the scenes was successfully accomplished under weather conditions heretofore believed impertical for movie camera operation.

Wide World



FOR a long time we wished that some amateur would film a "hoss opera"—one of those rootin', tootin' good old western movies with hard-riding cowboys, a villain, and all the cinematic trimmings that make "westerns" top movie fare in theaters the country over. Well, at last our wish has come true!

After a hectic eight months of preparation, production, editing and titling, Demetris Emanuel of Los Angeles has come through with "El Lobo"—as fine an amateur movie as one could wish to see, and which the editors of HOME MOVIES have accorded the honor of the "Movie of the Month."

Construction of interior sets single-handed within his garage and traveling thirty-five miles into the interior of heavily wooded mountains in order to film a single scene, are just some of the trying experiences encountered by Emanuel in producing his picture. That he has given more than ordinary study to the techniques of script writing, acting, directing, makeup, set construction, and the selection of locations is fully apparent. Notable, too, is the judicious use of sunlight reflectors on all exterior scenes. And as for the lighting of interiors, this, too, was excellently done.

A flawless picture? Well, hardly. But any shortcomings are far outweighed by its general overall superiority. There is, for instance, a slight discrepancy in a backdrop employed behind a window and door of the interior of the cabin set—a backdrop skillfully painted to give the illusion that the cabin is situated on a prairie. But the exterior shots reveal the cabin nestled among a grove of trees in the midst of rolling hills. The interiors, you see, were filmed in advance of the exteriors; and when the time arrived for shooting the exterior scenes, it was found more expedient to use a nearby mountain locale in place of the more distant desert. But the action is so dramatic that, unless you purposely looked for little flaws like this, they pass unnoticed.

"El Lobo" is a Mexican bandit on whose head the sheriff has set a price of \$5,000, dead or alive. According to an explanatory foreword, during one of El Lobo's early forays of banditry, he found a young girl whom he took into his home and raised to womanhood. In the meantime, El Lobo is away a great deal, due to the vigilance of the gendarmerie, and the girl having grown, leaves to shift for herself. Unknown to El Lobo, she eventually marries a young rancher and settles with him on his small ranch.

IT IS toward this ranch in quest of the girl—whom he has come to love deeply—that we find El Lobo traveling with his partner when the picture opens. The costuming of El Lobo and his partner in the attire of early-day Mexican riders is a fine piece of work and deserving of especial credit in that it is one of the many examples of the great length and expense which Emanuel went to in order to insure the utmost realism in his picture.

There are some excellent action shots of El Lobo

• Continued on page 192

MOVIE of the MONTH

Reported by
J. H. SCHOEN

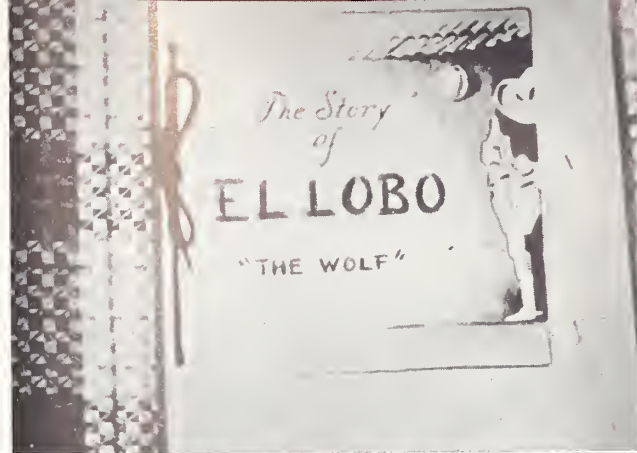

• These scenes — reproductions from "El Lobo" — indicate the thoroughness with which this fine amateur film was produced. Story, photography, acting, costuming, and direction are unusually good.



Authored by
F. C. MOULTRIE



chemical toners, on the other hand, are easily obtainable anywhere.

First it is necessary to review your films and to make a list of the shots which you think may be improved with tinting or toning. Let us take, for example, an imaginary shot of a swan on a scenic stretch of water, appropriately framed with branches of a weeping willow silhouetted in the foreground. It is not difficult to imagine the pleasing effect that would be imparted to such a scene, were it toned a gentle, indigo-blue. The swan and

If it's **COLOR YOU WANT**, try toning . . . !

AFTER witnessing the screening of a beautiful Kodachrome film taken, perhaps, by some friend, those of us of more or less limited budgets may go home somewhat disappointed with our black and white filming efforts.

But if you are the kind of a filmer who is willing to tuck up shirt sleeves and do some really interesting cinematic work, and are not content to leave your films just as they were received from the processors, it is possible to work some marvelous transformations with ordinary black and white films. You may even like the results equally as well as Kodachrome!

Such improvement consists in tinting or toning your films—or both. The tinting process affects the base of the film, whereas the toning process affects only the emulsion. Thus, by resorting to both processes, it is possible for you to impart a dual coloring to your films. The base can be tinted yellow or amber and the image on the emulsion can be toned blue, green, red, etc. The effect of the two colors on the screen is startling.

The three colors I found easiest to manipulate are chemical toners: blue, green and copper-sepia. Dye-toning is satisfactory, but difficulty is often experienced in securing the correct basic dyes. The

all of the highlights would remain white. The willows would remain essentially dark, and the grays and intermediate tones, such as the shading of the swan and the ripples in the water, would be replaced by delicate shadings of blue.

To tone or tint cine film, equipment similar to that required for developing or reversing—a rack or developing drum and two or more trays—is necessary; although they need not be so elaborate as those required for processing. Also, the tinting or toning may be carried on in full light. No dark-room is necessary.

IN FOLLOWING the toning process, it is important that all of the ingredients of a toning solution be thoroughly dissolved before coming in contact with the film. Following are formulas for three of the most popular toners—two of which can be mixed by one's self. The third, the green toner, is more successful if secured already compounded, since the vanadium salts necessary in the formula are not always easily secured in some localities. All formulas or ingredients should be available from any leading photographic supply house.

BLUE TONER

Solution—A

Potassium ferricyanide, 70 grains; water, 20 fluid ounces.

Solution—B

Iron ammonia alum, 80 grains; oxalic acid, 95 grains; water, 20 fluid ounces.

• Continued on page 197

● Tinting or toning may be carried on with short lengths of film outside of the dark-room, under ordinary light, using common photo trays for the solutions, as shown above; or with a simple home made developing rack and tray as pictured below.



Reviews by
THE EDITORS

TELL ME— *how can I improve my film?*

THE reviews of amateur films published each month are not necessarily of the best of the films which we have been privileged to screen. Rather they have been selected for the valuable pointers which we believe they contain that may be of interest to other amateurs.

Every amateur filmer, whether a subscriber of HOME MOVIES or not, is invited to submit his films to the Editors for review and constructive criticism. If your films are carefully packed and properly addressed they will reach us safely and in good order. Return postage should be included, otherwise films will be returned by insured express collect.

Effective this month, all films submitted for review will be given a free cleaning and preservative treatment in addition to the attractive animated two, three, or four star HOME MOVIES leader.

Reviews selected for this month are as follows:

"**BEAUTIFUL ALLENTOWN**"
200 ft. 8mm Kodachrome—by A. W. H. ★★★

Continuity: A well handled documentary of a city. Scenes are kept to interesting length. Variety of scenes heighten interest. Continuity well maintained because of good editing. There is no lag in interest in such shots as those of the City Hall and other city buildings because they have been well titled and the footage of same held down to the minimum. Cut in, among shots of historic Zion Church, is an insert that tells the famed Liberty Bell was hidden there during the revolutionary war.

In introducing the retail district of the city, a title tells us it is the envy of many larger cities for several reasons, one of which is the flower bedecked light standards which line the downtown streets. Following this is a shot of the city's tallest building and also some highly interesting shots made from the top of it.

Views of the well landscaped waterworks are followed by shots of the city reservoir, fish hatchery, etc. It was interesting to note that all related subjects were kept together. From this point, a mother and a little girl about three are introduced and we find them appearing in the balance of the scenes which include shots of the city's parks, a famed covered bridge, hunter's cabin, another parkway, and a fine closing shot of a colorful sunset. It is a fine continuity, not overloaded at any point with scenes that do not

show action, and made further interesting with fine titles.

Editing: A fine piece of editing. Scenes are cut to proper length and titles are spliced at the proper point in each instance.

Titling: A commendable job of titling. The main title is superimposed over a street scene. The end title is a triple exposure of our flag waving from a staff over the city, and the words, "The End" superimposed over all. Exposure on titles was good throughout.

Photography: This story was filmed entirely in Kodachrome and the exposure was consistently good. Composition in many shots was exceptional. A steady camera is in evidence throughout, the result of use of tripod in about 95% of these shots. This filmer used a Bell & Howell camera with a f 2.7 lens, and an exposure meter.

"**THE HANDY MAN**"
60 ft. 8mm—by D. W. S. ★★★

Continuity: A clever story, typical of the alleged "handy man" about the house on a Sunday morning. Dad, the "handy man" stretches out on a garden lounge and prepares to read the newspaper, when Mother brings out a floor lamp to be repaired. He examines it roughly and suggests that all that may be wrong is a short in the wiring. The clever action starts at this point with Dad calling for Mother to fetch the pliers; son to bring a screw driver; then Mother is called again to bring still another tool; until both have been exhausted bringing tools which are now piled deep in Dad's lap!

Dad finally completes the repair, and falls back on the lounge exhausted from the exertion. Mother enters the

• Continued on page 198

• Reproductions are enlargements from the 8mm Kodachrome film, "Beautiful Allentown" (Pennsylvania) — a finely photographed, edited, and titled home movie.



THE EXPERIMENTAL

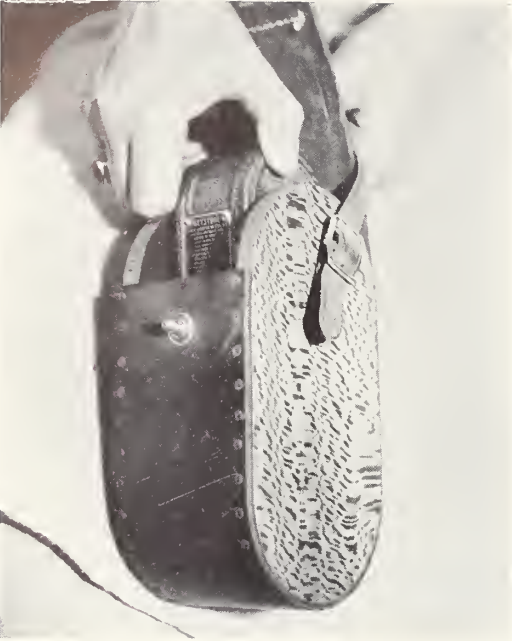

Camera Case

Here is a very sturdy and inexpensive carrying case which I made for my 8mm camera from two pieces of quarter-inch veneer and a strip of leather belting. The wooden sides are cut according to size of camera. The leather is fastened to these sides with small brass escutcheon pins. The flap was made separately, skived and sewed to the main body in order to form a "hinge." This is completed with a "lift the dot" type of fastener, obtainable from any awning or auto top shop. The case should be lined with felt or velvet to protect camera from abrasions.

Two buckles are attached at either side of the case to allow changing from a hand carrying strap to a shoulder strap. The case cost me approximately 50c to make.

—Bruce E. Stevens.

Aid To Color

Recently in shooting some movies of youngsters playing in the bathtub, I found the result somewhat disappointing, inasmuch as the water registered

CINEBUGS!

• If you have an idea for a gadget, trick, or shortcut in filming, titling, editing or processing home movies, pass it on to your fellow Cinebugs through these columns. If your idea is published you will receive two reels for your efforts. Extraordinary ideas will net you a roll of film.

Ideas not published will be held for future publication unless they duplicate ideas previously received. Endeavor also to send along photos or rough sketches illustrating your suggestions. There is no limit to number of suggestions you may submit.

Names and addresses of contributors of published ideas are furnished a prominent manufacturer interested in acquiring rights to saleable gadgets on a royalty basis.

Important: When submitting ideas, be sure to mention whether equipment you use is 8mm or 16mm, enabling us to promptly forward awards adaptable to your use.

very flat. I re-shot the scenes, after adding a small quantity of household bluing to the water. The result was much more natural and pleasing.

—Harold N. Hayden.

Centering Closeups

I have discovered a very simple method for centering my 16mm Keystone camera on closeups when same is hand held—an idea which may be practical with other cine cameras, too. On my viewfinder there is a little square etched into the glass which indicates the frame area when a telephoto lens is used. I

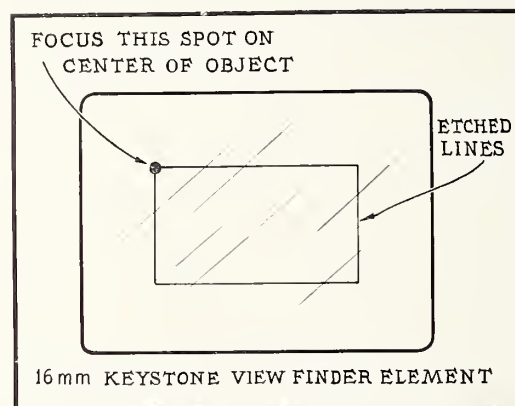

find, when sighting on closeups, that by bringing the upper left-hand corner of this square in line with the center of my object, my camera is accurately centered on the object.

I have painted a dot with black lacquer at this point on my viewfinder to facilitate easier alignment.

—Max O. Goldberg.

Film Grips

The film editor using one of the small film splicers, such as those furnished with Eastman projectors, will find a pair of ordinary spring-clip clothespins

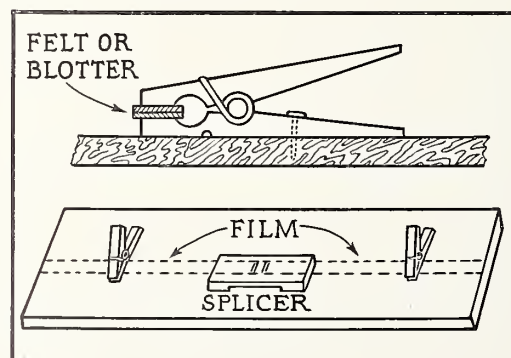

a decided help in holding the film where it is wanted during the making of a splice. The jaws of the clothespins, which are usually rounded, should be dressed off so that they will meet with

a flat surface parallel with the surface of the editing board. Pieces of blotting paper or felt should be glued to the face of the clothespin jaws to protect the film. The clothespins should be fastened to the board by glue and a small brad, about 2 or 3 inches away from the splicer and with the padded jaws in direct line with the film track of the splicer.

—Walter E. McBath.

Filming Upside—Down

Illustrated here is a plan for making a simple device for mounting your movie camera upside down on your tripod in order to shoot reverse action. The gadget can easily be made by anyone from a piece of 1/4"x1" strap iron obtainable from any "heavy" hardware store or supply house. Allowing for the height of your camera, bend the iron at right angles, top and bottom, as shown. At "A" drill a hole 9/32" in diameter. This takes a 1/4" thumbscrew, "B," with a

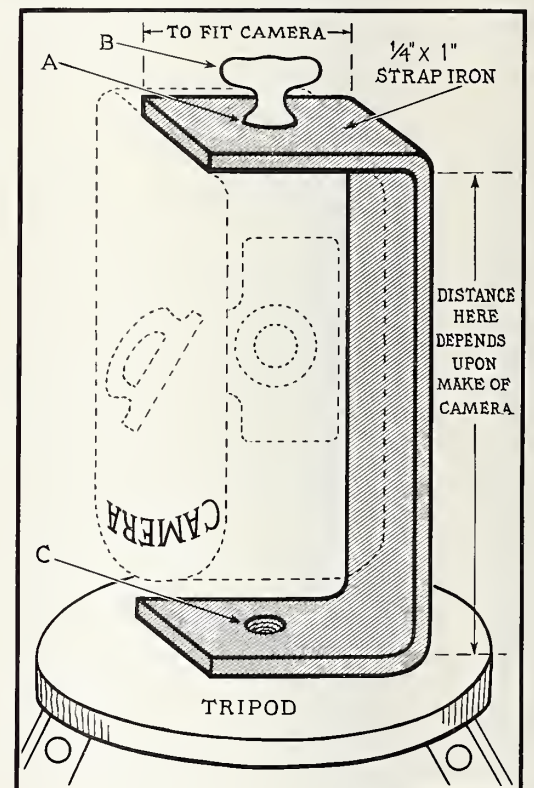

No. 24 thread which holds the camera in place.

At "C" drill a hole 7/32" in diameter and tap for a 1/4" No. 24 thread screw. This permits attaching the gadget to tripod or a tilt-pan head with regular tripod screw.

—Fred L. Ward.

Editing Aid

Here's a film editing idea that eliminates the necessity of tediously rewinding the sections of film that are cut from

C I N E W O R K S H O P

the roll during the break-down process. It is approximately the same system used in the cutting rooms of Hollywood studios.

A woven or wicker clothes hamper, some of which are now obtainable at low cost, is completely lined with soft muslin or flannel. Around the inside edge paste a strip of white paper or light cardboard, on which have been printed with ink, numerals from 1 up at intervals of about every two inches. Below each number screw in a small brass cup hook—the *small* size only will fit the film perforations. Thus you have a receptacle for holding your strips of film free from scratching and dust, and they may be kept in order, splicing end up, on the hooks.

—James A. Boice.

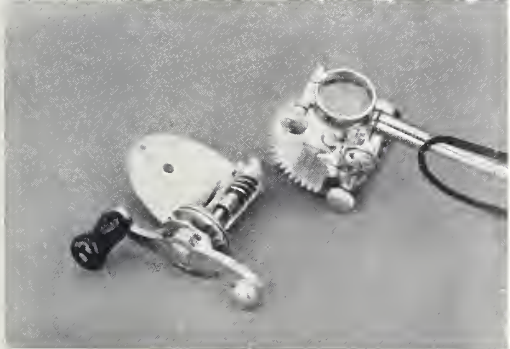
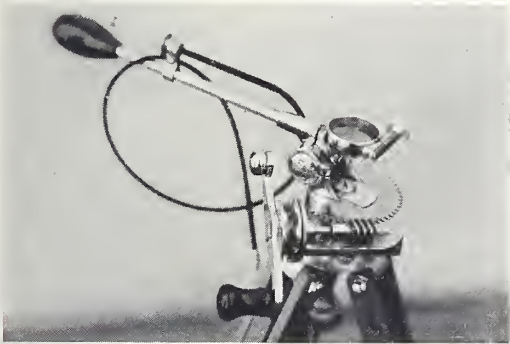

Geared Pan Head

I recently improved my friction-controlled pan head with a gear drive as shown in the accompanying photos. The gear assembly consists of a venetian blind tilting unit, which is obtainable from any venetian blind dealer for about 50c. The flat half-gear is detached from the unit and fitted to the base of the regular tripod head. The worm gear

and its mounting are riveted or soldered to an angular piece of metal which in turn fits the tripod screw of the tripod head.

The metal housing over the venetian blind cord pulley is entirely cut away with a hacksaw, chisel, and file, allowing for attaching a handle or crank over the pulley. I used a crank from an old fishing reel, and attached it to the pulley by drilling and tapping a hole in same and securing the handle to it with a machine screw.

The entire unit is demountable, as shown. When assembled, the worm gear fits the half-gear and the panorama action is controlled by turning the crank.

The cable release, also shown, is a remote camera button control which I also rigged up, permitting complete control of camera release and tilting action with one hand.

—Lawrence W. Gregory.

Film Changing Bag

For those who find difficulty in splicing leaders on spools of bulk film, here is a light-tight changing bag that will enable you to load your camera and watch the operation safely while doing it. A "muff" is made from two thicknesses of black sateen and large enough to accommodate your camera and also to allow movement of hands within it during threading process. All seams are on the inside, turned and double stitched.

The "arm-holes" on either side of the bag are fitted with elastic, drawn sufficiently to insure a snug fit about the wrists or arms. The under side of the bag is slit and a zipper, obtained from

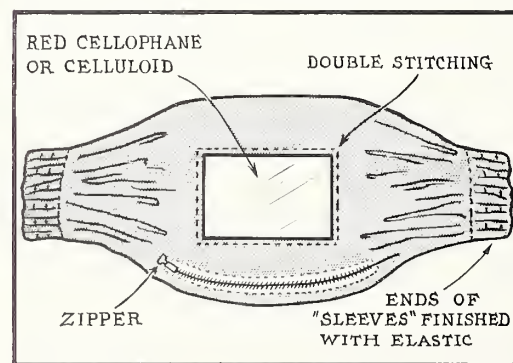

the notion counter of any 5 and 10, is fitted to it. This opening is made light-proof by an overlapping flap sewed inside the bag.

If you are using ortho or positive film exclusively, then add a "window" to the changing bag. This can be done by stitching a small panel of red cellophane or celluloid over a square opening and sealing the small holes made by the stitches with red or black cellulose tape. This "window" will enable you to watch film changing and threading operations.

—George Burnwood.

gadgets, tricks and short cuts contributed by Cinebugs

Film Fastener

Here is a cinekink which may help those amateurs who process their own film. Instead of using pins, wire, paper clips, etc., to fasten end of film to developing drum, bend the end of the film so that the glossy side of the turned end faces glossy side of rest of film. Insert a rubber band in the "hook" thus

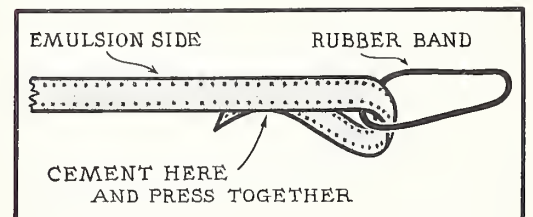

created, then touch a dab of film cement to the bent section and press it firmly against the film. When dry, a loop will be formed that will not come apart during the processing.

—Clifford E. Young.

Reel Book Covers

Keeping one's films on a library shelf or between book ends on the library table makes them more readily accessible for showing to drop-in visitors. To make this practical, I have built some novel covers for my 8mm reels to resemble books, as shown. The "core" of the book is made from a piece of celotex. The center is cut out with a scroll saw. The "covers" of the book are made from pieces of No. 15 chip board and one of these is securely glued to one side of the



"core." The other is hinged with a piece of gummed fabric and then the two covers are finished with a covering of colorful chintz. I added further decorations of illustrations cut from magazines or enlargements from frames of the films which the books contained.

—Leo Bachman.

"IT'S NEW TO ME"

By CINEBUG SHOPPER

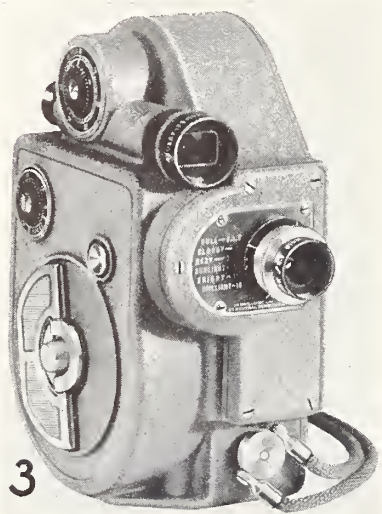

New Revere Camera

Revere Camera Company, Chicago, announce their new double 8mm Cine Camera this month, a camera which is a distinct advance over their early single 8mm model. The new model will take any double-eight film, including Kodachrome, and it features a radically new improvement — an automatic loop-forming feature that prevents film jamming. Five speeds — 8, 12, 16, 24, and 32 F.P.S., make this camera adaptable to every filming condition. The improved optical viewfinder is parallax corrected with markings indicating the field of various size lenses. The new Revere Double-8 is available with an $f/3.5$, $f/2.7$, or an $f/1.9$ lens.

Centering Device

Camera Specialties, Hollywood, announce the Noparlax — a new optical alignment device for the centering of titles and ultra closeups. Noparlax is made to fit any 8mm or 16mm camera except Cine Kodaks with bayonet mounts. By removing camera lens and inserting the Noparlax in lens opening and remounting lens on the Noparlax, it is possible to line up your camera accurately with the center of your titling board or the field of ultra closeups, according to the maker.

New Catalog

Cinefilers as well as still camera fans are invited to write to Burke & James, 223 W. Madison Street, Chicago, for a copy of their latest bargain catalog, which lists several hundred items and accessories at attractive prices.

"Hi-Spot" Spotlight

Especially adaptable for special lighting effects in home movies is the recently intro-

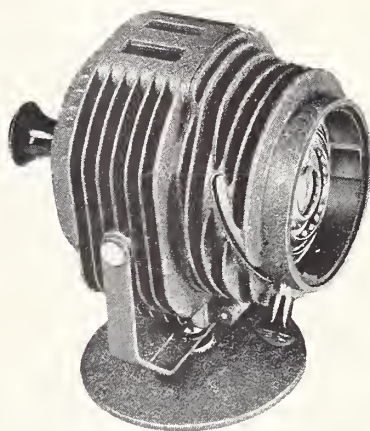

duced Hi-Spot — a miniature spotlight sporting all the features of its big brothers, according to the manufacturer, Fink Roselieve Company. The entire unit is attractively finished in fine gray crackle. The housing is a single unit casting with ventilating fins that keep heat content at a minimum and insure maximum life of lamps. The lamp is adjustable to produce spots of light of varying areas and a Fresnel lens insures concentrated light beams free of "ghost" effects. Hi-Spot's exceptionally low price now makes it possible for every cinefilmer to add spotlights to his movie making equipment, according to the manufacturer.

Clever Title Cards

A clever innovation in title cards are those printed on transparent celluloid in black or colors by Newlands, 6016 Barton Avenue, Hollywood.

They are especially ideal where it is desired to superimpose title text over pictorial backgrounds such as picture postcards, magazine illustrations, or enlargements made from frames of the film being titled. They are particularly effective, too, when used in conjunction with the title backgrounds which appear each month in HOME MOVIES. Another effect recommended by Newlands is the use of two transparent cards with the same text printed on each. In the titler, the cards are inserted together, with the second card placed slightly off center so as to give the illusion of a shadow of the lettering on the first card — especially effective when printed in color for Kodachrome.

Self-Reflecting Lamp

According to General Electric Company, their new self-reflecting photoflood lamp is



meeting with increased demand everywhere, obviating as it does the necessity of using metal reflectors. This new photoflood lamp, known as the "R-2," is a mushroom type bulb with frosted surface and with the lower portion coated on the inside with an aluminum reflecting material. Thus the lamp is a light source and reflector all in one. A special feature of the General Electric R-2 lamp is the "black neck" — a black coating applied on the outside lower portion of the lamp, designed to prevent stray light escaping into the camera lens.

Super-size Film Packs

Bulk film users, those who like to process their own, and those cinefilers whose filming amounts to more than an occasional 50-foot roll of film, will be interested in the announcement made by The Gevaert Company of America that, effective March 15th, their regular double 8mm and 16mm reversal film will be available in 100-foot 8mm and 200-foot 16mm laboratory packings. The films thus available are: Panchro Super Reversal, Panchro Microgran Reversal, and Ortho Reversal. The purchase price does not include processing.

Edit and Title Service

Stahl Editing & Titling Service, 33 W. 42nd Street, New York City, announce they have taken over all the editing and titling work formerly done by that branch of Eastman Kodak Company. According to Miss Stahl, manager, during the past month her organization has produced in excess of 3600 feet of Kodachrome titles alone. A new booklet describing their entire service and prices may be obtained free by writing to the above address.

Synchro Light Control

A remote control synchronizing system for photoflood lamps is announced by Bar-



nett Laboratories, 160 N. Wells Street, Chicago, which,

according to the makers, enables anyone taking indoor movies to synchronize his lights with his camera action. A small hand switch, connected to the lamps, keeps them on only while the camera is in motion, thus preventing unnecessary eye-strain and needless burning of lamps between shots. Unit consists of adjustable synchronizing switch and resistor in ventilated housing, and 40 feet of molded rubber extension cord.

Fade-O-Scope

The recently announced Fade-O-Scope — the newest device for making fades and lap dissolves — is being well received by amateurs everywhere, according to the makers, Fade-O-Scope, Inc., Brooklyn, N. Y. This new accessory clamps on to the lens by means of an adjustable screw, and by operating a small lever at the side, discs of polaroid glass are moved in such a manner as to fade the scene from view, or, by reversing the action — fade in the scene. An illustrated folder describing the Fade-O-Scope may be had from your dealer or by writing to the manufacturer.

New Ampro Projectors

Keeping in step with the progress of 16mm movies, The Ampro Corporation, Chicago, announce seven new and superior models of 16mm projectors — both sound and silent.

Literature illustrating and describing the entire Ampro line is now available by writing direct to the Ampro Corporation.

Title Figurettes

A novel method for illustrating and decorating home movie titles are the "A to Z Figurettes" — a product of Jacob Stein, manufacturer of the "A to Z" titling sets. Die cut from a gummed linen substance, the Figurettes will adhere to paper, glass, wood and similar materials and may be used over and over again. The assortment consists of 30 general subjects in an assortment of colors. Free samples may be had by writing direct to the manufacturer, 175 Fifth Avenue, New York City.

DON'T MISS THE FUN
get a new Voca-TITLER
RECORDER · RADIO · PHONOGRAPH
DIRECT RADIO RECORDER AND PUBLIC ADDRESS SYSTEM



VOICE TITLES FOR 8 and 16mm SILENT FILMS
 Enjoy the thrill of making voice titles and sound effects for your "silent" films. Making spoken titles is both inexpensive and easy to do. You can also record anything played or sung and play it back immediately.

The new Recorder-Microphone-Radio-Phonograph-Loudspeaker Unit can't be matched for value. . . . It is attractively finished in airplane luggage fabric with distinctive hardware



YOU CAN EASILY RECORD NARRATIVE TITLES AND SOUND EFFECTS FOR YOUR OWN FILMS

ENTHUSIASTIC movie makers were quick to recognize the value of spoken titles for silent films as produced by the Voca-TITLER. Obviously, the value of motion pictures is increased tremendously when accompanied by sound and particularly when one's own voice, recorded with fidelity, accompanies the action on the screen. Voice titles are made in a small fraction of the time required to make ordinary lettered titles. In fact, it takes but little longer than the projection time of the film being titled, and the record is ready for use immediately. Of outstanding importance is the fact that spoken titles cost much less than lettered titles. And best of all, it's fun to do—the recording of narrative titles is in itself a fascinating hobby.

Recording with the Voca-TITLER is simple—anyone can do it without assistance. It is not at all complicated but rather an easy system by which voice titles and sound effects are produced in conjunction with a film at the proper moment—just like the narrative of the professional news reel.

The Voca-TITLER unit, through which the film passes, controls electrically the phonograph turntable and the amplified loudspeaker. Sound comes from the loudspeaker, usually placed near the projection screen, clearly and without lag or distortion.

The Recorder-Microphone-Radio-Phonograph-Loudspeaker Unit (shown in upper circle) closes into an easy-to-carry case. Turntable runs at 78 r.p.m. and Recorder cuts 109 lines to the inch. About 30 titles of 20 words each can be put on either side of a 12-inch record. Included is 25-foot cable to Loudspeaker—\$110. With Voca-Titler—\$179.50.

The Voca-Titler Unit (shown at right) is a precisely built instrument for electrically controlling the phonograph turntable and amplified loudspeaker. Can be used with any recorder-phonograph. 100-125V., 60 cycle, AC. 8mm or 16mm...\$69.50

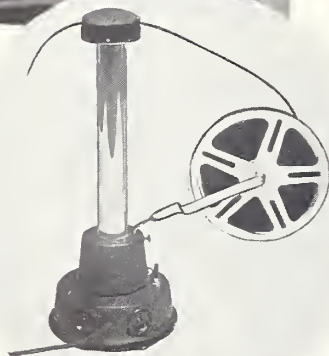

VOICE TITLES FOR SILENT FILMS

Voca-TITLER

RECORDER · RADIO · PHONOGRAPH

EXCLUSIVE DISTRIBUTORS

AMERICAN BOLEX COMPANY

155 EAST 44th STREET

NEW YORK, N. Y.

STOP—get a Voca-TITLER—then LOOK and LISTEN

SEE IT—HEAR IT—SEND TODAY

AMERICAN BOLEX CO.
 155 EAST 44th STREET, NEW YORK, N. Y.

I am interested in the Voca-Titler—send illustrated folder, without obligation. Also tell me where I can see and hear demonstration.

NAME.....

ADDRESS.....

CITY..... STATE.....

PUT "CLASS" INTO YOUR MOVIE TITLES WITH OUR

ART TITLE BACKGROUNDS

Printed on separate cards, ready to use. Each one different — made especially for typewriter titlers. Packaged complete with instructions. Specify Set No. 1 for Black & White; or Set No. 2 for Kodachrome. . . . **25 cards 50c**

VER HALEN PUBLICATIONS 6060 Sunset Blvd., Hollywood, California

LIGHT YOUR MOVIES THE HOLLYWOOD WAY

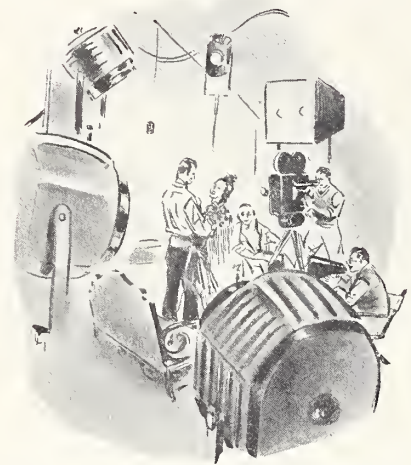

As your camera leaps from subject to subject, each movement comes alive with the utmost in dramatic effect. For with the F-R HI-SPOT, you "pick-up" features ordinary lights could never discover. GOOD photographers study Hollywood lighting, acknowledged the world's finest. Use the same type of lighting cinematographers and studios do.

F-R HI-SPOT HOLLYWOOD TYPE SPOTLIGHT

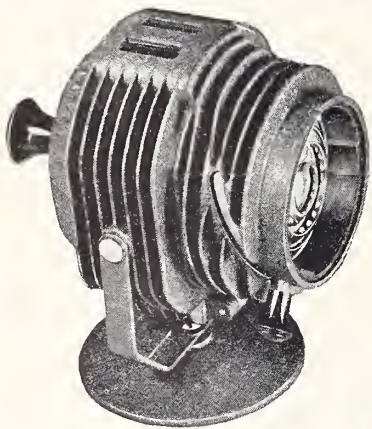

Complete with special
150-watt F-R HI-SPOT
PROJECTION LAMP

\$9.95

*The Light
with a Punch*

Equipped with the famous Fresnel lens, heat dissipating construction, ample ventilation, and many other distinctive features. Compact and light-in-weight (less than 6½" overall), it is easily handled. Tripod-mounted or adapted to any standard light stand, it affords complete directional control from any angle. Finger-tip focusing from a large to a small spot in varying degrees of sharpness and intensity. Never before has a comparable light sold for so little. Buy it at your dealer today!



The "Magic Wand" — script and titles!

• Continued from page 173

Main Title:

THE MAGIC WAND

Scene:

1. Scene—garden or yard. Fadein to semi-closeup of Daddy reclining on beach chair. He yawns and stretches lazily, then snuggles down comfortably and begins to doze.
2. Medium shot. Mother, with Helen and Mary, exiting from house, dressed for an outing. Mother looks off in direction of Daddy dozing in garden. The trio start walking toward him.
3. Same as scene 1. Mother and girls walking into scene in distance.
4. Semi-closeup of Mother and girls as they look at Daddy amusingly.
5. Closeup of Daddy in chair. He peeks at the trio with one eye, then opens the other. Looks at trio inquisitively.
6. Back to scene 4. Mother speaks —
7. TITLE: "We're going for a walk in the park. Want to come along?"
8. Back to scene 5. Daddy says no, emphatically, waves them on their way good-naturedly, and snuggles back into chair.
9. Back to scene 6. The trio turn and exit from scene.
10. Scene: Street in front of home. Mother and girls exit from yard to sidewalk and proceed down street. Fadeout, or dissolve into —
11. Scene: Park. Mother and girls walking leisurely across park lawn.
12. Scene: Another view of park with flower garden or hedge in immediate background. Medium shot. Mother and children walking leisurely. Mother and Mary stop to examine a flower. Helen is attracted by object on lawn. Stoops to pick it up.
13. Closeup of Helen picking up a glittering wand.
14. Back to scene 12. Helen examines wand quizzically. Looks up toward and calls to Mother —
15. TITLE: "Oh! Look what I found!"
16. Back to scene 14, as Helen finishes speaking. Mother and Mary walk over, look at wand, then Mother takes wand in hand.
17. Medium closeup of all three. Mother takes wand and starts to speak —
18. TITLE: "Why, It's a Fairy's Magic Wand!"
19. Back to scene 17. Mother finishes speaking. Returns wand to Helen, who waves the wand back and forth. Then asks Mother what is magic about it.
20. Closeup of Mother as she speaks:
21. TITLE: "You must say some magic word as you wave it, like — 'Abracadabra.'"
22. Back to scene 19. Helen waves wand and says:
23. TITLE: "Abracadabra!"
24. Back to scene 22. As Helen finishes speaking, Mary disappears instantaneously. (This is accomplished by stopping camera in middle of action, "freezing" all characters, then removing Mary from scene. Mary should stand at left facing Helen at right.)
25. Closeup of Helen with terrified expression. Drops wand and looks up anxiously at Mother.
26. Closeup of mother, amazed at disappearance of Mary.
27. Medium long shot of mother and Helen as they look around and begin to search for Mary. Call out, search bushes, etc. Mother walks over to wand and picks it up.
28. Medium closeup of mother, Helen along side, as she picks up wand and waves it, saying:
29. TITLE: "Abracadabra!"
30. Same as scene 27. Mother finishes speaking and waving wand. Mary re-
31. Medium closeup. Mother, overjoyed, drops wand, and draws Mary close to her, giving her hug and kiss.
32. Closeup of Mother's face over shoulder of Mary, registering joy.
33. Medium shot. Helen picks up wand while Mother still embraces Mary. Waves wand over heads of Mother and Mary, saying, gleefully:
34. TITLE: "Abracadabra!"
35. Back to scene 33. Mother and Mary both disappear. Helen calls, starts to look for them, and waves wand some more.
36. Closeup of Helen with frightened expression. Speaks:
37. TITLE: "O-o-o-oh! I must go and tell Daddy!"
38. Same as scene 36. Helen finishes speaking. Exits from scene running.
39. Medium shot. Helen running out of scene away from camera. Wipe into —
40. Medium shot. Helen running down path in park. Stops at park bench to rest.
41. Closeup: Helen seated on park bench, breathing hard. Appears about to burst into tears and says, as she looks at wand:
42. TITLE: "Oh, why did I ever find this old wand!"
43. Same as 41. Helen finishes speaking. Looks about, anxiously; then arises from park bench and continues running. (Follow her briefly with camera, then fadeout.)
44. Same as scene 1. Fadein. Father fast asleep in chair. Helen comes into scene running.
45. Medium closeup. Helen reaches father's side. Calls to him. Shakes his arm. He awakens with a start. Looks at her drowsily and inquisitively as he asks

what is the matter. Helen speaks:

- 46. TITLE: "Mother and sister have disappeared. Come and help me find them!"
- 47. Back to scene 45. Helen finishes speaking.
- 48. Closeup of Daddy. Looks bewildered and says, "Disappeared?!"
- 49. Same as scene 45. Helen, with frightened look, and still breathing hard, nods her head in assent. Daddy asks:
- 50. TITLE: "How did it happen?"
- 51. Back to scene 49 as Daddy finishes speaking. Helen starts to speak.
- 52. Closeup of Helen as she shows Daddy wand and speaks:
- 53. TITLE: "I just waved this wand and they disappeared."
- 54. Back to scene 51. Daddy abruptly takes wand from Helen. Examines it and looks at her skeptically. Helen speaks:
- 55. TITLE: "And I said 'Abracadabra' when I waved it."
- 56. Medium shot. Daddy waves wand in skeptic fashion. Then half-heartedly and with a sheepish grin, says:
- 57. TITLE: "Abracadabra!"
- 58. Back to scene 56. Daddy finishes speaking. (Both Daddy and Helen are at extreme left of scene.) Abruptly, Mother and Mary appear in scene to the amazement of Daddy and Helen. (Accomplish same as before: "Freeze" Daddy and Helen, stop camera, insert Mother and Mary in scene to right of camera.) As action is resumed, Helen expresses joy and runs over to Mother and Mary, who bend down to embrace her.
- 59. Medium closeup. Mother and Mary being embraced by Helen. Helen turns and looks at Daddy appreciatively.
- 60. Closeup of Daddy with broad smile on face as he says, boastfully:
- 61. TITLE: "See, Honey, I'm a magician, too!"
- 62. Back to scene 60 as Daddy finishes speaking.
- 63. Medium shot. Daddy laughingly thumps his chest, expresses his ego-

BETTER PICTURES WITH BOLEX

"SIXTEEN"

"DOUBLE-EIGHT"

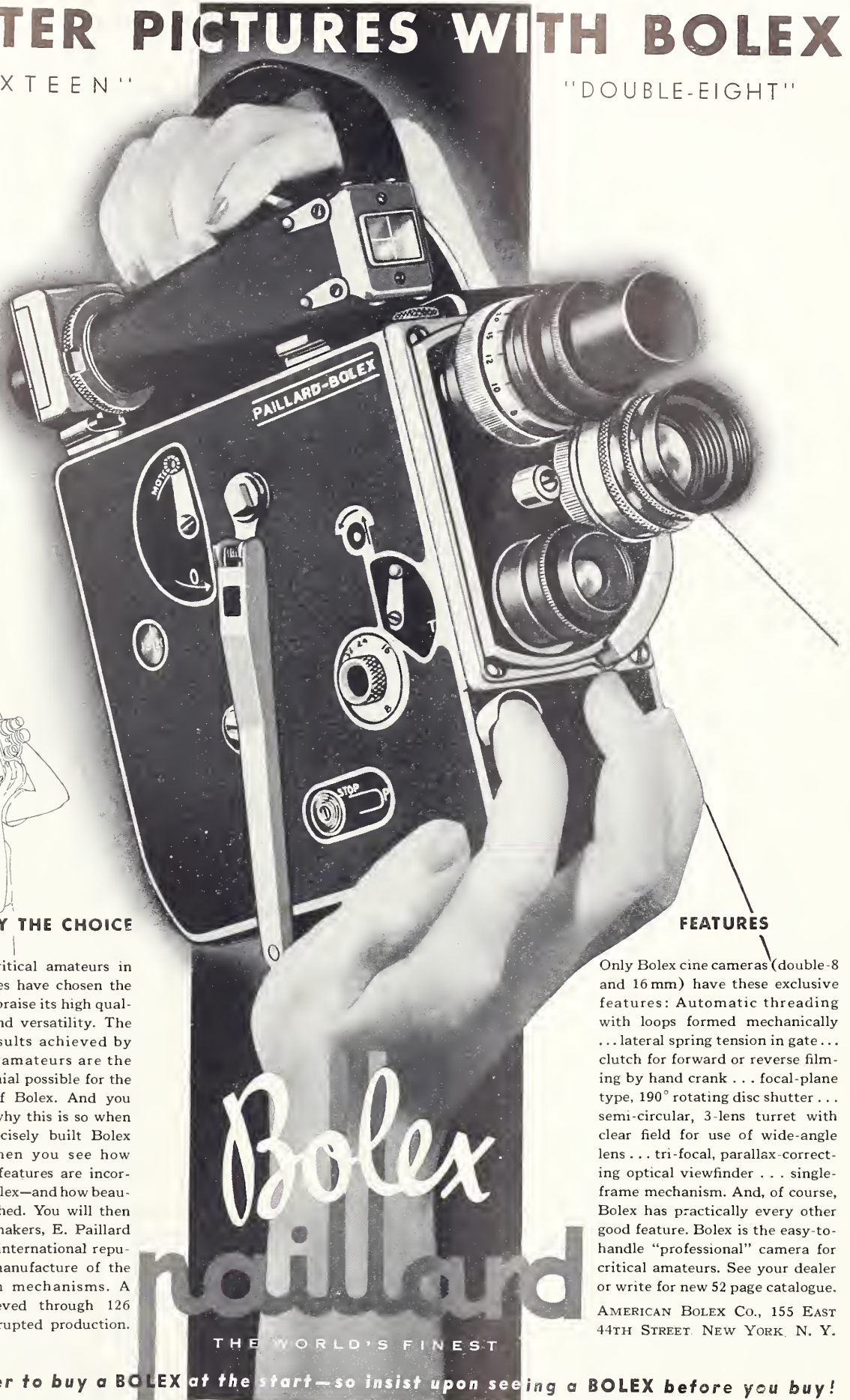

INVARIABLY THE CHOICE

Thousands of critical amateurs in the United States have chosen the Bolex and daily praise its high quality, precision, and versatility. The outstanding results achieved by these foremost amateurs are the greatest testimonial possible for the sterling merit of Bolex. And you can readily see why this is so when you see the precisely built Bolex mechanism—when you see how many exclusive features are incorporated in the Bolex—and how beautifully it is finished. You will then know why the makers, E. Paillard & Co., enjoy an international reputation for the manufacture of the finest precision mechanisms. A reputation achieved through 126 years of uninterrupted production.

FEATURES

Only Bolex cine cameras (double-8 and 16 mm) have these exclusive features: Automatic threading with loops formed mechanically . . . lateral spring tension in gate . . . clutch for forward or reverse filming by hand crank . . . focal-plane type, 190° rotating disc shutter . . . semi-circular, 3-lens turret with clear field for use of wide-angle lens . . . tri-focal, parallax-correcting optical viewfinder . . . single-frame mechanism. And, of course, Bolex has practically every other good feature. Bolex is the easy-to-handle "professional" camera for critical amateurs. See your dealer or write for new 52 page catalogue.

AMERICAN BOLEX CO., 155 EAST 44TH STREET, NEW YORK, N. Y.

THE WORLD'S FINEST

It is cheaper to buy a BOLEX at the start—so insist upon seeing a BOLEX before you buy!

Special Offer!

A TWO-YEAR SUBSCRIPTION TO HOME MOVIES (Value \$4.00), AND A HANDSOME LEATHERETTE BINDER HOLDING 12 ISSUES—ALL FOR **\$5.00**

HOME MOVIES 6060 SUNSET BOULEVARD • HOLLYWOOD, CALIF.

SALE!

TO MAKE ROOM
FOR NEW MODELS
WE OFFER
THE COMPACT

Candid Midget

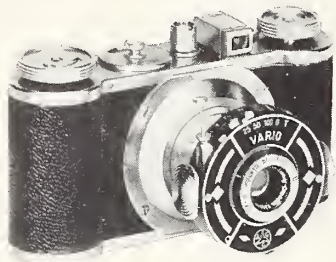

AT \$8⁹⁵ FORMERLY \$20.00

Here is an opportunity to get one of these popular miniature cameras at more than 50% off. The Candid Midget is chromium finished, compact, lightweight, with an all-metal leather covered body, and is equipped with an f/4.5 Anastigmat Lens in Vario Shutter with speeds up to 1/100th part of a second. It measures 4 3/4 x 2 1/2 x 2 inches in size, takes all standard 35mm film and makes pictures 1 x 1 1/2 inches.

Eveready Leather Case \$2.85

MAIL ORDERS FILLED
POSTAGE PREPAID
TRADE IN YOUR OLD CAMERA

Willoughbys

110 West 32nd St., N. Y.
Near 6th Avenue
World's Largest Camera Store
Built on Square Dealing

- tism, and snuggles back into his chair.
64. Back to scene 59. Mother looks up toward Daddy with a sly expression. Arises and walks toward him.
 65. Same as scene 63. Mother enters scene. Daddy, laughing boisterously. Mother takes wand from his hand. Waves it over him and starts to speak.
 66. Closeup of Mother as she waves wand and speaks:
 67. TITLE: "Abracadabra!"
 68. Back to scene 66 as Mother smilingly finishes speaking.
 69. Back to scene 65. Daddy suddenly disappears from scene.
 70. Same as scene 68. Closeup of Mother with amused leering expression as she speaks toward chair:
 71. TITLE: "So you're a magician, too!"
 72. Back to scene 70 as Mother finishes speaking. She waves wand again and says, "Abracadabra!"
 73. Same as scene 69. Scene opens with Daddy's chair vacant. Helen and Mary looking at it expectantly. Daddy suddenly reappears. Children run to him and embrace him.
 74. Semi-closeup of Daddy, with girls embracing him on either side, looking up toward Mother with pleased expression. Mother enters scene, kneels down, and wags her finger at Daddy provocatively. Fadeout.
 75. Fadein, same as scene 1. Daddy asleep in chair, unconsciously waving his right hand as though waving a wand. Mother, Helen, and Mary, enter scene in background. Approach Daddy.
 76. Semi-closeup of Helen as she reaches Daddy's side. She has a long wisp of grass in her hand and she cautiously tickles Daddy's ear. Daddy swings his hand languidly towards the annoyance, shifts in his chair, then awakens.
 77. Medium shot, similar to scene 76 with Mother and Mary now in the scene. Mother and girls laughing, as Daddy sits upright in chair rubbing ear.
 78. Closeup of Daddy as he looks at them with a surprised expression.
 79. Same as 77. Mother speaks:
 80. TITLE: "What's the matter?"
 81. Same as scene 78. Daddy looking sheepishly, scratches his head, laughs and says:
 82. TITLE: "I guess I must have been dreaming".
 83. Same as scene 77. Mother with arms about both girls, shaking head affirmatively and laughing.
 84. Medium closeup. Daddy reaches for wisp of grass in Helen's hand, waves it, like a wand, toward Mother and girls and says:
 85. TITLE: "Abracadabra!"
 86. Back to scene 84 as Daddy finishes speaking. Mother and girls look quizzically at each other. Daddy flops back into chair, snuggles down and continues napping. Fadeout.

THE END

You will note there are seven separate titles of the word, "Abracadabra". Shoot sufficient footage of this at one time to make the seven titles. Allowing about one foot for each "Abracadabra" title, this would be approximately seven feet.

Spotlights light way for better films . . .

• Continued from page 170

fits between the camera and the tripod-head, while the upper end carries the lamp.

Often when a cinematographer—either professional or amateur—has to make a close shot of two people together, he'll find himself up against a tricky lighting problem if one person is in a light-toned costume and the other in a dark one. If you light the whole scene for the dark costume, the light one will be overexposed; if you light for the light one, the dark one will be just a heavy, black shadow.

These small spotlights help a situation like this a lot; for one of them, either on the camera or nearby, can be adjusted to throw a bit of special illumination on the dark costume, yet avoid illuminating the light

costume or the faces of both players. The professional has a simple little gadget that makes this trick still easier. It's called a "barn door"—and that's just what it looks like. It is simply a frame that slips over the front of the spotlight and carries a pair of hinged metal flaps (sometimes four) which can be swung open or closed independently, and adjusted to block off the edges of the beam any way you want it.

Spotlights are the main tool for professional back-lighting and rim-lighting, which serve to make the player appear to stand out on the screen with three dimensional clarity. Anyone who has tried these effects with conventional, floodlight-type home-movie equipment knows how hard

it is to get such effects with equipment that can't be controlled accurately. If you swing the lamp so its direct rays don't hit the lens, you're likely to get an undesired streak across the back wall; if you keep the streak off the back wall, the other side of the beam is likely to strike your lens.

With a spotlight you can concentrate the beam until it just "covers" your actor without slopping over

ANSWERS TO CINE QUIZ	
1	A
2	B
3	f/3.5
4	A
5	2 or more
6	B

ORDER FOR SUBSCRIPTION

Home Movies Magazine

12 MONTHS FOR \$2.00 IN U. S.

In Canada, \$2.00; Foreign—\$3.00

SPECIAL OFFER: 3 Years for \$5.00 in the U. S.

HOME MOVIES
6060 Sunset Blvd.
Hollywood, Calif.



1. Send to.....

Address

City..... State.....

New Renewal Gift

2. Send to.....

Address

City..... State.....

New Renewal Gift



Enclosed find \$..... Date.....19.....

Sent in by.....

Address

City..... State.....

NO SUBSCRIPTIONS ACCEPTED FOR LESS THAN ONE YEAR





where you don't want light. Until recently, true back-lighting has been almost impossible in home movies, for this lighting usually has to come from behind and above the player and there has been no way of getting big lamps—spotlights or floodlights—up into that position. But with today's super-small spots, it's a different story. These lamps are so small and light that it is easy to support them on curtain-rods, picture-mouldings, and the like. Some of them are even light enough so it should be possible to hold them on the wall itself, just above camera-range, with the disc-shaped, rubber suction-cups some stores use for holding signs and small shelves in their windows.

This same trick can be used when you find it necessary to "pick out" some special part of a room, or some special object, with a spot of highlight to make it stand out correctly in the picture. If you can hang one of these "dinky" spots on the wall, you can often put its light where you want it more accurately

than if you had to use any sort of lamp-standard to support it. And the spotlight's controllability of course means you can give its beam precisely the intensity and spread your shot calls for.

What's more, these newest members of the "spot" family are so small they can often be hidden right in the scene to toss their bit of light where it will be the most useful. If you've a chair or a davenport, for instance, near a wall and of such a color that with only front lighting the two are likely to blend together on the screen, just put your little spotlight on the floor behind it, flood its beam out wide and direct it upwards along the wall. This high-light will give wall and furniture different tonal values, and make them stand apart three-dimensionally.

In the same way, when making long-shots, a "peanut" spot concealed behind what the professional would call "some of the set-dressing"—a vase of flowers, a pile of books, anything that will hide the lamp from the camera—



THEY ARE ALL YOURS WITH A GRAPHIC

VERSATILITY—of course. You expect it. But add top quality, and you've specified a Speed Graphic.

Consider the $2\frac{1}{4} \times 3\frac{1}{4}$ model. Compact, yet it offers the advantages of both focal-plane and between-the-lens shutters, ground-glass focusing, interchangeable lenses, parallax-correcting

tubular view finder, internal coupling for range finder, and built-in focal plane shutter flash synchronization. Adaptable for film packs, plates, or sheet film, including Kodachrome, the full-color film.

With Kodak Anastigmat $f/4.5$ lens, in Compur (1/400 sec.) shutter, \$111.

Graphic and Graflex Cameras are made by Folmer Graflex Corporation.

EASTMAN KODAK COMPANY, ROCHESTER, N. Y.

An Outstanding Value! SEEMANN EDITEER

Check these special EDITEER features!

- Illuminated Optical Film-viewer shows magnified 8mm or 16mm film image in VERTICAL position.
- Seemann Splicer features dry emulsion scraper—makes quick, accurate splices that won't come apart.
- Splices 16mm sound film, too!
- Geared rewinds permit quick winding of film in either direction. Fits all 8mm and 16mm reels.
- Editing board provides recesses for holding film scenes coiled and in order, ready for splicing.

All Accessories Available Separately; Write for Circular H-2.

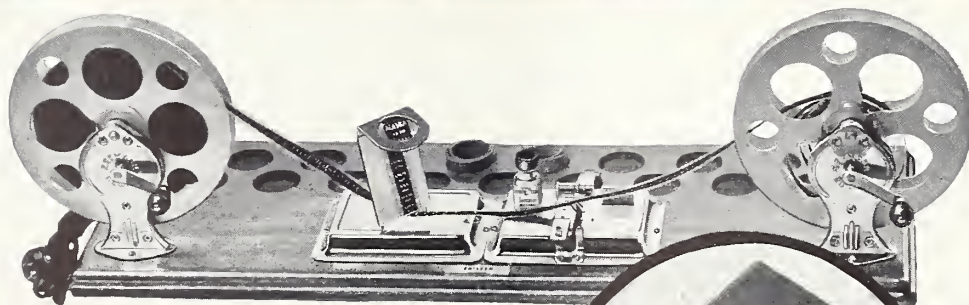

for Quick, Easy Editing Of 8mm and 16mm Silent and 16mm Sound Films

The EDITEER makes film editing and splicing a pleasure—not a task. Every necessary accessory is provided to make this phase of home movie making easy, interesting, and successful! Your films are easy to inspect, quickly and safely spliced, and the individual film-section receptacles are an innovation that will delight every amateur. Ask for a demonstration at your dealer's!

\$12⁵⁰



Distributed by

RAYGRAM, New York City
HORNSTEIN, Chicago and Dallas

SEEMANN'S Inc.

6628 SANTA MONICA BLVD. HOLLYWOOD
420 MARKET ST. SAN FRANCISCO

WHY PAY MORE THAN \$3.00 FOR PERFECT OUTDOOR FILM PERFORMANCE

KIN-O-LUX
FINE SAFETY FILM FOR USE IN 16 mm MOVIE CAMERAS
16 mm
KIN-O-LUX FILMS NEW YORK, N. Y.
FILM No. 1

... unless, of course, you're the sort of person who likes to pay more. Three dollars for a 100-ft. roll of Kin-O-Lux No. 1 Film includes every essential requirement for good outdoor filming. It offers brilliancy—snap-gradation—latitude—tonal fidelity—anti-halation backing—free Scratchproofing to insure long life and the maker's unequivocal guarantee. Within limitations that preclude indoor filming and filter use, its performance is identical to that of more expensive films.

DAYLIGHT EMULSION SPEEDS

Scheiner 16° Weston 6

100-ft. roll	\$3.00
50-ft. roll	\$2.00

KIN-O-LUX No. 2. Fine-grain, semi-chromatic. Greater speed and wider latitude than No. 1 Daylight Emulsion Speeds: Scheiner, 18°; Weston 12.

50 ft.	\$2.50
100 ft.	\$3.50

KIN-O-LUX No. 3. Supersensitive over the entire range of the visible spectrum, Kin-O-Lux No. 3 has established a new standard of film performance. Achieves an ultimate, present-day perfection that cannot be surpassed. Is preferred by movie makers who discriminate in favor of the best. Daylight Emulsion Speeds: Scheiner, 26°, Weston 50. Tungsten Speeds: Scheiner, 24°, Weston 40.

100 ft.	\$6.00
50 ft.	\$3.50

ALL FILM PRICES INCLUDE PROCESSING, SCRATCH-PROOFING AND RETURN POSTAGE

At Leading Dealers Everywhere
Booklet H-4 on Request

Learn about Glare-Free, Reflectionless Photography. Send for instructive Folder on Marks Polarization Plates.

KIN-O-LUX
16 MM REVERSAL FILM
KIN-O-LUX, INC.
105 W. 40th ST., N. Y. C.

can help out in lighting people, and sometimes can be useful in helping you to simulate lamplight effects.

If you're a gadgeteer, there are several easily built accessories which will help you use these lamps better. The "barn door", already described, is one. Another is a set of diffusers to give you more complete control of the quality of your light. One should be plain, white silk. Another, tracing-cloth. A third should be thin, translucent, white oiled cellophane or even waxed paper. And if you are going to be making close-ups in black-and-white of a person who has pale gray or blue eyes, you'll find it very handy to have one fitted with a sheet of magenta-colored theatrical filter-gelatin, which you can get at any theatre-supply store. If this magenta light is used softly on the face, it has a filtering effect on the blue eyes (which would ordinarily be "washed out" on the screen) and makes them photograph much better.

How are these diffusers made? Quite simply. The easiest way is to take a square of plywood or, bet-

ter, Masonite "presdwood." Make this square just a bit larger than the front lens-mount of your spot. Next, cut a circular opening in its middle, slightly larger than the diameter of the spotlight's lens. Finally, tack or glue onto this (over the hole, of course) whatever diffusing material you want. And there you are! Of course, if you're an experienced tinsmith, you can turn out a much neater diffuser frame by using tin, and making it book-shaped, with the diffusing material held between the two plates; but unless they're subjected to too much heat, the plywood ones will work just as well, and be easier to make.

Some lamps come equipped with clips to hold diffusers, etc., in place; others don't. If yours is one of the kind that don't, simply solder onto the rim that projects in front of the lens, three little L-shaped clips—one at the bottom, and one at each side. They should be big enough, by the way, to provide room for at least two of your diffusers and your "barn door," for you'll often want to use them all together.

Practice perfects reversal

• Continued from page 167

clude the original exposure, the time and temperature of the first developer, the bleaching time, the second exposure, the second developing time, and the hypo rinse (if used). The first two—exposure and first developer—probably always will be variables; but the remainder can be, and I think should be, constants. In other words, some workers flash the light for the second exposure. My method is to turn on a 60 or 75 watt light 4 or 5 feet away as soon as the film has begun to bleach, and leave it on for the rest of the process, thus making the second exposure a constant, and reducing any chance for error in this operation.

Secondly, I bleach until the image is clear, or until the black is entirely gone, whether it be three or ten minutes. Thus another variable is made a constant. Third, I redevelop until the

film won't develop any more—or until the film is entirely black—no white showing. This may take 5 minutes or it may take 20. Thus I have turned this last troublesome variable into a constant. And lastly, the hypo rinse, when I use it, is carried out indefinitely, so that it, too, becomes a constant.

Thus from the above the reader will see that the only variables which I have left are the original exposure and the first development. There is no denying that they do go hand in hand. I do not believe that an exposure meter can be used satisfactorily with positive film. In the desert and high altitudes positive film will have a Weston rating of 24 or 32—that is, in the middle of the day. An hour before sunset the speed may fall to a Weston speed of 3 or 4. Now, you tell me when and where the change in

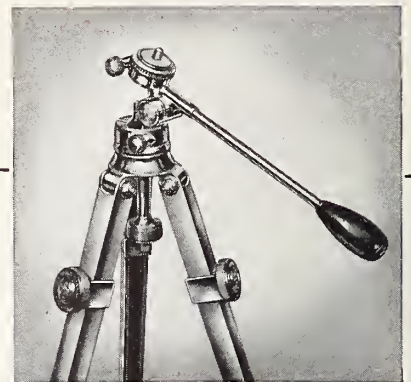

THALMETAL TRIPOD

A handsome, uniquely-styled, metal tripod worthy of the finest camera. The upper leg section is a rigid channel of polished metal, while the lower section is tough black hardwood. It is completely rigidized and fitted with Sure Foot Points. The Precision-built Pan-Tilt Head has full panorama sweeps, Instant-On Plug and is chromium finished. This tripod is outstanding in appearance—in serviceability—in dollar value.

Thalmetal Tripod, complete with Head \$14.00

THALHAMMER COMPANY

1015 W. Second St. Los Angeles, Calif.



COLD film snaps and breaks readily

VAPORATE

displaces water-content to resist brittleness resulting from COLD.

AVOID eye straining punishment from SCRATCHES, SPOTS and STAINS. Looking at your pictures should be a pleasure for you and your friends.

Fraction-of-a-cent-per-foot-cost. • Nationwide facilities through your dealer.

Better Photo Finishers offer VapOrate protection for still negatives.

VAPORATE CO., INC. 130 W. 46th St. New York
BELL & HOWELL CO. 1801 Larchmont Chicago 716 No. La Brea Hollywood

PROCESSING

100 Ft. 60c	50 Ft. 45c
25 Ft. 40c	3-30 Ft. 50c

Any make or type single, double 8 and 16mm film. Reversal or Negative. You may combine rolls to make 100' price. 8mm slitted free. Spools and cans returned.

REDUCTION 2c ft. — Minimum \$1.00
INTENSIFICATION 3c ft. — Minimum \$1.50
Other services and literature on Request.

NON HALATION FILMS

Dalite Loading — Free processing.
25 ft. Double 8mm \$1.00
100 ft. 16mm \$1.60

100' Bulk Dbl. 8 or 16mm \$1.10
Postage paid except on C.O.D. orders.

BRITE TONE MOVIE SUPPLY
Dept. D. 188 W. Randolph, Chicago

DRESS UP YOUR MOVIE TITLES

"A to Z" Figurettes
for movie title backgrounds

STICK 'EM ON — PEEL 'EM OFF
Figurettes may be used over and over again. Easily applied. Will stick instantly to any surface. Photographs perfectly with black and white or color film.

IT'S EASY — IT'S FUN
Complete \$1.00 Instructions
Assortment \$1.00 Title Distance Chart
FREE—Sample Figurette—Try It
JACOB STEIN (Mir.)
175 5th Ave., Dept. F New York City

30 FIGURETTES IN BRILLIANT COLORS

CORRECTION

• In the March issue of HOME MOVIES we erroneously reported that the Vaporate Company had announced arrangements had been made with several photographic dealers to provide Vaporate service to home movie makers. We are informed by the Vaporate Company that motion picture films can be Vaporated only at their regional plants located at key points throughout the country. We trust no undue inconvenience was caused our readers through this announcement.

rectly exposed or over-exposed, I don't bother with the hypo. In either event, the film is washed for several minutes, then hung up to dry.

And now a word about equipment. You can't build a house with a jack knife; neither can you do a good reversal job with two-bits worth of equipment. I use a solid, stainless steel drum, and believe that for best results the drum must be solid. I prefer the drum to tanks and racks, since I believe the results are better and also there is a great saving in developing solutions. The trays can be of any material, but should be paraffined or painted with acid-resisting paint. Running water is almost a necessity, the ideal set-up being to run the water in one end of the tray and out the other.

And that is about all I can tell you. Yes, I know it's awfully cut and dried, but if you walked into my laboratory right now and watched me develop a film, you wouldn't see anything but what I have told you. You'd swear you could go home and do an identical job, and yet the chances are you wouldn't get the same results, even using the identical solutions I have outlined. Why? For the same reason the artist can put a masterpiece on that canvas; yet you and I, with the same canvas, the same paints, the same brushes, do a miserable job. We know that as we practice and practice, our landscape slowly begins to look like the landscape in front of us. Yet what do we do differently? Something, yes; but whatever it is, we can't describe it—we can't see it. *It's an indefinable something that comes with practice.* And so it is with home reversal processing—not to such a degree, perhaps, but similar at least.

Some of you old-timers may say my procedure just outlined is such poor practice you wonder how I ever get anything presentable at all. My only answer is that my results are clear and sharp, free from streaks and stains, and when exposed correctly contain soft highlights with good detail in the shadows. What more does anyone want from home film reversal?

speed takes place! But under ordinary circumstances I should say a Weston 8 would hit it pretty squarely.

Assuming that the film has been exposed correctly, the image will be nicely visible in the first developer in one minute. At the end of three minutes it will be quite black, and at the end of the fourth minute it will be so black that you cannot tell what it is. This is the way it should look. I wash the film in running water for at least five minutes. From here it goes into the bleach, which I mix up as follows:

Hot water, 5 oz.; potassium bichromate, 96 gr.; sulphuric acid, C. P., 180 minims; cold water to make 45 oz.

I have found that the bleaching time will vary, but no matter how long it takes, the film is left in the bleach until all the black has disappeared.

I have never used a clearing bath, so cannot say whether they are advisable or not. Instead, I wash the film again in running water for several minutes—you can't over-do it—and then redevelop. The room light is turned on any time during the bleach and left on.

I use the same developer for the second developing as the first. I have tried other formulas such as D-76, D-72, etc., but I do not believe that the change is worth the difference, for the results are hardly any different. As mentioned before, I develop the second time until the film is entirely black without any whiteness showing. The hypo rinse is optional. If the film looks a bit dark, I usually give it a hypo bath, since this acts as a weak reducer. But if the film has been cor-

Protect OVER 200 SQUARE FEET OF FILM FOR ONLY 50¢

Against ... BRITTLINESS

Against ... FINGER PRINTS

Against ... SCRATCHES

Film Gard
FOR PRESERVING AND POLISHING FILM

FILMGARD is a combined Cleaner, Polish and Preservative; for use on negative or positive film. Penetrates and seals the emulsion—toughens the base. Permits sharper projection—protects from finger prints, brittleness and scratches. 2 oz. bottle, only 50c.

At your dealer—If he cannot supply you, order direct from closest distributor, giving your dealer's name and address.

See P & H products at Photographic Association of America Exhibit, Booth 148. August 19 to 23 incl.

Copyright 1940 P & H Corp.

P & H CORPORATION, 7000 Romaine St., Hollywood, Cal.

HORNSTEIN PHOTO SALES, CHICAGO • W. E. BOOTH COMPANY, TORONTO, CANADA
JOHN WORO CALOWELL, HONOLULU, HAWAII • FOTO MANTEL, MEXICO, O. F.
SINGAPORE PHOTO CO., SINGAPORE, S. S. • P & H CORPORATION, HOLLYWOOD
SCIENTIFIC INSTRUMENT CO., CAPE TOWN, SOUTH AFRICA

REVELATION

“Dated”

8mm MOVIE FILM 16mm

Top quality movie film at bargain prices. A DUPONT film. Packed and processed by Pacific Coast Film Company.

Special Introductory GET ACQUAINTED Offer...

REVELATION No. 1	Weston 12	Scheiner 20
A better grade outdoor film, non-halation, that provides wide latitude and softness of detail, takes sharp, clear, clean pictures of professional quality.		
30 ft. single 8mm for Univex, etc.....\$.75 each	2 or more.....	\$.60 each
25 ft. double 8mm	2 or more.....	1.25 each
50 ft. 16mm	2 or more.....	1.50 each
100 ft. 16mm	2 or more.....	2.75 each
All rolls on Daylite spools with ample leader footage. All above prices include reversal processing and postage.		
REVELATION No. 2	Weston 50-32	Scheiner 26-23
Panchromatic		
A super-sensitive, non-halation film, fine grain, extremely high speed. Clear, beautiful pictures, either indoors or out.		
30 ft. single 8mm for Univex, etc.....\$1.00 each	2 or more.....	\$.85 each
25 ft. double 8mm	2 or more.....	1.75 each
50 ft. 16mm	2 or more.....	2.50 each
100 ft. 16mm	2 or more.....	4.25 each
All rolls on Daylite spools with ample leader footage. All above prices include reversal processing and postage.		
SAVE on your movie film—make more pictures at less cost by buying direct by mail from the Pacific Coast Film Company.		
ORDER NOW!!		
C. O. D. Orders Postage Extra—Remit 1/3 With C. O. D. Orders Prompt, Reliable Service		
California Buyers Include Tax		

PACIFIC COAST FILM CO.

1510 North Sierra Bonita, Hollywood, California

35mm FOR CANDID CAMERAS: EASTMAN - DuPONT - AGFA

**YOU CAN'T GO WRONG—
WITH THE EFFICIENT**

Cinea 30

FILM SPLICER



**FAST AND
ACCURATE**

**PERFECT SPLICES FOR BOTH 8mm
AND 16mm SOUND OR SILENT FILM**

You can splice film easier with a Cinea 30—trim—scrape—splice—bing—bing—bing—just like that—no wasted motion. And you make more accurate splices, because five staggered pins and tightly fitting covers hold the film ends in exact alignment. The Cinea 30 is all metal with working parts under steel spring tension assuring clean splices and the pressure plate applies strong even pressure. Splices properly made are stronger than the film itself. You can't go wrong with a Cinea 30..... **\$10.00**

Cinea-WINDERS

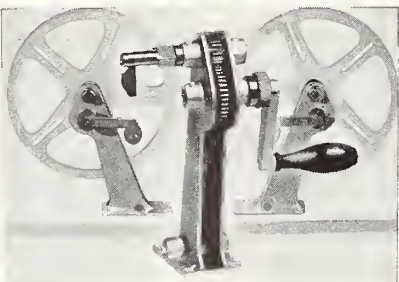

**HANDLE BOTH 8mm and 16mm REELS—
ADJUSTABLE TENSION AND DRAG**

This exclusive feature of adjustable drag on both winders prevents back spinning—leaves one hand free. Fine-cut gears and large, easy-grip wooden handles make operation smooth and quiet. Cinea-Winders take both 8mm and 16mm reels up to 800-foot. (Auxiliary bases which increase capacity to 1,600-foot reels are available.) For the best—insist on Cinea-Winders..... **\$9.00**



Cinea FILM CEMENT

The only film cement for all kinds of film—acetate or nitrate—35mm, 16mm, or 8mm. Cinea Cement is odorless, slow to evaporate from corked bottle, yet it joins film quickly and securely. At all better photographic stores, per bottle **25¢**

See your dealer or write to:

AMERICAN BOLEX CO.
155 EAST 44th STREET • NEW YORK

Movie of the Month...

• Continued from page 179

and his partner on horseback traveling through picturesque rolling hills. Close-ups are plentiful, and the one of El Lobo reading the sheriff's notice posted on a tree is well done and properly timed in relation to the telling of the story.

As they near the cabin, El Lobo sends his partner to the cabin with a note addressed to the girl's husband and supposedly written by the sheriff summoning him to a search for the bandit, El Lobo. This ruse is successful in drawing the husband from the house and as soon as he leaves, El Lobo comes out of hiding and enters the cabin.

The girl is terrified. El Lobo attempts to make love to her. She repulses him. They battle together for some time, then suddenly El Lobo hears the clatter of hoofs as the husband, having discovered the trick, returns home. The husband enters the cabin apprehensively, only to find his wife safe. As he takes her in his

arms, El Lobo, in typical bandit fashion, swaggers from behind a drapery with guns drawn, ordering the couple to raise their hands. The girl introduces El Lobo to her husband as "a friend," and when it is apparent to the bandit that his identity is unknown to the husband, he drops his guns, shakes hands and offers cigarettes.

Presently there is talk about El Lobo, and the husband remarks that he would like to capture him so they might have the reward for the baby that is coming. News of the expected baby is a keen disappointment to El Lobo, who had hoped to take the girl away to be his bride. El Lobo's disappointment, coupled with increased vigilance of the sheriff, which makes his capture imminent, prompts him to make a decision. Apparently with softened heart, he prepares to depart alone, saying that he will leave "something outside for the 'leetle' one."

Bidding the couple adios,

Movie of the Month

• Each month the Editors of HOME MOVIES select the best picture sent in for analysis and designate it "The Movie of the Month." This movie is given a detailed review and a special leader is awarded the maker.

This award does not affect the eligibility of such films for entry in the annual HOME MOVIES CONTEST. They are automatically entered for rejudging with those films submitted especially for the annual contest. Films awarded the honor of MOVIE OF THE MONTH during past 12 months are:

1939

MAY: "Africa," produced by Mrs. Albert Heekin, Cincinnati, 16mm picture approximately 900 ft. long.

JUNE: "Alaska Cyclorama," produced by R. C. Denny, Fresno, Calif. 16mm picture approximately 800 ft. long.

JULY: "Behind the Dial," produced by Robert C. Orr, Mt. Kisco, N. Y. 16mm picture approximately 400 ft. long.

AUGUST: "New England Holiday," produced by Albert Watts, Buffalo, N. Y. 8mm Kodachrome picture, 800 ft.

1940

JANUARY: "The Cauldron," produced by Dr. R. E. Gerstenkorn, Beverly Hills, Calif. A 16mm picture 400 ft. in length.

FEBRUARY: "Whistling Wings," produced by W. H. Nordin, Austin, Minn. A 16mm Kodachrome picture, 400 ft. in length.

MARCH: "Checking Off the Budget," produced by B. W. Johnson. An 8mm Kodachrome film, 1000 feet in length.

APRIL: "El Lobo," produced by Demetris Emanuel. A 16mm picture, 400 feet in length.

Save ON PHOTOGRAPHIC EQUIPMENT

Write for our **FREE CATALOG** no obligation!

Our large turn-over permits us to sell for less! Complete line of "Still" and "Movie" equipment.

SUNNY SCHICK

National Brokers
403 W. WASHINGTON BLVD.
FORT WAYNE, INDIANA

MODERNIZE—Trade in Your Equipment!

Save Money... Use

8mm BULK FILM 16mm

Fine grain, Semi-ortho, Non-halation Weston 8. For titles or reversals. Lab. packed. Free formulas each order. All film guaranteed fresh stock—not re-perforated positive. Calif. buyers include sales tax.

400 ft. STRAIGHT 8mm for UNIVEX, KEYSTONE, etc. **\$3.50**

800 ft. 8mm in dbl. 8mm widths for all dbl. 8mm cameras. **\$5.00**

400 ft. 16mm. **\$4.75**

SPOOLS—Univex, 5 for \$1.00. Dbl. 8mm, ea., 40c. 50 ft. 16mm, ea., 40c. 100 ft. 16mm, ea., 50c.

Write for Big Free Bulk Film Catalog

HOLLYWOODLAND STUDIOS
THE WEST'S GREATEST FILM MAIL ORDER HOUSE
SOUTHGATE, CALIFORNIA

TITLES BY PARK CINE

Complete Titles on appropriate backgrounds to professionalize your home movies. Compose your own TITLES... we hand-set them on backgrounds you select from our catalogue, sent you FREE on request.

Yet these artistically photographed Titles cost no more than typewritten Titles. Priced at 25c for genuine hand-set printed Titles and only 35c for Art Background Titles.

PARK CINE LABORATORY

120 West 41st St.

New York

16 mm Films Duplicated

Have a duplicate negative or positive reel made from your cherished 16mm films before sprocket holes are damaged or your treasured prints are ruined beyond the possibility of duplicating. Duplicating 16mm, per foot, 2½c. Minimum charge (50 feet), \$1.25. We do all types of film processing. Write for lists.

AMERICAN FILM CORPORATION
6227 N. Broadway Chicago, Ill.

REDUCTIONS

ENLARGEMENTS
DUPLICATES

**GEO. W. COLBURN
LABORATORY**
1197 MERCHANDISE MART
CHICAGO

DAYLITE LOADING

BULK FILM FOR ALL 8mm and 16mm CINE CAMERAS - SPOOLED READY FOR CAMERA USE FREE.

State Make of Camera Please

ESO-S CINEFILMS
3975 Menlo Los Angeles, California

MAKE YOUR OWN TITLER!

For all types of titles, close-up and copy work. Complete kit of finished parts—optically ground lens—easy instructions. Assemble in 15 minutes! Money Back Guarantee. State camera model.

Distinctive Title Card—"Photography by (your name)"—35c.

ONLY \$1.65 IN KIT FORM

For All 8 or 16 MM CAMERAS

HOLLYWOOD MOVIE SUPPLY COMPANY
NORTH HOLLYWOOD • CALIFORNIA

he exits. Outside we see him contemplating his next act. With a final look at the sheriff's notice offering the reward for his capture, El Lobo draws his gun and shoots himself. The couple, alarmed by the shot, rush outside and find El Lobo dying at their doorstep with the sheriff's notice clasped in one hand. The girl holds El Lobo's head tenderly as he breathes his last. The sheriff happens along at this moment, recognizes El Lobo and declares the couple entitled to the reward.

We believe it will be evident, from this short synopsis, that filming "El Lobo" was something of an undertaking for an amateur. Yet it is a story any serious amateur might have filmed. The story not only provided wide latitude for the actors' and directors' abilities, but opportunity for exploiting one's ingenuity for costum-

ing, makeup, set building, and decoration. Emanuel did a swell job in all departments. He collaborated on the script, directed and photographed the picture, and played the part of "El Lobo"—in addition to constructing the interior sets, as previously described.

Photography is exceptionally well done. The interior shots appear somewhat flat and grainy but this is due entirely to the low speed film used in the early filming of these scenes. The lighting of the interiors, however, is highly commendable.

As fine a job of editing we have not seen in a long time and the titles—except that some of them are a little shy of footage—are excellent. All were hand lettered in a rustic manner so suitable to the story, and each carried some symbolic decoration.

**MORE
OOMPH
FOR YOUR
HOME MOVIES**



with the
CRAIG PROJECTO-EDITOR

It takes proper **Editing** to make modern fast-moving, interest-sustaining movies. **ACTION-EDIT** your films the Hollywood Studio way — transform random shots into smooth-running sequences that everyone will enjoy seeing.

The Projecto-Editor provides a unique viewing method — allows careful inspection, slow motion if desired, of **every** movement on its brilliant miniature screen. Films may be readily removed from the polished guides for quick cutting and splicing.

At all dealers — Ask for demonstration.

8mm. model, complete . . . \$27.50
16mm. model, complete . . . \$49.50

CRAIG MOVIE SUPPLY COMPANY

1053 S. OLIVE ST. • LOS ANGELES, CALIF.

"Makes Editing a Pleasure"

Craig Safety Film
Cement—25c



FOR NEW IDEAS AND SHORT CUTS

in home movie making, read Movie Kinks No. 1 and Movie Kinks No. 2—two valuable books chock full of time and money saving ideas.

25c Copy

VER HALEN PUBLICATIONS, 6060 Sunset Blvd., Hollywood, Calif.

"Pros" effect tricks no secret . . .

• Continued from page 168

began as a clear celluloid, and in which an opaque area of the correct outline would appear at the left and move across the frame, effectively blacking out its image from the re-photographing lens of the camera.

The matte for the second scene would be printed from this first matte, and would therefore be identical with it except that the clear and opaque areas would be reversed. After the film in the camera head has been rewound, following the first printing operation, this second matte will "black" out the parts that have already been exposed, and let the second scene register on the unexposed areas. Since the two mattes match perfectly, if the several films are started each time at the correct starting point, the result will be a wipe with a perfect blend between the two scenes that are being wiped. Of course, from this basic idea, an infinite number of combinations can be evolved, resulting in wipes and other transitions that can be as spectacular as anyone could wish.

The same general procedure is followed in making superimposed titles. And let

me tell you, in watching the way our title crews make trailer titles, I've learned a lot that has been helpful in my own 8mm work! First of all, the professional uses really large title cards which can be lettered much more easily than small ones; the average size is about 14x20 inches. (I don't carry things quite so far as following this in my 8mm, but I do use cards about 6x8, which I've found far better than the tiny "calling-card" sizes used in most titlers.)

Whether the title is to be used as a superimposed title "doubled" over an action scene, or simply as a plain title with white lettering on a black background, it is vital to have a really flat black card, and to use ink that is genuinely white. You can get both at most artists' supply stores; but be sure your black card is a really smooth, flat black. If it is a glossy black, it will pick up reflections from lamps, etc.; if it is on an ordinary dull-black stock, you're likely to find that there's enough texture in the slightly rough-surfaced paper to catch the light and give you a grayish background instead of the husky black you want. In the same way, many of

FOR 100%
EYE CUE

THE *New*
RAYGRAM BEADED SCREEN

wins this high rating because it gives a new sparkle and clarity to your home movies. Assures professional sharpness of image . . . equipped with semi-automatic frame. When screen is pulled out of case it automatically stands erect . . . a slight pull on the release cord closes it.

Graded blue white glass beads impart brilliant realism. High quality Dupont screen cloth and coated back make for theatre perfection. Black nickel hardware . . . solid leather handle makes it a handsome addition to your photographic equipment.

22 x 30" . . . \$10.00 36 x 48" . . . \$16.50
30 x 40" . . . \$12.50 39 x 52" . . . \$20.00

AT ALL LEADING DEALERS



RAYGRAM CORP. 425 FOURTH AVE.
NEW YORK CITY



Easy to operate . . .
requires only one
hand to open and
to close.

TRUE WESTON SPEEDS

Complete New Reversal and Title Instructions Free With Film Orders. Separately 25c each. Cash, Check or M. O. With Order For Quick Service, or C.O.D. Air Mail 50c Extra. Special Delivery 15c. Overpayments refunded.

SUPER CINEPAN REVERSAL

Weston 24-16—Violet Non Halation Base	
33 ft. Double 8 Not Scored	\$ 1.25
100 ft. Double 8 Not Scored (16mm \$ 3.25)	3.75
400 ft. Double 8 Not Scored (16mm \$11.75)	12.00
33 ft. Straight 8	.80
100 ft. Straight 8 — One Piece	2.15
400 ft. Straight 8 — 4-100 ft. Pieces	6.75

CINECHROME REVERSAL

Weston 8-2—Violet Non Halation Base	
33 ft. Double 8 Not Scored	.75
100 ft. Double 8 Not Scored (16mm \$ 1.75)	1.85
400 ft. Double 8 Not Scored (16mm \$ 5.50)	6.00
33 ft. Straight 8	.50
100 ft. Straight 8 — One Piece	1.15
400 ft. Straight 8 — 4-100 ft. Pieces	3.50

Super Cinepan & Cinechrome are Factory Perforated. Fully Daylight Loading When Spooled. Processing and Camera Spools, Extra.

SUPER PANCHRO REVERSAL

Weston 24-16—Anti-Halo Backing	
33 ft. Double 8 Not Scored	\$ 1.35
100 ft. Double 8 Not Scored (16mm \$ 3.50)	3.75
400 ft. Double 8 Not Scored (16mm \$12.50)	13.00
33 ft. Straight 8	.85
100 ft. Straight 8 — One Piece	2.25
400 ft. Straight 8 — 4-100 ft. Pieces	7.00

Super Panchro is Repertorated 16mm for 8mm Cameras. Satisfactory in All 8mm Cameras except Keystone 8 and Stewart-Warner 8 Cameras. Daylight Loading when Spooled as Colloidal Silver Backing Process. Spools and Processing Extra.

WESTON 8-2 SEMI-ORTHO REVERSAL

Weston 8-2 Darkroom Loading—Processing Extra	
33 ft. Double 8 Scored—Clear or Lavender	.60
100 ft. Double 8 Scored—Clear or Lavender	1.50
400 ft. Double 8 Scored—Clear or Lavender	4.00
33 ft. Straight 8—Clear or Lavender	.40
100 ft. Straight 8—Clear or Lavender	1.00
400 ft. Straight 8—Clear or Lavender	2.75
100 ft. 16mm. All Tints Available	1.15
400 ft. 16mm. All Tints Available	4.00

Clear, Lavender, Amber, Blue, Yellow. Factory Perforated. Works Perfectly in ALL Cameras.

CINE-KODAK POSITIVE TITLE FILM

Darkroom Loading—Processing Extra	
33 ft. Double 8—Not Scored	\$.60
3-33 ft. Rolls. Your Choice Assorted Colors	1.50
100 ft. Double 8—Not Scored	1.35
400 ft. Double 8—Not Scored	4.10
33 ft. Straight 8	.46
3-33 ft. Rolls. Your Choice Assorted Colors	.95
100 ft. Straight 8—One Piece	.99
400 ft. Straight 8—In 4-100 ft. Pieces	2.15
100 ft. 16mm. In One Piece	1.00
400 ft. 16mm. In One Piece	4.00
25 ft. 35mm. Safety, Clear or Purplehaze	1.00
100 ft. 35mm. Safety, All Tints Available	3.00

Clear, Purplehaze, Yellow, Red, Amber, SPECIAL Blue. Also Lavender and Salmon Pink, DuPont make.

CAMERA SPOOLS WITH CANS

Double 8	ea. \$.35	Filmo St. 8	ea. \$.50
Univex St. 8	ea. .20	16mm. 50 ft.	ea. .35
Keystone St. 8	ea. .35	16mm. 100 ft.	ea. .65
Extra Cans, 100 ft. and 50 ft. 16mm size	.10		
Extra Cans, Double 8 and Straight 8 size	.05		
Non-Humidor Cans, 400 ft. 25c ea. 6 for	1.00		

MISCELLANEOUS

BAIA Precision 8mm Film Sitter, All Metal	\$ 2.50
FOTOFAB DYE, 16mm bottles	1.00
FOTOFAB WIPE-OFF TAPE, Waterproof, per roll	.60
CINETINTS, Set of 6 COLORS and Instructions	3.00
BOLEX CINELAC, Film Preservative, bottle	1.00
DUPONT VISCOSE SPONGES, each	.35
HOW TO TITLE HOME MOVIES, Complete bk	1.00
HOME MOVIES, Back Issues, 1936-37-38-39	.15
(Not All Months) Back Issues for 1940 ea.	.30
FILM PROCESSING: Eastman 8, \$1.00; Other Types 65c; Straight 8, 35c; Eastman 16mm \$2.00; Other Types \$1.50. TITLE DEVELOPING, 16mm \$1.25 per 100 ft.; Double 8, 75c; Straight 8; 40c per 30 ft. rolls.	

A Personal Movie Service

Also Available Evenings, Sundays and Holidays. Telephone Lincoln 1207.

W. Stuart Bussey Film Lab.

17 E. St. Joseph St., Indianapolis, Ind.

Paillard-BOLEX on CREDIT
World's Finest 16mm and 8mm Motion Picture Cameras
ONLY \$64.50 DOWN
12 Months to Pay

Enjoy the finest advantages of "professional" cameras—fades, superimposition, lap dissolves, animation, slow motion, etc. Get terms to suit you, as little as \$21.31 a month. BOLEX cameras are complete, there are no costly "extras" to buy. F/1.5 lens and carrying case. With Leitz Hektor Rapid F/1.4 lens, \$20.00 additional. Write for details to Dept. HM-4.

Trade In Your Old Camera—
Liberal Allowance

FORDHAM ELECTRIC CO., Inc.

2563 Webster Ave. New York City
(One-Half Block No. of Fordham Road)

the so-called "white" paints on the market aren't a true white, but tend to be grayish or more often yellowish. They'll photograph gray—light, perhaps, but sufficiently off-color to be disappointing.

In making "trailers" for theaters we photograph our titles on high-contrast positive film, and use the old mercury-vapor lamps to light the job. I tried using the same lighting set-up with my 8mm, using a popular 8mm "title-positive" film. This film, I found, is of the "color-blind" variety, highly sensitive to blue and ultra-violet light but almost blind to light of any other color. Under ordinary photofloods, which haven't very much blue in their radiated light, it is very slow, with a Weston speed of about 2. But under the mercury-vapor lamps which are strong in blue and ultra-violet, I use a Weston speed of 12 when I take a reading off a white card. This enables me to stop down plenty and get depth and definition I couldn't hope to get otherwise. It also lets me photograph the relatively large cards I use (6x8 inches) with a fixed-focus 12½mm lens at about 18 inches distance without any supplementary lens, and still get good, sharp titles. I'm planning to build a titler for home use, equipped with a pair of small mercury-vapor tubes such as can be gotten from any neon sign shop.

Choosing the right style of lettering for each title card is just as important in trailer-making as choosing the right words. A smart, modern letter fits a modern picture like "Irene"; strong, bold letters are more appropriate for a film like "Grapes of Wrath"; a film

"Finland Fights" ...

• Continued from page 178

by fear for their lives, are seen in bomb-shelters and hurriedly gathering together for mass evacuation from the city.

"Finland Fights" also gives one a closer understanding of the strategy so successfully employed by Field Marshal Mannerheim in meeting the invaders of

with a "gay nineties" background can make excellent use of highly ornate, "gay nineties" lettering, while for a "western" a rough, sweeping letter is best. In fact, if the title-lettering artist is clever, he can make the lettering itself suggest a great deal of the atmosphere of any picture before a single scene is shown.

Some of you may argue that what we have been describing here applies to the specialized production of trailers. Quite true; but—all of these tricks or effects had their origin in the studios and were and continue to be used in film productions. Essentially tools for creating or imparting emphasis, they have been found ideally suited to trailer production where, as intimated before, the brief message must be put over with a punch.

You can use wipe-offs and zoom effects, for instance, in your home movie productions, and by doing so materially step up their class. But, of course, such effects must be properly used. A zoom effect, for instance, properly belongs in a main title, not in the subtitles, except where some exceptional exclamation is made. Wipe-offs should be used with discretion. Properly placed, they are more effective than any other method of transition. Flop-over effects belong in main and introductory titles.

It is because these effects are used so judiciously, and therefore sparingly, in standard film productions, that we have chosen the trailer as a medium of study of professional cinematic effects. Amateurs interested in developing their "effects" technique will do well to study the "trailers" on their theater screen.

his country. The action of his wonderfully trained forces is seen bringing down Russian planes; sniping Reds in the air as they attempt the landing of forces on Finnish soil by mass parachute jumps from flying planes; ambushing a division on narrow roads in the Karelian area and cap-

Tex Ritter
and his horse "White Flash"
In the NEW
MUSICAL WESTERN FEATURES
"Rollin' Plains" & "Utah Trail"
6 Reels Each on 16mm Sound Film
Controlled Exclusively by
POST PICTURES CORP.
723-7th Avenue New York
Catalogue Sent on Request

Absolutely FREE
HOME MOVIE TITLING KIT
Create Big Theatre Effects
The "TRY IT YOURSELF" KIT
Includes 36 Initials • 1 Alphabet
Numerals • Decorations • Tracing
Paper • Background Board.
Complete Sample Title
Send TODAY for YOUR KIT
FREE
"A TO Z" TITLING OUTFIT
• ONLY \$2.00 COMPLETE •
at Your Dealer or Send Direct to
STEIN STUDIOS
175 Fifth Avenue Dept. H12 New York, N. Y.

ECONOMICAL OUTDOOR MOVIES
Double 8mm — Weston 6 — 16mm
"SUN AMBER"
A Non-halation—Reversible Safety Film
25 ft. DOUBLE 8mm \$.85 per roll
50 ft. 16mm . . . 1.00 per roll
100 ft. 16mm . . . 2.00 per roll
REVERSAL Processing and POSTAGE INCLUDED
California Buyers Include Sales Tax, Please
PACIFIC COAST FILM CO.
1510 North Sierra Bonita Hollywood, Calif.

BETTER Home Movies
when you use
Write Wonderlite
for our price list. Photo Lamps
WONDERLITE CO. 14-H Northfield Ave.
WEST ORANGE, NEW JERSEY

Kodachrome
MAPS *Charts* FINE TITLES
Geo. W. Colburn Laboratory
Special Motion Picture Printing
1197 Merchandise Mart, Chicago

Better Movies with BLACK and WHITE FILM
Reversible Film 98c Includes
25 ft. Obl. 8mm Processing
Rating Weston 12 Scheiner 18
At your dealer or direct. Fast
service processing same day in-
cluded at no additional cost.
VISUAL INSTR. SUPPLY CO.
1757 B'way Box H12 B'klyn, N. Y.

HOT OFF THE PRESS
16mm SILENT AND SOUND-ON-FILM
RENTAL LIBRARY CATALOGUE
Films Shipped Anywhere—Large Selection
Write Today for Your Copy
NATIONAL CINEMA SERVICE
71 Telegram Sq. New York City

ONYX
FILM SAVES YOU MONEY
100 feet 16mm \$2.60
25 feet double 8mm \$1.20
30 foot Univex reload .65 cents
No additional charge for processing.
Daylight loading spools.
Immediate service by return mail.
KENWOOD FILMS 1238 E. 46TH ST.
CHICAGO, ILL.

IF IT'S TITLES . . .

(A 15-second quiz)

Ques.: Are you a "do your own" fan?

Ans.: Ciné Shop has bulk film for titles at \$1 per 100', double 8mm, single 8mm (two 100' slit sections), and 16mm.

P. S. — A sample kit just out has 25' lengths each of clear, amber, yellow, daylight blue bases, costs \$1.25 postpaid.

Ques.: Are you an artist?

Ans.: The Ciné Shop photographs your titles, drawings and photos on film at a nominal charge.

Ques.: Are you strictly a filmer, without time or equipment to make your own titles?

Ans.: The Ciné Shop makes high grade titles for professional productions and personal films.

Write Now for Complete Information

Ciné Shop

1812 Piedmont Charleston, W. Va.

Buy GENERA in BULK
DOUBLE 8 SCORED
SEPARATES WITHOUT SLITTING
Single 8, Double 8 & 16mm

NEW FILMS for YOU DAYLIGHT LOADING

WITH BLACK ANTI-HALO BACKING THAT ELIMINATES THE USE OF SPLICED AND PAINTED LEADERS

No more leaders to splice or paint. Simply fill empty spools. Anti-halo backing comes off in processing. Use these FAST high quality fine grain reversible Motion Picture Films at amazing low prices. Have great latitude and color correction. Order yours today.

	Normal	Fast	Super
WESTON 12-16-24:			
100 ft. Single 8 for Univex, etc. . . .	\$1.90	\$1.95	\$2.10
25 ft. Double 8 in Tin Can90	.95	1.10
100 ft. Double 8 in Tin Can	3.25	3.30	3.45
50 ft. 16mm on Spool in Can	1.65	1.75	1.90
100 ft. 16mm on Spool in Can	3.05	3.10	3.15
400 ft. 16mm in Film Can	11.75	11.80	11.85

PROFESSIONAL REVERSAL PROCESSING

100 ft. 16mm Ortho \$1.00 100 ft. 16mm Pan \$1.25
25 ft. Dble. 8 Ortho .50 25 ft. Dble. 8 Pan .60
Simplified Processing Outfits, including our Prepared Powders: For 30 ft. Single 8, \$3.55, postpaid; Dble. 8 and 16, \$4.95, express. Instructions are FREE.

Send stamp for Film sample, catalog and Bargain List.
FROMADER GENERA COMPANY
MOVIE DEPT. DAVENPORT, IOWA

16MM

DuPont Regular Pan Film
Motion Picture
Makes Better Home Movies at Less Cost

Standard speed, FULL PANCHROMATIC sensitivity, wide latitude, fine grain. Has all qualities of costlier black and white films except extreme speed. Excellent for normal outdoor shooting or indoors with photo-floods. Can be used with filters. Calif. buyers include sales tax. Including Reversal Processing 100-ft. roll **\$4.50**

Write for Free Bulk Film Catalogue

HOLLYWOODLAND STUDIOS
SOUTH GATE CALIFORNIA



FADES, WIPES Can be added to your Reels after Processing WITH FOTOFADE on black and white or color films. Price \$1.00. Waterproof Wipeoff Tape, 60¢ per roll. Complete Fotofade Kit \$1.60
CINETINTS for coloring your 16mm or 8mm film. Set of six colors \$3. At your Dealer or direct.

DYE RESEARCH LABORATORIES
318 Jackson Street Los Angeles, Calif.

GLASS-BEADED MOVIE SCREENS
Easily Made!

Make your own sparkling beaded screens—at a fraction of their usual cost! Crystal beads can be applied to cloth, cardboard or almost any smooth surface. Complete directions with each pound. (No fractions of pounds sold.)
Glass Bead to cover 20 sq. ft. (1 lb.)
Finest Size \$1.25
D. GARD, C2, 54 WEST 74th ST., NEW YORK CITY

turing huge quantities of tanks, artillery, and other valuable military supplies.

It shows Russian prisoners, taken by the thousands, pitifully under-clad for biting 40-below zero weather. How the Finns have been taught to enlist nature's trees and snows into an important part of their defense plans is seen as troops cheat a raiding Red plane by "melting" into the trees of their protective woods. Particularly striking are the shots of the famous, white-clad ski patrols of the Finnish army, rushing into action as word comes that a Russian division has been trapped. The burning of their own homes by the Finns in the Petsamo sector also is shown, this being a measure to further hamper the enemy.

The Russo-Finnish war

has fortunately come to an end. It will go down in history as one of the greatest ever fought, particularly because it definitely exposed the weakness of a hitherto believed much superior power. It is a subject that will be discussed time and again not only in homes throughout the country but in schools and other institutions. To be able to screen movies of this remarkable event right in your own home is a privilege available to every owner of an 8mm or 16mm projector — modern magic made possible by the medium of motion pictures.

In all respects — photographically, historically, dramatically — "Finland Fights" is about the most important and valuable news home movie ever to be released.

Tip for filming "Ghosts" . . .

• Continued from page 177

at "B," is facing a vacant chair at "AA." Suddenly the image of another man appears sitting in the chair at "AA." The man at "B" registers surprise, arises, and walks over to "AA," and attempts to engage the "ghost" in conversation. Then the man walks around to the back of the chair, picks it up and walks off stage with it. The "ghost" remains in the scene in sitting position, apparently suspended in mid-air, and watches the chair being carried away from under him. Then the "ghost" arises and walks out of the scene — gradually evaporating into this air.

This effect is obtained

by placing the "ghost" in a chair draped with a black cloth at position "A" (Fig. 1). In addition to the black cloth drape which covers the chair, the "ghost" is seated on another piece of black material which he uses at the close of the shot to draw about him as he emerges from the scene in order to produce the "evaporation" effect. The image of this ghost in reflected into the glass panel and within camera range, as shown. Two strong lights are used — one on the man and one directed against the "ghost" who is seated facing the glass panel.

To fade the "ghost" in and out, it is necessary to

• All Amateurs, whether subscribers of HOME MOVIES or not, are invited to submit their films to the editors for review and helpful criticism. Unless otherwise requested, reviews of some of the films which we believe would benefit other amateurs will be published each month.

Reviewed films will be rated one, two, three, and four stars, and films qualifying for two or more stars will receive free, an animated leader indicative of such award. Detailed reviews, with suggestions for improvement — if any — will be mailed to amateurs submitting their films.

Exceptional films qualifying for the distinction of the "Movie of the Month" will be treated in detail in a feature length article in a following issue of HOME MOVIES. In addition, a certificate evidencing the award of "Movie of the Month" and a special animated "Movie of the Month" leader will be returned with such films after review.

When submitting films for review and analysis, please advise make of camera, speed of lens, whether or not tripod was used, or if you used filters, exposure meter, or other accessories. While this information is not essential to obtain analysis of your film, we would like to pass it on for the benefit of other amateurs.

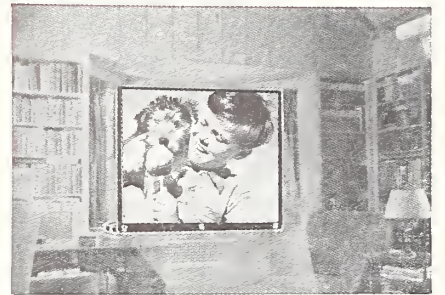

Your Screen Is the Stage of Your Home Theatre

. . . whereon your achievements are displayed. To a spectator, the various phases that enter into the making of a picture are of secondary importance. He is concerned with its appearance on the screen. A Raven Screen, in one of the many types, sizes and materials that are available will provide you truly professional performance and will reflect your ability as a "producer" in a manner that is most creditable.

Investigate the Superiority of Raven Screens at your local dealer's or send for Folder 52.

RAVEN SCREEN CORPORATION
314 East 35th Street New York



GOERZ KINO-HYPAR LENSES
f:2.7 and f:3
For regular and color movies of surprising quality — high chromatic correction . . .
Focal lengths 15mm to 100mm — can be fitted in suitable focusing mounts to Amateur and Professional Movie Cameras.

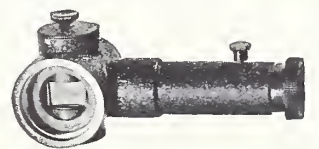

GOERZ Reflex FOCUSER

— Patented —

For 16mm Movie Cameras — voids PARALLAX between finder and lens — provides full-size ground-glass image magnified 10 times. Adaptable to lenses 3" and up. Also useful as extension tube for shorter focus lenses for close-ups. Extensively used in shooting surgical operations, small animal life, etc.

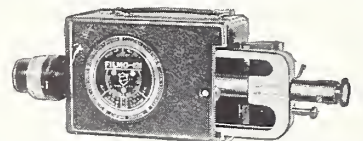

GOERZ Parallax-Free FOCUSER and FIELD FINDER CONTROL

No more off-center pictures, for Filmo 121 and Simplex-Pockette magnifies 4 and 8x.

For Detailed Information Address Dept. HM-4

C. P. Goerz American Optical Co.
317 East 34th St., New York
American Lens Makers Since 1899

**PEERLESS
"PLUS+VIOLET"
REVERSIBLE MOVIE FILM
ASSURES YOU OF
BETTER MOVIES**

"PLUS+VIOLET" is the kind of film you have often wanted but have been unable to find in its class price.

"PLUS+VIOLET" is a medium speed (Weston 12, Scheiner 20), fine grained outdoor type film with wide latitude anti-halo backing and a special base which filters out all of the low frequency rays of the projection lamp, giving upon the screen a more brilliant and pleasing picture. "PLUS+VIOLET" is not just another cheap film at a low price, but is a SUPERIOR film in the low price class. It is offered as a splendid film for those who wish to get good results on a limited film budget.

A trial will convince you that "PLUS+VIOLET" will enable you to take more and better shots for less money. Order today one or more trial rolls of "PLUS+VIOLET" at these attractive prices:

- 30 ft. 8mm for Univex. 60c
2 rolls for \$1.00
- 25 ft. double 8mm \$1.00
4 rolls for \$3.50
- 100 ft. 16mm \$2.35
4 rolls for \$8.00

Above prices include generous extra footage for leaders, daylight loading spools, processing, projection reel, and return transportation.

**"PLUS+VIOLET"
PANCHROMATIC**

A high speed fully panchromatic "PLUS+VIOLET" reversible film with a speed rating of Weston Daylight 32 and Mazda 20—Scheiner Daylight 24 and Mazda 22. 100 feet 16mm on daylight loading spool, including processing, \$4.50, or 3 rolls for \$12.00 (8mm not available).

SPECIAL TRIAL OFFER

One 100-foot 16mm roll each of our regular "PLUS+VIOLET" and one roll of our Panchromatic "PLUS+VIOLET"—a \$6.85 value for only \$5.00.

ALSO SOLD IN BULK

Write for Descriptive Circular and Price Lists

Sold Only by

PEERLESS of HOLLYWOOD
P. O. BOX 1310-H
HOLLYWOOD, CALIFORNIA

connect the light used at "A" with a variable or dimming rheostat that can be operated off-stage during the shooting. As the ghost is wanted to appear in the scene, this light is turned up to full brightness. This procedure is reversed for a fadeout.

The action of the "ghost" should be slow and deliberate. Very white make-up should be used to obtain maximum image reflection, and, of course, to obtain the best ghost-like expression. The entire set should be bordered with black drops and they should continue around the left of the set with an opening to permit exit of the "ghost" at the close of the scene.

If you wish to ghost in only certain parts of the image, such as his hands,

feet, etc., you can do this by draping the rest of the body in a black cloth, leaving only the wanted portion exposed to reflection in the glass. For a quick appearance or disappearance of the "ghost," merely "wipe" him out of the scene by drawing a black cloth before him.

You will note that the reflected image is placed at the same angle and distance in the back of the glass as the real object is in front of the glass. An inversion of objects from right to left, or vice versa, will take place and must be anticipated when planning the shot.

A simple trick effect like this may be successfully handled in a limited space by using a short focus lens at its widest opening.

Device speaks titles . . .

• Continued from page 176

the contact of the Voca-Titler with another notch in the film.

In the same manner, special sound effects may be recorded in conjunction with projection of film—the mechanism operating in the same way for the duration of the sound effect on the record.

Undoubtedly, ingenious amateurs would find a way to hook up a second turntable, thereby enabling him

a complete musical accompaniment during screening of the film. As the record on the turntable controlled by the Voca-Titler played the titles, the musical record could be faded out or temporarily "dimmed" by manual operation of the rheostat or "fader."

Digging up old files of personal films and adding a "voice" to them will serve to make modern movies of these old and probably for-

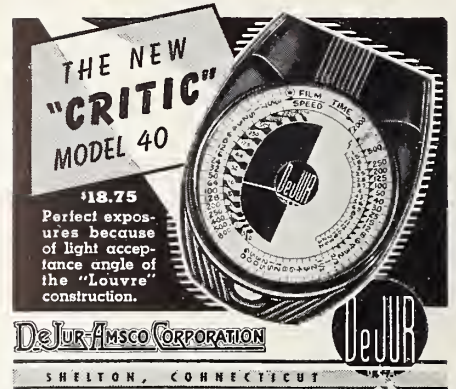

16MM TITLES
10 Words 25¢ Background Free
2c for each additional word.

8MM TITLES
Backgrounds Free
Reducing * Enlarging
ILLUSTRATED CATALOGUE
GENERAL CINE SERVICE
204P East 18th St., New York

WESTON 8 ORTHO BULK FILM
400 ft. double 8mm scored . . . \$3.50
400 ft. 16mm \$3.50

8mm SLITTER
Slits perfectly 16mm width film to exact 8mm width. Die cast body with hardened steel cutting wheels. New price, each, \$2.50.

DEVELOPING RACKS
Stainless steel, take 30 feet 16mm or 8mm width film. Can be used in 11x14 or 8x10 flat trays respectively. Complete with loading stand, each, \$6.75. Specify type wanted.

At Your Dealer's or Direct
J. C. Haile & Sons
Motion Picture Dept.
215 Walnut Street Cincinnati, Ohio

Bass says:
Shoot from the hip with this **VICTOR 5**
Every shot tells with this superb 16mm camera . . . with 1" F:1.5 lens; 5 speeds, adjustable parallax, geared motor, interchangeable lens mount, hand cranks, 3-year factory warranty.
Formerly \$197.50 at . . . \$137.50
Send for complete Cine Bargaingram listing everything of interest in movies. Free.

BASS CAMERA CO.
179 W. MADISON ST. CHICAGO, ILL. Dept. H. M.

8mm-BULK FILM-16mm
Save Money! LOAD YOUR OWN
Laboratory Packed Fresh Stocks Guaranteed
Non-Halation Fine Grain
(A Dupont Film) Weston B
400 ft. Straight 8mm (for Univex, Revere, Keystone, etc.) . . . \$3.25
800 ft. 8mm for double 8 widths for Laboratory Packed Fresh Stocks Guaranteed double 8 cameras . . . 5.00
400 ft. 16mm 4.25
Postpaid (California buyers include sales tax)
Spools—(Univex) 5 for \$1.00
Double 8 each 35c
50 ft. 16mm each 35c
100 ft. 16mm each 50c

PACIFIC COAST FILM COMPANY
PACIFIC COAST FILM
1510 N. Sierra Bonita Hollywood, Calif.

**BEAUTIFUL—EXPERT
TITLES - EDITING**
Genuine Kodachrome Titles
Tinted and Positive Stock Titles
HORNE MOTION PICTURE SERVICE
9 East 40th Street New York City

**FOR OWNERS OF SMALL TITLERS
BESBEE POCKET TITLE LETTER SET**

Enjoy the pleasure of making professional screen titles with your miniature title-making outfit. The Besbee Pocket Title Letter Set is the answer . . . small, clear-cut metal letters . . . white for regular film, and red for Kodachrome.

Fits every miniature titler. Complete set with grooved background. **\$3.50**

BESBEE PRODUCTS CORPORATION
Trenton, N. J.

Exposure Meter Guide

CORRECTED MARCH 1, 1940

	SCHEINER		WESTON OR GE			SCHEINER		WESTON OR GE	
	Day	Mazda	Day	Mazda		Day	Mazda	Day	Mazda
AGFA					GEVAERT				
16mm SSS Pan	29	27	100	64	Super Reversal	23	21	24	16
16mm Hypan	24	23	32	24	Panchro	20	18	12	8
16mm Panchromatic	21	20	16	12	Ortho	21	17	16	6
16mm Supreme Pan. Neg.	27	25	64	40	GEBERA				
16mm Finopan Neg.	23	21	24	16	Super Pan	23	21	24	16
16mm Positive	12	8	3	2	Panchromatic	20	18	12	8
16mm Plenachrome	20	12	3	3	Semi-Ortho	18	12	8	2
8mm Twin-8 Hypan	23	21	24	20	KINOLUX				
8mm Filmopan	16	16	8	5	No. 1	16	16	6	6
DUPONT					No. 2	18	16	12	10
Reversal Pan	21	19	16	10	No. 3	26	24	50	40
Regular Pan Neg.	20	18	12	8	PELLEX				
Superior Pan Neg.	24	21	32	20	Super	26	25	50	40
Positive	12	8	2	1-6	Pan	20	18	12	8
EASTMAN					Ortho	18	14	8	3
16mm Super XX Pan	24	23	32	24	Super 8mm	25	24	40	32
16mm Super X Pan	20	18	12	8	Ortho 8mm	17	12	6	2
16mm Safety	20	18	12	8	HOLLYWOOD				
16mm Sound Pan	23	21	24	16	S.S. Pan	26	25	50	40
16mm Pan. Negative	23	21	24	16	Pan	21	20	16	12
16mm Positive	16	10	6	6	Semi-Ortho	18	12	8	2
16mm Super X Pan	23	21	24	16					
8mm Regular Pan	18	16	8	5					
Kodachrome (8 & 16mm)	18	14*	8	3*					
Kodachrome (8 & 16mm)	18*	21	8*	12					

*With filter

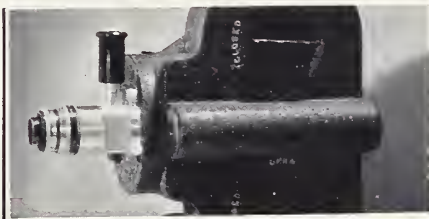

RIGHT ON THE NOSE!

With NOPARLAX Alignment Gauge you can line up any cine camera for shooting titles or ultra close-ups, insuring dead-center focusing—see the full field of scene or title card on ground glass viewer. Fits any 8mm or 16mm camera except Cine Kodaks with bayonet mounts. Inexpensive Adapters make possible to convert for use should you trade or buy another camera. A precision built instrument every cinefilmer has been waiting for!

\$12.00

Postpaid

Are You On Our Mailing List?

CAMERA SPECIALTIES

P. O. Box 3182

Hollywood, Calif.

16mm COLOR MOVIES

For Outright Sale

(Kodachrome Duplicates at 10c Per Foot)

EUROPE
Germany
Switzerland
Prag
Budapest
Vienna
Austria
Italy
Riviera
Luxembourg
France
BRITISH COLUMBIA AND ALBERTA
Lake Louise and Banff
Victoria
Vancouver Island
Vancouver, B. C.
SEND FOR FULL DETAILS on these fine subjects. Many satisfied customers have reordered. Beautifully photographed—superbly edited. Every one a valuable addition to your library.
RENTAL SERVICE—Our rental library contains over 350,000 ft. of 8mm and 16mm silent and 16mm sound subjects in black and white. Film rental catalogue Free. We carry a complete stock of CASTLE FILM SUBJECTS in 8 and 16mm.

ZENITH CINEMA SERVICE

5011 N. SAWYER AVE. CHICAGO, ILL.
Fine Movies Since 1924

DO FILTER FACTORS FLOOR YOU?

... then ask about the new **HARRISON Duraline FILTER SET**—4 Filters, a Holder and Shade to meet 99% of all your requirements. With compact leather case—Easy instructions. New low prices. See them at your dealer today! .. Or write for folder.

HARRISON & HARRISON
Optical Engineers
8351 SANTA MONICA BLVD. HOLLYWOOD, CALIF.

Professionally Printed TITLES ON CELLULOID

Jet back, colored, or snow-white letters for B & W or KODACHROME Titled Titles—Use colored post cards for color backgrounds. Also fill-ins for home movie backgrounds. 10 words, 10c; add'l words, 1c. Send 10c and copy for test celluloid.

NEWLANDS
6016 Barton Ave. Hollywood, Calif.

FINE MACHINE WORK

Turrets, Backwinds, Titlers, Lens Adaptations, 8mm Frame Enlargers, Focusers, Recorders, Sound Apparatus. Expert remodeling of cameras, lenses and projectors. Special Apparatus.

MacVAN MANUFACTURING CO.
3829 El Cajon Blvd. San Diego, Calif.
Courtesy to Dealers

Better Movies with BLACK and WHITE FILM

16 MM. 100 Ft. \$1.98 Includes Reversible Film Processing Rating Weston 12 Scheiner 18 At your dealer or direct. Fast service processing same day included at no additional cost.

VISUAL INSTR. SUPPLY CO
1757 B'way Box H12 B'klyn. N. Y.

gotten films. They may long since have been considered too "corny" to be projected along with your more recent filming efforts. Yet you'd be surprised what a hit they may make if projected with humorous titles made now and played through your radio phonograph or record player controlled with a Voca-Titler.

Nothing is claimed for

the Voca-Titler in connection with synchronization of lips with recorded speech or of specific movements on the screen with sound effects. It was the originator's idea to produce a satisfactory narrating instrument for 8mm and 16mm silent films, and the Voca-Titler seems to accomplish this purpose in a highly satisfactory manner.

Try toning for color . . .

• Continued from page 180

SEPIA-COPPER TONER
Solution—A

Potassium ferricyanide, 170 grains; water, 20 fluid ounces.

Solution—B

Copper sulphate, 140 grains; sodium citrate, 1½ ounces; water, 20 fluid ounces.

GREEN TONER

Purchase Burroughs & Wellcomes "Tabloid S-137 Green Toner."

To use, first immerse film to be toned in a bath of clear, cold water in order to soften the emulsion so that toning solution will penetrate more readily and evenly. Then immerse film in solution "A" until the image begins to turn yellow. Then rinse thoroughly in clear water. Next pour solution "A" into solution "B," mixing the two thoroughly, and immerse film in same until desired color has been obtained in the emulsion. Wash film thoroughly in clear, cold, and preferably running water for at least thirty minutes.

One very important thing to remember is, that when pausing to examine the film during the toning process, it should be quickly removed from the toning solution and thoroughly rinsed in water before inspection. Otherwise, spotting of film will result.

After the film is thoroughly washed, it should be dried in a dust-proof room. If a developing rack is used, the film may be left wound upon it during the drying period, provided the rack allows for contraction of the film during the drying process. Otherwise, it is advisable to remove the film and hang it loosely about the room.

Foggy or veiled high-

lights will sustain a delicate coloring in the toning process. Where such highlights exist, and you do not wish the toning process to affect them, it is advisable to subject such shots for a brief period to a reducing bath. This will definitely clear the highlights and render the image more suitable for toning.

The reducing process may be carried out with the same equipment already referred to as suitable for toning. As to the reducer formula, the writer has found that in using some of the more or less popular reducers such as "Farmers" that difficulty is often encountered in preserving the film in its natural clear tones. It invariably comes out of the reducing process, a dirty, muddy-brown color; and although satisfactorily reduced in density, the result makes one rather regret not having left well enough alone.

After carrying out extensive tests, I discovered a reducing formula which really "behaves," leaving the film not only thinner in density, but with clear, clean blacks, greys and whites. Here it is:

NEUTRAL TONE REDUCER

Solution—A

Potassium permanganate, 3 grains; water, 8 fluid ounces.

Solution—B

Glacial acetic acid, ¾ drachm.

Solution—C

Ordinary acid hypo fixing bath.

To use, first wind the film to be treated emulsion side out on the drum or rack. Soak film in clear cold water as recommended for toning. Dissolve the per-

"OK" Stands for O.K. OMAG KITS

• And for years to thousands of motion and still picture takers OMAG KITS have been all of that—O. K.—plus! Each kit contains four assorted genuine OMAG optical glass filters, world-renowned for precision, accuracy and uniform absorption and density characteristics. Also a duraluminum combination Sunshade and Filter Holder, machined with micrometer exactness. A carrying pouch is furnished free. These KITS are available FOR ALL MODELS of leading still and cine cameras of which a few are listed below:

CINE CAMERAS	STILL CAMERAS
Bell & Howell	Agfa Memo
Bolex	Argus
Keystone	Detrola
Kodak	Kodak
Revere	Univex Mercury
Univex	Perflex
Victor	Candid Midget

and many other cameras too numerous to identify in this advertisement.

Complete kit, \$4.95. Wollensak F 1.5 and F 1.9 kits, \$6.50. Your dealer has these OMAG FILTERS and FILTER KITS in stock. Good weather means good pictures. OMAG FILTERS mean better pictures.

Write us on your filter needs and problems, mentioning camera, name of lens and lens aperture.

CHESS-UNITED CO., INC.

Emmet Bldg. 29th St. & Madison Ave., N. Y. C.

Professional-Looking FADES LAP-DISSOLVES WIPES VIGNETTES

BAIA CINE-TRANSITO JUNIOR
1. PAIR OF DISSOLVE FILTERS
2. WIPE DISC
3. VIGNETTER
4. MASKS AND METER

Operated by Clockwork

- ★ 12 Transitions on one winding.
- ★ Warning buzz—stops automatically.
- ★ Weighs only 4 oz.
- ★ Attaches to lens instantly and in exact center.
- ★ Packed in attractive kit.

Price \$795

With Wipe Disc Adapter and Cable Release Accessories

FADE DISC	\$1.95
VIGNETTER	\$1.95
MASKS	25c each
Extra ADAPTERS	95c each

Specify Camera and Lens
From Your Dealer or Direct

WINDBACK: For Model K, has winding key with frame counter; on C-Kodak 8 includes 8 frames hand crank. Price . . . \$27.50
Note: Clockwork installed on Cine-Transito, Jr., \$5.95 model.

BAIA MOTION PICTURE ENGINEERING
8044 Hardyke Detroit, Mich.



After thrilling to the beauty of our mountains, lakes or waterfalls, don't suffer from disappointment when you return home and have your film developed. Take a WESTON Exposure Meter along. It instantly measures the light, and gives you the correct camera settings for any scene... assures a perfect exposure every time you use your still or movie camera. Be prepared for perfect pictures with a WESTON. See all models at dealer's, or write for literature. Weston Electrical Instrument Corporation, 585 Frelinghuysen Avenue, Newark, New Jersey.

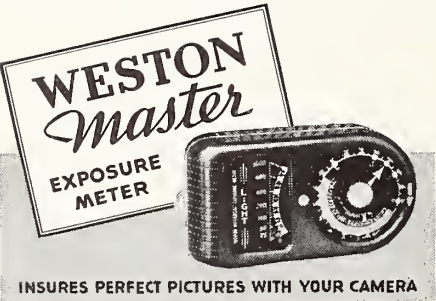

For Only \$8.50
... you get all the facilities to make professional screen titles with the ...
BESBEE TRICK EFFECT EASEL

This new device will make the following effects with no other equipment other than your movie camera:

- Scroll Titles
- Flop-Up and Flop-Down Titles
- Turn-Over Titles
- Revolving Turn-Around Titles
- Curtain Titles
- And Many, Many Others

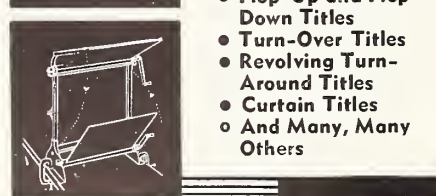

There are no difficult instructions to follow... no complicated mechanism to work. The Besbee Trick Effect Easel is simple and easy... yet exactly professional. Complete with various accessories... **\$8.50**

At your dealer or write for details.
BESBEE PRODUCTS CORP.
TRENTON, N. J.

• 24-HR. FINISHING GUARANTEED **45c**
30 ft. of double 8mm.....
Genera, Pellex, Etc., Processed
30 ft. single 8mm.....25c
30 ft. Univex Standard & U. P.....15c
ESO-S PICTURES
Quality 8mm Service
3945 Central Kansas City Mo.

manganate *thoroughly* in the water. If any grains are permitted to remain in the solution, they will damage the film should they come in contact with it. For this reason, filtering of this part of the solution is recommended before using.

Next, add the glacial acetic acid, stirring it thoroughly. Then place the solution in one of the trays, and the hypo in another. With the tray of the solution in place, lowering the rack or drum wound with film into it, and rotate it continuously. To examine the film during treatment, do not stop rotating of the drum any longer than is necessary. Within a very short time the emulsion will take on a milky appearance. The degree to which this condition should be allowed to proceed may be quite accurately gauged after very little experience. And it is advisable, as with any process, first to make a few tests on discarded film in

order to avoid serious mistakes with valued films. However, with this particular reducer, I have yet to spoil a single foot of film, as it is not overly violent in its action.

When the milky deposit, through which the image can still be clearly seen, has spread over the entire surface of the film, lose no time in washing it in clear running water. A few seconds' thorough washing is sufficient. Then, replacing the tray of solution with the tray of hypo, immerse the film in it for a few minutes until the milky deposit has disappeared.

A final wash of about 20 minutes in clear running water completes the reducing process. Should the film be found not sufficiently reduced, the process should be repeated, but not until the film has been thoroughly washed; as the slightest trace of hypo remaining on the film will decompose the reducer.

Information please...!

• Continued from page 164

Division of the Department of National Revenue at Ottawa, Canada, which we believe contains the information you desire. We quote from it as follows:

"... cameras (still and motion picture, as well as a reasonable quantity of film for use therein) may be admitted with the tourist when visiting Canada without deposit. But is also advisable to direct attention to Section 5 of the department's memorandum which indicates that still picture

cameras including a reasonable supply of positive film therefor may be admitted with non-residents for use in taking pictures... on payment of a deposit of a sum equivalent to the duty and taxes ordinarily payable... subject to refund when and if camera and films be exported under customs supervision within thirty days from date of importation. Two or three rolls of film are considered 'reasonable' by the department."

Can I improve my film?

• Continued from page 181

scene with the boy. Taking care to make no noise, Mother carefully covers Dad with a blanket and exits from the scene with the lamp.

Editing: Would suggest just a few more closeups — short ones of the man's hands at work repairing the lamp. Occasional change of camera set-up would have helped to heighten in-

terest and increase pace of film. One set-up for all action has a tendency to dull after a series of scenes repeat themselves.

Titling: Very satisfactory, well worded, and good exposure throughout.

Photography: Consistently good exposure, reasonably steady, but change of camera angle would have helped. A high shot of the

is this your problem, too?



Would you like to improve your films... acquire that professional touch? With top-notch home movie equipment — complete equipment, chances are, you can. You know that? But do you know it's easier to own the equipment you want when you have Lofayette's Comero Cotolog? It's all here — and guaranteed — at low, money-saving prices. You can order everything you need at home. Send for free copy of this amazing camera cotolog today. See for yourself just what we mean by values. Mail a penny postcard — that's all.

LAFAYETTE CAMERA
Dept. 80 D — 100 Sixth Ave., New York, N. Y.

Better OUTDOOR Action Shots
WHEN YOU USE
16mm AMBERTINT

Fine grain, semi-ortho, large latitude — the OUTDOOR sensation film of the 20th century. AMBER tint of film "different" and pleasing. Amazing low price includes machine processing.



ORDER DIRECT
AMBERTINT not sold at dealers — order several rolls direct — save money. Not made in 8mm nor sold in bulk. **\$2.00**
100-ft. Roll

California Buyers Include Sales Tax
Write for Big Bulk Film Catalog

HOLLYWOODLAND STUDIOS
THE WEST'S GREATEST FILM MAIL ORDER HOUSE
SOUTHGATE, CALIFORNIA

USE METAL LETTERS FOR **MAKING TITLES**

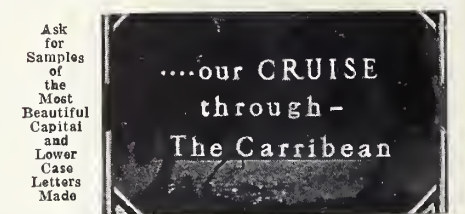

Assortment 222 pieces in wood case. \$7.16 postpaid in U. S. Outside add \$1.00. 126 caps and figures in box. \$4.28. Order white or black letters. YOUR FILMS are not COMPLETE until you TITLE them; adding real interest value for you and your friends. P. O. BOX B

Knight & Son, Inc., Seneca Falls, N. Y.

16 M TITLES

Let FILMACK MAKE YOUR 16 mm TITLES And Announcements

We'll make your titles snappy, artistic, colorful... and put punch and showmanship in every foot. **PROFESSIONAL WORK**
The some fine service FILMACK supplies to thousands of theatres. Send Trial Order or Write for Free Catalog

FILMACK LABORATORIES
845 So. Wobash Ave. Chicago

SILENT or SOUND

FILMS FOR RENT
16MM SOUND - 16MM SILENT - 8MM SILENT
Send for Free Gigantic Catalogue
Listing over 3500 subjects.
IDEAL PICTURES CORPORATION
26 East Eighth Street, Chicago
and
2402 West 7th Street, Los Angeles, Calif.

Use **THRIFTY** 16MM **FILMS**

You'll Get **BETTER PICTURES AT LESS COST**

16mm quality film at amazingly low prices—permitting YOU to shoot more than TWICE as much footage at LESS COST.

THRIFTY ORTHOTYPE
For OUTDOOR . . . non-halation base, fine grain, fast, Weston 8—the film you've been waiting to find at an unheard of low price. Machine processed. Per 100 ft. rolls. **\$1.60**

THRIFTY PANCHROMATIC
Use for all types of shooting. High-speed Weston 16 daylight—10 photofloods, machine processed. Per 100 ft. rolls. **\$3.75**

THRIFTY SUPER-PANCHROMATIC
Super-fast; high sensitivity requiring minimum of light. Weston 50 daylight—32 photofloods, machine processed. Per 100 ft. rolls. **\$4.25**

California Buyers Include Sales Tax
10% DISCOUNT IF YOU ORDER ONE ROLL OF EACH OF THE ABOVE FILM AT ONE TIME.
Regular cost, \$9.60. Special discount price, \$8.64.

THRIFTY FILMS
Drawer 98, Watts Station, Los Angeles, California

Presenting—
—A NEW PLAN—
MOVIE A MONTH
For 8mm Fans

- Have you taken advantage of this new film viewing plan?
- For as low as \$3.00 per year you and your friends can view twelve 8mm films.

AND THAT'S NOT ALL!

- You will receive one reel **Free**—you select it and own it!
- It's a great service for 8mm enthusiasts. Write now and get further details.

MOVIE A MONTH ASSOCIATION
Box 524 Reynoldsville, Pa.
Please Mention HOME MOVIES when answering.
"THE SERVICE THAT SAVES!"

NOTICE TO MOVIE FANS

If you take movies (8mm or 16mm) you simply cannot afford to be without a Free copy of the latest Photo Bargain Book now being distributed throughout the U. S. Lists all the best moving picture equipment from all the leading manufacturers—describes them. The prices save you money in many cases. You'll find the latest in lenses, screens, meters, projectors, cameras, film, titlers, editing outfits, tripods, books on editing, titling, etc. This Bargain Book is invaluable to you as an equipment REFERENCE book. Don't wait a day longer to send for your Free copy. Write us now.

Central Camera Company
Dept. D9
230 S. Wabash Chicago, Ill.

8mm SAVE ON FILM 16mm

Save \$\$ on Film. Take movies at cost of snapshots. Highest quality film giving full tone gradations—with super speed. Assures perfect picture results. Laboratory packing—Weston 10. **Not Positive Film.**

100 ft. Double 8mm (200' 8mm).....\$1.25
100 ft. 16mm with Daylight Leaders.....\$1.25
100 ft. without daylight leaders.....\$1.15
Processing extra - 100 ft. 16mm......75
25 ft. double 8mm - 50c. 4 rolls 25 ft. double 8mm sent in at one time - \$1.50.

ACCURATE CINEMA SERVICE
2609 Morse Ave. Dept. H4 Chicago, Ill.

HARBOR ACTIVITIES

Each Film 400 ft. 16mm silent . . . \$24.00
Subjects: Navigating a Ship Into Harbor, Harbor Safety Measures, Port Commerce, Drydocking Ocean-going Ships, Procedure of United States Customs, Safeguarding Health at the Nation's Gateways, Pacific Coast Fishermen at Sea, etc. Send for Catalogue.

FRITH FILMS Box 565, Hollywood, Calif.

man lying on his back, lazily working at the repair and with all the tools scattered about him, would have been very effective.

"THE NEWSREEL DIGEST" ★★★
200 ft. 16mm—by C. C.

Continuity: This is a burlesque on newsreels in which the maker used local scenes and events to good effect. The opening news item is introduced with a title about a great jockey, and the shot that follows shows a little darky riding a broomstick. The next title refers to a famous mother, and the succeeding shot shows a mother hen and brood of chicks. "Washington Speeds Up Traffic" is the text of another title and the scenes that follow show people scurrying down the street in fast motion. These shots were made at 8 frames per second. A comic diving event is introduced with an appropriate title.

Editing: An idea of this kind depends a great deal upon the editing, the same

The reader speaks

• Continued from page 160

ment or the trunk of an automobile is NOT the best place for keeping one's camera or exposure meter for an extended period of time is a fact not fully appreciated by many amateur movie makers. We are pleased, therefore, at the opportunity reader Taylor's letter affords us to warn cinebugs of this danger.

Gentlemen: You would think that after having a brand new roll of Kodachrome film ruined through having left my camera locked in the glove compartment of my car one extremely hot day last summer, that I would have learned a lesson. But I had to make the mistake twice before the lesson really registered on my noggin! Just recently I had to have my electric exposure meter repaired because I had made it a practice to carry it in the glove compartment of my car. The excessive summer heat had ruined the photoelectric cell. I'm passing this on, hoping it will be a warning to other amateurs.

—Howard A. Taylor.

as a "blackout" in a professional picture or a vaudeville act. When the gag is sprung, the scene or sequence should end abruptly. This is difficult to do in filming an idea of this nature as the first scene after the title invariably exposes the gag. So, the footage of such scenes should be kept down to a minimum with quick intercutting from one angle to another. Additional titles can be made to give a new angle of interest.

Photography: Good, and well exposed. There were some very effective wipe-offs which, according to this cinefilmer, were made with 14 different sized masks used consecutively with single frame exposures and placed five inches before the lens.

Titles: Good, nicely exposed, well worded and hand lettered. Portrait attachment was used not only for shooting titles but for several of the scenes.



Pep up your movies with "candid shots" TAKEN AT A DISTANCE. Shy and distant birds . . . wild animals . . . sports events . . . unsuspecting friends, children. Get these fascinating close-ups with a Wollensak Cine-Telephoto. Fit most 8mm and 16mm movie cameras. F3.5-F4.5. Economical, too.

WRITE for Special Folder on "BETTER MOVIES"

WOLLENSAK OPTICAL CO.

507 Hudson Ave.

Rochester, N. Y.

WOLLENSAK



LEARN photography from EXPERTS

If you are ambitious to become a successful photographer, either for pleasure or career, the New York Institute offers you an unusual opportunity to train under the personal direction of some of America's foremost photographic experts. Courses cover **Commercial, News, Portrait, Advertising, Color, and Motion Picture photography.**

RESIDENT COURSES: Conducted in our modern, completely equipped studios. Day or evening sessions. No classes. You are taught individually. Start any time.

HOME STUDY COURSE: For those who are unable to come to New York. Practical, individual training under the close supervision of the N. Y. I. faculty.

Send for Booklet

NEW YORK INSTITUTE OF PHOTOGRAPHY

10 West 33 St. (Dept. 114) New York City

Established 1910

Liked The Idea Too

Reader Hale's letter speaks for itself.

Sirs: Thanks for the suggestion about showing movies to shut-ins. If you hadn't printed this idea, I would have missed one of the greatest "kicks" I have ever gotten out of life. When I read about shut-in showings of home movies, I realized that there was a man living right across the street from me who hadn't been able to leave his house for six months.

That night I called on my neighboring "shut-in"—put on a show for him. Say—tears almost came to his eyes after the show was over, just because someone had thought enough of him to bring entertainment for him to his home. His whole world had been within the four walls of his home for six months. Now, things seemed brighter—I had brought him renewed hope. I got a lot out of it, too; now I'm looking for other shut-ins in my neighborhood whom I might help in the same way.

—John L. Hale.

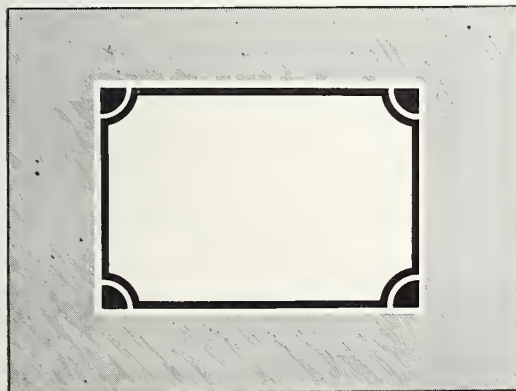
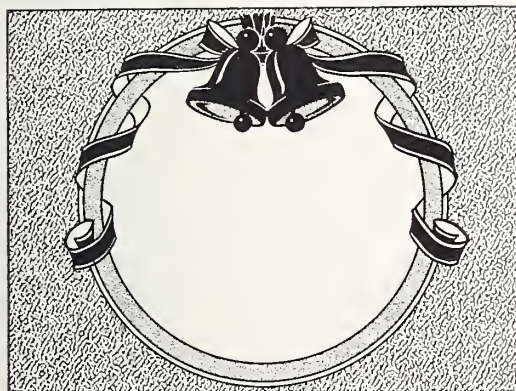

TITLE Backgrounds

By EDMUND TURNER

HAVE you need for a title for your Dude Ranch vacation picture, or that trip out west—or perhaps those golf shots you made? Well, here they are. And—continuing with our series of title backgrounds for traveling cinefilers—we present this month a title card for those who have made, or are planning to make, movies in Cuba.

The background with the bells and ribbon entwined about the circle would make a pleasing background for titles relating to a wedding or an anniversary. And the plain, square title card just below it can be used for framing a series of sub-titles, as may the three similar title backgrounds at the right.

These are very effective if the white text area is cut out carefully along the border with a razor blade and the title text printed or written on a separate white card and placed in back of them.

Should the area of these backgrounds be smaller than required by your typewriter titler, we suggest that you paste them over a card of colored or patterned stock of the required size.

All of these backgrounds are adaptable to either reversal or positive film use. With positive film, the dark areas and black lettering will be white, with the white areas reversed in black.

Readers are invited to drop a post card to Edmund Turner, in care of HOME MOVIES, suggesting other title background ideas, or suggestions for any improvements in these backgrounds or the manner in which they are presented.

If you have missed the backgrounds in earlier issues of HOME MOVIES, they are available to you in packets of 25 assorted titles for 50 cents. Packet No. 1 is for black and white films and Packet No. 2 for Kodachrome.

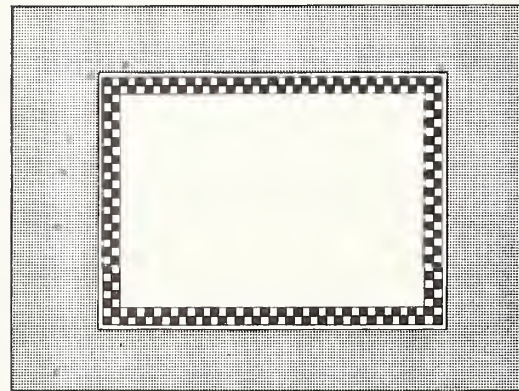
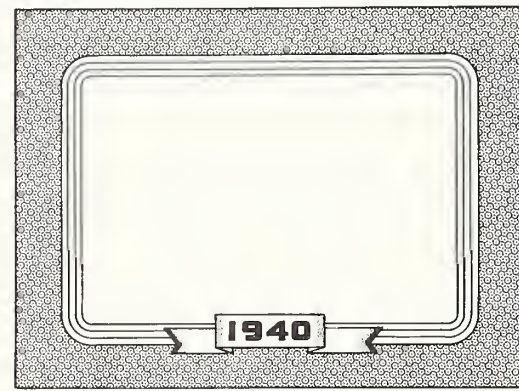
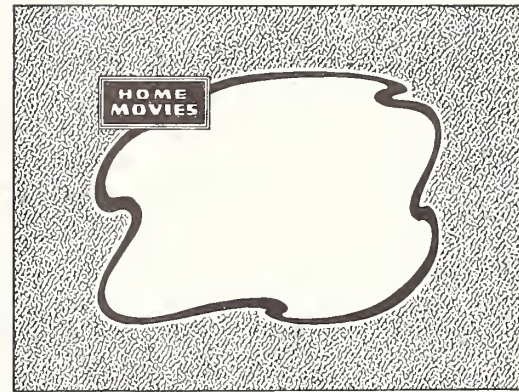
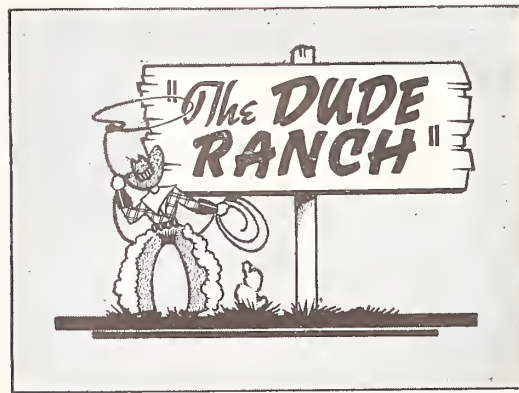

PASSAIC: Passaic Y. M. C. A. Cinema Club.

TRENTON: Trenton Movie Makers (8mm and 16mm) — Jules Y. Shein, Sec'y, 521 S. Warren St. Meet either 1st or 2nd Friday each month.

NEW YORK

BINGHAMTON: Cinema Club of the Triple Cities — Edwin Moody, Sec'y.

BRONX: Bronx Amateur Cinema Club (8mm and 16mm) — Nicholas H. Zella, Sec'y, 384 E. 193rd St.

BROOKLYN: Brooklyn Amateur Cinema Club — Irving Pollock, Pres., 91-01 64th Rd., Rego Park, L. I. Meet every two weeks.

BUFFALO: Amateur Cinema Club of Buffalo — Edward C. Denny, Sec'y, 38 La Salle Ave.

Niagara Cinema League (8mm and 16mm) — K. N. Hadley, Sec'y, 103 Villa Ave. Meet 3rd Wednesday each month.

ELMIRA: Y. M. C. A. Movie Club (8mm and 16mm) — H. M. Shinn, Jr., Sec'y, Y. M. C. A. Meet 1st Monday each month.

JOHNSON CITY: I. B. M. Cinematographer's Club — W. M. Muir, Pres., R. D. No. 2.

MOUNT KISCO: Mount Kisco Cinemats (16mm) — Robert F. Gowen, Sec'y, Chilmark Park, Assinng, N. Y. Meets 1st Monday of each month.

MOUNT VERNON: Mount Vernon Movie Makers (8mm and 16mm) — N. W. Knight, Sec'y, 258 Westchester Ave. Meet 3rd Tuesday.

NEWBURGH: Newburgh Amateur Cinema Club (8mm and 16mm) — J. Earl Maharay, Sec'y, City Hall. Meet 1st Thursday and 3rd Wednesday of each month.

NEW YORK CITY: Metropolitan Motion Picture Club, Inc. (8mm and 16mm) — Robert M. Coles, Sec'y, 35 E. 20th St. Meet 2nd Tuesday each month.

New York City 8mm Motion Picture Club — Walter C. Mills, 35 Park View Rd., Bronxville. Meet 3rd Monday.

Telephone Camera Club of Manhattan — Thos. G. Herendeen, Room 1958, 195 Broadway.

PEEKSKILL: Peekskill Sport Center, Inc. — 830 South St.

ROCHESTER: Rochester Amateur Movie Club (8mm and 16mm) — Raymond H. Jacobs, Sec'y, Y. M. C. A., 100 Gibbs St. Meet 1st and 3rd Thursdays each month.

ROCKVILLE CENTER, LONG ISLAND: Rockville Amateur Cinema Club.

SCHENECTADY: Schenectady Photographic Society, Cine Group (8mm and 16mm) — H. M. Webber, Sec'y, 1279 Dean St. Meet 1st Wednesday of each month.

STATEN ISLAND: Staten Island Cinema Club (8mm and 16mm) — Frank E. Gunnell, Sec'y, 34 Colonial Court, West New Brighton. Meet 2nd Tuesday each month.

Staten Island Movie Makers (8mm and 16mm) — Harry S. Wilson, Sec'y, 34 Rokey Pl.

SYRACUSE: Syracuse Amateur Movie Makers (8mm and 16mm) — Benjamin Franklin, Sec'y, 221 Marguerite Ave. Meet every other Monday.

VALLEY STREAM, LONG ISLAND: Valley Stream Camera Club (8mm and 16mm) — John H. Trunk, Sec'y, 152 Locust Blvd. Meet 1st and 3rd Wednesday each month.

NORTH CAROLINA

MORGANTON: Morganton Camera Club, Movie Division — Edw. M. Hairfield, Jr., Sec'y, Box 793.

NOVA SCOTIA

HALIFAX: Halifax Cinema Club.

OHIO

AKRON: Buckeye Camera Guild (8mm and 16mm) — E. R. Evans, Sec'y, 615 Metropolitan Bldg. Meet every other Monday night.

CLEVELAND: Aremac Club (8mm and 16mm) — L. C. Neuffer, Pres., Box 1719. Meet every 3rd Tuesday.

Cleveland Amateur Cinematographers (8mm and 16mm) — Miss Dorothy Boetticher, Sec'y, 3394 W. 3rd St., c/o Strong, Carliss & Hammond Co. Meet 1st and 3rd Wednesday each month.

COLUMBUS: Columbus Movie Makers — Arthur Robinson, Sec'y, 34 N. 3rd St.

DAYTON: Cinema Research Club of Dayton — Richard W. Ziegler, 1217 E. 3rd St. Meet once a month.

Dayton Cinema League — P. C. Beach, Sec'y, 2240 E. 5th St.

FINDLAY: Findlay Camera Club — Ralph L. Stears, Sec'y, 208 Lark St.

GALION: Galion Camera Club (8mm and 16mm) — Mary Postance, Sec'y, 377 N. Market St. Meet 1st and 3rd Tuesdays each month.

HAMILTON: The Movie Makers Club — Clinton W. Bergen, Pres., 1269 Harmon Ave.

MANSFIELD: Mansfield Movie Club — Dr. L. B. McCullough, 78 Park Ave. W.

MOUNT VERNON: Mount Vernon Camera Club (8mm and 16mm) — Frank J. Van Vorhis, Sec'y, 306 N. Main St. Meet 1st and 3rd Tuesdays each month.

NORTH CANTON: North Canton Cin-

ema Club (8mm and 16mm) — R. L. Wearstler, Sec'y, R. D. 6, E. Maple St. Ext. Meet 1st Friday each month.

SPRINGFIELD: Springfield Cinema Club — C. O. Harrison, Sec'y.

TOLEDO: Toledo Cine Club — Mr. Harry Howland, Sec'y, P. O. Box 23. Meets 2nd and 4th Mondays.

NEWARK: YMCA Movie Makers (8mm and 16mm) — C. I. Grimm, Pres., Arcade Annex. Meet 1st and 3rd Wednesdays.

WOOSTER: Wooster Amateur Movie Makers (8mm and 16mm) — Howard W. Keister, Sec'y, 218 W. University St. Meet 3rd Monday each month.

YOUNGSTOWN: Youngstown Amateur Movie Club (8mm and 16mm) — Fred Deiter, Sec'y, 52 Wesley Ave. Meet 1st and 3rd Mondays.

OKLAHOMA

NAWATA: Nawata Cine Club — Audrey Albin, Sec'y, 514 N. Pine.

OKLAHOMA CITY: Cinemateur Club (8mm and 16mm) — H. P. Douglass, Sec'y, 1909 N. W. 27th. Meet 3rd Friday each month.

Oklahoma City Movie Club — Alex McDonald, Pres., 721 N. W. 29th St.

TULSA: Tulsa Am-Mo Club — J. B. Close, Pres., Box 854. Meet 1st and 3rd Wednesdays.

OREGON

MEDFORD: Medford Movie Club (16mm) — Mrs. George F. Tucker, Sec'y, 37 Kenwood Ave. Meet 3rd Saturday.

Southern Oregon Cinema Club — W. Bernard Roberts, Pres., 922 Reddy Ave.

PORTLAND: Portland Cine Club, Inc. — Arthur E. Gibbs, Sec'y, 324 S. W. Stark St. Meet every two weeks.

PENNSYLVANIA

ALLENTOWN: Allentown Y. M. C. A. Cinema Club — Aral M. Hollenbach, Sec'y, 1229 N. 19th St.

LEBANON: Lebanon Valley Camera Club, Movie Division — W. C. Graeff, Sec'y, 20 S. 8th St.

NORRISTOWN: Mrs. Mary Leanord, Sec'y (8mm and 16mm). 618 De Kalb St. Meet every 3rd Monday.

PHILADELPHIA: ★The 8-16 Movie Club — Louis Sobel, Sec'y, 4916 Ormes St. Philadelphia Cinema Club (8mm and 16mm) — George A. Pittman, Sec'y, 1808 E. Tulpehocken St. Meet 2nd Tuesday each month.

PITTSBURGH: Pittsburgh Amateur Cinema Club (8mm and 16mm) — Miss Rose Goldman, Sec'y, 319 Amber St. Meet 1st and 3rd Wednesday each month.

POTTSTOWN: Pottstown 8mm Movie Club (8mm) — Wm. J. Weiss, Sec'y, 874 N. Charlotte St. Meet 1st Tuesday each month.

READING: Berks Camera Club (8mm and 16mm) — George Kephart, Sec'y, 611 N. 11th St. Meet every Thursday.

SUNBURY: Sunbury Amateur Cinema Club (8mm and 16mm) — David Lenker, Sec'y, 346 Chestnut St. Meet 1st and 3rd Mondays.

SOUTH DAKOTA

SIoux FALLS: Sioux Falls Amateur Cine Club — (16mm and 8mm) — H. E. Hanson Harold's, 308 S. Phillips Ave. Meet 1st Monday each month.

YANKTON: Yankton Camera Club. Arthur J. Smith, Pres., 414 Capitol St.

TENNESSEE

MEMPHIS: W. G. Snowden, Sec'y Box 2073, DeSoto Sta.

TEXAS

DALLAS: Dallas Cine Club — Stan Everman, Pres., 1504 Young St.

UTAH

LOGAN: Logan Amateur Cinema Club (8mm and 16mm) — Mrs. E. L. Hansen, Sec'y, Logan, Utah.

SALT LAKE CITY: Utah Amateur Movie Club (8mm and 16mm) — C. F. Solomon, Jr., Sec'y, 1471 Browning Ave. Meet 2nd Monday of each month.

VIRGINIA

LYNCHBURG: Hill City 8 Movie Club (8mm) — Nowlin Puckett, Corresponding Sec'y, 822 Floyd St. Meet once a month.

NORFOLK: Norfolk Amateur Movie Club (8mm and 16mm) — Claude D. McMillan, Jr., Sec'y, 720 Carolina Ave. Meets 3rd Tuesday.

WASHINGTON

SEATTLE: Northwest Amateur Cinema League — Carlos E. Grant, 915 Green Bldg., Seattle, Wash.

Roosevelt Movie Club (16mm) — Jayne Stokes, Sec'y, Roosevelt High School, 2032 Franklin Ave. Meet every other Wednesday.

Seattle 8mm Club (8mm) — W. B. Bowden, Sec'y, 546 Dexter Horton Bldg. Meet 2nd Tuesday each month.

TACOMA: Tacoma Cinema Club (16mm) — Don Flag, Sec'y, 829 S. Ferry St. Meet 4th Monday each month.

WALLA WALLA: Walla Walla Cinema Club (8mm and 16mm) — Cromie L. Wilson, Sec'y, 715 Catherine St. Meet 4th Monday.

YAKIMA: Yakima Amateur Movie Club (8mm and 16mm) — William Hassell, Pres., 1208 W. Yakima Ave. Meet 4th Wednesday.

“Up” Your Movie Making Skill— with these fine books!

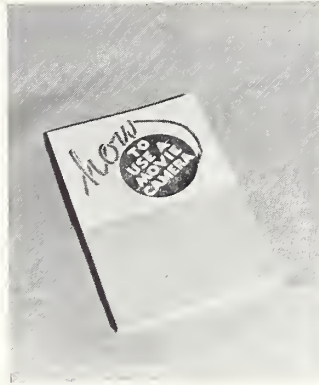

A new handbook for the beginner. Takes up where your camera instruction book leaves off. Contains essential data on fundamentals of making good home movies, boiled down in one small, easy-to-read volume. Makes clear in easy-to-understand terms the use of lenses, threading of camera, setting exposure, correct focusing, etc., and points out mistakes to avoid that will save many dollars in wasted film. Per copy.....

50c

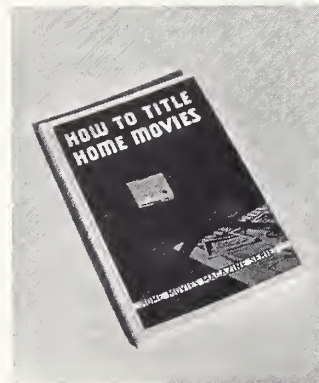

The latest, most complete book on titling home movies which includes, in addition to complete plans for building the renowned Home Movies Titrer, such data as Title Area Chart, Lighting Chart, Diopter Lens Chart, How to Make Trick Titles, Data on Use of Shims for ultra-closeups, etc. There's approximately 100 pages jam packed with vital information for every amateur movie maker. Price

\$1.00

per copy.....

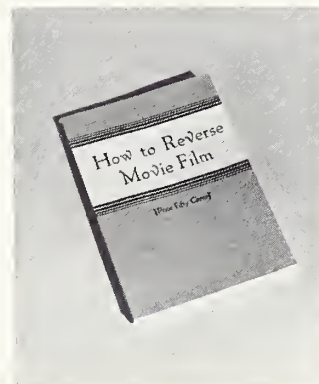

The leading textbook for the amateur on the subject of reversing home movie film. Over 5000 copies sold to date! Illustrates and describes how to build home processing equipment; gives all the popular reversal formulas; and tells how to intensify or reduce over- or under-developed films. Get this book today and start processing your own films for greater economy and pleasure in home movie making.

Per copy.....

50c

If your dealer cannot supply you with any of the above books, send your order, together with check or money order, direct to us and same will receive immediate attention.

VER HALEN PUBLICATIONS

6060 Sunset Boulevard

Hollywood, Calif.

• Continued on next page

CLASSIFIED • ADVERTISING

EQUIPMENT FOR SALE

• **BASS SAYS:** An April Shower of bargains with money-back guarantee.

USED CAMERAS

Simplex Pockette Magazine, f/3.5 lens, \$25.00.
Cine-Kodak Model M, f/3.5 lens, \$25.00.
Aega Magazine, f/1.9 lens, three films, \$34.50.
Filmo 70-A, Cooke f/3.5 lens and case, \$35.00.
Keystone Model A-7, Wollensak f/1.5 lens, \$49.50.
Cine-Kodak Model K, f/1.9 lens, with case, \$59.50.
Filmo 75, Cooke f/1.8 lens and case, \$67.50.
Filmo 70-D, 1" Zeiss f/2.7 focusing mount, 1" Wollensak f/1.5, 2" Zeiss f/3.5, case, \$174.50.
Filmo 70-D, 1" Cooke f/3.5, 1" Cooke f/1.8, 3" Cooke f/3.3, case, \$192.50.
16mm Movikron 16, Sonnar f/1.4, metric marked, rangefinder, \$245.00.

USED PROJECTORS

Ampro Model J, 500 watt, with case, \$67.50.
Bell & Howell 8mm projector, 122-B, 110-220 volt, complete with case, \$92.50.
Bell & Howell Diplomat, 750 watt, variable resistance, and case, \$95.00.
Ampro Model NC, 750 watt, with case, \$115.00.

USED SOUND ON FILM PROJECTORS

Victor Model 25, S.O.F., 500 watt bulb, \$125.
Victor Model 38, S.O.F., 750 watt bulb, \$245.
Ampro Model L, 750 watt bulb, \$295.00.

New **BOOL** four-way **FADER**, spring driven, complete, fits all cameras, \$17.50.

UP-TO-THE-MINUTE TEXT BOOKS

American Cinematographer Handbook and Reference Guide, invaluable, Special at 97c postpaid.

Trick Effects with the Cine Camera, \$1.00 postpaid.

Home Processing, includes all necessary information, by Harris, \$2.00 postpaid.

Be sure to get your copy of our great 66-page Cine Catalog No. 240. It is free. Also a 72-page Still Camera Catalog No. 242.

BASS CAMERA COMPANY

Dept. HC, 179 W. Madison St., Chicago, Ill.

Cine Kodak K f/1.9 and Case, \$62.50.

Cine Kodak BB f/1.9 and Case, \$37.50.

Simplex CC f/1.9, \$57.50.

Filmo 70A f/3.5, \$29.50.

Filmo 70E f/2.7, \$85.00.

Filmo 75 f/3.5, \$32.50.

Cine Kodak 8-20 f/3.5, \$19.50.

Keystone 8 f/3.5, \$18.50.

Ensign f/2.6 Lens, \$35.00.

B. & H. Filmo 57 C 400 Watt, \$55.00.

B. & H. Filmo 57 A 250 Watt, \$40.00.

EK Kodscope EE 750 Watt, \$40.00.

Keystone A 81 750 Watt, \$48.50.

Keystone A 75 500 Watt, \$35.00.

Filmo 129C 750 Watt—New, \$122.50.

Kodascope 8-20, \$12.00.

Kodascope 8-50, 300 Watt, \$22.50.

Keystone L 8, 500 Watt, \$35.00.

Keystone M 8, 300 Watt, \$23.50.

12 1/2mm f/1.9 Lens with Hypar Cinor Attachment for Filmo Sportster, \$37.50.

15mm f/2.7 Wollensak for Filmo 70, \$18.50.

1" f/1.8 Wirgin Lens for Filmo 70, \$25.00.

1" f/1.9 Berthiot Cinor for 70A, \$25.00.

2" f/3.5 Wollensak for 70A, \$15.00.

2" f/3.5 Cinor Lens for 70A, \$22.50.

3" f/3.5 Cinor Lens for 70A, \$37.50.

6" f/4.5 Dollmeyer for 70A, \$30.00.

SEND FOR NEW BARGAIN CATALOG

WILLOUGHBY'S, 110 West 32nd St., New York

• **8MM AND 16MM CAMERA Bargains!** 8mm Siemens Magazine Camera, f/2.5, case, tel. lens, filter — \$200.00. Dittmar "8" Special with backwind, frame counter, case — only \$110.00. Eumig "8" with f/2.5, electric driven, 3 filters — only \$45.00. Revere f/3.5, only \$17.00. 16mm Siemens Magazine Camera, f/1.5, case — \$110.00. 16mm Eastman "B" with f/3.5 — only \$25.00. HANS UNFRIED, 24 Camp Buffalo, N. Y.

• **BOLEX H-8, 1/2" F:1.5** Hugo Meyer. 1 1/2" F:3.5 Wollensak Telephoto, Case, Cable Release. \$285.00. Perfect condition. Privately owned. H. A. Downard, 2221 Eye, Sacramento, Calif.

• **VICTOR Model 3, used eleven times!** Absolutely perfect. Looks, works like new: with Victor dist-a-sight — \$29.00. REV. PHILIP LI CALZI, Wilmington, Del.

• **FOR SALE**—16mm Bell & Howell turret 70-DA camera, Cooke lens, leather case, \$105.00. J. D. PHILLIPS, 417 Montgomery St., San Francisco, Calif.

• **COMPLETE UNIVEX C-8, f/3.5**, case, meter, titler, projector PU-8, extra bulb, de luxe case, 6 rolls ultra pan — \$59.00 cash. SIDNEY MILLER, 91-11 Springfield Blvd., Queens Village, L. I., N. Y.

• **EXPOSURE METERS** list to \$16.00, new, guaranteed Mini, Mini-Photocopy W/C, Photrix W/C — \$7.95. C.O.D. Satisfaction guaranteed. PARK CAMERA EXCHANGE, 6041 Pacific Blvd., Huntington Park, Calif.

• **CLOSING OUT**, hundreds of items, still and movie cameras, accessories and supplies. Write now for Free Bargain Bulletin. CAMERA MART Dept. G, 70 West 45th St., New York

• Ten cents per word; minimum charge, \$2.00 cash with order. Closing date, tenth of preceding month. • **HOME MOVIES** does not guarantee goods advertised. • Send ads to 6060 Sunset Boulevard, Hollywood, California.

ACCESSORIES

• **SAVE!** Catalog! News Bulletin! Bulk Films! 8mm-16mm Film Subjects galore! Cameras! Projectors! Accessories! Send Postal! PENN-CRAFT, 423 Williamsport, Pa.

• **MOVIE** Cameras, Films, Projectors, etc., bought, sold, and exchanged. Big lists Free. Art samples, 25c. PEERLESS, Box 1310-H, Hollywood, Calif.

• **CLEARANCE SALE**—Cameras, projectors, films—8-16mm. Big Free list. We buy anything. ROBERT BLOCK, 1451-B Broadway, New York.

WANTED

• **WE WILL PAY \$ \$ \$ \$** for new **Movie** Kinks and Gadgets that we can use for resale purposes. MIROTEX PRODUCTS, 6241 Southwood Ave., St. Louis, Mo.

TITLING SERVICE

• **TITLE YOUR** Home Movie Films with artistic title backgrounds, same as appear Home Movies Magazine. Pkg. 25 titles, 50c. Specify for color or black and white. VER HALEN PUBLICATIONS, 6060 Sunset Blvd., Hollywood, Calif.

• **HOLLYWOOD PROFESSIONAL** title service. Colored films, Backgrounds, Special Effects. 16mm or 8mm, low as 25c. FREE Main and End titles. Use Orbit Titles in your Home Movies Contest entry. Write for particulars. ORBIT, 5437 1/4 Hollywood Blvd., Hollywood, Calif.

WANTED

• **WANTED**—16mm Eastman f/1.9 or Filmo camera and projector. Describe fully. H. F. BERGSTEDT, 1721 Clover Lane, Fort Wayne, Indiana.

FILM RELEASES (8 and 16mm)

• **CASTLE FILMS** Library. Sales—Exchanges. Offering the finest exchange services. Keystone Sales—Service—Parts. RIEDEL FILM SERVICE, 6120 Lorain Ave., Cleveland, Ohio.

• **REAL "ART"** FILM—Send 10c today for generous prepaid sample or get Free fully descriptive list. CINEART, 2443-B Gunnison, Chicago, Ill.

• **"FINLAND FIGHTS"** and all latest Castle Film releases for sale. Also, complete exchange service. Free Catalog. OVERBROOK FILMS, Dept. H, Box 722, Philadelphia, Penna.

• **FREE CATALOG**—Rent 16mm silent programs, 7 reels—\$2.00. New exchange list ready. ASHA FILMS, 785 St. Johns, Brooklyn, N. Y.

• **8mm—16mm—16mm S. O. F.** subjects exchanged. Free lists. Good used S. O. F. subjects wanted. K & G FILM EXCHANGE, Box 65, Arverne, N. Y.

• **CASH FOR** your 8 and 16mm film subjects, or will give liberal allowance towards brand new films. MICHIGAN 8-16mm FILM EXCHANGE, 1514 Garfield Ave., Grand Rapids, Mich.

• **8mm - 16mm FILMS**—Latest releases: War, Comedies, Cartoons, Travels, Dramas, Educationals, silent and sound. Films rented everywhere! Free illustrated catalog (with sample Art film, 10c). GARDEN FILM, 317 West 50th St., New York City.

• **LARGE 8mm Film Catalog** mailed Free—Buy now—Unusual assortment of Chaplins, Charlie Choses, Snub Pollards, and Castles at reduced prices. Also assortment of Arts (all in perfect condition). THE ABBE FILMS, 1265 Broadway, N. Y. C. Telephone Murray Hill 4-1257.

• **HANIK 16mm FILM RENTAL CLUB** Comedies—Art Features 1225 Stowe Ave. McKees Rocks, Pa. JOIN NOW! FREE CATALOG!

• **NEW VARIETY 8-16mm** unusual subjects. Western, Comedy, Travel. Send 10c for sample and list. RIO FILMS, Box 421-C, Hornell, N. Y.

• **8MM-16MM LIBRARY.** Low rates. Films shipped anywhere. Bargains: Used equipment. Trades. Cash for used films. DAYTON FILM RENTAL, 2227 Heburn, Dayton, Ohio.

PROCESSING SERVICE

• **8mm DUPLICATES, 3c ft.** Fast processing, 30 ft. 8-8, 45c; Single 8, 25c. CINE FOTO, 128 Wilson, Springfield, Ohio.

FILM

• **EASTMAN** Kodachrome, 8mm 200 feet—\$8.00. Also black and white at big saving. COPE STUDIO, 3720 S. Figueroa, Los Angeles, Calif.

• **SPECIAL! 100' 16mm** or double 8mm, \$1.45. 30' single 8, 30c. Includes processing. MGM PHOTO SERVICE, 1485 Oak, San Francisco, Calif.

MISCELLANEOUS

• **DON'T FAIL** to title those personal films. Make them a complete record. Any 8mm or 16mm movie maker can make professional looking titles with the **PIN LETTER TITLING SET**. Basic set of 150 white block 3/4-inch letters is priced at \$5.50. A dozen other size and style letters are available as well as many interesting title decorations. Write for pamphlet or ask your camera store for demonstration. Mittens Letter Company, Redlands, Calif.

• **YOUR DOG** can become your most willing actor. Let me educate him at nominal cost if his age is between 8 mos. and 5 years. Courses in obedience, tricks, and special movie work. Free details. JOHN KLOK, Lyons, Mich.

• **"ANIMATED CARTOONS"**—a new book that tells how to draw and animate cartoon characters for movies. Sent prepaid for \$1.00! VER HALEN PUBLICATIONS, 6060 Sunset Blvd., Hollywood, Calif.

• **BACK ISSUES OF HOME MOVIES**—June, July, August, Sept., Oct., Nov. and Dec., 1939, issues at 15c each; six or more, 10c each. Jan. and Feb., 1940, issues, 25c copy. VER HALEN PUBLICATIONS, 6060 Sunset Blvd., Hollywood, Calif.

• **BINDERS FOR HOME MOVIES**—Handsome leatherette binders with quick detachable retainers for 12 separate issues. Preserve your HOME MOVIES in neat, orderly manner with one of these binders. \$1.25 prepaid. Supply limited! HOME MOVIES, 6060 Sunset Blvd., Hollywood, Calif.

• **NEW ARGUS** Cine-Still Exposure Meter, 25c postpaid. Fine-grain developing, enlarging. Low prices. PHOTOSERVE, P. O. Box M-62, Collinsville, Ill.



For Future Reference

File your copies of **HOME MOVIES Magazine** in one of these attractive gold-stamped leatherette binders.

\$1.25

Postpaid

HOME MOVIES—6060 Sunset Boulevard, Hollywood, Cal.

Directory of Amateur Cine Clubs

• *Continued from page 203*

YAKIMA (Wash'n)
Amateur Movie Club: Paul Thompson, Pres., 709 S. 4th St.

WEST VIRGINIA
HUNTINGTON: Huntington YMCA Amateur Movie Club (8mm and 16mm) — James Warfield, Sec'y, 629 6th St. Meet each 3rd Friday.

TRIADAPHIA: St. Vincent's Cinematic Club — E. Dietrich, Rt. 1, Box 93.

WHEELING: ★ Cinematography Group of the Ohio Valley Camera Club (8mm and 16mm) — R. E. Dempster, 162 15th St. Meet every other Friday.

WISCONSIN
MADISON: Cine 8 Club — Ruth Hoffman, Sec'y, 535 W. Dayton St. Meet 1st Tuesday each month.
Maple Bluff Camera Club — John B. Casodary, Sec'y, 1005 Power & Light Bldg.

MILWAUKEE: The Amateur Movie Society of Milwaukee (8mm and 16mm) — Miss Parmelia M. Mills, Sec'y, 530 N. 20th St. Meet 2nd and 4th Wednesday.
Cream City Cinema Club — E. R. Glaessner, Sec'y, 3730 W. Lisbon Ave.
Milwaukee Movie Makers — Harold Francke, Sec'y, 1926 E. Fernwood Ave.

NEENAH: The Winnebago Camera Club, Movie Division — Duane Raiche, Sec'y, 247 4th St.

WYOMING
CASPER: Casper Amateur Motion Picture Club (8mm and 16mm) — A. F. Everitts, Sec'y, 1544 S. Cedar St. Meet 1st Tuesday each month.

CANADA
ALBERTA, CALGARY: Calgary Amateur Motion Picture Club (8mm and 16mm) — Mrs. A. F. McKenna, 2316 2nd St. W. Meet 3rd Thursday each month.

ALBERTA, EDMONTON: The Edmonton Cine Club (8mm and 16mm) — H. B. Holloway, Sec'y, Ste. 2, 10617 98th Ave. Meet 1st and 3rd Monday each month.

BRITISH COLUMBIA, VANCOUVER: Cine 8 Club (8mm) — J. L. Hudson, Pres., Box 35; A. S. Sutcliffe, Sec'y, Box 35. Meet 1st and 3rd Tuesday each month.

ONTARIO, HAMILTON: Hamilton Movie Makers (8mm and 16mm) — J. J. Wood, Sec'y, 136 Markland Ave. Meet 4th Monday each month.

ONTARIO, TORONTO: Shots & Angles — N. Pelletier, 34 Blandford St., Toronto 10.
Toronto Amateur Movie Club (8mm and 16mm) — J. R. Beale, Sec'y, 40 Roscliffe, Apt. 2. Meet 1st and 3rd Wednesday each month.

WINNEPEG, MANITOBA: Winnepeg Cine Club — Walter R. Lawson, Sec'y, 390 Winterton Ave. fl fl
SASKATCHEWAN, MOOSE JAW: Moose Jaw Movie Makers Club — Len Taylor, Sec'y, Canadian Legion Home.

MEXICO
MEXICO CITY: Cinema Club de Mexico (8mm and 16mm) — Harry Wright,

SOLVES

Exposure PROBLEMS

- **New Universal Guide for Ciné-Kodaks Gives Immediate, Explicit Answers to Movie-making Exposure Problems**

ON the side of all new Ciné-Kodaks is a simple little device that takes all the worry, higher mathematics, and black magic out of the exposure problem.

It's called the Ciné-Kodak Universal Guide. For every type of Ciné-Kodak Film there's a little exposure card designed to slip neatly into place in the Guide; by rotating the disk of the Guide so that its indicator arrow points to a specific light condition, given on the exposure card, you may take immediate exposure readings. One side of the exposure card defines outdoor light conditions; the other covers indoor, artificial light in terms of the number and type of Photofloods used and their distance from the subject. Allowances are shown for the various standard camera speeds and for subjects of average, light, or dark color.

An individual exposure card is now being packed with each roll of Ciné-Kodak Film (obviously, it will be some time before film so packed is generally available).

Meantime, Pocket Model Universal Guides, complete with exposure cards for all Ciné-Kodak Films, are available (price, \$1) at Ciné-Kodak dealers'. New shipments of Ciné-Kodaks, of course, include the Guide and a set of cards. Present owners of Ciné-Kodaks may have Guides affixed to their cameras. A charge of \$1 covers the Guide, a set of cards, installing Guide on camera, and removing the old front exposure plate. Your dealer can arrange this service.

Simple, Explicit, Inexpensive

The Guide for each model Ciné-Kodak, 8 or 16 mm., varies according to that camera's characteristics.

Simple, explicit is this new Guide. With it the precise exposures required for finest results with Kodachrome Film are as easily and accurately determined as are exposures for black-and-white filming.

It's beautifully simple, completely successful.

**EASTMAN KODAK COMPANY
ROCHESTER, N. Y.**

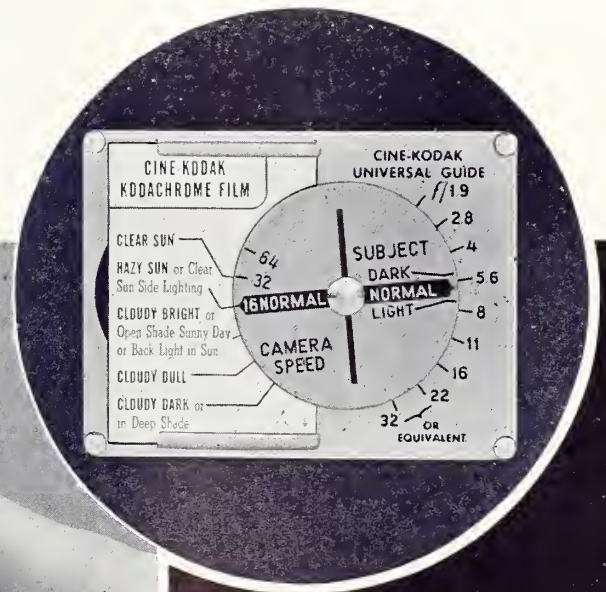

Slip the exposure card, for the kind of film you're using, into the Guide, and the answers to your exposure problems are immediately determinable. Incidentally, when you become a Guide user, you eliminate the possibility of forgetting the type of film loaded in your camera.

It's Time You Owned a *Filmo* MOVIE CAMERA!

Your movies can be no better than the camera with which you make them. It's time you owned a really fine camera . . . one so precise that it would always assure professional results with amateur ease . . . one so versatile it would permit you to cope with every movie opportunity. Get *that* kind of a movie camera now—a FILMO, precision-made by the makers of Hollywood's professional movie equipment. Easy terms available.

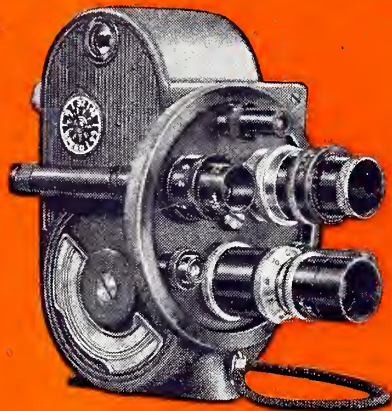

Be Ready for Every Shot

. . . with the new Filmo Turret 8. This midjet miracle combines the economy of 8 mm. film with the instant readiness of a newsreel man's camera! Mounts three lenses and matching viewfinders on a revolving turret. Just turn the turret, and the correct lens and finder are in position ready to shoot—one quick operation! Also has new eye-parallax-correcting viewfinder; critical focuser; four speeds, including slow motion; and single frame exposure. With 12½ mm. F 2.5 lens. . . . \$140



"Shelloading!" No Threading of Film!

EASY Does It

. . . with the new Shelloading Filmo. This trim, pocket-fitting 16 mm. camera gives you unusual versatility and almost automatic ease of operation. It "shelloads" with pre-threaded 16 mm. film magazines. Permits mid-reel changes from color to black-and-white. Has built-in, damage-proof, "positive" viewfinder which eliminates off-center pictures even if your eye wanders! Has four speeds and single frame exposure. Uses all special lenses. With one-inch F 2.7 lens. . . . \$115

NEW FILMO PROJECTORS

Both Fully Gear Driven!

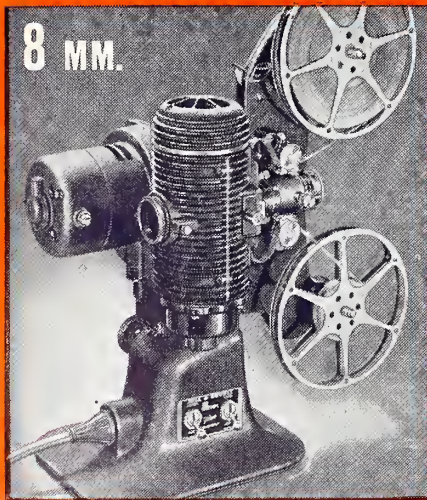

8 MM.

To see your 8 mm. movies at their best, use this new Filmo-Master 8. With many improved features, it offers theater-quality projection and absolute film safety. Has 400- or 500-watt lamp; gear drive throughout; fast F 1.6 lens; 200-foot film capacity; lens focus lock; two-way tilt; radio interference eliminator; tripod socket; separate lamp switch; and many other features. With case. . . . \$118

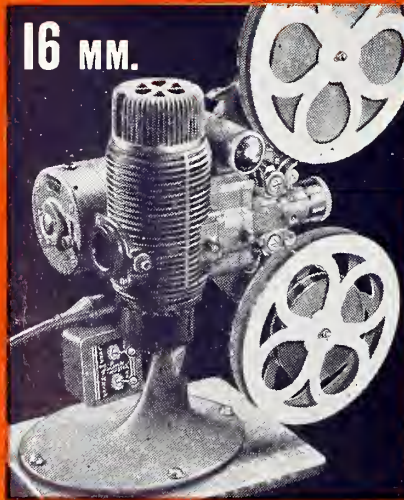

16 MM.

The new 16 mm. Filmo-Master Silent Projector provides extra power and extra convenience. Is fully gear driven. Has speedy power rewind. Has powerful 750-watt lamp and Magnilite condenser for 32% greater picture brilliance. Has two-way tilt; reverse switch; still-picture clutch; "floating film" protection; metered lubrication; other features. With 400-foot capacity, two-inch F 1.6 lens, and carrying case. . . . \$139

FREE! New Filmo Accessory Catalog

Every movie maker anxious to improve his films should have a copy of the new 36-page Filmo Accessory Catalog. It's a guide book to the innumerable fascinating things you can do with a personal movie outfit, and it presents units that will extend your camera's abilities into delightful new fields of movie making. Mail coupon today for your free copy.



NEW FILMS AVAILABLE

Expect a Baby? Dr. David Bennett Hill has prepared three new single-reel films, 16 mm. sound or silent, on prenatal, infant, and child care. Order by name: **Before the Baby Comes; The First Year; The Child Grows Up.**

Like Astronomy? A new, condensed edition of Ruoy Sibley's popular astronomy demonstration is now available in two reels, 16 mm. sound or silent. Title: **Seeing the Universe.**

Charming Fairy Story—told in superlative puppet technique. (Two reels, 16 mm. sound or silent.) Title: **King and Scullery Maid.**

Mail Coupon for **FREE FILM LIST.** Bell & Howell Company, Chicago; New York; Hollywood; London. Established 1907.

MAIL TODAY

BELL & HOWELL COMPANY
1825 Larchmont Ave., Chicago, Ill.

Send () free Filmo Accessory Catalog; () free list of () sound () silent 16 mm. films for home showings.

Include details on () new 16 mm. Shelloading Filmo Camera; () Filmo Turret 8; () Filmo-Master 8 mm. Projector; () Filmo-Master 16 mm. Projector.

Name.....

Address.....

City..... State..... HM 4-40

PRECISION-MADE BY

BELL & HOWELL

Price 25c

HOME MOVIES

Register of Copyrights
Washington, D. C.



Jack Treacy Ph

May . 1940

Hollywood's Magazine for the Amateur



3

THRILLING AVIATION FILMS!

IN 8MM AND 16MM

DAREDEVILS OF THE AIR!

A thrilling circus of aerial stunts. Packed from start to finish with well-photographed scenes of planes in trick maneuvers, stunt flying, and racing. Every print "screen-tested" to insure highest quality screening performance. When ordering, specify No. 457-C.

400 ft. — 16mm . . . \$12.00
200 ft. — 8mm . . . 5.00



AIR STUNTS

A dramatic record of some highly intricate aerial maneuvers performed by renowned and daring air pilots. Most scenes filmed "close-up" from other planes. Specify No. 292-A.

100 ft. — 16mm . . . \$2.50
50 ft. — 8mm . . . 1.25

"Spice
for
Your
Program!"



THE DOG FIGHT

Takes you right into the pilot's seat behind crackling machine guns. Shows "straffing" of enemy planes. Death struggle of doomed pilots as their flaming planes hurtle earthward. Specify No. 291.

100 ft. — 16mm . . . \$2.50
50 ft. — 8mm . . . 1.25

DISTRIBUTED EXCLUSIVELY BY
SEEMANN'S Inc.
HOLLYWOOD, CALIF.



For the LAUGH in Your Program, Screen "MEANY, MINY & MOE"

in the biggest laugh hits of their career — "Beauty Shop" (No. 1202-A) and "Pickled Herring" (No. 1211-A). Also fourteen other laugh hits. Your home movie audience will beg for more of these rollicking, rib-tickling simian funsters!

100 ft. — 16mm . . . \$3.00
50 ft. — 8mm . . . 1.50

HOLLYWOOD FILM ENTERPRISES, INC.

6060 SUNSET BLVD. • • HOLLYWOOD, CALIF

FREE!

New 20-page catalog
of 8mm and 16mm
Home Movie Films!



Home Movies

MAGAZINE



**Subscription
Order Form**



MAY - 8 1940

©C1B 453980



★ Shot of the Month . . .

home MOVIES

Copyright 1940 by Ver Halen Publications. No part of magazine may be reprinted without specific permission.

CONTENTS FOR MAY, 1940

INFORMATION PLEASE	210
THE READER SPEAKS	212
BACKYARD MOVIES	214
WITH THE "PRO-16'S"	216
TITLE TROUBLES	218
SHOWINGS FOR SHUT-INS GAINS MOMENTUM <i>By Wm. MacGrath</i>	221
"FROM A TO Z"—MOVIE OF THE MONTH <i>By J. H. Schoen</i>	222
"THE FAMILY CHAMP"—KNOCKOUT SCRIPT WITH TITLES <i>By J. H. Schoen</i>	224
A GUIDE FOR AMATEURS FILMING THE FAIR <i>By Henry Fisher</i>	227
RARE ADVENTURE AWAITS CINEFILMERS DOWN MEXICO WAY! <i>By Frederick E. Strauss</i>	228
YOU CAN BUILD THIS ROBOT CAMERA CONTROL <i>By Chas. A. Munz</i>	230
PEP UP YOUR MOVIES WITH NEW TITLE TRICKS <i>By George W. Cushman</i>	231
MORE ABOUT 1940 "DREAM" CAMERA <i>By Ray E. Merville</i>	232
TELL ME—HOW CAN I IMPROVE MY FILM? <i>By the Editors</i>	233
THREE WAYS TO IMPROVE EXPOSURE QUALITY <i>By Wm. Lee Morgan</i>	234
THERE'S NO MYSTERY ABOUT "F" STOPS <i>By R. S. MacCollister</i>	235
EXPERIMENTAL CINE WORKSHOP	236-237
IT'S NEW TO ME!	238
EXPOSURE METER GUIDE	252
TITLE BACKGROUNDS	257
DIRECTORY OF AMATEUR CINE CLUBS	258

★ Shot of the Month—An example of excellent framing. Without tree in foreground, this would be just another picture.

CHAS. J. Ver HALEN
PUBLISHER

C. J. Ver HALEN, JR.
ASSOCIATE PUBLISHER

ARTHUR E. GAVIN
EDITOR

OFFICE OF PUBLICATION
6060 Sunset Boulevard, Los Angeles, Calif.
Phone GRanite 5149

NEW YORK OFFICE
Everett Gellert, 62 West 45th Street
Vanderbilt 6-5254

CHICAGO OFFICE
C. N. Burris, 712 Wrigley Building
Whitehall 7784

RAY FERNSTROM
Technical Editor

GEORGE W. CUSHMAN

R. E. MERVILLE

J. H. SCHOEN

Associate Editors

COUNT H. von SCHOENFELDT

Photographic Editor

C. E. BELL

Associate Photo Editor

L. C. BUSCHER

Art Director

SEYMOUR B. AGINS

Asst. Art Director

MAY
1940
NUMBER 5
VOLUME VII



Registered as Second-Class Matter, May 6, 1938, at Postoffice at Los Angeles, California, under the Act of March 3, 1879. Subscription rates—U. S. \$2.00 a year. Canada \$3.00 a year. Foreign \$2.50 a year. Single copies 10c. Foreign single copies 35c. Copyright, 1940, Ver Halen Publications. Advertising Rates on Application.

DO YOUR TITLES "Up Brown"!

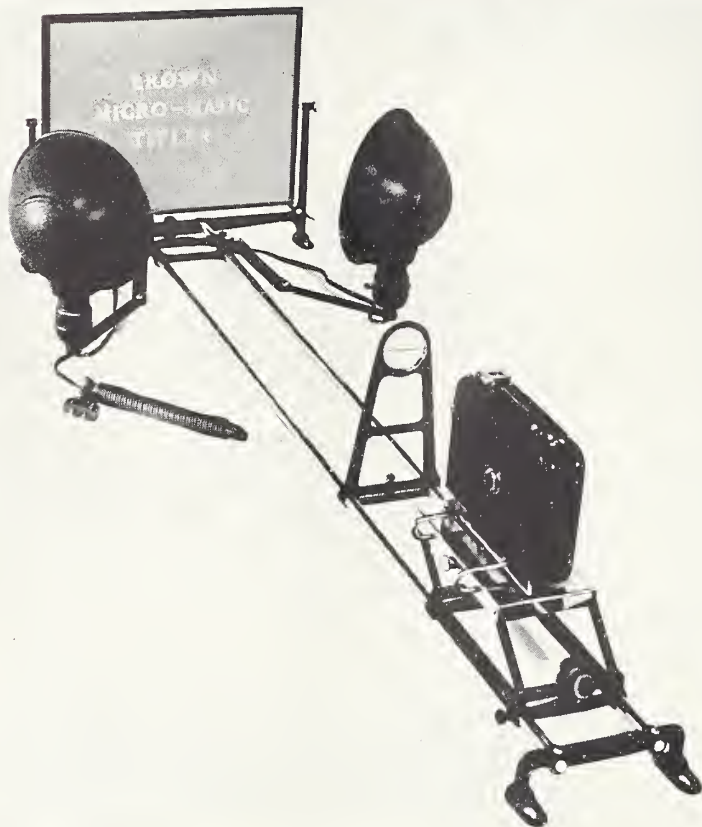

The Brown Micro-Matic Titler

ENABLES YOU TO DRESS UP FILMS WITH UNLIMITED TRICK EFFECTS

Flip-Flops . . . Zooms . . . Receding Titles . . . Silhouettes
Shadows . . . Turn Arounds . . . Fade-Ins . . . Fade-Outs
Handwriting . . . Moving Letter . . . Book Covers . . . Animation

Only Your Imagination Will Limit You!

No other titler gives the amateur the optical bench precision found in the Brown, throughout its 31-inch range. It's precision built. Low-cost high-quality supplemental lens are available for fixed-focus cameras or close-ups.

Cork, clear glass, and opal glass backgrounds are provided as standard equipment. The title frame is so designed that you can use any background you wish for novelty or special treatment.

FEATURES Vertical or Horizontal Mounting (Trick Effects Either Way) Self-locking Camera Mount . . . Accurate Field-of-view Chart . . . Self-centering Lens Holder (Holds Masks Also) . . . Full Adjustable Reflectors . . . Positive Target Centering . . . All Metal (Micrometer Machined) . . . Fits Any Camera . . . Twelve-foot Extension Cord.

THE BROWN MICRO-MATIC TITLER IS FULLY GUARANTEED

Price \$27.50 Complete



Pat. Pending.

See Your Nearest Dealer or Write Direct to

BROWN CINE PRODUCTS
2901 18th Street, N. W.
Washington, D. C.

Information PLEASE

Exposure (Francis Reib-scheid, Colo. Springs, Colo.)

How does one film a scene, adequately exposed, of a man in a darkened room—such as a burglar? I mean, what method of lighting is used?

Spotlighting will effect best results in a scene of this kind. The small, low-cost spotlights now on the market are adequate for this type of photography.

Why No Filter?! (H. E. Speer, Stratford, Conn.)

On the packaging of some of the low-cost semi-ortho film I have recently purchased, I find notice to the effect filters must not be used with it. These films are rated between Weston 8 and Weston 12, which seems high enough to allow for use of a filter. Is it safe to try a filter?

The reason filters are not recommended for use with ortho or semi-ortho films is not because of their low Weston rating, but because ortho emulsions are not sensitive to red. The purpose of any filter is to hold back certain colors, permitting the rays of red to penetrate to the film emulsion in a greater ratio. Pan-chromatic emulsions are sensitive to red, and are therefore the only emulsions that react satisfactorily to filters.

Some ortho emulsion films, however, like Agfa's Plenachrome, react favorably to light yellow filters, giving a pleasing medium correction of overall tones.

Wants More Detail (R. H. Swartzwelder, Lansdowne, Penna.)

How can I get more detail, especially in the faces of my subjects, when filming with Kodachrome?

Use of a sunlight reflector to reflect added light into the shadows is the best remedy for your trouble. A reflector may easily be made from a large sheet of cardboard or wallboard, covered with tinfoil or sil-

• READERS: This department is for your benefit. Send in your problems and our technical board of professional cameramen will answer your question in these columns. If an answer by mail is desired, enclose addressed stamped envelope.

ver leaf. In the absence of such a reflector, a large piece of white paper, a white sheet, or even a sheet of bright tin will serve the purpose.

Titles (E. E. Leonhart, Sacramento, Calif.)

How can I make good titles that will screen with white letters on a black background without using the direct-positive method with positive film? I have a small printing press and can print black on white stock; but to print white on black is a job even for a commercial printer.

You can print the kind of cards necessary for shooting white lettered titles on black backgrounds with reversal film, in this way: First secure a quantity of fine aluminum powder from a printer's supply house. Then print your title cards—with white ink on black cards—and dust each card with the alumi-

• Continued on Page 254

Whatsa

HALATION

• Halation occurs in exterior shots when dark objects are photographed against a brilliant sky or sunset; or, in indoor photography, when it shows as a spreading of light from unshuttered windows in the scene. Also, halation may be caused through reflection of light from the lens by some bright metal part within the camera, such as the pressure plate of the film gate. For this reason, the metal parts of most modern cameras — especially those about the film aperture — are finished in dull black. To minimize the halation bugaboo, most films are now manufactured with an anti-halation or non-halation backing.

A PROFESSIONAL TITLER FOR THE AMATEUR



See it

AT CAMERA STORES JUNE 1st

- ATTRACTIVE STYLING
- ONE-HAND OPERATION
- SIMPLIFIED LIGHT SCALE
- SIMPLIFIED CALCULATOR
- EXCLUSIVE LOCKING FEATURE

ORDER FROM YOUR DEALER—TODAY

GENERAL  ELECTRIC

Wesco's Winning Combination... FADETTE and FADE-O-MASK assure amateur movie makers PROFESSIONAL RESULTS!

Here's an unsolicited
testimonial from an
enthusiastic user.

Dear Sirs:

I recently bought from a Los Angeles dealer, one of your "Fadette" and "Fade-O-Mask" sets, and have just got back the first roll of film taken with it. I am highly pleased with the result. Any doubts expressed by some as to the sharpness of masks so close to the lens are entirely dispelled.

With my lens wide open - 2.5 - the outline was soft, but distinctive and very pleasing, while stopped down to F11 and f16, was razor sharp. The "Fadette" was very smooth and pleasing in its work. I will take every opportunity to boost your "gadget".

Yours truly,

Signed - *G. J. O.

P. S. - I use a Bell & Howell 8mm Filmo. I saw your ad and read description in "Home Movies".

*Name furnished upon request.

You too, will be highly pleased with the results you can get in your home movies with this Fade-in and Fade-out and these 6 popular masking effects.

Wesco FADETTE
combined with
FADE-O-MASK

WESCO FADETTE — the only vignetter producing a rectangular fade of ANY desired speed. Gradual Fading—In or Out—Fast or Slow at the will of the operator. NO SUDDEN SHUT OFF. Light weight... rugged construction. Fits most all cameras. Comes with cable release and filter holder. **\$5.95**

Special adapter for Eastman lenses, 75c. When ordering, specify make and model of camera.

Ask Your Dealer for a Demonstration

WESTERN MOVIE SUPPLY CO.
254 SUTTER STREET • SAN FRANCISCO, CALIF.

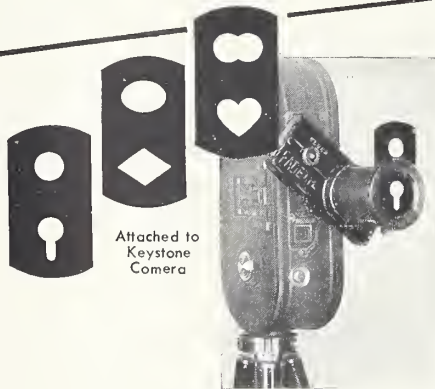

Attached to
Keystone
Camera

Now specially priced
complete with holder
and 3 double masks **\$7.75**

WESCO FADE-O-MASK — holder of durable tenite, takes the place of filter holder. Attached quickly and easily to the Fadette. The Wesco Fade-O-Masks of thin flexible pyralin are quickly and easily interchangeable, and give the movie maker an unlimited range of novel effects. **\$2.50**

The Reader



SPEAKS

Wants Super Camera

Here's a reader who wishes to convert his Keystone "8" into a "Dream" camera — wants aid or suggestions from other cinebugs.

Gentlemen: I have been a religious reader of HOME MOVIES for the past two years. Recently I was presented with a Keystone "8." In the past you have published many articles about "Super" and "Dream" cameras. How about a Super Keystone Eight? Do you know of anyone who could help me turret my camera, and install a backwind, etc., on same? I have the chance to use regular machine shop equipment.

—A. Kozyzanowski.

Another Recruit!

This is just one of many letters that come to us daily expressing not only keen interest but a desire to help in furthering HOME MOVIES' "Showings for Shut-ins" movement. The need is for more films.

Dear Sirs: Would be glad to do my part in putting on shows for "shut-ins" in the movement that HOME MOVIES has taken up, if you can aid me in obtaining use of the films—silent or sound—necessary for such shows. Have recently screened films twice for a local orphan's home, but rental of films runs too high to give these shows very often. Have dozens of other places in mind to show pictures, so I would be thankful for any assistance in securing films. I have a sound projector.

—Stuart Ogg,
4955 Kenmore,
Chicago, Ill.

New Use For Titles

Here's an interesting note from a reader relating how he made double use of the title backgrounds published in HOME MOVIES.

Gentlemen: Thought you might be interested to know I found the title backgrounds you publish each month excellent for titles for my 2"x2" Kodachrome

slides. Like titles in a well edited movie, they help greatly in telling a story with slides, too. Incidentally, why not an article some time on the subject of using titles with 2"x2" slides, which often supplement home movie showings?

—Cecil R. Nelin.

Like This Idea?

If you do, write and tell us, offering any further suggestions you may have on the subject, and HOME MOVIES will get solidly behind the idea if sufficient cinebugs are interested.

Dear Sirs: During the travels of many of our amateur movie makers, we have by chance made the acquaintance of members of cine clubs from other cities. The suggestion has been offered that you assist us in standardizing an emblem for amateur movie makers that could be adopted by all cine clubs. Thus, such an emblem, when worn as a key, pin, or otherwise — as we are doing in our club at present — would identify the wearer as an amateur movie friend.

It is our idea that the use of some one emblem become nation wide, so that members of one club may more readily recognize and come to know the members of other cine clubs.

—Irwin Sipherd,
Pittsburgh Amateur Cine Club.

Traders' Corner

Have you films you want to swap? Want to make some footage for a brother cinebug in exchange for something you want? Here are some more "swap" requests:

Sirs: Desire to trade 8mm film taken of children's Jiu Jitsu group and Jiu Jitsu demonstrations, for 8mm or 16mm scenes of other sports. — R. C. Service, 30 Warrington St., Providence, R. I.

Gentlemen: I am anxious to contact a few 8mm filmmakers in Georgia, North Carolina, and South Carolina, for Kodachrome shots of

• Continued on Page 256

Wollensak means Good Lenses



"In the Bobbie Burns Group—Canadian Rockies," by Georgia Engelhard, member of the Camera Club of New York City, who is rated as leading woman mountaineer by the American Alpine Club. Notice how clearly enlargement brings out full detail in glaring snow and on shadowed rock. Taken with a 2¼ x 3¼ Speed Graphic, exposure 1/100 at f_{22} , through a 3½-inch Wollensak Velostigmat.* Enlarged with a Series 11, $f_{4.5}$ 6½-inch Wollensak Velostigmat.* Miss Engelhard uses Wollensak lenses for all of her work. Improve *your* photography with a Wollensak. *Reg. U. S. Pat. Off.

For Movies, Candid, Enlarging, Action, Stills

WOLLENSAK OPTICAL CO., ROCHESTER, N.Y.

AMAZING 16MM VICTOR CAMERA GETS ALL SHOTS

Indoor shots, outdoor shots, slow motion, telephoto shots — all have a professional brilliance when taken with a Victor camera. Precision-built Victor Model 4 camera offers: Full Vision Focusing for Sharp Images — 3 Lens Revolving Turret — 5 speeds including Slow Motion to 72 Frames — Geared Film Footage Meter — Hand Crank for Continuous Filming. Learn about this remarkable camera before the big outdoor season starts.

VICTOR CAPTURES
Life Action Color
WITH PROFESSIONAL RESULTS

THE NEW VICTOR "SILENT 16" Heralds a New Day in 16mm Silent Projection

Again, in the new "Silent 16," Victor ingenuity firmly establishes Victor as the leader in 16mm film projection. More silent operation. Fewer Moving Parts — Disappearing Reel Arms — Automatic "Rewind-As-You-Show" — Victor's Famous and Absolute Film Protection — Lamp Switch — Reverse Switch — Pilot Light and many others. Convenient carrying case provides extra space for tools, reels, lamp and accessories.

ASK ANY QUALIFIED PHOTOGRAPHIC DEALER — OR WRITE
ANIMATOGRAPH CORP.
Dept. B-1 Davenport, Iowa

BACKYARD MOVIES

Ideas for Short Films

Skit for Roller Skates

Here is a short filming idea which I recently filmed with great success. We titled it "8 Wheels and a Girl." It is a simple story, but a swell idea for making movies of your wife and child with a little continuity.

It starts out with a girl about six or eight years of age (or it could be a boy) seated on the front steps rather impatiently. She looks anxiously down the street. There's a sudden expression of joy and she gets up and runs out to the sidewalk and down the street to meet her mother who is returning from shopping with a sizable package under her arm.

The youngster begs for the package and mother allows her to carry it. Upon reaching home, we show, with a closeup, tiny hands opening the package. Then the expression of joy as the little girl discovers the package contains a pair of roller skates. There's a shot of mother and the youngster as the latter impatiently tries to put on the skates. Mother helps her and then she tries them out.

Outside on the sidewalk, the youngster finds difficulty in keeping her feet, falling down frequently. Mother comes out of the house with pillow and cord, and ties pillow on youngster's back to ease her fall. She continues to fall and in utter disgust, takes off the skates, carries them to the trash heap in the yard and discards them. As she starts to walk away she suffers a change of heart, picks up the skates.

As she bends over to pick up the skates with her back toward camera, her dress goes up, revealing the words "The End" painted on the seat of her panties.

—J. C. Neuffer.

"That's My Pop!"

As a rule Dads appear very seldom in their own home movies. They're usually behind the camera, pressing the button. But here is a backyard movie idea that will give Dad a break, providing he will

trust some other member of the family to do the shooting, or if his camera is equipped with either a remote control or a camera button lock. The title is taken from that well known cartoon feature — "That's my Pop!"

In addition to "Pop," the cast can be made up of your son or daughter, and an assortment of neighbors' boys or girls. For the shots of "Pop's" son preceding each spoken title — "That's my Pop!" — a different boy or girl should be used each time.

Start your story with a medium shot of Pop fishing. He's reeling in a big one. The fish — a large one — is landed. Cut to a medium closeup of Son and a neighbor boy as Son says, with a proud expression, "That's my Pop!"

Next a sequence of Pop playing golf. He tees off, with family standing nearby on tee. The drive is a long one, which can be conveyed by a low angle view of those in scene watching the ball, carefully following it in its flight. Cut to another closeup of Son speaking to another playmate as they remark about Pop's swell drive and as Son proudly exclaims, "That's my Pop!"

Make similar sequences of Pop playing tennis, cutting antics on a bicycle, and any other events you wish to include — each time completing the sequence with

• Continued on Page 253

For ROCK-STEADY

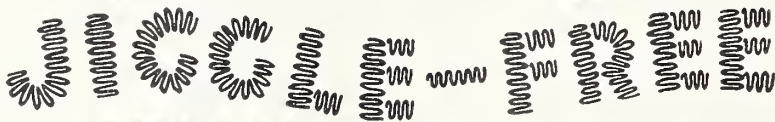

MOVIES USE THE ALBERT ROYAL TRIPOD

All-Metal—Telescoping—
Chrome-Plated Steel

ANOTHER **\$750** TILT TOP EXTRA
ALBERT VALUE AT

• All metal (tubular chrome plated steel and bar) construction gives utmost rigidity and strength to withstand shocks.

• Quick lock adjustment feature instantly and securely locks legs at any desired length (see arrow); with a quarter turn the leg is free to slide to new position — another twist locks it tight.

• Rubber tipped legs prevent sliding and marring floors and prevent slipping on any smooth surface.

• Combination patented panoraming and tilting top. Will tilt full 180 degs. and panoram 360 degs. You can lock the panoraming feature or tilting feature independently. Precision machined parts make the camera movement smooth. The easy grip handle gives you perfect control at all times. Folds conveniently flat against tripod for easy carrying.

COMPLETE
\$1250

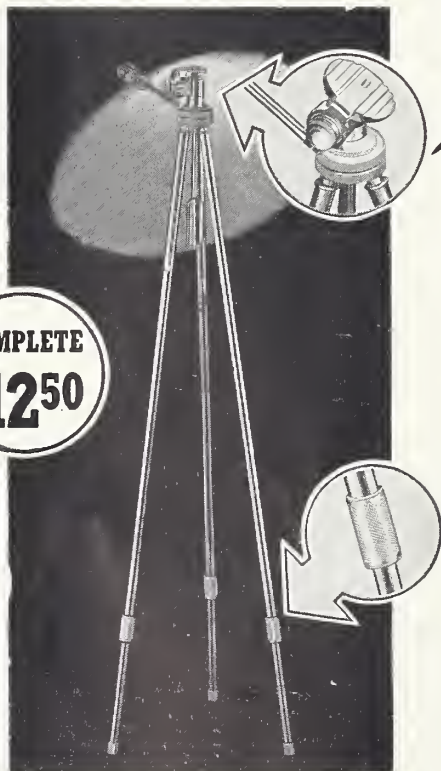

Albert
SPECIALTY CO.

CHICAGO . . . NEW YORK
Main Office and Factory: 231 S. Green St., Chicago

See it at Your Dealer's. Write Us for Descriptive Circular, Dept. E-6.

• We want suggestions and ideas for random "backyard" filming; also for simple home movie scenarios. Those which are published will bring the contributors either a 100-ft. 16mm or a 50-ft. 8mm film subject selected from the advertisements or catalogues of any library or producer-advertiser in HOME MOVIES magazine.

For ideas that can be adopted to a feature length article we will reward the contributor with two rolls of panchromatic film. Address your suggestions to BACKYARD MOVIES, care of HOME MOVIES, 6060 Sunset Boulevard, Hollywood, Calif.

Partial List of PROMINENT USERS of DA-LITE SCREENS

ADDRESSOGRAPH-MULTIGRAPH CORP.
AIRWAY ELECTRIC APPLIANCE CORP.
ALLIS-CHALMERS MFG. CO.
CALIFORNIA FRUIT GROWERS
EXCHANGE
CHICAGO FILM LABORATORY, INC.
CHICAGO & NORTHWESTERN RAILROAD
CHRYSLER CORP.
COMMONWEALTH EDISON CO.
COOPERS, INC.
DEERE & CO.
DE VILBISS CO.
DIXIE-VORTEX CO.
E. I. DuPONT de NEMOURS & CO.
REUBEN H. DONNELLEY CORP.
FISK TIRES, Division of U. S.
Tire Dealers Corp.
GENERAL MOTORS CORP.
THE GREYHOUND MANAGEMENT CO.
THE JAM HANDY ORGANIZATION
HART, SCHAFFNER & MARX CO.
HOUSEHOLD FINANCE CORP.
INTERNATIONAL BUSINESS MACHINES

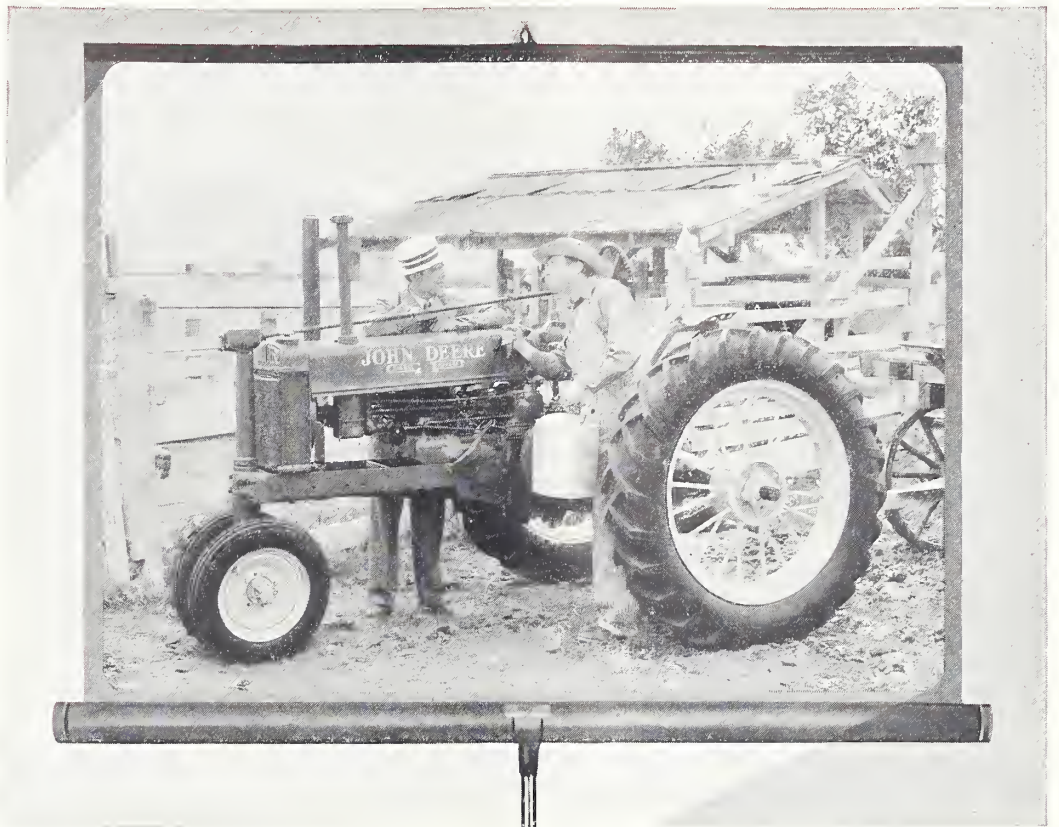

Scene from the Tuttle Tugger, motion picture film of Deere & Co. as shown on a Da-Lite Challenger Screen.

When Their Pictures Mean Business or Their Business Is Pictures

INTERNATIONAL HARVESTER CO.
INVESTORS SYNDICATE
JEWELL TEA CO., INC.
JOHNS-MANVILLE CO.
S. C. JOHNSON & SONS, INC.
LEE HAT CO.
LIBBY, McNEIL & LIBBY
LUMBERMEN'S MUTUAL CASUALTY CO.
MODERN TALKING PICTURE
SERVICE, INC.
MODINE MFG. CO.
JOHN MORRELL & CO.
PACKARD MOTOR CAR CO.
THE PENNSYLVANIA RAILROAD CO.
PROCTER & GAMBLE CO.
THE PURE OIL CO.
SAFETY GLASS ASSOCIATION
SCHULZE BAKING CO.
STEWART-WARNER CORP.
THE STUDEBAKER CORP.
TALKING SALES PICTURES
THE TEXAS CO.
WEYERHAUSER SALES CO.
WILDING PICTURE PRODUCTIONS, INC.
WILLARD STORAGE CO.

They
use



(Reg. U.S. Pat. Off.)

SCREENS

Companies which invest thousands of dollars in motion pictures or slide-films for sales work or personnel training use Da-Lite Screens to insure perfect projection.

Professionals who make industrial films and want to be sure that their productions are shown at their best use and recommend Da-Lite Screens. Theatres, museums, schools and universities which use motion pictures or slides for entertainment or instruction choose Da-Lite Screens to be sure of thoroughly satisfactory showings.



The Da-Lite Junior Screen can be set up on a table or hung against the wall. It has as fine a glass-beaded surface as the highest priced screen in the Da-Lite line. From \$2.00 up. Slightly higher on Pacific Coast.

When you choose screens for your home movies or projected color slides, take a tip from these careful buyers! Specify DA-LITE and look for the familiar Da-Lite trade-mark when you buy.

Da-Lite Screens are available in many styles, including the famous Challenger (tripod model) which can be set up instantly anywhere. Ask your dealer for a demonstration! Write for literature!

DA-LITE SCREEN COMPANY, Inc.

Dept. 5HM

2723 N. Crawford Ave.

Chicago, Ill.

DA-LITE SCREENS

AND MOVIE ACCESSORIES

With the PRO-16's



THERE'S A REAL SATISFACTION IN PROJECTING MOVIES THAT LOOK PROFESSIONAL, THAT HAVE THEATRE QUALITY!

This satisfaction is the regular experience of Gevaert Reversal Film movie makers. They know that whatever scene they shoot, Gevaert film will reproduce it faithfully—beautifully—will aid their carefully worked out movie technique. Listed below are the three popular brands of Reversal Film used by amateurs all over the world. They are supplied both in daylight loading and laboratory packing.

LIST PRICES AND SIZES

Price includes processing	Panchro Super Reversal	Fanchro Microgran Reversal	Ortho Reversal
16 mm. 100 ft. DAYLIGHT SPOOLS	\$6.00	\$4.50	\$4.50
16 mm. 50 ft. DAYLIGHT SPOOLS	3.25	2.50	2.50
Double 8 mm. 25 ft. DAYLIGHT SPOOLS	2.25	2.00	2.00
Sold without processing			
16 mm. 200 ft. LABORATORY PACKED	6.60	6.00	6.00
Double 8 mm. 100 ft. LABORATORY PACKED	3.60	3.30	3.30



Gevaert Processing Laboratories are located at convenient centers all over the world. Prompt reversal service is thus assured the movie maker everywhere.

THE GEVAERT COMPANY OF AMERICA, INC.

423 WEST 55th STREET, NEW YORK

Boston • Philadelphia • Chicago • Los Angeles • San Francisco • Seattle
Gevaert (Canada) Limited — Toronto • Montreal • Winnipeg

Slot Machine Movies

Just over the horizon looms what portends to be a new cine industry—nickel-in-the-slot movies. And it is especially interesting to serious cinefilmmers because the slot machine projectors will use 16mm films—both sound and silent.

Among recent announcements to reach the general public is that James Roosevelt, son of the President, has formed a company to produce the nickel-in-the-slot film, with a separate company for producing the necessary projectors.

Another new company—Phonovision Corporation—has been organized in Beverly Hills to turn out dime-in-the-slot projectors and films for same.

Most recent of all reports is that Edgar Bergen and his knee pal, Charlie McCarthy, will not re-sign with Universal Pictures when their current contract expires, but will organize a company of their own to produce Bergen-McCarthy shorts for the slot-machine projectors.

So you see, there is really a lot stirring in this direction. Ambitious amateur film producers will undoubtedly see the dawning of new opportunities for them far more definite and promising than when visual education first began to be talked about.

Dairy Film

R. S. MacCollister, San Francisco, is busily engaged shooting final scenes on an 800-foot silent Kodachrome production for the Bell-Brook Dairies, Inc., of that city. This film, when completed, will show the production of grade A milk from clover in the meadow to the tumbler on the break-fast table.

Many problems have been encountered and overcome during production, according to MacCollister. In addition to having to shoot Kodachrome in fog ten minutes before dawn, the most trying problem was that of photographing the color of stainless steel in the dairy equipment in its natural

• News of readers' activities in business, school, and publicity film production.

tones. It photographed brown instead of the usual blue. To correct this, a blue spotlight was turned on the metal parts.

New Biz-Film Group

For a long time the filming activities of Edward J. Pyle, Jr., of the Los Angeles 16mm Cine Club have been the envy of his associates. Recently Pyle, along with several pro and semi-pro cinematographers, formed a company for the production of 16mm color motion pictures for advertising purposes. The company has been established under the name of Hollywood Industrial Pictures, with headquarters in the filming capital at 1715 N. Mariposa Street.

Their latest color production was previewed recently before an imposing group at the Los Angeles Biltmore Hotel. Here is another instance of a group of amateurs "graduating" into the money class, producing cine films for practical purposes.

Madden Films Scenic

Ross Madden, contributing photographer for HOME MOVIES and long the "still man" for Charlie Herbert, ace newsreel and March of Time cinematographer, recently embarked on his own as producer of 16mm publicity films. He has been engaged by a Tucson travel agency to film several travelogues in Arizona, New Mexico, and Colorado.

Madden's productions will be all-silent. His equipment consists of a regular Victor model 5 cine camera, a modest assortment of lenses and a keen noodle for composition and continuity.

Dog Food Film

Alex McDonell of Oklahoma City, Okla., is reported to have been commis-

• Continued on Page 255

4 STAR



Titler

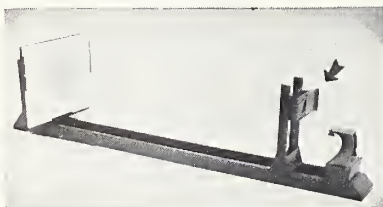

RIGHT OUT OF HOLLYWOOD, where movies are made, comes this newest of titlers that will produce every popular cinematic trick and effect in Home Movie titles!



Adjustable camera base accommodates every make of 8mm, 9½mm, and 16mm camera. Alignment and centering of titles is simple and accurate. Title board is readily adjustable to either small type-written or large 9"x12" title cards.



The Four-Star Titler will make practically every wanted kind of standard movie title, including zoom titles, wipe-off titles, etc. Additional accessories, available at small cost, make possible scroll, flop-over, superimposed titles, and others.

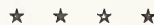

The Four-Star Titler is sturdily built. All-metal construction insures accuracy and durability. Price, complete as shown in Fig. 1, above, including two supplemental close-up lenses, but without lights—

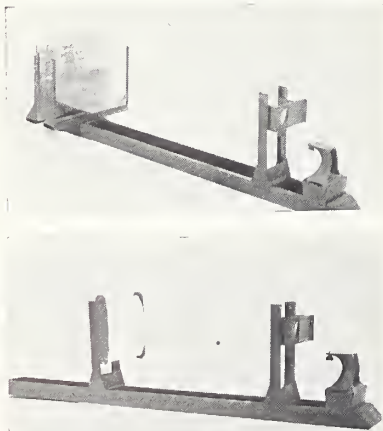

• Top—Titler complete with supplemental lens holder and built-in wipe-off device. Center—Showing glass bracket in place, used in making superimposed titles. Price, \$2.50. Bottom—Shows Scroll Titling device in use. Price, \$4.50 additional.

\$13⁷⁵

Lights, \$4.50 Extra

HOLLYWOOD CINE PRODUCTS CO.

3221 South Figueroa Street

Los Angeles, Calif.



EVERYTHING YOU NEED

WRICOPRINT

LETTERING SETS

The quickest, easiest, most economical way to letter your movie titles perfectly is available now at a price everyone can afford.

When you letter your own titles with the new inexpensive WRICOPRINT, they will equal the work of professional artists. They will be your titles and you'll enjoy making them.

See WRICOPRINT at your dealer's or write for illustrated bulletin M-B.

WOOD-REGAN INSTRUMENT CO., INC.
NUTLEY, N. J.



ADD THRILLING SOUND

to your movies . . .



At a fraction of the cost of sound-on-film. The FIDELITONE is ideal for adding music, sound effects, and speech to amateur films. **TEN DAYS FREE TRIAL.** Licensed under E. R. P. I. patents.

Write for details, also free advice on "sound" questions.

GEORGE K. CULBERTSON COMPANY
46 LUVERNE AVE. SO.
MINNEAPOLIS, MINN.

A PERFECTED, PORTABLE, FLEXIBLE SOUND UNIT, PRICED FOR THE AMATEUR FIELD . . . AS SIMPLE TO OPERATE AS A RADIO



**MORE
OOMPH
FOR YOUR
HOME MOVIES**



with the CRAIG PROJECTO-EDITOR

It takes proper **Editing** to make modern fast-moving, interest-sustaining movies. **ACTION-EDIT** your films the Hollywood Studio way — transform random shots into smooth-running sequences that everyone will enjoy seeing.

The Projecto-Editor provides a unique viewing method — allows careful inspection, slow motion if desired, of **every** movement on its brilliant miniature screen. Films may be readily removed from the polished guides for quick cutting and splicing.

At all dealers — Ask for demonstration.

8mm. model, complete . . . **\$27.50**
16mm. model, complete . . . **\$49.50**

CRAIG MOVIE SUPPLY COMPANY

1053 S. OLIVE ST. • LOS ANGELES, CALIF.

"Makes Editing a Pleasure"

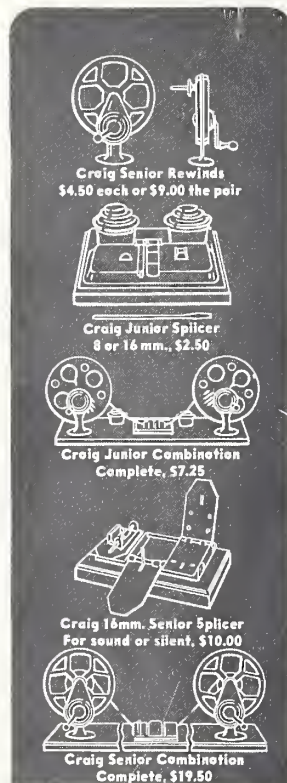

Craig Safety Film
Cement—25c



• TITLE TROUBLES •

By GEORGE W. CUSHMAN

IF YOU have any questions concerning titles or title making, Mr. Cushman will be glad to help you. You can address him in care of this magazine or direct to his home address, 3425 Witter Parkway, Des Moines, Iowa. Include all the information you can, such as type of film used, illumination, developer, etc. Don't forget to enclose a self-addressed, stamped envelope for your reply.

Q. I intend to use colored base positive film for titling my Kodachrome film and then tone the film another color. Is it possible to get three colors, such as a background of one color, letters of another, and border of still another?—C. F., Shilington, Pa.

A. I believe that two colors are the most you can expect. By using a tinted base such as yellow and toning it blue or green, you can get yellow letters on a green background, but I do not know what you would do to get a border of a third color. If any of our readers have the answer to this question, we feel sure this reader would appreciate any information. Has any reader had any experience in toning a film in two colors? If so, Mr. Charles Forney would like to know how it's done.

Q. My positive titles with 8mm film show too much grain for the letters to stand out clear and sharp. Can you furnish me with a good fine grain developer that gives good contrast?—M. S. W., Omaha, Neb.

A. If your letters are so small that the grain affects their legibility, then they certainly cannot be seen at any distance from the screen. Your best solution is to make your letters larger. If you have more than 25 letters in a line (includ-

ing spaces), then you have too many.

Q. I have tried several times but unsuccessfully to copy a newspaper page. I focus carefully but the letters do not come out clear and distinct. What is the trouble and how may I correct it?—H. C., Miami, Fla.

A. It is hard to say exactly what is wrong without seeing the results and knowing all of the conditions. The lens may be of poor quality or not sharp when wide open. Perhaps it is not set properly in its mount.

I would suggest you use more light and stop down the lens as far as possible. If this fails to bring the desired definition, then copy the newspaper with a plate camera. Make a sharp print on glossy paper and then photograph this print with an auxiliary lens on the movie camera. I have seen this method work where others failed.

Q. I have noticed titles having backgrounds which seem to fade and melt into one another and would like to produce some of these effects if possible. Can I do it with my 8mm camera?—A. L. L., Eagle Pass, Texas.

A. The professional studios have hundreds of ways of producing backgrounds with motion, such as you speak of, and many of their effects would be difficult for the amateur to copy. You can, however, come very close to such effects by the use of double and triple exposure. Set up the effect you want and photograph it, slowly moving it, underexposing slightly. Rewind the film and repeat the procedure, moving the background slowly the other way. Rewind the film and re-expose as many times as you wish. After this is done the title, which is made of white letters on a very black

• Continued on Page 256

NOW CASTLE FILMS BRINGS TO YOUR SCREEN THE NATION'S 5¢ WORLD'S FUN FROLIC!

16 MM • 8 MM MOVIES

CONEY ISLAND



FUN FOR YOUR HOME MOVIE!

Thousands of home movie fans demanded it. Now Castle Films brings you a merry cavalcade of action and fun! A rollicking screen-fest of fast and furious gaiety for your movie! All of this famed resort's upside-down, topsy-turvy merriment—all of its lusty flavor of laughter and thrills—all of its unbelievable bigness brought right to your own screen.

Did you ever see a million people at one time? They're

all in this joy reel having the time of their lives at Coney Island—and they'll give you a rousing time of it, too, right in your home.

Now you can treat yourself and your friends to a dynamic movie preview of what's in store when you come to New York. Add "CONEY ISLAND", the granddaddy of big fun spectacles, to your home movie collection.

PRICES Order from your Photo Dealer Today: 8 mm. 50 ft. \$1.75—180 ft. \$5.50
16 mm. 100 ft. \$3.50—360 ft. \$8.75 • Sound-on-film 350 ft.—\$17.50

CASTLE FILMS

30. ROCKEFELLER PLAZA
NEW YORK

WRIGLEY BUILDING
CHICAGO

RUSS BUILDING
SAN FRANCISCO

PERSONAL ORDER BLANK

Mail This to Your Photo Dealer
Today! Reserve for earliest delivery
"CONEY ISLAND"

.....mm. size foot length

Name.....

Address.....

City and State.....

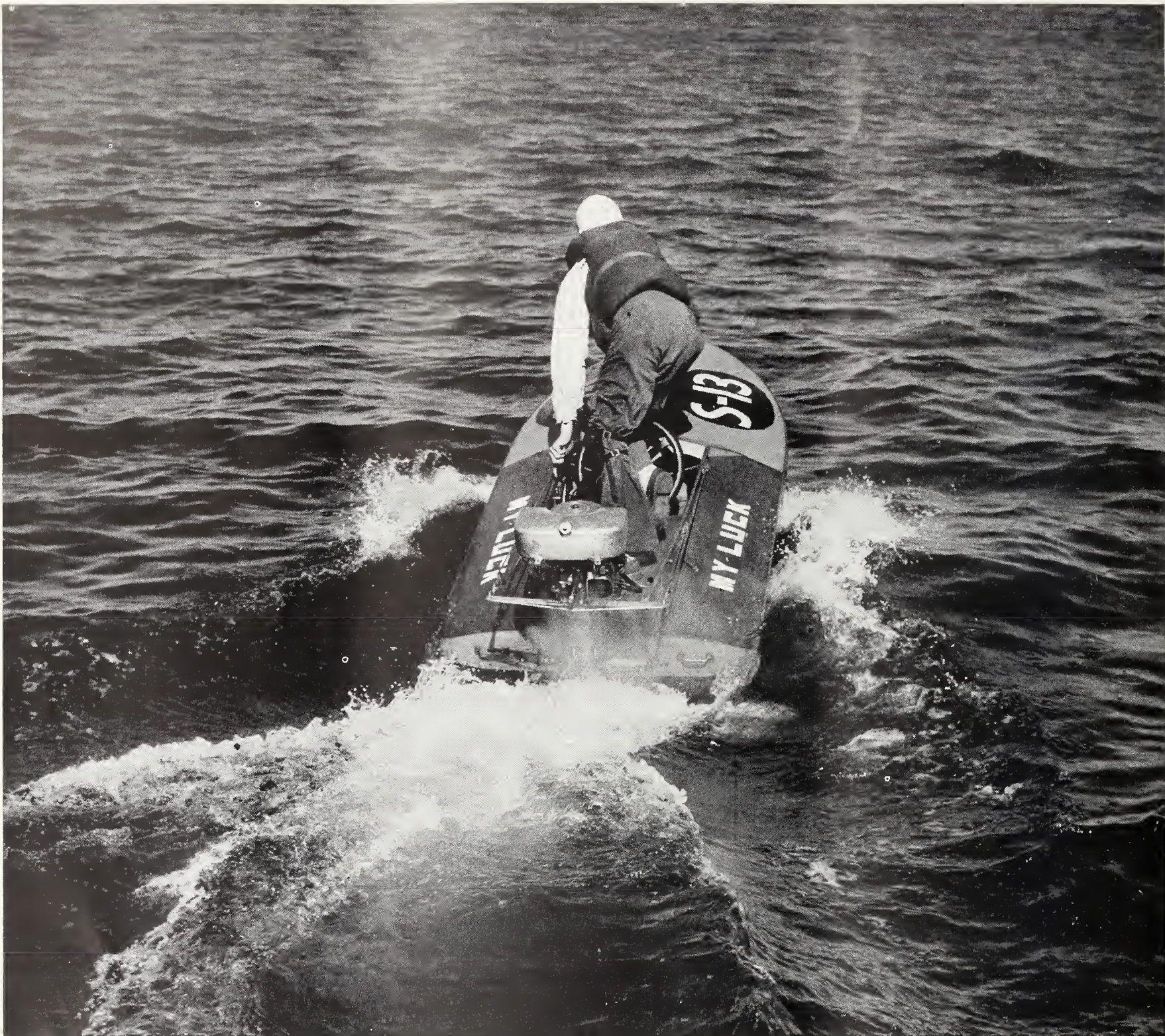

Hard to catch

THOSE hard-to-catch outdoor sequences won't get away from you—if you put the job up to Agfa 16 mm. Hypan Reversible Film!

Hypan will capture them for you with all the sharpness and contrast you could desire, and with a perfect rendering of all color values. Its fine-grain emulsion and anti-halation coating assure you of clear, brilliant projection.

FOR DOUBLE 8 MM. CAMERAS

"Twin Eight" Hypan Reversible is a great achievement for double 8 cameras. Its extra speed produces excellent

results both indoors and out; it has full color sensitivity, and an extremely fine-grained emulsion. "Twin Eight" Hypan is notable also for brilliance and wide latitude.

Either of these great films will add to your skill—try them today. Agfa 16 mm. Hypan Reversible is available in 100 ft. rolls at \$6.00; and in 50 ft. rolls at \$3.25. Agfa "Twin Eight" Hypan Reversible is available in 25 ft. (double width) rolls at \$2.25. These prices include processing and return postage.

Agfa Ansco, Binghamton, New York. Made in U. S. A.

Agfa
HYPAN
MOVIE FILM



HOME MOVIES

Published in Hollywood

MAY 1940



onstration of the fact that the milk of human kindness has not yet altogether curdled.

However, the greatest part of the job and joy of this movement remains to be accomplished and achieved. What is being presently done, though it is inspiring and laudable, is a scattered and limited attempt to bring cheer through screening of home movies to those in hospital wards, in wheel chairs, in sanatoria, and in homes. Among individuals, as well as some movie clubs, who are pioneering such shut-in showings the spirit is more than willing, but oftentimes the supply of films is weak and limited.

How to meet such limitations, how to keep alive

● Below, left to right: Axel Manson, president, Ampro Corporation, and E. S. Brackway, president, American Ballex Company, are among many leaders in cine industry heartily endorsing Home Movies' great humanitarian movement, Showing Movies to Shut-Ins.

SHOWINGS FOR SHUT-INS *gains momentum*

**Cine Manufacturers
Endorse Movement
Sponsored by Home Movies**

By WILLIAM MACGRATH

WHEN the editors of HOME MOVIES presented and advocated the plan of staging film showings for shut-ins, invalids and hospitalized groups a few issues back, little did they reckon they were launching an idea whose appeal and popularity would grow and gather speed like a snowball rolling downhill.

It was one of those seemingly timely and inspired suggestions that hit directly home to the humanitarian hearts and fancies of scores of readers of this magazine. Also it has drawn commendation, endorsement and even offers of cooperation from some of the leading figures among the manufacturers and distributors of home movie projectors and equipment. All in all, so wholehearted, keen and enthusiastic has been the approval and interest to date in this "Showings for Shut-Ins" movement, that it is a gratifying dem-

and expand this movement, is therefore presently the question to be dealt with. As a sponsor of showings for shut-ins, and as a voice reaching the nation-wide fraternity of home movie fans, the editors of this magazine reiterate their previously made offer to aid in increasing the supply and outlets of films, projectors, etc., for that purpose.

Here, and toward that end, we advance several suggestions whereby this can be accomplished by the individual cooperation of owners of home movie projectors and films. For instance, perhaps time or circumstance does not allow you the big thrill of putting on a show personally

● *Continued on Page 242*



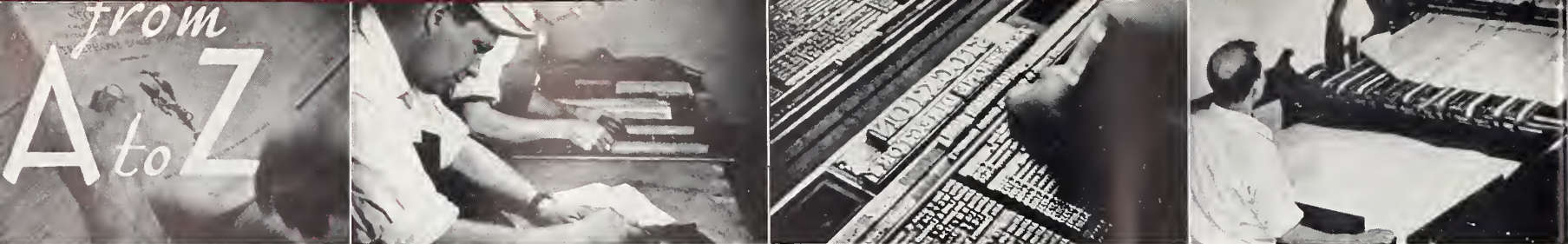

Reported by
J. H. SCHOEN

WHEN we want a doctor, a lawyer, or a pest exterminator, we usually refer to our telephone directory. The slogan, "You'll find it in the yellow pages," is now well known and consistently followed by most of us. Yet, one would hardly expect to find in a 'phone directory an idea for a home movie film. The countless lines of small type, the monotony of its unillustrated pages, offer little in the way of inspiration for a movie.

Yet one amateur movie maker saw the germ of a filming idea in the directory that hung on the wall near the telephone in his home. Why not, he reasoned, film the compilation, printing, binding and distribution of one of the most important publications in American life! And so, Vernon

that makes the picture more than ordinarily interesting to the layman.

Altree's camera followed the job from the compositor's bench to the pressroom where he recorded scenes showing presses of various size, turning out the printed pages of Stockton's 'phone directory. Each step — the feeding of huge sheets of paper into the press, the manner in which the presses handle the paper, are recorded in closeups, bringing the action right up close as you review the picture on the screen.

There is no lagging in interest as the picture goes on to show how the pages are gathered in the bindery, stapled into individual volumes, the covers applied, and the books counted and tied

"From A to Z" — MOVIE OF THE MONTH

Altree, an amateur cinefilmer of Stockton, Calif., set about to do just this. Recently, he submitted his completed film "From A to Z" to the editors of HOME MOVIES for review. It has been selected as the Movie of the Month for May.

Filed in Kodachrome, "From A to Z" runs a full 400 feet. It is a commercial type film — a documentary of telephone book production in which the printers of the Stockton directory cooperated with Altree by operating their presses and staff overtime in order to permit retakes, or furnishing power for the batteries of photofloods. "From A to Z" was filmed almost 100 per cent indoors.

The picture opens with scenes showing the directory staff compiling the subscribers' names, arranging them in alphabetical order, and later reading the proof sheets. Notable at this point is the manner in which Altree brought out the fact that all proofs are treble-checked to reduce to a minimum the omission of names and incorrect spelling.

Next we are shown lists in the linotyper's hands; type being set; and the page forms being arranged in the composing room. All of this was not skipped over lightly by Altree. When there was an interesting operation to explain, he moved his camera right up close, and recorded the action in a vivid, understandable closeup. Such closeups are frequent throughout the picture and it is this

into bundles. The finished directory is shown in closeup, and the story of its origin and production closes with scenes of huge trucks leaving the printer's to begin distribution of the directories to homes and business establishments in Stockton and vicinity.

Altree is to be commended for his fine photography and the fact he hit accurate exposure "right on the nose" every time — an accomplishment, considering the fact he used Kodachrome film indoors with nothing but amateur lighting equipment. We've seen lots of Technicolor films that were not exposed as well.

THE titling, too, was very thoroughly done. The main and credit titles were expertly executed. Cards were printed on letterpress, and photographed on tinted base film. Descriptive subtitles are ample to tie the story together and afford complete explanation where needed. We rather liked the simplicity of the main title, illustrated here, with its animated background.

We wish to emphasize that production of "From A to Z" was a one-man amateur job. Altree wrote the script, planned and executed the shots, made all the titles, and did the editing. Of course, almost every amateur does all of these things when he produces a "feature length" film. But making

• Continued on Page 254

• Photos bordering top and bottom of page are reproductions from Vernon Altree's 16mm Kodachrome film, "From A to Z," on excellent all-amateur mode documentary film pictorializing the production of a telephone directory.

(Photo on opposite page by Elmer Dyer)





Authored by
J. H. SCHOEN



C. E. Bell Photo

"THE FAMILY CHAMP"

a knockout script with titles

PROBABLY no other feature of HOME MOVIES ever brought such an avalanche of compliments as did "The Magic Wand" in the April issue. Judging from opinions of most of our readers, this new feature is just what many have been waiting for—simple home movie shooting scripts complete with title cards. For a limited time, therefore, HOME MOVIES will publish with titles each month the best original home movie skit contributed by a HOME MOVIES reader, and for which the contributor will receive three rolls of panchromatic film.

This month we present the complete shooting script and titles for "The Family Champ"—an easy-to-film movie that requires as actors, father, mother, and a small son. This interesting little story has to do with a red-blooded American boy and his father—both of whom possess the conviction that, with a little training in the manly art of self-defense, they could take care of all comers their size! The story may be filmed with 200 feet of 16mm or 100 feet of 8mm film. The time is the present; the place, your home.

Scene 1. Medium long shot of boy walking (toward camera) in an alley or on sidewalk. His appearance shows he has undergone some rough

treatment; his shirt is torn, shoelaces are untied, and his trousers are soiled. He approaches camera with head hung low, hands thrust deep in pockets. He is apparently in very low spirits, for as he walks along aimlessly, he kicks at every small object lying in his path. He stops, brushes hair out of his eyes, and feels of his eye. Cut to—

Scene 2. Closeup of boy revealing magnificent black eye, as he gently feels of same.

Scene 3. Back to scene 1 as boy continues walking. Follow him with slow panning action as he turns into his yard through gate.

Scene 4. Medium long shot of yard. Father is reclining comfortably on lawn chair or garden swing, reading paper. Boy enters scene, spies Father, then draws back, apparently in fear Father will reprimand him. Starts to tip-toe out of scene.

Scene 5. Closeup of Father in chair. Looks up; sees boy; expresses concern.

Scene 6. Medium shot of Father, similar to scene 5, but with boy in distance stealing out of scene. Father calls to him:

Title: "What's the trouble, Son?"

Scene 7. Back to scene 6. Father finishes speaking. Boy stops abruptly, looks toward Father, then with head down he walks over toward him.

Scene 8. Medium closeup, camera at low angle, as boy reaches Father's side. Father whistles as he spies black eye. Father turns son's head from side to side, carefully examining the damage. He smiles slightly and speaks:

Title: "That's sure a beauty, Son. How does the other fellow look?"

Scene 9. Back to scene 8, as Father finishes speaking. Boy looks away momentarily, rather shame-faced. Then turns to Father and says:

Title: "Aw, he was bigger'n me . . ."

Scene 10. Back to scene 9, as boy finishes speaking. Father laughs gently, and pats him on the head. Takes boy's hand in his. Sees skinned knuckle.

Scene 11. Closeup of skinned knuckle.

Scene 12. Back to scene 10. Boy explaining how knuckle was skinned. He steps back, striking a fighting pose, then goes through some sparring motions to show how he landed punch that injured the knuckle.

Scene 13. Same as 12, but farther back and at slightly different angle. Father laughing at boy's explanation, rises, throws arm about boy's shoulder, and both walk out of scene in direction of house. Fade-out.

Scene 14. Fade-in. Closeup of boy's face. Hand

• Continued on Page 244

• On the opposite page are all the titles necessary for "The Family Champ." There is an extra title background, too, for credit titles. Should they not fit the card holder of your typewriter titler, cut out and paste them on black cards cut to required size.

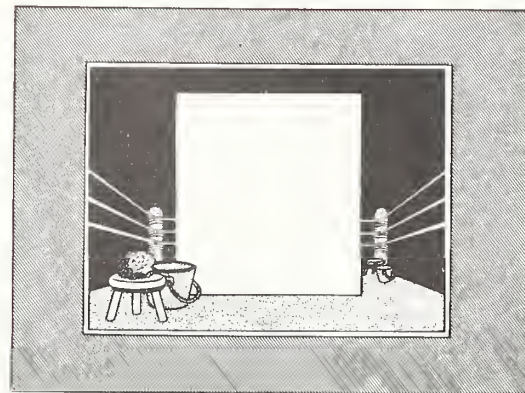
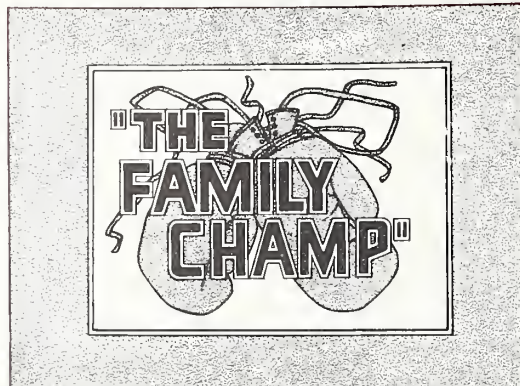
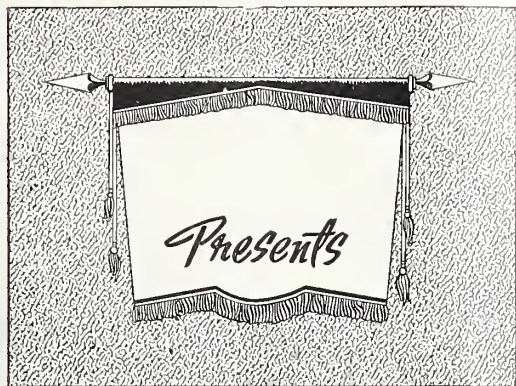

"What's the trouble,
Son . . .?"

"That's sure a beauty!
How does the other fel-
low look . . .?"

"Aw, he was bigger'n
me . . .!"

"There . . . that'll fix you
up . . ."

THE NEXT DAY

"Well, Son . . . now you
get your first real box-
ing lesson!"

"Look, Son . . . you must
always keep your left
up . . .!"

"Now you try to get
through my guard!"

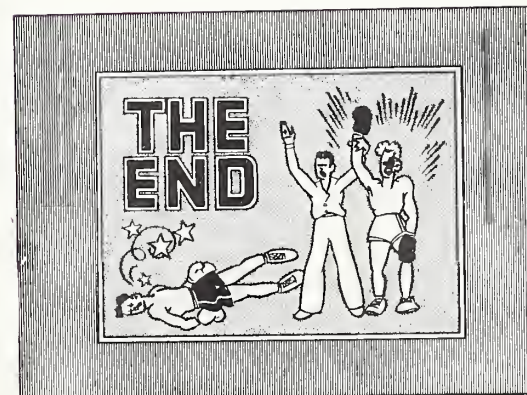



Authored by
HENRY FISHER

Photos Courtesy N. Y. World's Fair

PROBABLY no other single subject was so widely filmed last year as the New York World's Fair. And since its closing, late last summer, home movies of the Fair have been exhibited far and wide—some of them creating considerable desire upon the part of many for an opportunity to re-film some shots or perhaps shoot many points of interest overlooked on their Fair filming expedition.

Well, if you're one of such cinebugs, or one of the many who were unable to travel to the Fair last year, you are probably elated over the news that the Fair will reopen in May and continue throughout the summer. Perhaps already your

the Four Freedom Statues. At this time of day the side-lighting imparts fine definition to the giant Perisphere and the reflection of both structures in the water is more picturesque. For Pan film, a stop of f/8 is suggested. Kodachrome filmers should set the lens at f/6.3 in order to get full



A guide for amateurs **FILMING THE FAIR...**

1940 budget is being revamped to include a trip to the Fair, and cinefilming technique is being studied and improved with an eye toward bringing back on home movie film well-composed and properly exposed shots of all the important features of the Nation's No. 1 show.

HOME MOVIES believes it can be of some assistance to the amateur by setting down here tips and data on what, when, and where to film at the Fair, with exposure data for most locations, based upon the experiences of a number of cinefilmmers successfully filming the Fair last year. Of course, we cannot give you data on all locations, but we hope to touch upon the most important ones.

Obviously, any filming record of the Fair should start with an artistic view of the Fair's theme or symbol—the Trylon and Perisphere at Theme Center. The best time to make this shot is between 3 and 5 p.m. with camera set up at the extreme end of Constitution Mall, and under

tones in the side-lighting. There is no longer a ban on tripods, so bring yours along and use it consistently, if for no other reason than to stifle the urge to panoram promiscuously.

EARLY visitors to the Fair will find thousands of vari-colored Holland tulips in full bloom, lending the enchantment of color sought by Kodachrome filmers. Under normal light, the yellow tulips should record well at f/8, and those of darker hue at f/6.3.

For a marvelous over-all shot of the Fair, set up the camera on the balcony of the Belgium Exhibit

● Continued on Page 240

● On this and the opposite page are examples of good photographic composition for amateur movie makers to shoot at when filming the New York World's Fair this year. You can make similar good shots with careful planning and execution. Use the photo on opposite page for your World's Fair title background.



Authored by
FREDERICK E. STRAUSS



Southern Pacific Photo

Rare adventure awaits cinefilmmers—

DOWN MEXICO WAY!

“MEXICO has everything!” read the travel folder. “It is the perfect vacation land—superb scenery, picturesque old towns, interesting and colorful people, venerable traditions, quaint customs, magnificent old buildings steeped in romantic history, stupendous pre-historic ruins, a genuinely foreign atmosphere and even a foreign language. And to add to the enjoyment and comfort of your vacation, Mexico has a network of excellent paved highways; splendid modern hotels; every facility for sports, recreation and amusement; and a glorious climate the year round.”

Although the author of the travel folder may have exhausted his vocabulary of adjectives, nevertheless his statements are no exaggeration; and this, plus the unusually attractive current exchange rate on the Mexican peso—which is down to about 17c now—makes a trip to Mexico the logical choice of the cinefilmer seeking new worlds to conquer with his camera.

Traveling by automobile anywhere in Mexico is entirely safe. And with completion of the Pan-American highway from Laredo, Texas, to Mexico City, Americans are afforded easy access to the wonders often pictured in print of perhaps the most interesting part of the North American continent.

But whether the movie maker goes by rail or pavement, here are a few pointers that are well worth remembering:

1. Take along plenty of raw film stock. Invariably the demand is greater than the supply.

2. A safe rule to follow when hesitant about shooting scenes or objects is to “shoot first and ask afterwards!” There are no official restrictions on what you may film in Mexico except, of course, government buildings, fortifications, prisons, etc., the filming of which is prohibited for obvious reasons.

3. There is no limit on the number of rolls of film you are permitted to take into Mexico from the United States.

4. Substandard films (8mm or 16mm) do not have to be processed and inspected in Mexico. You may bring your exposed films back with you for processing if you desire.

5. All foreign made cameras must be registered with the U. S. customs office before entering Mexico, otherwise you may be compelled to pay customs duty on same when re-crossing the border

into the United States. Therefore, if yours is a Bolex, an Emel, a Leica, or any one of several foreign made cameras, be sure to register it.

6. Watch your equipment closely at all times to insure against theft. Insurance—if its coverage extends beyond the boundaries of the United States—is a wise investment.

Jack Treacy

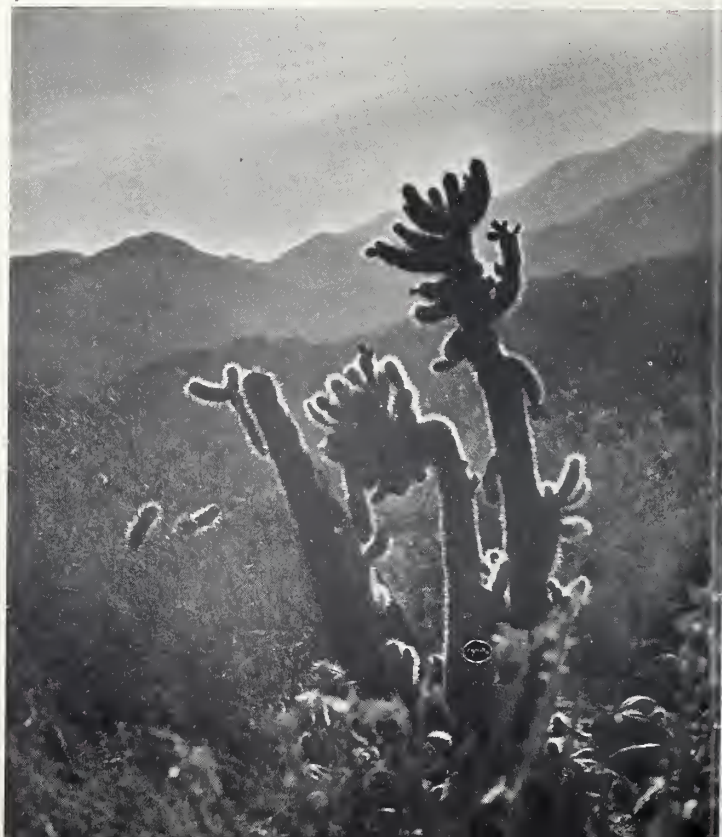

• The cinefilmer of today, entering Mexico for the first time, is due for as many thrills as Cortes, the discoverer, received four centuries ago. Mexico has archeological ruins so old that scientists can only guess at their antiquity.



Southern Pacific Photo

7. Last, but not least, be sure to carry a good supply of Mexican small change in your pockets. For seldom is one allowed any personal photographs without first "greasing the palm" of the subject. A bag of candy will go a long way and insure plenty of shots of quaint Mexican children.

ASSUMING that one's Mexican jaunt will begin at the northern terminus of the Pan-American highway at Laredo, important documentary filming can start at this point with the recording of such atmospheric shots as the family embarking in the car, the scanning of road maps, and pasting of the "Turista" sticker on the windshield. Then with a long shot of the International Bridge, the filming of one's trip to Mexico is definitely well on its way. Interesting shots may be had of the payment of tolls at the bridge gate, and closeups should be secured of the customs officials as they inspect and pass upon the cars.

After crossing the International Bridge, there isn't much in the way of interesting cine fare to satisfy the itching in one's trigger finger until approaching Monterrey — 145 miles below the border. But in the meantime, it is well to secure a few shots showing the car traveling down the highway and perhaps an occasional shot of the Mexican highway signs which register the dis-

tance between points in kilometers. Such shots will prove useful at the editing board to indicate lapse of time or distance from town to town along the route.

Monterrey is quite a large city, often referred to as the Pittsburgh of Mexico because it is probably the largest industrial center in the whole Republic. The traveler should pause in Monterrey at least long enough to film the handsome Cathedral; the new Federal palace; the Bull Ring, and other interesting sights of the city.

Monterrey is unique for the large army of itinerant bootblacks that descend upon the tourist like ants! — a scene which should not escape any cine camera lens. For nowhere in Mexico will there be found bootblacks in such numbers, nor as persistent. If you wish to be free of them, wear suede shoes.

AFTER leaving Monterrey, typical Mexican natives will be seen in increasing numbers, barefooted, wearing huge straw sombreros, and an inevitable lazy expression on their countenances. Orange groves, remindful of those in California, will be found bordering the highway in the vicinity of Montemorelos, 48 miles south of Monterrey.

An increasing number of native villages with thatched roofs will be found dotting the landscape

● There's plenty to see everywhere in Mexico, and the wise cinefilmer will begin his trip well supplied with film and a few filters. The scenes pictured here are but a few examples of the filming fare available in rural sections "south of the border."

● Continued on Page 246

Authored by
CHARLES A. MUNZ

Illustration by Author

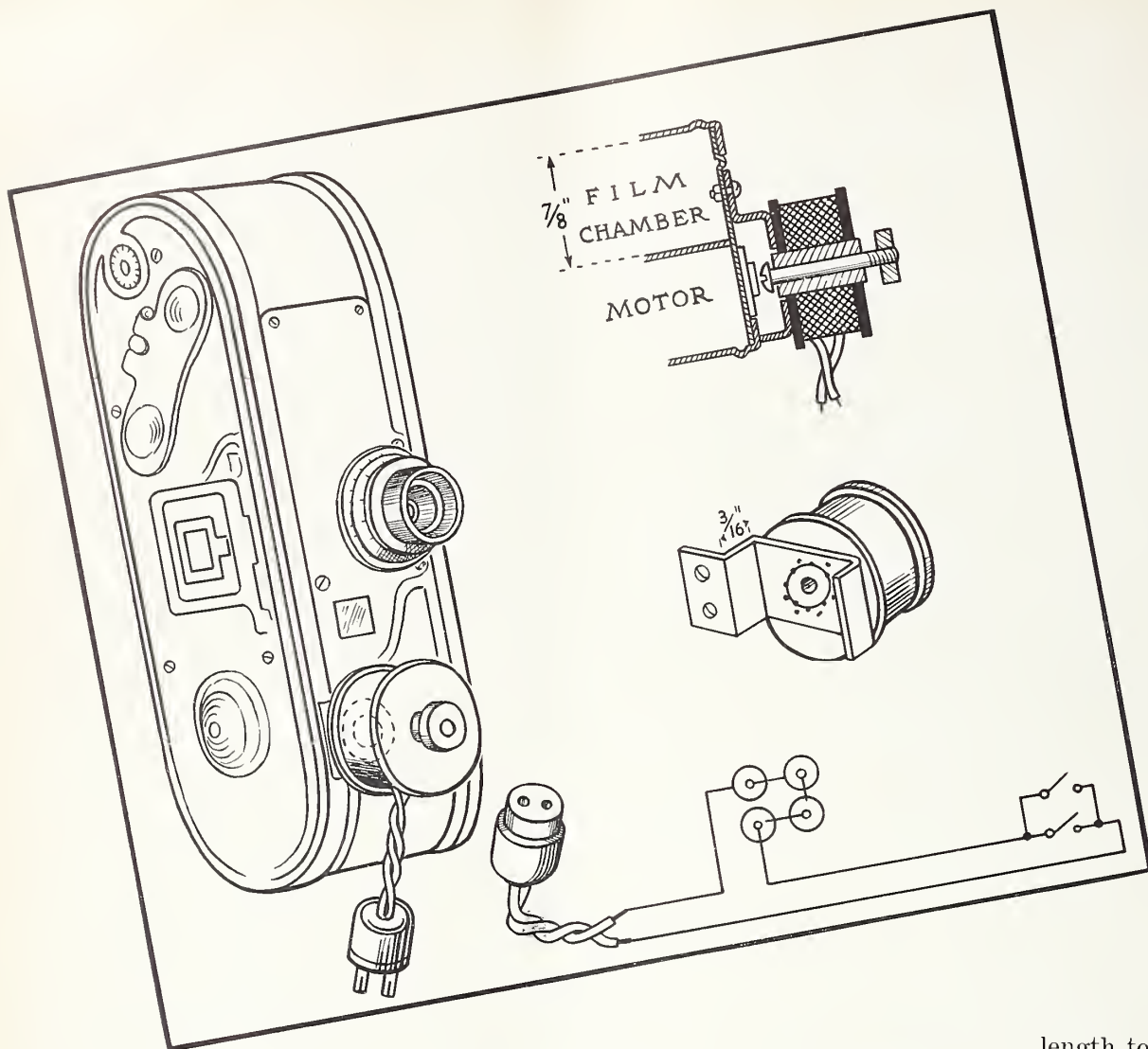

This magnetic control consists of an electric magnet of approximately 100 ohms resistance and is of the type used in relays in 6 volt circuits of most telephone equipment. The soft iron core should be between $\frac{1}{2}$ " and $\frac{5}{8}$ " in diameter and the overall diameter of the windings should be such as will permit mounting same on camera without interfering with the lens mount or viewfinder. For application to an 8mm Keystone camera as pictured, the overall diameter of the winding should not exceed $1\frac{1}{2}$ ".

The core is drilled axially on center, $\frac{9}{64}$ " diameter which provides for an easily sliding fit of a $\frac{6}{32}$ " brass machine screw of sufficient length to protrude beyond the core $\frac{1}{4}$ " to $\frac{5}{16}$ ". The armature—the metal "button" which fits on the threaded end of the brass screw as shown—is of soft iron of a diameter equal to or slightly larger than the diameter of the iron core and about $\frac{1}{8}$ " in thickness. This may be cut from a round iron bar, drilled, and threaded to fit the brass screw.

The mounting bracket is formed as shown from a strip of brass and drilled to snugly receive the protruding end of the magnet core which is made secure by riveting or punch-pricking the metal about the core.

The assembled magnet is then placed in proper position on the camera, clamped in place and drilled for small 4-40 screws and nuts. Care should be taken, in drilling the Keystone "8" camera, to stay well within the $\frac{7}{8}$ " depth of the film chamber indicated in the sketch. About $\frac{1}{2}$ " from the outer edge gives ample working space. With the bolt (plunger sliding through the magnet) fully depressing camera release button, adjust the iron armature or button to just clear the magnet core—not touching it. To maintain this adjustment the bolt threads may be mutilated or a small locknut employed.

FOUR flashlight battery cells furnish adequate current for operating this control, and they may be contained in a small box that is easily fastened to the tripod or placed on the ground beneath it. The cells should be connected in series by soldering wires to the pole and packet of each cell alternately.

Various types of switches may be used. I prefer to use two separate switches connected in parallel as shown in sketch—one, a push-button type for quick, instantaneous control for stop-motion

• Continued on Page 252

You can build this robot CAMERA CONTROL

HERE'S a handy little gadget—a sort of robot assistant cameraman to push the button for those amateurs whose tricky cinefilming operations often require the use of one, if not both hands in adjusting a figure in a table-top shot, winding the titler scroll, or operating the fade-out device on the camera. Originally developed for use on a Keystone "8," it may, nevertheless, be adapted to almost any make of 8mm or 16mm camera with equally successful results.

It will operate the camera starting button with unflinching positive action in making such shots as those in which you wish to appear yourself; shots of wild life where the camera must be concealed and the operator kept at a distance; and also for shooting stop motion in table top movies and trick titles.

It is a magnetic control—similar to a solenoid—yet easily constructed by any amateur from materials cached away in the garage, or readily procurable from an electric or radio supply store—possibly from your local "five and ten." The device, method of construction, and manner of attaching to camera are pictured in the sketch on this page.

• All parts necessary to build the magnetic camera release illustrated above may be purchased from almost any electrical supply or hardware store. Attached to your camera, it leaves hands free to operate effect devices, make fades, etc.

Authored by
GEORGE W. CUSHMAN

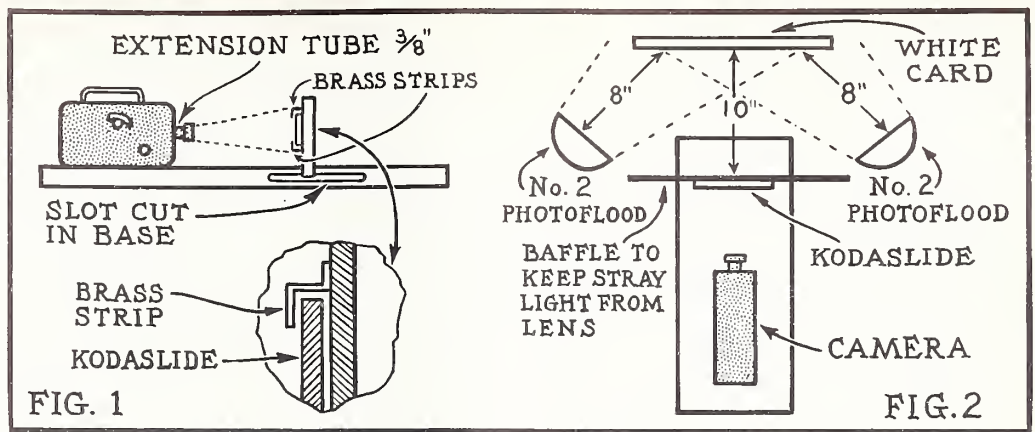

Pep up your movies with new TITLE TRICKS

HERE are a couple of rather novel title tricks. The first concerns photographing a banner towed by an airplane and the second describes another method of using the same background with different wordings.

Two or three months ago one of the questions answered in the "Title Trouble" column concerned how the amateur might go about photographing a title to resemble one of the advertising banners such as are towed through the sky by airplane. Mr. George W. Prediger of New York City saw this item, and, since he had succeeded in filming just such an effect, he was kind enough to tell us just how he did it, and supplied the diagrams reproduced here.

Mr. Prediger explains that, while employed by an aerial advertising company, he had occasion to make such shots. "First," he says, "it is necessary to secure a small model airplane, which can usually be found in a dime store or department store. Then, working on a scale proportional to the size of the model, make the banner as follows:

"Put 2 sets of 8 small brads or tacks into a board, about 2 feet apart. (See Fig. 4.) Between these sets of nails, stretch 8 lengths of string and draw them taut. Let any excess string lap over on the right hand end, in case the strings prove too short for the banner planned.

"Cut medium weight paper of any desired color in strips with a width proportional to the height of the letters. With a transparent glue or cement, paste the letters thus made on the string as shown in Fig. 5. At the left edge of each letter paste on a toothpick or similar piece of wood to keep the banner from collapsing.

"The lead pole, before the first letter, should be of a slightly heavier stock. A lollypop stick does very well. The tail cone can be made of piece of the same paper rolled into a cone and pasted together. A small weight or two at the bottom keeps the banner upright.

"The model plane used should be a biplane if possible, for the companies commercially engaged in this kind of work use this type of ship almost exclusively. The tow-line should be attached to the plane almost exactly under the pilot's cockpit,

and should be long enough to keep the plane and banner a goodly distance apart. In actual practice about 375 feet of rope is used."

Mr. Prediger goes on to explain that by stringing up the airplane outdoors in a place clear of trees or buildings, a realistic effect will be obtained. It is best, of course, to choose a low camera angle. Be sure that the sign hangs slightly below the plane and has a "grown-up" appearance and not a "model" look. Stretching the tow line too taut takes away from the flying effect; but still it should not sag.

"THE effect was quite satisfactory," he concludes, "when photographed on Kodachrome with an 8mm movie camera. A fan was used to give a

• Continued on Page 249

• Sketch at top illustrates method of shooting title backgrounds, as explained this month by George Cushman. Lower sketch explains method of making novel main title. Full details may be found in the accompanying article.

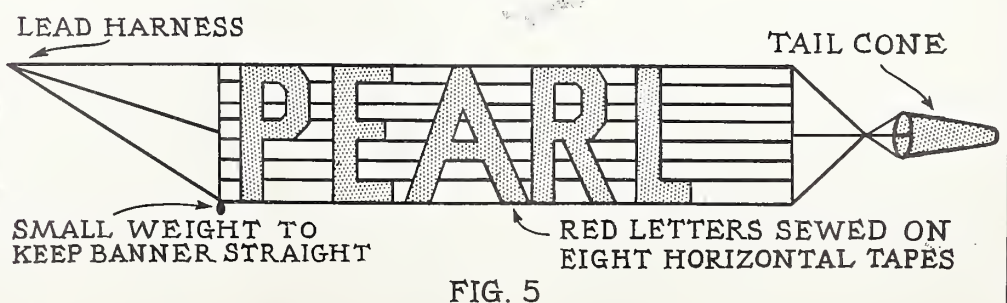
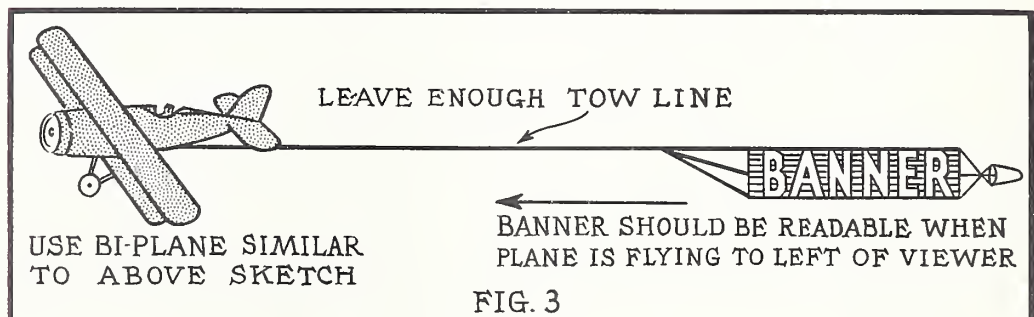

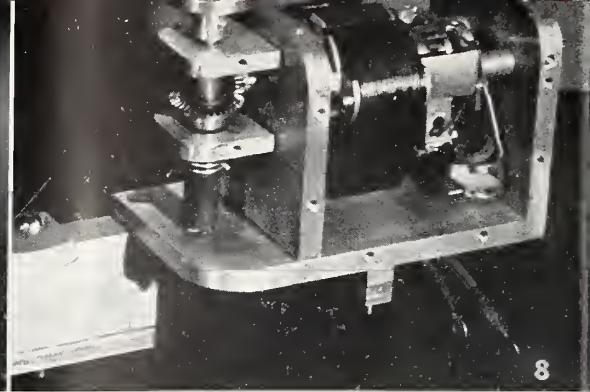
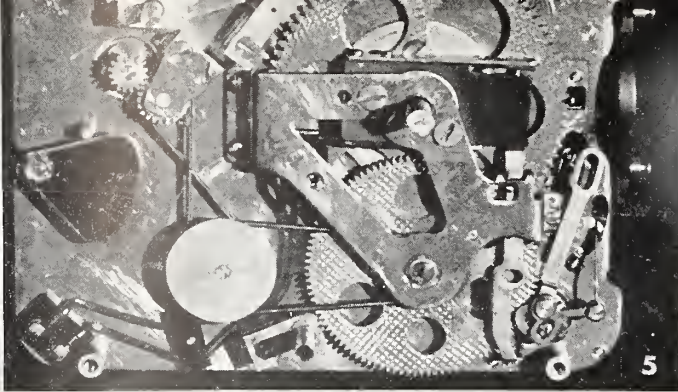
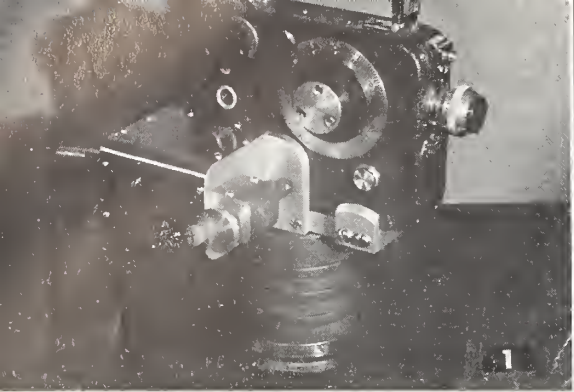

More about 1940 "DREAM" CAMERA..

Authored by
RAY E. MERVILLE

Illustrations by Author

FROM the number of letters received commenting on last month's article, we know that many owners of Model 60 Eastman cameras are well on their way to having a 1940 "Dream" camera.

The next operation is the installation of the single frame gear and shaft to which the motor is connected. Please refer to photograph No. 5. You will see the gear in the lower center of the picture, just below the horizontal belt. The gear is 1/3" diameter pitch 16 tooth 48 pitch. The bearing is bronze and the shaft is 3/16" diameter.

Photograph No. 8 shows the motor assembly. The motor runs without load at 3500 r.p.m. Under load of the camera with film, at 3200 r.p.m. The reduction gear assembly on the motor is a ratio of 3 to 1. This causes the motor to revolve the main gear in the camera at approximately the same speed as the spring motor revolved it. However, it's just a trifle faster so that it runs against the camera governor which keeps the camera at a constant speed of 16 frames per second. Binding posts are arranged on the camera case so that when the motor is attached, the internal switch will be cut in, and through the regular camera release button, will operate the motor.

Duralumin is used wherever possible in order to lighten the assembly. However, bronze is used where bearings are necessary. Sleeve bearings of bronze can be inserted in the duralumin. A crystal microphone cable is used to connect the motor to the source of electricity. This cable has a single wire running through the center of a shielded cable. The shield acts as one of the conductors. This was used because the connec-

tions are simple and easily attached, and the cable is very flexible considering the amount of current it will carry.

The hand crank shown in photograph No. 8 is very necessary, as this is used as a one-frame crank when needed; but more important, it is used to form the loop when the film has been reversed, and it will also be found very handy for more accurately placing the film, being guided by the frame counter. It is necessary that a flexible coupling be used between the motor and the camera drive shaft. Short lengths of the best grade of rubber windshield wiper tubing was found to be satisfactory. Clamps similar to those used on radiator hose on the automobile should be made for clamping the tubing to the shafts, or cotter pins and the shafts and tubing drilled.

Photograph No. 3 shows the motor completely enclosed. Stainless steel was used for this purpose. The gear case was made grease tight and before putting the cover in place the case was filled with white vaseline.

On the back of the motor housing, near the cable coupling, there was inserted a small double pole, double throw switch, used for reversing the motor. Care should be exercised in reversing the motor. Before throwing the reversing switch, one should religiously check the position of the "claw shift knob" shown in photograph No. 2. This should be in "back" position, indicated by a mark "B." In this position the pull down claw will be moved away from the film and will not damage it when reversed. The film supply spool automatically becomes the take-up spool when the film is run backwards.

WHEN the film is ready to move forward again, throw the "claw shift knob" to "F" or "forward" position. Re-form the loop — that is, the upper loop — by turning the single frame hand crank on the motor one or two frames. Throw the switch on the motor to forward position and the camera mechanism is ready to transport the film forward again.

Photograph No. 7 and Sketch "D" show construction of the combination electric switch and camera release. The bakelite block is attached to the camera with the two screws as shown. The ratchet and pawl used on the spring motor should

be removed to make more space for the bakelite switch block. The phosphorous bronze spring, shown in the

• Con'd on Page 241

• This month, Ray Merville completes instructions on creating a "Dream" camera from a model 60 Cine Kodak. The photos and sketch on this page illustrate steps necessary in the conversion process. Illustrations 2, 3, 4, and 6 appeared in the April issue.

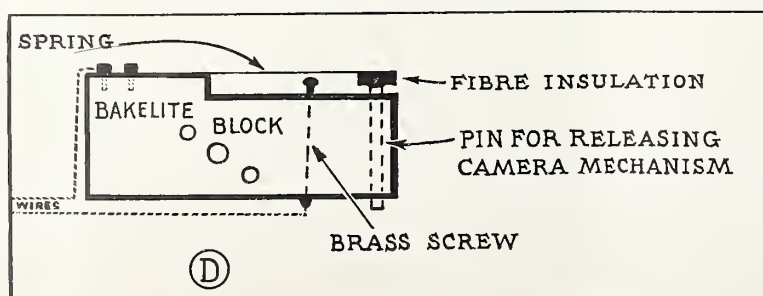
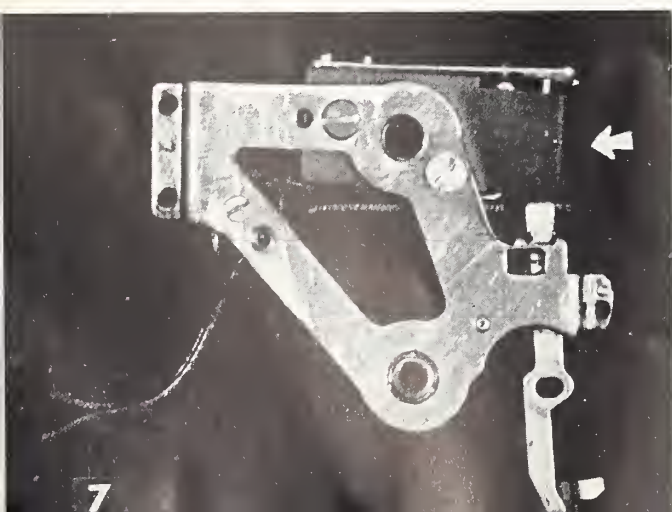

Reviews by
THE EDITORS



TELL ME — how can I improve my film?

READERS are again reminded that HOME MOVIES' film reviewing and criticism service is offered to all amateur movie makers — the only such service made available without charge by a cine publication. If you want advice on editing or titling your film, or criticism on photography, exposure, etc., send it to the editors of HOME MOVIES together with sufficient postage for its return.

In addition to the above, your film will be graded and an attractive animated leader returned with it. Also, it will be given a free cleaning and preservative treatment.

Reviews selected for this month are as follows:

"A LETTER TO ANNE" ★★★

400 ft. 16mm Kodachrome — By E. M.

Continuity: Whether one shoots 8mm or 16mm film, this is a story readily adaptable — requiring no tricks or gadgets. The action opens with a woman seating herself at a writing desk and proceeding to write a letter to "Anne." The opening paragraph of the letter says something about it being an eventful year. Then shots from commercial 16mm library films are cut in, some of which were from Castle Films' news reels, showing flashes of sensational headlines about war followed by quick cuts of action war scenes.

The theme works right up to the present — that is, the time of writing the letter, which is right after Thanksgiving. The letter proceeds to tell about the big turkey dinner, and is followed by compelling scenes of the preparation of the dinner right up to carving the turkey, the family grouped about the large table, etc. Members of family and guests are quickly introduced. Scenes are held down and well diversified.

The story continues to Christmas, with the aid of short cutbacks to the letter, and then on to New Year's, with extensive play given to the New Year's party where there is a great deal of hilarity — well captured in color by this filmer. Friends

are shown arriving at the home, dining, dancing and having a swell time. No scene is held too long. The picture closes with a cutback to the letter being written and showing an appropriate paragraph, and then the letter is sealed and addressed, closing the picture.

Editing: This amateur has demonstrated a good "feel" for editing. He is particularly adept at timing length of each scene and for changing camera angle frequently to hold interest where many people must be shown in one sequence merely to record them.

Titling: In this instance, titles consisted of part of the picture in that they were ultra-closeups of the letter. Each time a sequence changed, the filmer cut back first to the woman writing, and then into a closeup of what she had written which served as a descriptive title of the action next to follow.

Photography: One of the outstanding bits of photography in this film was a shot near the close of the story where people are leaving the house and entering their car. Snow covers the ground and a low, descending sun casts long shadows and a tinge of orange over the snowy landscape, making a composition that few cine cameras have ever recorded in such natural tones.

"PLAYING WITH FIRE" ★★★

400 ft. 16mm — By M. T.

Continuity: This is a story that almost any amateur could tailor to his needs. While much of it is shot indoors, lighting requirements are simple to provide adequate exposure.

The picture opens with a medium closeup of a husband seated

• Continued on Page 247

• Reproductions on this page are from "Playing With Fire" (top); "Hawdy Mr. Santa!" (lower top); and "A Letter To Anne" (bottom). Note clever wipe-off technique used on "Hawdy Mr. Santa!" titles.

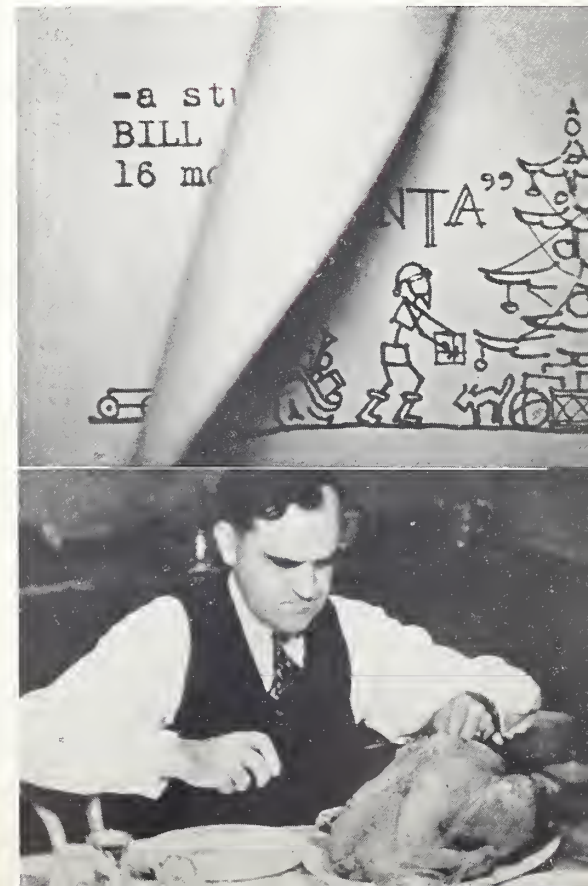

Authored by
WM. LEE MORGAN

Three ways to IMPROVE EXPOSURE *quality*

THERE are three kinds of exposure guides in general use: (1) the chart or scale; (2) the extinction type exposure meter; (3) the photoelectric type of meter.

The exposure chart is the simplest of all. It is a list of the various lighting conditions you will encounter. Opposite these are the "f" stops you will use at 1/50 of a second. This is usually the only shutter speed mentioned in the chart, as if you wish to shoot at another speed, you can stop down one full stop if you double the shutter speed (1/50 doubled is 1/25), and open up a stop each time you cut the shutter speed in half. Charts of this kind are usually found in the film you buy, and refer only to that particular film or other films of the same rating.

The exposure scale may be either a circular disc mounted on a card, or it can be the slide-rule type. The user has to judge which lighting condition listed on the scale best describes the conditions under which he is making the particular exposure. For example, he might select: day-cloudy bright; subject back-lighted. From this it is a simple matter to set dial or slide-rule and find the "f" value opposite the shutter speed you want, or vice versa.

The extinction type of meter measures the intensity of light reflected from the scene to be photographed. It usually consists of a small tube which is held to the eye, and the subject viewed through it. Inside the tube is a small translucent object which transmits luminosity in a graded field. As the user looks through the tube, he sees numbers across this field, becoming dimmer as they become greater in numerical value. The biggest number he can see is the key number to the

exposure for that scene. Most meters of this type have a calculating scale right on the tube, which is adjusted to determine what stops and shutter speeds to use together. Usually there is also an adjustment which takes care of film speed rating.

Extinction meters are valuable in that they take a critical reading of light intensity, eliminating guessing. It should be remembered, however, that the human eye does not always see objects the same each time. For example, if you had just come out of a darkened interior, as a motion picture theater, you would obtain an entirely different reading from that made if you had been out in the sunlight for awhile.

The photoelectric type of exposure meter, as its name implies, employs a light-sensitive photoelectric cell which changes light into electrical energy, activating a moving pointer. The pointer, against a scale of figures, indicates the light reading, which is used as an index on the calculating dial. Shutter speeds are then opposite the correct lens opening.

Some meters give direct readings, the sensitive pointer indicating the lens opening to use in that light. However, this is applicable only to a given shutter speed and film rating. For other speeds and ratings, it is necessary to figure on the diaphragm scale, either up or down, to determine exposure.

ALL film has a definite sensitivity, called film speed rating. As there is considerable variation in this rating between different types of film, it is necessary to pre-set the meter for the rating of the film you are using. The Weston meter and several other American-made meters use the Weston system of rating film speeds. As an example of the ratings used, a film for general outdoor use would be rated at about 24 Weston. It might be valuable to know that Weston ratings are directly proportional to film sensitivity, a film with a rating of 12 Weston being half as fast as a film of 24 Weston, and thus requiring one stop larger opening or double the shutter speed.

• Continued on Page 250

• Pictured here are the three most common types of photographic exposure guides and their method of use—The photoelectric exposure meter; the exposure scale or "chart" and the "extinction type meter." The photoelectric meter is most accurate under adverse light conditions.



Authored by
R. S. MACCOLLISTER
Photos by C. E. Bell

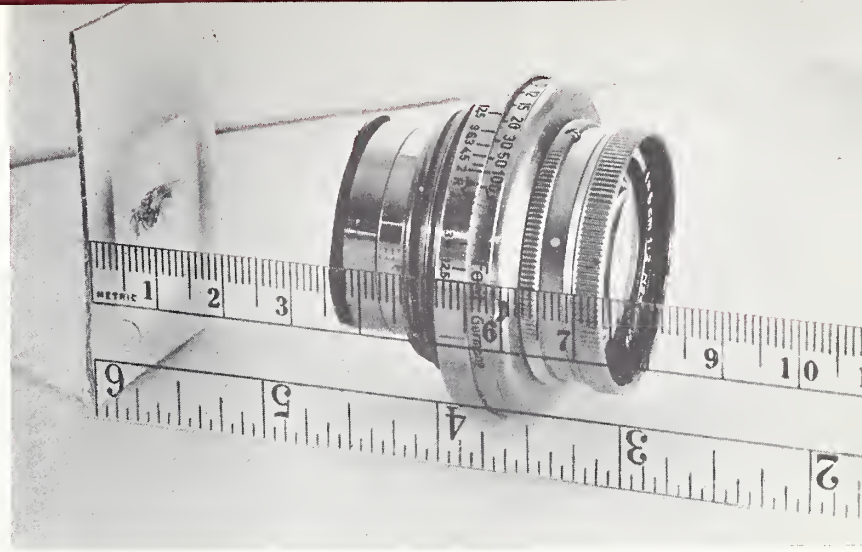

FIG. 1

There's no mystery about "F" STOPS!

PERHAPS the first thing that puzzles the proud owner of a new camera is the explanation of f/ stops — those mysterious numbers engraved upon the lens barrel. Most puzzling, perhaps, is the terminology used in describing the adjustment of camera lenses. We are told to "open up" the lens by moving it from one f/ stop number to a smaller one, and to "close down" the lens by adjusting the f/ stop to a larger number!

It would seem to most beginners that to open up the lens, it should be adjusted to a larger f/ number; yet just the opposite is true, and an early and thorough understanding of this will guarantee good exposures in picture making.

First, we shall try to clarify the meaning of f/ stops and to explain the manner in which they are calculated. Probably the best definition of an f/ stop — or, more specifically, "f" — is the following which appeared in a recent issue of *Scope*, publication of the Wollensak Lens Company:

"That 'f' is merely an abbreviation for the word 'factor.' And 'factor' means the answer to a little simple example in plain arithmetic. You get it by dividing the free aperture (which means the widest opening of the lens or with iris diaphragm fully open) into the focal length of the lens."

Example: Free aperture, 2"; focal length, 6". We divide thus: $6 \div 2 = 3$ ".

So this lens, we find, has a speed of f/3. Other examples: Free aperture, 1"; focal length, 2"; 1 divided into 2 gives 2 for the answer, so the speed is f/2. Again, free aperture, 2"; focal length, 9"; lens speed is f/4.5 (that is, 9 divided by 2).

In a nutshell, the formula used in determining the f/ stop of a lens is expressed mathematically as follows:

$$f/ \text{ equals } \frac{F}{D}$$

f/ represents the "f" stop; F the focal length of the lens (distance from lens to film); and D equals the diameter of the maximum or free aperture.

It is apparent, then, that an f/ stop is not a number of feet, or inches, or degrees, or anything

like that. It is merely a number used to indicate that a certain relationship governs the amount of light that enters the camera. In other words, it deals with the exposure.

When we move the iris ring of the lens from one number to the next, we change the size of the aperture — the opening in the lens — a certain definite amount. Thus we alter exposure and are able to control the amount of light the lens allows to fall on our film, so that every foot of it will be correctly exposed.

MOST lenses are marked in one of two series of numbers: The most common begins with the basic number, f/1 (although this number is seldom used), and continues with f/1.4, f/2, f/2.8, f/4, f/5.6, f/8, f/11, f/16, and sometimes up to f/22 or f/32. The other series starts at f/4.5 and continues with f/6.3, f/8, f/12.7, f/18, f/25, and f/36. In either case, the series is so arranged that the steps between each f/ number vary the volume of light 100%. Thus, by opening up the lens diaphragm, say, from f/8 to f/5.6, the volume of light entering the lens is doubled — increased 100% — whereas, by closing down the lens, say, from f/8 to f/11,

• Continued on Page 251

• Fig. 1 shows method of determining focal length of unmarked lens. Object is reflected through lens on white card. At point of sharpest focus (with lens iris wide open) distance of lens from card is measured which gives the focal length. Fig. 2 illustrates another method of calculating focal length of lens as described in accompanying article.

FIG. 2



THE EXPERIMENTAL

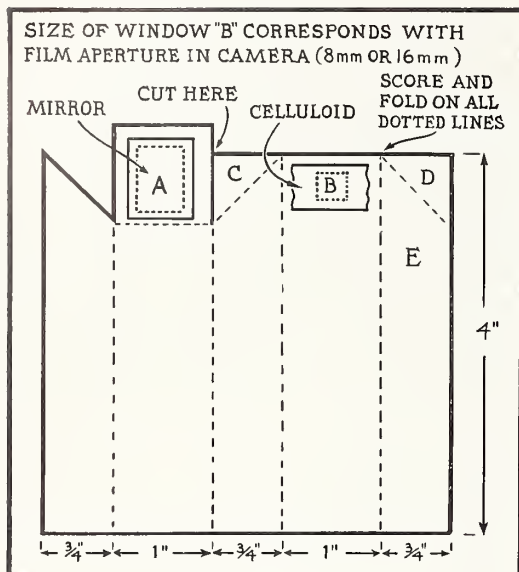

Centering Gadget

If yours is a camera that permits opening or entirely removing the film pressure gate, here is an ideal title centering device which will enable you to view the exact title image as it will appear on the film at the camera gate. It is akin to a periscope, and is inserted into the open camera with the little window next to the film aperture. The image of the title or scene is reflected by the mirror within the periscope and through the tube to the eye.

The sketch herewith shows manner of constructing this gadget. Material required is a piece of medium weight bristol board, preferably black in color (or it may be painted black); a small piece of mirror; and a piece of frosted film.

Score and crease the bristol board along the dotted lines. Before gluing, cement the mirror at "A" and the piece of frosted celluloid over the opening "B." Fold the tube into shape and make it secure by cementing the flaps "C," "D," and "E." The mirror may be cut from an old vanity case, and a piece of frosted 16mm film may be used over the window "B." If frosted film is not available, you can make this yourself from a piece of clear celluloid or film. The

CINEBUGS!

• If you have an idea for a gadget, trick, or shortcut in filming, titling, editing or processing home movies, pass it on to your fellow Cinebugs through these columns. If your idea is published you will receive two reels for your efforts. Extraordinary ideas will net you a roll of film.

Ideas not published will be held for future publication unless they duplicate ideas previously received. Endeavor also to send along photos or rough sketches illustrating your suggestions. There is no limit to number of suggestions you may submit.

Names and addresses of contributors of published ideas are furnished a prominent manufacturer interested in acquiring rights to soleable gadgets on a royalty basis.

Important: When submitting ideas, be sure to mention whether equipment you use is 8mm or 16mm, enabling us to promptly forward words adoptable to your use.

"frosting" may be accomplished by rubbing a paste of pumice and water on one side of the film.

—Eric M. Unmack.

Parallax Corrector

Here is a parallax correcting camera base which is a step ahead of many others offered to date, in that it includes a mount for the auxiliary lens. Thus, sighting is accomplished through the auxiliary lens, making for maximum accuracy in lining up an ultra-closeup or title shot.

This gadget is made of pieces of 1/16-inch brass sheet and 3/4-inch brass angle riveted and soldered together. Actual dimensions cannot be given, as different makes of cameras require varying measurements. One caution must be observed, however: the camera lens must move up to exactly the same spot that the finder formerly occupied, as the auxiliary lens will magnify any error. If the gadget is not accurately made, results will be problematical.

To determine correct angles, lay out full size on a sheet of paper a triangle,

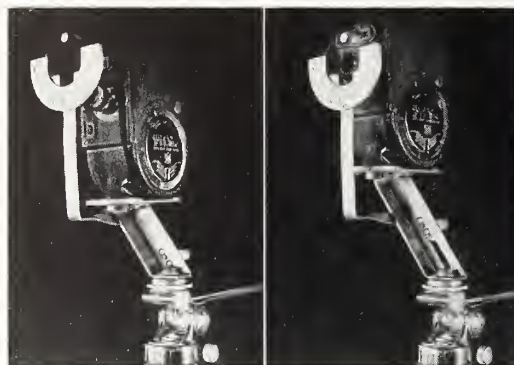

the base of which should correspond to that dimension representing the distance which the viewfinder is to the right or left of the camera lens. Perpendicular to this base, lay off the height corresponding to distance viewfinder is above the lens. Then connect these two sides; and the third, or longer, side will not only represent the angle at which the sliding member of gadget must move, but also the exact distance it must travel. On the Filmo, illustrated, the viewfinder is 15/16 inch above and 21/32 inch to the right of the camera lens.

—C. H. Brainerd.

An Accurate Titler

The accompanying sketch illustrates a simple home-made titler especially adaptable for cine cameras of the rounded base type which are usually difficult to keep in alignment. A raised platform is made on the baseboard. Nailed to the top of this is a thin piece of board in which has been cut an opening to accom-

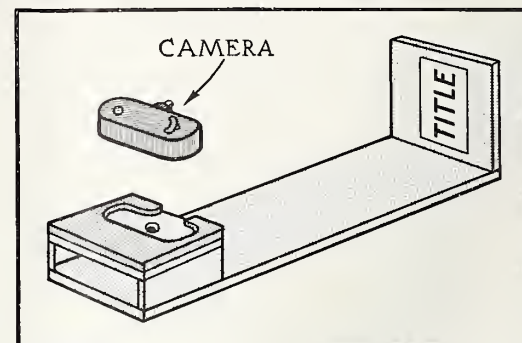

modate the camera, as shown. The edges of the opening are lined with a thin felt strip as a protection to the camera and also to insure a snug fit.

To use this titler, the camera is loaded and then placed in the opening on its side. If there are any parts of the camera projecting on the under side, holes may be drilled in the platform to allow for them. It is also a good idea to drill another hole clear through the platform which will permit pushing up on the camera to remove it from titler.

—Martin Alger.

Film Moistener

Having had trouble applying just the right amount of water to the film emulsion before scraping preparatory to making a splice, I tried using an old fountain pen for this purpose. Loading it with water, I draw the penpoint over the area to be scraped which leaves a thin film of water, loosening the emulsion. This method makes "wet" splices successful because the water applied to the film does not flow beyond the area to be scraped.

—O. A. Harmon.

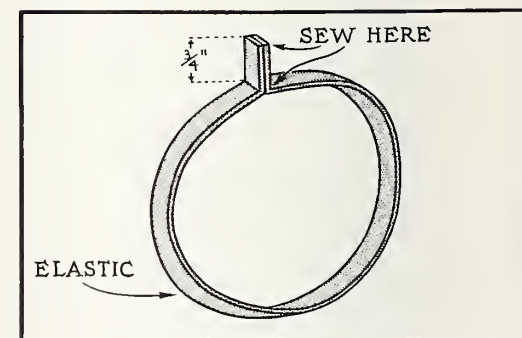

Reel Bands

Here is an idea which is a great improvement over use of ordinary rubber bands for binding film on reels. I made bands from quarter-inch elastic which is obtainable at any notion counter. Cut into 16-inch lengths (for 200-foot 8mm reels), the ends are sewed together as shown to form a tab about 3/4 inch in length. With these bands there is no excessive stretching with age, and none

C I N E W O R K S H O P

of the annoyance of the rubber bands which invariably slip down between film and sides of the reel. For 16mm reels, use 1/2-inch elastic. Length of strips may easily be determined by measurement.

—W. D. Garlock.

jected, I made a loop from a discarded section of film by splicing the ends together. After setting up my projector, I thread this loop into the projector, turn on the motor, and adjust my lens while projecting the loop. Then when my picture is thrown on the screen it is in focus right from the beginning.

—Frederick A. Richter.

Titler Tripod Mount

With the gain in use of typewriter titlers for shooting ultra-closeups of flowers and other small objects, there is an increasing need for a means of attaching such titlers firmly to a tripod. The accompanying photo shows a simple means of accomplishing this — perhaps more satisfactory than any other method because the wood block, which has been drilled to fit the screw of the tripod head, has been trimmed to fit snugly between the sides of the titler base. This enables user to slide the titler backward or forward on the block when focusing upon an object without the necessity of moving tripod.

—Norman Cummings.

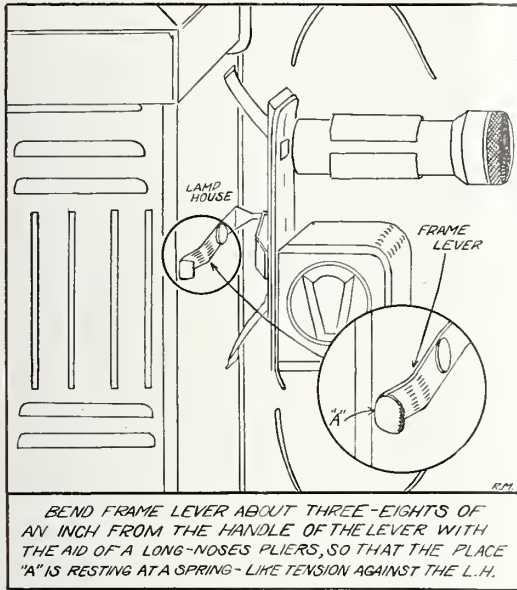

Framing Kink

I find that, after considerable use, the framing lever on some older model Univex projectors becomes loose, with the result that each time a splice passes through the film gate, it causes the frame aperture to be carried downward and requiring constant re-framing of the picture. To remedy this, I bent the framing lever with a sharp-nosed pliers so that it would rest constantly against the projector housing and remain in place after adjustment.

—Russell Meyer.

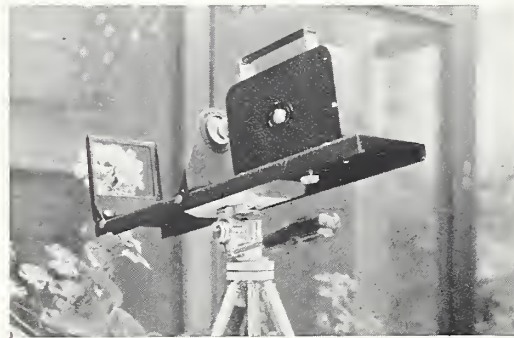

Rewind Reel Retainer

With so many amateurs making their own film rewinds by converting small grindstones, pencil sharpeners, etc., here is an idea that will solve the problem of a reel lock for same. The use of wing nuts for this purpose is unsatisfactory, wastes time, and in addition wing nuts are easily mislaid.

The need for locks or retaining de-

Copying Film

Having some film I wished to copy, I tried using my projector as a printer without making any alterations, and found the method successful. Threading the film I desired to copy, together with a strip of raw film, into the projector emulsion to emulsion, I turned out the room lights and then inserted a small "pen" flashlight into the lens barrel as a printing light. The projector was run at regular speed. I found that by altering projector speed I obtained the required exposure according to density of film to be copied.

—Al Olston.

Focusing Aid

Almost every amateur encounters the delay involved in focusing his projector on the screen just before a showing of home movies. In order that this may be done accurately before a film is pro-

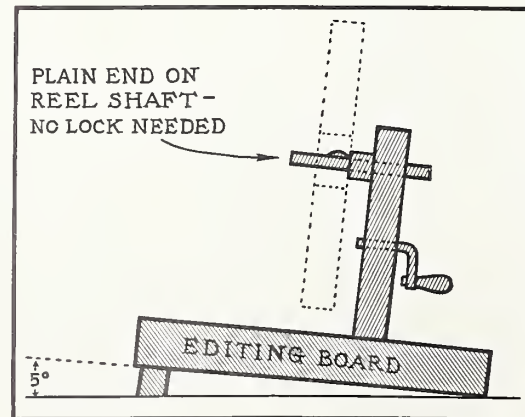

gadgets, tricks and short cuts contributed by Cinebugs

ices for reels may be dispensed with if the board to which the rewinds are attached is tilted at the back, as shown in accompanying sketch. You will also find your editing board easier to work upon when tilted in this manner.

—Palmer McKinney.

For Trick Shots

Here is a simple home-made gadget that will enable you to make some excellent trick shots with your movie camera. Undoubtedly you have seen novel "whirling" effects in motion pictures often used to convey the effect of dizziness of an actor, or other comedy effects. This gadget may easily be built from a few pieces of wood, iron pipe, and pipe fittings.

A block of wood, which may be a piece of two-by-four or four-by-four about ten inches long, is drilled axially to snugly accommodate a length of pipe. At the base of the block a plate of metal, which has been drilled and tapped to accommodate the tripod screw, is attached. This holds the block firmly to tripod.

At one end of iron pipe is attached an iron floor ring, obtainable from any plumbing shop, and to this is attached the wooden clamp that holds the camera. No specific details of this clamp will be given here as it must be constructed dif-

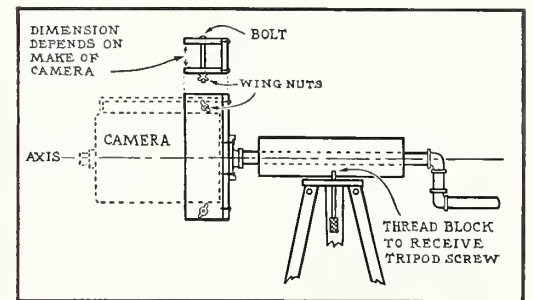

ferently for each make of camera. The sketch will convey the necessary details for attaching such clamp to the rest of the gadget. The bolts and wing nuts, indicated in sketch, serve to tighten jaws of wooden clamp to hold the camera securely.

A handle is constructed from additional short lengths of pipe and two elbows, as shown.

Thus, with the gadget completed, the camera is locked in place so that the

• Continued on Page 253

"IT'S NEW TO ME"

By CINEBUG SHOPPER



Castles' "Coney Island"

Except for animated cartoons and a few novelties, fun is rarely found in movies that are available for use in 16 and 8mm projectors. Now comes the announcement of a film which reels with fun from leader to end title. It is Castle Films' "Coney Island"—a movie record of a day at the world's greatest five-cent "World's Fair."

The picture unreels from one breath-taking spectacle after another—from the dizzy Loop-A-Plane and the Roller Coaster to the Fun House. There's a bathing beauty contest, too. "Coney Island" is available at regular prices in five sizes and lengths for 8mm and 16mm projectors at photo dealers.

New Cine Exposure Guide

A new, truly universal exposure guide, furnishing quick data for all Cine-Kodak films, 16mm and 8mm, black-and-white or Kodachrome, indoors or out, will now be a part of each new Cine-Kodak, the Eastman Kodak Company announces from Rochester.

The new guide is a neat satin-chromium plate with movable dial and retaining grooves for small insert cards—one card for each type of Cine-Kodak Film. The plate and dial, permanently attached to the side of the camera, bear a lens-aperture scale, camera speed arrow, and subject class-

ifications "light," "normal," and "dark." Each individual film card bears the film name and a scale on each side, one referring to outdoor lighting conditions, the other bearing indoor lamp-to-subject distances.

When the camera is loaded with a certain type of Cine-Kodak film, the card for that film is to be inserted in the exposure guide plate.

A pocket model of the Cine-Kodak Universal Guide is also available separately for \$1, the price including a complete set of film cards. This pocket model corresponds in design, finish and size to the camera-attached guide.

New B & H Titler

Newest accessory offered by the Bell & Howell Company is the 16mm Filmo Titler, which will fit Filmo 141, 70, and 121 Cameras without the use of separate, loose adapters. Rigidity and compactness are said to characterize the new unit, and special mention is made of a clever arrangement which permits titles to be centered accurately through the viewfinder of each camera. Bell & Howell states that this "visual centering" feature fills a long felt want, and that with

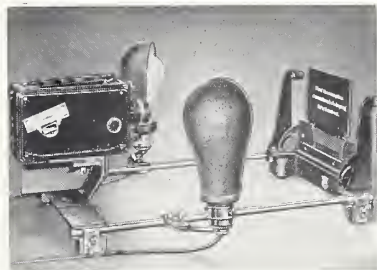

it, off-center titles are a thing of the past.

The titler consists of a camera carriage, a title-card carriage, and two swiveled reflectors, each unit sliding upon a connecting track and clamping firmly in any position. The Filmo Titler can be used in the conventional horizontal position, or it may be set up vertically, as an animation stand or to permit the filming of a title actually being writ-

ten by a human hand. The reflectors are adjustable and are made to take ordinary No. 1 photoflood lamps.

New "Alignoscope"

Camera Specialties, Hollywood, announce increased production of their new NOPARLAX Alignoscope, for aligning, centering, and focusing of ultra closeups and titles. The magnified image is seen on a

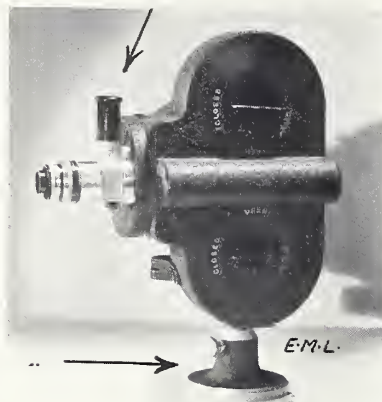

special screen in conjunction with use of the regular camera lens. The NOPARLAX is available for all cine cameras except those with lenses with clip or bayonet mount.

Fidelitone Turntable

Sturdily constructed within a case little larger than an ordinary traveling bag is the Fidelitone Dual Turntable—one of the newest units made available for playing recordings in conjunction with the screening of 8mm or 16mm home movies.

Fidelitone consists of a dual turntable and pickups, amplifier, and loudspeaker—all uniquely built into the sturdy case. There is no plugging into radios, and no need for carrying an external amplifier or speaker, according to the manufacturer.

Each pickup has its individual volume control and a guide light so mounted under the pickup arm that it throws a beam of light on the record close to the needle. Also, each pickup has a pushbutton switch for instantaneous cut-

off of music or sound, thus assuring split-second synchronization.

Descriptive folder and price list is available by writing the manufacturer, George K. Culbertson Company, 4928 Newton Avenue, South, Minneapolis, Minn.

Micromatic Titler

Featuring a worm gear adjustment of the camera base, the new Brown Micromatic Titler has just been introduced on the market. This precise adjustment insures a steady camera and accurate centering of same on title card, according to manufacturer. The title frame is so designed that you can use almost any background for novelty or special treatment. The titler provides for making flip-flops, zoom, and receding titles, as well as many others. An interesting illustrated folder describing the Brown Micromatic Titler is available free to those addressing Brown Cine Products, 2901 Eighteenth Street, N. W., Washington, D. C.

Dinky-Inky Accessories

As accessories for the Dinky Inky, 150-watt spotlight,

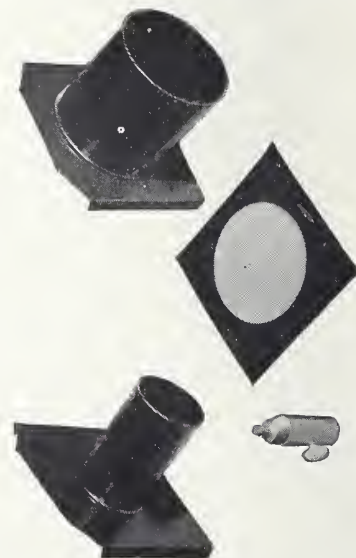

Bardwell & McAlister, Inc., of Hollywood, California, have announced "snoots" (light

shades) in two sizes and a diffuser frame with Fiberglas Matt diffuser.

These accessories fit into clips on the front of the light and are invaluable for the photographer whose time is valuable. An adapter, which permits the use of the Dinky Inky on an ordinary music stand tripod, is also available.

All of these accessories can be purchased from Eastman Kodak Stores or camera shops throughout the United States and Canada that sell the Dinky Inky spotlight.

Gevaert Seattle Branch

The Gevaert Company of America, Inc., manufacturers of photographic films, plates and papers, announces the opening of a new branch office and warehouse in the Textile Tower, Seattle, Wash. The offices are in charge of Mr. A. H. Graham under the supervision of Mr. G. M. Goffin, West Coast manager.

Lens Prices Remain

Hugo Meyer & Company, of New York, manufacturers and importers of fine camera lenses, announce that contrary to the general reports of increasing prices on imported lenses, their company has not increased prices on their products. On those items which they still have in stock, this company reports, they will continue to furnish, regardless of the fact that replacement costs would be much higher.

New Film Release

Official Films, Inc., announce the release of their latest "Snortsbeam" film—"Away With the Wind"—a story of the sea. The film is replete with thrilling scenes of sailboat, outboard, and motorboat racing, as well as surfboard and hydroplane activities. This film is now available in both 8mm and 16mm, according to the producers.

Movie-A-Month

Membership in the Movie-A-Month Association, whose announcement appeared for the first time in HOME MOVIES last month, consists of a free Castle film upon receipt of membership fee. Thereafter, you may exchange this film for another, and continue this exchange privilege until you

• Continued on Page 256

Invariably THE CHOICE OF CRITICAL AMATEURS

"DOUBLE-EIGHT" "SIXTEEN"

Because, among other things, only BOLEX has these exclusive and important features:

- Automatic threading with pre-formed loops
- Facial-plane type, 190° rotating disc shutter
- Clutch far forward or reverse filming by hand crank
- Special 3-lens turret
- Tri-facial, parallax-correcting viewfinder
- Single-frame mechanism
- Lateral spring tension in the gate
- BOLEX is the easy-to-operate movie camera
- BOLEX produces better pictures in the "professional" manner
- And, of course, BOLEX has practically every other feature found in the best cameras

CUSTOM BUILT

BOLEX is, in practically every way, a custom-built instrument. Every important part is carefully fitted and numbered with its reciprocal part—assembly is not a haphazard proposition but rather a meticulous process. E. PAILLARD & Co. are internationally famous as manufacturers of precision-made instruments—a reputation earned through 126 years of uninterrupted production. That's why every BOLEX is guaranteed against defects in workmanship and materials for two years.

Yes, it has everything—versatility and adaptability are built right into BOLEX. You can do with it nearly everything that you see done on the professional movie screen. At your finger tips are the means to produce slow motion, animations, single-frame "stills," super-impositions, fades, close-ups, lap-dissolves and all the other "professional" effects that add so much to the interest of personal movies. And of greatest importance is the fact that BOLEX films are always rock-steady and when properly exposed are of the most beautiful photographic quality. Ask your dealer to show you how BOLEX meets and masters every movie-making situation—see for yourself how it feels just to handle the world's finest sub-standard cine camera. Then you will know why critical amateurs by the thousands choose BOLEX. Send today for new 52-page catalogue.

AMERICAN BOLEX COMPANY, Inc.
155 EAST 44th STREET • NEW YORK, N. Y.

Bolex
pailard
THE WORLD'S FINEST

It's cheaper to buy a BOLEX at the start — so see a BOLEX before you buy!

A guide for filming the Fair . . .

• Continued from Page 227



Get G-E Photofloods and take it!

• Even everyday incidents, like this, make priceless movies . . . the kind you want to show again and again when you shoot them with G-E MAZDA Photoflood lamps.

Remember, for crisp, clear, sparkling pictures, there is no substitute for plenty of light . . . and it is so easy to have, with G-E Photofloods. These are the same high-efficiency type lamps that Hollywood uses . . . made to fit your needs by the folks who make lamps for the big movie studios. Get G-E Photofloods and enjoy the pictures you take *more!*



TWO SIZES fit most needs.

No. 1 20c list

No. 2 40c list

Available in Daylight bulbs for use with regular Kodachrome. And for extra lights, try G-E Photoflood R-2, bulb and reflector in one unit.

NEW G-E MAZDA Mighty Midget Photoflash (Synchro-Press No. 5) Plenty of light for most pictures. Highly effective in regular equipment—sensational in concentrating reflectors . . . carry as many as 30 midgets in one pocket! 20c list.



GENERAL ELECTRIC
MAZDA PHOTO LAMPS

building at about 3 p.m. You will have for a background the scores of flags of all nations floating over the Court of Nations. And, if the camera is focused a little to the left, the beautiful building of the Italian exhibit will be included. Incidentally, the Italian building remains the most widely photographed structure at the Fair. For the best contrast, a 2X yellow filter should be used when filming it with Pan film—with an opening of f/6.3. The best time of day for this shot is between noon and 3 p.m. Remarkable results have been had with Kodachrome on this scene shooting at f/8.

Those who filmed the spectacular "Aquacade" last year will receive a far greater thrill this year. It is a more colorful show and destined to be the mecca of all home movie filers. It is advisable to plan shooting this event in two stanzas: The first time from the very first row for closeups, etc., and the second time, for general overall shots of the mass water drills and stunts as well as atmosphere shots of the spectators. About 3:30 in the afternoon is the best time for filming the "Aquacade." The sun sidelights the entire spectacle from the extreme right side of the huge stage. Secure a seat at the extreme right of the arena. Due to the glistening water displays, Kodachrome filers should shoot this at f/8. The same opening is suggested for Pan film.

On the American Common, just completed on the site of the former Russian Pavilion, will be presented this year a highly colorful show made to order for users of color film. Here will be staged versions of old-world bazaars and fiestas in a series of colorful festivals. Regular Kodachrome at f/6.3 or pan film at f/8 with flat lighting should obtain best results here.

Of course, the filer will encounter many parades in progress on the Fairgrounds. As most of them pass down the Great White Way, the spot to film them is from the uncrowded side-

walk facing Ballentines Inn. From noon until 4 p.m. the sun will give the necessary flat lighting to shoot Kodachrome at f/6.3; Pan film at f/8. After the parade disbands, do not hesitate to walk up to any one of the pretty majorettes for some fascinating closeups. Such shots add punch to a film and should be obtained as frequently as possible. And a good tip to remember is not to panoram parade shots. Let the parade pass in front of your camera—at an angle—to furnish movement in the scene.

No movie record of the Fair would be complete without a few closeups of the Glamour Girls dotting the Fairgrounds. New and more colorful uniforms have been provided this year for the many beauties of the Fair's treasury division. Shoot them candidly as they walk toward you through a flowery lane, or door or archway of one of the buildings.

1940 improvements in the Florida exhibit provide for visitors to stroll along Orange Blossom Lane to a real Southern beach. Beautiful girls in slacks will parade through the grounds, lending added color and life to the scene. Here indeed is another "must" location for the Kodachrome filer, offering a fine array of pastel colorings.

This year, Frank Buck's Jungle Camp will offer the movie maker an excellent chance to film scenes that cannot be duplicated elsewhere. Here, a thousand monkeys will cavort on a man-made mountain. Here bananas are sold to which are tied gas filled balloons. Spectators float the banana-bearing balloons over monkey mountain, and the antics of the monkeys attempting to capture the fruit is a highlight that must not escape your camera.

Situated at Lincoln Place within the Fair is the Eastman Kodak exhibit, which embraces everything the serious cinebug could ask for. Here, experts will be on hand to oblige cameraists with technical information

regarding films or cameras as well as dependable information on exposures for picture making on the Fairgrounds.

Another "must" location for the Kodachrome filer is Gardens on Parade exhibit. Here will be found roses transplanted from almost every country on the globe. This exhibit is located next to the British building in the heart of the International Exhibit area.

Water scenes add zest to any movie, and Liberty Lake, which may be crossed in a water taxi for only 10 cents, offers many opportunities for including water in movie compositions. Scenes filmed here at f/8 will include in the background the opposite shore with its Dutch windmill and the famous parachute tower.

Railroads on Parade exhibit will present a slightly difficult problem for cine-filers. The amphitheatre is so located that the sun strikes the stage from the rear—right into the eyes of the filer. Super XX film will net best results here at about f/8. Little success can be expected with Kodachrome.

Day or night—the Lagoon of All Nations is the attraction upon which the most cameras are focused. At night, the fire and water displays augmented by fireworks afford a beautiful spectacle which may be captured on Kodachrome if your lens is an f/1.9. Cameras with slower lenses should stick to Super XX and an f/3.5 opening for this location at night.

Shooting the Lagoon in the daytime is another proposition. The reflections of the surrounding buildings of pastel shades is so vivid that no lens should be opened beyond f/8 regardless of film used. Up to 12 o'clock noon, the Lagoon may be photographed from the steps or balcony of the U. S. Federal Exhibit building. This location is famous for good Kodachrome compositions that include the Trylon and Perisphere

in the background, and the reflections framed within the boundaries of the Lagoon in the foreground.

At night, Constitution Mall — lined with hundreds of mercury lighted trees that are reflected in the water — is a picture that must not escape your camera. The Trylon and Perisphere are also well illuminated and the statue of George Washington stands out in bold silhouette.

Human interest and "gag" shots should not be overlooked in filming the Fair. It is these that occasionally break up the monotony of the procession of scenic shots on the screen. A well planned "gag" idea, regardless how simple, will raise one's Fair picture above the mediocre. Close-ups of people — or those accompanying you — eating hot dogs; massaging sore feet; stopping at rest rooms — all make interesting film fare.

The Fair abounds with some of the finest sculpture to be found anywhere. The most inspiring of all statues is probably the group of four entitled — "The Four Freedoms." These face Constitution Mall and may be filmed individually or in an entire group with the Theme Center for a background.

In the Plaza of Light four beautiful columns entitled "The Four Elements" form a picturesque frame for another work of art — the "Four Victories of Peace." Do not attempt to film these statues from the seat of a sightseeing bus, particularly if you are seated in one of the soft rubber cushioned seats! Needless to say, such a shot would jump about the screen and annoy your audience.

Panoraming a huge

statue from base to top or vice versa is not to be recommended. Unless you possess a wide angle lens, move back a sufficient distance to enable you to get most of the structure in the viewfinder, then slowly pan to take in the rest.

Here are a few brief tips that will prove helpful to all Fair filmers: When arriving at the Fair, purchase a map and guide which will enable you to plot your course. From the map you will be able to determine how each exhibit lies with relation to the sun, so that you can decide upon what time of day to film those locations not covered here. This will save you considerable time.

Before shooting any scene, take time to study it carefully, moving about — perhaps ascending the balcony of an adjacent building — in order to get the best possible composition. This, more than anything else, will enable you to bring back extraordinary movies of the Fair.

The Fair management maintains an official camera car which may be placed at your disposal by applying in advance at the Administration building. Use of it will enable you to get some unusual shots overlooked by the "hit and run" cinefilmers.

Birdseye views — those made from an elevated position — may be secured from the Pericline, or from any one of the balconies of the many structures within the grounds.

While the Fair is essentially a Kodachromer's paradise, those holding to good old Pan film can bring back equally fine records with judicious use of filters, careful attention to exposure, and unhurried study of composition.

1940 "Dream" Camera...

• Continued from Page 232

sketch, is heavy and stiff enough to keep the pin with its fibre insulation in contact with the camera release lever, so that when the regular outside camera release button is depressed in the usual manner for starting the camera, the spring will follow down, make contact

with the brass screw, and start the motor. The contacts should be adjusted so they close just before the stop releases the gear. This puts pressure on the gear, the same pressure as when the spring motor was used, thus assuring that the first frame will start with 1/30

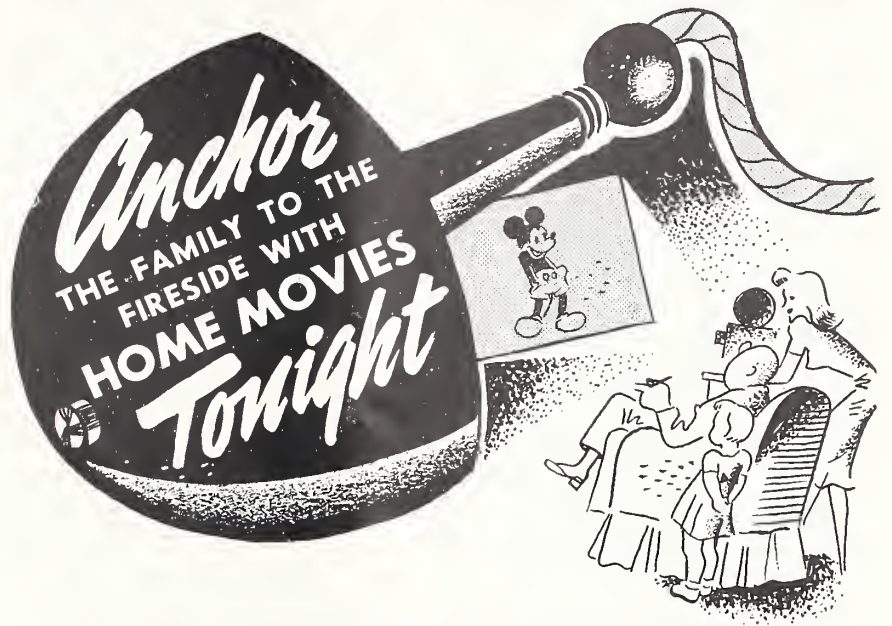

Families cease to scatter when it's home movie night. There's too much fun by the fireside . . . too much going on at home. Show home movies often . . . keep the family circle intact. At surprisingly small cost you can have a parade of movie stars through your home . . . can "hob nob" with such famous characters as:

Mickey Mouse—Donald Duck—Oswald the Rabbit—Popeye the Sailor—Meany, Miny and Moe the Three Monkeys—Betty Boop and more than

40 FAMOUS MOVIE STARS including Shirley Temple—Charlie Chaplin—Joan Blondell—Gary Cooper—Anne Shirley—Bob Burns

Only at your SEEMANN dealer can you get these films from the world-famous collection of Hollywood Film Enterprises, Inc.; hundreds of subjects including travelogues, educational films, Westerns, etc., produced right in Hollywood in 8mm and 16mm sizes for your home projector. See your SEEMANN dealer or write to SEEMANN, Inc., TODAY for catalog of subjects.



AND PREPARE YOUR OWN MOVIE ENTERTAINMENT AT HOME.

You can make your own movies. Title them with the SEEMANN Titler just like professional films. Perfect results. Fits 8mm, 9½mm and 16mm cameras. Accurate centering of titles assured. Complete with rolling title attachment and accessories.

MODEL A (without lights) \$6.95

MODEL B (with lights) \$9.95

Order from your dealer or write to SEEMANN, Inc.

SEEMANN, INC.

6628 Santa Monica Blvd.

HOLLYWOOD, CALIFORNIA

In San Francisco — 86 Third St.

Sole World-Wide Distributors for
HOLLYWOOD FILM ENTERPRISES, INC.
Hollywood California

FADE-O-SCOPE*

CAMERA DISSOLVE
with POLAROID* Lenses.

*T. M. Reg. U. S. Pat. Off.



NOW You Can Make the Finest PROFESSIONAL Fades and Lap Dissolves Quickly—Easily

No more abrupt starts or stops! No more jerky, unrelated scenes, wasted film, *distractions* . . . but delightful *smooth continuous action* and gradual scene transitions of big-time movies! For FADE-O-SCOPE, the new, scientific instrument, now enables the amateur to execute true PROFESSIONAL fades and dissolves* . . . by simply moving a small lever up or down!

Genuine POLAROID Lenses

of high-transmission, neutral density, light-control glass permit uniform intensity control without causing slightest loss of detail. Fits ANY camera; performs perfectly on 16mm or 8mm. Attached or removed in a minute. Carried easily in the pocket like a watch. For astonishingly better results in picture making, investigate FADE-O-SCOPE.

Ask Your Dealer for Details

See New Demonstration Film

Descriptive Folder on Request



*Camera must be equipped with backwind.
3 HANSON PLACE
FADE-O-SCOPE, Inc.
Brooklyn, N. Y.

of second exposure speed.

Since the motor requires 12 volts to operate, we recommend two 6-volt "hot shot" batteries for use in the field. To save the batteries at home or where 110 volt A.C. is available, the 12-volt current supply can be obtained through an economical step-down transformer plugged into the house current.

Photograph No. 1 shows the frame counter which was constructed from a radio dial numbered from "0" to "100." The dial is attached to the shaft which was inserted in the spring case. If a more accurately calibrated frame counter is desired, there is a choice of two elaborations. You may have a dial engraved with 52 lines to represent the 52 frames of film that pass the aperture gate with one complete revolution of the dial;

or, if you wish to go further, it would be possible to mount a small gear on the shaft, which is attached to the spring case, and then another and larger gear on a bracket to the mounting plate. A 4-to-1 ratio would require a gear of 3/8" diameter on the shaft and 1 1/2" on the bracket. The shaft from the larger gear should extend through the case and to this a dial engraved with 208 lines should be attached. This will accurately clock 208 frames as they pass the gate.

This completes the instructions for converting a standard Model 60 to the 1940 "Dream" camera, and we are sure you will gain much added pleasure in your chosen hobby when you have completed the camera and set forth to make more and better pictures.

Showings for Shut-ins . . .

• Continued from Page 221

for a hospital ward full of crippled or sick children, or at an orphanage or home for the aged. In that case, and in your city or community, you can cooperate with some brother fan who is able to do it, or is doing it, by contributing some of your films.

Even if you are doing your bit by staging showings for shut-ins in your community, pass on your films to the other good fellow in another town, and keep the ball a-rollin' in that manner. You will find the cockles of your heart glowing all the more for a kind and charitable deed doubly done. And when you get the lift that comes with that glow, even your projector will seem a light load to lug across town, or even to a suburb, to bring an hour's surcease from cheerlessness and pain to some sick or stricken kiddies or grownups.

It doesn't take much to break the monotony and take the drear out of a sick-room or a hospital ward, or make a covey of little Orphan Annies forget their plight, so don't worry too much about the type of films to show them. Kids like adventure, comedy, out-

doorsy and scenic pictures, especially when a withered leg, a touched lung or polio paralysis keeps them from enjoying these pleasures at first hand. And so do the older invalids and shut-ins.

And no cine fan worthy of the name but has a supply of such subjects to draw upon. That vacation film you made at Grand Canyon two years ago; those swell shots you got of ships and sea while fishing last year; that neighborhood kid comedy you made, or those 800 feet of World's Fair scenes — what about them? They may be "old hat" to yourself, your family and friends, but they would be as fresh as a newly minted dollar, even do a lot more good, to that sick neighbor up the street or those wistful-eyed youngsters over at the Children's Home.

Of course, there are cine fans who confine their hobby to showing films which they rent or buy. They classify, if they choose, to be charter members in the showings - for - shut - ins movement. Dig down in that library, pick out the thrillers and killer-dillers, pack up the projector and screen and sally forth to make someone forget their pain

GET THOSE DISTANCE SHOTS!



Price
\$73.00

with this 4-in., F3.5

DALLMEYER CINE TELEPHOTO

For 16mm Models

For FILMO, BOLEX,
VICTOR, KEYSTONE

Other Models

World famous for greatest accuracy and optical precision, these popular Dallmeyer Telephotos are supplied for practically all makes of Still and Cine cameras (both 8 and 16mm). You will increase the use and enjoyment of your camera to an amazing degree by means of a Dallmeyer Telephoto.

Booklet Describing All Models
on Request

M E D O
15 West 47th St. New York City

Economical OUTDOOR FILM —Weston 6—

“SUN-AMBER”

A Reversible Safety Film
50 ft. 16mm . . . \$1.00 per roll
100 ft. 16mm . . . 2.00 per roll
REVERSAL PROCESSING and
POSTAGE INCLUDED
California Buyers Include Sales Tax

Pacific Coast Film Co.
1510 N. Sierra Bonita Hollywood, California
“Everything Photographic”

Titler Owners Are Now Making 16 and 8mm
Natural Color Background
KODACHROME TITLES for 10c
They Are Using Professionally Hand-Set Titles
Printed in White or Blue on
TRANSPARENT CELLULOID
Send 10c and Copy for Test Title to
NEWLANDS
6016 Barton Avenue Hollywood, Calif.

BETTER Home Movies
Write when you use
for our price list. Wonderlite
Photo Lamps
WONDERLITE CO. 14-H Northfield Ave.
WEST ORANGE, NEW JERSEY

or poverty. And as we suggested before, if you can't do it yourself, pass on some of your film library to those who are engaged in this laudable service.

When the urge is in the heart, and the heart is in the right place, this showing to shut-ins can be a hobby as pleasant and thrilling as home movie making itself. Let's cite an example of the rewards in gratitude and joy that have been heaped upon one "shut-ins" exhibitor.

One would say that a physician might well feel he was doing his share of caring for suffering humanity. Not so with Dr. H. S. Bayless of 1628 Belmont Avenue, Chicago, who is one of the pioneers of the shut-in movement. Lauding our sponsorship of such showings, Dr. Bayless writes:

"I have been doing this for some time, renting films of educational and other subject matter to show, as I did not have any films of my own taking until recently. I am enclosing some original letters from children at the Chicago Children's Memorial Hospital. They speak for themselves and carry a message to others who may wish to cheer big folks as well as little, less fortunate than themselves, without much expenditure of money or loss of time . . ."

We wager that neither gold nor crown jewels could have repaid Dr. Bayless more richly for his merciful and humanitarian efforts than these childish scrawled missives sent from hospital beds by sick and crippled youngsters still aglow with the thrill of the good doctor's treat.

"I liked the movies very much," writes one little boy. "Best of all, I liked the skiing in Quebec and the fishing in New Zealand. Boy, that was a big fish that man caught, wasn't it?"

Another lad says: "I liked your movies a lot . . . I think it was very nice of you to come and show us those movies. Do you know that Baby Arthur in the next bed is still excited and talking about the show. And thanks for the candy . . . yum, yum."

Read those without a gulp

in your throat if you can, and remember they were but a couple of the childish letters of gratitude showered on Dr. Bayless for his thoughtfulness and kindness. Even in a little hand-printed and illustrated magazine issued by the children patients of the hospital, Dr. Bayless was honored with a tribute. Not only that. Chicago newspapers exploited his good deeds!

One of the directors of the hospital wrote to tell the doctor that he had established himself as a very welcome friend of the children. "They speak of you in a most possessive way . . ." added this official.

The experience of this physician-reader of HOME MOVIES is but one of the many that have come to the editor's desk since the showings for shut-ins project was launched. The majority not only warmly endorsed it but offered as well to lend every possible aid in giving it a country-wide sweep.

Most encouraging were the reactions of the heads of several of the firms manufacturing projection machines and cine equipment. "Since the advent of your 'Showings for Shut-ins' we have been extremely interested in this service which you are sponsoring for those unfortunates who, by their infirmities and afflictions, are kept indoors," wrote Ezra S. Brockway, president of the American Bolex Company, New York.

"We wish to congratulate you for giving time to such a worthy cause. It is refreshing to note the humane side of HOME MOVIES magazine's management . . . and you should profit if only through the knowledge that you are attempting to make the lives of shut-ins a little more tolerable.

"We heartily endorse this movement and want you to know that we would consider it a rare privilege to contribute to its success. Let us hope that your 'Showings for Shut-ins' will bring amateur movie makers to their toes throughout the country and that with their films they will help perpetuate this very worthy service," Mr. Brockway concludes.

In offering the endorsement of his company, James

CHOOSE A KODAK 35 for Your "Stills"

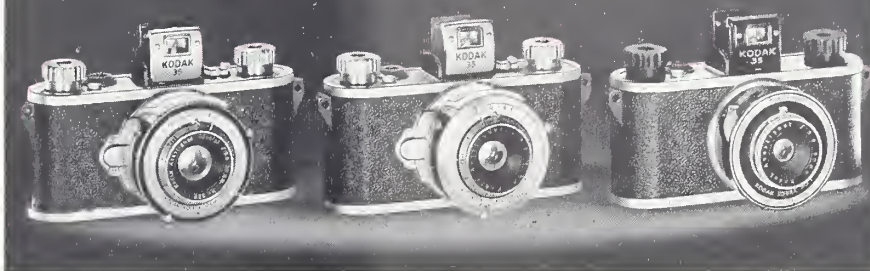

PRICED AS LOW AS \$14.50

KODAK 35's produce sharp little negatives which through modern photofinishing methods lead to pictures $2\frac{3}{4} \times 4$ inches. You can make Kodachrome (full-color) transparencies with them, too.

Kodak 35 f/5.6, at right above, has Kodak Anastigmat f/5.6 lens . . . three-speed Kodex shutter . . . fingertip focusing . . . folding optical finder . . . exposure counter. Price, \$14.50.

Kodak 35 f/4.5, center above, has faster Kodak Anastigmat f/4.5 lens, and Diomatic shutter with four speeds and delayed action. Winding film sets shutter, avoiding double exposures. It costs but \$24.50.

Kodak 35 f/3.5, at left above, offers fast Kodak Anastigmat Special f/3.5 lens and five-speed 1/200 Kodamatic shutter. It's the most versatile of Kodak 35 models. \$33.50, at your dealer's.

Only Eastman Makes the Kodak

EASTMAN KODAK COMPANY, ROCHESTER, N. Y.



FOR 100%
EYE CUE

THE NEW RAYGRAM BEADED SCREEN

wins this high rating because it gives a new sparkle and clarity to your home movies. Assures professional sharpness of image . . . equipped with semi-automatic frame. When screen is pulled out of case it automatically stands erect . . . a slight pull on the release cord closes it.

Graded blue white glass beads impart brilliant realism. High quality Dupont screen cloth and coated back make for theatre perfection. Black nickel hardware . . . solid leather handle makes it a handsome addition to your photographic equipment.

22 x 30" . . . \$10.00

36 x 48" . . . \$16.50

30 x 40" . . . \$12.50

39 x 52" . . . \$20.00



Easy to operate . . . requires only one hand to open and to close.

AT ALL LEADING DEALERS



RAYGRAM CORP. 425 FOURTH AVE.
NEW YORK CITY

RAYGRAM CINE PRODUCTS

are sold by leading photographic supply dealers. For literature on Raygram Screens, Cine Reels, Humidors and Projector Cases, write Cine Department

425 Fourth Avenue

RAYGRAM CORPORATION

New York City

Bool CINE-FADER

**PUTS 64 VARIETIES OF
FADES & DISSOLVES**
at your finger tips

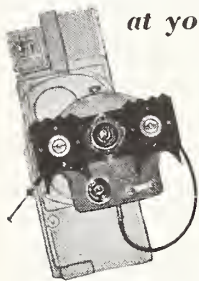

The handy Bool times and automatically makes by clockwork mechanism, all kinds of tricky effects "as you go." When operating there is no need to remove the eye from viewfinder. Bool also serves as filter holder.

**FITS MOST EVERY MOVIE
CAMERA AND PROJECTOR**

Complete with extension tube, cable release, and instructions for operation..... \$17.50

Cinea 30

FILM SPLICER

HANDLES BOTH 8 and 16 mm
SOUND and SILENT
FILM

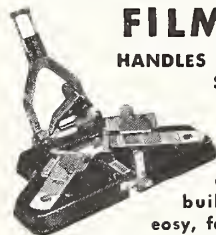

It's the best! It is expertly designed for efficiency and precision—built to make all splicing easy, fast, and accurate. All of the working parts are held under steel spring tension. When properly made, Cinea splices are neat and strong..... \$10.00

Cinea-WINDERS



The Only Rewinds That Have
Adjustable Drag and Brake
(Handle both 8 and 16mm Reels)

The exclusive drag feature does away with spin and backlash and leaves one hand free. Fine-cut gears and large, easy-grip wooden handles make operation smooth and quiet. Per pair, \$9.00

Cinea FILM CEMENT

The only cement that is good for all kinds of film—acetate or nitrate—35 mm, 16 mm, or 8 mm. Cinea Cement is odorless, does not bleach color, is slow to evaporate from uncorked bottle yet joins film quickly and strongly. Bottle..... 25c

CINELAC PROTECTS YOUR FILM

against SCRATCHES,
FINGER MARKS, CURL
AND BRITTLINESS

CINELAC permeates and toughens the emulsion—seals in moisture—prevents excessive aging—protects negatives and cine film. No apparatus needed—easy to apply. 2 oz. bottle..... \$1.00



See your dealer or order direct from—

AMERICAN BOLEX COMPANY
155 EAST 44th ST. • NEW YORK, N. Y.

Forrestal, general sales manager of Agfa Ansco, wrote: "We believe that your "Showings for Shut-ins" is a most worthy enterprise and we sympathize wholeheartedly with it . . . We think you deserve a great deal of credit for your part in bringing pleasure to those who are denied so many things which the rest of us enjoy regularly."

Axel Monson, president of Ampro Corporation, Chicago, endorses the movement and sees it as "a fine humanitarian work on the part of those who participate in it." President Monson and the Ampro company are among the pioneers in the movement. Many times a

month Ampro workers visit hospitals, orphanages, and such institutions to show pictures to inmates. During the Christmas season, Mr. Monson personally sponsors a number of these programs for sick and underprivileged children.

Joining in the endorsement and laudation of the movement, especially of those cine camera and projector owners participating in it, is S. G. Rose, vice president of Victor Animatograph Company, makers of cameras and projectors.

"It is a grand move . . . and I hope we can be of some aid to you . . ." the Victor executive wired.

"The Family Champ . . ."

• Continued from Page 224

comes into scene and places piece of beefsteak over black eye, as boy winces.

Scene 15. Medium shot—same scene as above. Father steps back after placing beefsteak over boy's eye. Brushes his hands and says:

Title: "There—that'll fix you up!"

Scene 16. Continuing with scene 15. Father finishes speaking. Father reaches for piece of string and ties it around boy's head to hold beefsteak in place. Boy places hand over beefsteak as he and Father, with arm about him, exit from scene. Fade-out.

Scene 17. Fade-in—close-up of feet of Father and boy walking along sidewalk. They suddenly stop and turn as though pausing to observe something.

Scene 18. Medium close-up of Father and boy reading poster announcing boxing program for that night. Dolly in to a full closeup of poster and beyond until camera is centered on bold caption: "TONIGHT!" (This may be done by mounting camera and tripod on a toy wagon, or an automobile or truck, and moving same slowly toward poster while camera is in motion.)

Scene 19. Same as scene 17. Father and boy turn and continue walking in same direction.

Scene 20. Medium shot. Exterior stadium box office.

Attendant on duty. Father and boy enter scene and stop at window.

Scene 21. Closeup of Father and boy at window. Business of Father buying two tickets. Pockets tickets and change and both exit from scene. Fade-out.

Title: THE NEXT DAY.

Scene 22. Fade-in. Medium shot of boy in backyard. He is dressed in different clothes, and industriously shadow boxing against side of garage. Once or twice he hesitates, as though trying to remember how the fighters he saw the night before handled their punches; then continues boxing furiously, frequently letting go a punch that almost throws him off balance.

Scene 23. Medium long shot of preceding scene. Junior in background, still shadow boxing. Father, sans coat and with amused look on face, enters scene with package under arm. Calls to boy, who hurries over to him. Father hands package to him. Cut to—

Scene 24. Medium close-up, as boy takes package from Father, starting to unwrap it as he does so. As he discovers contents and registers delight, cut to—

Scene 25. Closeup of pair of boxing gloves in box.

Scene 26. Back to scene 22. Boy shakes dad's hands over-eagerly, thanking him

Use THRIFTY 16MM QUALITY FILM

A Money Saving "Thrifty" Film for Your Every Need

THRIFTY ORTHOTYPE

For OUTDOOR . . . non-halation base, fine grain, fast, Weston 8—the film you've been wanting to find at an unheard of low price. Machine processed. Per 100 ft. . . . **\$1.60**

THRIFTY PANCHROMATIC

Use for all types of shooting. High-speed Weston 16 daylight—10 photo-floods, machine processed. Per 100 ft. . . . **\$3.75**

THRIFTY SUPER-PANCHROMATIC

Super-fast; high sensitivity requiring minimum of light. Weston 50 daylight—32 photo-floods, machine processed. Per 100 ft. . . . **\$4.25**

California Buyers Include Sales Tax
10% DISCOUNT IF YOU ORDER ONE ROLL OF EACH OF THE ABOVE FILM AT ONE TIME.
Regular cost, \$9.60. Special discount price, \$8.64.

THRIFTY FILMS

Drawer 98, Watts Station Los Angeles, California

PRESENTING

A NEW FILM PLAN MOVIE A MONTH For 8mm Fans

- Have you taken advantage of this new film viewing plan?
- Far as low as 35 cents a reel you may view complete edition Castle Films.

AND THAT'S NOT ALL!

- You receive an headline reel FREE! You select it and own it.
- It's a great service for 8mm fans.
- Write now for further details.

MOVIE A MONTH ASSOCIATION

Box 524 Reynoldsville, Pa.

The Service That Saves

DRESS UP YOUR MOVIE TITLES

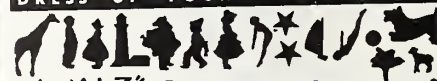

"A to Z" Figurettes for movie title backgrounds

STICK 'EM ON—PEEL 'EM OFF
Figurettes may be used over and over again. Easily applied. Will stick instantly to any surface. Photographs perfectly with black and white or color film.

IT'S EASY—IT'S FUN
Complete \$1.00 Instructions
Assortment \$1.00 Title Distance Chart
FREE—Sample Figurette—Try It
JACOB STEIN (Mir.)
175 5th Ave., Dept. F2 New York City

30 FIGURETTES IN BRILLIANT COLORS

DEVELOP and PRINT YOUR OWN 16mm Sound Silent FILM

with the **PHIL-LAB** DEVELOPING RACK
100 ft. Racks in 11x14 Trays
Also 25 ft. Racks for Titles
Continuous Silent or Sound
Printers up to 400 ft.

Send to Dept. M for Descriptive Circular
Philips Laboratory 653 Hillcrest Ave.
Westfield, N. J.

Use GENERA PDQ REVERSAL PROCESSING POWDERS

for 35 mm, Bantam, 16 & 8mm black & white & Dufaycolor Reverse your Films for Projection—Anyone can do it.
No. 1 Set—1/2 gal. size: PD12 Developer 65c; Bleach 15c; Clearing 25c; Hardener 15c; Set, postpaid, \$1.20.
No. 2 Set—1 gal. size: PD12 Developer 95c; Bleach 25c; Clearing 40c; Hardener 25c; Set, postpaid, \$1.85.
Simplified Processing Outfits including our Prepared Powders: For 35mm and 8mm, \$3.35, postpaid; Dble. 8 and 16, \$4.95, express. Instructions included.
Reducing Powders for dense films, 1 gal. size . . . 35c
Send stamp for processing instructions, Bulk Film prices.
FROMADER GENERA PRODUCTS, Davenport, Iowa

profusely, then stops to try on gloves. Playfully passes gloved hand under Father's nose, then Father starts to don other pair of gloves.

Scene 27. Closeup of Father tying on one of his gloves. Looks up at boy (out of scene) and speaks:

Title: "Well, son, now you get your first real boxing lesson."

Scene 28. Back to scene 25, as Father finishes speaking.

Scene 29. Same as 24. Boy hears Father's words, and says, "O. K. — come one!" Then putting up one of his gloved hands he starts sparring with Father. The two try tying on each other's gloves, and after some difficulty succeed, then square off and prepare to box.

Scene 30. Medium long shot of previous scene. Boy and Father start maneuvering. Father takes the advantage and lands aggressive punches.

Scene 31. Medium close-up of Father pushing boy around. Boy momentarily drops his guard and Father lands a blow square on boy's nose. This stops the fight momentarily, and Father walks over to boy to console him, saying as he holds left arm in front of him:

Title: "Look, son — you must always keep your left up!"

Scene 32. Back to scene 29, as father finishes speaking and demonstrating how to "hold up his left."

Scene 33. Closeup of Junior rubbing his nose with one of his gloved hands. He nods, indicating he understands Father's instructions; then, with a determined scowl on his face, he spits into his glove, doubles up his fists and prepares to fight some more.

Scene 34. Same as scene 30. Father and boy boxing again. Boy, a bit wiser for Father's advice, keeps out of range of Father's blows. Father slowly relaxes his guard, and is breathing heavily.

Scene 35. Closeup of Father, with gloves up, and breathing hard. He speaks to boy:

Title: "Now, you try to get through my guard . . ."

Scene 36. Back to scene 35 as Father finishes speaking.

Scene 37. Medium long shot of the same scene but

from a lower angle that shows a window at rear or side of the house in the immediate background. Mother comes to window, opens it, and calls out. Father looks around at her. As he does so, a blow, which the boy started to swing before he looked away, catches him right on the eye. Cut to—

Scene 38. Big closeup from low angle, as boy's glove connects with Father's eye.

Scene 39. Medium shot of boy and Father as Father reels back from blow. Staggers dizzily.

Scene 40. At this point cut in about two feet of trick effects to indicate Father's sensation of being knocked out. How to do this is explained in the item on "Trick Shots" on page 253.

The necessary effect may also be filmed right on the spot by inserting a supplementary lens in front of your camera lens and moving it back and forth in a line with the lens as same is focused on the boy. This will produce a blurred, out-of-focus effect which will be greatly enhanced if the boy has a wide grin on his face.

Scene 41. Medium shot of Father as with considerable difficulty he rises to a sitting position on lawn where he fell after receiving blow. He shakes his head, in an effort to clear it, rubs his eye which has already assumed some color, then looks up dazedly toward his son, who is just out of the scene.

Scene 42. Medium closeup of boy as he looks down at Father, rather elated at his feat in flooring him. Looks at his right gloved hand, motions it in a manner similar to that of the near-knockout blow, and with a sudden expression indicating that now he knows how to swing the lucky punch, he looks off out of scene as though contemplating something mischievous. Tearing off the gloves, he rehearses his fighting action, then dashes out of the scene, ostensibly to challenge the chap with whom he fought the day before!

Scene 43. Same as scene 37. Father, still rubbing eye, watches son leave and calls meekly after him. Fade-out.

Scene 44. Same setting as

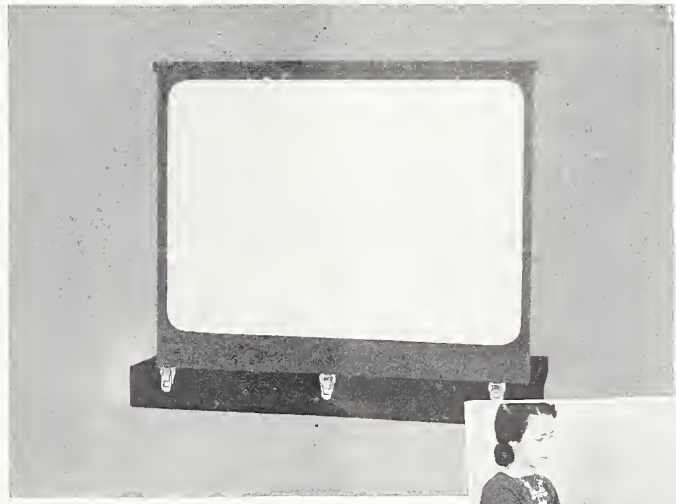

2
MODELS
6
SIZES

4 STAR HOME MOVIE Screens

What has a 4-Star Screen that other screens haven't got? When you buy a 4-Star Screen you buy a screen only once! — a brilliant screen of fine crystal beads that improves projected movies 100%. Special soft felt backing — an exclusive feature — prevents loosening of beads by friction, protects beaded surface when screen is rolled up. 4-Star "Senior" Model Screens are mounted on self-erecting frames in sturdy, lightweight, leatherette covered boxes.

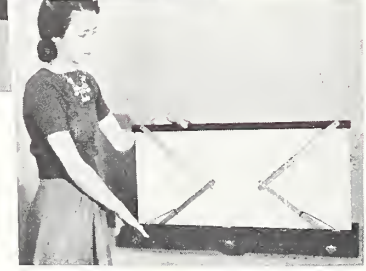

Senior Models are instantly self-erecting. Exclusive principle insures against wrinkle-damage — holds screen sag-free.

22" x 30" . . . \$9.95 30" x 40" . . . \$13.95 36" x 48" . . . \$17.95

JUNIOR WIRE EASEL MODELS
. . . have all the special features of the "Senior" models except they are mounted on two battens and are made to stand erect on a table by two wire easels and small wooden legs that fold out of the way when screen is not in use.

22" x 30" . . . \$3.95 30" x 40" . . . \$5.50 36" x 48" . . . \$8.50

HOLLYWOOD CINE PRODUCTS CO.

3221 South Figueroa Street

Los Angeles, Calif.



GOERZ KINO-HYPAR LENSES



f:2.7 and f:3
For regular and color movies of surprising quality — high chromatic correction . . .

Focal lengths 15mm to 100mm — can be fitted in suitable focusing mounts to Amateur and Professional Movie Cameras.

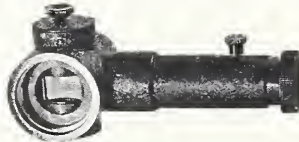

GOERZ Reflex FOCUSER

— Patented —

For 16mm Movie Cameras — voids PARALLAX between finder and lens — provides full-size ground-glass image magnified 10 times. Adaptable to lenses 3" and up. Also useful as extension tube for shorter focus lenses for close-ups. Extensively used in shooting surgical operations, small animal life, etc.



GOERZ Parallax-Free FOCUSER and FIELD FINDER CONTROL

No more off-center pictures, for Filmo 121 and Simplex-Pockette magnifies 4 and 8x.

For Detailed Information Address Dept. HM-5

C. P. Goerz American Optical Co.

317 East 34th St., New York

American Lens Makers Since 1899

SOLAR FILM

Costs Less!



Whether you spend much or little for your movies, get the film that gives you better pictures for less. Your dealer has SOLAR FILM or can quickly get it for you. If more convenient, order direct from this ad and mention dealer's name.

	Weston Rating	16mm 100 ft.	16mm 50 ft.	Dbl. 8mm 25 ft.
Solar ECONOMY Outdoor	8	\$2.50	\$1.75
Solar SUPER Outdoor	12	2.95	1.95	\$1.39
Solar HI-SPEED	24	5.50	3.25	2.00

Prices include processing at our Chicago, Miami, or Arlington, California, plants, and return postpaid to you. One of three Solar Processing Laboratories is less than 24 hours from 90% of all movie camera fans. Learn more about these low-cost Solar films. Try them. Ask your dealer. Write for descriptive literature, today.

Dealers Write for Special Offer

SOLD BY OVER 300 LEADING DEALERS IN 49 PRINCIPAL CITIES

SOLAR CINE PRODUCTS INCORPORATED
3827 Archer Avenue, Dept. 1A CHICAGO, ILLINOIS

WHY PAY MORE THAN \$3.00 FOR PERFECT OUTDOOR FILM PERFORMANCE



CINE SAFETY FILM FOR USE IN 16mm MOVIE CAMERAS

KIN-O-LUX 16mm FILM No. 1

... unless, of course, you're the sort of person who likes to pay more. Three dollars for a 100-ft. roll of Kin-O-Lux No. 1 Film includes every essential requirement for good outdoor filming. It offers brilliancy—snap-gradation—latitude—tonal fidelity—anti-balation backing—free Scratchproofing to insure long life and the maker's unequivocal guarantee. Within limitations that preclude indoor filming and filter use, its performance is identical to that of more expensive films.

DAYLIGHT EMULSION SPEEDS

Scheiner 16°	Weston 6
100-ft. roll	\$3.00
50-ft. roll	\$2.00

KIN-O-LUX No. 2. Fine-grain, semi-chromatic. Greater speed and wider latitude than No. 1 Daylight Emulsion Speeds: Scheiner, 18°; Weston 12.

50 ft.	\$2.50
100 ft.	\$3.50

KIN-O-LUX No. 3. Supersensitive over the entire range of the visible spectrum, Kin-O-Lux No. 3 has established a new standard of film performance. Achieves an ultimate, present-day perfection that cannot be surpassed. Is preferred by movie makers who discriminate in favor of the best. Daylight Emulsion Speeds: Scheiner, 26°, Weston 50. Tungsten Speeds: Scheiner, 24°, Weston 40.

100 ft.	\$6.00
50 ft.	\$3.50

ALL FILM PRICES INCLUDE PROCESSING, SCRATCH-PROOFING AND RETURN POSTAGE

At Leading Dealers Everywhere
Booklet H-5 on request

Learn about Glare-Free, Reflectionless Photography. Send for instructive Folder on Marks Polarization Plates.

KIN-O-LUX 16 MM REVERSAL FILM
KIN-O-LUX, INC.
105 W. 40th ST., N. Y. C.

scene 6. Fade-in. Medium closeup of Father slouched down in lawn chair and reading book which hides his face. A thin wisp of cigar smoke wafts lazily upward from behind the book.

Scene 45. Closeup of book in Father's hands but still covering his face, revealing title, "Boxing in Ten Easy Lessons."

Scene 46. Back to scene 44. Father lowers book momentarily in order to remove cigar from mouth and flick the ashes, thus revealing an exaggerated black eye and his glum expression. He resumes reading without changing expression. Fade-out.

Title: THE END.

Down Mexico Way...

• Continued from Page 229

in the vicinity of Victoria. It is advisable to make the most of this opportunity to film these villages as, farther along the highway, they are not so easily approached.

Beyond the 550 kilometer marker, the country begins to take on true tropical appearance. At this point it is advisable to unlimber the telephoto lens, for here will be found opportunity to get shots of rare birds lurking in the lush tropical growth along the roadside. The region is also abundant in rare and magnificent flowers, and just beyond is a picturesque area thickly studded with huge palm trees

The next town of interest is Tamazunchale—pronounced like "Thomas an' Cholly." At this point is operated a good tourist camp that affords excellent overnight accommodations for the traveler who wishes to rest before proceeding on to Mexico City. Tamazunchale is a picturesque and very old town and, like many others in its vicinity, was completely isolated before the coming of the highway—peacefully reposing where time has practically stood still for centuries.

Here may be seen native women taking care of the family laundry on the banks of a nearby river, and native milkmen dispensing their wares in any and every conceivable kind of container. A view from the bridge over the nearby Moctezuma River—its banks verdant with rich, tropical growth—is one of the most impressive sights on the whole trip.

Leaving Tamazunchale, the highway parallels the

torrential Moctezuma River for several miles, and then begins the long ascent over the picturesque Sierra Madre del Oriente mountains. Here will be found what is perhaps the most awe-inspiring mountain scenery on the whole American continent! Here, indeed, will occur the long awaited opportunity for the "black and white" filmer to dust off the filters and obtain swell "cloud effect" shots. Nor will the Kodachrome filmer be left idle at this point, for fleecy white clouds scudding lazily across the deep blue Mexican sky will present many opportunities for truly artistic color compositions.

For more views of a typical Mexican town, one should be prepared to train his camera on Zimapan, nestled in a picturesque valley, as descent is made on the highway leading into it. In Zimapan is a highly ornate cathedral which has never been completed, although begun about 1525 A. D. Venerable old buildings and its plaza crowded with neighboring Indian natives make it a point on which to expend more than ordinary footage.

All along the route to Mexico City will be seen increasing numbers of one thing that is typically Mexican—the ever-present, ever-patient burro. This little animal has an important place in the Mexican scene—much the same as the automobile has in our own. Interesting are the astonishing loads they carry, and often the feet are the only evidence that a burro exists beneath the load! Here, in-

3 NEW REVERSAL FILMS

Provided with SPECIAL Black Colloidal Silver Backing. Fully Daylight Loading without Leaders. Finest Home Reversal Film Originally Made Double 8 Prescored for Easy Separation. Clear Base when Processed PERFECT FOR ALL 8mm CAMERAS. Guaranteed Fresh. True Weston Speeds. Spools and Processing Extra.

Complete New Reversal and Title Instructions Free with Film Orders. Separately, 25c each. Cash, Check or Money Order for Quick Service, or C. O. D. Air Mail, 50c, and Special Delivery, 15c Extra. Overpayments Refunded or Credited.

NEW SUPER PANCHRO REVERSAL
Weston 24-16 Anti-Halo Backing
PERFECT FOR KEYSTONE 8mm CAMERAS NOW
Originally Made 8mm Film

33 ft. Double 8—Pre-scored.	\$ 1.30
100 ft. Double 8—Pre-scored (16mm \$3.15)	3.60
400 ft. Double 8—Pre-scored (16mm \$11.60)	13.00
33 ft. Straight 8	.80
100 ft. Straight 8 (1 piece)	2.00
400 ft. Straight 8 (4-100-ft. rolls)	7.00

NEW MICROGRAN PANCHRO REVERSAL
Weston 12-8 (Extra Fine Grain), Anti-Halo Backing

33 ft. Double 8—Pre-scored	\$ 1.20
100 ft. Double 8—Pre-scored (16mm \$3.10)	3.30
400 ft. Double 8—Pre-scored (16mm \$11.50)	11.80
33 ft. Straight 8	.70
100 ft. Straight 8 (in 1 piece)	1.85
400 ft. Straight 8 (4-100-ft. rolls)	6.75

NEW HIGH SPEED ORTHO-CHROMATIC
Weston 16-6 Anti-Halo Backing
Prices Same as New Microgran Panchro

WESTON 8 SEMI-ORTHO REVERSAL
Weston 8-2 Darkroom Loading—Processing Extra

33 ft. Double 8 Scored—Clear or Lavender	\$.60
100 ft. Double 8 Scored—Clear or Lavender	1.50
400 ft. Double 8 Scored—Clear or Lavender	4.00
33 ft. Straight 8—Clear or Lavender	.40
100 ft. Straight 8—Clear or Lavender	1.00
400 ft. Straight 8—Clear or Lavender	2.75
100 ft. 16mm. All Tints Available	1.15
400 ft. 16mm. All Tints Available	4.00

Clear, Lavender, Amber, Blue, Yellow. Factory Perforated. Works Perfectly in All Cameras.

CINECHROME REVERSAL
Weston 8-2—Violet Non Halation Base

33 ft. Double 8 Not Scored	\$.75
100 ft. Double 8 Not Scored (16mm \$1.75)	1.85
400 ft. Double 8 Not Scored (16mm \$5.50)	6.00
33 ft. Straight 8	.50
100 ft. Straight 8—One Piece	1.15
400 ft. Straight 8—4-100 ft. Pieces	3.50

Super Cinepan & Cinechrome are Factory Perforated. Fully Daylight Loading When Spooled. Processing and Camera Spools, Extra.

CINE-KODAK POSITIVE TITLE FILM
Darkroom Loading—Processing Extra

33 ft. Double 8—Not Scored	\$.60
3-33 ft. Rolls, Your Choice Assorted Colors	1.50
100 ft. Double 8—Not Scored	1.35
400 ft. Double 8—Not Scored	4.10
33 ft. Straight 8	.46
3-33 ft. Rolls, Your Choice Assorted Colors	.85
100 ft. Straight 8—One Piece	.90
400 ft. Straight 8—In 4-100 ft. Pieces	2.15
100 ft. 16mm	1.00
400 ft. 16mm. In One Piece	4.00
25 ft. 35mm. Safety, Clear or Purplehaze	1.00
100 ft. 35mm. Safety, All Tints Available	3.00

Clear, Purplehaze, Yellow, Red, Amber, SPECIAL Blue, Also Lavender and Salmon Pink, DuPont make.

CAMERA SPOOLS WITH CANS

Double 8—ea. \$.35 Film St. 8—ea. \$.50	
Univex St. 8—ea. .20 16mm. 50 ft.—ea. .35	
Keystone St. 8—ea. .35 16mm. 100 ft.—ea. .65	
Extra Cans, 100 ft. and 50 ft. 16mm size—\$.10	
Extra Cans, Double 8 and Straight 8 size—.05	
Non-Humidifier Cans, 400 ft. 25c ea. 6 for—1.00	

MISCELLANEOUS

BAIA Precision 8mm Film Sitter, All Metal	\$ 2.50
FOTOFAD DYE, per bottle	1.00
FOTOFAD WIPE-OFF TAPE, per roll	.60
CINETINTS, Set of 6 COLORS and Instructions	3.00
BDEX CINELAC, Film Preservative, bottle	1.00
DUPONT VISCOS E SPONGES, each	.35
DARKROOM APRONS PLIDFILM, each	.75
HOW TO TITLE HOME MOVIES, Complete bk	1.00
HOME MOVIES, Back Issues, 1936-37-38-39	.15
(Not All Months) Back Issues for 1940 ea.	.30

REVERSAL PROCESSING, PER ROLL

100 ft. 16mm (1 piece)	\$1.50
25-30 ft. Double 8	.65
25-30 ft. Straight 8	.35

TITLE DEVELOPING, PER ROLL

100 ft. 16mm (1 piece)	\$1.25
25-30 ft. Double 8	.75
25-30 ft. Straight 8	.40

WE STOCK EVERY MAKE FILM
Write for NEW Price List

A Personal Movie Service
Also Available Evenings, Sundays and Holidays. Telephone Lincoln 1207.

W. Stuart Bussey Film Lab.
17 E. St. Joseph St., Indianapolis, Ind.

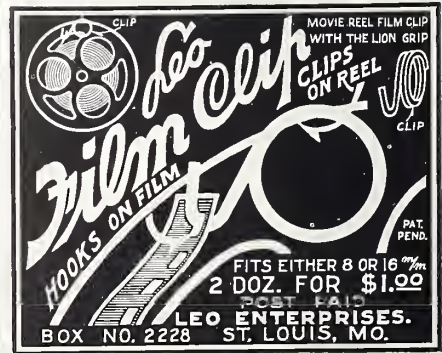

Film Clips
MOVIE REEL FILM CLIP WITH THE LION GRIP
CLIPS ON REEL
PAT. PEND.

FITS EITHER 8 OR 16mm
2 DOZ. FOR \$1.00
POST PAID
LEO ENTERPRISES.
BOX NO. 2228 ST. LOUIS, MO.

8M RAINBOW 16M

The following prices include processing and are for daylight loading films:

	25'	100'
	Double 8mm	16mm
No. 1	1.00	1.85
No. 1 Anti-Halo	1.25	2.15
No. 2 S S Pan Halo	2.00	4.40
No. 3 Pan Halo	1.50	3.50

The following prices are for laboratory packed films without processing:

	100'	100'
	Double 8mm	16mm
No. 1	1.25	1.20
No. 1 Anti-Halo	1.50	1.50
No. 2 S S Pan Halo	3.50	3.50
No. 3 Pan Halo	3.00	3.00

RATINGS:

	Weston	Scheiner
No. 1 Both Types	12-4	20-15
No. 2 S S Pan	50-32	26-23
No. 3 Pan	16-12	21-20

We Pay Postage on All Orders Except C.O.D.

RAINBOW LABORATORIES

STATEN ISLAND, N. Y.

NO MORE Spoiled FILM!

\$1.95

NOW—PERFECT PICTURES WITH ANY CAMERA!

Most accurate and lowest-priced extinction-type meter. Reads direct in Weston Ratings. Automatically corrects for film speeds, filters, subjects, etc. Made of G. E. Textolite. Waterproof case included. At all dealers.



Univex EXPOSURE METER

16MM

DuPont Regular Pan Film

Makes Better Home Movies at Less Cost

Standard speed, FULL PANCHROMATIC sensitivity, wide latitude, fine grain. Has all qualities of costlier black and white films except extreme speed. Excellent for normal outdoor shooting or indoors with photo-floods. Can be used with filters. Calif. buyers include sales tax. Including Reversal Processing..... 100-ft. roll

\$4.50

Write for Free Bulk Film Catalogue

HOLLYWOODLAND STUDIOS

SOUTH GATE CALIFORNIA

Bass says:



Bring on your movie problems . . . I have the answer in the

MOVIKON 16

A Zeiss triumph . . . fitted with Contax type optical range finder (built in) and Sonnar F:1.4 lens. One of the finest precision cameras made . . . complete with swell case . . . \$385

Send for Special Cine Bargaining No. 240

FREE FOR THE ASKING

Bass CAMERA CO.

179 W. MADISON ST. CHICAGO, ILL. Dept. H. M.

BETTER MOVIES

WITH BLACK & WHITE FILM



100 FOOT SAFETY FILM ON DAYLIGHT LOADING SPOOL FOR 16 MM CAMERAS

\$1.98

Rating: Weston 12, Scheiner 18

At your dealer or direct. Fast service processing same day included at no additional cost.

VISUAL INSTRUCTION SUPPLY CO.

1757 Broadway Box H9 Brooklyn, N. Y.

MAKE YOUR OWN TITLER!

For all types of titles, close-up and copy work. Complete kit of finished parts—optically ground lens—easy instructions. Assemble in 15 minutes! Money Back Guarantee. State camera model.

\$1.65

IN KIT FORM

For All 8 or 16 MM CAMERAS

Distinctive Title Card—"Photography by (your name)"—35c

HOLLYWOOD MOVIE SUPPLY COMPANY

NORTH HOLLYWOOD • CALIFORNIA

deed, is highly interesting filming fare!

Just 47 miles south of Zimapan, one eventually reaches the gem of Mexico—Mexico City. As to what, when, and where to shoot in and around Mexico City—that is almost another story in itself. The Zocalo is the city's central square and a good point from which to begin filming. On the south side of the Zocalo is located one of the government administration buildings. Permission will gladly be granted by authorities to ascend to the roof for the purpose of filming the city. From this point, an excellent shot may be secured of the big cathedral located directly across the square.

Mexico City is teeming with interesting material for the home movie filmer, and it is hardly necessary to set down here a list of the important filming points. So abundant is photogenic material on every side, one would scarcely refer to a guide book were one available.

There are many interesting side trips of one day duration which the traveling cinefilmer may take to advantage, such as the nearby pyramids of San Juan Teotihuacan; the floating gardens of Xochimilco—pronounced "So-chee-meelko"; the city of Puebla;

and Cholula—a little town containing more than 350 churches; and others, all of which furnish unlimited cinefilming material.

Where time permits, one may be well repaid by proceeding on to Taxco. Here some of the most beautiful examples of Mexican architecture are to be seen. This little city has been preserved in all its original glory, with age-old cobblestone streets; red-tile roofs; community laundry centers, etc.

The return trip to the United States will afford opportunity to capture shots overlooked or unplanned on the trip south—that is, if any film is left! Wise filmers will shoot plenty of closeups at every opportunity. Mexico is a country teeming with interest, and unless you look *closely*—through your viewfinder—at its people, its buildings, and its industry, much will be missed that words never can aptly describe.

If you want to set out for a real "Roman Holiday" of movie making, then head south of the border. No other place—no other trip on the American continent, perhaps—will afford so much real cine clicking pleasure!

Can I improve my Film?

• Continued from Page 233

in his home and reading, with some trepidation, a horror-thriller novel. At a critical moment in the story his young daughter enters the room wearing a Halloween mask, momentarily frightening her father. Annoyed, he sends her out of the room to dispose of the mask, which the little girl attempts to do by climbing up into a tall cupboard and upsets some of its contents. This brings mother on the run, who orders her husband to take the girl out for a stroll.

We see father and child strolling in the park. A snapshot camera is carried by father, and as he approaches a park bench, a friendly female stranger strikes up an acquaintance

with him. Picture taking follows, and not long afterward the husband has the girl's phone number.

That evening, with the youngster tucked in bed, mother decides to go to the movies alone. After she leaves, father calls up his new acquaintance and invites her to the house to watch him develop her picture taken that afternoon.

The girl arrives and after a few scenes in the darkroom, none of which are censorable, they go into the living room for a tete-a-tete and highballs. Presently there are closeups showing the two in an amorous pose and the husband's face decorated with lipstick. This is followed with a flashback to mother walking down the street toward the theater as she discovers the absence

AT THE WORLD'S FAIR

THE EASTMAN KODAK COMPANY USED



exclusively to portray the gripping beauty of "The Cavalcade of Color." This was no haphazard choice but a definite selection prompted by the exacting requirements of the subject. In all branches of movie making—professional, industrial, educational and amateur—wherever the advantages of precise screen-rendition are understood—a Raven Screen is invariably the logical choice. Investigate the Superiority of Raven Screens at your dealer's or write for folder 58 which describes the five tested fabrics, nine different mounts and thirty various sizes in which these screens are available.

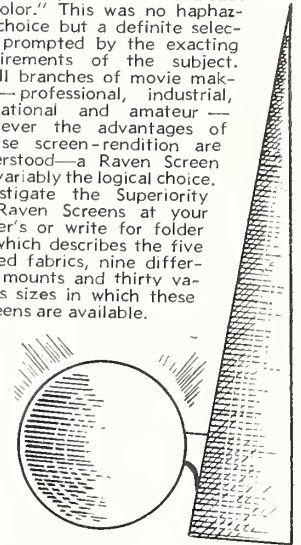

RAVEN SCREEN CORP.
314 East 35th Street NEW YORK

PROPER LIGHTING—THE FIRST ESSENTIAL IN HOME MOVIES

Properly lighted, each detailed movement of your subject comes alive with the utmost in dramatic effect. Use the same type of lighting cinematographers and studios do.

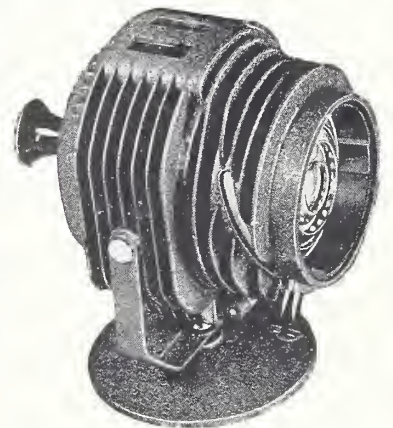

F-R HI-SPOT
Hollywood Type Spotlight
Complete with Special High Efficiency F-R HI-SPOT PROJECTION LAMP..... **\$9.95**

Equipped with the famous Fresnel lens, heat dissipating construction, ample ventilation and many other distinctive features. Tripod-mounted or adapted to any standard light stand, it affords complete directional control from any angle. Compact and lightweight (less than 6½" overall), it is easily handled. Write to Dept. 29 for free copy of John Hutchins' new booklet, "THIRD DIMENSIONAL PORTRAITURE—How to Get It."

FINK-ROSELIEVE CO. Inc.
NEW YORK • CHICAGO • LOS ANGELES

GET ACQUAINTED

... WITH ...

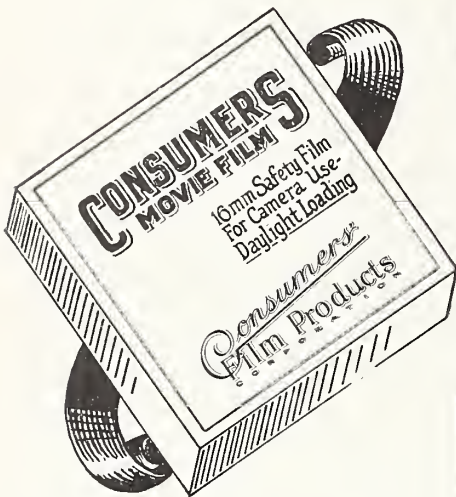

FULLY GUARANTEED

as to **Speed Rating**
Excellent Quality
Fast Processing

Our plant has a capacity of 1,000,000 feet per week with complete Modern Machine Processing, also a Complete Laboratory Service.

Managed and Directed by Professional Craftsmen with high records in the Motion Picture Profession for over 20 years.

CONSUMERS' CAMERA FILMS

Are Popular Priced

	16mm: 100 ft.	50 ft.
Consumers' Ortho	\$3.00	\$2.00
(18 Scheiners, Weston Daylight 8)		
Consumers' Panchro	5.00	3.00
(23 Scheiners, Weston Daylight 24, Tungsten 16)		
Consumers' Colorcrome	6.00	3.00
(18 Scheiners, Weston Daylight 8)		
A Colortone Process (Not a Natural Color)		



ONE Park Avenue New York City

Buy Our Films Today and You Are Assured of Outstanding Value as to Quality and Price in Home Movies

SPECIAL OFFER

As a special introductory offer, you may use this coupon below and receive credit of \$1.00 per 100-ft. roll or 50c per 50-ft. roll on your first order either from your dealer or direct by filling in your dealer's name and address, should he not have our film in stock, we will credit him with the sale.

COUPON

This Coupon Is Worth \$1.00 on each 100-ft. Roll and 50c on each 50-ft. Roll

Customer's Name.....

Address.....

Dealer's Name.....

Address.....

Check Below

Ortho Panchro Colorcrome

CONSUMER FILM PRODUCTS

1 Park Ave. New York City, N. Y.

Not more than two of each to a customer. Coupon good until June 15th, 1940.

of her purse. She turns and retraces her steps toward the house. Entering her home, she surprises her husband and friend. The girl is ordered to leave, and the husband handed a lacing with an umbrella. The next morning finds husband in bed with a black eye and an ice pack on his head.

Continuity was well worked out. The story held together good, and commendable is the fact that not too much footage was given to the actors just to show them off, as is so frequently done.

"HOWDY MR. SANTA!" ★★★
400 ft. 16mm — By V. L. W.

Most cinedads make it a special point to film the Christmas doings of their kiddies as a part of their growing-up record. Those who search vainly for a smooth Christmas continuity each year will do well to make a note of this one. The story is notable for some of the unusual things this filmer has accomplished.

The picture starts with a closeup of little 16 months old Bill window shopping with his mother. This permits showing a number of interesting mechanical toys usually found on display in windows at Christmas time. As this picture was filmed in Detroit, the city's big annual Christmas parade is shown with occasional cut-backs of little Bill applauding.

Later there are scenes of the Christmas tree being trimmed and Bill is shown looking on with awe at his first Christmas tree, then making a dive for the intriguing toys spread beneath it.

The highlight of this picture is the different twist

given it through the animated filming of the toys. Unlike the stop-motion method of filming, the toys were operated like puppets, with near-invisible strings attached to their arms and legs, with which they were made to dance and cavort about by manipulation of someone out of camera range.

A sequence appears later where a squad of wooden soldiers are seen to march across the room. This was executed in stop motion and was extremely effective as well as colorful. Closeups of Bill applauding are cut in at intervals in a very effective manner. These shots of Bill were made closeup and did not show the rest of the scene, and therefore could have been made at some other time, then cut in later.

The animation of toys puppet fashion is something new to us and we feel it is something worthy of the efforts of any serious amateur filmer. It should open up a new field for those who wish to do something different in a Christmas film.

Editing: A few rough spots still remain in this picture, but no more than is ordinarily excusable in a personal film record of this kind. The film is obviously more of a record which is more important than perfection in the technical and cinematic phases of the picture.

In one instance, the direction of the parade is changed from left to right. Then the opening scene showing many people walking along the street is a bit unnecessary, as we felt the story concerns little Bill, and after all, it is intended

• All Amateurs, whether subscribers of HOME MOVIES or not, are invited to submit their films to the editors for review and helpful criticism. Unless otherwise requested, reviews of some of the films which we believe would benefit other amateurs will be published each month.

Reviewed films will be roted one, two, three, and four stars, and films qualifying for two or more stars will receive free, an animated leader indicative of such award. Detailed reviews, with suggestions for improvement — if any — will be mailed to amateurs submitting their films.

Exceptional films qualifying for the distinction of the "Movie of the Month" will be treated in detail in a feature length article in a following issue of HOME MOVIES. In addition, a certificate evidencing the award of "Movie of the Month" and a special animated "Movie of the Month" leader will be returned with such films after review.

When submitting films for review and onolysis, please advise make of camera, speed of lens, whether or not tripod was used, or if you used filters, exposure meter, or other accessories. While this information is not essential to obtain analysis of your film, we would like to poss it on for the benefit of other amateurs.

RIGHT ON THE NOSE!

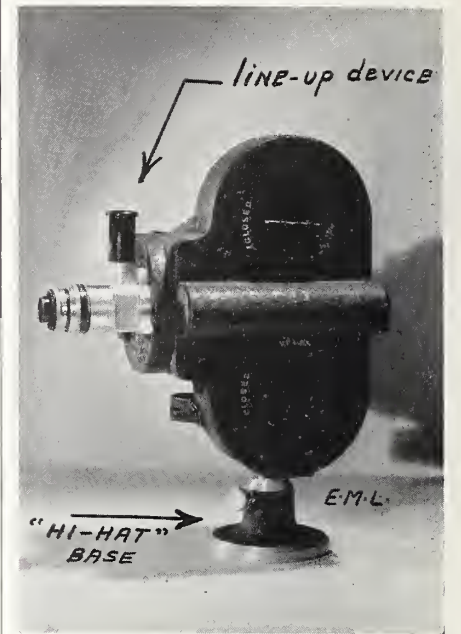

"NO PARLAX" ALIGNOSCOPE

(Immediate Delivery)

Complete **\$12.00** Postpaid, Insured

"SEE THE IMAGE before you SHOOT it!" Models to fit ALL 8 (or 16mm) cameras (for threaded lenses only, not clip or bayonet). A precision, optical instrument for lining up and focusing ULTRA closeups, insects, titles, etc. The REAL, clean-cut, highly mag., image is seen on viewing-screen using any focus lens. Alignoscope is removed before shooting.

QUICK—FAST TO USE—ACCURATE

State camera, model, etc. Enclose M. O. or check. ORDER NOW and receive a FREE (12x16-in.) "FOCUSING AND ALIGNMENT CARD" and a 3 to 42 in. Range "TABLE OF FIELD-SIZES CHART."

"HI-HAT" BASE, complete, postpaid, ins.....\$3.50 Precision-machined aluminum. Raises camera to std. 6-inch lens center. Has quick "SLIP-IN" brass adapter, with std. thd. top. Models to fit ANY 8 or 16mm camera.

NEW! IMPROVED CINESCOPE 8-16 POCKET-VIEWER \$1.00

MAGNIFIES 36 TIMES AREA. Optically-ground lenses insure a large, clear-cut image. Adjustable Film is slipped in, at the side. Groove holds film in position (see photo). A \$3.50 value—GOING FAST at \$1.00.

A REAL NECESSITY—ORDER NOW! State 8 or 16 mm. Enclose dollar-bill and dime post. (DON'T SEND STAMPS.)

157-pc. "moderne" TITLING-SET, \$1.95 ¾ in. high—¾ in. thick, of cast white DENTAL plaster. "Third dimension." NO PINS. Regular price, \$4.00 per set. Has letters, figures, etc. 157 pcs. Shipped ins. exp. (chgs. approx. 35c). DIME BRINGS SAMPLES.

ARE YOU ON OUR MAILING LIST? CAMERA SPECIALTIES

P. O. BOX 3182 HOLLYWOOD, CALIF.

Save ON PHOTOGRAPHIC EQUIPMENT

Write for our FREE CATALOG no obligation!

Our large turn-over permits us to sell for less! Complete line of "Still" and "Movie" equipment.

SUNNY SCHICK

National Brokers
403 W. WASHINGTON BLVD.
FORT WAYNE, INDIANA

MODERNIZE—Trade in Your Equipment!

EQUIPPED to Serve You... with a comprehensive line of CAMERAS & ACCESSORIES
KLEIN & GOODMAN
18 S. 10th Street, Philadelphia, Pa.

Professional-Looking
**FADES
LAP-DISSOLVES
WIPES
VIGNETTES**

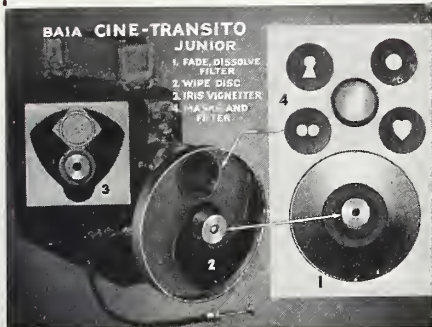

Operated by Clockwork

- ★ 12 Transitions on one winding.
- ★ Warning buzz—stops automatically.
- ★ Weighs only 4 oz.
- ★ Attaches to lens instantly and in exact center.
- ★ Packed in attractive kit.

Price \$795

With Wipe Disc Adapter and Cable Release
Accessories

FADE DISC	\$1.95
VIGNETTER	\$1.95
MASKS	25c each
Extra ADAPTERS	95c each

Specify Camera and Lens

From Your Dealer or Direct

WINDBACK: For Model K, has winding key with frame counter; on C-Kodak 8 includes 8 frames hand crank. Price \$27.50

Write for Free Booklet
"What Are Transitions?"

BAIA MOTION PICTURE ENGINEERING
8044 Hardyke Detroit, Mich.

DAYLITE LOADING
BULK FILM FOR ALL 8mm and 16mm
CINE CAMERAS - SPOOLED READY
FOR CAMERA USE. 7 Emulsions
from which to choose.
State Make of Camera Please
ESO-S CINEFILMS
3975 Menlo Los Angeles, California

Reelitone 16mm 35
SOUND-ON-FILM
RECORDERS • CAMERAS
WHY be satisfied with half the musical range when you can get the full range with a Shook & Pace Reelitone Recorder? Also world's finest recording units adaptable to many makes. Three-year unconditional guarantee.
PRODUCERS SOUND-COLOR PICTURES
SHOOK - PACE & BUTWIN
LABORATORIES
40 FORT STREET • FORTY FORT, PA.

8mm BULK FILM 16mm
Fine grain, Semi-ortho, Non-halation Weston 8. For titles or reversals. Lab. packed. Free formulas each order. All film guaranteed fresh stock — not re-perforated positive. California buyers include sales tax.
LOAD YOUR OWN—SAVE MONEY
400 ft. Straight 8mm for Univex, Keystone, etc. \$3.50
800 ft. 8mm in dbl. 8mm widths for all dbl. 8mm cameras. \$5.00
400 ft. 16mm. \$4.75
SPOOLS:—Univex, 5 for \$1.00. Dbl. 8mm, ea. 40c; 50 ft. 16mm, ea., 40c. 100 ft. 16mm, ea., 50c.
Write for Big Bulk Film Catalog
HOLLYWOODLAND STUDIOS
THE WEST'S GREATEST FILM MAIL ORDER HOUSE
SOUTHGATE, CALIFORNIA

as a record of his Christmas. Scenes are of good length with good intercutting throughout.

Titling: The titling of this picture is deserving of more than ordinary mention. The filmer is something of an artist, as is evidenced by the fine sketches and hand-lettering of his titles and the manner in which each of the beginning titles — main, credit

title, etc.—was made to roll away in a sort of wipe-off disclosing the next title beneath was very effective.

Photography: Was good. One cannot criticize photography when children are involved as subjects, because they must be filmed catch as catch can. In spite of this handicap, exposure was good and set-ups interesting.

Pep up your movies . . .

• Continued from Page 231

characteristic ripple to the banner.

We should like to add further that if the ripples are too rapid, slow motion will not only slow them down, but make them look more real. But of course if clouds are in the background, slow motion would practically "freeze" them. Stop motion with from two to three seconds between exposures will make the clouds move past the banner quite naturally (but make sure the clouds are moving from left to right if the airplane is headed from right to left).

The background process we are about to describe is similar to many we have published before; but since it varies in various details, we present it here exactly as it was sent to us by Mr. Vance B. Chamberlain of Garfield, Utah. He uses an Argus 35mm still camera and describes his procedure as follows:

"First of all I make the background on a piece of cardboard 22 x 28 inches. The cardboard is black and the design in grey or white. Next, the titles are made with white letters on the same kind of black cardboard.

"When the background and title cards are completed, I set them up, illuminate them, and photograph them with my Argus still camera. The camera is loaded not with the usual fast panchromatic materials, but with slow, positive, 35mm film. For illumination I use two No. 2 photofloods and give an exposure of 4 seconds at f.16. (Mr. Chamberlain did not say

how far his lights are from his title.)

"The 35mm film thus exposed is developed in a contrast developer such as D-11. Sometimes I make the titles with black letters on a white background, in which case the resulting film is white letters on a dark background. Using this film as a negative I make contact prints on another piece of positive film thus again reversing the tonal values to the same as they were in the original card—that is—black letters on a clear background.

"By now you have probably guessed what happens next. The film containing the lettering and the film containing the background are placed together and photographed with the movie camera on positive film. Two problems at first confronted me, and these were how to hold these small negatives and next how to focus on them.

"The problem of how to hold them was solved by slightly re-vamping my Eastman titler to hold a Kodachrome slide frame. This was found to be most satisfactory since both films must be in contact and held firm. Also, the Kodaslide permits easy alignment of the two positive transparencies and allows them to be changed quickly and easily.

"As shown in Fig 1, a slot was cut in the base to adjust the slide holder. Further adjustment of the slide holder is made by screws or bolts on the front side. Brass strips of thin material are placed at the top and bottom the slide

NEW! Univex 8mm
500 WATT PROJECTOR
\$42.50

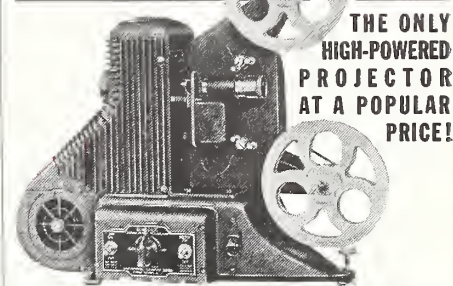

THE ONLY
HIGH-POWERED
PROJECTOR
AT A POPULAR
PRICE!

Brilliant illumination to give lifelike color-film projection, to liven up underexposed film. High speed f1.6 lens; polished reflector. Automatic cooling. Variable speeds. Projects perfectly to 5 x 7 feet. Many other important features. Completely die-cast frame, handsome brown crackled finish. The low price is as exciting a surprise as the projector itself! Free booklet, Dept. P.M. **Universal Camera Corp., N. Y. C.**

BE SMART! BUY UNIVEX!

NEW! Low Priced Univex Movie Camera

Gives you dependable performance, thrilling, life-like results. Uses economical 69c Univex film. New \$15 faster f4.5 lens. Built-in viewfinder.

Professional

- **FADES**
- **DISSOLVES**
- **WIPES**

now made possible by

Wind-Bak

for 8mm
Bell & Howell
Movie
Cameras

No More Choppy Scene Changes

With the sensational new Wind-Bak attachment for your Filmo-Eight, you can make smooth scene changes and put yourself right up in the professional class.

Just a Twist of "Wind-Bak"
and Hollywood theatre-technique is right at your fingertips. Wind-Bak is so simple to operate! You can easily superimpose scenes, make cut-aways, ghost titles and artistic fades. You can wind back any portion of the film, one foot or the entire roll.

Your Camera Still Carries

the regular Bell & Howell factory guarantee with our Wind-Bak installed. Simply ship your camera to us, and our trained technicians will make the necessary installations and return your camera promptly ready for professional filming. All work guaranteed.

Write for Further Literature
\$19.95 COMPLETELY INSTALLED

National Camera Exchange
11 South 5th Street Minneapolis, Minn.

Rental Rates Reduced on Cine Equipment

16mm. PROJECTORS

Article	Rental Price:		Deposit
	Day	Week	
KEYSTONE 300 watt	\$ 1.50	\$ 5.00	\$ 25.00
KEYSTONE 500 watt	2.00	7.00	30.00
BELL & HOWELL 750 watt	3.00	12.00	90.00
BELL & HOWELL 1600 foot reel 750 watt	5.00	20.00	120.00
BELL & HOWELL 1600 foot reel 1200 watt	7.50	25.00	250.00
BELL & HOWELL Filmo Sound 750 watt	12.00	40.00	250.00

8mm. PROJECTORS

KODAK 300 watt	\$ 1.50	\$ 5.00	\$ 25.00
BELL & HOWELL 400 watt	2.50	10.00	75.00

16mm. CAMERAS

KEYSTONE 3.5 lens	\$ 1.50	\$ 5.00	\$ 20.00
KODAK 3.5 lens	2.50	7.00	25.00
KEYSTONE 1.5 lens	3.50	10.00	50.00
BELL & HOWELL 70A 1.5 lens	4.00	12.00	60.00
KODAK 1.9 lens	4.00	12.00	70.00
MAGAZINE KODAK 1.9 lens	4.00	12.00	85.00

8mm. CAMERAS

KEYSTONE 3.5 lens	\$ 1.50	\$ 5.00	\$ 17.00
KODAK 3.5 lens	1.50	5.00	20.00
KODAK 1.9 lens	2.50	7.50	50.00
BELL & HOWELL 2.5 lens	2.50	7.50	50.00

SLIDE AND 35mm. STILL PROJECTORS

OPAQUE BALOPTICAN	\$ 4.00	\$ 12.00	\$ 75.00
KODASLIDE NO. 1	1.50	5.00	15.00
ARGUS SLIDE, MODEL B	2.50	8.00	25.00
3/4x4 SLIDE PROJECTOR	3.00	10.00	40.00

SCREENS

30x40 or 36x48	\$ 1.00	\$ 3.00	\$ 10.00
39x52 or 45x60	1.50	4.00	20.00
54x72	2.50	7.50	40.00
6x8 or 8x10 ft.	4.00	12.00	40.00

PROJECTIONISTS AND CAMERAMEN

OPERATOR FOR SILENT PROJECTOR \$5.00
OPERATOR FOR SOUND PROJECTOR 7.50
Rates on Request for Out-of-Town Showings

16mm. CAMERAMAN, PER DAY \$25.00
Includes Complete Equipment;
Film and Transportation Extra
Rates for Special Work on Footage Basis by Request

COMPLETE SILENT OR SOUND SHOWS STAGED;
PRICES ON REQUEST

NO DELIVERY OR PICK-UP OF RENTAL EQUIPMENT

Willoughbys

110 West 32nd Street, N. Y.
World's Largest Camera Store
Built on Square Dealing

holder and bent in such a way that they hold the Kodaslide firmly yet allow movement to either side. Thus the Kodaslide can be moved in all four directions as well as forward and back.

"Focusing on this small area was accomplished by employing a small copper extension tube of the right length to conform with the area to be photographed.

"With my 20mm f. 3.5 lens, I found that an extension tube of 3/8" was correct. When photographing, I set the footage indicator at 25'.

"And now as to the actual exposure. The light of course must come from the rear. My illumination consists of a white card placed 10 inches in back of the Kodaslide holding the title. (Fig. 2) On each side of the white card at an angle of about 45° and 8 inches away I place a No. 2 photoflood bulb in a reflector.

"I found f.4 to be a satisfactory exposure when the camera is running at 8 frames per second and loaded with Eastman positive

film. Development was carried out in D-11." (Time not given.)

We should like to add to what Mr. Chamberlain has given, that a smaller diaphragm opening and less exposure would be possible if a piece of ground glass were substituted for the white cardboard and one photoflood placed a foot or so behind it.

And also, there is no reason why this set-up wouldn't be an excellent one for copying Kodachrome slides on Kodachrome film. By re-winding such an exposure and shooting white letters on a black background, white titles on a colored background are easily possible.

Thanks to both Mr. Pre-diger and Mr. Chamberlain for their courtesy in passing this information on to the rest of us cine fans. We're always glad to receive new stunts along this line, and if you'll shoot them into us, we'll see that they are given the consideration they deserve.

Ways to improve exposure . . .

• Continued from Page 234

Other meters use the Scheiner system of rating. An average film might be rated 20 Scheiner. However, a film with half the sensitivity would not be 10 Scheiner, but 17. The Weston and Scheiner systems are not directly comparable, being based on different principles of light reading.

There are several other systems in use, such as H & D, Din, European Scheiner, etc., and you will encounter them on foreign-made meters. None of the systems is difficult to use although you must, of course, know how your film is rated in that particular system.

The various exposure meters differ greatly in the field covered, some having angles as great as 70°, others as small as 30°. The average camera includes an angle of about 60°. However, you will not want to

make a reading from camera position at that angle. The meter cannot discriminate between the important and the unimportant portions of your picture, and if a considerable part is sky or deep shadow, an average reading of the whole scene would give a false reading of the subject you really want correctly exposed.

The most satisfactory method of taking a reading is to include the main point of interest only, if it can be approached. Point the meter directly at the subject, holding it about as far away as the subject's height.

Be careful not to get your own shadow in the area read. The meter must be shaded if the sun is behind the subject, and the reading should be taken of the shadow area, in back-lighted scenes.

If it is impossible to approach the subject to be taken, take an average read-

PEERLESS "PLUS + VIOLET" REVERSIBLE MOVIE FILM ASSURES YOU OF BETTER MOVIES

"PLUS + VIOLET" is the kind of film you have often wanted but have been unable to find in its class price.

"PLUS + VIOLET" is a medium speed (Weston 12, Scheiner 20), fine grained outdoor type film with wide latitude anti-halo backing and a special base which filters out all of the low frequency rays of the projection lamp, giving upon the screen a more brilliant and pleasing picture.

"PLUS + VIOLET" is not just another cheap film at a low price, but is a SUPERIOR film in the low price class. It is offered as a splendid film for those who wish to get good results on a limited film budget.

A trial will convince you that "PLUS + VIOLET" will enable you to take more and better shots for less money. Order today one or more trial rolls of "PLUS + VIOLET" at these attractive prices:

30 ft. 8mm spooled for Univex. .60c
2 rolls for \$1.00

25 ft. double 8mm. \$1.00
4 rolls for \$3.50

100 ft. 16mm. \$2.35
4 rolls for \$8.00

Above prices include generous extra footage for leaders, daylight loading spools, processing, projection reel, and return transportation.

"PLUS + VIOLET" PANCHROMATIC

A high speed fully panchromatic "PLUS + VIOLET" reversible film with a speed rating of Weston Daylight 32 and Mazda 20—Scheiner Daylight 24 and Mazda 22. 100 feet 16mm on daylight loading spool, including processing, \$4.50, or 3 rolls for \$12.00 (8mm not available).

SPECIAL TRIAL OFFER

One 100-foot 16mm roll each of our regular "PLUS + VIOLET" and one roll of our Panchromatic "PLUS + VIOLET"—a \$6.85 value for only \$5.00.

ALSO SOLD IN BULK

Write for Descriptive Circular and Price Lists

Sold Only by

PEERLESS of HOLLYWOOD

P. O. BOX 1310-H

HOLLYWOOD, CALIFORNIA

16MM TITLES
10 Words 25c. Background Free
2c for each additional word.

16MM
8MM
.. TITLES ..
BACKGROUNDS FREE
Reducing * Enlarging
ILLUSTRATED CATALOGUE
GENERAL CINE SERVICE
204P East 18th St., New York

WESTON 8 ORTHO BULK FILM
400 ft. double 8mm scored . . . \$3.50
400 ft. 16mm \$3.50

24-HR. FINISHING GUARANTEED 45c
30 ft. of double 8mm.....
Gevaert, DuPont, Etc., Processed 25c
30 ft. single 8mm.....
30 ft. Univex Standard & U. P.....15c
ESO-S PICTURES
Quality 8mm Service
3945 Central Kansas City Mo.



EACH FRAME LIKE THIS...



Easy with a WESTON

Possibly you're satisfied just to get an occasional picture as good as this . . . forgetting all the disappointments, all the wasted film, in between. Actually, however, you can do it every time . . . have each and every frame you take correctly exposed. All you need is a WESTON Exposure Meter! Then, no matter where or what you are shooting . . . you have complete control of your negative results. Why not get complete information on WESTON Exposure Meters now; find out how easy it is to have all your movies correctly exposed. Ask your dealer for a demonstration, or write for illustrated literature. Weston Electrical Instrument Corporation, 585 Frelinghuysen Ave., Newark, N. J.

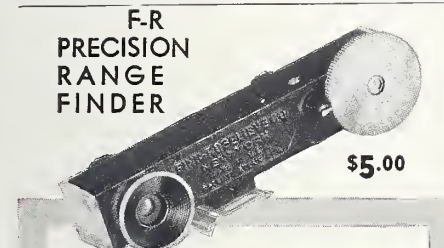

DON'T GUESS—BE SURE!
GET FINER RESULTS

For as little as \$6.00 the combined price of the F-R Precision Range Finder and the F-R Exposure Meter — you can provide yourself with the essential tools for eliminating the element of guess work from focusing and exposure problems. The F-R name — symbol of photography's truest value — unequivocally guarantees the dependability of these instruments.



FINK-ROSELIEVE CO. Inc.
NEW YORK • CHICAGO • LOS ANGELES

FOTOFADE

FADES, WIPES Can be added to your Reels after Processing WITH FOTOFADE on black and white or color films. Price \$1.00. Waterproof Wipeoff Tape, 60¢ per roll. Complete Fotofade Kit . . . \$1.60. **CINETINTS** for coloring your 16mm or 8mm film. Set of six colors \$3. At your Dealer or direct. **DYE RESEARCH LABORATORIES** 318 Jackson Street Los Angeles, Calif.

ing of the entire scene, pointing the meter downward slightly to omit as much sky as possible. If the scene is in strong sunlight and you want detail in the shadows, give it twice the exposure indicated by the meter. On the other hand, a scene with little contrast, as on a dull day, requires slightly less exposure than normal.

The exposure meter should be considered a guide, not a cure-all which never fails. Amateurs often

"f" stops no mystery . . .

Continued from Page 235

the volume of light is reduced by one-half. The following table will enable the reader to visualize this more readily.

OPENING UP LENS

	Increases Light
1 full stop . . .	100%
2 full stops . . .	200%
3 full stops . . .	800%
4 full stops . . .	1600%
5 full stops . . .	3200%

The table below shows the value or volume of light for each stop of an f/1.4 lens: Each f/ number represents one full stop.

Stop No.	Light Volume	
f/1.4	1,000%	
f/2	500%	or ½ the light volume of previous stop.
f/2.8	250%	or ½ the light volume of previous stop.
f/4	125%	or ½ the light volume of previous stop.
f/5.6	62.5%	or ½ the light volume of previous stop.
f/8	31.25%	or ½ the light volume of previous stop.
f/16	15.62%	or ½ the light volume of previous stop.

Once this data is fully visualized, the cameraman often can save precious seconds of time needed to get going and make the shot. The necessity of taking repeated readings with the exposure meter can be eliminated. Let us suppose we are working with a cine camera, shooting at the normal speed of 16 frames per second. Film and light conditions call for an exposure of f/8. The subject is a track

place too much reliance on their meters, with the result that when they are caught without one, they are helpless. As you use the meter, observe carefully the lighting conditions and the exposure used. Try to remember it when you see the negatives. You will be learning about exposure until finally you can drop the use of the meter in your general picture making, using it only for specialized work. Thus, to develop an "exposure sense" is a real achievement!

meet or baseball game with plenty of action.

Suddenly we find a subject we wish to film in slow motion at 64 frames per second — 4 times normal camera speed. Since the film will be traveling 4 times faster through the camera, each frame will pause before the film gate only 1/4th as long as at 16 f.p.s. — reducing exposure time to 1/4th. What stop must we use? Well, if exposure is reduced to 1/4th, then increasing the light 4 times will bring the exposure back to normal. But this does not mean opening the lens four stops! Referring to the last table above, it will be noted that the light volume of stop f/8 in the lens illustrated is 31.25%. Four times this volume of light would be 125%. Reference to the table shows that by opening up the lens two stops to f/4, the light volume of 125% is obtained. Therefore, f/4 would be the correct stop to use in this instance.

We may find instances where, instead of the f/ stops being obliterated on a lens, the focal length figures are missing. Given the speed of the lens and a rule, we can find this information quite readily.

Let us take this situation: We have a wide-angle lens of good make. It is just called a wide-angle lens — its focal length is unknown. The speed of the lens is f/1.9. Now, by using a ruler calibrated in millimeters, we measure the maximum

Bill Besbee says:

"Movie maker who make 'Big Shots' out of little outdoor subjects get special attention from audience!"

The movie amateur can center attention on anything, no matter how small, by means of the close-up. In this way, you can bring detail to your pictures that will add tremendously to their interest. This kind of close-up movie making is now made easy by the **BESBEE CLOSE-UP ADAPTER**. Take advantage of it — win your audience's admiration.

BESBEE CLOSE-UP ADAPTER KIT No. 52

Consists of adjustable lens holder which may be universally attached to any 8mm or 16mm camera . . . 2 close-up lenses for sharp pictures at 10" and 30" distances . . . tripod table for firm support of lens holder when tripod is used . . . special handle for all outdoor hand-held camera shots . . . \$3.75

BESBEE CLOSE-UP LENS SET No. 53

A combination of six additional auxiliary close-up lenses for sharp pictures at distances of 7, 12, 15, 18, 24 and 27 inches . . . \$4.00

FRAME YOUR MOVIES DIFFERENTLY

Every picture in your home has its own appropriate frame. Why not do the same for your movies? The **BESBEE EFFECTOGRAPH** lets you frame each movie in its own individual outline. In addition, you can have individual iris-in and iris-out effects, too. Try it.

BESBEE EFFECTOGRAPH, complete with ten masks and five different pairs of iris-in and iris-out effect shutters. Also functions as a highly efficient lens hood . . . makes unusual back-lighting effects \$10.50

A GOOD IDEA!

Take a **BESBEE STICK-ON LETTER SET** on your vacation trip. Title as you go. Avoid splicing in extra titles. Letters stick anywhere. Available in silver, black, blue or red. 150 Letters and Figures for only . . . \$5.25

Ask for Besbee at Your Dealer's or Write for Information

BESBEE PRODUCTS CORP. TRENTON, NEW JERSEY

Attention! Amateurs!

All amateurs using new miniature titlers such as Kodak, Keystone, Bell & Howell will make better titles more easily with the **NEW BESBEE POCKET TITLE LETTER SET**. Available in white or red letters. Complete set . . . \$3.50 **BESBEE PRODUCTS CORP. Trenton, N. J.**

Filmo

Movie Equipment Does Not Limit Your Skill!

FILMO movie equipment imposes no restrictions upon your skill. The more advanced you become, the better the basically complete Filmo serves you. There are no limits to quality or variety of movies it lets you make. That's why Filmo owners are satisfied owners.

Make your next movie purchase a Filmo. Write today for free literature describing cameras, 8 mm., 16 mm., or 35 mm.; projectors, sound or silent; or any particular accessory in which you are interested. Most literature is in interesting, illustrated booklet form. Write for information today. Bell & Howell Company, 1825 Larchmont Ave., Chicago; New York; Hollywood; London. *Since 1907 the largest manufacturer of precision equipment for motion picture studios of Hollywood and the world.*

PRECISION-MADE BY
BELL & HOWELL

NEW FREE CATALOG
MORE FUN WITH HOME MOVIES COST YOU LESS!

Improve your movie-making skill—and enjoyment. It's easy with the right equipment. This FREE book shows you how. It's the experienced home-movie maker's favorite guide—up-to-the-minute in equipment, and down-to-earth in price.

Lafayette's latest catalog contains the most complete home-movie section ever assembled. From popular cameras to beaded screens, it illustrates and describes color film, movie films, projectors, titlers, film chests, editing apparatus—everything for modern home-movie making and processing. All the leading manufacturers represented, and prices are unusually low. Send for your FREE copy.

FROM THE BOOK OF BUYS

HUMIDORS AND REELS for Movie Film

Humidors constructed of heavy gauge aluminum. Sturdy aluminum reels have patented sprocket feature. For use on any type reel arm. Capacity of 8 mm. reels—200 ft., 16 mm.—400 ft. Send today. Use Coupon below to order. Catalog **FREE**

8 MM. REEL
8 MM. HUMIDOR
29c each

16 MM. REEL
16 MM. HUMIDOR
39c each

LAFAYETTE CAMERA

LAFAYETTE CAMERA
Dept. 80-E—100 SIXTH AVE., NEW YORK, N. Y.
Rush FREE 1940 Camera Catalog.

I enclose \$_____ Please rush my order.

Name.....
Address.....
City..... State.....

diameter or the largest opening of the lens, *i. e.*, with the iris diaphragm fully open as shown in Fig. 2, and find it to be 7.9 millimeters. Using the formula already described, we do a little figuring, thus:

$$f/\text{equals} \frac{F}{D}$$

$$\text{We get } 1.9 \text{ equals } \frac{F}{7.9}$$

$$\text{Therefore } \frac{F}{7.9} \text{ equals } 1.9$$

and F equals 1.9 times 7.9, or 15.01, which is the focal length of the lens in millimeters. This could be worked out in inches and fractions just as easily, but it sometimes facilitates matters to work with the metric system.

Moviebugs who dabble in

Build this camera control...

• Continued from Page 230

work, etc., and the other, a double action switch. Both are mounted on a switch box at the end of a 20-foot length of cord. The push-button switch must be held or depressed for the period of exposure, while the double action switch—an automobile headlight beam control switch is ideal for this—may be operated by foot, leaving the hands free for operating fade, dissolve, or other effect devices. Where an extremely long cord is used, extra batteries may be required to compensate

still work occasionally may frequently run across superb lenses where only the plate covered will be engraved on the lens mount. The method outlined above for finding the focal length will be found useful for such calculation. The same formula may also be used to determine the stop numbers of a lens should they become obliterated. Dividing the known or marked focal length of the lens by the measured diameter of the largest stop will give the *f*/number of that stop directly. Application of the formula to the smaller stops in turn will enable one to calibrate the entire range of *f*/stops from start to finish.

for the added resistance of the wire.

To facilitate disconnection when it is desired to hold the camera by hand, a two wire connector is attached near the magnetic control. It is unnecessary to remove the gadget from the camera as manual control of the release button may be accomplished by pressing the armature button.

The principal of this gadget makes it adaptable to almost any cine camera. Such 16mm cameras as the Filmo and Victor—with

Exposure Meter Guide

CORRECTED MARCH 1, 1940

	SCHEINER		WESTON OR GE			SCHEINER		WESTON OR GE	
	Day	Mazda	Day	Mazda		Day	Mazda	Day	Mazda
AGFA									
16mm SSS Pan.....	29	27	100	64	GEVAERT				
16mm Hypan.....	24	23	32	24	Super Reversal.....	23	21	24	16
16mm Panchromatic.....	21	20	16	12	Panchro.....	20	18	12	8
16mm Supreme Pan, Neg.	27	25	64	40	Ortho.....	21	17	16	6
16mm Finopan Neg.....	23	21	24	16	GENERA				
16mm Positive.....	12	8	3	3	Meteorpan.....	23	21	24	16
16mm Plenachrome.....	20	18	12	8	Normal Panchromatic.....	20	18	12	8
8mm Twin-8 Hypan.....	23	21	24	20	Super Ortho.....	21	17	16	6
8mm Humipan.....	18	16	8	5	Movetone Ortho.....	19	13	10	3
					Semi-Ortho.....	18	12	8	2
DUPONT					KIN O LUX				
Reversal Pan.....	21	19	16	10	No. 1.....	16	6	6	..
Regular Pan Neg.....	20	18	12	8	No. 2.....	18	16	12	..
Superior Pan Neg.....	24	21	32	20	No. 3.....	26	24	50	40
Positive.....	12	..	2	1-6					
EASTMAN					PELLEX				
16mm Super XX Pan.....	100	64	Super.....	26	25	50	40
16mm Super X Pan.....	24	23	32	24	Pan.....	20	18	12	8
16mm Safety.....	20	18	12	8	Ortho.....	18	14	8	3
16mm Sound Pan.....	23	21	24	16	Super 8mm.....	25	24	40	32
16mm Pan, Negative.....	23	21	24	16	Ortho 8mm.....	17	12	6	2
16mm Positive.....	16	10	5	3	HOLLYWOOD				
8mm Super X Pan.....	23	21	24	16	S. S. Pan.....	26	25	50	40
8mm Regular Pan.....	18	16	8	5	Pan.....	21	20	16	12
Kodachrome (8 & 16mm).....	18	14*	8	3*	Semi-Ortho.....	18	12	8	2
Koda. "A" (8 & 16mm).....	18*	21	8*	12					

*With filter

USE PROFESSIONAL TITLES

WITH YOUR 8MM and 16MM FILMS
MADE IN THE MODERN LABORATORY OF

the Ciné Shop

—Literature is free—
1812 PIEDMONT • CHARLESTON, WEST VA.

NOTICE TO MOVIE FANS

If you take movies (8mm or 16mm) you simply cannot afford to be without a Free copy of the latest Photo Bargain Book now being distributed throughout the U. S. Lists all the best moving picture equipment from all the leading manufacturers, describes them. The prices save you money in many cases. You'll find the latest in lenses, screens, meters, projectors, cameras, film, titlers, editing outfits, tripods, books on editing, titling, etc. This Bargain Book is invaluable to you as an equipment REFERENCE book. Don't wait a day longer to send for your Free copy. Write us now.

Central Camera Company

Dept. E9
230 S. Wabash Chicago, Ill.

8mm—BULK FILM—16mm

Save Money!

LOAD YOUR OWN

Laboratory Packed Fresh Stocks Guaranteed
Non-Halation Weston 8 Fine Grain

400 ft. Straight 8mm (for Univex, Revere, Keystone, etc.).....\$3.25
800 ft. 8mm in double 8 widths for double 8 cameras.....5.00
400 ft. 16mm.....4.25

Spools—(Univex).....5 for \$1.00
Double 8.....each 35c
50 ft. 16mm.....each 35c
100 ft. 16mm.....each 50c

Postpaid (California Buyers Include Sales Tax)
PACIFIC COAST FILM COMPANY
1510 N. Sierra Bonita Hollywood, Calif.

The LEUDI CINEMETER

With scales specially fitted for all motion picture cameras. Frequencies of 8 to 128 frames per second, film speeds from 15° to 29° Scheiner.

- Optical type, automatic exposure meter.
- Feather-weight, measures 1"x1 1/2"x3/4".
- Jars and shocks do not affect it.
- Accurate and simple to operate.

With Bakelite Case.....**\$2.15**

MIMOSA AMERICAN CORP.
485 Fifth Avenue New York City

Absolutely FREE

HOME MOVIE TITLING KIT

Create Big Theatre Effects

The "TRY IT YOURSELF" KIT
Includes 36 Initials • 1 Alphabet
Numerals • Decorations • Tracing Paper • Background Board.
Complete Sample Title

"A TO Z" TITLING OUTFIT
• ONLY \$2.00 COMPLETE •
at Your Dealer or Send Direct to

STEIN STUDIOS
175 Fifth Avenue Dept. H13 New York, N. Y.

FINE MACHINE WORK

Turrets, Backwinds, Titlers, Lens Adaptations, 8mm Frame Enlargers, Focusers, Recorders, Sound Apparatus. Expert remodeling of cameras, lenses and projectors. Special Apparatus.

MacVAN MANUFACTURING CO.
3829 El Cajon Blvd. San Diego, Calif.
Courtesy to Dealers

Take Your MOVIES with



Cut Your Film Costs in Half

A FULLY GUARANTEED PRODUCT

It is easy to take GOOD PICTURES with

MOVIE MASTER CAMERA FILMS
FAST PROCESSING SERVICE

	100 ft.	50 ft.
Movie Master Ortho.....	\$2.50	\$1.50
18 Scheiners, Weston Daylight 8		
Movie Master Panthro.....	\$4.25	\$2.50
23 Scheiners, Weston Daylight 24, Tungsten 16		
Movie Master Colortone.....	\$6.00	\$3.00
A Colortone Process (Not Natural Color)		
18 Scheiner - Weston Daylight 8		

MOVIE MASTER FILM CO.
Ridgefield Park, N. J.

plunger or button type of motor release are particularly adapted to it. But those cameras with slide releases may also be made to operate just as easily and efficiently with this mag-

netic control. With the basic idea as presented here, almost any amateur will be able to build one of these gadgets to fit his camera regardless of make.

Backyard Movies...

• Continued from Page 214

the closeup of the boy saying—"That's my Pop!"

For the final surprise shot, Pop, with family plus a neighbor's child in car, is driving rather fast along the highway. Mother cautions him to slow down, but Pop, overconfident, says "I'll do the driving!"

Suddenly he crashes into a parked car as he wildly negotiates a turn in a street intersection. Make a close-up of dented fender of parked car. Then cut to medium shot of owner of car rushing madly into scene and engaging Pop in argument. By this time family get out of car and are standing about. A fight ensues between Pop and other man. Other man lands punch on Pop's nose, and Pop drops to ground. Follow this with closeup of Pop out, cold, on the pavement. Then cut to Son as he looks toward Pop with worried expression, then pointing toward him says, rather meekly, to neighbor lad—"That's my Pop."

Crash of cars can be faked by employing use of another car with fender or body already dented.

—Jose Prieta.

—Rocco Rotundo.

Odd Shot Reel

Often when we have loaded our camera ostensibly to shoot some particular subject, opportunity presents itself to film some unlooked for event—an accident, a fire, etc. Then, at the editing board, such shots are eventually deleted, coiled and laid aside because they do not fit into the continuity of the rest of the reel.

The shooting of such odd shots is never to be discouraged, for often an amateur has an opportunity to score a "beat" on newspaper or newsreel photographers in filming an unusual event. And for this reason, his camera should always be loaded with film and carried along on all trips, ready for just such opportunity.

But to make such random shots available for projection, it is suggested that early in the year a main title — "Events of 1940" — be prepared, so that such random shots may immediately be spliced to it. The formation of an interesting newsreel thus will be commenced which will in itself give incentive for increased filming of this kind.

Experimental Workshop...

• Continued from Page 237

lens is on the same axis as the pipe which extends through the block. To film a trick shot, set the camera in motion, locking the starting button in place. Then whirl the camera by turning the gadget crank.

A slow whirl filmed at 32 frames per second is especially good to indicate the dizzy effect of a punch-drunk fighter. (This is the gadget referred to in the scenario on page 245. Ed.)

Splicing Leaders

Users of bulk film who spool their own and encounter difficulty splicing on black or light-proof leaders will find this simple method will end their troubles. It eliminates necessity of scraping the emulsion. Instead, the leader is spliced to the film "back to back"—that is, glossy side to glossy side. All that is necessary is that both be held in perfect alignment during splicing.

Streamlined WELTINI SPEED CANDID

For Exquisite Natural Color Pictures

Tops in the 35mm. field. Fine color corrected lenses and high speed shutters stop the fastest action. Single view (color spot) range finder, coupled for automatic focusing. Ideal for natural color shots. Streamlined. Vibrationless.

Trigger Release

SOLAR

The PERFECT ENLARGER for "PRIZE WINNING" prints. Enlarges! Reduces! Copies! See the Solar before you buy. Sizes 35mm. to 5x7 inches. Prices from \$39.50 up. Descriptive Catalog No. HM 540 FREE.

BURKE & JAMES, Inc.
223 W. MADISON ST. CHICAGO, ILL.

What's the Shooting About?

IN ANY EVENT, BE SURE IT IS 16mm "PANORAM"

VAPORATE

- 100 ft. — 16mm (Semi-Ortho) Weston 8 . . . \$1.45
- 100 ft. — 16mm (Panchromatic) Weston 40 . . . \$2.50

Above prices do not include processing.

In addition to processing, this film will be treated with Vaporate, insuring better projection, longer film life, and permanent protection against climate, wear, scratches, oil, dirt, water, and fingermarks. For only 75c. Same day processing.

Complete line of 16mm equipment. Ask for quotation on any item you desire.

MINIATURE FILM SUPPLY CO.
130 West 46th Street New York City

16 M TITLES

Let FILMACK MAKE YOUR 16 mm TITLES And Announcements

We'll make your titles snappy, artistic, colorful . . . and put punch and showmanship in every foot.

PROFESSIONAL WORK

The same fine service FILMACK supplies to thousands of theatres.

Send Trial Order or Write for Free Catalog

SILENT or SOUND **FILMACK LABORATORIES**
847 So. Wabash Ave. Chicago

HOME TITLE LETTERS

The kind you see on the screen. Hollywood studios use them. Beautiful classic style metal letters and numerals. \$8.00 set for \$5.00—220 pieces, stars bars arrows, commas periods, ? \$.

3/4-in. caps, 3/8-in. lower case. White or black. Instructions for treating your title board with your order. No pins; move the letters anywhere. Circular sent on request. Price \$5.00 postpaid; extra letters 1c each.

CALIFORNIA LETTER SUPPLY
6205 Lexington Ave. Hollywood, Calif.

BETTER MOVIES WITH BLACK & WHITE FILM

Reversible Film 25 Ft. Double 8mm 98c Including Processing

Rating: Weston 12, Scheiner 18

At your dealer or direct. Fast service processing same day included at no additional cost.

• VISUAL INSTRUCTION SUPPLY CO.
1757 Broadway Box H9 Brooklyn, N. Y.

WATER

softened gelatin is easily damaged... it may melt... it may mildew.

VAPORATE

PEERLESS FILM TREATMENT

makes gelatin insoluble; it can't melt and it can't mildew.

AVOID eye straining punishment from SCRATCHES, SPOTS and STAINS. Looking at your pictures should be a pleasure for you and your friends.

Fraction-of-a-cent-per-foot-cost. • Nationwide facilities through your dealer.

Better Photo Finishers offer Vaporate protection for still negatives

VAPORATE CO., INC. 130 W. 46th St. New York

BELL & HOWELL CO. 1801 Larchmont Chicago 716 No. La Brea Hollywood

Your Own Metal Title Letters

Ask for Samples of the Most Beautiful Capital and Lower Case Letters Made

Tittle your films with **METAL Letters Professional EASY**

Complete Sets in Wood Case, 222 Pcs. . . . \$7.16
126 Caps Only . . . \$4.28

AN INTERESTING ADDITION TO YOUR MOVIE HOBBY

Specify White or Black Letters

KNIGHT & SON, INC. P. O. Box B, Seneca Falls, N. Y.

REG. \$38. 60-LESSON COURSE N. Y. Inst. Professional Motion Picture Operation and Projection, with charts and diagrams, special. . . . \$395

- Tripod, beaded screen (22x30), \$4.49; EXCEL, 16mm motor-driven, prof., \$3.49; Title for Key-stone, 16mm, \$3.75; MOGULL \$410 DUPLEX S-O-F Proj., complete, ready to run, \$289.50;
- Mogul-Lite foldable screen, 4'x6', \$5.99. 8-16mm Sound-Silent Library. Low rates. Film List and BARGAIN NEWS—FREE!
- Trades Accepted Monthly Terms

MOGULLS RADIO CITY 35 West 48th St. New York City

Kodachrome

MAPS • Charts • FINE TITLES

Geo. W. Colburn Laboratory
Special Motion Picture Printing
1197 Merchandise Mart, Chicago

DON'T WAIT!

Get Acquainted NOW with the

A B C

of Dependable 16mm Reversal Film

PEERLESS A—A reliable high-grade outdoor film. Moderately priced, yet superior in rendering high-quality results.

100 Feet Daylight Loading.....\$2.00
Weston 6, Scheiner 10

PEERLESS B—A non-halation base outdoor film. More highly sensitive than Peerless A, yielding excellent results.

100 Feet Daylight Loading.....\$2.75
Weston 12, Scheiner 18

PEERLESS C—A perfectly balanced panchromatic fine grain film for indoor or outdoor use. Thoroughly non-halation, producing brilliant pictures.

100 Feet Daylight Loading.....\$3.50
Weston 24-16, Scheiner 23-21

Above Prices Include Processing and Postage

Complete Professional Laboratory Service for the Amateur Movie Maker

All Prices Apply to Finished Film Per Foot
35mm Negative to 16mm Positive.....\$.83
35mm Positive to 16mm Positive......04
35mm Negative to 16mm Positive......025
16mm Positive to 16mm Positive......035
16mm Negative Developed......015
16mm Positive Developed......01

Minimum Charges on Any Above Order, \$1.00

16mm Panchromatic Reversal, 100 ft. or less.....\$1.00
16mm Reversal Orthochromatic, 100 ft. or less.....\$.75
FREE BOOKLET RS—Our specially low priced list of laboratory packed film.
Write for **BOOKLET FL**—Our complete list of 8mm and 16mm library subjects for sale or rent. Sound or silent.

PEERLESS CAMERA & FILM SERVICE

7-11 West 45th Street
NEW YORK CITY

11 River Drive
PASSAIC, N. J.

DO FILTER FACTORS FLOOR YOU?



HARRISON & HARRISON
Optical Engineers
8351 SANTA MONICA BLVD. HOLLYWOOD, CALIF.

8mm SLITTER

Slits perfectly 16mm width film to exact 8mm width. Die cast body with hardened steel cutting wheels. New price, each, \$2.50.

DEVELOPING RACKS

Stainless steel, take 30 feet 16mm or 8mm width film. Can be used in 11x14 or 8x10 flat trays respectively. Complete with loading stand, each, \$6.75. Specify type wanted.

At Your Dealer's or Direct

J. C. Haile & Sons

Motion Picture Dept.

215 Walnut Street Cincinnati, Ohio

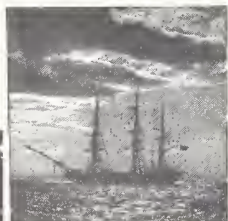

AMBERTINT makes clear fine quality **OUTDOOR** pictures

• Ample speed for outdoor filming.

16mm AMBERTINT

FOR OUTDOOR ACTION SHOTS—Fine grain, semi-ortho, large latitude. Amazing low price includes machine processing. Not sold at dealers and none made in 8mm or sold in bulk.....\$2.00
Calif. buyers includes sales tax 100-ft. roll

Write for Big Free Film Catalog

HOLLYWOODLAND STUDIOS
THE WEST'S GREATEST FILM MAIL ORDER HOUSE
SOUTHGATE, CALIFORNIA

You can make a splicing block for this purpose from a piece of wood and several small brads for alignment pins, or you may use your regular splicer. Simply trim ends of film in usual manner, making sure film lies on splicer with glossy side of leader facing glossy side of film. Apply touch of film cement and press the two together.

—Edw. H. Traten.

Floodlight

Here is an idea for a floodlighting unit. I took an old

suitcase and covered the entire inside except the cover with crinkled tinfoil. On the bottom I attached and wired two porcelain lamp sockets for photoflood lamps. Using No. 2 photofloods, this unit gives me adequate, even lighting for average indoor shots. The suitcase is easy to carry and easy to use, as it will stand erect when placed on table, chair or floor. The space inside is utilized for carrying the extension cords, switching blocks, etc., and sometimes my camera and film.

—Wilbur D. Lyon.

Information please...!

• Continued from Page 210

num powder as soon as taken off the press. The aluminum powder will adhere to the "wet" ink, producing a crisp, brilliant copy that will photograph perfectly.

Backgrounds (Robt. C. Herrick, Spokane, Wash.)

In making titles where the lettering is superimposed over a moving background, what kind of glass must one use for this? Does the glass have to be of large dimensions?

We presume you intend to project a moving background and for this purpose you should project it on a ground glass, the texture of which should be of the finest obtainable. Do not use flash-opal glass for this. The size of glass depends entirely upon the focusing range of your camera lens or titling equipment. If you are using one of the several typewriter titlers, then the ground glass should be cut to fit the title card holder. On the other hand, if your camera lens is capable of focusing sharply from 2 ft. and beyond, then the ground glass could be positioned ahead of the camera, say at a distance of 30", and would have to be large enough to fill the field at this distance—9" by 12".

Movie of the Month...

• Continued from Page 222

"From A to Z" presented hazards and difficulties not ordinarily encountered in shooting the ordinary outdoor epic consisting of scenery and people.

There were camera angles difficult to obtain because of the limitations of the pressrooms. Lights could not always be placed in the desired spots. And shooting could not interfere with the ordinary workaday routine of the printing establishment any more than absolutely necessary. Yet Altree got his shots, and his job of editing is an

excellent one. Scenes are kept to proper length and there is evidence of timing in every sequence. Scenes are well arranged and clarifying closeups are inserted frequently to clarify and strengthen the continuity of the picture.

The fact Altree used a Cine Special and Kodachrome film to produce his picture made no difference in our estimation. From the technique demonstrated in the production of "From A to Z" we are confident Altree could turn out an equally compelling picture using only a \$30 8mm camera.

NEW! GRAPHICROME Plus...

FREE \$1 FILM SLITTER

WITH EVERY ORDER FOR TWO 100-FT. ROLLS DBL. 8 MM. GRAPHICROME PLUS.

SINGLE 8 USERS, SLIT YOUR OWN... SAVE MONEY!

FILM

FASTER DAYLIGHT LOADING BULK MOVIE

SAVE 2/3. Buy in bulk, roll your own! Now this new faster film (Weston 12) costs little more than regular GRAPHICROME. Non-halation, Ortho. fine grain for sharp projection. Daylight loading leaders and trailers. Costs no more for processing.

Look at these LOW PRICES	Regular (Graphicrome (Weston 8))	Graphicrome PLUS (Weston 12)
100 ft. 8 mm. dbl. notched in four 25 ft. dbl. 8 rolls, with daylight loaders, trailers between ea. load	\$1.75	\$2.15
100 ft. 8 mm. dbl., without leaders	1.50	1.85
100 ft. 8mm. sgl., without leaders	1.00	1.10
30 ft. 8 mm. double, Camera ReFill	.50	.65
Same with daylight leader, trailer	.65	.75
400 ft. 16 mm. notched in 100 ft. lengths	4.00	4.65
100 ft. 16 mm.	1.15	1.30
Same with daylight leader, trailer	1.75	1.45

EVERY ITEM FULLY GUARANTEED

Order today direct from this ad. Or write for FREE circulars, processing rates, supplies, accessories, etc.

Superior Bulk Film Co., Dept. HM-5
188 W. Randolph St. Chicago, Illinois

AMERICA'S MOST VERSATILE SCREEN

Triple Duty Screen

- BRITELITE CRYSTAL BEADED SCREEN
- BLACK MASKING BORDER
- THREE POPULAR SIZES
- STURDY 6" STEEL TRIPOD
- CONVENIENT TO USE ANYWHERE
- SIMPLE IN OPERATION
- EXCEPTIONALLY LOW IN COST

SIZE	ONLY	*PRICE
30 x 40		\$10.00
40 x 40		12.00
36 x 48		13.50

*10% higher west of the Rockies

See Britelite Products at your dealer or write for illustrated catalogue. HM-3

BRITELITE
MOTION PICTURE SCREEN & ACCESSORIES CO., INC.
351 West 52nd Street, New York City

NOW! "EASY-TO-LOAD" GENERA MOVIE FILMS

WITH **BLACK ANTI-HALO COATING**

That **ELIMINATES** the Use of Spliced or Painted Leaders

The kind of film you have been waiting for. No more leaders to splice or paint. Simply fill empty spools. The Anti-halo coating automatically disappears in processing. The Double 8 Films are Scored in the Middle. Use these **FAST** high quality fine grain reversible Motion Picture Films at amazing low prices. Have great latitude and color correction. Send us your order today.

WESTON 12-16-24:	NORMAL SUPER SUPER		
	PAN.	ORTHO	PAN.
33 ft. Sgl. 8 on Univex Spool \$.79	\$.84	\$.89
100 ft. Single 8 on Univex, Etc.	1.90	1.95	2.10
25 ft. Double 8 on Spool	1.00	1.05	1.10
100 ft. Double 8 in Tin Can	3.25	3.30	3.45
100 ft. 16mm on Spool in Can	3.05	3.10	3.15
400 ft. 16mm in Film Can	11.75	11.80	11.85

Simplified Processing Outfits including our Prepared Powders: For 30 ft. Single 8, \$3.55, postpaid; Double 8 and 16, \$4.95, express. Simple instructions included. Stamp for Film sample, circulars and processing prices.

FROMADER GENERA COMPANY, Davenport, Iowa

GENUINE **KODACHROME** TITLES

HORNE MOTION PICTURE SERVICE
Producers of Industrial-Educational Films
9 EAST 40th STREET NEW YORK CITY

8mm SAVE ON FILM 16mm

Save \$\$ on Film. Take movies at cost of snapshots. Highest quality film giving full tone gradations—with super speed. Assures perfect picture results. Laboratory packing—Weston 10. **Not Positive Film.**

100 ft. Double 8mm (200' 8mm)	\$1.25
100 ft. 16mm with Daylight Leaders	\$1.25
100 ft. without daylight leaders	\$1.15
Processing extra - 100 ft. 16mm	.75
25 ft. double 8mm - 50c. 4 rolls 25 ft. double 8mm sent in at one time - \$1.50.	

ACCURATE CINEMA SERVICE
2609 Morse Ave. Dept. H4 Chicago, Ill.

16mm COLOR MOVIES

For Outright Sale

(Kodachrome Duplicates at 10c Per Foot)

- | | |
|-----------------------|--------------------------|
| EUROPE | WESTERN U. S. A. |
| Germany | Lake Tahoe |
| Switzerland | Yosemite National Park |
| Prag | Los Angeles |
| Budapest | Santa Barbara - Monterey |
| Vienna | San Francisco |
| Austria | San Francisco Fair—1939 |
| Italy | Giant Redwood Trees |
| Riviera | Glacier National Park |
| Luxembourg | Yellowstone Nat'l Park |
| France | Teton National Forest |
| BRITISH COLUMBIA | Rodeo at Worland, Wyo. |
| AND ALBERTA | Devils Tower |
| Lake Louise and Banff | Black Hills, S. D. |
| Victoria | |
| Vancouver Island | |
| Vancouver, B. C. | |

SEND FOR FULL DETAILS on these fine subjects. Many satisfied customers have reordered. Beautifully photographed—superbly edited. Every one a valuable addition to your library.

ZENITH CINEMA SERVICE
5011 N. SAWYER AVE. CHICAGO, ILL.
Fine Movies Since 1924

ORDER DIRECT SAVE MONEY
SUPERPAN

Brite Tone (Private Formula)
Processing Included, Dalite Load,
Panchromatic—Anti-Halo—Weston 24

100' 16mm \$3.37 25' Dble. 8mm \$1.40
No Better Film at Any Price

ORTHOTYPE Outdoor Films
Weston 8
Processing included by Brite Tone (private formula). Dalite Loading.

100' 16mm \$1.60 25' Dble. 8mm \$1.00

100' Bulk Dble. 8 or 16mm . . . \$1.10

PROCESSING 100' 60c
50' . . 45c 25' . . 40c 3-30' . . 50c

Single, Double 8 or 16mm. Any make or type of film. Reversal or negative. 8mm slit free. Send footage together to make 100' price. Spools, cans returned. Brite Tone (private formula) assures you 50 to 80% brighter, clearer pictures. Complete laboratory. Prints, copies 2c per ft. Min. \$1.00. All postage paid except C. O. D.

BRITE TONE MOVIE SUPPLY

Dept. E, 188 W. Randolph St., Chicago

Now FACTORY-TO-YOU PRICES!
ON MOVIE FILM

ESSCO FILM PRODUCTS now offers Quality Cine film for all cameras, AT FACTORY PRICES. Now you can get TWO rolls of film for what you formerly paid for one roll. Do not confuse this product with bulk film, as ESSCO FILM is a completely finished product. Each roll comes on Daylight Loading Spool in Metal Container and mailing carton. Prices on all films INCLUDE high grade laboratory processing. Service 24 hours in our laboratory. ESSCO FILM is supplied in three popular types: REGULAR is semi-ortho, speed Weston 8, ideal for all outdoor shots and titles. SUPER is guaranteed non-halation, wide latitude, ortho, Weston 12. PAN is extremely fast, fully Panchromatic, unusually fine grain, ideal for both indoor and outdoor use. . . . Weston 24 daylight, 16 mazda.

Look at These Low Prices:	Regular	Super	Pan
16mm, 100 ft.	\$1.79	\$2.19	\$3.69
16mm, 50 ft.	1.19	1.39	2.19
Dbl. 8mm, 25 ft.	.98	1.19	1.39

Processing and return postage included.
Order NOW for immediate delivery; 1/2 deposit required on C.O.D. orders. Minimum C.O.D. order, 2 rolls.
ESSCO FILM PRODUCTS
6117 South Campbell Ave. Dept. HM Chicago, Ill.

GLASS-BEADED
MOVIE SCREENS
Easily Made!

Make your own sparkling beaded screens—at a fraction of their usual cost! Crystal beads can be applied to cloth, cardboard or almost any smooth surface. Complete directions with each pound. (No fractions of pounds sold.)
FINEST SIZE \$1.25
D. GARD, C-3, 54 WEST 74TH ST., NEW YORK CITY

FILMS FOR RENT
16MM SOUND - 16MM SILENT - 8MM SILENT
Send for Free Gigantic Catalogue
Listing over 3500 subjects.
IDEAL PICTURES CORPORATION
28 East Eighth Street, Chicago
and
2402 West 7th Street, Los Angeles, Calif.

Why use anything else when
TITLES BY PARK CINE
cost no more than ordinary titles.
Catalog Free on Request
PARK CINE LABORATORY
120 West 41st Street New York City

With the "Pro-16's" . . .

• Continued from Page 216

sioned by Ideal Dog Foods, subsidiary of Wilson & Co., to shoot an ad film on their product. Starred will be every species of dog available, and of course Ideal Dog Food will play an important part in the story, tentatively titled, "Man's Best Food for Man's Best Friend."

Civic Film

Directors of the Memphis Amateur Movie Club report progress on their plans for production of another 16mm film for Memphis' Department of Public Safety which will show the prevailing causes of most traffic accidents with suggestions of what can be done to curb them. Plans also include dubbing in sound on the finished negative.

Last year this group produced two civic films which had wide circulation among schools, churches, clubs and civic groups.

8mm in Business

Interesting is the experi-

ment of Ruth Henry, San Diego, Calif., who is testing the practicability of producing and exhibiting business films in 8mm width. Encouraged by the success of her first ad-film production—a 300-foot 8mm black and white film delineating the processes of a San Diego laundry and cleaning establishment—he is proceeding with more pretentious plans for a film to be used in an advertising campaign soon to be launched by her sponsors.

Instructional Film

John O. Bessor, Jr., of Philadelphia, long experienced in producing 16mm business films, has developed a lecture covering scenario construction and use of script in film production. The lecture is augmented by a special instructional motion picture film and series of slides which are the product of Bessor. Both pictures and lecture are much in demand by various cine clubs and photographic groups throughout Pennsylvania.

Movie of the Month

• Each month the Editors of HOME MOVIES select the best picture sent in for analysis and designate it "The Movie of the Month." This movie is given a detailed review and a special leader is awarded the maker.

This award does not affect the eligibility of such films for entry in the annual HOME MOVIES CONTEST. They are automatically entered for rejudging with those films submitted especially for the annual contest. Films awarded the honor of MOVIE OF THE MONTH during past 12 months are:

1939

JUNE: "Alaska Cyclorama," produced by R. C. Denny, Fresno, Calif. 16mm picture approximately 800 ft. long.

JULY: "Behind the Dial," produced by Robert C. Orr, Mt. Kisco, N. Y. 16mm picture approximately 400 ft. long.

AUGUST: "New England Holiday," produced by Albert Watts, Buffalo, N. Y. 8mm Kodachrome picture, 800 ft.

SEPTEMBER: "Within the Garden Gates," produced by Murray Beliz, Sacramento, Calif. A 200-ft. 8mm Kodachrome film.

OCTOBER: "Hummingbirds," filmed by Richard L. Cassell, D.D. S., Los Angeles, Calif. A 16mm Kodachrome film, 400 ft. in length.

NOVEMBER: "Esquire's Escapade," produced by Clarence M. Aldrich, Long Beach, Calif. A 16mm picture 800 ft. in length.

DECEMBER: "Souvenir," produced by Harold E. Remier, Hollywood, Calif. A 100-ft. 8mm Kodachrome film.

1940

JANUARY: "The Cauldron," produced by Dr. R. E. Gerstenkorn, Beverly Hills, Calif. A 16mm picture 400 ft. in length.

FEBRUARY: "Whistling Wings," produced by W. H. Nordin, Austin, Minn. A 16mm Kodachrome picture, 400 ft. in length.

MARCH: "Checking Off the Budget," produced by B. W. Johnson. An 8mm Kodachrome film, 1000 feet in length.

APRIL: "El Lobo," produced by Demetris Emanuel. A 16mm picture, 400 feet in length.

MAY: "From A to Z," produced by Vernon Altree, Stockton, Calif. A 16mm Kodachrome film, 400 feet in length.

8mm "DATED" 16mm REVELATION

— MOVIE FILM —

SAVE on your movie film—make more pictures at less cost.

REVELATION No. 1 SEMI-ORTHO

Weston 12 Scheiner 20
A better grade outdoor film, non-halation, that provides wide latitude and softness of detail, takes sharp, clear, clean pictures of professional quality.
30 ft. single 8mm . . \$.75 each
25 ft. double 8mm . . 1.50 each
50 ft. 16mm 1.75 each
100 ft. 16mm 3.00 each

Two or More Rolls, 10% Discount

REVERSAL PROCESSING AND POSTAGE INCLUDED

C.O.D. Orders, Postage Extra—Remit 1/3 with C.O.D. Orders. Prompt, Reliable Service. California Buyers Include Tax

Pacific Coast Film Co.
1510 North Sierra Bonita
Hollywood, California
"Everything Photographic"

New! SPORTSMAN TRIPOD

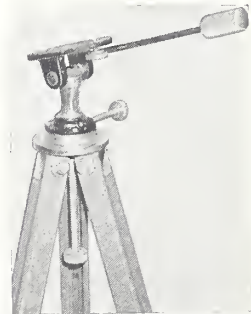

High in Quality!
Low in Price!

\$6.75

Complete with Pan-Tilt Head

A two-section wood tripod of sturdy construction—complete with tripod head, machined to give velvet-smooth panorama and tilting action for all movie and still cameras.

A REGULAR \$8.50 VALUE!
W. J. SEEMANN CO.
1010 1/2 So. Olive St. Los Angeles, Calif.

8MM ATTENTION 16MM 1c FOOT 1c
— BULK FILM —

		Double	8mm	16mm
100' No. 1 Pan Anti-Halo	Weston 24-16	\$3.50	\$3.50	
100' No. 2 Pan Anti-Halo	16-12	\$3.30	\$3.40	
100' No. 3 Ortho Anti-Halo	16-6	\$3.25	\$3.30	
100' No. 4 Ortho Anti-Halo	8-2	\$1.50	\$1.50	
100' No. 5 Ortho Plain	8-2	\$1.25	\$1.25	

All the above 16mm film is camera spooled. Write for prices on enlarging and reduction printing.

Developing 100 ft. 16mm, \$1.00; Double 8, 25 ft., 50c. We carry a complete line of all movie equipment. All orders prepaid except C. O. D.

MORRISON'S
43 PROVINCE ST. BOSTON, MASS.

Develop Your Movies With a
REISH MOTION PICTURE DEVELOPER
Easier than developing stills. Enjoy the thrill of developing your own movies. Many new and improved features. Write for complete circular.
Reish Motion Picture Co.
1232 Mishwaka Avenue South Bend, Ind.
Pioneers in Home Movie Developing Equipment

LEARN PHOTOGRAPHY
Thorough, practical training. For pleasure or career. All phases of photography. Commercial, News, Portrait, Advertising, Motion Picture, Color. Teaching staff of noted authorities. 30th year. Send for free booklet.
New York Institute of Photography
10 West 33 Street (Dept. 114) New York City

8mm "DATED" 16mm REVELATION

8mm — MOVIE FILM — 16mm
SAVE on your movie film—make more pictures of less cost.

REVELATION No. 2
PANCHROMATIC
Weston 50 Scheiner 26

A super-sensitive, non-holotian film—fine grain, extremely high speed. Clear, beautiful pictures, either indoors or out.

- 30 ft. single 8 mm . \$1.00 each
- 25 ft. double 8mm . 2.00 each
- 50 ft. 16mm 2.75 each
- 100 ft. 16mm 4.50 each

Two or More Rolls, 10% Discount

REVERSAL PROCESSING AND POSTAGE INCLUDED

C.O.D. Orders, Postage Extra—Remit 1/3 with C.O.D. Orders. Prompt, Reliable Service. California Buyers Include Tax

Pacific Coast Film Co.
1510 North Sierrita Bonita
Hollywood, California
"Everything Photographic"

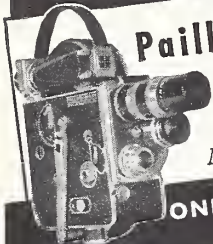

Paillard-BOLEX
on CREDIT
World's Finest
16mm and 8mm
Motion Picture Cameras
ONLY \$64.50 DOWN
12 Months to Pay

Enjoy the finest advantages of "professional" cameras—fades, superimposition, lap dissolves, animation, slow motion, etc. Get terms to suit you, as little as \$21.41 a month. BOLEX cameras are complete, there are no costly "extras" to buy. F/1.5 lens and carrying case. With Leitz Hektor Rapid F/1.4 lens, \$20.00 additional. Write for details to Dept. HM-4.

Trade In Your Old Camera—
Liberal Allowance

FORDHAM ELECTRIC CO., Inc.
2563 Webster Ave. New York City
(One-Half Block No. of Fordham Road)

GEVAERT FILM IN BULK
DOUBLE 8MM SCORED
AND 16MM

PANCHRO SUPER REVERSAL, ANTI-HALO			
16mm	Weston	100 Ft.	2 Rolls
Oouble 8	24-16	\$3.25	\$6.00
	24-16	\$3.50	
ORTHO REVERSAL, ANTI HALO			
16mm	16-6	\$2.80	\$5.25
Oouble 8	16-6	\$3.00	
CORONA SEMI-ORTHO — WESTON OAY — 8			
	Oouble 8 Scored or 16mm		
100 ft.	\$1.25	400 ft.	\$4.00

Films notched on request. Prices do not include processing. Write for special club offer.

REVERSAL PROCESSING — 16mm and 8mm
100 ft. . . \$.85 50 ft. . . \$.65 25 ft. . . \$.50
All Orders Shipped Postpaid Except C. O. D.

CORONA FILM LABORATORIES
200 East 34th Street Brooklyn, N. Y.

LEATHER CASES—Finest Cawhide
Everready Cases for Filmo 8—Keystone 8mm or Cine-Kodak 8. Postpaid. \$4.00
Everready Weston Meter Cases. \$1.25
NEW! LENS ADAPTER—Permits use of standard screw-mount super speed or telephoto lens in your Filmo 8. \$2.25, postpaid.

CAMERACRAFT DIVISION
Mail Order Only
1305 South Union Ave. Los Angeles, Calif.
Write for Complete Free Price Lists

CASH - CASH - CASH
FOR YOUR MOVIE EQUIPMENT
● We will pay you cash for your Movie and Still Cameras. Highest prices paid. Write us today, or send us your equipment today for our prompt liberal appraisal!

BROMFIELD CAMERA EXCHANGE
48 Bromfield Street Boston, Mass.

Title Troubles . . .

• Continued from Page 218

background, is exposed. If in exposing the backgrounds you will photograph them slightly out of focus, they will appear to blend more smoothly. The letters should be large, bold, block letters.

Q. I have been reversing my own titles (white letters on black) but now plan to develop them only to a negative (using black letters on white). I understand that the latter requires less exposure on the same positive film. Is this so? If so,

how much less, and why?—B. L. W., St. Louis, Mo.

A. Not knowing what reversing methods you use, it is hard to say if this is true or not in your particular case. As a general rule, however, it has been found that reversing slows down the film speed about 1 stop (using bichromate bleach), and even more with other bleaches. I would suggest you use one smaller stop on a test strip, then project it and judge for yourself if the exposure has been correct.

The Reader Speaks . . .

• Continued from Page 212

their vicinity. I will trade equal footage of historic Boston. I can send a booklet descriptive of Boston from which they may select the shots they desire.—John L. Anderson, 26 West St., Boston, Mass. Room 515.

Dear Sirs: I would appreciate your aid in assisting me to contact an 8mm filmer in Southern California—preferably San Diego vicinity. I have complete film of Niagara Falls, Ontario, and New York Fair to swap for the footage I desire. — Doug. Kutzbach, 116 Euclid Ave., Kenmore, New York.

Gentlemen: I will make up special title card designs (original drawings) with your own special copy and include a main title card, an over-all panel title background design, and an end title card in colors or black and white, in exchange for single reel 16mm comedies, novelties, and especially cartoons. If you have such films to swap, write to me, describing same and give idea of what you want in title cards. Titles will be your exclusive design and not duplicated for anyone else, and made to dimensions to fit your titler.—Edmund Turner, 12681 Monica, Detroit, Mich.

It's new to me . . .!

• Continued from Page 239

complete edition Castle Films, according to the sponsors of this association.

lic's increased use of Kodachrome film.

Added Service

With the increased facilities afforded by the recent enlargement of their Hollywood film developing and processing laboratories, Eastman Kodak Company announces that processing of 35mm Kodachrome film and mounting of transparencies will now be available from its Hollywood plant.

New Tripod Head

A new and vastly simplified type of tripod head has been announced by Western Movie Supply Company, of San Francisco.

The new head, called Wesco "All-In-Won," may be used for either still or motion picture work, and instead of separate adjustments, the Wesco All-In-Won may be locked for either vertical or horizontal framing, by a slight turn of the tilt arm.

Plant enlargement was made necessary by the pub-

GET RESULTS

16mm with Top Grade 8mm
CAMERA FILM

★ **CEL-O-TONE.** Weston 12, Scheiner 18. A remarkably fine outdoor film providing exceptional latitude and perfection of detail.

100 ft., 16mm . 2.50 25 ft., double 8mm . 1.35

★ **EXCEL PANCHRO.** Weston 50 (day), 40 (Tungsten); Scheiner 26 (day), 24 (Tungsten). A super-sensitive, anti-halo film of extremely high speed and fine grain. Beautiful results indoors or out.

100 ft., 16mm 4.75
25 ft., double 8mm 1.75



Excel MOVIE PRODUCTS
4230 DRUMMOND PLACE CHICAGO

\$2.00
100 feet
16mm

In keeping with our policy of bringing to the home movie maker a film of very high quality, we are reducing the price of ONYX 8 film to this NEW LOW PRICE. Daylight loading spools and processing free of charge. Send P. O. or Express Money Order for immediate service

KENWOOD FILMS
1231 East 46th Street
CHICAGO, ILL.



THE NEW "CRITIC" MODEL 40
\$18.75
Perfect exposures because of light acceptance angle of the "Louvre" construction.

DeJUR-AMSCO CORPORATION
SHELTON, CONNECTICUT



GIBBS FLOOD-GUNS
THE ONLY flood-light that follows the camera—models for either still or movie cameras.
ARTHUR E. GIBBS
1925 N. E. Knott St., Dept. H Portland, Oregon

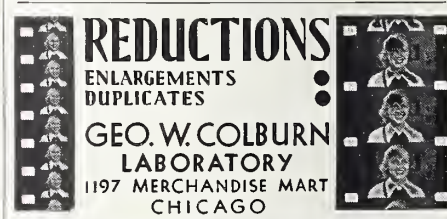

REDUCTIONS ENLARGEMENTS DUPLICATES
GEO. W. COLBURN LABORATORY
1197 MERCHANDISE MART CHICAGO

TITLES make the Picture
. . . and MITTENS PIN LETTERS make superb titles . . . clean-cut plastic letters in a variety of sizes and styles; also decorations.
Complete Sets from **\$5.50**
MITTENS LETTER CO.
Redlands, Calif.



TITLE Backgrounds

By EDMUND TURNER

IN the spring an amateur's fancy lightly turns to thoughts of good title backgrounds for spring filming—so here they are! There's a background for each of the months of March, April, and May. Then there's one titled simply "Spring." The "Picnic" background is another that will fit into currently filmed amateur movies.

Here's a suggestion that came to us recently from an amateur that may prove more practical for many than the suggestion given last month for a means of using open area backgrounds for more than one title.

Instead of cutting out the "open" area and placing the lettered title text in back of the opening, try typing or lettering the title text on a small square of clear cellophane. Place the cellophane over the title background. This will enable you to use the background indefinitely for one or more series of titles.

To type title on cellophane, use two sheets of carbon paper. Sandwich the sheet of cellophane between them, with the carbon-coated side of each against the cellophane. Remove typewriter ribbon and type directly on the carbon paper. This will produce an impression on both sides of the cellophane, making for a denser imprint.

By using tinted cellophane, you can add color to these backgrounds for Kodachrome. Still another color idea is to type on the cellophane with a colored ribbon—blue, brown, green, etc.

Amateurs who use typewriter titlers like the Kodatitler need not cut out these title backgrounds nor even remove the page from the magazine. Simply open magazine to title page, lay flat on table, and place titler vertically on end over the background to be photographed.

Two sets of individual title backgrounds—one for black and white and the other in colors for Kodachrome filming—are now available to amateurs from HOME MOVIES. Each set consists of 25 separate title cards and will be shipped prepaid on receipt of 50 cents per set. When ordering, be sure to specify either "Set No. 1" for black and white films, or "Set No. 2" for Kodachrome.

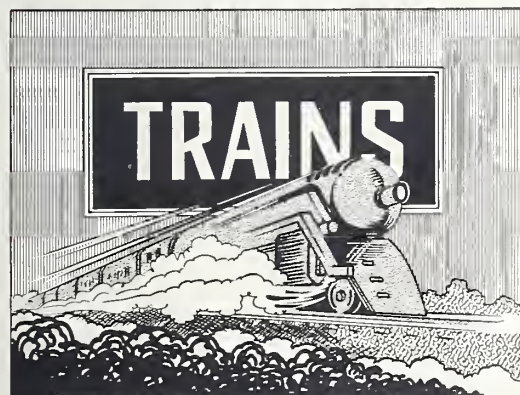
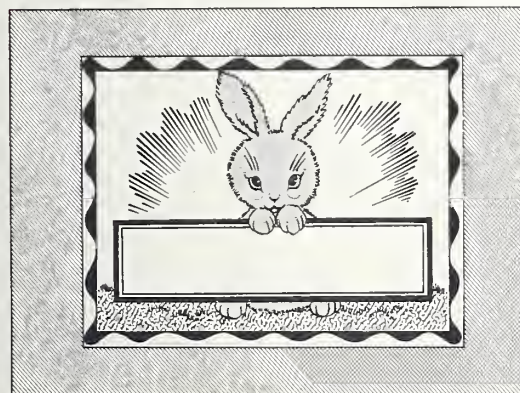
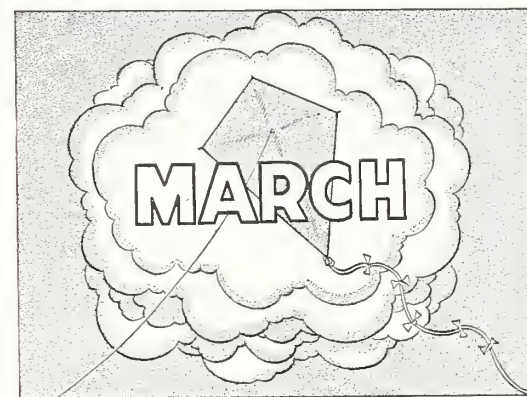
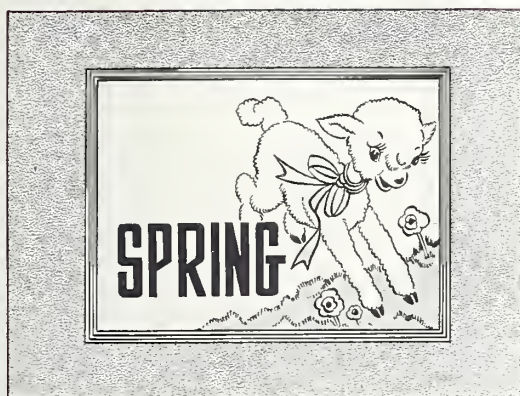

Directory Of Amateur Cine Clubs.

ARIZONA

TEMPE: Tempe Cine Club (8mm and 16mm) — Howard Lindly, Sec'y, 103 E. 5th St. Meet 2nd Wednesday.

CALIFORNIA

ALHAMBRA: La Casa Movie Club (8mm and 16mm) — H. P. Carnahan, Pres., 21 S. Garfield. Meet 3rd Monday each month.

AZUSA: Sunstik Movie Makers of the San Gabriel Valley (8mm and 16mm) — Elbert B. Griffith, Sec'y, 708 E. Bonita Ave. Meet 1st Monday each month.

BERKELEY: Berkeley Amateur Motion Picture Club — Dr. Kenneth Palmer, Sec'y, 90 Poplar St.

EL SEGUNDO: South Bay Camera Club — Heath L. Martz, Vice-Pres., 314 1/2 Virginia St.

FRESNO: Fresno Movie Makers — R. C. Denny, Sec'y, 750 Vassar Ave.

GLENDALE: Glendale Lens & Shutter Club (8mm and 16mm) — Howard Manning, Sec'y, 547 N. Brand Blvd. Meet 2nd Tuesday each month.

HANFORD: Kings Camera Club — G. Meldrum, Pres., 206 W. Grangeville Blvd.

HAYWARD: Hayward Cinema Club (8mm and 16mm) — Harvey Reed, Jr., Sec'y, 230 Pearce St. Meet 2nd and 4th Thursday.

HERMOSA BEACH: Amateur Movie Club of Hermosa Beach — Robert Balfour, Producer.

HIGHLAND PARK: Highland Park 8mm Club (8mm) — Howard Timmons, Sec'y, 4530 W. Avenue 41. Meet 2nd week of month.

LONG BEACH: Long Beach Cinema Club — Pat Rafferty, Sec'y, 916 Dawson Ave.

LOS ANGELES: Los Angeles 8mm Club — Leo Caloia, Sec'y, 143 West Avenue 28. Meet 2nd Tuesday each month.

Los Angeles 8mm Club (8mm) — Leo Caloia, Sec'y, 143 W. Avenue 28. Meet 2nd Tuesday each month.

Los Angeles 16mm Club — Wm. Hight, Sec'y, 361 N. Formosa Ave. Meet 1st Tuesday every month.

Southwest 8mm Club (8mm) — Mrs. W. B. Blanchard, Sec'y, 2127 Glendon Ave. Meet every 3rd Tuesday.

Southwest 8mm Club (8mm) — Mrs. W. B. Blanchard, Sec'y, 2127 Glendon Ave., W. Los Angeles.

LYNWOOD: Southern Cinema Club (8mm and 16mm) — Don Hunt, Sec'y. Meet 4th Tuesday each month.

MONTEREY: Peninsula Cine Club (8mm and 16mm) — H. H. Daugherty, Box 97, Pacific Grove. Meet 3rd Wednesday each month.

NORTH HOLLYWOOD: North Hollywood Cine Club (8mm and 16mm) — Ted Knight, Sec'y, 4873 Lankershim Blvd. Meet 1st Tuesday each month.

NORWALK: The Tri City Movie Club (8mm and 16mm) — Bert P. Teets, Sec'y, 804 Pine. Meet 1st and 3rd Wednesday of the month.

OAKLAND: Bay Empire 8mm Movie Club (8mm) — R. J. Shattock, Sec'y, 4132 Opal St. Meet 2nd and 4th Wednesday of month.

The Greater Oakland Motion Picture Club (8mm and 16mm) — B. F. Pratt, Sec'y, 2039 Shattuck Ave., Berkeley. Meet 2nd and 4th Monday each month.

PASADENA: Pasadena Movie Club — Gordon Plank, Sec'y, 2075 E. Orange Grove. Meet 3rd Wednesday of each month.

POMONA: Pomona Valley Club — T. J. Hebert, 155 S. Garey St.

RED BLUFF: Tehame County Movie Club (8mm and 16mm) — Hank Schaffer, Sec'y, 415 Madison St. Meet every 3rd Thursday of the month.

SACRAMENTO: Sacramento Movie Club (8mm and 16mm) — Wilfred Meacham, Sec'y, c/o Associated Oil Company. Meet 1st Thursday of month.

Sierra Camera Club (8mm and 16mm) — John Pardee, Sec'y, 1207 K St. Meet 2nd Tuesday and last Thursday.

SAN DIEGO: San Diego Cinema Club (8mm and 16mm) — G. E. Taylor, Sec'y, 4522 Utah. Meet 2nd and 4th Wednesday each month.

SAN FRANCISCO: Cinema Club of San Francisco (8mm and 16mm) — Edwin L. Sargeant, 1980 Washington St. Meet 3rd Tuesday each month.

Cinemachanics Club of San Francisco, 130 Taraval St.

Sherman Clay Movie Club (8mm and 16mm) — Mrs. C. E. Griffon, Sec'y, 1335 Washington. Meet 3rd Wednesday of each month.

Silver Screen Players of San Francisco (16mm) — Bette Byers, Sec'y, c/o Eric Mawson, 237 Wooley St.

SAN JOSE: San Jose Cine Club (16mm) — Frank T. Bondi, Sec'y, 1286 Vine St. Meet 1st Monday each month.

• Amateur movie makers interested in joining a cine club may make inquiry of the secretary of the club nearest their vicinity whose headquarters are given on this page.

If you are interested in forming a new cine club, HOME MOVIES will be glad to assist you. You are invited to write to the editors for free data that will be of assistance to you in organizing a club.

Listing of additional clubs will be made to this directory from time to

time as the data is received from club secretaries. Every amateur cine club in the United States, Canada, and Mexico is invited to participate. Clubs not as yet listed are requested to furnish the necessary information for listing.

Stars indicate clubs from whom club-produced films are available to other clubs on exchange basis on payment of transportation charges.

This directory is another of HOME MOVIES' exclusive services for the amateur movie maker.

SANTA ANA: Orange County 8mm Club (8mm) — Jack Kahler, Sec'y, 1512 Dresser St.

8-16 Movie Makers — Thelma Heath, 1028 Hickory St. Meet 1st and 3rd Thursdays.

STOCKTON: Port Stockton Cine Club (8mm and 16mm) — K. R. Oliver, Sec'y, 345 N. San Joaquin. Meets 2nd and last Thursday of each month.

Stockton Cine Club — Harold Liddicoat, Sec'y, 11 S. Hunter St.

COLORADO

DENVER: Bell Movie and Camera Club of Denver — H. M. Price, Box 960. Denver Cine 8mm Club — Preston Hopkins, Sec'y, 621 E. Colfax St. Meet 2nd Monday each month.

CONNECTICUT

BRIDGEPORT: Monogram Movie Club. BRISTOL: Bristol Cine Club — Earle H. Sparks, Pres., 20 Good St. Meet 2nd Thursday each month.

HARTFORD: Hartford Amateur 8mm Camera Club (8mm) — George McGauley, Sec'y, 1214 Main St. Nutmeg Film & Reel Club — J. Philip Earley, Sec'y, 138 Main St.

CONNECTICUT

MANCHESTER: Manchester Cinema Club — Mrs. Thos. Hooy, Sec'y. STAMFORD: Stamford Cine Club — R. Taylor, Sec'y, 65 South St. Meet 1st Monday and 3rd Wednesday.

TARRINGTON: Tarrington Cinema Club.

DISTRICT OF COLUMBIA

WASHINGTON: National Capital Cine Club (16mm) — Geo. D. Lane, 738 Numsey Bldg. Meet 2nd Thursday.

Washington Society of Cinematographers (8mm-16mm) — John T. Chedester, Sec'y. Meet 1st and 3rd Mondays.

Washington 8mm Club — Dr. I. Rodis, Sec'y, 1726 Eye St. Meet 2nd Wednesday each month.

FLORIDA

GAINESVILLE: Orange State Camera Club — Earl H. Jernigan, Pres., Box 587. Meet every other Tuesday.

JACKSONVILLE: Jacksonville Cinematographers — P. O. Box 56.

MIAMI: Miami Camera Club — Alfred Kahn, Sec'y, 1005 S. W. 19th Ave. Miami Movie Makers (8mm and 16mm) — Mrs. Paul Hockett, Sec'y, 1460 N. W. 38th St. Meet 1st and 3rd Monday each month.

TERRITORY OF HAWAII

HIILO: The Family Movies Club — P. O. Box 106.

HONOLULU: Honolulu Amateur Cinema Club (8mm and 16mm) — Richard G. Bailey, Sec'y, c/o Nuanu Y.M.C.A., Fort St. Meet 1st and 3rd Tuesday each month.

Honolulu 8mm Club (8mm) — Francis C. Williams, 4740 Farmer Rd.

GEORGIA

ATLANTA: Atlanta Movie Club (8mm and 16mm) — Douglas Cone, Sec'y, P. O. Box 74, Station C. Meet 1st and 3rd Friday each month.

THOMASTON: Thomaston Movie Club — (16mm and 8mm) — J. Lee Abernathy, Sec'y, 308 W. Main St. Meet every other Sunday.

IDAHO

BOISE: Boise Camera Club (8mm and 16mm) — Mabel M. Sturgis, Sec'y, 1505 N. 15th St. Meet 1st and 3rd Tuesday each month.

NAMPA: Nampa Movie Club (8mm and 16mm) — Art French, Sec'y, c/o Northwest Photo Shop. Meet 1st Monday.

ILLINOIS

BERWYN: Suburban Amateur Movie Club (8mm and 16mm) — John Triska, Sec'y, 2415 S. Highland Ave. Meet 1st and 3rd Monday each month.

CANTON: Canton Movie Camera Club (8mm and 16mm) — Lefe Drury, Sec'y, Main and Walnut. Meet 2nd and 4th Mondays.

CHICAGO: Chicago Cine Club (8mm and 16mm) — Lilly Thye, Sec'y, 314 S. Federal St. Meet every Thursday. Commonwealth Edison Camera Club — Arnold R. Hatch, 72 W. Adams St., Room 737.

Lane Tech Movie Club — A. P. Heffin, Sec'y, 2501 Addison St.

Metro Movie Club of River Park (8mm and 16mm) — J. W. Claywell, Sec'y, 5100 N. Francisco Ave. Meet every Wednesday night.

Shutter Snapper Club — Faith Church, Pine and Augusta.

South Side Cinema Club (8mm and 16mm) — Caroline Hetzner, Sec'y, 7321 Lawrence Ave. Meet 2nd and 4th Wednesday each month.

The Camera Adventurers' Club (8mm) — Mrs. Frank H. Crowe, Sec'y, 5916 N. Paulina.

Triangle Cinema League of Chicago (8mm and 16mm) — Leo Brooks, Sec'y, 1528 S. Harding Ave. Meet Sunday afternoons, once or twice a month.

Westlawn Cinema Club — Walter Sengstock, Sec'y, 1517 S. Kostner Ave.

EVANSTON: Northwestern Amateur Club. HOMEWOOD: 3H Camera Club, Movie Division — George Durand, Sec'y, 1750 Linden Rd.

OTTAWA: Ottawa Cine Club — C. F. Grover, Sec'y.

PEKIN: Pekin Cinema Club (8mm and 16mm) — Howard E. Miller, Sec'y, Box 262. Meet every other Monday night.

PEORIA: Peoria Cine Club, Inc. (8mm and 16mm) — Miss Lena R. Hoerr, Sec'y, 1102 Frye Ave. Meet every 3rd Tuesday.

ROCK ISLAND: Tri-City Cine Club (8mm and 16mm) — Albert N. Mueller, M.D., 550 26th St. Meet 4th Friday each month.

INDIANA

FORT WAYNE: Fort Wayne Amateur Cine Club (8mm and 16mm) — B. J. Olander, Sec'y, 2560 E. Brook Dr. Meet 2nd Monday each month.

HAMMOND: Calumet Movie Makers (8mm and 16mm) — Gladys Patrick, Sec'y, 5411 Price Pl. Meet every 3rd Monday.

INDIANAPOLIS: Indianapolis Amateur Movie Club (8mm and 16mm) — Alfred F. Kaufman, Sec'y, 4623 N. Arsenal Ave. Meet 1st and 3rd Wednesday each month.

Super-Art Productions of Indianapolis — W. Stuart Bussey, 17 E. St. Joseph St. Public Service Company Camera Club — James Genders, Sec'y, 4935 W. 11th St. VINCENNES: Vincennes Camera Club (8mm and 16mm) — Robert M. Johnson. Meet 1st Thursday.

IOWA

DES MOINES: Y. M. C. A. Movie and Camera Club of Des Moines (8mm and 16mm) — Mary H. Platt, Sec'y, 3223 2nd St.

SIoux CITY: Amateur Cinema Club (8mm and 16mm) — Don Goodwin, Sec'y, 3733 Seventh Ave. Meet 3rd Tuesday each month at Hunt School.

KANSAS

PRATT: Camera Club — 16mm and 8mm — Benjamin F. Henry, First Presbyterian Church.

MASSACHUSETTS

ATTLEBORO: Attleboro Movie Club — Francis J. O'Neil, 37 Pleasant St.

BOSTON: Boston Cineamateur Club (8mm and 16mm) — Fannie Tinkham, Sec'y, Cambridge Photographic Society, 631 Massachusetts Ave. Meet 2nd and 4th Mondays.

LOWELL: Lowell Amateur Cinema Club — Leslie R. Lawson, Sec'y, 311 Westford St.

PITTSFIELD: Berkshire Museum Camera Club (8mm and 16mm) — A. C. Hindle, Sec'y, 19 North St. Meet 2nd Wednesday each month.

SOUTHBRIDGE: Southbridge Amateur Movie Makers Club (8mm and 16mm) — Joseph A. Giroux, Sec'y, 85 Everett St. Meet 2nd Friday each month.

MICHIGAN

BATTLE CREEK: Photographic Society of Battle Creek (8mm and 16mm) — Neil E. Elliott, Sec'y, 215 Fairfield Ave.

DETROIT: Detroit Society of Cinematographers (8mm and 16mm) — James A. Harris, Sec'y, c/o McGregor Library. Meet 4th Monday.

FOND DU LAC: Fond du Lac Camera Club (8mm and 16mm) — Miss Mildred E. Weber, Sec'y, 333 S. Marr St. Meet 4th Monday each month.

FLINT: Flint Amateur Movie Club — Lynn J. DePree, 2006 Mountain Ave. Meet 1st Wednesday each month.

JACKSON: Jackson Amateur 8mm Camera Club (8mm) — Lila O. Redinger, Sec'y, 1040 S. Jackson St. Meet 3rd Friday each month.

KALAMAZOO: Kalamazoo 8mm. Cinematographers — (8mm) — Grant Kinch, Pres., 806 S. Park. Meet 1st and 3rd Thursdays.

LANSING: Capitol Camera Club (8mm and 16mm) — R. B. Gould, Sec'y, 1414 Corbett St. Meet 2nd Monday each month.

LAPEER: Lapeer Cinema Club (8mm and 16mm) — Peter Skeberdis, Sec'y, 1665 Imlay City Rd. Meet 3rd Tuesday of each month.

PONTIAC: Pontiac Amateur Cinematographers (8mm and 16mm) — Welton J. Jones, 583 E. Tennyson. Meet 1st Monday each month.

SAGINAW: The Saginaw Movie Club (8mm and 16mm) — Clarence R. Kreuger, Sec'y, P. O. Box 671. Meet every other Thursday.

MINNESOTA

AUSTIN: Austin Camera Club (8mm and 16mm) — Lon Enochson, Sec'y, 205 N. 2nd St. Meet 2nd Tuesday each month.

HOPKINS: Suburban Cine Club (8mm and 16mm) — J. M. Devoy, Sec'y, 309 Blake Rd. Meet last Thursday.

MINNEAPOLIS: Minneapolis Octo-Cine Guild (8mm) — C. G. Crosby, Sec'y, 5617 12th Avenue S. Meet last Thursday each month.

Minneapolis Cine Club (8mm and 16mm) — Dr. Reinhold Ericson, Sec'y, c/o R. A. Riebeth, P. O. Box 22, Commerce Station, Minneapolis.

ST. PAUL: Gonher Movie Club (8mm and 16mm) — Mrs. L. T. Thiets, Sec'y, 580 Wentworth. Meet last Friday each month.

St. Paul Amateur Movie Makers (8mm and 16mm) — Walter Gayman, Sec'y, 314 W. Kellogg Blvd. Meet 1st and 3rd Tuesday each month.

Metropolitan Cine Club (8mm and 16mm) — T. C. Hotchkiss, Sec'y, 303 S. Cleveland Ave. Meet 1st and 3rd Wednesdays.

MISSOURI

KANSAS CITY: The Heart of America Movie Club (8mm and 16mm) — Cooper Jenkins, Sec'y, 616 W. 26th St. Meet 1st Monday of each month.

Kansas City Cine Club (8mm and 16mm) — E. P. Witte, Sec'y, 3125 Broadway. Meet 2nd and 4th Wednesday each month.

ST. JOSEPH: St. Joseph Amateur Movie Camera Club (8mm and 16mm) — Ruthanna Beard, Sec'y, 610 E. Missouri Ave. Meet 2nd and 4th Wednesdays.

ST. LOUIS: Amateur Motion Picture Club of St. Louis (8mm and 16mm) — Miss Eloise Koch, Sec'y, 2738 Accomac St. Meet 2nd Wednesday each month.

* St. Louis Amateur Movie Club — J. B. Barger, Pres., Suite 815, University Club Bldg.

MONTANA

BILLINGS: Billings Movie Club — Louis M. Moos, Sec'y, 311 Wyoming.

NEW JERSEY

BAYONNE: Bayonne Cine Club (8mm and 16mm) — E. Robert Gross, 298 Ave. B. Meet 1st Friday.

EAST ORANGE: Cinema Club of the Oranges (8mm and 16mm) — Herbert A. Smith, Sec'y, 541 Main St. Meet 3rd Friday.

MILLBURN: Gibraltar 8mm Club (8mm) — M. H. Sanders, 85 Greenwood Dr.

NEW CLUB FORMING

• 8mm and 16mm cinefilmmers residing in the southwestern Los Angeles area and who are interested in becoming members of a new Amateur Cine Club are requested to communicate with Hugh M. Foster, 4318 Crenshaw Boulevard, of that city.

MAPLE SHADE: The Wedgewood-Draper Club (8mm) — William Hoover, Sec'y. Meet 2nd and 4th Wednesdays.

MAPLEWOOD: Maplewood Amateur Movie Club (8mm and 16mm) — Mrs. Fred W. Miller, Sec'y, 13 Rynda Rd.

NUTLEY: ★ Cinemas Club of North Essex (8mm and 16mm) — J. E. Nestell, Sec'y, 18 Shepard Pl. Meet 3rd Thursday each month.

PASSAIC: Passaic Y. M. C. A. Cinema Club.

TRENTON: Trenton Movie Makers (8mm and 16mm) — Jules Y. Shein, Sec'y, 521 S. Warren St. Meet either 1st or 2nd Friday each month.

NEW YORK

BINGHAMTON: Cinema Club of The Triple Cities — Edwin Moody, Sec'y.

BRONX: Bronx Amateur Cinema Club (8mm and 16mm) — Nicholas H. Zella, Sec'y, 384 E. 193rd St.

BROOKLYN: Brooklyn Amateur Cine Club — Irving Pollock, Pres., 91-01 64th Rd., Rego Park, L. I. Meet every two weeks.

BUFFALO: Amateur Cinema Club of Buffalo — Edward C. Denny, Sec'y, 38 La Salle Ave.

Niagara Cinema League (8mm and 16mm) — K. N. Hadley, Sec'y, 103 Villa Ave. Meet 3rd Wednesday each month.

ELMIRA: Y. M. C. A. Movie Club (8mm and 16mm) — H. M. Shinn, Jr., Sec'y, Y. M. C. A. Meet 1st Monday each month.

JOHNSON CITY: I. B. M. Cinematographer's Club — W. M. Muir, Pres., R. D. No. 2.

LONG ISLAND: Queens Cine Club (8mm and 16mm) — Jack Jacoby, 103-17 125th St., Richmond Hills, L. I.

MOUNT KISCO: Mount Kisco Cinemats (16mm) — Robert F. Gowen, Sec'y, Chilmark Park, Assinng, N. Y. Meets 1st Monday of each month.

MOUNT VERNON: Mount Vernon Movie Makers (8mm and 16mm) — N. W. Knight, Sec'y, 258 Westchester Ave. Meet 3rd Tuesday.

NEWBURGH: Newburgh Amateur Cinema Club (8mm and 16mm) — Robert S. Kelly, Sec'y, 217 North St. Meet 2nd Thursday each month.

NEW YORK CITY: Metropolitan Motion Picture Club, Inc. (8mm and 16mm) — Robert M. Coles, Sec'y, 35 E. 20th St. Meet 2nd Tuesday each month.

New York City 8mm Motion Picture Club — Walter C. Mills, 35 Park View Rd., Bronxville. Meet 3rd Monday.

Telephone Camera Club of Manhattan — Thos. G. Herendeen, Room 1958, 195 Broadway.

PEEKSKILL: Peekskill Sport Center, Inc. — 830 South St.

ROCHESTER: Rochester Amateur Movie Club (8mm and 16mm) — Raymond H. Jacobs, Sec'y, Y. M. C. A., 100 Gibbs St. Meet 1st and 3rd Thursdays each month.

ROCKVILLE CENTER, LONG ISLAND: Rockville Amateur Cinema Club.

SCHENECTADY: Schenectady Photographic Society, Cine Group (8mm and 16mm) — H. M. Webber, Sec'y, 1279 Dean St. Meet 1st Wednesday of each month.

STATEN ISLAND: Staten Island Cinema Club (8mm and 16mm) — Frank E. Gunnell, Sec'y, 34 Colonial Court, West New Brighton. Meet 2nd Tuesday each month.

Staten Island Movie Makers (8mm and 16mm) — Harry S. Wilson, Sec'y, 34 Rokeby Pl.

SYRACUSE: Syracuse Amateur Movie Makers (8mm and 16mm) — Benjamin Franklin, Sec'y, 221 Marguerite Ave. Meet every other Monday.

VALLEY STREAM, LONG ISLAND: Valley Stream Camera Club (8mm and 16mm) — John H. Trunk, Sec'y, 152 Locust Blvd. Meet 1st and 3rd Wednesday each month.

NORTH CAROLINA

MORGANTON: Morganton Camera Club, Movie Division — Edw. M. Hairfield, Jr., Sec'y, Box 793.

NOVA SCOTIA

HALIFAX: Halifax Cinema Club.

OHIO

AKRON: Buckeye Camera Guild (8mm and 16mm) — E. R. Evans, Sec'y, 615 Metropolitan Bldg. Meet every other Monday night.

CLEVELAND: Aremac Club (8mm and 16mm) — L. C. Neuffer, Pres., Box 1719. Meet every 3rd Tuesday.

Cleveland Amateur Cinematographers (8mm and 16mm) — Miss Dorothy Boetticher, Sec'y, 1394 W. 3rd St., c/o Strong, Carliss & Hammond Co. Meet 1st and 3rd Wednesdays each month in Hotel Carter.

COLUMBUS: Columbus Movie Makers — Arthur Robinson, Sec'y, 34 N. 3rd St.

DAYTON: Cinema Research Club — F. H. Bickford, Jr., Chairman, 1529 S. Broadway.

Dayton Cinema League — P. C. Beach, Sec'y, 2240 E. 5th St.

FINDLAY: Findlay Camera Club — Ralph L. Stears, Sec'y, 208 Lark St.

GALION: Galion Camera Club (8mm and 16mm) — Mary Postance, Sec'y, 377 N. Market St. Meet 1st and 3rd Tuesdays each month.

HAMILTON: The Movie Makers Club — Clinton W. Bergen, Pres., 1269 Harmon Ave.

MANSFIELD: Mansfield Movie Club — Dr. L. B. McCullough, 78 Park Ave. W.

MOUNT VERNON: Mount Vernon Camera Club (8mm and 16mm) — Frank J. Van Vorhis, Sec'y, 306 N. Main St. Meet 1st and 3rd Tuesdays each month.

NORTH CANTON: North Canton Cinema Club (8mm and 16mm) — R. L. Wearstler, Sec'y, R. D. 6, E. Maple St. Ext. Meet 1st Friday each month.

SPRINGFIELD: Springfield Cinema Club — C. O. Harrison, Sec'y.

TOLEDO: Toledo Cine Club — Mr. Harry Howland, Sec'y, P. O. Box 23. Meets 2nd and 4th Mondays.

NEWARK: YMCA Movie Makers (8mm and 16mm) — C. I. Grimm, Pres., Arcade Annex. Meet 1st and 3rd Wednesdays.

WOOSTER: Wooster Amateur Movie Makers (8mm and 16mm) — Howard W. Keister, Sec'y, 218 W. University St. Meet 3rd Monday each month.

YOUNGSTOWN: Youngstown Amateur Movie Club (8mm and 16mm) — Fred Deiter, Sec'y, 52 Wesley Ave. Meet 1st and 3rd Mondays.

OKLAHOMA

NAWATA: Nawata Cine Club — Audrey Albin, Sec'y, 514 N. Pine.

OKLAHOMA CITY: Cinematear Club (8mm and 16mm) — H. P. Douglass, Sec'y, 1909 N. W. 27th. Meet 3rd Friday each month.

Oklahoma City Movie Club — Alex McDonald, Pres., 721 N. W. 29th St.

TULSA: Tulsa Am-Mo Club — J. B. Close, Pres., Box 854. Meet 1st and 3rd Wednesdays.

OREGON

MEDFORD: Medford Movie Club (16mm) — Mrs. George F. Tucker, Sec'y, 37 Kenwood Ave. Meet 3rd Saturday.

Southern Oregon Cinema Club — W. Bernard Roberts, Pres., 922 Reddy Ave.

PORTLAND: Portland Cine Club, Inc. — Arthur E. Gibbs, Sec'y, 324 S. W. Stark St. Meet every two weeks.

PENNSYLVANIA

ALLENTOWN: Allentown Y. M. C. A. Cinema Club — Aral M. Hollenbach, Sec'y, 1229 N. 19th St.

LEBANON: Lebanon Valley Camera Club, Movie Division — W. C. Graeff, Sec'y, 20 S. 8th St.

NORRISTOWN: Mrs. Mary Leanord, Sec'y (8mm and 16mm), 618 De Kalb St. Meet every 3rd Monday.

PHILADELPHIA: ★ The 8-16 Movie Club — Louis Sobel, Sec'y, 4916 Ormes St. Philadelphia Cinema Club (8mm and 16mm) — George A. Pittman, Sec'y, 1308 E. Tulpehocken St. Meet 2nd Tuesday each month.

PITTSBURGH: Pittsburgh Amateur Cinema Club (8mm and 16mm) — Miss Rose Goldman, Sec'y, 319 Amber St. Meet 1st and 3rd Wednesday each month.

POTTSTOWN: Pottstown 8mm Movie Club (8mm) — Wm. J. Weiss, Sec'y, 874 N. Charlotte St. Meet 1st Tuesday each month.

READING: Berks Camera Club (8mm and 16mm) — Stephen Lawrence, 310 N. 12th St. Meet every Monday night.

SUNBURY: Sunbury Amateur Cinema Club (8mm and 16mm) — David Lenker, Sec'y, 346 Chestnut St. Meet 1st and 3rd Mondays.

SOUTH DAKOTA

SIoux FALLS: Sioux Falls Amateur Cine Club — (16mm and 8mm) — H. E. Hanson Harold's, 308 S. Phillips Ave. Meet 1st Monday each month.

YANKTON: Yankton Camera Club. Arthur J. Smith, Pres., 414 Capitol St.

TENNESSEE

MEMPHIS: W. G. Snowden, Sec'y Box 2073, DeSoto Sta.

TEXAS

DALLAS: Dallas Cine Club — Stan Everman, Pres., 1504 Young St.

UTAH

LOGAN: Logan Amateur Cinema Club (8mm and 16mm) — Mrs. E. L. Hansen, Sec'y, Logan, Utah.

SALT LAKE CITY: Utah Amateur Movie Club (8mm and 16mm) — C. F. Solomon, Jr., Sec'y, 1471 Browning Ave. Meet 2nd Monday of each month.

VIRGINIA

LYNCHBURG: Hill City 8 Movie Club (8mm) — Nowlin Puckett, Corresponding Sec'y, 822 Floyd St. Meet once a month.

NORFOLK: Norfolk Amateur Movie Club (8mm and 16mm) — Claude D. McMillan, Jr., Sec'y, 720 Carolina Ave. Meets 3rd Tuesday.

These Books will tell you how...!

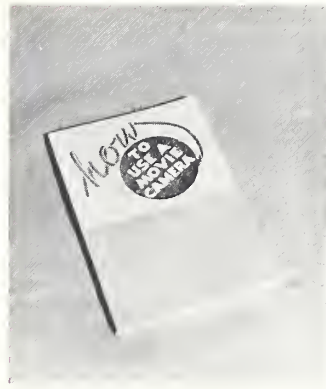

A new handbook for the beginner. Takes up where your camera instruction book leaves off. Contains essential data on fundamentals of making good home movies, boiled down in one small, easy-to-read volume. Makes clear in easy-to-understand terms the use of lenses, threading of camera, setting exposure, correct focusing, etc., and points out mistakes to avoid that will save many dollars in wasted film. Per copy **50c**

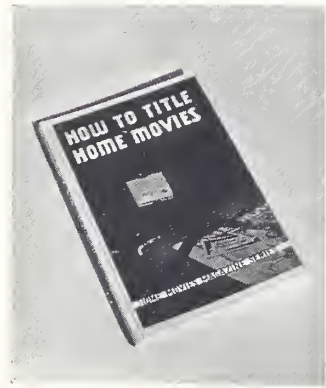

The latest, most complete book on titling home movies which includes, in addition to complete plans for building the renowned Home Movies Titler, such data as Title Area Chart, Lighting Chart, Diopter Lens Chart, How to Make Trick Titles, Data on Use of Shims for ultra-closeups, etc. There's approximately 100 pages jam packed with vital information for every amateur movie maker. Price per copy **\$1.00**



The leading textbook for the amateur on the subject of reversing home movie film. Over 5000 copies sold to date! Illustrates and describes how to build home processing equipment; gives all the popular reversal formulas; and tells how to intensify or reduce over- or under-developed films. Get this book today and start processing your own films for greater economy and pleasure in home movie making. Per copy **50c**

If your dealer cannot supply you with any of the above books, send your order, together with check or money order, direct to us and same will receive immediate attention.

VER HALEN PUBLICATIONS

6060 Sunset Boulevard

Hollywood, Calif.

• Continued on Next Page

CLASSIFIED • ADVERTISING

EQUIPMENT FOR SALE

● **BASS SAYS:** Get ready for summer shooting with May bargains.

USED CAMERAS
 Keystone Model B 16mm, f/3.5 lens, \$17.50.
 Keystone Model A-3 16mm, f/3.5 lens, \$19.50.
 Agfa Ansco Cine 16mm, slow motion, f/3.5 lens, \$24.50.
 Cine Kodak Model B, f/3.5 lens, \$24.50.
 Simplex Pockette Magazine, f/3.5 lens, \$25.00.
 Filmo 75, f/3.5 lens, \$34.50.
 Cine Kodak Model B, Kodak f/1.9 lens, \$44.50.
 Simplex Pockette with Kodak Anastigmat, f/1.9, focusing mount, \$60.00.
 Super Speed Filmo 70, Wollensak f/1.5 lens, case, \$85.00.
 Filmo 70-D, 1" Cooke f/3.5, 1" Wollensak f/1.5, 2" Tessar f/2.7, carrying case, \$174.50.

USED PROJECTORS
 Kodascope Model A, 200 watt, \$22.50.
 Keystone A-81, 750 watt, \$45.00.
 Ampro Model KD, 750 watt, case, \$82.50.
 Bell & Howell Model SU, 750 watt, variable resistance, with case, \$87.50.

USED SOUND ON FILM PROJECTOR
 RCA Victor, 500 watt, \$135.00.
 New Polaroid Fade-O-Scope, fits most cameras, highly efficient, \$18.75.
 New Bool Four-Way Fader, spring driven, complete, fits most cameras, \$17.50.

UP-TO-THE-MINUTE TEXTBOOKS
 American Cinematographer Handbook and Reference Guide, invaluable, special at 97c postpaid.
 Trick Effects with the Cine Camera, \$1.00 postpaid.
 Home Processing, includes all necessary information, by Harris, \$2.00 postpaid.
 Be sure to get your copy of our great 66-page Cine Catalog No. 240. It is free. Also a 72-page Still Camera Catalog No. 242.

BASS CAMERA COMPANY
 Dept. HC 179 W. Madison St., Chicago, Ill.

● Ten cents per word; minimum charge, \$2.00 cash with order. Closing date, tenth of preceding month. ● **HOME MOVIES** does not guarantee goods advertised. ● Send ads to 6060 Sunset Boulevard, Hollywood, California.

FILM RELEASES (8 and 16mm)

● **8-16MM FILMS.** Latest releases. "All subjects," silent and sound. Films rented everywhere. Tremendous savings on silent and sound equipment. Trades accepted. Good sound odd reels as low as \$3.00 per reel. Silent and sound reels exchanged, \$1.00 per reel. Free illustrated catalog (with sample Art film, 10c). **GARDEN FILM SERVICE**, 317 West 50th St., New York City.

● "THE LIFE OF SEABISCUIT." Action, thrills, suspense. 2 reels all in 16mm sound. Send for our list of sensational pictures never before offered for sale. **HOLLYWOOD PRODUCERS**, 845 No. Seward St., Hollywood, Calif.

● **SILENT FILMS EXCHANGED**, bought, sold, rented; plenty bargains. Send for free lists now. **FRANK LANE**, 5 Little Bldg., Boston, Mass.

● **SEND FOR** our large lists, brand new films, lowest prices. Exchange rates: 25c per 50 ft.; 50c per 100 ft.; \$1.00 per 200 ft. **THE ABBE FILMS**, 1265 Broadway, New York, N. Y.

● **FOR SALE** — Private Library of Sound Films and equipment. Bargain. Almost new. Write for list. Write P.O. Box 821, Wilmington, Del.

● **REAL "ART"** film. Send 10c today for generous prepaid sample or get free fully descriptive catalog. **CINEART**, 2443-B Gunnison, Chicago.

● **8MM-16MM** Movie equipment, bargains. Art sample, 10c. List free! Write wants to **EDCO**, 199 West Broadway, Paterson, N. J.

● **FREE FILM RENTAL Catalogs**, 16mm-8mm, silent and sound. Largest selection in U. S. A. **NATIONAL CINEMA SERVICE**, 71 Dey St., New York City.

● **CASTLE FILMS** Library. All latest releases for sale. 8mm, 16mm, Silent, Sound. Free catalog. **RIEDEL FILMS**, 2221 W. 67th St., Cleveland, Ohio.

EQUIPMENT FOR SALE

Filmo 75 with f/3.5 lens, \$32.50.
 Ensign Camera, f/2.6 Lens, \$35.00.
 Filmo 70A f/3.5, Cooke Lens, \$25.00.
 Filmo 70A f/3.5, Cooke Lens, \$29.50.
 Filmo Super Speed, No Lens, \$20.00.
 Keystone A7, f/2.7 Lens, \$29.50.
 Filmo 70 DA 1" f/2.7 Tessar, 2" f/3.5 Cinor, 3" f/3.5 Cinor, \$170.00.
 Filmo 141, f/2.7 Lens, \$80.00.
 Filmo 121, f/2.7 Lens, \$42.50.
 Simplex CC, f/2.8 Lens, \$29.50.
 Simplex CC, f/1.9 Lens, \$49.50.
 Filmo Projector 57A, 200 Watt, \$27.50.
 Filmo Projector 57A, 200 Watt, \$32.50.
 Filmo Projector 57A, 250 Watt, \$37.50.
 Filmo Projector Model S, 500 Watt, \$79.50.
 Keystone A 81, 750 Watt, \$48.50.
 Keystone A 74, 300 Watt, \$27.50.
 Kodascope E, 500 Watt, \$40.00.
 Kodascope EE, 750 Watt, \$45.00.
 Ampro J, 500 Watt, \$62.50.
 Keystone L 8, 500 Watt, \$58.50.
 Keystone J 8, 300 Watt, \$23.50.

ACCESSORIES

● **MOVIE MAKERS:** Process your titles and reversal film. Equipment, chemicals, instructions — 50' capacity double 8 or 16 — \$2.95 express. **ROYCRAFT CO.**, Box 1810, Milwaukee, Wis.

● **SAVE! CATALOG!** Bargains galore! News Bulletins! New Accessories items! New "Arts" Line! Fast Service! Send Postal! **PENN-CRAFT**, 423, Williamsport, Pennsylvania.

● **SCREEN YOUR Snapshots!** Miniature glass slides made from any size negative, print, map, diagram, or movie frame. 35c each, 3 for \$1.00. **THE PHOTO-TECHNICAL LABORATORY**, Box 113, East Station, Des Moines, Iowa.

● **FILMS** and equipment bought, sold, exchanged. Complete Castle and Home Movie lines. **MICHIGAN FILM EXCHANGE**, 1514 Garfield, Grand Rapids, Mich.

● **MOVIE Cameras, Films, Projectors, etc.**, bought, sold, and exchanged. Big lists free. Art samples, 25c. **PEERLESS**, Box 1310-H, Hollywood, Calif.

BEFORE IT'S TOO LATE . . .

● Before a single copy of your **HOME MOVIES** becomes mislaid or mutilated, get one of our new handsome leatherette binders to keep them in. Holds 12 issues of the "new" **HOME MOVIES**. Sent prepaid for

\$1.25

HOME MOVIES, 6060 Sunset Blvd., Los Angeles, Calif.

Directory of Amateur Cine Clubs

● Continued from Preceding Page

WASHINGTON

SEATTLE: Northwest Amateur Cinema League — Carlos E. Grant, 915 Green Bldg., Seattle, Wash.
 Roosevelt Movie Club (16mm) — Jayne Stokes, Sec'y, Roosevelt High School, 2032 Franklin Ave. Meet every other Wednesday.
 Seattle 8mm Club (8mm) — W. B. Bowden, Sec'y, 546 Dexter Horton Bldg. Meet 2nd Tuesday each month.
TACOMA: Tacoma Cinema Club (16mm) — Don Flag, Sec'y, 829 S. Ferry St. Meet 4th Monday each month.

NEENAH: The Winnebago Camera Club, Movie Division — Duane Raiche, Sec'y, 247 4th St.

WYOMING

CASPER: Casper Amateur Motion Picture Club (8mm and 16mm) — A. F. Everitts, Sec'y, 1544 S. Cedar St. Meet 1st Tuesday each month.

CANADA

ALBERTA, CALGARY: Calgary Amateur Motion Picture Club (8mm and 16mm) — Mrs. A. F. McKenna, 2316 2nd St. W. Meet 3rd Thursday each month.
ALBERTA, EDMONTON: The Edmonton Cine Club (8mm and 16mm) — H. B. Holloway, Sec'y, Ste. 2, 10617 98th Ave. Meet 1st and 3rd Monday each month.

BRITISH COLUMBIA, VANCOUVER: Cine 8 Club (8mm) — J. L. Hudson, Pres., Box 35; A. S. Sutcliffe, Sec'y, Box 35. Meet 1st and 3rd Tuesday each month.

MANITOBA, WINNIPEG: University of Manitoba Students Camera Club, Cine Branch — Frank Kucera, Sec'y, 251 Poplar Ave.

ONTARIO, HAMILTON: Hamilton Movie Makers (8mm and 16mm) — J. J. Wood, Sec'y, 136 Markland Ave. Meet 4th Monday each month.

ONTARIO, TORONTO: Shots & Angles — N. Pelletier, 34 Blandford St., Toronto 10.

Toronto Amateur Movie Club (8mm and 16mm) — J. R. Beale, Sec'y, 40 Rosecliffe, Apt. 2. Meet 1st and 3rd Wednesday each month.

WINNEPEG, MANITOBA: Winnipeg Cine Club — Walter R. Lawson, Sec'y, 300 Winterton Ave. #11

SASKATCHEWAN, MOOSE JAW: Moose Jaw Movie Makers Club — Len Taylor, Sec'y, Canadian Legion Home.

MEXICO

MEXICO CITY: Cinema Club de Mexico (8mm and 16mm) — Harry Wright, Sec'y, Box 81 Bis., Mexico, D. F.

PUERTO RICO

SAN JUAN: San Juan Camera Club — B. Cruz, Jr., P. O. Box 3183.

WALLA WALLA: Walla Walla Cinema Club (8mm and 16mm) — Cromie L. Wilson, Sec'y, 715 Catherine St. Meet 4th Monday.
YAKIMA: Yakima Amateur Movie Club (8mm and 16mm) — William Hassell, Pres., 1208 W. Yakima Ave. Meet 4th Wednesday.
 Amateur Movie Club: Paul Thompson, Pres., 709 S. 4th St.

WEST VIRGINIA

HUNTINGTON: Huntington YMCA Amateur Movie Club (8mm and 16mm) — James Warfuehl, Sec'y, 629 6th St. Meet each 3rd Friday.

TRIADELPHIA: St. Vincent's Cinematic Club — E. Dietrich, Rt. 1, Box 93.

WHEELING: *Cinematography Group of the Ohio Valley Camera Club (8mm and 16mm) — R. E. Dempster, 162 15th St. Meet every other Friday.

WISCONSIN

MADISON: Cine 8 Club — Ruth Hoffman, Sec'y, 535 W. Dayton St. Meet 1st Tuesday each month.
 Maple Bluff Camera Club — John B. Casoday, Sec'y, 1005 Power & Light Bldg.

MILWAUKEE: The Amateur Movie Society of Milwaukee (8mm and 16mm) — Miss Parmelia M. Mills, Sec'y, 530 N. 20th St. Meet 2nd and 4th Wednesday.

Cream City Cinema Club — E. R. Glaesner, Sec'y, 3730 W. Lisbon Ave.
Milwaukeeke Movie Makers — Harold Francke, Sec'y, 1926 E. Fernwood Ave.

LOOKING FOR BARGAINS?

Cine Kodak BB, 3 1/2" K.A. f/4.5 telephoto lens, \$32.50. Filmo Projector 57-C, 400-W, case, \$39.50. 100 ft. 16mm positive film, 95c. Write for FREE BARGAIN BULLETIN No. 103G. **CAMERA MART**, 70 West 45 St., N. Y. C.

● **8MM TURRET** — including 1" f/3.5 telephoto — Keystone, \$34.95; Filmo, \$39.95. Keystone Windback, \$15.00. **CUSTOM-BUILT CAMERA ACCESSORIES CO.**, 4124 Rawlins, Dallas, Texas.

● **BOLEX H-8, 1/2"** f/1.5 Hugo-Meyer; 1 1/2" f/3.5 Wollensak, Bolex case, cable release — \$265.00 cash. Less than year old. Private owner. **MILES D. PILLARS**, Munsey Bldg., Washington, D. C.

EXCHANGE

● **PUMP SHOTGUNS**, target pistols, binoculars and medical microscopes accepted in trade on everything photographic, such as Leicas, Contaxes, Eastman and Bell & Howell motion picture equipment, Da-Lite Screens and Webster sound equipment including public address systems, amplifiers, etc. Write for catalog. **NATIONAL CAMERA EXCHANGE**, established in 1914, 11 S. 5th St., Minneapolis, Minn.

● **WILL TRADE** expensive inaudible 8-16mm camera. Want complete 9.5 equipment, performer, projector, good still camera or lens. **BOX 34, Elwood, R. I.**

● **WILL TRADE** — Buescher B-Flat Tenor Saxophone in good condition for 8mm movie camera. **HART**, 1444 So. Hayworth Ave., Los Angeles, Calif.

FILM

● **MAY SPECIAL!** 400 ft. 16mm, \$3.75; double 8 scored, \$3.95. Processing extra. 18 Scheiner. **MGM PHOTO SERVICE**, 1485 Oak, San Francisco.

● **WINNERLUX** 16mm film, fine grain, non-halation, Weston 8, 100 ft. \$2.50, including processing, return postage. 4318 Crenshaw, Los Angeles, California.

WANTED

● **WE WILL PAY \$ \$ \$ \$** for new **Movie Kinks** and Gadgets that we can use for resale purposes. **MIRETAX PRODUCTS**, 6241 Southwood Ave., St. Louis, Mo.

● **WANTED FOR CASH!** Private buyer wants used Eastman Cine-Kodak Special 16mm motion picture camera with extra 100 ft. magazine. Can also use fast telephoto lenses. Send best price, complete description to **WILLIAM CALKINS**, 301 Stephens Union, Berkeley, Calif.

● **WANTED** — Combination disc recorder and cutting head for 16", 33 1/3 R.P.M. records; also interested in complete record cutting and playing outfit coupled with 750 watt projector. Reply to **BOX 10, HOME MOVIES**.

TITLING SERVICE

● **HOLLYWOOD PROFESSIONAL** Titles. Effects, colors, poster art backgrounds, 16mm or 8mm. Use Orbit titles for Home Movies contest entries. Free Main and End titles. Write for information. **ORBIT FILMS**, 5437 1/4 Hollywood, Hollywood.

FILMING SERVICE

● **COLOR MOVIES** of Hawaii! Taken to order. Satisfaction assured. References, V. L. **COCHRAN**, Star-Bulletin, Honolulu, T. H.

PROCESSING SERVICE

● **8MM DUPLICATES**, 3c ft. Fast processing guaranteed, 30 ft. 8-8, 40c; Single 8, 25c. **CINE FOTO**, 128 Wilson, Springfield, Ohio.

PHOTO FINISHING

● **MIR-O-SHEEN PRINTS**. Quality photo finishing. Roll developed and one print each, 19c. Re-prints, 2c each. Reverse processing of movie film, 25 ft. dbl. 8mm, 25c — 50 ft. 16mm, 40c — 100 ft. 16mm, 60c. Washington customers include tax. Your spools returned. Return postage paid. **BOX 177, Seattle**.

BOOKS

● **IMPROVE** your photo technique with sensational handy reference book — **MOVIE KINKS** (2 volumes). Hundreds of new camera ideas. 25c per volume. **HUDDLE PUBLISHING CO.**, 1329 Fourth St., S. E., Minneapolis, Minn.

● **"ANIMATED CARTOONS"** — a new book that tells how to draw and animate cartoon characters for movies. Sent prepaid for \$1.00! **VER HALEN PUBLICATIONS**, 6060 Sunset Blvd., Hollywood, Calif.

ORDER FOR SUBSCRIPTION

Home Movies Magazine

12 MONTHS FOR \$2.00 IN U. S.

In Canada, \$2.00; Foreign—\$3.00

SPECIAL OFFER: 3 Years for \$5.00 in the U. S.

HOME MOVIES

1060 Sunset Blvd.
Hollywood, Calif.



Send to.....

Address

City..... State.....

New Renewal Gift

Send to.....

Address

City..... State.....

New Renewal Gift



Enclosed find \$..... Date..... 19.....

Sent in by.....

Address

City..... State.....



NO SUBSCRIPTIONS ACCEPTED FOR LESS THAN ONE YEAR



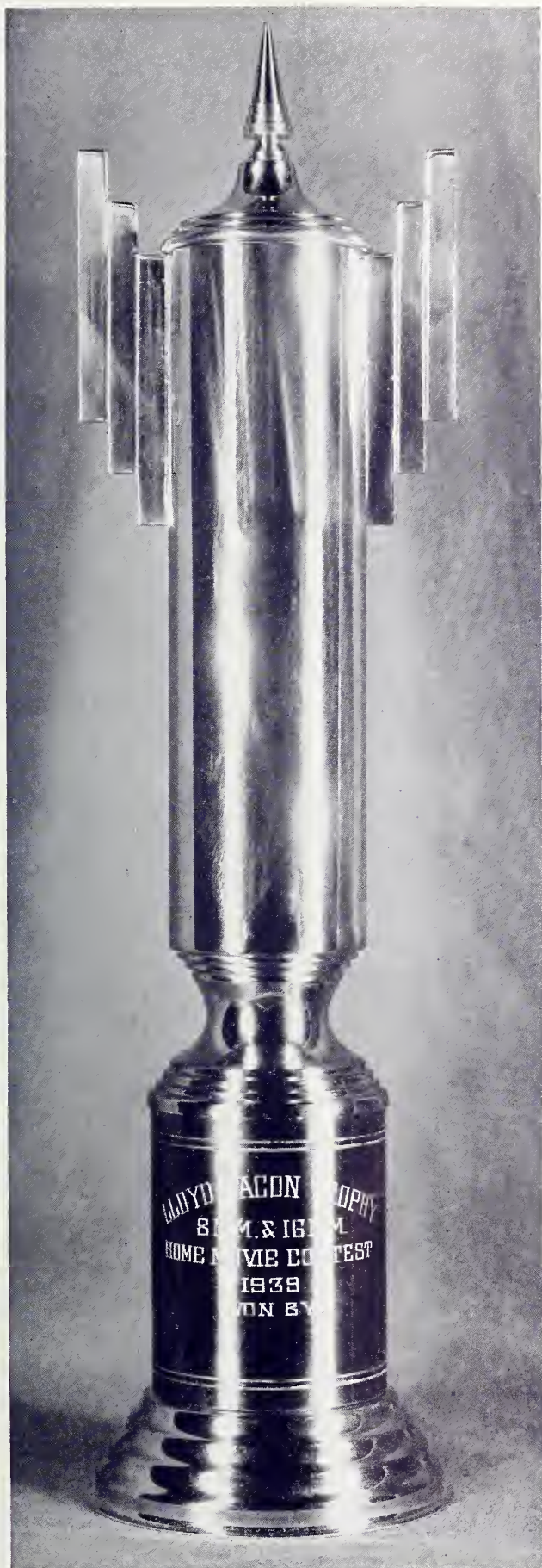

Who'll win it in 1940?

Sponsored by Lloyd Bacon, top flight director of Warner Brothers Hollywood studios, the Lloyd Bacon Trophy is comparable in the amateur field with the award of the Academy of Motion Picture Arts and Sciences in professional motion pictures and is probably the greatest distinction that can come to any amateur cinephotographer.

Every amateur movie maker has an equal chance in HOME MOVIES 1940 Amateur Contest. All you need is an 8mm or 16mm cine camera and film — and the ingenuity to edit your filming results in an interesting manner.

Contest Closes in 60 Days!

Prepare your entry now! Although contest does not close until June 30, 1940, submit your films early for judging and grading. They will be returned to you subject to recall for final judgment at conclusion of contest.

Contest is open to amateurs only. Submit as many entries as you wish. Twelve major prizes will be awarded.

RULES

Enclose postage for return of film.

Films must be either 8mm or 16mm. No limit on length.

Film should be titled . . . at least a main title. Commercial laboratory titles permitted.

No entry blanks necessary.

Be sure to properly label your reel and can for identification.

Include information regarding camera, lens, and film used, as well as other accessories.

**HOME MOVIES 1940 AMATEUR CONTEST
Closes June 30th!**

It's a Colorful World

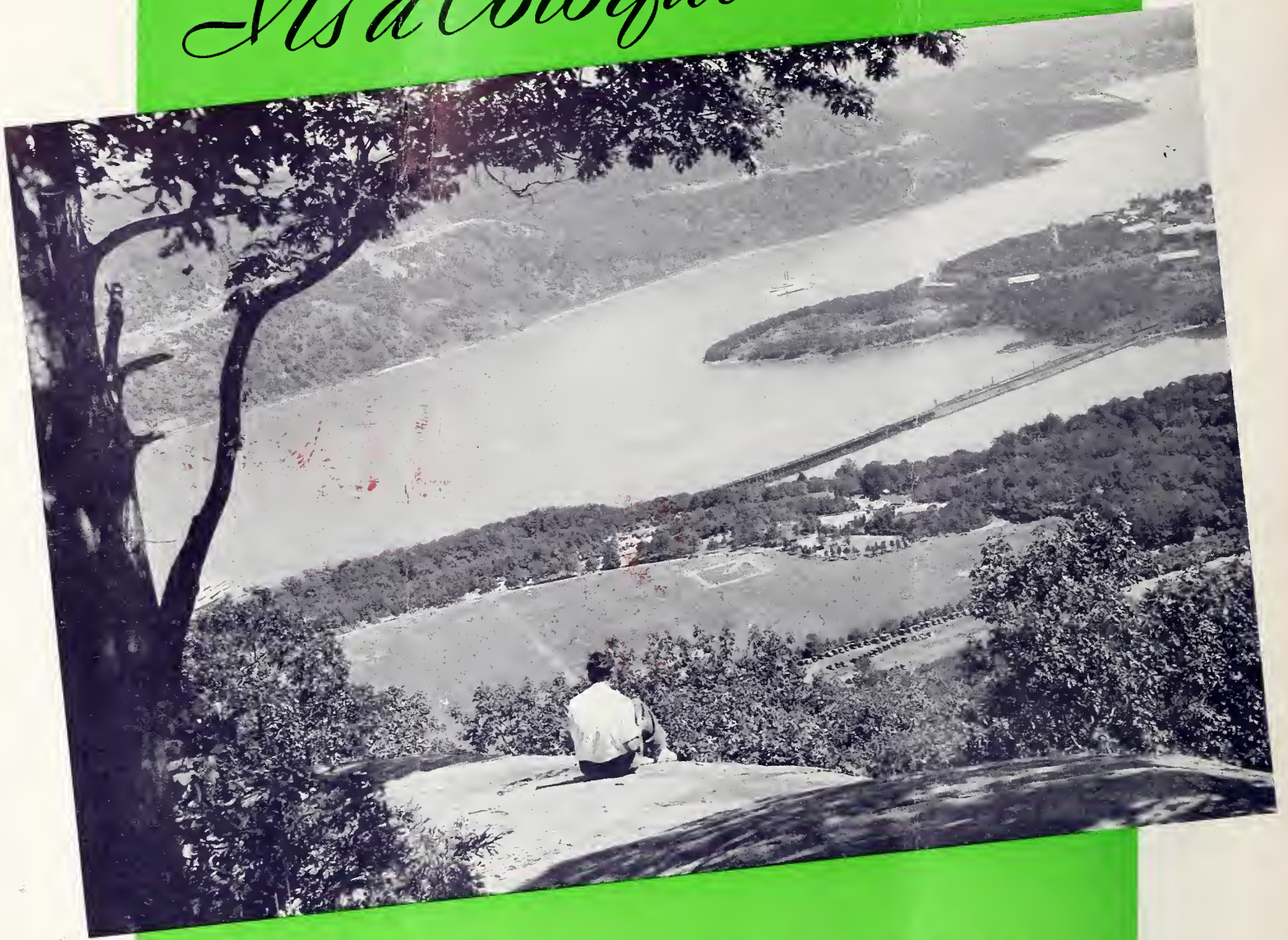

It's all yours in **KODACHROME**

KODACHROME, the full-color Ciné-Kodak Film, gives you mastery of all the world's color—brilliant or subtle.

It requires no camera or projector accessories, is as easy to use as black-and-white film. And its results are beautiful.

Ciné-Kodak Kodachrome Film is available for 16 mm. and 8 mm. home movie cameras. Regular Kodachrome is for use by daylight; Kodachrome Type A is especially balanced for correct color rendering by Photoflood light. Either can be used in the other's special field by slipping a corrective filter over the camera lens. Both types are the same price.

16 mm. Ciné-Kodak Kodachrome Film: 100-ft. roll, \$8; 50-ft. roll, \$4.30; 50-ft. magazine, \$4.65.

8 mm. Ciné-Kodak Kodachrome Film: 25-ft. roll, \$3.40.

Rediscover the color of the world with Kodachrome.

EASTMAN KODAK COMPANY, ROCHESTER, N. Y.



Register of Copyrights
Washington, D. C.

Price 25c

HOME MOVIES

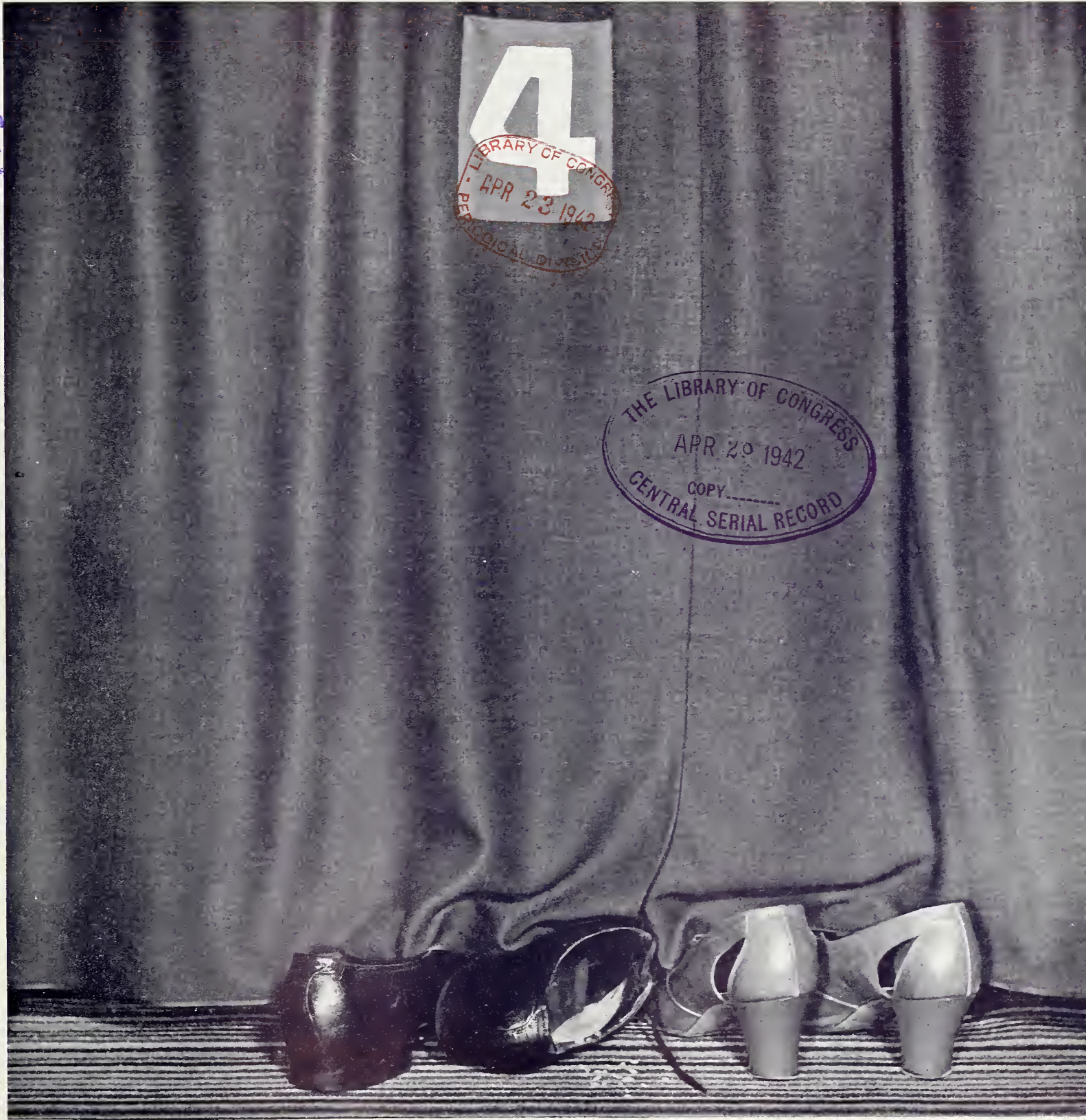

Fred J. Roth Photo

June . 1940

Hollywood's Magazine for the Amateur

NOW

3 historical war zone films!

Each a moving, vital document, pictorializing countries and peoples now playing an important part in the current European war . . . sure to prove of immense educational and historical value when smoke of the "blitzkrieg" lifts!



HOLLAND

Holland—her cities, villages, canals, her picturesque people in quaint costume—all are brought to you in this fine home movie film. Catalog No. 1069-B.

200 ft. 16mm \$5.00
100 ft. 8mm 2.50



BALKANS

"Children of The Balkan Mountains" is a document of one of the most vital areas destined to control future of the European war. Specify No. 1067-C.

400 ft. 16mm \$12.00
200 ft. 8mm 5.00



POLAND

"Peasant Women of Poland" depicts the hardworking native women of this recently conquered nation, whose menfolk continue to oppose their conquerors in allied armies. No. 1068-B.

200 ft. 16mm \$5.00
100 ft. 8mm 2.50

... And for the Laugh in your program—



Billy Dooley in "DIZZY DIVER"

Dooley, the sailor, ordered to paint the ship, paints everything, including the Captain. Fun begins when he is shot out of the boat on a torpedo! Specify No. 425-A.

100 ft. 16mm \$2.00
50 ft. 8mm 1.00

Meany, Miny and Moe in "MIDNIGHT SPOOKS!"



Meany, Miny and Moe take shelter from a rainstorm in a house of magic. Moe swallows the key, blocking their escape. Laugh provoking are their antics as magic jokes are played on them. Specify No. 1214-A.

100 ft. 16mm \$3.00
50 ft. 8mm 1.50

Distributed exclusively by SEEMANN'S, INC., Hollywood, Calif.

HOLLYWOOD FILM ENTERPRISES, INC.

6060 SUNSET BLVD. • HOLLYWOOD, CALIF

JUN -6 1940

©CIB 459233



★ Shot of the Month ...

ADVISORY EDITORS

- LOUIS SOBEL
The 8-16 Movie Club
- ARAK T. MATTINGLY
St. Louis Amateur Movie Club
- PAUL SNYDER
Norfolk Amateur Movie Club
- HOME RIEBETH
Minneapolis Cine Club
- MARCISSA A. PELLETIER
Toronto Amateur Movie Club
- E. NESTELL
Cinemen Club
- CLAUDE W. A. CADARETTE
Los Angeles 8mm Club
- ALFRED F. KAUFMAN
Indianapolis Am. Movie Club
- C. O. ROUNTREE
Bay Empire 8mm Movie Club
- ELBERT B. GRIFFITH
Sunkist Movie Club
- ARTHUR E. GIBBS
Portland Cine Club
- RAY A. HOOK
Seattle 8mm Club
- W. EMERSON CLYMA
Detroit Society of Cinematographers
- M. F. SISSEL
Austin Movie Club
- A. THEO. ROTH
Sherman Clay Movie Club
- REED E. SNYDER
Des Moines Y. M. C. A. Movie Club
- DR. C. ENION SMITH
Metro Movie Club of Chicago
- MOSS BROWN
Dallas Cinema Club
- PETER BEZEK
Chicago Cinema Club
- RUSSELL A. DIXON
Pittsburgh Amateur Cinema Club

home MOVIES

Copyright 1940 by Ver Halen Publications. No part of magazine may be reprinted without specific permission.

CONTENTS FOR JUNE, 1940

INFORMATION PLEASE	268
THE READER SPEAKS.....	270
BACKYARD MOVIES	271
HYPER-SENSITIZING AIDS NIGHT KODACHROME FILMING By R. S. MacCollister	273
PLAN FOR TREASURE ISLAND FILM...By J. Allyn Thatcher, M.D.	274
"LITTLE HOUSEKEEPER" SCENARIO, TITLES AND ALL By Curtis Randall	276
SIMPLE SOUND EFFECTS — AT HOME.....By Maurie Webster	278
MOVIE OF THE MONTH.....By J. H. Schoen	280
VERTICAL MULTI-PLANE TITLER.....By Robert E. Brock	281
"BOMBS OVER EUROPE".....By Paul F. Stacy	282
BACKGROUNDS IN MOTION.....By George W. Cushman	283
TITLE CENTERING GUIDES.....	284
TELEPHOTO ANY AMATEUR CAN BUILD.....By Walter W. Light	285
AMATEUR BUILDS MAGAZINE FOR 8MM CAMERA By Victor H. Wasson	286
TELL ME — HOW CAN I IMPROVE MY FILM?.....By the Editors	287
EXPERIMENTAL CINE WORKSHOP.....By Cinebugs	288
IT'S NEW TO ME.....By Cinebug Shopper	292
WITH THE PRO-16'S.....	294
EXPOSURE METER GUIDE	297
TITLE BACKGROUNDS	309
DIRECTORY OF AMATEUR CLUBS.....	310

J U N E
1940
NUMBER 6
VOLUME VII



★ Shot of the Month—example of a fine human interest closeup of the kind that adds materially to any amateur home movie.

CHAS. J. Ver HALEN
PUBLISHER

C. J. Ver HALEN, JR.
ASSOCIATE PUBLISHER

ARTHUR E. GAVIN
EDITOR

RAY FERNSTROM
Technical Editor
GEORGE W. CUSHMAN
J. H. SCHOEN
Associate Editors

COUNT H. von SCHOENFELDT
Photographic Editor

C. E. BELL
Associate Photo Editor

L. C. BUSCHER
Art Director

SEYMOUR B. AGINS
Asst. Art Director

OFFICE OF PUBLICATION
6060 Sunset Boulevard, Los Angeles, Calif.
Phone GRANite 5149

NEW YORK OFFICE
Everett Gellert, 62 West 45th Street
Vanderbilt 6-5254

CHICAGO OFFICE
C. N. Burris, 712 Wrigley Building
Whitehall 7784

Entered as Second-Class Matter, May 6, 1938, at the Postoffice at Los Angeles, California, under the Act of March 3, 1879.
Subscription rates—U. S., \$2.00 a year. Canada, \$2.00 a year. Foreign, \$3.00 a year. Single copies, 35c. Foreign single copies, 35c. Copyright, 1940, by Ver Halen Publications. Advertising Rates on Application.

First!

**16 MM & 8 MM
ALLIES — NAZIS**

BOMBS

**CASTLE FILMS, FOREMOST HOME
MOVIE PRODUCER, SCORES ITS
GREATEST WORLD NEWS BEAT!**

**NOW YOU CAN OWN ASTOUNDING
ACTION MOVIES OF THE DARKEST
HOURS OF MODERN HISTORY!**



MOVIES OF WAR IN EARNEST FIGHTING ON ALL FRONTS!



OVER EUROPE

WAR in all its ruthless fury, caught by scores of intrepid cameramen who risk their lives under land, sea and sky fire. Europe's holocaust is brought to your own screen. Every projector owner will treasure this startling camera record of headlines coming to life. Here is grim history

recorded for today and for the ages to come.

Own this greatest News Parade. It covers the whole world-rocking operation from the invasion in the Arctic to the lightning thrusts for continental Europe, as the fierce god Mars goes on the wildest rampage of all times.

Thousands of 16 mm and 8 mm projector owners throughout the world depend upon Castle Films for authentic, exclusive movies of the march of modern history. Again Castle Films provides the picture you want to own. Despite unprecedented cost it is available for you to own at Castle Films' regular low prices.

Send this Handy Order Form to your photographic dealer NOW

CASTLE FILMS
30 Rockefeller Plaza • New York City

Please send Castle Films' BOMBS OVER EUROPE in the size and edition checked below.

16 mm SIZE			8 mm SIZE	
Headline 100 Feet \$3.50	Complete 360 Feet \$8.75	Sound 350 Feet \$17.50	Headline 50 Feet \$1.75	Complete 180 Feet \$5.50

Name _____

Address _____

City _____ State _____

B-6



"TAKE" Your Vacation . . .

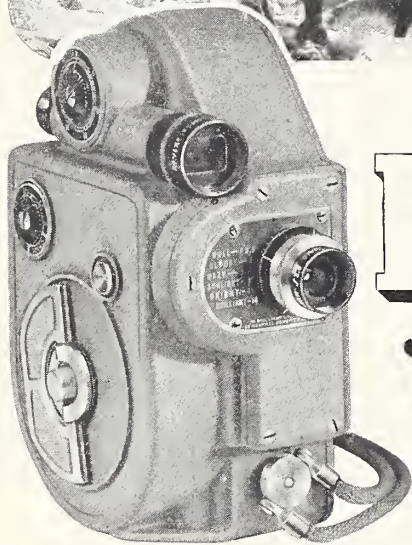

WITH THE NEW **Revere** *Double 8* **CAMERA**

Licensed Under
Eastman Spool and
Spindle Patents

Revere Model 88 Dble. 8 Camera

takes all Double 8 film, full color or black and white. Eastman standard spindles and spool insure correct threading. 5 ft. spring motor, helically cut gears, parallax corrected optical viewfinder. 5 speeds, 8, 12, 16, 24, 32 frames per second. Stainless steel aperture plate. 160° rotary disc shutter. Complete with Wollensak 12.5mm F 3.5 lens in removable universal focus mounting. \$29.50

Revere Turret Model 99

Has all the features of Model 88, plus Turret and extra optical viewfinder for use with 1" and 1½" telephoto lenses. Complete with one Wollensak 12.5mm F 2.5 lens. \$65.00.

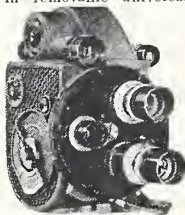

Your vacation trip can be enjoyed again and again when you take *movies* of it, in full color or brilliant black and white, with the new Revere Double 8 Camera.

Special features make the Revere Double 8 Camera the easiest of all to use. Its exclusive *retarding sprocket film control* makes a film loop automatically if you forget—prevents film jamming. It also takes all strain off the film gate and with Revere's *precision-built shuttle movement and positive speed control*, assures steadier, clearer movies. 5 speeds, 8 to 32 frames per second permit taking pictures under difficult light conditions and make possible surprising effects in slow motion or ultra fast action. See this remarkable camera and the Revere Standard 8 Projector at your dealer's!

SHOW BRIGHTER, CLEARER MOVIES WITH THE REVERE 8 PROJECTOR

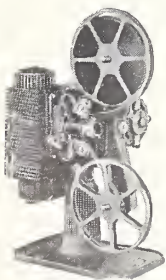

The new 500 watt Model 80 Series B Revere Projector will do wonders for your 8mm movies. Its greater screen illumination makes every picture sharper and more brilliant. Check its superior features: F 1.6 lens, high ratio Duplex shuttle film movement, double blower cooling system, enclosed gear and chain rewind. Complete with 500-watt lamp and F 1.6 lens. \$59.50.

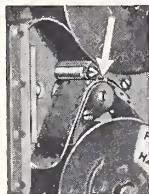

Camera Sprocket Film Control
forms loop automatically, an exclusive Revere feature.

Revere Motion Picture
STANDARD 8 Equipment

REVERE CAMERA COMPANY • CHICAGO
PHILADELPHIA • KANSAS CITY • MINNEAPOLIS • LOS ANGELES • DALLAS

Information PLEASE

Film Too Fast (John Gates, Detroit, Mich.)

Please tell me what to do when I am using such a fast film that I cannot stop my lens down far enough in order to use it in bright sunlight.

Ans. The remedy to your problem is to use a filter—one that will require opening up the lens one or two stops. As you know, the use of any filter requires opening up the lens (increasing exposure). Also, neutral density filters may be employed for this same purpose. They will have the same effect on your film—that of holding back the intensity of light—but will impart no correction to the color values as when color filters are used.

Supplemental Lenses (Ray Tannen, Aberdeen, Wash.)

There is some dispute among a group of local cinefilmmers as to whether or not the lenses of dime store reading spectacles are o.k. for shooting titles and ultra closeups. Will you please settle the argument for us?

Ans. Naturally, it would be difficult for us to say for sure that all of the spectacles found on dime store counters were fitted with accurate lenses. However, we know of hundreds of cases where these lenses are being used, and with success. If such lenses are centered accurately over the camera lens, then any error in the grinding of that lens will have little effect as such errors prevail mostly away from the center area of the lens.

Film Shrunk (J. R. Black, Chicago, Ill.)

Recently I purchased one of the commercially made 8mm library films and found that when projected, it caused a terrible clacking noise as it ran through my projector. Would the film on which the print was made be too thick, or what is the cause?

Ans. There is a tendency for all sub-standard films,

• READERS: This department is for your benefit. Send in your problems and our technical board of professional cameramen will answer your question in these columns. If an answer by mail is desired, enclose addressed stamped envelope.

both 8mm and 16mm, to shrink or stretch, depending upon atmospheric or climatic conditions. Also, an old film which has not been stored properly, may gradually shrink. Undoubtedly the film you refer to shrunk slightly, causing the sprocket holes not to line up accurately with the intermittent claw of your projector as it passes through the machine.

An amateur once wrote advising he had corrected this condition in an old film by soaking it in water, then allowing the film to dry slowly. The film was wound on a developing drum for this purpose, of course.

Film Cement (M. R. Ehrer, Sacramento, Calif.)

Is there a "thinner" available for reducing consistency of slightly aged film cement? Unless film cement is used up right away, it thickens with age. Also, is there any relatively simple formula for making one's own cement in small quantities as needed? And what solvent may be used to clean old cement bottles and applicators?

Ans. Because cement formulas vary, we hesitate to recommend a thinner. However, here is a formula for making your own cement for acetate film:

Ethyl Acetate,
Ethyl Alcohol, 94 proof,
Glacial Acetic Acid,
mix equal parts by volume. You must work fast with this cement as it dries quickly.

Regular acetone—the stuff used for removing finger nail polish—will clean old cement bottles and applicators.

Mail Coupon Now!

Revere Camera Co., Inc.
Dept. 6HM, 326 E. 21st St.,
Chicago, Ill.

Please send latest literature on the complete line of Revere 8mm motion picture equipment.

Name.....
Address.....
City..... State.....

10 REASONS



**WHY YOU
WILL LIKE THE**

NEW G-E EXPOSURE METER

- 1 NEW STYLING.** Attractive appearance, shaped to fit the hand and feel right.
- 2 NEW ONE-HAND OPERATION.** The calculator, hinged cover, and new locking device are designed to operate with one hand.
- 3 NEW LOCKING FEATURE.** Permits calculator to be locked in position after reading is taken. Adjustments will not change when meter is put into case or pocket.
- 4 NEW SINGLE SCALE.** By means of incident light and hinged cover, this scale covers a brightness range of .05 to 1700 candles per square foot.
- 5 NEW CALCULATOR.** Will meet all demands of stills, color, and movies. Easy to read.
- 6 NEW SELF-MULTIPLIER ON CALCULATOR.** Automatically multiplies exposure when meter is used for incident light measurement in very dim light.
- 7 NEW FILM VALUE LOCK.** Set it once, and it will stay locked until new film value is to be used.
- 8 NEW DIE-CAST METAL HOOD.** Protects light cell. Snaps off for dim-light readings.
- 9 NEW FILM VALUES** up to 800
NEW F STOPS from F:1 to F:44
NEW SHUTTER SPEEDS from 1/2500 second to 100 seconds.
- 10 NEW PHOTO DATA BOOK.** Free with every G-E meter. Convenient, vest-pocket size, 110 pages.

**ORDER AT YOUR
DEALER'S TODAY**

**TYPE DW-48
Price \$21.00**

GENERAL  **ELECTRIC**

606-5A

A DeLuxe Quality Slide Chest
at a Popular Price

DECO SLIDE CHEST

FOR ALL 2x2 SLIDES
Model 145-A for Glass Slides

\$250



FEATURES:

- * Durability
- * Snap Catch
- * Felt Feet
- * Compactness
- * Slide Cushions
- * Light Weight
- * Carrying Handle
- * Convenient Stacking
- * All Metal Construction
- * Angular Slide Positioning
- * Replaceable Individual Index
- * Capacity 100—2x2 Glass Slides
- * Full Width Individual Partitions
- * Durable Baked Opalescent Brown Rich Wrinkle Finish
- * Easy Positive Insertion and Removal of Slides

STURDILY CONSTRUCTED

PIONEER PAN and TILTING TOP

\$275



- Suitable for any cine or hand camera
- Easily attached to any tripod
- Very light and durable
- Beautifully finished

Mail Orders Filled
Include Postage with Remittance

Willoughbys

32nd St. Near 6th Ave., N. Y.
World's Largest Camera Store
Built on Square Dealing

The Reader



SPEAKS

Seconds The Motion

Here's another vote for the "emblems for home movie makers" idea!

Gentlemen: In the May issue of HOME MOVIES, Irwin Sipherd states that an emblem for the coat lapel or a ring that would identify amateur cinephotographers would be a great thing.

We of the Long Beach Cinema Club have also discussed a similar idea and are for it 100%. We'll appreciate it if—through the pages of your publication—you can bring this idea to the attention of every amateur cine club so that it may become a reality. And the sooner the better. Thank you for bringing it to our attention.

—H. E. Ward, Jr.

Lacked Club Guidance

Some beginning amateur movie makers question the value of membership in their local cine club. The following story related by Ed Nestell of the Cinemen Club is an example of a mistake that could have happened to any of us when we first began to shoot movies:

Dear Sirs: I don't suppose there are many amateurs as bad as the fellow whom I read about the other day. An article in a newspaper captioned "Light No Handicap as Far as He Knew" read as follows:

"Into one of the large midtown photographic supply houses walked a stout man who was considerably thinner after he had unloaded his bulging overcoat pockets. What he unloaded before the bug-eyed salesman was roll after roll of small motion picture film, sans boxes or containers. 'Why, man alive!' the salesman exclaimed, 'we can't process these films. They have been exposed to the light.' The customer went into a frenzy. 'You can't do this to me!' he shouted. 'I've been taking these pic-

tures for a year. They are a record of my world cruise and there was nothing on the packages about light hurting them.'"

Nevertheless that's a good illustration of just one subject. There are a number of other phases of photography which are just as much a mystery to many of us as light was to this fellow, and I think we all learn a lot more by attending our monthly club meetings regularly.

—J. E. Nestell.

Plea For "Eights"

The photographic dealers in this reader's locality will do well to heed this plea. The "eights" have become mighty important!

Dear Sirs: Now that everyone is "census" minded, how about a census of 8mm camera users, just to prove to some photo dealers how really numerous and important we are! My reason for suggesting this is that invariably when I go to a camera store to buy an accessory or a film, it is not available for 8mm equipment. Then there are the film libraries. The best films are usually available only in 16mm. Surely the number of 8mm users warrants more attention to our needs.

—Jos. A. Ullman.

Swappers

Have you films you want to swap? Want to make some footage for a brother cinebug in exchange for something you want? Here are some "swap" requests:

Sirs: Would some experienced and capable 8mm fan in or around Portland, Ore., be interested in exchanging certain filmed-to-order footage for an equal amount featuring Hawaiian travel, Honolulu and Island views, surfing, beaches, etc.?

I wish 200 feet of black and white 8mm film featuring farming occupations

• Continued on Page 308

WHY PAY MORE THAN \$3.00 FOR PERFECT OUTDOOR FILM PERFORMANCE

KIN-O-LUX
16mm
KIN-O-LUX FILMS
NEW YORK, N. Y.
KIN-O-LUX FILM No. 1

... unless, of course, you're the sort of person who likes to pay more. Three dollars for a 100-ft. roll of Kin-O-Lux No. 1 Film includes every essential requirement for good outdoor filming. It offers brilliancy—snap—gradation—latitude—tonal fidelity—antihalation backing—free Scratchproofing to insure long life and the maker's unequivocal guarantee. Within limitations that preclude indoor filming and filter use, its performance is identical to that of more expensive films.

DAYLIGHT EMULSION SPEEDS	
Scheiner 16°	Weston 6
100-ft. roll	\$3.00
50-ft. roll	\$2.00

KIN-O-LUX No. 2. Fine-grain, semi-chromatic. Greater speed and wider latitude than No. 1 Daylight Emulsion Speeds: Scheiner, 18°; Weston 12.

50 ft.	\$2.50
100 ft.	\$3.50

KIN-O-LUX No. 3. Supersensitive over the entire range of the visible spectrum, Kin-O-Lux No. 3 has established a new standard of film performance. Achieves an ultimate, present-day perfection that cannot be surpassed. Is preferred by movie makers who discriminate in favor of the best. Daylight Emulsion Speeds: Scheiner, 26°, Weston 50. Tungsten Speeds: Scheiner, 24°, Weston 40.

100 ft.	\$6.00
50 ft.	\$3.50

ALL FILM PRICES INCLUDE PROCESSING, SCRATCH-PROOFING AND RETURN POSTAGE

At Leading Dealers Everywhere
Booklet H-5 on request

Learn about Glare-Free, Reflectionless Photography. Send for instructive Folder on Marks Polarization Plates.

KIN-O-LUX
16 MM REVERSAL FILM
KIN-O-LUX, INC.
105 W. 40th ST., N. Y. C.

BACKYARD MOVIES

Ideas for Short Films

Vacation Plot

Here is a short vacation filming idea that may be filmed with the aid of three or more persons. A couple—husband and wife—start out on their vacation, car loaded with the usual baggage, fishing tackle, golf clubs, etc. As they proceed down the highway in their car, the wife begins to worry—worrying if she forgot anything, etc. Suddenly she startles her husband with the question, "Did you tell the milkman not to leave any milk?" And husband assures her he did. They travel a bit farther, then she asks if he turned off the water heater. Later she asks if he put her dressing set in the bag; did he remember to telephone mother; did he tell the paper boy not to leave the paper; then—did he lock the cat in the house or leave her outside to starve!

Finally, in exasperation, husband stops car abruptly, turns around and heads for home, telling wife they'll go back so that she can check all these things for herself. They arrive at the house, and husband hands wife the key, telling her to hustle into the house and satisfy herself everything is all right. He watches her intently as she proceeds up walk, unlocks door and enters house. As door closes behind her, a big smile lights up his face. He heaves a big sigh of relief, steps on the starter and drives off without her.

Proceeding down the highway, husband snuggles down comfortably in car seat, lights a cigarette and smiles as he contemplates a nice quiet vacation by himself. Fade-out.

—James Ferris.

Who Loves Her Best?

Scene 1—Long shot showing Mother, Bobby, Helen, and Mary sitting at the breakfast table, their heads bowed in prayer.

Scene 2—Semi-closeup of Mother with bowed head in prayer, saying:

Title—"Dear Lord, we thank You for this food."

Scene 3—Closeup of Helen with bowed head, and

eyes peering through half-closed lids.

Scene 4—Closeup of Mary with bowed head and eyes tightly closed.

Scene 5—Closeup of Bobby with bowed head, which he lifts and cautiously opens one eye.

Scene 6—Closeup of Bobby's hand slowly stealing out for a biscuit.

Scene 7—Semi-closeup of Helen grabbing wrist of Bobby's outstretched hand before he reaches biscuit, and holding it there.

Scene 8—Long shot of table with prayer finished, and heads being raised.

Scene 9—Semi-closeup of Mother looking down at Bobby's hand on the table and saying:

Title—"I try so hard to raise you children properly."

Scene 10—Semi-closeup of Bobby looking sheepish and then defiantly saying:

Title—"But I'm hungry, Mom."

Scene 11—Semi-closeup of Helen looking disgustedly at Bobby and saying:

Title—"And Mother loves you so."

Scene 12—Semi-closeup of Bobby with a defiant air, stating:

Title—"I love Mother more than any of you do."

Scene 13—Medium shot of Helen and Mary vigorously denying Bobby's statement, shaking their heads negatively and pointing to themselves.

Scene 14—Semi-closeup of Mother putting out both

• Continued on Page 306

• We want suggestions and ideas for random "backyard" filming; also for simple home movie scenarios. Those which are published will bring the contributors either a 100-ft. 16mm or a 50-ft. 8mm film subject selected from the advertisements or catalogues of any library or producer-advertiser in HOME MOVIES magazine.

For ideas that can be adapted to a feature length article we will reward the contributor with two rolls of panchromatic film. Address your suggestions to BACKYARD MOVIES, care of HOME MOVIES, 6060 Sunset Boulevard, Hollywood, Calif.

THIS YEAR *Bring Back* Sharper Pictures



--- Steady Your Camera with

THE DA-LITE UNIPOD!

Reg. U. S. Pat. Off.



For movies free from wobble and stills that are free from blurs—here is the most convenient camera support you have ever tried. The Da-Lite Unipod, consisting of two telescoping tubular members, weighs only 1 lb. When not in use it is a walking cane or swagger stick. It can be quickly put into service. No separate parts to carry or get lost.

The Da-Lite Unipod is made in two styles: No. 1, which rests upon the ground, and No. 2 (shown above), with neck strap. Get your Unipod today and bring back from your World's Fair or vacation trip sharper, clearer pictures that you will be proud to show.

For perfect projection of your movies or stills, use a Da-Lite Glass-Beaded Screen. The Challenger Model shown here can be set up anywhere in 15 seconds. See at your dealer's! Write for literature!

DA-LITE SCREEN COMPANY, INC.

DEPT. 6 H. M., 2723 N. CRAWFORD AVE.

CHICAGO, ILL.



How it came about

WHEN there's a sharp improvement in the quality of someone's home movies, it's very likely the result of using finer film.

Many such improvements can be traced to Agfa 16 mm. Fine-Grain Plenachrome Reversible. Particularly suited to outdoor work, it combines especially fine grain with ample speed, brilliant contrast, and orthochromatic color sensitivity.

Also sharing the credit is the fast Agfa 16 mm. Panchromatic Reversible Film.

It is adapted to a wide variety of uses, giving splendid screen brilliance on projection, and full sensitivity to all colors.

Each of these great 16 mm. films is supplied at a price that offers an exceptional value. Try them for your next movies. Both Fine-Grain Plenachrome Reversible and Panchromatic Reversible are available in 100 foot rolls at \$4.50; and in 50-foot rolls at \$2.75. Prices include processing and return postage. **Agfa Ansco, Binghamton, New York . . . Made in U. S. A.**

Agfa
16 mm. FILM





Home Movies

MAGAZINE



**Subscription
Order Form**



HOME MOVIES

Published in Hollywood

JUNE 1940



Photos courtesy Golden Gate International Exposition

HYPER-SENSITIZING aids night filming

Authored by
R. S. MACCOLLISTER

FAIR pictures which rated highest among cinebugs last year were those which included well-exposed footage of the colorfully-lighted Fair buildings and exhibits after sundown. Indeed, toward the close of the season, filming the Fairs at night in Kodachrome was the chief topic of conversation and, with some, the chief activity among many amateur movie makers.

And there were many who did succeed in getting good pictures of the night lighting effects, both at San Francisco and in New York. Many and varied were the gadgets and doohickeys employed by amateurs to enable their cameras to capture the elusive tones of color that make the Fairs more beautiful at night. These gadgets were rigged up to cameras for just one purpose — to increase the exposure time.

It was the general knowledge last year that, at the Golden Gate International Exposition at San Francisco, the proper exposure for Kodachrome film for night shots of the lighting reflected from the buildings was about $f/2$ for one full second exposure. Thus, cameras equipped with lenses capable of being opened to $f/1.5$ might film the night scenes at one-half second exposure — provided they could time their camera's exposure this slow. Since lenses could not be speeded up, the only alternative, it seemed, was to rig up gadgets that would maintain the camera speed at a consistently lower level.

Being among those interested in filming the San Francisco Fair at night, I remembered that it was possible to "hop up" the speed of black and white film by hyper-sensitizing it with mercury. I had never heard of anyone attempting to hyper-

with **KODACHROME**

sensitize Kodachrome, so I decided to try, believing it might give me the answer so many amateurs were seeking to the problem of obtaining satisfactory night exposures on Kodachrome.

This decision meant screwing the courage past the sticking point and risk blowing nine dollars for a roll of Kodachrome with no assurance whatever of success. The film purchased, the rest was comparatively easy. A modest supply of mercury was purchased from a drug store for 15 cents. Among the odds and ends at home, I found a discarded wooden box with a tight-fitting lid which served satisfactorily as the hyper-sensitizing chamber.

The mercury was poured out into a small nut dish and placed within the box. Next, the film was removed from the container and placed alongside of the dish of mercury. The lid was placed on the box and sealed with adhesive tape, as an air-tight chamber is necessary to the success of hyper-sensitization. The box was

• Continued on Page 295

• The spectacular night lighting at both Fairs this year may be captured on Kodachrome "hopped up" by a simple mercury hyper-sensitizing process.



Authored by
J. ALLYN THATCHER, M. D.



Courtesy Golden Gate International Exposition

Plan a cinematic treasure hunt on TREASURE ISLAND

● Keep an eye on the sun if you want to make the kind of movies of Treasure Island that will win more than ordinary applause. Waiting for the sun to "be just right" will net fine light and shadow detail, as in the pictures reproduced here.

ON May 25, the huge gates swung open on the 1940 edition of the Golden Gate International Exposition. The return engagement on San Francisco's Treasure Island of what is probably America's most colorful Fair promises amateur movie makers something special on which to try their cinematic superlatives.

Cinebugs who lamented inability to visit the Exposition last year, and those hoping for an opportunity to re-take scenes or add further footage to last year's Treasure Island movies, are afforded another chance to capture the beauty and charm of the West's greatest show.

We could go on indefinitely, describing the beauty and the interesting things to be seen at the Exposition, but such facts already have appeared in print elsewhere or the information may be had from guide books especially devoted to the 1940 Exposition. That it is a grand show, offering

unlimited opportunities for making swell home movies, is a foregone conclusion. We can serve the amateur better, perhaps, by attempting to point out the most important things to film, where best to set up the camera, and offering suggestions as to the best exposure to use on each scene.

First let us tell about an innovation which will be found this year, and sure to be welcomed by every cameraist. It was created and engineered by a true friend and champion of the home movie maker—Eric M. Unmack, proprietor of the Westwood Cinema Company on Ocean Avenue in San

Francisco. Prior to opening of the Exposition, Mr. Unmack called upon Major Keating, assistant general manager, and laid before him plans providing for erecting a series of elevated stands at vantage points about the Exposition grounds for the express use of cinefilmmers and photographers. The plan met with unanimous approval and at this writing we are informed the stands are being constructed and most of them will be in place throughout the grounds the opening week.

These stands will afford any person using a camera an opportunity to make pictures with camera set up above the heads of the crowds. Thus, there won't be any heads bobbing in the foreground when parades go by or when other important events are taking place. And each stand is being erected on a site especially selected for the camera angle and pictorial composition it will afford. It has been suggested also that framed in-

● Continued on Page 301

Courtesy Golden Gate International Exposition



(right)

AFTER SUNDOWN

A fine, low-key study noted for its composition, and a picture particularly adaptable as a title background.

Photo by

Chas. W. Herbert



Authored by
CURTIS RANDALL
Photos by C. E. Bell



clothes. She is on the back stoop, with her toy washing machine and clothes line.

Scene 1: Fade-in. Medium closeup. As described above, little girl is scrubbing doll clothes.

Title:

"Sakes alive! It seems to me,
I'm as busy as can be.
Monday I wash Dollie's clothes,
And they need it, goodness knows!"

Scene 2: Continuing with scene 1.

Scene 3: Closeup of girl. Same action as previous scene.

Scene 4: Closeup of her chubby hands scrubbing

For a kiddie scenario, you'll like the "LITTLE HOUSEKEEPER"

HERE is a simple and appealing home movie story written especially for cinedads with youngsters to film, a story that requires but a single 100-foot roll of 16mm or a 50-foot spool of 8mm film to record. It was especially prepared for those cine-filmers who so often have asked for a simple scenario for kiddies that does not require them to be Shirley Temples or Virginia Weidlers to act it out.

"The Little Housekeeper" is just the sort of story that enables one to make pictures of children that will have a semblance of plot and continuity. It is an account of the activities of a child and her playmates playing "house." The action is quite simple and amply tied together with descriptive titles which have been prepared, ready to shoot, on the opposite page.

It is essentially a "girl's" story, although, if there are boys in the family, they can be worked into the plot in the role of "husband," "neighbors," etc, as they have no lines to speak as far as titles are concerned. Also, the entire story may be filmed out of doors.

The story begins with a little girl busily engaged washing her doll's

clothes and then wringing them out.

Scene 5: Closeup of girl as she pins doll clothes to toy clothes line. Fade out.

Title:

"Tuesday is my ironing day,
So my friends must keep away.
Dollie's clothes must all be pressed,
So she'll look nice when she's dressed."

Scene 6: Another location. Little girl ironing doll clothes with toy iron and board. She moistens finger tips and touches same to iron. Cut to—

Scene 7: Closeup of fingers gingerly touching make-believe hot iron.

Scene 8: Back to scene 6, as girl continues ironing.

Scene 9: Closeup of hands manipulating folds in tiny dress as she moves iron over it.

Scene 10: Back to scene 8, as girl finishes ironing dress; picks it up daintily and hangs it up or lays it away with other finished work. Fade out.

Title:

"Wednesday is the maid's day out,
So I'm busy round about.
Two o'clock right on the tap,
Dollie has to take her nap."

Scene 11: Another location. Scene: Make-believe doll's bedroom. Girl has undressed doll and is putting on its pajamas. She speaks to it, reminding doll it must say its prayers; then makes doll kneel down beside bed.

Scene 12: Closeup of girl's hands placing doll in kneeling position, with its hands together as though in prayer.

Scene 13: Back to scene 11. Girl picks up doll and gently holds it to her bosom and begins to rock and sing it to sleep.

• Here's a shooting script that is easy to film and requires no histrionic abilities of your kiddie actors. And best of all, it may be filmed entirely out of doors. All the necessary title cards have been prepared for you on the opposite page.

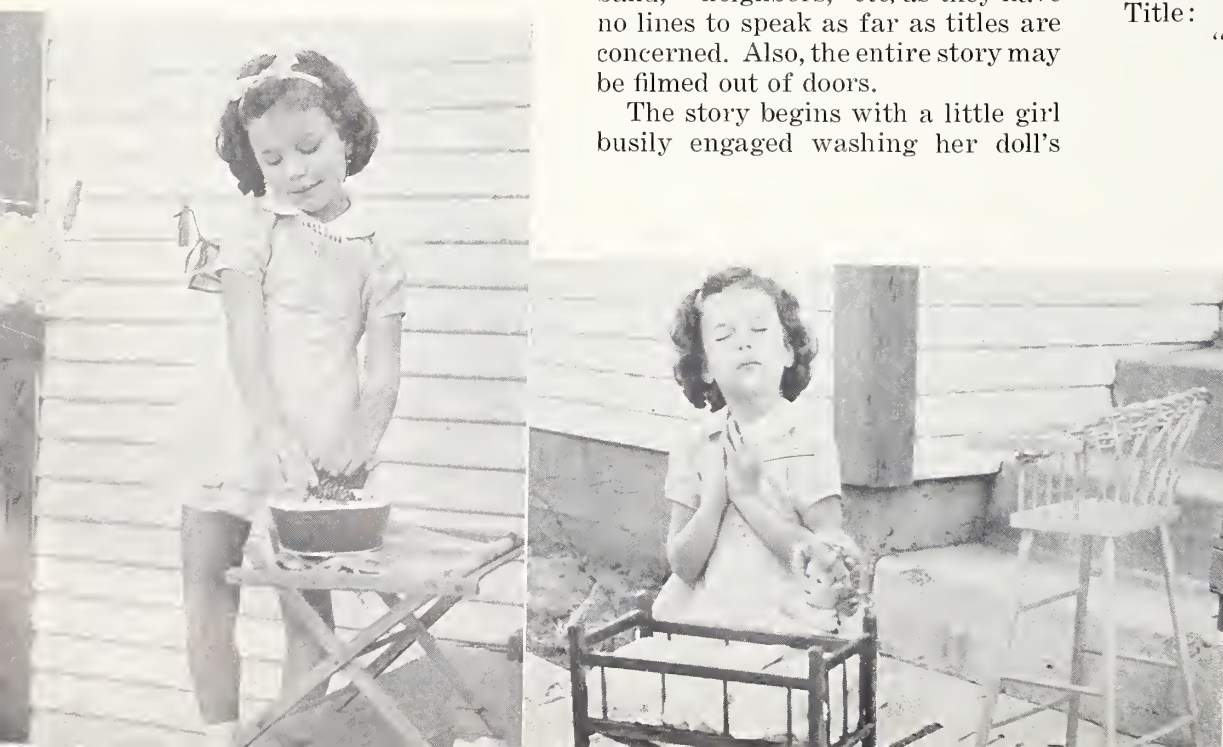



"Sakes alive! It seems to me,
I'm as busy as can be.
Monday I wash Dollie's
clothes,
And they need it, goodness
knows!"

"Tuesday is my ironing day,
So my friends must keep
away.
Dollie's clothes must all be
pressed,
So she'll look nice when she's
dressed."

"Wednesday is the maid's day
out,
So I'm busy round about.
Two o'clock right on the tap,
Dollie has to take her nap."

"Thursday is my calling day,
So I dress up in this way.
You don't know it's me at all,
When I have my parasol."

"Friday I've no time to roam,
Far that is my day at home.
Then my girl friends call on
me,
And we have a cup of tea."

"Saturday, you surely know,
To the market I must go.
Dollie goes along with me,
So I'll have some company."

"But when Sunday comes at
last,
Then my week of toil is past.
Here's the funny picture part
That I love with all my heart."



Scene 14: Closeup of girl singing gently to doll.
Scene 15: Back to scene 13 as girl finishes lullaby and places doll in crib. Fade out.

Title:

"Thursday is my calling day,
So I dress up in this way.
You don't know it's me at all,
When I have my parasol."

Scene 16: Medium shot of girl partly covered by large parasol, walking down sidewalk directly away from camera. Better still, place camera on improvised dolly (a toy wagon will do) and make a travel shot of this action, following the girl as she walks slowly.

Scene 17: Medium closeup. Girl meets another. Stops to chat and turns to one side to reveal her identity from beneath parasol.

Scene 18: Closeup of both girls talking with all the grown-up mannerisms of their elders. They bid one another goodby.

Scene 19: Back to scene 17. Girls bidding goodby. Girl with umbrella continues down street. Second girl comes toward camera and out of scene at left. Fade out.

Title:

"Friday I've no time to roam,
For that is my day at home.

Then my girl friends call on me,
And we have a cup of tea."

Scene 20: Scene: Garden. Toy table and chairs. Dishes and small cakes on the table. Girl greets one or two friends who have just arrived. Invites them to sit down. Cut to—

Scene 21: Closeup of girl as she holds chair and seats one of her guests at table.

Scene 22: Back to scene 20. Other guest sits down, then the girl takes her place at table and begins serving—pouring tea and passing the small cakes.

Scene 23: Here make a closeup of each of the girls in the scene as she sips tea and chats. Fade out.

Title:

"Saturday you surely know,
To the market I must go.
Dollie goes along with me,
So I'll have some company."

Scene 24: Front porch of home. Medium shot of girl dressed for an outing. She is placing doll in doll carriage and arranging the covers.

Scene 25: Closeup of hands tucking doll beneath covers.

Scene 26: Back to scene 24. Girl starts walking

• Continued on Page 307

• To make the title cards above fit larger titlers, they may be cut out and pasted over cards of proper size cut from black or dark patterned paper.

Authored by
MAURIE WEBSTER*
Photos by C. E. Bell



Adding sound? Try these simple SOUND EFFECTS!

HOME movies are starting to talk! That voice of moving pictures, discovered but a few years ago, has brought about development of simplified sound systems, home recording machines, "talking title" outfits and, more recently, the combination radio-phonograph recorder, until it's only natural that every home movie fan wants to add sound effects to his films.

If you've cherished the thought of making the horses in your movies actually go cloppety-clop, duplicating the noise of a fire or putting a first-rate crash into your favorite home movie epic, but gave up because it seemed too complicated—take heart! It's really easy!

Talking with the young wizards who produce the myriad of sounds at the famous Columbia Square studios of CBS in Hollywood, we learn that theirs is the second largest sound effects department in the world! And for the benefit of home movie makers interested in adding sound to their films, they recently demonstrated several good "kitchen" adaptations of their best effects—those which the average amateur would be most likely to use. In the photos on the opposite page, the wizards referred to—Harold Lindquist and James Murphy—are pictured demonstrating some of the sound effects easily within the scope of any amateur to produce.

Horses' hoofs are a popular sound which may be duplicated with exceptional realism with a pair of ordinary paper drinking cups pounded in "horse rhythm" in a box of gravel or on a table top close

*Originator and president of CBS's "Columbia's Camera Club of the Air."

to the microphone. To imitate footsteps, just place the "mike" near the floor and step up and down with leather-heeled shoes. Squeezing the straw of the kitchen broom will produce the sound of walking through heavy underbrush.

For the numerous odd sounds so often desired, the dime store will supply an assortment of whistles. The type for imitating a steamboat whistle may be obtained from the average music store in the orchestral equipment department.

Realistic crash effects may be produced economically by crushing ordinary berry boxes close to the microphone. With a little practice one can simulate the breaking in of a door or the crash of a skyscraper.

One of the most intriguing of the CBS sound effect devices duplicates a small army on the

march. It isn't complicated for the average amateur to build, either. Just a group of wooden blocks $1\frac{1}{4}'' \times 1\frac{1}{4}'' \times 8''$ suspended from elastic bands in a movable frame. Raised and lowered rhythmically on a piece of cellotex, they produce the sound of marching feet.

For that snow picture shot last winter, a box of cornstarch from the kitchen squeezed close to the microphone gives an ideal effect of the crunching sound of feet treading through snow. For those scenes where the rolling surf pounds the shore, take the lid of that suitcase in which dad's summer suit arrived, toss in a handful of buckshot, and everything's set for a roaring surf effect. Tilt the box slowly near the microphone as shown, and let the shot roll slowly from side to side. It may take a little practice to produce the perfect surf sounds but it's the experimenting that makes sound effects so much fun.

HE probably doesn't look it, but the fellow pictured crinkling the cellophane near the microphone has just started a roaring forest fire—at least that is the way it will sound coming through the loudspeaker. If the sheet of cellophane had been one-fourth the size and crumpled gently nearer the "mike," even a chef would swear it was a skillet of bacon and eggs sizzling over a stove!

Besides the effects pictured, there are hundreds more, of course. One of the most versatile of sound effects gadgets is an ordinary basketball bladder. With a teaspoonful of shot poured inside, then

• Pictured above are the sound wizards of CBS's Hollywood studios—James Murphy and Harold Lindquist—handling sound apparatus for a New Year's celebration sound effect. An assortment of whistles are blown while Lindquist imitates sound of gunfire by whacking cushion with flut stick.



The crunch of snow beneath feet is reproduced most realistically by James Murphy by merely squeezing a pockage of cornstorch near the "mike."



The rhythmic roll of surf may be imitated by gently rolling from side to side a large box-top filled with buckshot, as demonstrated by Harold Lindquist.



Crackling of fire or frying of a broce of eggs is reproduced with startling realism by slowly crinkling cellophone close to the "mike."



Just a pair of paper drinking cups are all one needs to produce the sound of hoof beats. Here, Murphy's pounding 'em in horse rhythm in a box of gravel.



An aid berry box crushed before the microphone doubles for the crash of a barricoded door or the collapse of a building. Effect depends upon distance from "mike."



Footsteps are imitated—strongly enough—by footsteps, with the microphone close to the floor. For effect of person walking through brush, the strow of a broom is squeezed near the "mike."



MOVIE of the MONTH

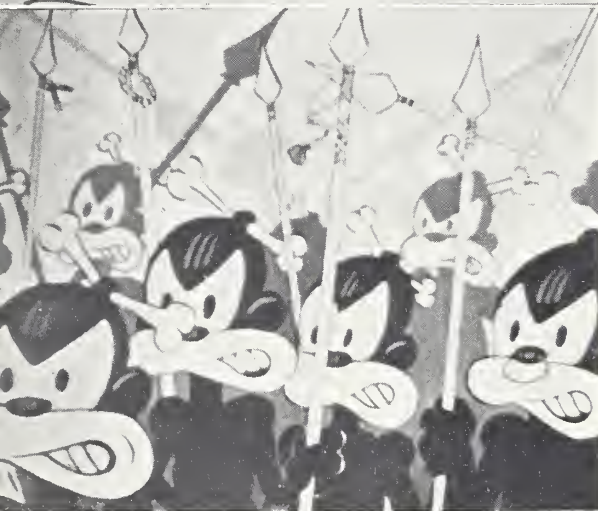

Reported by
J. H. SCHOEN

IN his first successful attempt at animating cartoons, Walt Disney never turned out a better job than "Peetie"—a 16mm amateur cartoon film from the home workshop of Edmund Turner, known to most of HOME MOVIES' readers as the artist who turns out those swell title backgrounds that appear in this magazine each month.



The fact that Turner is a commercial artist by profession in no way affects his status as an amateur movie maker. He may be a leg up on some of his cinebug brothers because of his ability with pen, ink and drawing board, but no less true is the fact there are hundreds of other artists among cinefilming hobbyists who have yet to taste of the fruits of combining their profession with their movie making hobby.

It is not Turner's art work alone for which his film "Peetie" has been chosen the Movie of the Month. Rather it is the

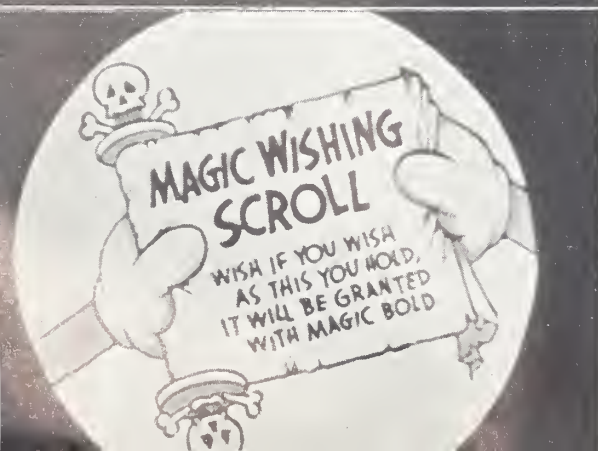

• Continued on Page 302

Authored by
ROBERT E. BROCK

For novel and variety titles, build this vertical MULTI-PLANE TITLER

HERE is a vertical titler capable of making a variety of title styles as well as serving admirably for animation work. While the one illustrated was constructed for a Filmo "8," this same type of titler is adaptable to all makes of cine cameras.

Alignment of title card with camera is accomplished through the camera viewfinder, and the matter of parallax is taken care of by a novel arrangement of the camera support which may be shifted diagonally in the guides shown in Figs. 2 and 3.

The table or titler stand is designed on the principle of the tripod because of its inherent stability, and also because three legs do not interfere as much with lighting as four. Note that the table top and the shelf (or middle plane) have rectangular openings cut in them. These openings are large enough to have their boundaries beyond the camera lines and an imaginary vertical line drawn from the center of the camera lens would pass exactly through the center of each opening. Thus, the floor, the middle shelf, and the top are each usable planes on which title cards may be placed.

The dimensions that will follow here are for a titler for the Filmo "8" as illustrated. The table top stands 34" above the floor. The camera-mount supports the camera rigidly with the lens 6" above the table. A distance of 8" would be more practical for typewritten titles and would enable using the title backgrounds published each month in HOME MOVIES. The middle plane is 20" from the camera lens and the floor—a distance of exactly 40".

If your camera is equipped with a universal or "fixed" focus lens, then you will need the following auxiliary or "supplemental" lenses as a part of your titler equipment for use in shooting titles at the distances already described:

6" distance	6.7 diopters
8" distance	5.0 diopters
20" distance	2.0 diopters
40" distance	1.0 diopters

Absolute rigidity of the titler is important. The legs should spread outward at 15 degrees or more from the vertical in order that they be well beyond the camera lines, as well as making for rigidity. The rectangular opening in the table top measures 3" by 4", and in the middle shelf, 7" by 9".

The camera carriage may be made from lengths of strap iron or brass rod. As the construction will differ for each make of camera, we shall assume that the illustrations will be sufficient guide for those who wish to build this unit, and dimensions, therefore, will be dispensed with. Details for arriving at the angle at which to place the two clips which control movement of the camera carriage follow:

Lay a straightedge over the opening in the table top, parallel with two of the sides, in such a way that one of its edges passes through the centerline of the opening. Next, fasten the camera to the camera mount, and then while sighting through the rangefinder, move the mount to a position that places the straightedge parallel to boundary of the visible field and with the centerline of the opening in the exact center of this visible field. To locate this center accurately, the straightedge should be rotated 90 degrees and the same operation repeated.

WHILE the mount is in this position, check and see that the centerline of the opening in the middle plane is in line with the opening in the table top. Locate the exact position of the mount on the table top. Then move the mount in the direction and distance of the parallax in your camera. In the instance of the Filmo Double Eight, this motion will be exactly 1-5/32" at an angle of 57 degrees with the long way of the rectangular opening. The movement of the camera mount must be identical at all points, in order that the camera be held in alignment at both positions.

Next, install guides on the camera mount that will facilitate the shift from one position to the other. Careful examination of illustrations 2

• Continued on Page 297

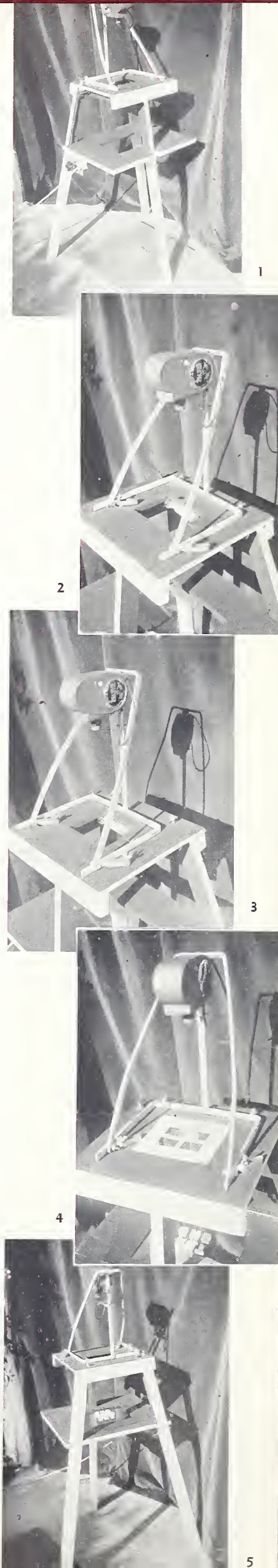
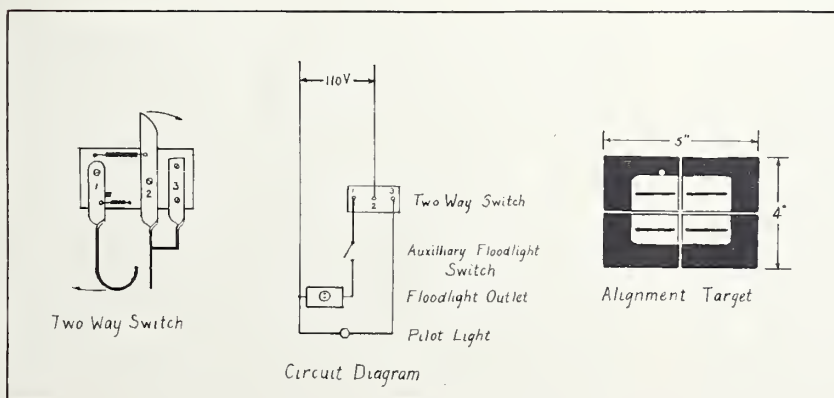

• The closeup views at right illustrate method of aligning and using this novel titler. An innovation is the automatic light switching device described in sketch at left.

Authored by
PAUL F. STACY



Wide World Photo

"BOMBS OVER EUROPE"

filmed during "blitzkrieg!"

THE explosions came . . . first in Denmark and Norway, then in Belgium, Holland, Luxembourg and Switzerland, to be followed by the greatest activity the Western Front has seen, by the strafing of the British Isles, by all the incidents that have crowded our front pages with type of a size to frighten a peaceful people.

And with it all came also a "blitzkrieg" movement on the part of the Castle Films' staff to secure footage of the most important current European events for their latest film release, "Bombs Over Europe."

Continual touch was kept with foreign agents. Word flashed that film was exposed successfully at Narvik, in Oslo, in Copenhagen, then at the Hague, at Brussels, at this and that focal point where action spelt danger to the intrepid men whose only weapons were their cameras, whose bodies were as fair targets for fire from land, sea and sky as those of their combatant companions.

Once the assurance arrived that film had been taken, then came the suspense as to how and when, through boards of censors and embattled lands, these precious footages were to reach American shores. Scouring, conniving, using the wits of super-men, these agents abroad contrived to get the film to Atlantic ports, and then, aboard ship but more often aboard a Yankee Clipper, to be flown in a day's time to the awaiting American public.

But, with its arrival, the job is only begun. True enough, cameramen and agent have done their part, only to rush to new scenes of carnage for later shipments.

Every foot of exposed film is screened. Every

foot is judged by a board of editors as to its relative importance in what must be a single reel of 16mm or 8mm film. Mr. Castle expresses his considered opinions, and they are not expressed lightly as he has edited close to a dozen similar pictures that now are library treasures for the historian and home movie collector.

Then his expert cutters go to work. This bit of naval action, while beautiful photographically, is omitted while that shot of a mighty fjord on the shores of which a warship rams itself to become a helpless derelict, is retained. Cities—capital cities of proud and ancient kingdoms—occupied in the light of early dawn; yes, they must be a part of the picture, for they are history in the making. Planes in action, planes in distress . . . yes, they, too, belong. Destroyers ploughing through mine-laden waters . . . troops landing . . . troops in action, whether aggressor or defender . . . they also are "cut in." Buildings burning from aerial bombs, whole cities turned to shambles . . . the order comes to cut them in.

And so it goes through thousands of feet of headline news, this, that and the other shots being selected from among the many for splicing and assembly into an experimental single reel.

THE footage reels off . . . from fjords to dikes . . . from raging straits to mountain passes . . . first in one nation, then in another . . . men of war at war, their uniforms changing but their missions the same—aggression, destruction, defense. With kaleidoscopic variety, the scenes shift as war's terrible drama thrusts with lightning speed from Denmark and Norway, from Skaggerak and Trondheim, from Narvik's wreck-strewn harbor, and from Oslo to Rotterdam and Brussels, to Antwerp and the Hague. Sturdy, valiant Belgians, defiant Hollanders take their stand in face of storming invaders. Here the film shows the

• Continued on Page 307

• And after the "blitzkrieg" the big job was to get the films through the censors. But Castle did, and they have a fine movie record of the current conflict that includes many scenes of big guns belching death and destruction.

Wide World Photo



Authored by
 GEORGE W. CUSHMAN
 Illustrations by Author

A MAIN title with an appropriate background is the proper beginning of any film. Since motion is the movie camera's greatest asset, there is no reason why some movement, within reason of course, shouldn't appear in this background.

Many an amateur has given his films a professional send-off by a properly executed lead title of this type. It matters little whether the equipment is 8 or 16mm, for titles with moving backgrounds are easily produced with either.

There are several ways of producing these



sufficient depth of field to render the background clear and sharp.

This can be corrected somewhat by closing down the lens as far as possible, thus resulting in a greater depth of field, and also by using as large a piece of glass as possible. With a large glass, the distance from camera to title is greater, thus put-

BACKGROUNDS IN MOTION *pep up titles!*

effects, but first it might be well to consider for a moment the types of moving backgrounds most suitable. As a rule, action which is constant and massive is preferred to any other kind. For instance, the mountain stream pictured on this page is an ideal example of constant, massive action. There is plenty of motion, yet it is not of a distracting type.

Contrast this with the Christmas morning scene with the two boys playing with their new gifts. The action here is unified and the eyes of the spectator will prefer to watch the actions of the youngsters rather than the wording which is super-imposed upon it.

Excellent examples of constant, massive motion are scenes of running water, including huge ocean waves breaking against the shore, crowds and scenes containing many units, such as packed grandstands, busy streets, etc., scenes of the sky with moving clouds, tree branches, etc. Luckily, too, these scenes are not difficult to obtain.

There are many ways of obtaining titles with moving backgrounds, and each has its own advantages. Probably the simplest and easiest method is pictured on this page. The title is lettered with white ink, paint, or other similar material upon a piece of clear glass, plate glass being preferred since it gets away from any unevenness in the glass which might be present.

This glass is now set up in front of the camera with the desired background in the rear. As the camera runs, the title and background are being exposed in one operation. The background will probably be out of focus, since the camera lens is focused on the title and there will probably not be

ting the glass and background nearer the same plane and resulting in a sharper background.

Also, by employing the use of the hyperfocal distance in such cases, the background can be made to stand out quite clearly.

A second method which will give better results is through double exposure—the scene and the title are exposed separately on the same piece of film. In this case the title should be made with white letters on a very black background. Flat black paper can be used but for excellent results, deep pile cotton velvet is much better. The lettering is, of course, done in white. With the velvet, pin or wood block letters can be used. Or, the title can be painted on glass with white paint and this placed over the cotton velvet.

THE minimum amount of exposure necessary to render the letters a good clear white should be given. A stop of F. 11 on par speed film in the direct sun should be about correct. With the paper titles, care must be taken to see that there is no light reflection, since this may cause the background to appear gray on the screen. After the exposure is

• Continued on Page 300

• Top photo shows method of shooting title and moving background simultaneously. Title is lettered on glass and placed in front of camera before scene to be used as background. Bottom—Two illustrations of titles made by this method.

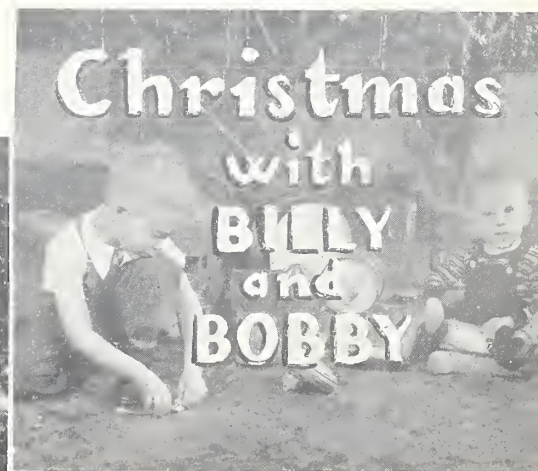
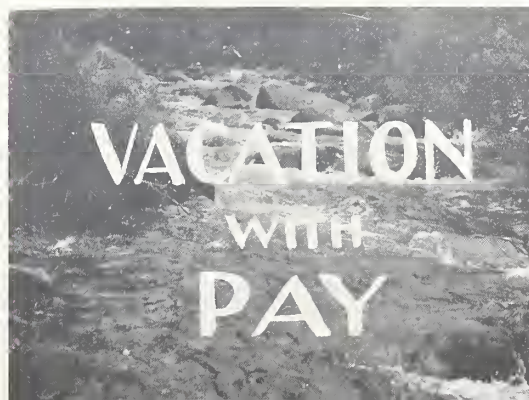

TITLE CENTERING GUIDES

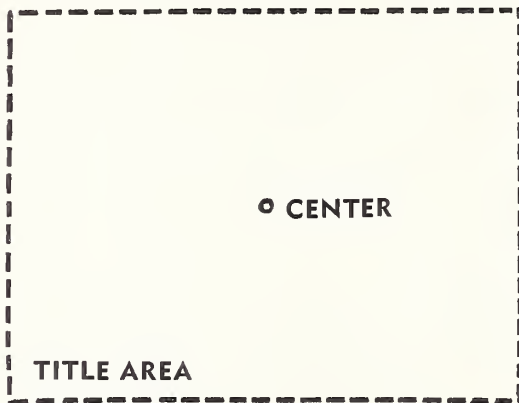
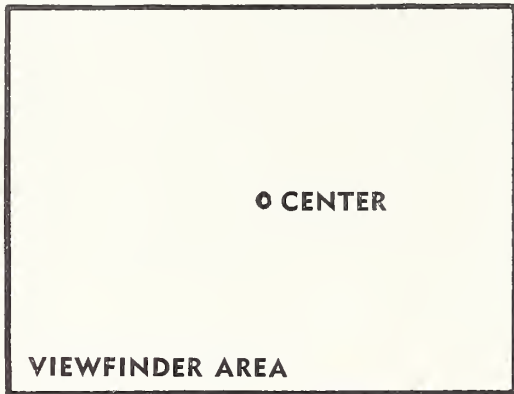

For Cine Kodak "8"
Models 20, 25, and 60.

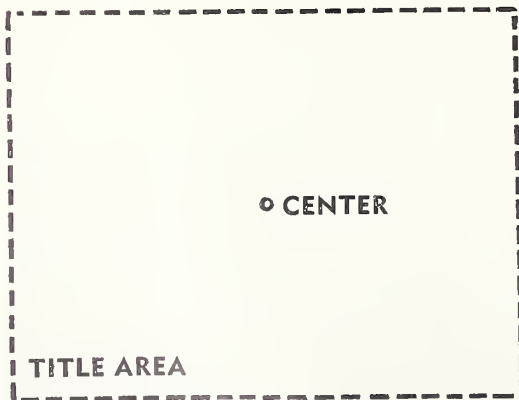
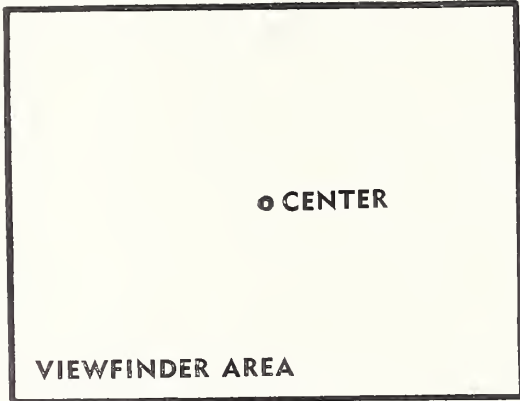

For Magazine Cine Kodak

PROBABLY the greatest single factor retarding the average amateur's progress in filming his own titles is the problem of lining up the camera accurately with the titling board. Many are the ways and means devised to simplify title alignment, but even in some of the title makers marketed commercially, this factor has not been entirely simplified.

After a great deal of research, the editors of HOME MOVIES believe they have found the most ideal, simple method of aligning cine camera with title card and without the aid of a titler, if necessary. The method requires that one know the exact measurements of the difference in the parallel and vertical centers of the camera lens and viewfinder. With such dimensions, rectangles are drawn corresponding to the field covered by the lens and that covered by the viewfinder, on a plane eight inches away from the camera lens.

Sighting through the viewfinder of the camera, which has been set up before the rectangles at the required distance (and this applies also where a titler is used), the camera is moved until the viewfinder area is lined up with the rectangle on the centering guide representing the viewfinder field. This done, the camera lens is automatically centered on the title card. It's as simple as that and dependable.

Beginning with this issue, HOME MOVIES will publish each month a set of title centering guides for one or more popular makes of 8mm and 16mm cine cameras. The guides on this page are for several models of Eastman Cine Kodaks, as indicated. While these guides are drawn to fit most of the popular typewriter titlers, they may be expanded, with the aid of pencil and ruler, to work effectively for lining up the camera with title cards of any size.

For example, to convert either guide for use with 9"x12" title cards, lay the guide on a large sheet of drawing or wrapping paper and expand the size of each rectangle to 9"x12", using the "center" point as a basis to work from.

For those readers who may be interested in the exact offset measurements of the models of Cine Kodaks for which the guides on this page are drawn, we publish them herewith:

Model	Finder Above Camera Lens	Horizontal Offset
Cine Kodak "8," Model 20.....	2.196"	.080"
Cine Kodak "8," Model 25.....	2.196"	.080"
Cine Kodak "8," Model 60.....	2.188"	.096"
Magazine Cine Kodak.....	2.511"	.347"

Title centering guides for other cameras will appear in the July and subsequent issues of HOME MOVIES.

Authored by
WALTER W. LIGHT
Illustrations by Author

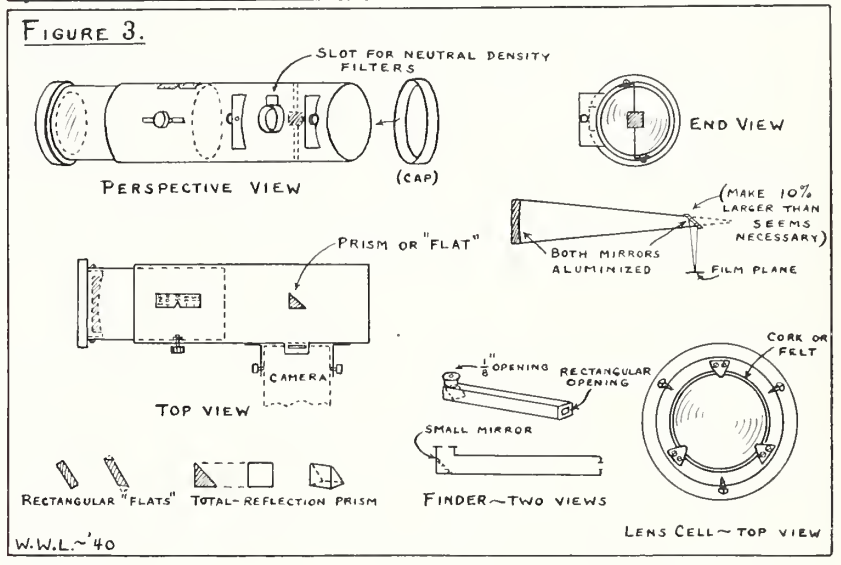
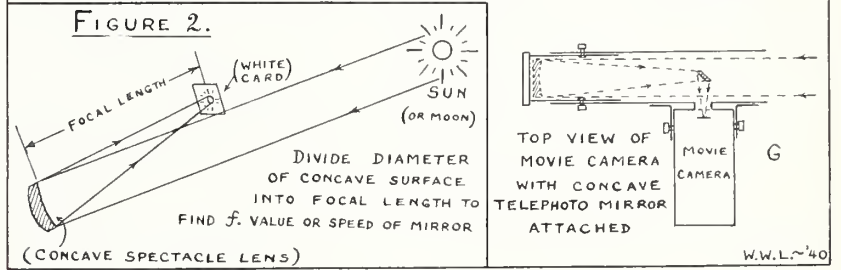
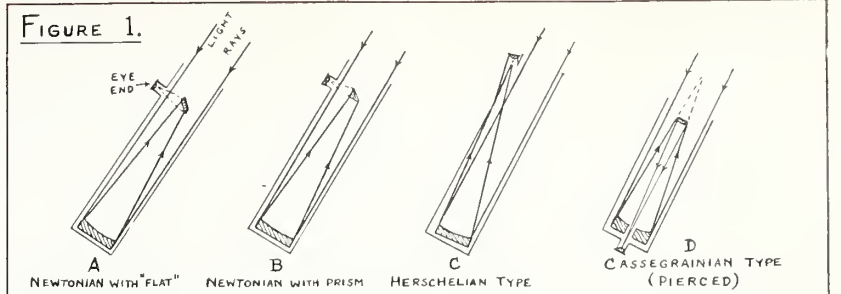

MANY inexpensive telephoto lenses have been devised from binoculars, spectacle lenses, projection lenses, etc. Reasonably good results can be obtained with these under favorable light conditions. However, there are many limitations to telephotos of this type.

Nevertheless, there is a way to construct fast, perfectly-corrected telephoto lenses of any focal length and speed you may desire, and it can be done very reasonably. The principle involved is the

A telephoto lens any AMATEUR CAN BUILD

same as is used in parabolic reflecting telescopes, such as the one nearing completion for Mount Palomar in Southern California.

A concave mirror has the property of forming an image by reflection, the same as a camera lens or reading glass does by refraction. But since the light rays do not pass through the glass there is no chromatic aberration; and only one surface is needed to form a perfectly corrected image, both photographically and visually. Standard telephotos have at least three to six elements of special optical glass—therefore, six to twelve optical surfaces have to be computed and figured.

In Fig. 1, the sketches A to D illustrate the theory of various forms of reflecting telescopes. A and B represent "Newtonian" type telescopes. Thousands of amateur astronomers in recent years have made their own instruments, mostly this type. This is the design which is easiest and also best suited for constructing 8mm and 16mm telephoto lenses. C shows the "Herschelian" type. Only one reflection is needed but slight astigmatism is introduced because of the tilt of the mirror required to bring the rays to the eye-piece, which is simply a short focus positive lens to further magnify the image formed by the concave mirror. Professional eye-pieces have two to four elements, however.

Fig. G shows a small Newtonian-type telescope lens fastened to a movie camera for telephoto purposes. A small flat mirror or right angle total reflection prism reflects the cone of light rays to the film—the camera lens having been removed.

Notice that there is another big advantage to using a reflector type telephoto—the camera is always pointed at right angles with the subject, a big help in taking candid movies. But enough for theory—now for the practical part.

THE important part of a telescope-telephoto lens will be the convex, lens-like reflecting surface. This may easily be made from a lens from a pair of reading spectacles such as you may purchase from any five and ten cent store. For experiment purposes, it is advisable to purchase at least two pair with lenses of different dioptré size. Be sure the lenses are of the spherically concave type—that is, one surface will be concave, differing from the type that is flat on one side and convex on the other.

Next step is to "silver" or "aluminize" the concave surface of the lens, transforming it into the reflecting mirror that will reflect the object directly into the secondary objective and then into

• The principle of simple reflecting telescope construction may be applied in making a very effective telephoto lens for cine cameras. Necessary materials are easily obtained and the entire lens may be put together by any amateur, according to Walter Light.

Authored by
VICTOR H. WASSON

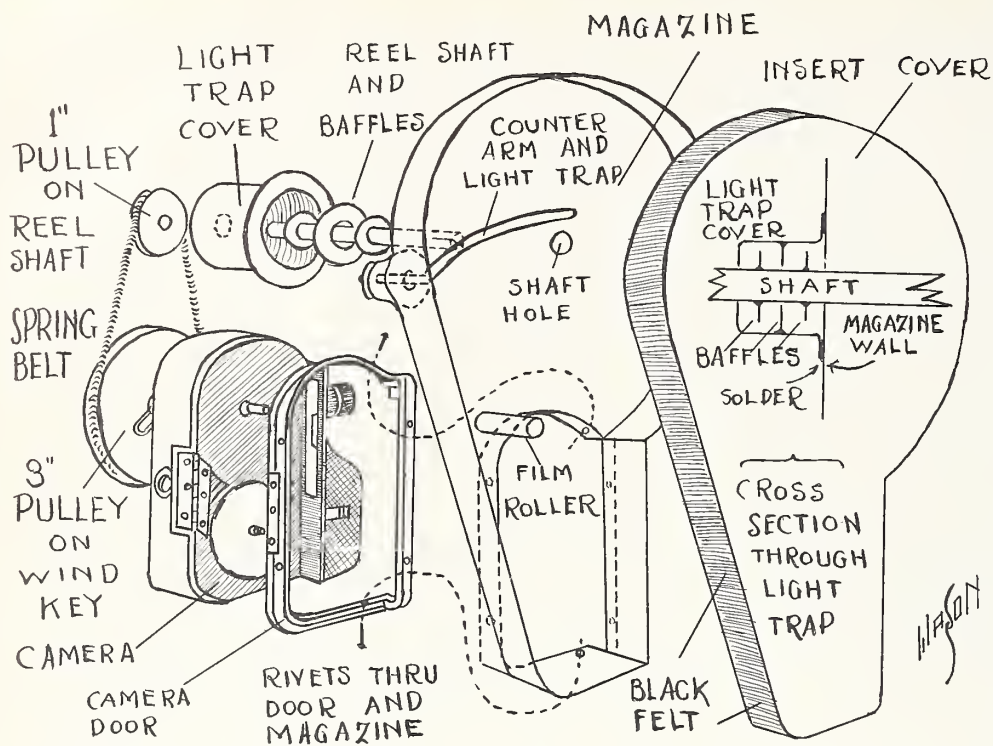

Amateur builds 200 foot 8mm FILM MAGAZINE

AMATEUR cinebugs who like to cut up will be interested in this experiment for increasing the camera's film capacity beyond the usual 25-foot roll of single 8mm film.

After much experimentation and "test block" operation with spools of various sizes, it was found that by the addition of a few non-complicated parts, the camera could be made to roll a 200-foot reel as easily as the original 30-footer. And this was accomplished without touching the internal mechanism of the camera. Those who must experiment can pick up a Univex very reasonably and try their skill in this reconstruction job.

The trick is to hang the new magazine on the door, so that the camera itself is not defaced. Replacement doors are available from the manufacturer at 75c each. So, when trade-in time comes, you simply switch doors and no harm's done. You'll be less anxious about this, though, after you've used your converted model.

The actual construction requires no special materials nor tools, and while the work should be done neatly and accurately, there is no reason why anyone who can handle a soldering iron and average tools should experience any difficulty.

The first step is to cut the side out of the replacement door. The metal will be found soft enough to work with a hacksaw blade held in the hand. Make your cut just inside the beads that are moulded around the top, back and bottom. The

cut along the front edge is made just back of the flat spot that takes the door catch, thus leaving a strip about one-quarter inch wide. Cut slowly and accurately without forcing. This metal is known as "die cast" and will snap if subjected to undue strain.

When the side is lifted out, you will have left a door frame, embodying the light trapping channels that fit against the camera. Open the camera and lay the door back. Place the door frame against the camera and examine to be sure that your cutting operations have not bent it out of line enough to cause light to enter around the channels. Slight discrepancies in alignment can be corrected by gently bending the frame in the hands; do not use tools.

Now we're ready to build the 200-foot magazine. Place the door frame, camera side down, on a piece of cardboard. Also on the cardboard and immediately above the door frame, place a 200-foot projection reel. Draw a line around both door and reel, and also draw a line around the inside of the door frame. Set the door and reel aside and draw a one-inch-wide border around their outline and cut out with scissors. Also cut on a line drawn one-quarter inch inside the line delineating the inside of the door frame.

Mark out this pattern on a piece of lightweight galvanized sheet metal and cut out with tin snips.

Now scribe a line one-half inch inside the edge of the metal and, working with pliers, bend the metal up at right angles all around, following this line, except where the front edge of the door runs off the pattern. This section will be cared for by the magazine rim to be described shortly.

WHEN this bending operation is finished, you will have a one-half inch high fence all around the magazine side except where the front edge of the door occurs. This fence will be one-half inch bigger around than the 200-foot reel.

Now lay the door frame on the sheet metal so that its outline is concentric to the opening in the sheet metal. Scribe a line around the inside of the frame. That will leave you a one-quarter inch border around the opening. Bend this border down in an opposite direction to the fence at the edge. This should be done so that the fence thus formed will fit snugly inside the door frame.

Slip the magazine side in place inside the door frame and secure it by drilling four or five holes at various points around the frame. Use a No. 80 or other very small drill and go clear through the door and the metal of the magazine. Then insert

• With a few simple tools, sheet metal and solder, this amateur enlarged the film chamber of his 8mm camera to take 200-foot rolls of film—and without altering the internal mechanism of the camera!



TELL ME — *how can I improve my film?*

SOOMETIMES even your best friend won't tell you what's wrong with your film. One may go on indefinitely making the same mistakes or overlooking the little improvements that would otherwise elevate a film to the point where it will stand the test of even the most critical of cine cliques. But for those really interested in improving filming, editing, and titling technique, there is a friend indeed who will give every friendly assistance — HOME MOVIES. Every amateur who shoots home movies, whether he is a subscriber of this magazine or not, is invited to freely submit any or all of his films to the editors for review and helpful criticism.

Each month, the best film submitted for review is chosen as the "Movie of the Month" and a special review is devoted to it in the pages of HOME MOVIES. Before the film is returned, a special "Movie of the Month" leader is attached. Also, a handsome certificate indicative of the "Movie of the Month" award is sent the producer.

The reviews published below may contain pointers that will aid you to step up your movie-making skill.

PARENTS BEWARE

400 ft. 16mm Kodachrome — By W. R. H.

★★★

Continuity: This cinefilmer and his wife conduct a private school for children from which he was able to draw upon for his acting talent. But he used a simple story, the sort any amateur could work up with a few children and friends as actors.

The picture opens with a little boy and his sister playing with their toys on the living room floor. Mother is nearby, preparing to go out. Just as she is about to leave, a neighbor arrives with her two children — a boy and a girl of about the same ages as her own. The two mothers go shopping together, leaving the children alone to play together.

Shortly after the mothers leave, the youngsters conceive the idea of playing "dressing-up" with their parents' clothes — an idea that comes to one of them after looking at pictures in a style magazine. The girls, garbed in evening gowns, parade

as mannequins before the boys, who have donned tuxedos. Some intimate close-ups show the boys "putting on airs" — smoking father's cigars, and reading and discussing the stock market reports.

Before leaving, the mothers reminded the children they would return at five o'clock; so, as the hour approaches, the children hastily remove their parents' clothes and return to playing with toys on the parlor floor. One of the boys inadvertently drops the collar of his tuxedo outfit, while changing clothes, and this remains to give them away when the parents return. The youngsters receive a scolding, the visiting mother departs rather abruptly with her son and daughter, and the other two are sent to bed. The picture closes with close-ups of the boy moving in his sleep, tugging at an imaginary tight collar about his neck, and of the girl — also asleep — going through the motion of using a lorgnette. The mother sits in the living room, contemplating the kiddies' escapade, and breaks into a smile as she realizes it was all in fun.

Editing: Is very well done throughout. The entire picture was filmed indoors, placing some limitation upon the camera. Nevertheless, good pace is maintained with cutting back and forth from medium to close-up shots, which greatly enhanced the interest.

Titling: Titles were very good, nicely exposed and worded.

Photography: With but few exceptions, the photography was very good. Once or twice there were shots slightly out of focus. The exposure was good and the camera set-ups satisfactory.

CRADLE OF THE MOVIES

400 ft. 16mm Kodachrome — By A. B.

★★★

Continuity: While the brunt of the continuity of this picture rests entirely upon the titles, nevertheless this is a very interesting picture. It is a documentary of the region

• Continued on Page 299

Reviews by
THE EDITORS

• Top photos — From left to right: Scenes from "Cradle of the Movies" and "Parents Beware!" — two fine 16mm Kodachrome films. Below: Closeup from "The Lady on June Street," Leo Colloia's 8mm film.



THE EXPERIMENTAL

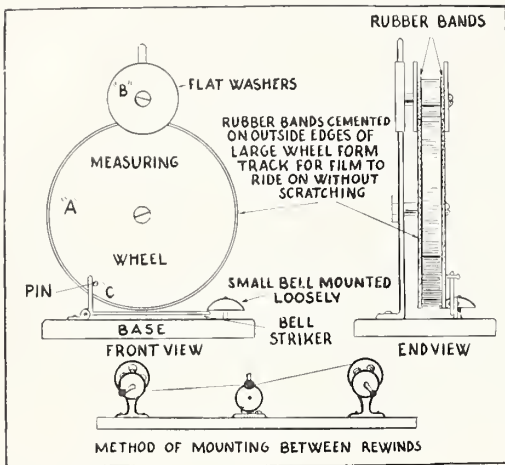

Film Footage Counter

The accompanying sketch shows a novel film measuring device which will prove especially handy to amateurs who load their own camera spools with bulk film. It is highly practical for spooling film in the dark, as a small bell is provided that rings each time one foot of film passes through the device.

The large measuring wheel is turned on a lathe and when finished should be $\frac{5}{8}$ " thick and 3.8" in diameter. The addition of two flat rubber bands cemented to the surface of the wheel on either outside edge provide a track for the film and increase the wheel's diameter so one complete turn represents one foot.

The wheel is mounted on a strap-iron bracket as shown and the entire assembly mounted on a wooden base. The wheel should turn freely but must not wobble. The small rider wheel "B" slides up and down on the strap-iron support and serves to hold the film in place. It may be made of a section of $\frac{3}{8}$ " or $\frac{1}{2}$ " metal tubing—just a trifle over $\frac{5}{8}$ " long—with flat metal or fiber washers fitted at either end. Rubber traction strips are cemented to this wheel, also. The rider assembly should be sufficiently heavy to exert enough pressure on the film and prevent it from slipping over the wheels.

A small brad is driven into the larger wheel, as shown at "C." This strikes the bell clapper with each revolution of the wheel.

— L. W. Hills.

CINEBUGS!

• If you have an idea for a gadget, trick, or shortcut in filming, titling, editing or processing home movies, pass it on to your fellow Cinebugs through these columns. If your idea is published you will receive two reels for your efforts. Extraordinary ideas will net you a roll of film.

Ideas not published will be held for future publication unless they duplicate ideas previously received. Endeavor also to send along photos or rough sketches illustrating your suggestions. There is no limit to number of suggestions you may submit.

Names and addresses of contributors of published ideas are furnished a prominent manufacturer interested in acquiring rights to saleable gadgets on a royalty basis.

Important: When submitting ideas, be sure to mention whether equipment you use is 8mm or 16mm, enabling us to promptly forward owords adoptable to your use.

Color Titles

Here's a tip for those amateurs lettering their titles with a typewriter and who wish to inject a variety of colors into their titles for Kodachrome films. Purchase a number of typewriter ribbons of various colors—blue, green, red, brown, etc. Cut a short section from each and sew them all together into one single ribbon. Thus you will have a typewriter ribbon composed of several colored sections.

When lettering titles, you can type the first line in one color, the second line in another, and so on. Or, you can type each title in a color to harmonize with the color of the Kodachrome scene it is to precede in your film without having to change typewriter ribbons each time.

The stitched splices may cause a little trouble in passing through the ribbon guides on some typewriters but, on the other hand, this difficulty will also serve as a check against one color section passing beyond the typing point unnoticed. With a little care, the splices may be "eased" through the guides.

— Verlin L. Cochran.

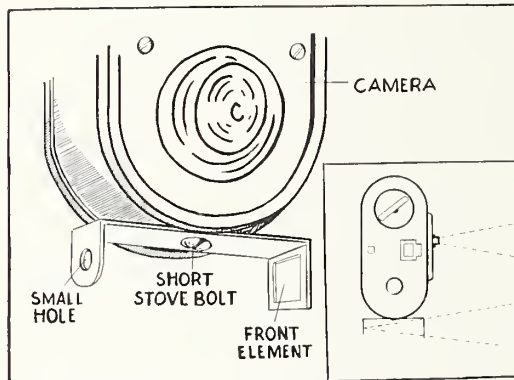

Shooting Over Their Heads

Often when filming sporting events among crowds, or making pictures in theaters or in crowded circus tents, I had trouble keeping my camera lens above the heads of those standing in front of me, and my scenes invariably had a sea of bobbing heads in the foreground. The accompanying drawing shows an auxiliary viewfinder which I made to remedy this trouble. It is made from a strip of thin metal and attached beneath the camera, enabling me to focus on the scene with my camera raised sufficiently above the heads of people in front of me. Due to the increased parallax, the finder is not for closeup use. When constructing it, the field area for the front element should be the same as that of your regular camera viewfinder.

— Martin Alger.

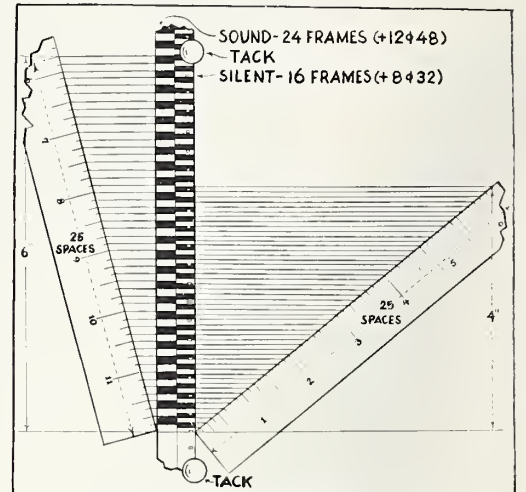

For Checking Film Speed

Occasionally checking the film speed of one's camera will insure uniform exposures at all times, and one of the most accurate methods of doing this is by means of a stroboscope which any amateur may make with a strip of white film leader, a bottle of india ink, and a ruler.

The finished stroboscope strip is shown in the accompanying photo, and the sketch shows the manner in which the black lines are calculated for both 8mm and 16mm films. The following chart gives the linear speed of 16mm film in feet for the various standard frame speeds and the number of lines required per inch:

Frame Speed	Feet Per Minute	Lines Per Inch	Inches Per 25 Lines
8	12	12-1/2	2
12	18	8-1/3	3
16	24	6-1/4	4
24	36	4-1/6	6
32	48	3-1/8	8
48	72	2-1/12	12
64	96	1-9/16	16

This gives a fractional dimension, so, to make possible more accurate spacing, this figure has been transposed to the number of inches used per 25 lines.

Probably the easiest method to put



the black and white lines accurately on a strip of film is to lay out the film on a drawing board as shown in the sketch below, using a ruler as shown to determine spacing of lines. After lines have

C I N E W O R K S H O P

been sketched on the film, they may be filled in with india ink. The stroboscope strip is then spliced in a loop and threaded into the camera.

By using a small Neon lamp (obtainable at most electrical stores) and suspending it from a cord within the camera as shown, the camera is started. As the film rotates, the black lines should appear to remain stationary if the camera speed is accurate and constant. If the lines appear to travel forward or backward, adjust the camera speed set screw until they appear stationary. Current used for lamp must be 60 cycle.

As the theory of the stroboscope may not be familiar to all, it may be well to explain something about its function. As the electric impulses of ordinary 60-cycle current pass through the Neon lamp, the lamp flashes off and on at the rate of 60 times per second—a speed imperceptible to the eye. When the stroboscope passes before the lamp at normal speed, the intermittent flashes of the lamp make the lines appear to stand still.

—W. B. Sanford.

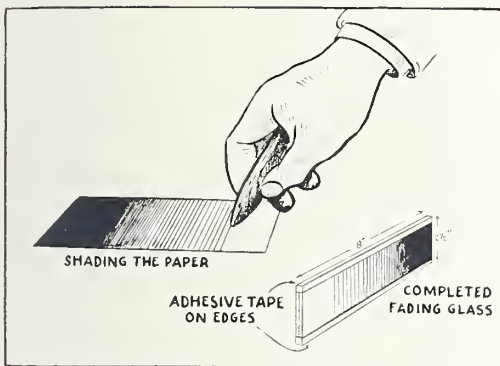

Fading Glass

Here is a simple method for making your own fading glass—one that will be more permanent than those made of smoked glass: Secure two pieces of clear window or picture frame glass $2\frac{1}{2}'' \times 8''$; a piece of black paper $20'' \times 7''$; several pieces of white chalk, and a quantity of scotch or adhesive tape.

With the chalk, carefully shade the strip of paper with vertical strokes so that when completed it will be gradually shaded from white at one end to full black at the other. If you do not own a still camera, have a friend or commercial photographer make a photograph of the paper strip on a $5'' \times 7''$ negative. Ortho film and two photofloods will produce a good quality negative.

After the negative is developed, trim the gradually shaded portion to $2\frac{1}{2}'' \times 7''$. Place it between the two panels of glass and bind on the top and bottom edges with tape. Do not bind the clear edge, otherwise it will interfere with the effect in moving this part of the glass past the lens—causing a shadow to appear on the film at this point.

The width of this glass is such that no

track is necessary to keep it accurately before the lens, and it is adaptable for use with either 8mm or 16mm camera lenses.

—Tom Tracy.

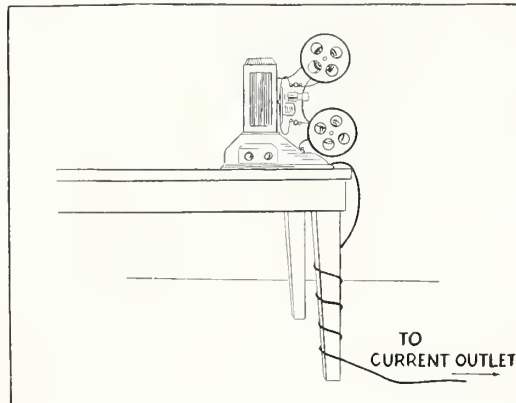

Safety For Projectors

Once, while showing movies to some friends, a newcomer entered the room, tripped on the extension cord and tipped over my projector. Now, whenever I set up my projector, I coil the extension cord around the table leg for several turns before plugging it into the wall socket.

—Chas. C. Harper.

Film Retainer

Pieces of sponge rubber about the size of a dime cut from one of the rubber mats available from most dime stores may be inserted between the sides of 16mm projector reels to keep the film from unwinding. For 8mm reels, the rubber discs may be split to necessary size.

—David S. Alexander.



Titler Lighting Unit

One of the new "bullet" type bed lamps may be converted easily to serve as a light source for making titles with typewriter titlers. With Filmo, Keystone and Revere 8mm cameras the clamp bracket may be reshaped to fit the camera case, as shown in the illustration, so that the light may be held by the camera and projected squarely against center of

gadgets, tricks and short cuts contributed by Cinebugs

title card. The unit is so compact, I found it less cumbersome than other types of lighting equipment for titling purposes. Usually, a No. 1 photoflood lamp gives ample illumination with this unit for titling purposes.

—Frank W. Truitt.

Projector Belts

Within the lids of many jars of pickles, preserves and jellies now on the market are square rubber bands. Save them, and should the spring drive on your projector fail you during a screening of films some evening, one of these rubber bands will prove a satisfactory substitute for the spring belt.

—O. J. Marcum.

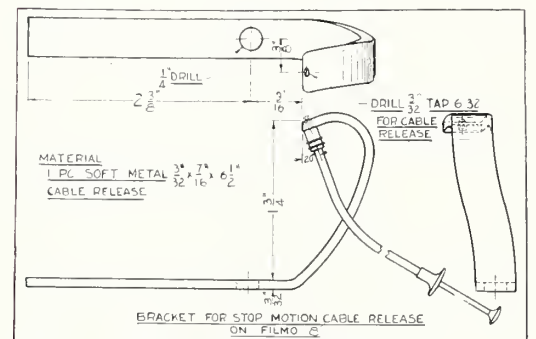

Cable Release Bracket

Although my Filmo "8" has a single frame release, I found it very tiresome to operate in making animated movies or stop-motion trick work. To remedy this, I made a simple bracket—as shown in the sketch—to hold a cable release in accurate position for operating the camera button. The sketch is self-explanatory. The bracket was made from a piece of aluminum.

—Bill F. Fisher.

So Film Won't Go Astray

Whenever I load a new film in my camera, I shoot a few frames of a card on which my name and address is printed. If supply of film permits, I repeat this, upon reaching the end of the roll. Thus if my film goes astray, it may easily be identified by examining the first few frames. As a rule, most processing stations project every film before packing it for re-shipment to its owner.

—E. M. Thornton.



1940

RULES



● Entries limited to 16mm and 8mm films. No 35mm reductions eligible. No restriction as to length or subject. You may submit as many entries as you wish.

● Transportation on entries must be paid both ways by contestant. Where return postage is omitted, film will be returned via express, collect. All entries will be promptly returned after review by judges.

● Don't wait until final week to submit your films. Send them in as soon as ready. They will be reviewed, judged, and graded and a full report of same filed for consideration at time of final judgment. Films should be available for a second review by judges at close of contest if necessary.

● All entries should be titled at least to the extent of a main title. Adequately titled films improve their standing in the contest. Professional or laboratory produced titles are permissible.

● Be sure to label your film reels and containers, giving your name and address and the title of your production.

● No entry blanks are necessary. Enclose data with entry as to camera, lens, and film used; also, state whether filters, tripod, exposure meter, and any other equipment was used. This information has no bearing on the judging, but is of interest to the editors.



● *Murray Beliz, first place winner in Home Movies' 1939 Amateur Contest, is pictured here receiving the handsome Lloyd Bacon Trophy from sponsor Lloyd Bacon, Warner Brothers-First National Pictures director. Who will be the lucky winner this year?*

EVERY man, woman or child who makes movies with an 8mm or 16mm camera, and who has never engaged in commercial movie production, is eligible to compete in HOME MOVIES' 1940 Annual Amateur Contest. Pictures may be of any length, in color, or in black and white. They must not have been filmed with a 35mm camera, then reduced.

All pictures should be titled, that is, complete with main title, descriptive subtitles,

and end title, although those with main title only will be acceptable. Remember, editing and titling play as much of a part in qualifying a film as does photography. Titles may be commercially made.

Do not hesitate to enter your film against those of more mature and experienced filmmakers. Remember, the film that captured first prize last year was the winner's first full-length movie of an every-day subject—the flowers within his garden.

YOUR LAST CHANCE

TO ENTER HOME MOVIES

AMATEUR CONTEST

CLOSES JUNE 30TH!

**Following are awards to be given Amateur-Producers
of twelve best films:**

LLOYD BACON TROPHY

Comparable in the amateur field to the famed "Oscars" awarded Hollywood picture producers by the Academy of Motion Picture Arts and Sciences, the Lloyd Bacon Trophy is the highest award attainable in HOME MOVIES' Annual Amateur Contest.

CRAIG PROJECTO-EDITOR

This is one of the finest accessories available to the amateur motion picture filmer. There's a model for either 8mm or 16mm films. Image of film is projected on ground glass right side up, enabling amateur film editors to cut scenes to the exact frame.

VICTOR MODEL 3 CAMERA

This fine 16mm camera with f/2.7 lens will produce the finest of home movie films. It takes either 50 or 100 foot spools of film, has compensating viewfinder, self-setting footage scale, 205° rotary shutter, and many other fine features.

THALMETAL TRIPOD

A handsome metal tripod complete with the "Instant-On" Thalhammer tilt-pan head. Upper leg section is made of rigid channel metal. Lower leg members are of wood and fitted with the exclusive Thalhammer Sure-Foot tips.

COMMANDER EXPOSURE METER

A revolutionary new electric exposure meter that accurately measures light on all or any single part of a picture from camera position. Gives readings to within one-eighth of an F stop. A neat, compact, palm-sized meter ideal for every picture-making requirement.

4-STAR TITLER

Features an adjustable camera base, accommodating practically every make of 8mm, 16mm and 9½mm cine camera. Aligning and centering of titles is simple and accurate. Title board is readily adjustable to accommodate small typewritten title cards or those 9"x12" in size.

12 ROLLS AGFA FILM

You can't go wrong with an Agfa film! And the lucky amateur who wins this fine prize will have a splendid stock of film with which to make pictures for some time to come! Film will be 8mm or 16mm, depending upon requirements of winner.

SEEMANN TITLER

Novel camera base accommodates practically every make of 8mm and 16mm camera. Notable is the built-in scroll title-making device and method for positive alignment of title cards with camera. Also adaptable for use with large title cards up to 9"x12".

BESBEE EFFECTOGRAPH

Provides for making 16 different framing effects in home movies. Complete outfit includes 9 different masks, 10 different shutters, 5-inch camera hood, automatic slide, tripod platform and handle.

BESBEE EDISCOPE

A complete film editing system that includes compact, dust-proof case with 40 compartments for holding separate film scenes ready for splicing; 100 film scene index cards; handy single flange rewind, and miniature "Ediscreen" for table projection of movies.

4-STAR BEADED SCREEN

A brilliant screen of extra fine crystal beads. Features exclusive soft felt backing that prevents loosening of beads by friction as screen is rolled up. Available in sizes from 22"x30" to 36"x48". Assures finest home movies screening.

4-STAR SPOTLIGHT

A miniature spotlight of many uses for the serious amateur movie maker. Spot area is adjustable. Flexible neck connects to collapsible metal stand that extends to six feet in height. Finished in brown crackle and powered by special 100-watt lamp.

"IT'S NEW TO ME"

By CINEBUG SHOPPER

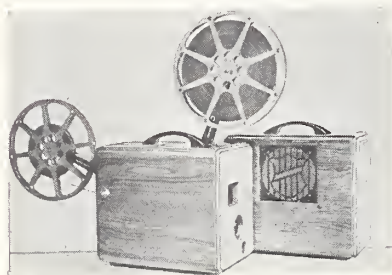

B & H Sound Projector

The Filmsound Projector, a deluxe sound-on-film model designed especially for home use, is announced by Bell & Howell, Chicago. Housed in polished walnut cases, the unit is said to be fundamentally the same as that of the "Academy" Filmsound. A 750-watt lamp furnishes illumination.

For the projection of silent films, a phonograph turntable, also in walnut cases, will soon be available. This unit is plugged into the Filmsound and accompanying music or sound is heard from a speaker near the screen when silent pictures are shown.

DeJur "Critic" Meter

The patented "louvre" feature of the new DeJur "Critic" electric exposure meter enables the meter to see only what the camera lens sees. Sensitivity is said to range from .1 to 4000 foot candles and film speeds from .3 to 800 official Weston. It also provides for a range of shutter speeds from 60 seconds to 1/2000th of a second. Other features are the single scale, and the one piece plastic case.

New Cine Film

Consumer Film Products of New York are placing on the market their new film, which for the time being can be bought only from their main office at 1 Park Avenue, New York City. This film has been in use in several eastern locations for some time and the manufacturers feel it is now ready for national distribution and usage.

Connected with the Labora-

tory Department of Consumer Film are ten experts who are thoroughly experienced in every phase of processing film, according to Consumer Film Products.

Cine Kodak Guide

A universal Cine-Kodak Exposure Guide, furnishing quick data for all 8 and 16mm Cine-Kodak films, black and white or Kodachrome, which will be a part of each new Cine-Kodak, is announced by Eastman.

It is a satin-chromium plate with movable dial and retain-



ing grooves for small insert cards—one card for each type of film. Plate and dial, permanently attached to the side of the camera, bear a lens-aperture scale, camera speed arrow and the subject classifications of "light", "normal" and "dark".

The new guide can be attached to any present Cine-Kodak and a pocket model, with complete set of cards, is also available.

New Superior Products

New products of the Superior Bulk Film Company include the Sensigraph Capsule, a convenient hyper-sensitizing agent that doubles the speed of ordinary film. Also the recently introduced Graphic Reel for home processing of movie film, and the Superior Film Slitter, a simplified device for easy slitting of double 8mm film. Graphichrome *plus* high-speed movie film was introduced several months ago,

featuring Superior's daylight-loading leaders and trailers heretofore not available on 8mm film. Daylight leaders are now available on 100-foot rolls of single 8mm film for Univex and other cameras using single 8mm film.

Besbee

New opportunities for novel and interesting outdoor movie shots are offered in the Besbee Closeup Combination Kit, which makes it easy to produce sharp closeups of small objects, indoors and out. Movie makers will welcome this possibility especially during the coming Spring and Summer seasons, because this new Kit is designed to work with any movie camera in making sharp closeups of flowers, small birds and animals, botanical details, insects, etc. The Kit consists of a tripod table (which also can be used effectively with the camera handle supplied), an adjustable lens holder universally adaptable to any 8mm. or 16mm camera, and two closeup auxiliary lenses, giv-

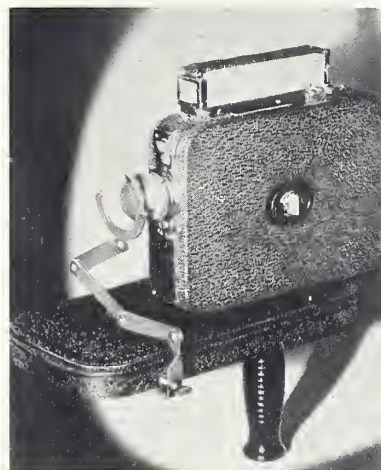

ing sharp closeups of objects at distances of ten and thirty inches. The special camera handle, which is a regular part of the Kit, may be used on all occasions and is a real aid to the steady holding of the camera.

Sixty-inch Telephoto

Claimed as the longest focus, largest aperture telephoto

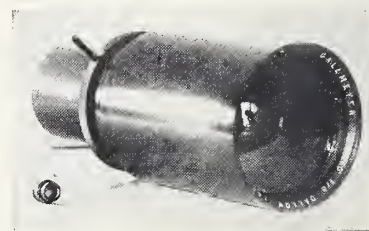

lens commercially produced, J. H. Dallmeyer, Ltd., have announced details of a new Dallon Anastigmat having an equivalent focal length of 60 inches, with an aperture of f/8.

Some idea of its huge size will be gained from the accompanying illustration, which shows it side by side with a four-inch f/5.6 Dallon.

Although this lens was made for special press work, the possibilities it offers have led to a decision to list it as a standard production.

As required, it can be adapted for use with miniature and cinematograph cameras. With the former cameras it would give a linear magnification of 30 times, and sixty times with cinematograph cameras.

Revere

The Revere Camera Co., Chicago, announces the addition of a new Turret Mount 8mm Camera to its line of motion picture equipment. This camera has the same precision mechanism as the Revere Double 8mm Camera, Model 88 which was announced recently but is equipped with a rotating turret head for three screw-type lenses. It also has an extra optical

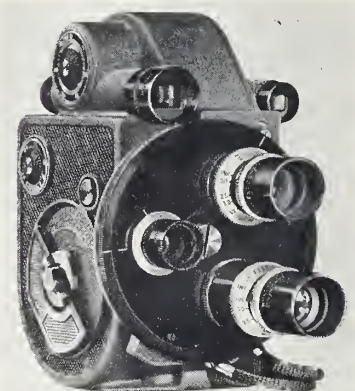

view finder (31mm.) for telephoto shots. Correct lens position is assured by precision index mechanism.

The Revere Turret Camera, like the single lens Revere Model 88, uses all standard 25 ft. double 8mm full color or black and white films. It is licensed under Eastman's Double 8 Spool and Spindle patents. It has an exclusive retarding sprocket film control which makes a film loop automatically should the user forget to do so. Other features include 5 speeds, 8 to 32 frames per second, film footage counter, 5 ft. spring motor, helically cut gears, stainless steel aperture plate and 160° rotary disc shutter.

World's Fair Films

Official Films, Inc., official motion picture photographers for the New York World's Fair, announce that many changes and improvements have been incorporated into the World's Fair pictures they are releasing this year. For example, scenes of the Russian Pavillion are eliminated entirely, and are substituted with pictures of the Polish Building under its new guise. The films of the 1940 World's Fair will be as spectacular and dazzling as the Fair itself, and these pictures should be in great demand by visitors who have attended the Fair as well as the less fortunate stay-at-homes who will want to enjoy the sights even though they cannot attend.

Ten separate titles will be released in color, including the fascinating Aquacade, which proved to be the most popular attraction at the Fair last year.

For full information regarding all World's Fair titles, write to Official Films, 330 West 42nd St., New York City, Attention Mr. Bluerock.

Test Strip Service

A new testing service that should prove of value to amateurs who use bulk film is offered by Corona Film Laboratories, 200 East 34th Street, Brooklyn, N. Y. This company has set up a special department devoted exclusively to processing test-strips of short lengths of film.

• Continued on Page 308

Invariably THE CHOICE OF CRITICAL AMATEURS

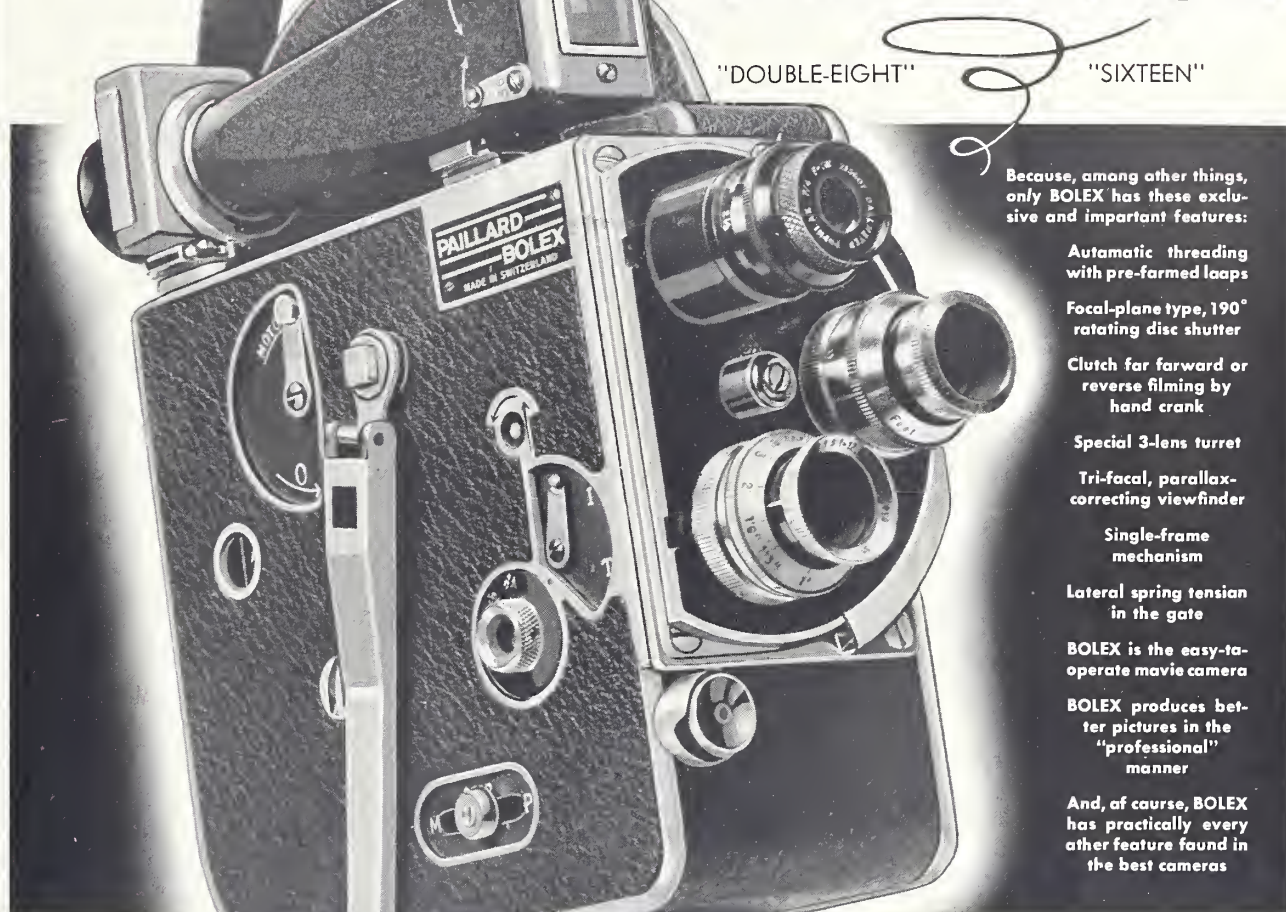

"DOUBLE-EIGHT"

"SIXTEEN"

Because, among other things, only BOLEX has these exclusive and important features:

Automatic threading with pre-formed loops

Focal-plane type, 190° rotating disc shutter

Clutch far forward or reverse filming by hand crank

Special 3-lens turret

Tri-facial, parallax-correcting viewfinder

Single-frame mechanism

Lateral spring tension in the gate

BOLEX is the easy-to-operate movie camera

BOLEX produces better pictures in the "professional" manner

And, of course, BOLEX has practically every other feature found in the best cameras

CUSTOM BUILT

BOLEX is, in practically every way, a custom-built instrument. Every important part is carefully fitted and numbered with its reciprocal part—assembly is not a haphazard proposition but rather a meticulous process. E. PAILLARD & Co. are internationally famous as manufacturers of precision-made instruments—a reputation earned through 126 years of uninterrupted production. That's why every BOLEX is guaranteed against defects in workmanship and materials for two years.

Yes, it has everything—versatility and adaptability are built right into BOLEX. You can do with it nearly everything that you see done on the professional movie screen. At your finger tips are the means to produce slow motion, animations, single-frame "stills," super-impositions, fades, close-ups, lap-dissolves and all the other "professional" effects that add so much to the interest of personal movies. And of greatest importance is the fact that BOLEX films are always rock-steady and when properly exposed are of the most beautiful photographic quality. Ask your dealer to show you how BOLEX meets and masters every movie-making situation—see for yourself how it feels just to handle the world's finest sub-standard cine camera. Then you will know why critical amateurs by the thousands choose BOLEX. Send today for new 52-page catalogue.

AMERICAN BOLEX COMPANY, Inc.
155 EAST 44th STREET • NEW YORK, N. Y.

Bolex

paillard

THE WORLD'S FINEST

It's cheaper to buy a BOLEX at the start — so see a BOLEX before you buy!

2 DU PONT 16^M/M FILMS

FOR BLACK & WHITE MOVIES AT THEIR BEST



REGULAR PAN

REVERSAL PROCESSING
The Double Economy Film

SUPERIOR PAN

NEGATIVE-POSITIVE PROCESSING
An Indestructible Record

REGULAR PAN saves money two ways. Its price is reasonable. And with its wide exposure latitude, you can make every foot count. For your next outdoor movies, try a roll of this double economy film. Its panchromatic sensitivity lets you use filters. Its speed in daylight fits the range of your lens. Bright scenes take f:16 the smallest opening. Sold by leading photo supply dealers. List price four-fifty per 100 ft.

SUPERIOR PAN makes your movie a permanent record. It's a fast, panchromatic film, that is grand to use outdoors or indoors for pictures of children and scenes you can never replace or retake. Negative-Positive processing gives Superior Pan its permanence. When you send a roll to be processed, you get two films back. One, the original camera negative, you keep. The other, the positive print, you project. You can have extra prints made by returning the negative to us. Superior Pan is sold by leading photographic dealers. The list price — \$7.50 — includes processing of both negative and print. For additional prints the charge is 3½ cents per foot (minimum one dollar).

DU PONT FILM MANUFACTURING CORP., Inc.
9 Rockefeller Plaza New York, N. Y.



With the **PRO-16's**

Medical

Billy Burke, of Beverly Hills, has just completed a 1600 foot film for the Medical Department of Winthrop Chemical Company demonstrating proper application and actual use of the various types of local anesthetics marketed by the firm. Burke took his camera into the operating rooms of ten different hospitals in order to record actual operations. When final editing, now in progress, is completed, fifty prints will be made for distribution among medical societies, hospitals, and medical schools.

For many years, Burke has specialized on filming for the medical profession as well as for chemical manufacturers, and shoots all his productions in 16mm. Current production is first of a series ordered by Winthrop.

Sun Valley

Union Pacific Railroad, under the supervision of cinefilmer Vincent Hunt, has just completed a series of pictures describing their Sun Valley resort in Idaho. Filmed directly on 16mm Kodachrome, the subjects range from 800 to 1200 feet in length. Each is complete with music and descriptive narrative which was added by Dunningcolor Corporation of Hollywood, who, incidentally, are also turning out the duplicate color prints.

The films depict all the summer and winter sports available at this popular year 'round resort, and prints will be distributed among travel bureaus, service clubs, and publicity agencies.

Pottery

Gladding-McBean Co., Los Angeles, whose multi-colored western potteryware is now distributed the world over, recently chose the most logical medium for publicizing their products — Kodachrome film. Immediately production was launched on an 800 foot 16mm color film, now nearing completion.

● **News of readers' activities in business, school, and publicity film production.**

Music and commentary will be scored in by Dunningcolor Corp'n., who will also turn out the duplicate Kodachrome prints.

Tuna Fishing

Fred Rocket recently completed a 3 reel 16mm Kodachrome picture for the Van Camp Sea Food Company, dramatizing the tuna fish from catch to canning. Rocket's camera followed the fishing crews in their "tuna clipper ships" to the fishing banks, recorded vividly in color the spectacular catch scenes, then proceeded along with the catch into the cannery. Windup shows many of the delectable dishes that may be turned out with a can of Van Camp's tuna.

Entire production was filmed with a Cine Special and is scored with music and commentary — some of it actually lip-synchronized. The production will be used by Van Camp's sales staff for showings to purchasing agents and personnel of large grocer and chain store organizations.

Cine Sermon

Rev. J. Harris Tegarden of Hopedale, Mass., has completed an 800 foot sound movie of one of his sermons — "Making the Most Of Your Life." This is but one instance of many where sound movies are being used as a means of furthering the interest of congregations in their church. And if Rev. Tegarden can't get to his church some Sunday, the film can be run off in place of the usual sermon.

Local Newsreel

Their interest awakened by a story appearing recently in HOME MOVIES, a theatre in North Hollywood is now filming their own local Newsreel each week.

Boole CINE-FADER

PUTS 64 VARIETIES OF FADES & DISSOLVES

at your finger tips



The handy Boole times and automatically makes by clockwork mechanism, all kinds of tricky effects "as you go." When operating there is no need to remove the eye from viewfinder. Boole also serves as filter holder.

FITS MOST EVERY MOVIE CAMERA AND PROJECTOR

Complete with extension tube, cable release, and instructions for operation..... \$17.50

Cinea 30

FILM SPLICER

HANDLES BOTH 8 and 16 mm SOUND and SILENT FILM



It's the best! It is expertly designed for efficiency and precision-built to make all splicing easy, fast, and accurate. All of the working parts are held under steel spring tension. When properly made, Cinea splices are neat and strong..... \$10.00

Cinea-WINDERS

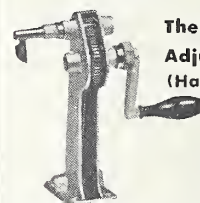

The Only Rewinds That Have Adjustable Drag and Brake (Handle both 8 and 16 mm Reels)

The exclusive drag feature does away with spin and backlash and leaves one hand free. Fine-cut gears and large, easy-grip wooden handles make operation smooth and quiet. Per pair, \$9.00

Cinea FILM CEMENT

The only cement that is good for all kinds of film—acetate or nitrate—35 mm, 16 mm, or 8 mm. Cinea Cement is odorless, does not bleach color, is slow to evaporate from uncorked bottle yet joins film quickly and strongly. Bottle..... 25c

GINELAC PROTECTS YOUR FILM

against SCRATCHES, FINGER MARKS, CURL AND BRITTLINESS

GINELAC permeates and toughens the emulsion—seals in moisture—prevents excessive aging—protects negatives and cine film. No apparatus needed—easy to apply. 2 oz. bottle..... \$1.00



See your dealer or order direct from—

AMERICAN BOLEX COMPANY
155 EAST 44th ST. • NEW YORK, N. Y.

Hyper-sensitizing films . . .

• Continued from Page 273

placed on a secluded shelf in a locker and left there for exactly one week.

When the night arrived for which the filming expedition to the Fair was planned, the film was removed from the box, loaded into the camera, and off we went to the Fair grounds. The camera used was a 16mm Bell & Howell model 70-DA with an f/1.5 lens. The speed indicator was turned down as far past the 8-frames-per-second mark as possible. A careful check enabled me to estimate the camera's speed now to be approximately 6 frames per second. This gave me a shutter speed of about 1/10th of a second.

It is generally agreed that mercury hyper-sensitizing of black and white film increases its speed 100 to 150 per cent. However, this information offered no basis for computing the effect of the mercury process on Kodachrome; so to play safe I believed it necessary to give the film all the exposure my lens and camera speed allowed.

Arriving at Treasure Island amid the dazzle of colorful lights which, to the uninitiated, would seem to furnish adequate light for any kind of filming, we set up the camera on the tripod with no little apprehension as to the results. After all, there were nine hard-earned dollars tied up in this experiment! With a brief prayer and my fingers crossed, I focused the camera on the towering Pacifica, pressed the starting button and slowly faded in on the scene.

There was another brief blessing mumbled over the roll of film next morning when it was carefully wrapped and sent on its way to the processing laboratory. Our humble prayers were answered, for when the roll of film was returned a quick check of it showed most of the scenes to be well exposed. Repeated screening of it later confirmed this. The "hopping up" by the mercury process had worked wonders!

Actually the film had recorded quite faithfully, and for the most part was quite brilliant. Best of all, it had even recorded the blues in the fountain at the feet of Pacifica; and Pacifica herself was there in long shot and closeup in good color and fine detail sharply defined throughout. Similar good results were had in the majority of scenes. Best of all, perhaps, was the fact that although the action was noticeably increased by the 6 frames per second speed, it was not annoying, and there was no flickering in the shadows or highlights.

As to the increase in the Weston speed of Kodachrome film "hopped up" by mercury sensitizing, no definite information is available. My film was carefully compared with others shot with 8mm cameras equipped with slightly faster lenses and slower shutter speeds, and, on the basis of visual comparison, it would seem that hyper-sensitizing almost tripled the speed of Kodachrome. At this rate, hyper-sensitizing would give Kodachrome a Weston rating of about 32.

The "hopping-up" process outlined above was subsequently tried several times by other amateurs in the San Francisco region, with various results. Films hyper-sensitized exactly as described above obtained rather consistent results. Kodachrome hyper-sensitized both before and after exposure produced no appreciable increase in speed. In every case, it was notable that there was little, if any, distortion in the color tones.

It has been suggested that Kodachrome reaches its peak in accelerated speed after about 36 hours' exposure to the hyper-sensitizing process. After 36 hours the speed decreases. This latter fact seems to be borne out by the experience with the one roll of Kodachrome that was hyper-sensitized both before and after exposure to light.

To those who would experiment with the mercury

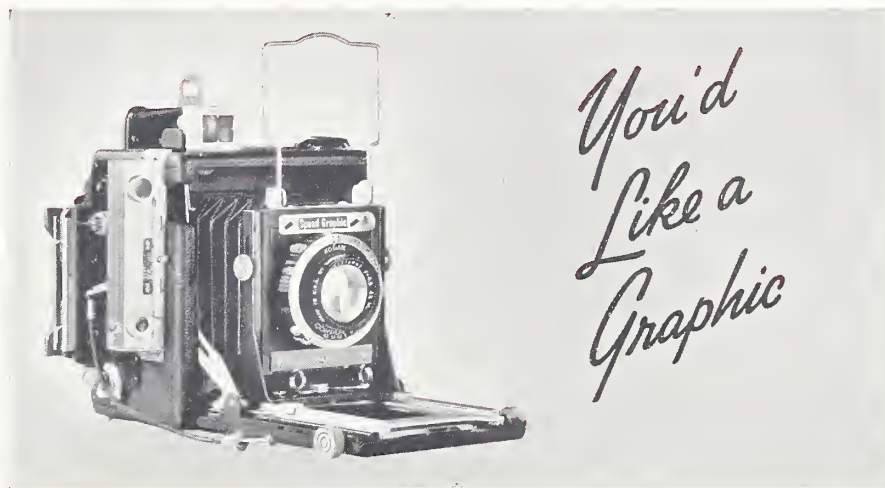

*You'd
Like a
Graphic*

YOU'D be sure to like a Speed Graphic—you'd like the feel and appearance of this fine photographic instrument . . . its 1000th-second focal plane shutter, extension bellows, interchangeable lenses, parallax-corrected tubular finder . . . its ability to take a wide range of plate and film emulsions, including sheet Kodachrome. And you'd like the pictures possible with all this versatility at your command.

The compact 2¼ x 3¼ Speed Graphic, illustrated, would make a fine "next" camera. With Kodak Anastigmat f/4.5 lens in 250th-second between-the-lens shutter, it is \$111. Internally-coupled range finder, shown, \$27 extra, installed.

Graflex and Graphic Cameras are made by the Folmer Graflex Corporation

EASTMAN KODAK COMPANY, ROCHESTER, N. Y.

**MORE
OOMPH
FOR YOUR
HOME MOVIES**

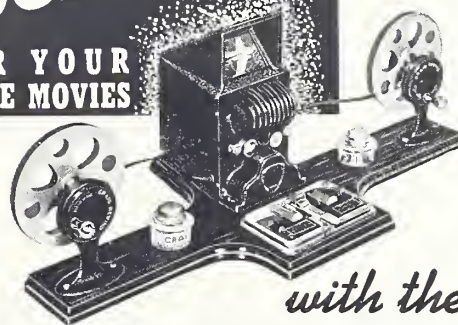

with the
CRAIG PROJECTO-EDITOR

It takes proper **Editing** to make modern fast-moving, interest-sustaining movies. **ACTION-EDIT** your films the Hollywood Studio way — transform random shots into smooth-running sequences that everyone will enjoy seeing.

The Projecto-Editor provides a unique viewing method — allows careful inspection, slow motion if desired, of **every** movement on its brilliant miniature screen. Films may be readily removed from the polished guides for quick cutting and splicing.

At all dealers — Ask for demonstration.
8mm. model, complete . . . \$27.50
16mm. model, complete . . . \$49.50

CRAIG MOVIE SUPPLY COMPANY

1053 S. OLIVE ST. • LOS ANGELES, CALIF.

"Makes Editing a Pleasure"

Craig Safety Film
Cement—25c



Craig Senior Rewinds
\$4.50 each or \$9.00 the pair



Craig Junior Splicer
8 or 16 mm., \$2.50



Craig Junior Combination
Complete, \$7.25

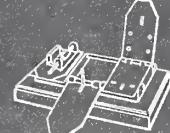

Craig 16mm. Senior Splicer
For sound or silent, \$10.00



Craig Senior Combination
Complete, \$19.50

Announcing PHOTRIX CINE

**A real movie exposure meter,
made especially for movie work**

THE movie camera owner needs a special exposure meter...he thinks in terms of operating speeds, not in exposure time...his main camera setting is the lens opening...his camera angle is small. That is why ordinary exposure meters are not satisfactory for motion-picture use. PHOTRIX CINE fills the need of movie camera owners...it is not a converted still picture meter, but has been designed, in every detail, for the special requirements of movie work.



HERE ARE ITS OUTSTANDING FEATURES:

- Movable scale of operating speeds for precise adjustment according to specific shutter speed of your movie camera.
- No setting between shots...reads lens opening directly.
- Sensitivity adapted to full range of light conditions occurring in cine photography.
- Tapered light chamber giving sharply defined light acceptance angle of 50 degrees.

The ideal exposure meter for amateur and studio use, with every movie camera, with all color and black-and-white films.

Top-grain cowhide zipper case, \$1.50

\$22.75

RANGES
 Brightness: 0.75 to 4500 cdl./sq. ft.
 Lens Opening: F:1 to F:32
 Light Acceptance Angle: 50°
 Film Speed: 0.75 to 800 W., 8 to 38 S.C.H.
 Operating Speed: 6 fr./sec. to 128 fr./sec.
 Shutter speed at 16 fr./sec. adjustable from 1/25 to 1/50 sec.

MADE IN U. S. A. by craftsmen with more than 25 years experience in electrical precision instruments. Photrix Cine is reliable, sturdy...built for years of faithful service. At your dealers, or write Dept. P-6.

INTERCONTINENTAL MARKETING CORPORATION, 8 West 40th Street, New York

process of "hopping up" Kodachrome film, a few words of caution here may enhance results: In placing the film in the box or container with the mercury, make sure the mercury will not spill from its container and touch the film. Contact of the mercury with the film will fog it badly. Use the hyper-sensitized film as soon as possible after it has reached its

speed peak—say four to six days after placed in the container with the mercury. And last but not least, rush the exposed film to the processing station as early as possible after it is removed from the camera. Decrease of film speed begins immediately after the hyper-sensitized film is removed from the mercury.

Build a Telephoto lens...

• Continued from Page 285

the camera. Aluminizing costs about 50c per diameter inch. This service is usually available from optical supply houses.

Figure 2 shows how to find the reflected focal length, and the ratio or speed of it, after the aluminizing process has prepared the lens for use. A sharp miniature image of the sun or moon or a distant electric light forms on the white card when the concave reflector is held at a distance from the card, representing its exact focal length. The reflected focal length is always one-half of the radius of curvature of the concave surface.

A 1 1/2" concave mirror of 9" focal length would make an F.6 telephoto of 9X power for 16mm use and 18X power with 8mm, compared with standard lenses. Do not try to make a telephoto any faster than F.5.6 to F.8 from spectacle lenses, as the curve must be very accurate in the larger ratios.

A small flat mirror set at a 45° angle is needed, as shown in A, figure 1. This should be 1/8" or 1/4" thick polished plate and must be flat, not wavy, glass. Its width should be about two-thirds of its length so that it appears about square when viewed from the opening that fits the camera lens. Its actual size depends on the size and ratio of the concave mirror. It should also be aluminized on its outer surface (one side only) so that no light passes through the glass but reflects direct from the concave mirror on the film. Two or three thin adjustable metal supports hold this secondary mirror (or prism) in place. The loss of light caused by the

secondary and its supports is negligible. See layout in figure 3 for determining the width of the secondary. Naturally, the shorter the mirror ratio the larger the secondary must be to reflect all of the rays to the film. Be sure to make the shorter diameter at least as wide as the largest diameter of the film frame, whether it be 8mm or 16mm.

Figure 3 shows how to mount the mirror cell and also an easy way to make it focusing. The cell can be turned on a lathe from hardwood or aluminum. The mirror must fit snugly but not tight. Sheet cork or felt is good for this purpose. Everything — particularly the two mirrors — must be lined up true.

The aperture can be stopped down by placing small neutral density filters in a slot located between the secondary mirror and the camera opening, as shown in figure 3. Small discs with circular openings could also be fitted in a slot in front of the main mirror. They cannot be made smaller than about F.8 or F.11, however, unless the "Herschelian" principle is used.

The finder shown in figure 3 is self-explanatory. Its length is the focal length of the telephoto and it is fastened at some convenient place near the top of the telephoto. It is adjusted to include the same area as the mirror. This is found by observing the ground-glass image at the film gate or making small tests on positive film and adjusting the angle of the finder until accurate. Naturally, a tripod or other steady support should always be used with

4 STAR



For Year 'Round Filming Activity

After the winter title-making season, use it for ultra-closeup filming of plants, flowers, insects and other nature studies!



Adjustable camera base accommodates every make of 8mm, 9 1/2mm, and 16mm camera. Alignment and centering of titles is simple and accurate. Title board is readily adjustable to either small typewritten or large 9"x12" title cards.



Will make practically every wanted kind of standard movie title, including zoom titles, wipe-off titles, etc. Additional accessories, available at small cost, make possible scroll, flop-over, superimposed titles and others.

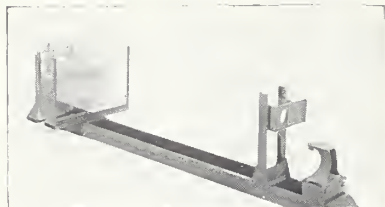
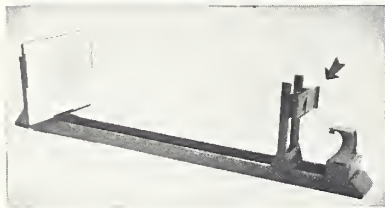

• Top—Titler complete with supplemental lens holder and built-in wipe-off device. Below—Showing glass bracket in place, used in making superimposed titles. Price, \$2.50.

\$13.75

Lights, \$4.50 Extra

HOLLYWOOD CINE PRODUCTS CO.

3221 South Figueroa Street

Los Angeles, Calif.

any kind of telephoto lens.

The two telescoping tubes must be an accurate fit but should telescope smoothly. They can be made of aluminum, brass or other metal. Square tubes of heavy plywood are also practical and much easier to line up, etc. The entire inside of the telephoto is painted flat black. The open end of the large tube should be longer than seems necessary, at least 3" or 4" past the camera opening. This prevents stray light from fogging the film. As shown in the sketches, either metal clamps or a tripod base arrangement holds the telephoto in a rigid position which must always be the same each time it is used. Black felt placed around the section that fits the camera opening will protect both the camera and the film.

If only distant telephotography is contemplated,

the telephoto can be simplified by making it fixed focus.

Movies of the moon taken at the proper phase show the lunar mountains and craters clearly. Solar and lunar eclipses can also be photographed.

Next month we will describe the "Foucault" test, a method of testing concave surfaces accurately to about five one-millionths of an inch with a simple home-made testing outfit. This will show which spectacle lens is best photographically. We also will describe in condensed form how an amateur can grind and polish by hand an accurate parabolic telephoto mirror of any desired size and speed at very low cost.

This reflecting telephoto principle can also be applied to 35mm candid cameras, provided they have a focal plane shutter and interchangeable lens mount.

Multi-plane titler . . .

• Continued from Page 281

and 3 will show the suggested type of guide.

The first position will be used in composing the title by sighting through the rangefinder. The second position is used in taking the picture, since the camera lens is in the exact position from which the picture was composed.

Next, examine the draw-

ing of the two-way switch. This switch is installed in the table top in a position such that movement of the camera mount from the first to the second position moves the lever arm No. 2 from contact with arm No. 3 to contact with arm No. 1. When the camera is in the composing position, the floodlights are extinguished

Exposure Meter Guide

CORRECTED MARCH 1, 1940

	SCHEINER		WESTON OR GE			SCHEINER		WESTON OR GE	
	Day	Maada	Day	Maada		Day	Maada	Day	Maada
AGFA					GEVAERT				
16mm SSS Pan.....	29	27	100	64	Super Reversal.....	23	21	24	16
16mm Hypan.....	24	23	32	24	Panchro.....	20	18	12	8
16mm Panchromatic.....	21	20	16	12	Ortho.....	21	17	16	6
16mm Supreme Pan. Neg.....	27	25	64	40	GENERA				
16mm Finopan Neg.....	23	21	24	16	Meteorpan.....	23	21	24	16
16mm Positive.....	12	8	3	..	Normal Panchromatic.....	20	18	12	8
16mm Plenachrome.....	20	..	12	3	Super Ortho.....	21	17	16	6
8mm Twin-8 Hypan.....	23	21	24	20	Movetone Ortho.....	19	13	10	3
8mm Filmopan.....	18	16	8	5	Semi-Ortho.....	18	12	8	2
DUPONT					KIN O LUX				
Reversal Pan.....	21	19	16	10	No. 1.....	16	..	6	..
Regular Pan Neg.....	20	18	12	8	No. 2.....	18	16	12	..
Superior Pan Neg.....	24	21	32	20	No. 3.....	26	24	50	40
Positive.....	12	..	2	1-6	PELLEX				
EASTMAN					Super.....	26	25	50	40
16mm Super XX Pan....	100	64	Pan.....	20	18	12	8
16mm Super X Pan.....	24	23	32	24	Ortho.....	18	14	8	3
16mm Safety.....	20	18	12	8	Super 8mm.....	25	24	40	32
16mm Sound Pan.....	23	21	24	16	Ortho 8mm.....	17	12	6	2
16mm Pan. Negative.....	23	21	24	16	HOLLYWOOD				
16mm Positive.....	16	10	5	3	S. S. Pan.....	26	25	50	40
8mm Super X Pan.....	23	21	24	16	Pan.....	21	20	16	12
8mm Regular Pan.....	18	16	8	5	Semi-Ortho.....	18	12	8	2
Kodachrome (8 & 16mm)..	18	14*	8	3*					
Koda. "A" (8 & 16mm)..	18*	21	8*	12					

*With filter

THE MOST THRILLING SPECTACLE OF ALL TIME!

Now Forever Yours!



"NEW YORK WORLD'S FAIR OF 1940"

In Home Movies exclusively produced by the Official Motion Picture Photographers of the New York World's Fair. 16 mm. 8 mm.

Now you can reserve a front-row seat for the mightiest spectacle ever conceived—mankind's Parade of Progress—the N.Y. World's Fair of 1940! Now you can thrill to the splendor of the World of Tomorrow as seen by day and by night. Now you can sit in your own easy chair and let Official ace cameramen take you on a tour of the colorful International Pavilions, the fascinating educational Exhibits, the gay, mad Amusement Area—everything that goes to make this World's Fair the most amazing and complete record of our Civilization! A film you'll enjoy now and treasure for years to come.

Made in Five Standard Sizes

16 mm.	8 mm.
360 Feet silent film . . . \$10.00	180 Feet silent film . . . \$6.00
100 Feet silent film . . . \$ 3.50	50 Feet silent film . . . \$1.75
Sound On Film—16 mm. Only. 350 feet . . . \$17.50	
Natural Color Film—16 mm. Only	
100 feet . . . \$17.50	360 feet . . . \$62.50
	400 feet on sound . . . \$100.00

MOMENTS WHEN THE WORLD GASPS!

Official Films

"NEWS THRILLS OF 1940"—Vol. 1

This year of 1940 is probably the most thrill-packed, chill-pocked year in the world's history. So Official brings you all the important headlines from January to June—not in cold type—but in alive, moving pictures—and brings them right into your own living room!

16 mm. and 8 mm. in the same
five lengths and prices as above. Released on or about
June 29

Ask your dealer for these films!

OFFICIAL FILMS

330 WEST 42nd STREET, NEW YORK, N. Y.

In Canada: General Films

DRESS UP YOUR MOVIE TITLES

"A to Z" Figurerettes
for MOVIE TITLE BACKGROUNDS

30 subjects in color. Reusable. Sticks to any surface. Complete assortment \$1. At your dealer or send direct.

JACOB STEIN (Mfr.), Dept. F3
175 Fifth Ave. New York, N.Y.

MAKE YOUR OWN TITLER!

For all types of titles, close-up and copy work. Complete kit of finished parts—optically ground lens—easy instructions. Assemble in 15 minutes! Money Back Guarantee. State camera model.

Distinctive Title Card—"Photography by (your name)"—35c

ONLY \$1.65 IN KIT FORM

For All 8 or 16 MM CAMERAS

HOLLYWOOD MOVIE SUPPLY COMPANY
NORTH HOLLYWOOD • CALIFORNIA

Sees eye-to-eye with your camera



Too many pictures are poorly exposed because your meter measured unnecessary light. That can't happen with the new DeJur "Critic" Model 40 Exposure Meter because the modern "Louvre" sees eye-to-eye with your camera. Indoors or outdoors. Made according to a mathematical formula, the "Louvre" reads only the area as seen by the lens, it admits light from your subject, and no more — assuring you of perfect exposures every time. No wonder that the "Critic" with this, and other superior features, is hailed as the last word in today's exposure meter art.

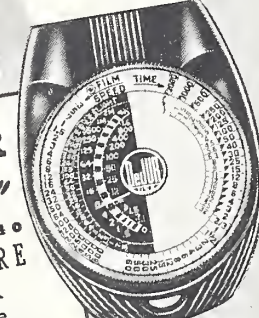

De JUR "Critic" MODEL 40 EXPOSURE METER
... with the Modern "Louvre"

\$18.75
(Custom Designed Case, \$1.75)

At Your Dealer's or Write for Booklet

De JUR-AMSCO CORPORATION
SHELTON, CONNECTICUT
"To be sure... buy De Jur"

and only the pilot light remains on. When the camera is in the photographing position, the pilot light goes out and the floodlights burn. This feature is invaluable in preventing the exposure of film before the correction is made for parallax.

Examination of the circuit diagram will show the simplicity of the electrical circuit used in this titler.

An alignment target made with a sheet of glass painted on one entire surface with aluminum enamel and then partly scraped off in the pattern shown in the drawing will be a great help in lining up the lettering in your titles. Place the target over the opening in the table top as shown in illustration No. 4. The criss-cross lines will locate the exact center of the title area on the middle plane or the floor and make it easy to make the spacing symmetrical.

Now refer to illustration No. 5 in which the use of the middle plane is shown. A pane of glass supports the letters of the subtitle. If a picture background is desired, it may be placed under the glass and will photograph perfectly.

If, however, a different effect is wanted, try placing

the titles on the glass, but use no top lighting. Instead, place the floodlights beneath the middle plane aimed downward at an angle of about 45 degrees. If black and white film is used, place a white piece of cloth on the floor under the table — if Kodachrome Type A, use a colored piece of cloth. The resulting title will be silhouetted letters against a white or colored background that is completely out of focus and thus gives contrast only.

The same setup except with the floodlights pointed upward from beneath at a 45-degree angle, with white paper or colored cellophane under the letters will produce a startlingly beautiful effect.

When photographing titles on the middle plane with an effective area of 5 1/4" by 7" letters and figures of 3/8" are about right. Titles photographed at 40" may be made with these or with 3/4" letters, depending somewhat on the subject-matter and type of title you are making.

While using either of these distances, the titles may be wiped on or off with an opaque card large enough to cover the open-

PEERLESS
"PLUS+VIOLET"
REVERSIBLE MOVIE FILM
ASSURES YOU OF
BETTER MOVIES

"PLUS+VIOLET" is the kind of film you have often wanted but have been unable to find in its class price.

"PLUS+VIOLET" is a medium speed (Weston 12, Scheiner 20), fine grained outdoor type film with wide latitude anti-halo backing and a special base which filters out all of the low frequency rays of the projection lamp, giving upon the screen a more brilliant and pleasing picture.

"PLUS+VIOLET" is not just another cheap film at a low price, but is a SUPERIOR film in the low price class. It is offered as a splendid film for those who wish to get good results on a limited film budget.

A trial will convince you that "PLUS+VIOLET" will enable you to take more and better shots for less money. Order today one or more trial rolls of "PLUS+VIOLET" at these attractive prices:

- 30 ft. 8mm spooled for Univex . 60c
2 rolls for \$1.00
- 25 ft. double 8mm \$1.00
4 rolls for \$3.50
- 100 ft. 16mm \$2.35
4 rolls for \$8.00

California Customers Add 3% Sales Tax

Above prices include generous extra footage for leaders, daylight loading spools, processing, projection reel, and return transportation.

"PLUS+VIOLET"
PANCHROMATIC

A high speed fully panchromatic "PLUS+VIOLET" reversible film with a speed rating of Weston Daylight 32 and Mazda 20—Scheiner Daylight 24 and Mazda 22. 100 feet 16mm on daylight loading spool, including processing, \$4.50, or 3 rolls for \$12.00 (8mm not available).

SPECIAL TRIAL OFFER

One 100-foot 16mm roll each of our regular "PLUS+VIOLET" and one roll of our Panchromatic "PLUS+VIOLET"—a \$6.85 value for only \$5.00.

ALSO SOLD IN BULK

Write for Descriptive Circular and Price Lists

Sold Only by

PEERLESS of HOLLYWOOD

7763 Santa Monica Boulevard
HOLLYWOOD, CALIFORNIA

USED BARGAINS

ANNUAL SPRING CLEARANCE OF FINE VALUES AT MONEY-SAVING PRICES!

CAMERAS	
8mm Keystone F2.5 with case	\$28.50
16mm Eastman Model B, F3.5 with case, 1 speed	25.00
16mm Eastman Model B, F1.9, no case, 1 speed	47.50
16mm Cine B, F1.9, telephoto lens, case, 1 speed	85.00
16mm Eastman Model BB, F1.9, 50 ft. load, 2 speed, case	56.25
16mm Victor 70A, F3.5, with case, 2 speed	42.50
16mm Victor, F3.5 with case, 3 speed	42.50
PROJECTORS	
8mm Eastman Model 20, no case	\$16.50
16mm Bell & Howell 57G, 400 watt, 120 v., with case	42.50
16mm Bell & Howell 129C, 750 watt, 1600 ft. reels, case	145.00
16mm Eastman Model G, 750 watt, with case, new guarantee	95.00
16mm Ampro, 750 watt, with case	95.00
16mm Ampro, 500 watt, continuous, 400 ft. capacity	125.00
16mm Standard, 750 watt, with case	69.50
MISCELLANEOUS	
Challenger glass-headed screen, 39"x52"	\$17.50
Standard Enlarger with easel, complete	35.00
Candid Camera, Robot F2.5, with case	111.50
Candid Camera, Kodak Volenda, F3.5, no case	34.50
Candid Camera, Rolleiord F3.8, with case	65.00
Guaranteed condition—subject to prior sale.	
RENTAL LIBRARY containing over 400,000 feet of 8 and 16mm silent and 16mm sound subjects. Free catalogue.	

ZENITH CINEMA SERVICE

5011 N. Sawyer Ave., Chicago, Ill. Established 1924

Movie of the Month

Each month the Editors of HOME MOVIES select the best picture sent in for analysis and designate it "The Movie of the Month." This movie is given a detailed review and a special leader is awarded the maker.

This award does not affect the eligibility of such films for entry in the annual HOME MOVIES CONTEST. They are automatically entered for rejudging with those films submitted especially for the annual contest. Films awarded the honor of MOVIE OF THE MONTH during past 12 months are:

1939

JULY: "Behind the Dial," produced by Robert C. Orr, Mt. Kisco, N. Y. 16mm picture approximately 400 ft. long.

AUGUST: "New England Holiday," produced by Albert Watts, Buffalo, N. Y. 8mm Kodachrome picture, 800 ft.

SEPTEMBER: "Within the Garden Gates," produced by Murray Beliz, Sacramento, Calif. A 200-ft. 8mm Kodachrome film.

OCTOBER: "Hummingbirds," filmed by Richard L. Cassell, D.D. S., Los Angeles, Calif. A 16mm Kodachrome film, 400 ft. in length.

NOVEMBER: "Esquire's Escape," produced by Clarence M. Aldrich, Long Beach, Calif. A 16mm picture 800 ft. in length.

DECEMBER: "Souvenir," produced by Harold E. Remier, Hollywood, Calif. A 100-ft. 8mm Kodachrome film.

1940

JANUARY: "The Cauldron," produced by Dr. R. E. Gerstenkorn, Beverly Hills, Calif. A 16mm picture 400 ft. in length.

FEBRUARY: "Whistling Wings," produced by W. H. Nordin, Austin, Minn. A 16mm Kodachrome picture, 400 ft. in length.

MARCH: "Checking Off the Budget," produced by B. W. Johnson. An 8mm Kodachrome film, 1000 feet in length.

APRIL: "El Lobo," produced by Demetris Emanuel. A 16mm picture, 400 feet in length.

MAY: "From A to Z," produced by Vernon Aldree, Stockton, Calif. A 16mm Kodachrome film, 400 feet in length.

JUNE: "Peetie," produced by Edmund Turner, Detroit, Mich. A 16mm Animated Cartoon, 400 feet in length.

NEW! **FREE**
GRAPHICHROME Plus
WITH EVERY ORDER FOR TWO 100-FT. ROLLS DBL. 8 MM. GRAPHICHROME PLUS.

SINGLE 8 USERS. SLIT YOUR OWN... SAVE MONEY!

FASTER DAYLIGHT LOADING BULK MOVIE FILM

SAVE 2/3. Buy in bulk, roll your own! Now this new faster film (Weston 12) costs little more than regular GRAPHICHROME. Non halation. Ortho, fine grain for sharp projection. Daylight loading leaders and trailers. Costs no more for processing.

Look at these LOW PRICES	Regular Graphichrome (Weston 8)	Graphichrome PLUS (Weston 12)
100 ft. dbl. 8 mm. notched in four leaders, trailers between ea. load	1.50	1.85
100 ft. sgl. 8 mm., without leaders	1.00	1.10
30 ft. double 8 mm., Camera Reel	.55	.65
Same with daylight leader, trailer	.65	.75
400 ft. 16 mm. notched in 100 ft. lengths	4.00	4.65
100 ft. 16 mm.	1.15	1.30
Same with daylight leader, trailer	1.25	1.45

EVERY ITEM FULLY GUARANTEED
Order today direct from this ad. Or write for FREE circulars, processing rates, supplies, accessories, etc.

Superior Bulk Film Co., Dept. HM-6
188 W. Randolph St. Chicago, Illinois

ing in the table top. Wipes or fades at both ends of a title strip make it possible to make your splices in opaque film that will not project on the screen the usual disturbing smear.

For double exposure or montage effects, this titler is ideal for accurately locating the masks to cover a portion of the field of view.

For subtitles with backgrounds of moving scenes, try setting up the letters on the middle plane with strong top lighting. Place a light-proof blanket or skirt around the table from the middle plane to the floor,

and cover the floor area with black cloth such as cotton velvet. Now photograph the title, noting the length of film exposed. Then rewind the film in a dark-room. At this point the film will be completely unexposed in the entire area of each frame not occupied by letters.

Subsequent re-exposure of the film on suitable moving scenes such as mountain streams, lakes, highways, city streets, etc., will produce the proper final result in which the title in clear, sharp letters appears superimposed on the desired scene.

Can I improve my Film?

• Continued from Page 287

on the east coast where the first motion pictures were produced by David Wark Griffith with Mary Pickford as the Biograph picture star at that time.

The film pictorializes some of the historic spots as they are today where some of the best known early day movies were filmed. Recorded is the site of the hotel in Cuddebackville which housed many a famous early day film star. Also shown is the site of the old railroad station which gradually decayed with age. Even the old timbers are seen still lying among the tall weeds which have since grown up

to shroud the revered skeleton of the station where many early day stars waited for trains that sped them to the more effulgent studios of fabled Hollywood. There were no studios in Cuddebackville. The pictures were all shot out of doors among the beautiful hills and valleys of that region. Included are closeups of some of the old timers who assisted D. W. Griffith in his early pictures, and the former owner of the hotel.

Editing: There was little in the way of continuity to edit in this picture. Lacking action, most scenes were purely scenic, but unusually colorful. The editing task consisted of balancing the length of each shot in order to maintain interest.

Titling: Titling is 90 per cent of the whole picture as they carry the story along, tying the scenes carefully together into an interesting document. Titles are well worded and written interestingly.

Photography: Is excellent, well exposed, with good composition evident throughout. Panoramings is well handled—slow and steady.

LADY ON JUNE STREET ★★★
200 ft. 8mm Kodachrome—By L. C.

Continuity: This is a closely knit story of a day in the life of a housewife whose life is one of comparative ease. Rising late, we see her slip into a negligee, and after a light breakfast she saunters into the living room, snaps on the radio, and proceeds to relax on a divan and read. A closeup

CORRECTION

• When R. S. MacCallister submitted his article, "There's No Mystery About F Stops!" which we published last month, we thought it so good we immediately got him on long distance telephone to secure additional data which, according to MacCallister, our reporter garbled considerably as evidenced by the errors which occur in that part of his article on page 251. So we hasten to correct this data for the benefit of our readers as well as for MacCallister, who has been called to task by more than one of his cinefilming brothers for mistakes for which he was not at all responsible.

First, in the table titled "Opening Up Lens," the third, fourth, and fifth apertures should have been shown as increasing light 400, 800, and 1600 per cent, respectively.

Then, in the next table, it seems we left out one stop entirely—f/11. The f/11 should have appeared in place of f/16 as the rest of the data is correct for that stop.

ADD THRILLING SOUND to your movies . . .



At a fraction of the cost of sound-on-film. The FIDELITONE is ideal for adding music, sound effects, and speech to amateur films. TEN DAYS FREE TRIAL. Licensed under E. R. P. I. patents.

Write for details, also free advice on "sound" questions.

GEORGE K. CULBERTSON COMPANY
46 LUVERNE AVE. SO.
MINNEAPOLIS, MINN.

A PERFECTED, PORTABLE, FLEXIBLE SOUND UNIT, PRICED FOR THE AMATEUR FIELD . . . AS SIMPLE TO OPERATE AS A RADIO



AMAZING 16MM VICTOR CAMERA GETS ALL SHOTS

Indoor shots, outdoor shots, slow motion, telephoto shots—all have a professional brilliance when taken with a Victor camera. Precision-built Victor Model 4 camera offers: Full Vision Focusing for Sharp Images—3 Lens Revolving Turret—5 speeds including Slow Motion to 72 Frames—Geared Film Footage Meter—Hand Crank for Continuous Filming. Learn about this remarkable camera before the big outdoor season starts.

VICTOR CAPTURES
Life·Action·Color
WITH PROFESSIONAL RESULTS

THE NEW VICTOR "SILENT 16" Heralds a New Day in 16mm Silent Projection

Again, in the new "Silent 16," Victor ingenuity firmly establishes Victor as the leader in 16mm film projection. More silent operation. Fewer Moving Parts—Disappearing Reel Arms—Automatic "Rewind-As-You-Show"—Victor's Famous and Absolute Film Protection—Lamp Switch—Reverse Switch—Pilot Light and many others. Convenient carrying case provides extra space for tools, reels, lamp and accessories.



ASK ANY QUALIFIED PHOTOGRAPHIC DEALER—OR WRITE
ANIMATOGRAPH CORP.
Dept. B-1 Davenport, Iowa

GET THOSE DISTANCE SHOTS!



Price \$73.00

with this 4-in., F3.5

DALLMEYER CINE TELEPHOTO

For 16mm Models

For FILMO, BOLEX, VICTOR, KEYSTONE

Other Models

World famous for greatest accuracy and optical precision, these popular Dallmeyer Telephotos are supplied for practically all makes of Still and Cine cameras (both 8 and 16mm). You will increase the use and enjoyment of your camera to an amazing degree by means of a Dallmeyer Telephoto.

Booklet Describing All Models on Request

M E D O

15 West 47th St. New York City

VACATION SPECIALS! Prices Slashed! "DATED"

"REVELATION"

8mm—MOVIE FILM—16mm

REVELATION No. 1—Weston 12—Scheiner 20. SEMI-ORTHO—FINE GRAIN. A better, non-halation outdoor film. Provides wide latitude and softness—sharp, clean, professional quality pictures.

30 ft. single 8mm	\$.75 each
25 ft. double 8mm	1.25 each
50 ft. 16mm	1.50 each
100 ft. 16mm	2.50 each

5 rolls or more each item, 10% discount. Reversal Processing and Postage Included

REVELATION No. 2—Weston 50—Scheiner 26. PANCHROMATIC. A super-sensitive, non-halation film—fine grain, extremely high speed. Clear, beautiful pictures, either indoors or out. Color balanced.

30 ft. single 8mm	\$.85 each
25 ft. double 8mm	1.75 each
50 ft. 16mm	2.25 each
100 ft. 16mm	4.00 each

5 Rolls or More Each Item—10% Discount. Reversal Processing and Postage Included

For Economical Outdoor Movies

"Sun Amber"—16mm

A Reversible Safety Film—Weston 6	
50 ft. 16mm	\$1.00 per roll
100 ft. 16mm	2.00 per roll

Reversal Processing and Postage Included

POSTPAID—ORDER NOW!—C. O. D. orders, postage extra. Remit 1/3 with C. O. D. orders. (Calif. buyers include sales tax.)

SAVE MONEY—LOAD YOUR OWN 8mm—BULK FILM—16mm PRICES ON REQUEST

PACIFIC COAST FILM CO.

1510 N. Sierra Bonita Hollywood, California "Everything Photographic"

shows her reading an attractive ad in the magazine in which a luscious strawberry shortcake is displayed.

Falling asleep, the lady dreams of baking a strawberry shortcake like the one illustrated in the magazine. We see her putting the cake together, and while topping it with several giant-size strawberries, one of them inadvertently escapes to the floor beneath her feet. As she lifts the cake from the table to survey its beauty, she turns to carry it across the room, when the recalcitrant strawberry on the floor causes her to slip, bringing the cake down upon her.

At this point, the lady awakes, finds it is time to prepare hubby's dinner, and

exits to the kitchen. We find her preparing the dinner from an assortment of canned foods, as the story ends.

Editing: Was well handled. The producer worked from long and medium shots to closeups in a highly professional manner. Special attention was given to footage of each scene to maintain satisfactory tempo.

Titling: Titles were scarce but without affecting the story, as it unfolded smoothly, due to good editing. Existing titles, however, were well lettered and photographed.

Photography: Was of general high quality throughout. Notable were some exceptional camera angles, smooth dissolves, and the consistently good exposure.

Backgrounds pep up titles

• Continued from Page 283

made, take the camera to a darkroom, remove the side of the camera and rewind the film back on the supply reel to where the title began. This is one foot for each 2½ seconds of exposure on 16mm film, or 5 seconds of exposure on 8mm film. A more accurate way of determining this distance is to cut a small niche in the edge of the film just below the film gate before the title is exposed. When taken to the darkroom for rewinding, the niche is easily felt and rewinding stops when the niche is back to its original position.

The second exposure is of course made upon the desired scene. Since a dark background causes the letters to stand out more forcibly, an under-exposure of one or two stops is desirable. Expose the scene as long as the title was exposed, and the result will be the white letters upon the dark background. This method creates sharp focus in both the letters and the background, since both were photographed separately, and should also give superior results to the previous method described because of the exposure control due to the two exposures.

It makes no difference whether the title or the

scene is exposed first; the important thing is that they are timed together, and since it is not always easy to tell exactly how long the title will run, many workers prefer to expose it first, knowing that the scene will run indefinitely.

Both of the methods described above are for new scenes, or for scenes photographed for the first time. Usually, however, some shot previously exposed is desired for the background. Such a background can be used by turning the camera into a printer for the process. To begin with, the title is exposed the same as in the preceding method, with white letters on black paper or cotton velvet, and the niche is cut in the film at the start.

After the film is rewound, the strip of processed film containing the desired background is threaded in the camera along with the raw film. The shiny side is placed next to the lens so that the emulsion sides are together as they pass through the film gate. In making the film loops, it is best to make the loops of the finished film larger than those of the raw film. With panchromatic film this loading must be done in total darkness, and to the beginner a few practices are recommended with dummy

EACH FRAME LIKE THIS...



Easy with a WESTON

Possibly you're satisfied just to get an occasional picture as good as this . . . forgetting all the disappointments, all the wasted film, in between. Actually, however, you can do it every time . . . have each and every frame you take correctly exposed. All you need is a WESTON Exposure Meter! Then, no matter where or what you are shooting . . . you have complete control of your negative results. Why not get complete information on WESTON Exposure Meters now; find out how easy it is to have all your movies correctly exposed. Ask your dealer for a demonstration, or write for illustrated literature. Weston Electrical Instrument Corporation, 585 Frelinghuysen Ave., Newark, N. J.



INSURES PERFECT PICTURES WITH YOUR CAMERA

F-R PRECISION RANGE FINDER

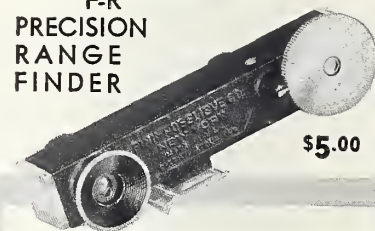

\$5.00

DON'T GUESS—BE SURE!

GET FINER RESULTS

For as little as \$6.00 the combined price of the F-R Precision Range Finder and the F-R Exposure Meter—you can provide yourself with the essential tools for eliminating the element of guess work from focusing and exposure problems. The F-R name—symbol of photography's trust value—unequivocally guarantees the dependability of these instruments.

\$1.00



F-R EXPOSURE METER



FINK-ROSELIEVE CO. Inc. NEW YORK • CHICAGO • LOS ANGELES

Kodachrome

MAPS • Charts • FINE TITLES

Geo. W. Colburn Laboratory

Special Motion Picture Printing

1197 Merchandise Mart, Chicago

film. It is also wise to try two films through the camera to see that the camera will accommodate both thicknesses satisfactorily. This applies also to single 8mm cameras (which, incidentally, must thread the second film with the emulsion side toward the lens, since this is the only way they will go through the camera right side up). Users of double 8mm cameras will have difficulty in performing this method, if not finding it impossible.

Now that the two films are threaded, the side is replaced on the camera, and the second exposure, or that of the background, made. This is done by pointing the camera at clear, blue sky and exposing at about F. 5.6 or F. 8 if a darker background is desired. These exposures are both approximate, since the light intensity of the sky as well as the density of the film being printed will vary. Focusing in such a case is unimportant. Indoors, the camera can be pointed at an electric light bulb held an inch or so away from the camera lens. With a 60-watt bulb so placed, an exposure of F. 11 should be about right.

Users of laboratory equipment such as printers and facilities for developing their own films will find still another method satis-

factory. In making the title, black letters on white paper are used and positive film is threaded in the camera. This is the usual procedure for direct positive titles but to get the motion a negative film is threaded in the camera along with the raw positive film. For good definition this negative should not be too dense and should be threaded with the shiny side toward the lens.

The exposure is made the same as though an ordinary positive title was being made. If the negative is thin enough, no increase in exposure is necessary, but with dense negatives a larger stop may have to be used. With two No. 1 photoflood bulbs in reflectors 9 inches away, F. 5.6 should be about right. In such cases a softer developing formula than is usually employed with positive film titles should be used in order to give the background warmth and not the usual harsh contrast.

The methods described here are the basic procedures. There is no end to the variations a worker can discover after he has made a few titles with moving backgrounds. Fades, dissolves, and all the other usual title tricks are just as possible as when there is no motion in the background.

Plan a treasure hunt . . .

• Continued from Page 274

struction cards giving exposure data for each location be installed on each stand.

In addition to the vantage afforded by use of the camera stands, there will be numerous other points from which one will wish to film, and the following suggestions on locations or approximate positions for setting up the camera may prove helpful:

Panorama of the Exposition: Shoot from deck of Ferry as it approaches Treasure Island.

Elephant Towers: Mount platform against the Ferry slip facing southeast. Also shoot from front of Administration Building facing northeast.

Court of Pacifica: From

entrance of cafeteria doorway at north end of Hall of Science; or from doorway, north end of Vacationland Building.

Tower of the Sun: From Court of Pacifica, looking south. From Court of Flowers near Triumphant Arch. From Court of the Moon.

Court of the Moon: From platform of Harbor Patrol dock; also, balcony of Administration Building.

Triumphant Arch: From base of Tower of the Sun or Court of Flowers.

Court of Flowers: From elevated walk encircling court; or from Temple Compound. Try telephoto shots from across Lake of the Nations.

Cambodian Towers: From entrance to Japanese Pavil-

BRILLIANT **RADIANT** **WIDE-ANGLE**
THE Hy-Flect SCREEN **PROJECTION**

HIGH IN QUALITY-LOW IN PRICE

Due to their distinctive glass bead surface, Radiant "Hy-Flect" Screens are recommended for brilliant, wide-angle projection, for lasting whiteness and for

dependable performance. They are durable and steady in their mechanical design—simple to set up and use—compact and light in weight. Life tested and proved immune to discoloration, cracking or peeling.

Available in four practical models: MODEL "T"—3-way tripod for use on its own tripod, for wall mounting or for use on a table. MODEL "S"—Box type. MODEL "W"—Wall type, and MODEL "L"—Radiant's popular-priced easel-type table model.

Distributed Exclusively by Albert

A Style for Every Purse and Purpose

THREE-WAY TRIPOD, MODEL "T"

30" x 40" retails	\$ 9.50
40" x 40" retails	11.95
36" x 48" retails	14.95

BOX TYPE MODEL "S"

30" x 40" retails	\$11.95
40" x 40" retails	14.50
36" x 48" retails	16.95
48" x 48" retails	18.50

Junior Models priced as low as \$2.00. See them at your dealer's first chance you get.

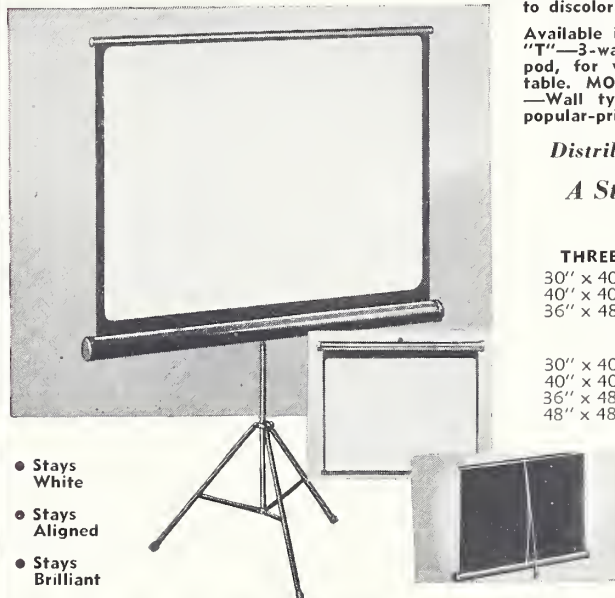

- Stays White
- Stays Aligned
- Stays Brilliant

ALBERT

NEW YORK • CHICAGO • LOS ANGELES
Main Office and Factory: 231 S. Green Street, Chicago

SPECIALTY CO.

Write Today for Illustrated Circular
Address Dept. F6

Start that new Camera on its career of Perfect Movie Making with

PANCHRO

SUPER REVERSAL

FILM



16mm. 9.5mm. double 8mm.

Plenty of speed for interior shots (Weston 16) as well as outdoor shots (Weston 24) on dull days with heavy overcast sky. Panchro's high color sensitivity, fine graininess and wide latitude contribute to the production of brilliant pictures of theatre quality. And for processing—Gevaert laboratories located throughout the world are organized to give you the fastest and at the same time the most efficient service—at no additional cost—purchase price includes this service—films are returned postage prepaid. For convenience to the user—when 400 ft. Gevaert Reversal Films are received for processing, Gevaert laboratories will return your films spliced on a 400 ft. spool ready for projection. You owe it to yourself and that new camera to provide this film for perfect movies.

Ask your dealer for Panchro Super Reversal or write to:

The GEVAERT COMPANY of AMERICA Inc
 423 West 55th Street, New York

Philadelphia . Boston . Chicago . Los Angeles . San Francisco . Seattle
 GEVAERT (CANADA) LIMITED . Toronto . Montreal . Winnipeg . Calgary

3 NEW REVERSAL FILMS

Provided with SPECIAL Black Colloidal Silver Backing. Fully Daylight Loading without Leaders. Finest Home Reversal Film Originally Made Double 8 Processed. PERFECT FOR ALL 8mm CAMERAS. Guaranteed Fresh. True Weston Speeds. Spools and Processing Extra.

Complete New Reversal and Title Instructions Free with Film Orders. Separately, 25c each. Cash, Check or Money Order for Quick Service, or C. O. D. Air Mail, 50c, and Special Delivery, 15c Extra. Overpayments Refunded or Credited.

NEW SUPER PANCHRO REVERSAL

Weston 24-16 Anti-Halo Backing
PERFECT for KEYSTONE 8mm CAMERAS NOW
Originally Made 8mm Film

33 ft. Double 8—Pre-scored.....	\$ 1.30
100 ft. Double 8—Pre-scored (16mm \$3.15).....	3.50
400 ft. Double 8—Pre-scored (16mm \$11.80).....	13.00
33 ft. Straight 8.....	.80
100 ft. Straight 8 (1 piece).....	2.00
400 ft. Straight 8 (4-100-ft. rolls).....	7.00

NEW MICROGRAN PANCHRO REVERSAL

Weston 12-8 (Extra Fine Grain), Anti-Halo Backing

33 ft. Double 8—Pre-scored.....	\$ 1.20
100 ft. Double 8—Pre-scored (16mm \$3.10).....	3.30
400 ft. Double 8—Pre-scored (16mm \$11.50).....	11.80
33 ft. Straight 8.....	.70
100 ft. Straight 8 (in 1 piece).....	1.85
400 ft. Straight 8 (4-100-ft. rolls).....	6.75

NEW HIGH SPEED ORTHO-CHROMATIC

Weston 16-6 Anti-Halo Backing
Prices Same as New Microgran Panchro

WESTON 8 SEMI-ORTHO REVERSAL

Weston 8-2 Darkroom Loading—Processing Extra

33 ft. Double 8 Scored—Clear or Lavender.....	\$.60
100 ft. Double 8 Scored—Clear or Lavender.....	1.50
400 ft. Double 8 Scored—Clear or Lavender.....	4.00
33 ft. Straight 8—Clear or Lavender.....	.40
100 ft. Straight 8—Clear or Lavender.....	1.00
400 ft. Straight 8—Clear or Lavender.....	2.75
100 ft. 16mm—All Tints Available.....	1.15
400 ft. 16mm—All Tints Available.....	4.00

CINECHROME REVERSAL

Weston 8-2—Violet Non-Halation Base

33 ft. Double 8—Not Scored.....	\$.75
100 ft. Double 8—Not Scored (16mm \$1.75).....	1.85
400 ft. Double 8—Not Scored (16mm \$5.50).....	6.00
33 ft. Straight 8.....	.50
100 ft. Straight 8—One Piece.....	1.15
400 ft. Straight 8—1-100 ft. Pieces.....	3.50

CINE-KODAK POSITIVE TITLE FILM

Darkroom Loading—Processing Extra

33 ft. Double 8—Not Scored.....	\$.60
3-33-ft. Rolls—Your Choice Assorted Colors.....	1.50
100 ft. Double 8—Not Scored.....	1.35
400 ft. Double 8—Not Scored.....	4.10
33 ft. Straight 8.....	.40
3-33-ft. Rolls—Your Choice Assorted Colors.....	.95
100 ft. Straight 8—One Piece.....	.93
400 ft. Straight 8—In 4-100 ft. Pieces.....	2.15
100 ft. 16mm.....	1.00
400 ft. 16mm—In One Piece.....	4.00
25 ft. 35mm—Safety, Clear or Purplehaze.....	1.00
100 ft. 35mm—Safety, All Tints Available.....	3.00

CAMERA SPOOLS WITH CANS

Double 8.....ea. \$.35	Filmo St. 8.....ea. \$.50
Univex St. 8.....ea. 20 16mm 50 ft.....ea. .35	Keystone St. 8.....ea. 35 16mm 100 ft.....ea. .65
Extra Cans, 100 ft. and 50 ft. 16mm size.....	\$.10
Extra Cans, Double 8 and Straight 8 size.....	.05
Non-Humidor Cans, 400 ft. 25c ea., 6 for.....	1.00

MISCELLANEOUS

BALA Precision 8mm Film Slitter, All Metal.....	\$2.50
FOTOFADE DYE, per bottle.....	1.00
FOTOFADE WIPE-OFF TAPE, per roll.....	.60
CINETINTS, Set of 6 COLORS and Instructions.....	3.00
BOLEX (CINELAC, Film Preservative, bottle.....	1.00
DUPONT VISCOSIL SPONGES, each.....	.35
DARKROOM APRONS PLOFILM, each.....	.75
HOW TO TITLE HOME MOVIES, Complete bk.....	1.00
HOME MOVIES, Back Issues, 1936-37-38-39.....	.15
(Not All Months) Back Issues for 1940, ea.....	.30

REVERSAL PROCESSING, PER ROLL

100 ft. 16mm (1 piece).....	\$1.50
25-30 ft. Double 8.....	.65
25-30 ft. Straight 8.....	.35

TITLE DEVELOPING, PER ROLL

100 ft. 16mm (1 piece).....	\$1.25
25-30 ft. Double 8.....	.75
25-30 ft. Straight 8.....	.40

WE STOCK EVERY MAKE FILM
Write for NEW Price List
A Personal Movie Service
Also Available Evenings, Sundays and
Holidays. Telephone Lincoln 1207.
W. Stuart Bussey Film Lab.
17 E. St. Joseph St., Indianapolis, Ind.

ion, or from entrance to Mission Trails Building.

Federal Buildings and Lake of Nations: From platform at base of Cambodian Towers.

Pacific Basin Area: From arch bridge crossing Lake of Nations.

Color keynotes this big show of the West, and while Kodachrome film will travel through most of the cine cameras clicking night and day at the Exposition, black and white filming can be made colorful, too, by the use of filters. After the breeze, which blows gently through Golden Gate Park, sweeps the early morning fog away, the sky is a deep blue; and on some days soft, fleecy clouds go scudding by, making it a paradise for filmers desiring beautiful cloud effects in their scenes. So, if you're shooting black and white—that is, "pan" film—be sure to bring along a filter or two.

And while we're on the subject of color we'll give a few pointers on shooting the colorful night displays in Kodachrome. Most cameras with variable speeds can be made to operate at less than eight frames per second—

nearer to six—simply by moving the speed adjustment beyond the 8 F. P. S. mark.

The following table of exposures were found to net good results last year on night shots filmed in Kodachrome type "A" at a speed of one frame per second (5/8 of a second exposure):

Elephant Tower.....	f/2
Pacifica.....	f/2
Tower of the Sun.....	f/2
Court of the Moon... ..	f/1.5
Court of the Flowers ..	f/1.5
Cambodian Towers.. .	f/2
Federal Bldg. Murals ..	f/1.5
Gayway	f/1.5

To those who will be film the Exposition for the first time this year, we advise purchasing a map and guide before exposing a single foot of film. Study the location of each point of interest and its relation to the sun, so you can plan to shoot each spot at the time of day when sunlight will be most advantageous. Then, combining the guide book information with what has preceded here, you will have ample data on which to systematically plan your search for cinematic treasure at Treasure Island.

Movie of the Month...

Continued from Page 280

technique with which it was executed—plainly the result of applied study to that branch of art of making pen and ink pictures move on the screen.

Casually thumbing through the pages of a HOME MOVIES issue several years ago, Turner saw opportunity to capitalize further on his artistry by sketching title background designs. It wasn't long aft-

erward that he succumbed to the urge to film movies, too, and purchase of a 16mm camera followed.

It was only natural that he should toy with the idea of making animated cartoons. He had the imagination and the artistic ability to create and execute interesting pictures on paper. What he lacked was the knowledge of just how pen and ink sketches were made

All Amateurs, whether subscribers of HOME MOVIES or not, are invited to submit their films to the editors for review and helpful criticism. Unless otherwise requested, reviews of some of the films which we believe would benefit other amateurs will be published each month.

Reviewed films will be rotated one, two, three, and four stars, and films qualifying for two or more stars will receive free, an animated leader indicative of such award. Detailed reviews, with suggestions for improvement—if any—will be mailed to amateurs submitting their films.

Exceptional films qualifying for the distinction of the "Movie of the Month" will be treated in detail in a feature length article in a following issue of HOME MOVIES. In addition, a certificate evidencing the award of "Movie of the Month" and a special animated "Movie of the Month" leader will be returned with such films after review.

When submitting films for review and analysis, please advise make of camera, speed of lens, whether or not tripod was used, or if you used filters, exposure meter, or other accessories. While this information is not essential to obtain analysis of your film, we would like to pass it on for the benefit of other amateurs.

THRIFTY Quality FILM

Gives You BETTER Films at Lower Cost

THRIFTY ORTHOTYPE \$1.60
For OUTDOOR... non-halation base, fine grain, fast, Weston 8—the film you've been wanting to find at an unheard-of low price. Machine processed. Per 100 ft. rolls.....

THRIFTY PANCHROMATIC	THRIFTY SUPER-PANCHROMATIC
Use for all types of shooting. High-speed Weston 16 daylight—10 photofloods, machine processed. Per 100 ft. rolls..	Super-fast; high sensitivity, requiring minimum of light. Weston 16 daylight—32 photofloods, machine processed. Per 100 ft. rolls..
\$3.75	\$4.25

California Buyers Include Sales Tax

THRIFTY FILMS

Drawer 98, Watts Station Los Angeles, Calif.



Enjoy the finest advantages of "professional" cameras—fade, superimposition, lap dissolves, animation, slow motion, etc. Get terms to suit you, as little as \$21.41 a month. BOLEX cameras are complete, there are no costly "extras" to buy. F/1.5 lens and carrying case. With Leitz Hektor Rapid F/1.4 lens, \$20.00 additional. Write for details to Dept. HM-4.

Trade In Your Old Camera— Liberal Allowance

FORDHAM ELECTRIC CO., Inc. 2563 Webster Ave. New York City (One-Half Block No. of Fordham Road)

Safe Summer Storage FOR YOUR FILMS IN YOUR OWN HOME

VapOrate your films NOW for protection against summer's sticky humidity.

Better photo finishers offer you VapOrate Permanent Protection against CLIMATE, WEAR, SCRATCHES, OIL, DIRT, WATER and FINGERMARKS for your still negatives.



VAPORATE CO., INC. 130 W. 46th St. New York	BELL & HOWELL CO. 1801 Larchmont Chicago 716 No. La Brea Hollywood
---	--

- ★ ★ ★ ★ ★ OUTSTANDING MONEY SAVERS
- ★ LIKE NEW ★ Filmo 70 superspeed for slow motion, f1.5 (regular \$212), \$105.
- ★ REFLEX ★ Victor 3, 5-speed, Cooke f1.8 (regular \$160), \$89.
- ★ SPECIALS ★ Filmo 8mm projector (regular \$118), \$74.50.
- ★ ★ ★ ★ ★ Kodascope L 16mm with case (regular \$205), \$94.50.
- ★ ★ ★ ★ ★ Ihagee 4 x 6, 6 1/2" f4.5 ZT (regular \$175), \$65.
- ★ ★ ★ ★ ★ Primarlex f3.5 (regular \$165), \$95. Graflex, 3 1/4 x 4 1/4, f4.5 (regular \$110), \$54.95. Twin-lens Kamrad, 2 1/4 x 2 1/4, f4.5, New! (regular \$55), \$39.50.
- ★ ★ ★ ★ ★ Sound-Silent Film Library. Trades accepted, easy terms, Bargainews free.
- ★ ★ ★ ★ ★ MOGULL'S 55 West 48th St. New York, N. Y.

FOTOFADE

FADES, WIPES Can be added to your Reels after Processing WITH FOTOFADE on black and white or color films. Price \$1.00. Waterproof Wipeoff Tape, 60c per roll. Complete FOTOFADE Kit.....\$1.60 CINETINTS for coloring your 16mm or 8mm film. Set of six colors \$3. At your Dealer or direct.
DYE RESEARCH LABORATORIES 318 Jackson Street Los Angeles, Calif.

GOERZ KINO-HYPAR LENSES



f:2.7 and f:3

For regular and color movies of surprising quality—high chromatic correction . . .

Focal lengths 15mm to 100mm—can be fitted in suitable focusing mounts to Amateur and Professional Movie Cameras.

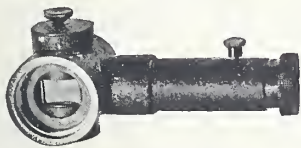

GOERZ Reflex FOCUSER

— Patented —

For 16mm Movie Cameras—voids PARALLAX between finder and lens—provides full-size ground-glass image magnified 10 times. Adaptable to lenses 3" and up. Also useful as extension tube for shorter focus lenses for close-ups. Extensively used in shooting surgical operations, small animal life, etc.



GOERZ Parallax-Free FOCUSER and FIELD FINDER CONTROL

No more off-center pictures, for Filmo 121 and Simplex-Pockette magnifies 4 and 8x.

For Detailed Information Address Dept. HM-6

C. P. Goerz American Optical Co.

317 East 34th St., New York

American Lens Makers Since 1899

to move when photographed by a movie camera. After considerable experimenting and no little disappointment Turner wrote to an acquaintance close to the motion picture industry in Hollywood, asking if it would be possible to secure some of the cast-off sketches made by one of the Hollywood cartoon-picture makers. This friend succeeded in obtaining a complete sequence of "cells"—celluloid sheets or cards on which were sketched a popular cartoon character in a sequence of movements.

With these "cells" to study, Turner was able to understand the technique of making drawings on celluloid sheets, and the timing and degree of movement necessary in each drawing to produce the illusion of smooth movement in the finished picture. Considerable practice followed and, after Turner began to get his animation "sea legs," he ventured boldly forth on "Peetie." That was three years ago.

Most of his spare hours since have been devoted to drawing, animating, filming and editing "Peetie." On April 10 last, a final editing was given the film; then it was packaged and sent to HOME MOVIES for review. In the letter which accompanied the film, Turner states:

"I put three years of my spare time on 'Peetie' and made it entirely by myself. All the photographing was done with a model 'E' Eastman Cine Kodak which, as you know, is not equipped with a single frame attachment; and if anyone thinks that it was easy to get single frame movement without this feature, they have things all wrong!

"All drawings were mounted on pegs 18 inches from the camera, and two No. 2 photofloods without reflectors were set 18 inches from center of titling board at a 45-degree angle. Lens was set at f/5.6. The drawings were made on clear celluloid of No. .003 gauge, white bond paper, and Strathmore illustrating board. India ink was used for outlines and the solid black areas, and show-card colors for the gray tones."

The story involves the title character, Peetie, in a

series of escapades which begin with Peetie reading about a magic scroll. According to legend, this scroll lay buried on some far-away cannibal island. It possessed magic powers of providing the owner with his every wish, a fact particularly appealing to Peetie, who is broke and just cut off by the milkman because of an unpaid bill.

Peetie goes out to steal milk from a neighbor's step and while running away from an imaginary pursuer falls into a deep well, and comes up at the North Pole on the other side of the world! Here he is chased by a hungry polar bear, and while attempting to escape falls into the sea through an open crevice in an ice floe and is carried away on the back of a gigantic fish. Presently he is tossed up on land again, which turns out to be a cannibal isle.

Here Peetie begins his search for the magic scroll, finds it in an old buried chest and, just as he is about to make a wish, is set upon by a horde of cannibals, captured and made ready for the stew kettle. In the excitement, Peetie has forgotten his magic scroll. Presently he brings it into play, wishing he were back home and, presto! he finds himself back on his own doorstep!

Home again, he practices further with the magic scroll. While revolving a globe in the parlor of his home his attention is drawn to the name of Turkey which reminds him of his hunger. This suggestion brings his magic scroll into play with a wish for turkey, and the picture ends with Peetie being snowed under with an avalanche of baked turkeys.

We believe Turner's remarkable success in his first animated cartoon venture will be an inspiration to other amateur movie makers skilled with pen and ink. We believe, also, that those not so well gifted will be urged to try animation, using simple "hair-line Harry" sketches or jointed dolls. Animation, as no other branch of movie making art, affords the amateur filmer wide latitude for developing his inherent artistic abilities.

The creators of Mickey

Bill Besbee says:

Take a Besbee Title Letter Set on your vacation and bring back a FINISHED FILM!

TITLE YOUR MOVIES OUTDOORS!

Title as you go, right on the spot! You'll be sure of having the date, time, place and all surrounding circumstances. Your titles will be right in place in your film—appropriate, clear, effective. And it's lots of fun making movie titles "on location." All sorts of suitable backgrounds are available, and you are provided with a fascinating outlet to your own ingenuity in finding the right one to give flavor and meaning to your shots.

BESBEE STICK-ON Rubber TITLE LETTER SETS

. . . make titling "as you go" easy. Being 1/4 of an inch or 1 inch high, they are large enough to stand out on such backgrounds as rock or sand surfaces, tree trunks, back of a car, the car's windows or windshield, a wooden fence, etc. Made with a special backing. Besbee Stick-On Rubber Letters will hold fast to any surface. Clean-cut, solid letter effects, with sharp outlines. Silver, black, blue, or red. Light in weight and contained in a special carrier. Try outdoor titling . . . no setting up of light, just give the same exposure you use for action shots. Complete set of 150 letters for only **\$5.25**

CENTER ATTENTION WITH CLOSEUPS

You can center attention on anything, no matter how small, by means of the close-up. And you'll bring detail to pictures that will "snap" up their interest tremendously. Close-up movie-making is now simplified by the BESBEE CLOSE-UP ADAPTER. Try it, and see for yourself.

BESBEE CLOSE-UP ADAPTER KIT No. 52

Consists of adjustable lens holder, universally attached to any 8mm or 16mm camera . . . 2 close-up lenses for sharp pictures at 10" and 30" distances . . . tripod table for firm support of lens holder when tripod is used . . . special handle for all outdoor hand-hold camera shots. **\$3.75**

BESBEE CLOSE-UP LENS SET No. 53

Six additional auxiliary close-up lenses for sharp pictures at 7, 12, 15, 18, 24 and 27 inches. **\$4.00**

Ask for Besbee at your dealer's, or write to Albert Specialty Co. for more details.

ALBERT

SPECIALTY CO.
231 S. Green St., Chicago, Ill.

FRAME MOVIES DIFFERENTLY!

Use the BESBEE EFFECT-O-GRAPH . . . it lets you frame each movie in its own individual outline. Has 10 masks, and 5 different pairs of iris-in and iris-out effect shutters. Also acts as lens hood . . . makes unusual back-lighting effects. **\$10.50**

ALBERT SPECIALTY CO.
231 S. Green St. Chicago, Ill.

SOLAR FILM

Costs Less!



Whether you spend much or little for your movies, get the film that gives you better pictures for less. Your dealer has SOLAR FILM or can quickly get it for you. If more convenient, order direct from this ad and mention dealer's name.

	Weston	16mm	16mm	Dbl.
	Rating	100 ft.	50 ft.	8mm
Solar ECONOMY Outdoor	. 8	\$2.50	\$1.75
Solar SUPER Outdoor	. . . 12	2.95	1.95	\$1.39
Solar HI-SPEED 24	5.50	3.25	2.00

Prices include processing at our Chicago, Miami, or Arlington, California, plants, and return postpaid to you. One of three Solar Processing Laboratories is less than 24 hours from 90% of all movie camera fans. Learn more about these low-cost Solar films. Try them. Ask your dealer. Write for descriptive literature, today.

Dealers
Write for
Special Offer

SOLD BY
OVER 300
LEADING DEALERS
IN 49
PRINCIPAL CITIES

SOLAR CINE PRODUCTS

INCORPORATED

3827 Archer Avenue, Dept. 1A
CHICAGO, ILLINOIS

Take Your MOVIES with



A FULLY GUARANTEED PRODUCT
with a long record of satisfied service.

MOVIE MASTER CAMERA FILMS
make **GOOD PICTURES** easy to take.
Past Processing Service

	100 ft.	50 ft.
Movie Master Ortho.....	\$2.50	\$1.50
18 Scheiners, Weston Daylight 8		
Movie Master Panchro.....	\$4.25	\$2.50
23 Scheiners, Weston Daylight 24, Tungsten 16		
Movie Master Colortone.....	\$6.00	\$3.00
A Colortone Process (Not Natural Color)		

MOVIE MASTER FILM CO.
Ridgefield Park, N. J.

PERFECT EXPOSURE

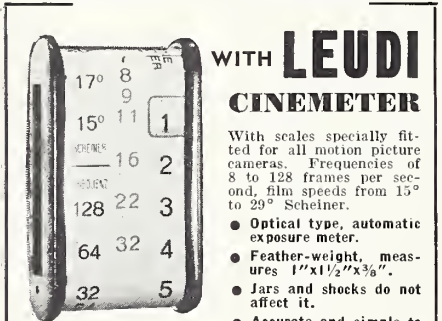

WITH **LEUDI**
CINEMETER

With scales specially fitted for all motion picture cameras. Frequencies of 8 to 128 frames per second, film speeds from 15° to 29° Scheiner.

- Optical type, automatic exposure meter.
- Feather-weight, measures 1" x 1 1/2" x 3/8".
- Jars and shocks do not affect it.
- Accurate and simple to operate.

Packed in attractive, durable, Bakelite case..... **\$2.15**

Literature on Request

MIMOSA AMERICAN CORP.

485 Fifth Avenue New York City

Your Own Metal Title Letters

Ask for Samples of the Most Beautiful Capital and Lower Case Letters Made



Complete Sets in Wood Case, 222 Pcs. . . . \$7.16
126 Caps Only . . . \$4.28
AN INTERESTING ADDITION TO YOUR MOVIE HOBBY
Specify White or Black Letters
KNIGHT & SON, INC. P. O. Box B, Seneca Falls, N. Y.

REDUCTIONS
ENLARGEMENTS
DUPLICATES
GEO. W. COLBURN
LABORATORY
1197 MERCHANDISE MART
CHICAGO

30' 8mm Semi Ortho Univex Type . . . \$.65
2 for . . . \$1.10
25' 8-8mm Semi Ortho . . . 1.00
2 for . . . \$1.75
Including processing and return postage.
"A New Spool if Proper Exposure Produces Poor Results"
CHAUTAUQUA MOVIES
91 NEWTON AVE. JAMESTOWN, N. Y.

Mouse, Porky Pig, Oswald Rabbit and others who now rank as foremost producers of animated cartoons reached their individual pinnacles after crashing the gates of Hollywood the hard way — without benefit of a home movie camera to aid their early study of animation.

200 foot 8mm film magazine

• Continued from Page 286

small bolts and rivet them over on the threaded end. See accompanying sketch.

Scrape the galvanized metal and the door frame bright where they meet on the outside. Flow solder freely at this point, all around the frame. The solder will not adhere very well to the door, but will stick with a vengeance to the galvanized metal and flow down between the two, thus creating a light-proof joint that could not be otherwise achieved.

Bend a piece of cardboard 1 3/4" wide and 30" long around the magazine fence, cutting and trimming until it makes a good fit all around. You will find that after allowance is made for the portion of the door that is on a different plane than the rest, the cardboard will be about 1 1/4" wide where it goes over the top of the magazine. Using the cardboard as a pattern, cut the magazine rim thus formed from metal and solder it in place against the 1/2" high fence around the magazine side. A study of the sketch will clearly show the result of this operation.

While you're cutting and soldering, you might as well make the cover. Simply lay the magazine, open side down, on the sheet metal and draw a line around it. Cut this piece out. Cut a strip of metal 1" wide and 30" long. Bend this strip to shape as shown and solder it to the cover so that it will go inside the magazine freely with 1/8" to spare all around. No, it's not light-proof now, but it will be.

Now we'll do the mechanical work. We know that's been bothering you. Place the reel inside the magazine so that there is 1/2" clearance all around the top. Mark the spot where the

shaft hole occurs and remove the reel. Punch a hole at this point and enlarge it to 5/16". Projection reels just fit over 5/16" shafts, so you'll need a piece of brass rod of this size about 4" long.

Next, make up a metal cylinder 2" in height and 1 1/2" in diameter. Flare the lower half inch out so that it will fit flat against the magazine, over the shaft hole. Solder a metal disc into the top of the cylinder and put a 5/16" hole in its center. That completes the light trap cover, and the 5/16" holes in the cover and magazine will form the bearings for the reel shaft.

Solder onto the shaft, about an inch from one end, a metal disc slightly smaller than the inside of the light trap cover. Slip a couple of washers over the shaft and slide it through the hole in the cover from the inside. Now cut a disc the same size as the inside of the cover, with a center hole somewhat larger than the shaft. Slide this disc over the shaft and halfway into the cover where it is soldered in place against the side. Now cut a disc, a duplicate of the first one, and solder it in place on the shaft at a point just inside the flared rim of the cover. The free end of the shaft is passed through the hole in the magazine and held in a position perpendicular to the sidewall of the magazine. Then the light trap cover is soldered in place against the outside of the magazine. The shaft should turn freely now, and an examination of the cross section in the sketch will show that there is no possibility of light entering around the shaft hole and making the bends that would be necessary for it to pass the baf-

FADE-O-SCOPE™
CAMERA DISSOLVE
with
POLAROID®
Lenses
*T. M. Reg. U. S. Pat. Off.

for **PROFESSIONAL FADES**
and **LAP DISSOLVES!**★

- Gives the *smooth, continuous* action and transitions of finest **PROFESSIONAL** pictures.
- Operates **EASILY** by simply moving lever up or down.
- Fits **ANY** camera; performs perfectly on 16 mm. or 8 mm.
- Attached or removed in a minute; carried like a watch.

WRITE TODAY for full descriptive literature on this new, amazing aid to better picture making.

★ For Lap Dissolves camera must have back wind.

FADE-O-SCOPE, Inc.
200 FIFTH AVENUE, NEW YORK, N. Y.

STOP - DON'T SHOOT!
Make a test first. Learn how those Special Lighting, Trick Shots, or Filter Effects turn out before you shoot the whole roll. With Corona's new exclusive **TEST-STRIP** Service, you will avoid disappointing results.
We will process your Test-Strip (double 8, single 8 or 16mm) up to 10 feet for only 25c. Titles may be included.
For accurate results, please state type of film used. Film developed as negative upon request.

SAVE \$ \$ \$
With **GEVAERT BULK FILM**
(16mm and Double 8 Scored)

PANCHRO SUPER REVERSAL, ANTI-HALO			
	Weston	100 Ft.	2 Rolls
16mm	24-16	\$3.25	\$6.00
Double 8	24-16	\$3.50	
ORTHO REVERSAL, ANTI-HALO			
16mm	16-6	\$2.80	\$5.25
Double 8	16-6	\$3.00	
CORONA SEMI-ORTHO - WESTON DAY - 8			
	Double 8 Scored or 16mm		
100 ft.	\$1.25	400 ft.	\$4.00
Films notched on request. Prices do not include processing. Write for special club offer.			
REVERSAL PROCESSING — 16mm and 8mm.			
100 ft.	85	50 ft.	65
	25 ft.		35
All Orders Shipped Postpaid Except C. O. D.			
CORONA FILM LABORATORIES			
200 East 34th Street		Brooklyn, N. Y.	

GENUINE
Kodachrome Titles
16mm - 8mm
MAIN TITLES in art display two color shadowed letters, on any color background.
Up to 8 words.....95c
Each added word.....12c
SUB-TITLES any color words on any color background.
Up to 8 words.....60c
Each added word.....8c
"THE END" title in art display shadowed letters same as in main title, 35c each.
Send for Descriptive Literature
Exclusive with
ORBIT FILMS
5437 1/4 Hollywood Blvd. Hollywood, Calif.

SHOOT THE WHOLE FAMILY!
HOME MOVIES-Only 10¢ a Day!
Nationally Advertised! 10-Day Trial!
Entertain with real movies of children, sporting events, trips, etc. Latest model Movie Cameras and Projectors, 8MM and 16MM sizes. For homes, business, churches, schools and clubs. All accessories. Satisfied Customers throughout the World. **MONEY BACK 10-DAY TRIAL** on all Cameras and Projectors. **SMALL DOWN PAYMENT. Balance AS LOW AS 10¢ A DAY.** FREE details, write: **DON ELOER'S HOME MOVIES, 739 BOYLSTON ST., Dept. L-6, BOSTON, MASS.**

ORDER FOR SUBSCRIPTION

Home Movies Magazine

12 MONTHS FOR \$2.00 IN U. S.

In Canada, \$2.00; Foreign—\$3.00

SPECIAL OFFER: 3 Years for \$5.00 in the U. S.

HOME MOVIES

1060 Sunset Blvd.

Hollywood, Calif.



Send to.....

Address

City..... State.....

New Renewal Gift

Send to.....

Address

City..... State.....

New Renewal Gift



Enclosed find \$..... Date.....19.....

Sent in by.....

Address

City..... State.....

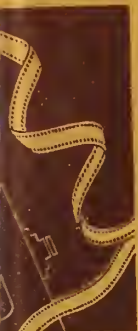

NO SUBSCRIPTIONS ACCEPTED FOR LESS THAN ONE YEAR



fles and enter the magazine.

Place a ruler across the open side of the magazine and mark the place where it touches the shaft. Cut the shaft off at this point and cut a key slot about one-half inch long.

A one-inch pulley must be fastened to the outside end of the shaft. A one-inch brass erector pulley is just right for our purpose and easily obtainable in any toy store. The hole in the pulley is too small for our shaft, so you can either turn the shaft down to fit it or enlarge the pulley hole and secure it to the shaft with solder. A pair of washers should go on first and the pulley put on so that it rests against these washers. Thus the washers inside and outside the light trap will prevent much end play in the shaft, although a little will not matter.

It is necessary that a ratchet be placed on the pulley so that the shaft cannot rotate as the camera is wound, otherwise film would be unspooled from the take-up reel in the magazine. The ratchet wheel from an old alarm clock or spring motor or any other small gear will do. Solder it to the small pulley and place a ratchet key on a stud soldered to the top of the cover, so that the key rests against the ratchet. This is shown in the photographs more clearly than it can be described here.

Now we need a three-inch drive pulley on the camera's wind shaft. Three-inch erector pulleys are sold in halves so that when they are bolted together a groove is formed in the edge. This groove, however, is too wide for us, so we simply bolt ONE half to a piece of the galvanized metal and cut around the pulley, thus forming a narrow groove.

Some type of finger grip is required to turn the pulley when winding. A piece of the galvanized metal, bent to form a "T" and bolted to the pulley along with the piece of circular galvanized, but on the opposite side, worked out fine for us. See photographs.

Don't try to duplicate the threads inside the winding key — they're left handed. Simply solder the key itself to the back of the pulley, being sure that it is cen-

This Summer.. Make Better VACATION MOVIES

with this professional FADE-IN & FADE-OUT and these 6 POPULAR MASKING EFFECTS

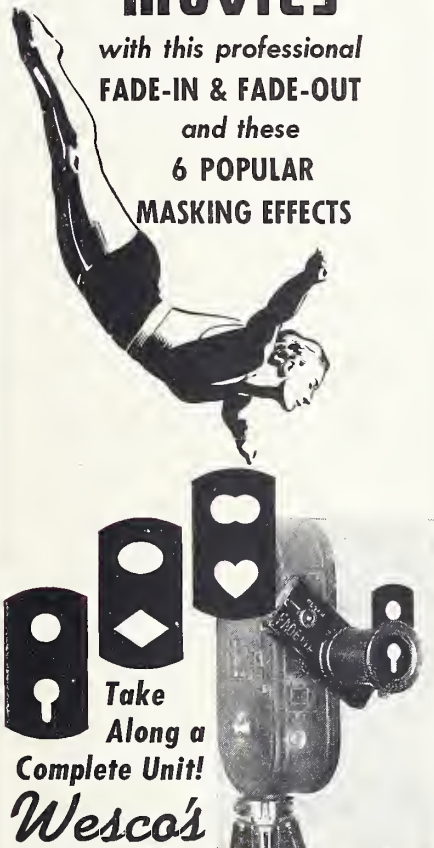

Take Along a Complete Unit! Wesco's

FADETTE combined with

FADE-O-MASK

regular price \$8.45

specially priced **\$7.75** complete with holder and three double masks

Above, Fadetite and Fade-O-Mask combined on Keystone Camera

WESCO FADETTE is the only vignetter on the market made to produce a rectangular fade at ANY desired speed. Gradual Fading—In or Out—Fast or Slow at the will of the operator and NO SUDDEN SHUT OFF at the end. No metal shutters to rust. Light weight . . . rugged construction . . . 5 moving parts. Fits all cameras, 8 or 16 mm, $\frac{3}{8}$ " to $1\frac{1}{2}$ " lens collars. No interference with view finder. Comes with cable release and a Wesco filter holder, accommodating 25 mm round filters. Available in models to fit most all movie cameras. **\$5.95**

Special adaptor for Eastman lenses . . . 75c

When ordering, give outside diameter of lens and specify make and model of camera

WESCO FADE-O-MASK holder, which is ruggedly constructed of durable tenite, takes the place of filter holder on the Wesco Fadetite. The non-inflammable and indestructible holder is attached quickly and easily to the Fadetite. The Wesco Fade-O-Masks are of thin flexible pyralin and are quickly and easily interchangeable. Smartly designed and perfected by experts . . . the Wesco Fade-O-Masks give the movie maker on unlimited range of novel effects to express the thought or character of the scene photographed. **\$2.50**

Ask Your Dealer for a Demonstration.

WESTERN MOVIE SUPPLY CO.
254 SUTTER STREET SAN FRANCISCO

LEARN PHOTOGRAPHY from Experts
Thorough, practical training. For pleasure or career. All phases of photography. Commercial, News, Portrait, Advertising, Motion Picture, Color. Teaching staff of noted authorities. 30th year. Send for free booklet.
New York Institute of Photography
10 West 33 Street (Dept. 114) New York City

tered. Flow solder freely all around the key, handle and all so that it is imbedded in the solder and a good firm joint. The addition of a spring belt from a projector completes the take-up mechanism.

The footage indicator is a comparatively simple device consisting of a $\frac{1}{8}$ " brass rod bent to conform to the shape of the inside of the magazine, this curved section being long enough to reach from the reel shaft to a hole punched in the magazine side between the rim and the reel on the same horizontal line as the shaft. See photographs and sketch. The rod makes a right angle turn and goes out this hole, where it is light-trapped in the same fashion as the reel shaft, except, of course, the parts will be smaller. A metal disc is soldered on the outside end of the rod and a small notch filed in its edge. The curved portion of the rod goes between the flanges of the reel next to the magazine wall. The counter may be calibrated by placing a reel on the shaft, of the type that has footage marked on its side. Hold the rod opposite these marks and mark the various points on the outside of the magazine where they come opposite the notch in the metal disc so that the position of the disc will indicate the position of the rod on the inside and thus indicate how much film is on the reel.

The last operation on the magazine is the placing of a roller on the inside, just opposite the upper camera spool spindle. See photographs. This roller may be made up by pushing the lead out of a round pencil and slipping it over a piece of the same rod that made up the counter arm and soldering it inside the magazine. Or you can use the handle from a crank taken from an old crank winding camera, as we did. Either one works.

Another roller is made up by cutting away the flanges from a Univex spool, leaving only the core. A length of dowel is placed against this hub and the whole business wrapped with paper sealing tape. This roller is placed over the upper spool spindle and prevented from falling off by a rod com-

GREAT VALUES OUT OF NEW FREE LAFAYETTE CATALOG

REELS AND CANS

Reel values! Made of heavy aluminum. Patented sprocket device accommodates every type reel arm. Humidors of heavy gauge aluminum.

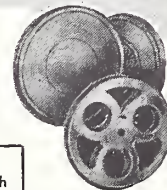

8 mm. Reel **29c** Each
8 mm. Can **6 for 1.69**

16 mm. Reel **39c** Each
16 mm. Can **6 for 2.27**

REEL CLIPS
8 mm.—6c ea.
12 for 67c
16 mm.—8c ea.
12 for 89c

FILM STORAGE CHESTS

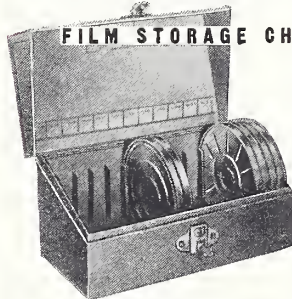

8 MM.
6-Reel Capacity **\$1.85**
12-Reel Capacity **\$2.55**
16 MM.
6-Reel Capacity **\$2.25**
12-Reel Capacity **\$2.95**

FILM CEMENT

1 oz. bottle **18c** 4 for **69c**
1/2 oz. bottle **9c** 4 for **29c**

ORDER NOW!

Economy TRIPOD SCREEN



Superfine quality 30x40 inch tripod screen. A new patented fabric surface processed to act as a light filter, giving intense light without glare. Sets up easily and quickly. Non-scratch rubber feet.

ONLY \$4.89

CLIP YOUR ORDER TO COUPON

Save time and money! Just enclose this ad, or any part, or note attached to coupon, along with your check or money order. Mark each item you desire and mail today.

ALL MERCHANDISE GUARANTEED

SEND FOR THIS BIG FREE CATALOG!

IT'S BRAND NEW!



A whole book of great values in photography! Complete, up-to-the-minute, packed with all the latest nationally advertised cameras and equipment. It's money-saving! Send coupon for your FREE copy at once!

LAFAYETTE CAMERA

NEW YORK
CHICAGO
ATLANTA
BOSTON
NEWARK
BRONX, N. Y.
JAMAICA, L. I.

LAFAYETTE CAMERA
DEPT. 80F—100 SIXTH AVE., NEW YORK, N. Y.

I ENCLOSE \$..... RUSH MY ORDER
 PLEASE RUSH FREE CATALOG No. 81

NAME

ADDRESS

CITY

STATE

DON'T WAIT!

Get Acquainted NOW with the

A B C

of Dependable 16mm Reversol Film

PEERLESS A—A reliable high-grade outdoor film. Moderately priced, yet superior in rendering high-quality results.
100 Feet Daylight Loading.....\$2.00
Weston 6, Scheiner 18

PEERLESS B—A non-halation base outdoor film. More highly sensitive than Peerless A, yielding excellent results.
100 Feet Daylight Loading.....\$2.75
Weston 12, Scheiner 18

PEERLESS C—A perfectly balanced panchromatic fine grain film for indoor or outdoor use. Thoroughly non-halation, producing brilliant pictures.
100 Feet Daylight Loading.....\$3.50
Weston 24-16, Scheiner 23-21

Above Prices Include Processing and Postage

Complete Professional Laboratory Service for the Amateur Movie Maker

All Prices Apply to Finished Film Per Foot

35mm Negative to 16mm Positive.....	\$.03
35mm Positive to 16mm Positive.....	.04
16mm Negative to 16mm Positive.....	.025
16mm Positive to 16mm Positive.....	.035
16mm Negative Developed.....	.015
16mm Positive Developed.....	.01

Minimum Charges on Any Above Order, \$1.00

16mm Panchromatic Reversal, 100 ft. or less.....\$1.00
16mm Reversal Orthochromatic, 100 ft. or less.....\$.75

FREE BOOKLET RS—Our specially low priced list of laboratory packed film.
Write for BOOKLET FL—Our complete list of 8mm and 16mm library subjects for sale or rent. Sound or silent.

PEERLESS CAMERA & FILM SERVICE

7-11 West 45th Street
NEW YORK CITY

11 River Drive
PASSAIC, N. J.

Save ON PHOTOGRAPHIC EQUIPMENT

Write for our **FREE CATALOG** no obligation!

Our large turn-over permits us to sell for less! Complete line of "Still" and "Movie" equipment.

SUNNY SCHICK

National Brokers
403 W. WASHINGTON BLVD.
FORT WAYNE, INDIANA

MODERNIZE—Trade in Your Equipment!

DON'T PAY HIGH PRICES FOR FILM

BUY ONYX 8 FILM FOR LESS

100 ft. 16mm	\$2.00
25 ft. double 8	\$1.00
30 ft. for Univex	50c

Minimum Order \$1.00

Reversol Free of Charge

Write for price list of all types and grades of film. Processing chemicals for Home use.

KENWOOD FILMS
1231 E. 46th St. Chicago, Ill.

IN PHILADELPHIA

CAMERAS

and Everything Photographic

KLEIN & GOODMAN

18 S. 10th STREET

Kodachrome Main Titles

16MM KODACHROME	1.00
8MM KODACHROME	.50

SAMPLES—INFORMATION—PRICE LIST UPON REQUEST

FRANCIS S. NELSON
737 MICHELTORRENA ST. LOS ANGELES, CAL.

ing over from the roller installed in the magazine. Consult photographs showing this roller.

Nothing remains but to switch doors. The rivets are filed off the camera hinge and the original door removed. The magazine is placed in position and the hinge secured with the rivets that will be furnished with the replacement door.

A strip of black felt is fastened to the cover flange with bicycle rim cement so that a tight job will result when the cover is forced into the magazine. A coat of flat black paint inside and a protective coat outside completes the job. The color of the Univex may be closely duplicated by mixing equal parts of medium brown

enamel and walnut stain, to which is added a small amount of bronze powder. Stippling with a brush when the paint is about half dry will produce a crackle effect.

If your nose bumps the wind key as the camera runs and your eye is jammed against the viewfinder, you may unscrew the metal ring on the finder and drop it into a spigot connection and screw it back on, as illustrated. This will make an eyepiece for you and keep you far enough away that your nose will not interfere with the belt or pulley.

Well, that's about all there is to it. You now own an 8mm movie camera with a 200-foot capacity, which is something you can't buy.

Backyard Movies . . .

• Continued from Page 271

hands as if to quiet the children and hushing them up.

Scene 15—Long shot of all eating breakfast.

Scene 16—Semi-closeup of Mary daintily eating.

Scene 17—Semi-closeup of Helen dawdling.

Scene 18—Semi-closeup of Bobby eating hurriedly.

Scene 19—Semi-closeup of Mother looking thoughtfully at each of them.

Scene 20—Medium shot of Bobby eating, stopping momentarily as if he was listening to something outside of the house, and then beginning to eat again. He quickly gulps two or three mouthfuls and then hastily gets up from the table.

Scene 21—Semi-closeup of Mother saying:

Title—"We need some water for the dishes, son."

Scene 22—Semi-closeup of Bobby looking disappointed and saying:

Title—"Aw gee, Mom, Bud just called me. I'll fetch some water later."

Scene 23—Semi-closeup of Mother resignedly assenting and nodding her head in the affirmative.

Scene 24—Medium shot of Bobby quickly leaving the table and running to the door.

Scene 25—Closeup of Bobby's napkin falling to floor and lying on floor.

Scene 26—Closeup of Mother shaking her head.

Scene 27—Medium shot of Helen getting up from ta-

ble, leaving crumpled napkin on table.

Scene 28—Closeup of crumpled napkin on table.

Scene 29—Medium shot from right angle of Helen walking into next room and sitting down in chair, picking up a book and reading it.

Scene 30—Medium shot of Mother turning her head and saying:

Title—"How about clearing off the dishes, dear?"

Scene 31—Semi-closeup of Helen looking up from book and saying:

Title—"In a minute, Mom. I've only got a few more pages to read."

Scene 32—Closeup of Mother shaking her head in resignation.

Scene 33—Semi-closeup of Mary carefully folding her napkin.

Scene 34—Medium shot of Mary getting up from chair, picking up some dishes and clearing off table.

Scene 35—Medium shot of Mother getting up and picking up Bobby's napkin from the floor.

Scene 36—Long shot of Mother going out kitchen door as Mary continues to clear up the dishes.

Scene 37—Medium shot of Helen still reading book.

Scene 38—Medium shot of kitchen door opening and Mother entering with pail of water.

Scene 39—Semi-closeup of pail of water being put

Bulk Film Gives You Big Savings in Footage Costs



Shoot More Film for Less Money

Use

8mm BULK FILM 16mm

Fine grain. Semi-ortho. Non-halation Weston 8. For titles or reversals. Lab. packed. Free formulas each order. All film guaranteed fresh stock—not re-perforated positive. Calif. buyers include sales tax.

400 ft. STRAIGHT 8mm for UNIVEX, KEYSTONE, etc. **\$3.50**

800 ft. 8mm in dbl. 8mm widths for all dbl. 8mm cameras **\$5.00**

400 ft. 16mm **\$4.75**

SPOOLS—Univex, 5 for \$1.00. Dbl. 8mm, ea., 40c. 50 ft. 16mm, ea., 40c. 100 ft. 16mm, ea., 50c.

Write for Big Free Bulk Film Catalog

HOLLYWOOD STUDIOS
THE WEST'S GREATEST FILM MAIL ORDER HOUSE
SOUTHGATE, CALIFORNIA

NOTICE TO MOVIE FANS

If you take movies (8mm or 16mm) you simply cannot afford to be without a Free copy of the latest Photo Bargain Book now being distributed throughout the U. S. Lists all the best moving picture equipment from all the leading manufacturers, describes them. The prices save you money in many cases. You'll find the latest in lenses, screens, meters, projectors, cameras, film, titlers, editing outfits, tripods, books on editing, titling, etc. This Bargain Book is invaluable to you as an equipment REFERENCE book. Don't wait a day longer to send for your Free copy. Write us now.

Central Camera Company
Dept. F-9
230 S. Wabash Chicago, Ill.

8 & 16mm DRY FILM CLEANER

Made in Assorted Colors



Pat. Applied For

CLEAN YOUR FILMS

They will last longer and project Brighter Pictures. Use no liquid cleanser. Price, postpaid, \$3.95.

Dept. 61 V
FISHER MFG. CO.
17 Main St. E. Rochester, N. Y.

DO FILTER FACTORS FLOOR YOU?



... then ask about the new HARRISON Duraline FILTER SET —4 Filters, a Holder and Shade to meet 99% of all your requirements. With compact leather case—Easy instructions, low prices. See them at your dealer today! ..Or write for folder.



HARRISON & HARRISON
Optical Engineers
8351 SANTA MONICA BLVD. HOLLYWOOD, CALIF

GLASS-BEADED MOVIE SCREENS

Easily Made!

Make your own sparkling beaded screens—at a fraction of their usual cost! Crystal beads can be applied to cloth, cardboard or almost any smooth surface. Complete directions with each pound. (No fractions of pounds sold.)

Glass Bead: to cover 20 sq. ft. (1 lb.).
Finest Size \$1.25.
D. GARD. C-4, 54 WEST 74TH ST., NEW YORK CITY

Develop Your Movies With a

REISH MOTION PICTURE DEVELOPER

Easier than developing stills. Enjoy the thrill of developing your own movies. Many new and improved features. Write for complete circular.

Reish Motion Picture Co.
1232 Mishwaka Avenue South Bend, Ind.
Pioneers in Home Movie Developing Equipment

down by Mother.

Scene 40—Medium shot of Mary walking over to ice box with butter dish in one hand and cream pitcher in the other.

Scene 41—Semi-closeup of ice box door being opened by Mother's hand.

Scene 42—Closeup of hand taking butter dish from Mary's hand and putting it in ice box, then taking milk pitcher and putting that in box, too, and then closing door.

Scene 43—Closeup of Mother's hands grasping Mary's hands.

Scene 44—Semi-closeup of Mother putting arms around Mary and burying her head in Mary's hair.

Scene 45—Semi-closeup of Mother's face, with look of love and tenderness on it, saying:

Title—"Now I know who loves Mother best."

Scene 46—Closeup of Mary's face with a look of love and happiness, shaking her head affirmatively. Fade.

Little Housekeeper

• Continued from Page 277

out of scene, pushing doll buggy before her. Fade out.

Scene 27: Fade in. Exterior of grocery, sweet shop, or soft drink stand. Girl enters scene with doll buggy. Opens her small purse and buys candy or ice cream bar.

Scene 28: Closeup as she hands coin to storekeeper and takes confection. Starts to eat it.

Scene 29: Back to scene 27. Girl continues walk down street. Fade out.

Title:

"But when Sunday comes at last,

Then my week of toil is past.

Here's the funny picture part,

That I love with all my heart."

Scene 30: Interior of home or front porch. Little girl is dressed in pajamas. Camera set at low angle to make closeup of girl's head and shoulders as she laughs gleefully at comic section of newspaper spread out before her. (This may be filmed by having girl lay flat on stomach on table with camera set-up as close to floor as possible.)



FOR VACATION
Color Movies
f1.5
Cine
Velostigmat* **R**ECORD your vacation this summer with color movies. A Wollensak Cine Velostigmat* assures gorgeous full-detail shots. Ultra-fast for best results under adverse lighting, for those "hard-to-get" black and white woodland shots, evening scenes, dim interiors. Fine optics give films brilliant sharpness on the screen. In 1" and 2" focus f1.5 for 16mm, 1/2" focus f1.9 for 8mm.

*Reg. U. S. Pat. Off.
Write for LITERATURE!
WOLLENSAK OPTICAL CO.
508 HUDSON AVE. ROCHESTER, N. Y.

WOLLENSAK

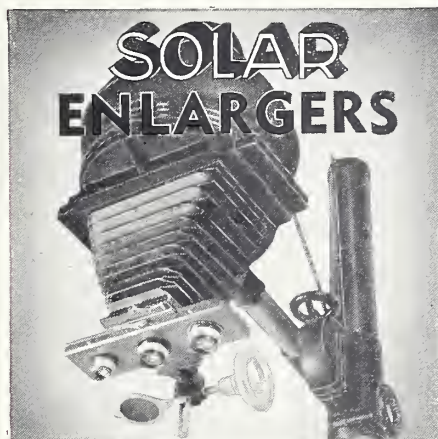

SOLAR ENLARGERS

For "PRIZE WINNING" Prints

For enlargements of Salon quality, you will want a Solar. Exclusive features, scientific design and substantial construction give you more in essential adjustments, efficient light system, ease in focusing, etc. Models for film sizes from 35mm. to 5x7 inches—with or without condensers. Be sure to see a Solar at your dealer's before you buy.
ENLARGING TREATISE HM640 FREE

BURKE & JAMES, Inc.

223 W. MADISON ST. • CHICAGO, ILLINOIS



16 M TITLES
Let FILMACK MAKE YOUR 16 mm TITLES And Announcements

We'll make your titles snappy, artistic, colorful... and put punch and showmanship in every foot.
PROFESSIONAL WORK
The same fine service FILMACK supplies to thousands of theatres.
Send Trial Order or Write for Free Catalog
FILMACK LABORATORIES
851 So. Wabash Ave. Chicago

SILENT or SOUND

Scene 31: Closeup of comic section of paper.

Scene 32: Medium close-up of girl lying on floor reading comics and laughing gleefully. Fade out.

(In this last scene, if there is a pet dog or cat in the family, arrange to have it walk into the scene, and then the girl roll over playfully on her back as she picks up the pet and plays with it. Another closeup of the girl and the pet should be cut in before ending the scene in a fade-out.)

Title: THE END.

Bombing film . . .

• Continued from Page 282

lowlands purposely flooded, the countryside opened to the sea, pouring in through wide gaps in otherwise protective dikes. And a few feet more bring fighting men soaring to earth behind their enemies' lines, landing to the rear from parachutes, this war's original tactics. But the defenders are not caught unaware or afraid, and heavy toll is taken by the homeland troops from these armies that drop from the sky.

The Allies rush to the new front, standing shoulder to shoulder with their smaller neighbors, presenting solid resistance to lightning attack in scenes the like of which have not yet come from the wars that harass the continent. Sea scenes, sea battles, sea tragedies reel one after the other as cutters pick and choose. Dog fights in the air and again planes falling victim to terrific anti-aircraft fire. Bombings and destruction. And land forces, tanks, artillery, infantrymen at pill-box outposts, fighters scouting, advancing, attacking. What a panorama unrolls before us in the cutting room! What a task for the cutters to choose the best from so much that is vital and true! Sorrowful scenes as foot after foot reveals proud and ancient cities, meccas that millions of us have crossed the seas to visit, great cities made the targets of ruthless, fiery destruction, flaring from the skies, hurtling from monster guns miles away.

Then comes a reshuffling

AMERICA

Celebrates the 4th
by Shooting

MOVIES

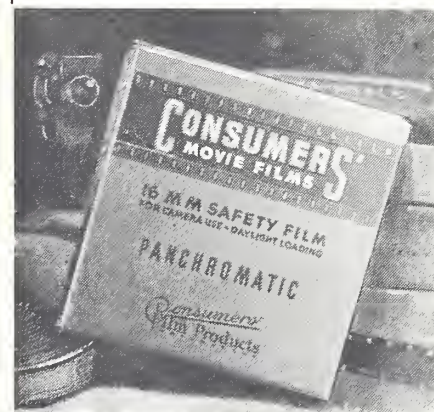

Fully Guaranteed . . .

As to Speed Rating

Excellent Quality

Fast Processing



Complete Modern Machine Processing
1,000,000 Feet Per Week Capacity
Under Expert Craftsman Supervision

CONSUMERS' CAMERA FILMS

Are Popular Priced

	16mm	100 ft.	50 ft.
Consumers' Ortho (18 Scheiners & Weston Daylight 8)		\$3.00	\$2.00
Consumers' Panchro (23 Scheiners, Weston Daylight 24, Tungsten 16)		5.00	3.00
Consumers' Colorcrome (18 Scheiner, Weston Daylight 8)		6.00	3.00

A Colortone Process (Not a Natural Color)

DEALERS EVERYWHERE

ore stocking our film.

Consumers'
Film Products
CORPORATION

Executive Offices

No. 1 PARK AVE., NEW YORK CITY

Orders and Inquiries Filled
Direct from Plant

RIDGEFIELD PARK, N. J.

GET RESULTS

with Top Grade
16mm CAMERA FILM 8mm 3mm

★ **CEL-O-TONE.** Weston 12, Scheiner 18. A remarkably fine outdoor film providing exceptional latitude and perfection of detail.

100 ft., 16mm . 2.50 25 ft., double 8mm . 1.35

★ **EXCEL PANCHRO.** Weston 50 (day), 40 (Tungsten); Scheiner 26 (day), 24 (Tungsten). A super-sensitive, anti-halo film of extremely high speed and fine grain. Beautiful results indoors or out.

100 ft., 16mm 4.75
25 ft., double 8mm 1.75



Excel MOVIE PRODUCTS
4230 DRUMMOND PLACE CHICAGO

Do as Hollywood Does—**Hand-letter your TITLES**

"A to Z" TITLING OUTFIT

Beautiful hand-lettered titles can be made in several colors or black and white with this easy tracing method. No loose letters—every title different—professional results. **AMERICA'S ONLY SCRIPT TITLE MAKER.**

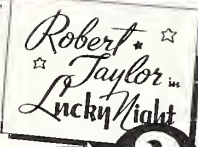

At your local dealer or send \$2.00.
• **FREE "Try It Yourself Kit"**
JACOB STEIN (Mfr.)
175 Fifth Ave., Dept. H 14
New York City

NOTICE TO FILM BUYERS

In the face of present conditions, we guarantee to maintain the following film prices up to and including July 1, 1940, after which time we shall publish any change. If you are planning to take pictures on your vacation, it will well pay you to buy now—these prices cannot be equaled.

FREE PROCESSING - DAYLIGHT LOADING

Superpan	Panchro	Orthotype
Weston 24	Weston 16	Weston 8
100' 16mm \$3.37	\$2.95	\$1.60
50' 16mm 1.92	1.60	1.25
25' Dble 8mm 1.40	1.25	1.00

PROCESSING EXTRA
100' Bulk 16mm \$3.00 \$2.65 \$1.10
100' Bulk Dble. 8mm . . . 3.60 3.30 1.10
Superpan and Panchro have a heavy black anti-halo backing which serves as a dalite leader. Orthotype has dalite leaders with a semi-halation base.

PROCESsing—All films 60¢ per 100 ft.; 50 ft., 45¢; 25 ft., 40¢. Extra spools, 20¢. Extra cans (all sizes), 10¢. Prints and copies, 2¢ per ft.

BRITE TONE MOVIE SUPPLY
188 W. Randolph St. Dept. F Chicago, Ill.

THIS AD IS WORTH \$1.00

WITH NO "STRINGS" ATTACHED!
In order to acquaint you with our unique laboratory services, cine equipment bargains and complete stock of motion picture films, we ask that you "spend" this ad as you see fit for anything listed in our catalogue.

Just Clip and Mail with Your Name and Address to Our Nearest Office. We'll Do the Rest.
(This offer is valid until July 15th, 1940.
Only one ad to a customer, please!)

ESO-S PICTURES
("Quality 8mm Service")
3945 CENTRAL STREET KANSAS CITY, MO. 3975 MENLO AVENUE LOS ANGELES, CALIF.

RAVEN SCREENS
Widest variety of styles, sizes and screen fabrics. Highest quality. At all leading dealers. Literature on Request
RAVEN SCREEN CORP., 314 East 35th St., New York

It's Coming! The TRI-METAL
The answer to a camera fan's prayer—the new, all-metal Thalhammer tripod. The TRI-METAL has class, beauty, strength, versatility, compactness. Watch for announcement of this new member of a distinguished family.
THE THALHAMMER CO.
1015 W. SECOND ST., LOS ANGELES, CALIF.

of sequences for pace, accuracy and good movie technique. Again this is the cutters' job. But in the meantime the creative staff has been drawn from the sidelines to start its work. One group studies the final footages and then identifies and describes the action with just enough titles to be enlightening and not so many that the picture is slowed and valuable footage stolen from action for words. Another group of writers go into a huddle for creation of off-screen commentary for sound editions of the film. And while their typewriters click, a conference is held with the sound studio men for arrangements for recording. And the announcer must be selected from a group of many topnotchers, chosen particularly for his ability to give to the reading of his lines the proper verve without bombast, the proper solemnity without funerealness.

That's all there was to making "Bombs Over Europe."

Sound Effects . . .

• Continued from Page 278

inflated a little more than usual, it can be made to produce a wide range of weird sound effects. Shaken quickly and then held against the microphone as the shot rumbles within the bladder, the effect of a tremendous explosion will be produced. Further manipulation will produce the effect of thunder or the fire of cannon, or the "choo-choo" effect of a railroad train or steamboat engine. A toy balloon may be used for the same purpose. Another good "choo-choo" sound effect may be produced with a pair of wooden blocks covered with sandpaper and rubbed together.

Glass crashes are expensive, if the wife's best crystal is used. A box of broken bottles will do as well when emptied into another box on cue. A pair of iron bars across the second box will add further naturalness to the effect.

Many more simple sound effects will suggest themselves once the cinebug starts this fascinating sideline to the home movies hobby. One can always add buzzer boxes and phone bells.

Last Christmas there was a small sound-effect kit on the market for a few dollars, but all the gadgets described here may be found in the average kitchen or garage. Ambitious amateurs who wish to expand their activities into making a library of recorded sound effects will be able to add the sound of automobiles, crowds, airplanes, animals, in fact anything one can name to their sound effect repertoire.

However, just to begin with, the effects described will surprise and intrigue any home movie audience. Indeed, for any home movie they'll win the vote—"Okay for sound!"

New to Me . . .

• Continued from Page 293

By using this service, amateurs will be able to determine the effect of certain types of filters, trick shots, etc., on a part of their roll before wasting additional film to learn whether these shots are effective.

Photrix Cine Motor

Photrix Cine is a photoelectric exposure meter designed in particular for amateur movie photographers and cine studios. It is not simply a converted still picture exposure meter but represents a completely new development and is built, in every detail, to meet the requirements of modern moving picture photography.

The Photrix Cine is built into a strong, one-piece bakelite casing. It is compact, amazingly flat and shaped to fit the grip of the hand. The gold-plated movement is visible under a double glass window through a cut-out of the dial, permitting inspection and offering an extremely interesting insight into the working parts of the instrument.

Reader Speaks . . .

• Continued from Page 270

but require very careful and accurate work. Further information, requirements, etc., may be exchanged by writing Verlin L. Cochran, care Star-Bulletin, Honolulu, T. H.

16mm
AMBERTINT
Quality Outdoor Film at Extremely Low Cost
Fine grain, semi-ortho, large latitude—half stop either way—the OUTDOOR sensation film of the 20th Century. AMBER tint of film "different" and pleasing. Amazing low price includes machine processing. **\$2.00**
SHOOT MORE OUTDOOR ACTION FILM AT LESS COST. 100-ft. roll.....
Order Direct
AMBERTINT not sold at dealers. Order several rolls direct—save money. Not made in 8mm nor sold in bulk.
California Buyers Include Sales Tax
Write for Big Free Bulk Film Catalog
HOLLYWOODLAND STUDIOS
THE WEST'S GREATEST FILM MAIL ORDER HOUSE
SOUTHGATE, CALIFORNIA

SH! SH! There's heavy cerebral activity in this department for ye proprietor is preparing ye new
CINE BARGAINGRAM No. 245
A scintillating collection of super-colossal values in sundry and several cameras, projectors, screens, tripods, and other tools of this fascinating trade. Write us to reserve your free copy for you . . . out soon.
BASS CAMERA CO. Dept. H. M.
179 W. MADISON ST. CHICAGO, ILL.

TITLES .. BACKGROUNDS FREE
UP TO 10 WORDS EACH ADDITIONAL WORD 2c
FILM IN BULK
LABORATORY PACKED 400 ft. 200 ft. 100 ft.
16mm ORTHO—West. 8 3.50 2.00 1.25
SUPER Panchromatic, West. 24 10.00 6.00 3.50
8mm Double ORTHO—West. 8 (Scored) 3.50 2.00 1.25
SUPER Panchromatic—West. 24 10.00 6.00 3.50
REVERSAL PROCESSING—100 Feet or Less 75c
Reducing ★ Enlarging
ILLUSTRATED CATALOGUE
GENERAL CINE SERVICE
204H East 18th St., New York

SACRIFICE!
Six 400-Ft. 16mm KODACHROME DUPLICATES
2—"California Wildflowers"
2—"Yellowstone's Geysers and Bears"
2—"Grand Canyon of Yellowstone and Grand Tetons"
Filmed with a Cine Kodak Special, each complete with fades, dissolves, and titles. Producer will sacrifice for less than cost of raw film, as he wishes to remake each subject in sound.
Price—\$25.00 per 400-Ft. Reel
WINTER, INC., 529 West 6th St. Los Angeles, Calif.

GUARANTEED—To read lower lowlight and higher highlight intensities more accurately than any other Meter...regardless of price.
PHAOSTRON
ELECTRIC EXPOSURE METER For Still or Movies
Ask your dealer...or write:
PHAOSTRON CO. ALHAMBRA, CALIF.

BETTER MOVIES WITH BLACK & WHITE FILM 16mm—100 Ft. Reversible Film \$1.98 Including Processing
Rating: Weston 12, Scheiner 18
At your dealer or direct. Past service processing same day included at no additional cost.
• **VISUAL INSTRUCTION SUPPLY CO.**
1757 Broadway Box H9 Brooklyn, N. Y.



TITLE Backgrounds

By EDMUND TURNER

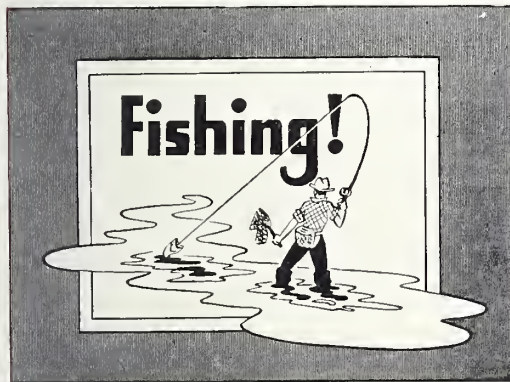

JUNE is the month of graduations, weddings and vacations — so it is timely that we bring you title backgrounds appropriate for home movies on these subjects. Our first title card this month, "Graduation Day," should fit in nicely as the main title for your commencement film, and the "End" title, decorated with the wise young owl, should add an appropriate finishing touch.

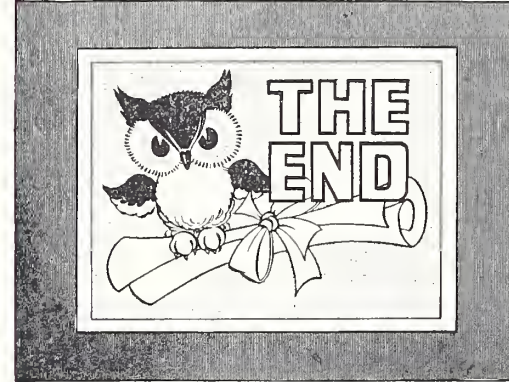

And the one on "Fishing!" we are sure will be welcomed by the host of cinefilers whose camera accompanied them at the opening of the fishing season this spring.

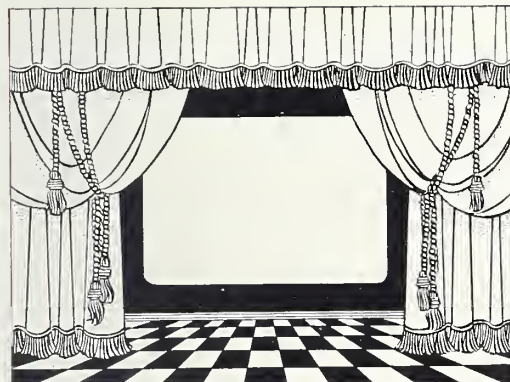

The very simplicity of the "June Bride" title makes it appropriate as a main caption for a documentary of a coming June wedding ceremony, a wedding party, or a scenarized home movie about a wedded couple.

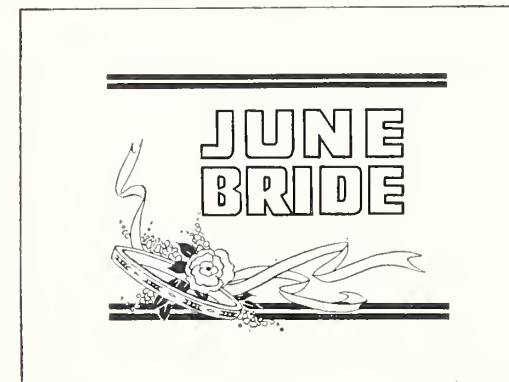

The title, "Our Pets," is published in response to the many requests received for a good general main title for home movies of pets. "First Day at School" will likely not be needed until next September or October, but file it away for use at that time. The blank title card with the curtains draped at either side should be used for introductory and credit titles. It may be used over again by simply cutting out the unlettered area and placing it over another title card on which the desired text has been lettered.

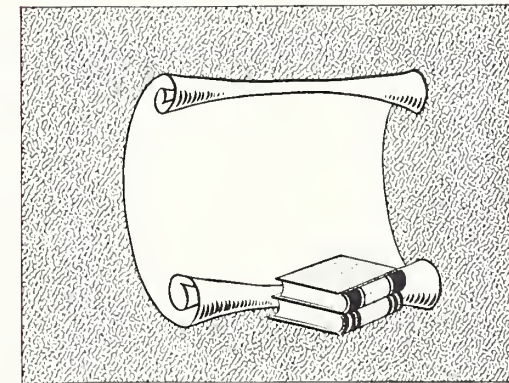
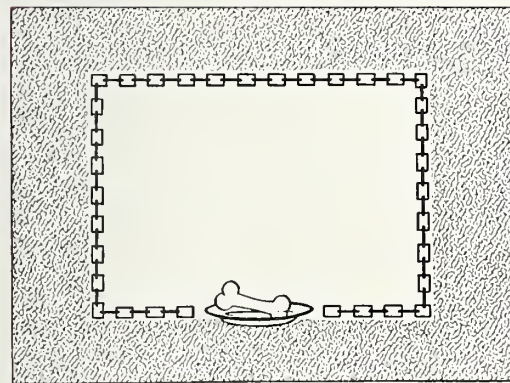

The graduation, June bride and "owl" end titles are adaptable to coloring for Kodachrome. Coloring may be done with water colors, show card colors or ink. Also, try placing a sheet of colored cellophane over the title card for an additional color effect.



If you would like to increase your supply of title backgrounds, we suggest you purchase one of the new HOME MOVIES sets of title cards which are available in packets of 25, printed on individual cards. These new sets are available in black and white for pan, ortho, and positive films, and in color for Kodachrome. When ordering, specify set No. 1 for black and white, and set No. 2 for Kodachrome. A set will be sent prepaid upon receipt of 50c.



Directory Of Amateur Cine Clubs.

ARIZONA

TEMPE: Tempe Cine Club (8mm and 16mm)—Howard Lindly, Sec'y, 103 E. 5th St. Meet 2nd Wednesday.

CALIFORNIA

ALHAMBRA: La Casa Movie Club (8mm and 16mm)—H. P. Carnahan, Pres., 21 S. Garfield. Meet 3rd Monday each month.

AZUSA: Sunkist Movie Makers of the San Gabriel Valley (8mm and 16mm)—Elbert B. Griffith, Sec'y, 708 E. Bonita Ave. Meet 1st Monday each month.

BERKELEY: Berkeley Amateur Motion Picture Club—Micky Ambrose, Sec'y, 1719 E. 15th St., Oakland.

EL SEGUNDO: South Bay Camera Club—Heath L. Martz, Vice-Pres., 314½ Virginia St.

FRESNO: Fresno Movie Makers—R. C. Denny, Sec'y, 750 Vassar Ave.

GLENDALE: Glendale Lens & Shutter Club (8mm and 16mm)—Howard Manning, Sec'y, 547 N. Brand Blvd. Meet 2nd Tuesday each month.

HANFORD: Kings Camera Club—G. Meldrum, Pres., 206 W. Grangeville Blvd.

HAYWARD: Hayward Cinema Club (8mm and 16mm)—Harvey Reed, Jr., Sec'y, 230 Pearce St. Meet 2nd and 4th Thursday.

HERMOSA BEACH: Amateur Movie Club of Hermosa Beach—Robert Balfour, Producer.

HIGHLAND PARK: Highland Park 8mm Club (8mm)—Howard Timmons, Sec'y, 4530 W. Avenue 41. Meet 2nd week of month.

LONG BEACH: Long Beach Cinema Club—Pat Rafferty, Sec'y, 2215 E. 8th St. Meets 8 p. m. 1st and 3rd Wednesdays at Y. W. C. A.

LOS ANGELES: Los Angeles 8mm Club—Leo Caloia, Sec'y, 143 West Avenue 28. Meet 2nd Tuesday each month.

Los Angeles Cinema Club (8mm and 16mm)—Wm. Hight, Sec'y, 361 N. Formosa Ave. Meet 1st Tuesday each month.

Southwest 8mm Club (8mm)—Mrs. W. B. Blanchard, Sec'y, 2127 Glendon Ave. Meet every 3rd Tuesday.

LYNWOOD: Southern Cinema Club (8mm and 16mm)—Don Hunt, Sec'y, 3522 Firestone Blvd., South Gate, Calif. Meet 4th Tuesday each month.

MONTEREY: Peninsula Cine Club (8mm and 16mm)—H. H. Daugherty, Box 97, Pacific Grove. Meet 3rd Wednesday each month.

NORTH HOLLYWOOD: North Hollywood Cine Club (8mm and 16mm)—Ted Knight, Sec'y, 4873 Lankershim Blvd. Meet 1st Tuesday each month.

NORWALK: The Tri City Movie Club (8mm and 16mm)—Bert P. Teets, Sec'y, 804 Pine. Meet 1st and 3rd Wednesday of the month.

OAKLAND: Bay Empire 8mm Movie Club (8mm)—R. J. Shatlock, Sec'y, 4132 Opal St. Meet 2nd and 4th Wednesday of month.

The Greater Oakland Motion Picture Club (8mm and 16mm)—B. F. Pratt, Sec'y, 2039 Shattuck Ave., Berkeley. Meet 2nd and 4th Monday each month.

PASADENA: Pasadena Movie Club—Gordon Plank, Sec'y, 2075 E. Orange Grove. Meet 3rd Wednesday of each month.

POMONA: Pomona Valley Club—T. J. Hebert, 155 S. Garey St.

RED BLUFF: Tehame County Movie Club (8mm and 16mm)—Hank Schafer, Sec'y, 415 Madison St. Meet every 3rd Thursday of the month.

SACRAMENTO: Sacramento Movie Club (8mm and 16mm)—Wilfred Meacham, Sec'y, c/o Associated Oil Company. Meet 1st Thursday of month.

Sierra Camera Club (8mm and 16mm)—John Pardee, Sec'y, 1207 K St. Meet 2nd Tuesday and last Thursday.

SAN DIEGO: San Diego Cinema Club (8mm and 16mm)—G. E. Taylor, Sec'y, 4522 Utah. Meet 2nd and 4th Wednesday each month.

SAN FRANCISCO: Cinema Club of San Francisco (8mm and 16mm)—Edwin L. Sargeant, 1980 Washington St. Meet 3rd Tuesday each month.

Cinemachanics Club of San Francisco, 130 Taraval St.

Sherman Clay Movie Club (8mm and 16mm)—Mrs. C. E. Grifton, Sec'y, 1335 Washington. Meet 3rd Wednesday of each month.

Silver Screen Players of San Francisco (16mm)—Bette Byers, Sec'y, c/o Eric Mawson, 237 Woolsey St.

SAN JOSE: San Jose Cine Club (16mm)—Frank T. Bondi, Sec'y, 1286 Vine St. Meet 1st Monday each month.

SANTA ANA: Orange County 8mm Club (8mm)—Jack Kahler, Sec'y, 1512 Dresser St.

• Amateur movie makers interested in joining a cine club may make inquiry of the secretary of the club nearest their vicinity whose headquarters are given on this page.

If you are interested in forming a new cine club, HOME MOVIES will be glad to assist you. You are invited to write to the editors for free data that will be of assistance to you in organizing a club.

Listing of additional clubs will be made to this directory from time to

time as the data is received from club secretaries. Every amateur cine club in the United States, Canada, and Mexico is invited to participate. Clubs not as yet listed are requested to furnish the necessary information for listing.

Stars indicate clubs from whom club-produced films are available to other clubs on exchange basis on payment of transportation charges.

This directory is another of HOME MOVIES' exclusive services for the amateur movie maker.

8-16 Movie Makers—Thelma Heath, 1028 Hickory St. Meet 1st and 3rd Thursdays.

STOCKTON: Port Stockton Cine Club (8mm and 16mm)—K. R. Oliver, Sec'y, 345 N. San Joaquin. Meets 2nd and last Thursday of each month.
Stockton Cine Club—Harold Liddicoat, Sec'y, 11 S. Hunter St.

COLORADO

DENVER: Bell Movie and Camera Club of Denver—H. M. Price, Box 960.
Denver Cine 8mm Club—Preston Hopkins, Sec'y, 621 E. Colfax St. Meet 2nd Monday each month.

CONNECTICUT

BRIDGEPORT: Monogram Movie Club.
BRISTOL: Bristol Cinema Club—Earle H. Sparks, Pres., 20 Good St. Meet 2nd Thursday each month.

HARTFORD: Hartford Amateur 8mm Camera Club (8mm)—George McGauley, Sec'y, 1214 Main St.
Nutmeg Film & Reel Club—J. Philip Earley, Sec'y, 138 Main St.

MANCHESTER: Manchester Cinema Club—Mrs. Thos. Hooley, Sec'y.

NEW BEDFORD: Greater New Bedford Movie Club—Percy Lord, Sec'y.

NEW HAVEN: The 8mm Movie Club of New Haven (8mm)—Syd Sidebottom, Sec'y, 29 May St., West Haven. Meet 3rd Tuesday each month.

STAMFORD: Stamford Cinema Club—R. Taylor, Sec'y, 65 South St. Meet 1st Monday and 3rd Wednesday.

TARRINGTON: Tarrington Cinema Club.

DISTRICT OF COLUMBIA

WASHINGTON: National Capital Cinema Club (16mm)—Geo. D. Lane, 738 Numsey Bldg. Meet 2nd Thursday.

Washington Society of Cinematographers (8mm-16mm)—John T. Chedester, Sec'y. Meet 1st and 3rd Mondays.

Washington 8mm Club—Dr. I. Rodis, Sec'y, 1726 Eye St. Meet 2nd Wednesday each month.

FLORIDA

GAINESVILLE: Orange State Camera Club—Earl H. Jernigan, Pres., Box 587. Meet every other Tuesday.

JACKSONVILLE: Jacksonville Cinematographers—P. O. Box 56.

MIAMI: Miami Camera Club—Alfred Kahn, Sec'y.

Miami Movie Makers (8mm and 16mm)—Mrs. Paul Hockett, Sec'y, 1460 N. W. 38th St. Meet 1st and 3rd Monday each month.

TERRITORY OF HAWAII

HILO: The Family Movies Club—P. O. Box 106.

HONOLULU: Honolulu Amateur Cinema Club (8mm and 16mm)—Richard G. Bailey, Sec'y, c/o Nuuanu Y.M.C.A., Fort St. Meet 1st and 3rd Tuesday each month.

Honolulu 8mm Club (8mm)—Francis C. Williams, 4740 Farmer Rd.

GEORGIA

ATLANTA: Atlanta Movie Club (8mm and 16mm)—Douglas Cone, Sec'y, P. O. Box 74, Station C. Meet 1st and 3rd Friday each month.

THOMASTON: Thomaston Movie Club—(16mm and 8mm)—J. Lee Abernathy, Sec'y, 308 W. Main St. Meet every other Sunday.

IDAHO

BOISE: Boise Camera Club (8mm and 16mm)—Mabel M. Sturgis, Sec'y, 1505 N. 15th St. Meet 1st and 3rd Tuesday each month.

NAMPA: Nampa Movie Club (8mm and 16mm)—Art French, Sec'y, c/o Northwest Photo Shop. Meet 1st Monday.

ILLINOIS

BERWYN: Suburban Amateur Movie Club (8mm and 16mm)—John Triska, Sec'y, 2415 S. Highland Ave. Meet 1st and 3rd Monday each month.

CANTON: Canton Movie Camera Club (8mm and 16mm)—Lafe Drury, Sec'y, Main and Walnut. Meet 2nd and 4th Mondays.

CHICAGO: Chicago Cine Club (8mm and 16mm)—Lilly Thye, Sec'y, 314 S. Federal St. Meet every Thursday.

Chicago Cinematographers—S. F. Warner, 1538 Marengo Ave., Forest Park. Meet 1st Tuesday each month.

Commonwealth Edison Camera Club—Arnold R. Hatch, 72 W. Adams St., Room 737.

Lane Tech Movie Club—A. P. Heffin, Sec'y, 2501 Addison St.

Metro Movie Club of River Park (8mm and 16mm)—J. W. Claywell, Sec'y, 5100 N. Francisco Ave. Meet every Wednesday night.

Shutter Snapper Club—Faith Church, Pine and Augusta.

South Side Cinema Club (8mm and 16mm)—Caroline Hetzner, Sec'y, 7321 Lawrence Ave. Meet 2nd and 4th Wednesday each month.

The Camera Adventurers' Club (8mm)—Mrs. Frank H. Crowe, Sec'y, 5916 N. Paulina.

Triangle Cinema League of Chicago (8mm and 16mm)—Leo Brooks, Sec'y, 1528 S. Harding Ave. Meet Sunday afternoons, once or twice a month.

Westlawn Cinema Club—Walter Sengstock, Sec'y, 1517 S. Kostner Ave.

EVANSTON: Northwestern Amateur Club.
HOMEWOOD: 3H Camera Club, Movie Division—George Durand, Sec'y, 1750 Linden Rd.

OTTAWA: Ottawa Cine Club—C. F. Grover, Sec'y.

PEKIN: Pekin Cinema Club (8mm and 16mm)—Howard E. Miller, Sec'y, Box 262. Meet every other Monday night.

PEORIA: Peoria Cinema Club, Inc. (8mm and 16mm)—Miss Lena R. Hoerr, Sec'y, 1102 Frye Ave. Meet every 3rd Tuesday.

ROCKFORD: Rockford Amateur Movie Club.

ROCK ISLAND: Tri-City Cinema Club (8mm and 16mm)—Albert N. Mueller, M.D., 550 26th St. Meet 4th Friday each month.

INDIANA

FORT WAYNE: Fort Wayne Amateur Cinema Club (8mm and 16mm)—B. J. Olander, Sec'y, 2560 E. Brook Dr. Meet 2nd Monday each month.

HAMMOND: Calumet Movie Makers (8mm and 16mm)—Gladys Patrick, Sec'y, 5411 Price Pl. Meet every 3rd Monday.

INDIANAPOLIS: Indianapolis Amateur Movie Club (8mm and 16mm)—Alfred F. Kaufman, Sec'y, 4623 N. Arsenal Ave. Meet 1st and 3rd Wednesday each month.

Super-Art Productions of Indianapolis—W. Stuart Bussey, 17 E. St. Joseph St. Public Service Company Camera Club—James Genders, Sec'y, 4935 W. 11th St.

VINCENNES: Vincennes Camera Club (8mm and 16mm)—Robert M. Johnson. Meet 1st Thursday.

IOWA

DES MOINES: Y. M. C. A. Movie and Camera Club of Des Moines (8mm and 16mm)—Mary H. Platt, Sec'y, 3223 2nd St.

SIoux CITY: Amateur Cinema Club of Sioux City (8mm and 16mm)—Don Goodwin, Sec'y, 3733 7th Ave. Meet 3rd Tuesday each month at Hunt School.

KANSAS

PRATT: Camera Club—16mm and 8mm)—Benjamin F. Henry, First Presbyterian Church.

WICHITA: Wichita Amateur Movie Club—Mrs. Martin Lentz, Sec'y, Martin W. Lentz Co., 111 W. William St.

MASSACHUSETTS

ATTLEBORO: Attleboro Movie Club—Francis J. O'Neil, 37 Pleasant St.

BOSTON: Boston Cinematographer Club (8mm and 16mm)—Fannie Tinkham, Sec'y, Cambridge Photographic Society, 631 Massachusetts Ave. Meet 2nd and 4th Mondays.

LOWELL: Lowell Amateur Cinema Club—Leslie R. Lawson, Sec'y, 311 Westford St.

LYNN: Greater Lynn Camera Club, Movie Division—Max Hurwitz, Sec'y, 46 Central Square.

PITTSFIELD: Berkshire Museum Camera Club (8mm and 16mm)—A. C. Hindle, Sec'y, 19 North St. Meet 2nd Wednesday each month.

SOUTHBRIDGE: ★Southbridge Amateur Movie Makers Club (8mm and 16mm)—Joseph A. Giroux, Sec'y, 85 Everett St. Meet 2nd Friday each month.

MICHIGAN

BATTLE CREEK: Photographic Society of Battle Creek (8mm and 16mm)—Neil E. Elliott, Sec'y, 215 Fairfield Ave.

DETROIT: Detroit Society of Cinematographers (8mm and 16mm)—James A. Harris, Sec'y, c/o McGregor Library. Meet 4th Monday.

FLINT: Flint Amateur Movie Club—Lynn J. DePree, 2006 Mountain Ave. Meet 1st Wednesday each month.

JACKSON: Jackson Amateur 8mm Camera Club (8mm)—Lila O. Redinger, Sec'y, 1040 S. Jackson St. Meet 3rd Friday each month.

KALAMAZOO: Kalamazoo 8mm. Cinematographers—(8mm)—Grant Kinch, Pres., 806 S. Park. Meet 1st and 3rd Thursdays.

LANSING: Capitol Camera Club (8mm and 16mm)—R. B. Gould, Sec'y, 1414 Corbett St. Meet 2nd Monday each month.

LAPEER: Lapeer Cinema Club (8mm and 16mm)—Peter Skeberdis, Sec'y, 1665 Imlay City Rd. Meet 3rd Tuesday of each month.

PONTIAC: ★Pontiac Amateur Cinematographers (8mm and 16mm)—Welton J. Jones, 583 E. Tennyson. Meet 1st Monday each month.

SAGINAW: The Saginaw Movie Club (8mm and 16mm)—Clarence R. Kreuger, Sec'y, P. O. Box 671. Meet every other Thursday.

MINNESOTA

AUSTIN: Austin Camera Club (8mm and 16mm)—Lon Enochson, Sec'y, 205 N. 2nd St. Meet 2nd Tuesday each month.

HOPKINS: Suburban Cine Club (8mm and 16mm)—J. M. Devoy, Sec'y, 309 Blake Rd. Meet last Thursday.

MINNEAPOLIS: Minneapolis Octo-Cine Guild (8mm)—C. G. Crosby, Sec'y, 5617 12th Avenue S. Meet last Thursday each month.

Minneapolis Cine Club (8mm and 16mm)—Dr. Reinhold Ericson, Sec'y, c/o R. A. Riebeth, P. O. Box 22, Commerce Station, Minneapolis.

ST. PAUL: Gonfer Movie Club (8mm and 16mm)—Mrs. L. T. Thiets, Sec'y, 580 Wentworth. Meet last Friday each month.

St. Paul Amateur Movie Makers (8mm and 16mm)—Walter Gayman, Sec'y, 314 W. Kellogg Blvd. Meet 1st and 3rd Tuesday each month.

Metropolitan Cine Club (8mm and 16mm)—T. C. Hotchkiss, Sec'y, 303 S. Cleveland Ave. Meet 1st and 3rd Wednesdays.

MISSOURI

KANSAS CITY: The Heart of America Movie Club (8mm and 16mm)—Cooper Jenkins, Sec'y, 616 W. 26th St. Meet 1st Monday of each month.

Kansas City Cinema Club (8mm and 16mm)—E. P. Witte, Sec'y, 3125 Broadway. Meet 2nd and 4th Wednesday each month.

ST. JOSEPH: St. Joseph Amateur Movie Camera Club (8mm and 16mm)—Ruthanna Beard, Sec'y, 610 E. Missouri Ave. Meet 2nd and 4th Wednesdays.

ST. LOUIS: Amateur Motion Picture Club of St. Louis (8mm and 16mm)—Miss Eloise Koch, Sec'y, 2738 Accomac St. Meet 2nd Wednesday each month.

★St. Louis Amateur Movie Club—J. B. Barger, Pres., Suite 815, University Club Bldg.

MONTANA

BILLINGS: Billings Movie Club—Louis M. Moos, Sec'y, 311 Wyoming.

NEW JERSEY

BAYONNE: Bayonne Cine Club (8mm and 16mm)—Thomas A. Dolan, Sec'y, 232 Danforth Ave., Jersey City. Meet 1st Friday.

EAST ORANGE: Cinema Club of the Oranges (8mm and 16mm)—Herbert A. Smith, Sec'y, 541 Main St. Meet 3rd Friday.

MILLBURN: Gibraltar 8mm Club (8mm)—M. H. Sanders, 85 Greenwood Dr.

NEW CLUB FORMING

• 8mm and 16mm cinefilmmers residing in the southwestern Los Angeles area and who are interested in becoming members of a new Amateur Cine Club are requested to communicate with Hugh M. Foster, 4318 Crenshaw Boulevard, of that city.

Buy GENERAL in BULK
DOUBLE 8 SCORED
SEPARATES WITHOUT SLITTING
Single 8, Double 8 & 16

A High Class Reversible Semi-Ortho Outdoor Film. Used in Cine Kodaks, Keystone, Victor, Filmo and Univex. Also suitable for titles. Processing simplified by use of our Prepared Powders. FREE Instructions.

200 ft. 8mm. Double 8 \$1.50 post paid
width 1mm 35c each
Filmo—Eastman 40c

100 ft. 16mm on Economy Spool for Cameras \$1.25 ptd.
400 ft. roll 16mm, laboratory packing, \$4.25 postpaid

100 ft. Single 8. \$1.00 post paid
Univex, etc. 3 for 50c postpaid
Keystone single 30c

100 ft. single 8 Pancho. \$1.90; Super Ortho \$1.90 pp.
100 ft. double 8 Pancho. \$3.45; Super Pan. \$3.45 pp.
100 ft. 16mm Super Pan (West. 24) day, \$3.15 pp.

Simplified Processing Outfits including Prepared Powders: For 30 ft. Single 8, \$3.55, postpaid; Double 8 and 16, \$4.95, express. Simple instructions included. Stamp for Film sample, circulars and processing prices.

FROMADER GENERAL COMPANY, Davenport, Iowa

16mm DuPont
REGULAR PAN MOTION PICTURE FILM
Including Reversal Processing
\$4.50
PER 100-FT. ROLL

Make Better Home Movies at Less Cost

Standard speed, FULL PANCHROMATIC sensitivity, wide latitude, fine grain. Has all qualities of costlier black and white films except extreme speed. Excellent for normal outdoor shooting or indoors with photofoods. Can be used with filters. C.B.H. buyers include sales tax.

Write for Free Bulk Film Catalogue
Hollywoodland Studios
SOUTH GATE CALIFORNIA

MOVIE FILM
Reg. West 8 Super Pan
Weston 12 Weston 24
\$1.79 \$2.19 \$3.69

16mm, 100 ft			
16mm, 50 ft.	1.19	1.39	2.19
Dbl. 8mm, 25 ft.	.98	1.19	1.39

Not to be confused with bulk film. Each roll complete on daylight loading spool in metal container in mailing carton. Prices INCLUDE high grade processing service 24 hours in our laboratory. Supplied in 3 popular types. REGULAR semi-ortho; SUPER full-ortho, non-halation, wide latitude. PAN is extremely fast, panchromatic, very fine grained.

ORDER TODAY DIRECT FROM THIS AD
Orders for 2 rolls or more, accompanied by \$1, may be sent C. O. D. for balance.

ESSCO FILM PRODUCTS
Dept. HM
6117 CAMPBELL AVE. CHICAGO, ILL.

BAIA
When You Buy BAIA You Buy the Best
Precision Made; Guaranteed Perfect
\$2.50
From Your Dealer or Direct
BAIA MOTION PICTURE ENG.
8044 Hardyke, Detroit, Mich.

FILMS FOR RENT
18MM SOUND - 16MM SILENT - 8MM SILENT
Send for Free Gigantic Catalogue
Listing over 5500 subjects.
IDEAL PICTURES CORPORATION
28 East Eighth Street, Chicago
and
2402 West 7th Street, Los Angeles, Calif.

BRITELITE - TRUVISION
America's foremost line of motion picture screens, spotlights, reflectors, paper sales, etc.
Write for complete details.
MOTION PICTURE SCREEN and ACCESSORIES CO., INC.
351 West 52nd St., New York City

LEATHER CASES—Finest Cowhide
Everready Cases for Filmo 8—Keystone 8mm or Cine-Kodak 8. Postpaid. \$4.00
Everready Weston Meter Cases. \$1.25
NEW! LENS ADAPTER—Permits use of standard screw-mount super speed or telephoto lens in your Filmo 8. \$2.25, postpaid.
CAMERACRAFT DIVISION
Mail Order Only
1305 South Union Ave. Los Angeles, Calif.
Write for Complete Free Price List

MAPLE SHADE: The Wedgewood-Draper Club (8mm) — William Hoover, Sec'y, Meet 2nd and 4th Wednesdays.

MAPLEWOOD: Maplewood Amateur Movie Club (8mm and 16mm)—Mrs. Fred W. Miller, Sec'y, 13 Rynda Rd.

NUTLEY: ★Cineman Club of North Essex (8mm and 16mm)—J. E. Nestell, Sec'y, 18 Shepard Pl. Meet 3rd Thursday each month.

PASSAIC: Passaic Y. M. C. A. Cinema Club.

TRENTON: Trenton Movie Makers (8mm and 16mm)—Jules V. Shein, Sec'y, 521 S. Warren St. Meet either 1st or 2nd Friday each month.

NEW YORK
BINGHAMTON: Cinema Club of the Triple Cities — Edwin Moody, Sec'y.

BRONX: Bronx Amateur Cinema Club (8mm and 16mm)—Nicholas H. Zella, Sec'y, 384 E. 193rd St.

BROOKLYN: Brooklyn Amateur Cine Club — Irving Pollock, Pres., 91-01 64th Rd., Rego Park, L. I. Meet every two weeks.

BUFFALO: Amateur Cinema Club of Buffalo—Edward C. Denny, Sec'y, 385 La Salle Ave.

Niagara Cinema League (8mm and 16mm) — K. N. Hadley, Sec'y, 103 Villa Ave. Meet 3rd Wednesday each month.

ELMIRA: Y. M. C. A. Movie Club (8mm and 16mm) — H. M. Shinn, Jr., Sec'y, Y. M. C. A. Meet 1st Monday each month.

JOHNSON CITY: I. B. M. Cinematographer's Club — W. M. Muir, Pres., R. D. No. 2.

LONG ISLAND: Queens Cine Club (8mm and 16mm)—Jack Jacoby, 103-17 125th St., Richmond Hills, L. I.

MOUNT KISCO: Mount Kisco Cinemats (16mm) — Robert F. Gowen, Sec'y, Chilmark Park, Assining, N. Y. Meets 1st Monday of each month.

MOUNT VERNON: Mount Vernon Movie Makers (8mm and 16mm) — N. W. Knight, Sec'y, 258 Westchester Ave. Meet 3rd Tuesday.

NEWBURGH: Newburgh Amateur Cinema Club (8mm and 16mm) — Robert S. Kelly, Sec'y, 217 North St. Meet 2nd Thursday each month.

NEW YORK CITY: Metropolitan Motion Picture Club, Inc. (8mm and 16mm)—Robert M. Coles, Sec'y, 35 E. 20th St. Meet 2nd Thursday each month.

New York City 8mm Motion Picture Club — Walter C. Mills, 35 Park View Rd., Bronxville, Meet 3rd Monday.

Telephone Camera Club of Manhattan — Thos. G. Herendeen, Room 1958, 195 Broadway.

PEEKSKILL: Peekskill Sport Center, Inc. — 830 South St.

ROCHESTER: Rochester Amateur Movie Club (8mm and 16mm) — Raymond H. Jacobs, Sec'y, Y. M. C. A., 100 Gibbs St. Meet 1st and 3rd Thursdays each month.

ROCKVILLE CENTER, LONG ISLAND: Rockville Amateur Cinema Club.

SCHENECTADY: Schenectady Photographic Society, Cine Group (8mm and 16mm) — H. M. Webber, Sec'y, 1279 Dean St. Meet 1st Wednesday of each month.

STATEN ISLAND: Staten Island Cinema Club (8mm and 16mm) — Frank E. Gunnell, Sec'y, 34 Colonial Court, West New Brighton. Meet 2nd Tuesday each month.

Staten Island Movie Makers (8mm and 16mm) — Harry S. Wilson, Sec'y, 34 Rokeby Pl.

SYRACUSE: Syracuse Amateur Movie Makers (8mm and 16mm) — Benjamin Franklin, Sec'y, 221 Marguerite Ave. Meet every other Monday.

VALLEY STREAM, LONG ISLAND: Valley Stream Camera Club (8mm and 16mm) — John H. Trunk, Sec'y, 152 Locust Blvd. Meet 1st and 3rd Wednesday each month.

NORTH CAROLINA
MORGANTON: Morganton Camera Club, Movie Division — Edw. M. Hairfield, Jr., Sec'y, Box 793.

OHIO
WKRON: Buckeye Camera Guild (8mm and 16mm) — E. R. Evans, Sec'y, 615 Metropolitan Bldg. Meet every other Monday night.

CLEVELAND: Aremac Club (8mm and 16mm)—L. C. Neuffer, Pres., Box 1719. Meet every 3rd Tuesday.

Cleveland Amateur Cinematographers (8mm and 16mm) — Miss Dorothy Boetticher, Sec'y, 1394 W. 3rd St. c/o Strong, Carliss & Hammond Co. Meet 1st and 3rd Wednesdays each month in Hotel Carter.

COLUMBUS: Columbus Movie Makers — Arthur Robinson, Sec'y, 34 N. 3rd St.

DAYTON: Cinema Research Club — F. H. Bickford, Jr., Chairman, 1529 S. Broadway.

Dayton Cinema League — P. C. Beach, Sec'y, 2240 E. 5th St.

FINDLAY: Findlay Camera Club — Ralph L. Stears, Sec'y, 208 Lark St.

GALION: Galion Camera Club (8mm and 16mm) — Mary Postance, Sec'y, 377 N. Market St. Meet 1st and 3rd Tuesdays each month.

HAMILTON: The Movie Makers Club — Clinton W. Bergen, Pres., 1269 Harmon Ave.

MANSFIELD: Mansfield Movie Club — Dr. L. B. McCullough, 78 Park Ave. W.

MOUNDSVILLE: Trojan Production Co. — Jacquelyn Rusen, Sec'y.

MOUNT VERNON: Mount Vernon Camera Club (8mm and 16mm) — Frank J. Van Vorhis, Sec'y, 306 N. Main St. Meet 1st and 3rd Tuesdays each month.

NORTH CANTON: North Canton Cinema Club (8mm and 16mm) — R. L. Wearstler, Sec'y, R. D. 6, E. Maple St. Ext. Meet 1st Friday each month.

SPRINGFIELD: Springfield Cinema Club — C. O. Harrison, Sec'y.

TOLEDO: Toledo Cine Club — Mr. Harry Howland, Sec'y, P. O. Box 23. Meets 2nd and 4th Mondays.

NEWARK: YMCA Movie Makers (8mm and 16mm) — C. I. Grimm, Pres., Arcade Annex. Meet 1st and 3rd Wednesdays.

WOOSTER: Wooster Amateur Movie Makers (8mm and 16mm) — Howard W. Keister, Sec'y, 218 W. University St. Meet 3rd Monday each month.

YOUNGSTOWN: Youngstown Amateur Movie Club (8mm and 16mm) — Fred Deiter, Sec'y, 52 Wesley Ave. Meet 1st and 3rd Mondays.

OKLAHOMA
NAWATA: Nawata Cine Club — Audrey Albin, Sec'y, 514 N. Pine.

OKLAHOMA CITY: Cinematographer Club (8mm and 16mm) — H. P. Douglass, Sec'y, 1909 N. W. 27th. Meet 3rd Friday each month.

Oklahoma City Movie Club — Alex McDonald, Pres., 721 N. W. 29th St.

TULSA: Tulsa Am-Mo Club — J. B. Close, Pres., Box 854. Meet 1st and 3rd Wednesdays.

OREGON
MEDFORD: Medford Movie Club (16mm) — Mrs. George F. Tucker, Sec'y, 37 Kenwood Ave. Meet 3rd Saturday.

Southern Oregon Cinema Club — W. Bernard Roberts, Pres., 922 Reddy Ave.

PORTLAND: Portland Cine Club, Inc. — Arthur E. Gibbs, Sec'y, 324 S. W. Stark St. Meet every two weeks.

PENNSYLVANIA
ALLENTOWN: Allentown Y. M. C. A. Cinema Club — Aral M. Hollenbach, Sec'y, 1229 N. 19th St.

LEBANON: Lebanon Valley Camera Club, Movie Division — W. C. Graeff, Sec'y, 20 S. 8th St.

NORRISTOWN: Mrs. Mary Leonard, Sec'y (8mm and 16mm). 618 De Kalb St. Meet every 3rd Monday.

PHILADELPHIA: ★The 8-16 Movie Club — Louis Sobel, Sec'y, 4916 Ormes St. Philadelphia Cinema Club (8mm and 16mm) — George A. Pittman, Sec'y, 1808 E. Tulpehocken St. Meet 2nd Tuesday each month.

8-8 Club (8mm)—Mrs. Robert H. Connor, Sec'y, 6707 Linmore Ave. Meet 1st and 3rd Thursday each month.

PITTSBURGH: Pittsburgh Amateur Cinema Club (8mm and 16mm) — Miss Rose Goldman, Sec'y, 319 Amber St. Meet 1st and 3rd Wednesday each month.

Amateur Cinematographers of East McKeesport—J. J. Carbaugh, P. O. Box 1466.

POTTSTOWN: Pottstown 8mm Movie Club (8mm) — Wm. J. Weiss, Sec'y, 874 N. Charlotte St. Meet 1st Tuesday each month.

READING: Berks Camera Club (8mm and 16mm) — Stephen Lawrence, 310 N. 12th St. Meet every Monday night.

SUNBURY: Sunbury Amateur Cinema Club (8mm and 16mm) — David Lenker, Sec'y, 346 Chestnut St. Meet 1st and 3rd Mondays.

SOUTH DAKOTA
SIOUX FALLS: Sioux Falls Amateur Cine Club—(16mm and 8mm)—H. E. Hanson Harold's, 308 S. Phillips Ave. Meet 1st Monday each month.

YANKTON: Yankton Camera Club. Arthur J. Smith, Pres., 414 Capitol St.

TENNESSEE
JACKSONVILLE: Jacksonville Movie Makers, P. O. Box 56.

MEMPHIS: W. G. Snowden, Sec'y Box 2073, DeSoto Sta.

TEXAS
DALLAS: Dallas Cine Club — Stan Everman, Pres., 1504 Young St.

FORT WORTH: Movie Makers Club (8mm and 16mm)—J. C. Duvall, Pres., 604 Burk-Burnett Bldg.

UTAH
LOGAN: Logan Amateur Cinema Club (8mm and 16mm) — Mrs. E. L. Hansen, Sec'y, Logan, Utah.

SALT LAKE CITY: Utah Amateur Movie Club (8mm and 16mm) — C. F. Solomon, Jr., Sec'y, 1471 Browning Ave. Meet 2nd Monday of each month.

Continued on Next Page

8M RAINBOW 16M

The following prices include processing and are for daylight loading films:

	25'	100'
	Double 8mm	16mm
No. 1	1.00	1.85
No. 1 Anti-Halo	1.25	2.15
No. 2 S S Pan Halo	2.00	4.40
No. 3 Pan Halo	1.50	3.50

The following prices are for laboratory packed films without processing:

	100'	100'
	Double 8mm	16mm
No. 1	1.25	1.20
No. 1 Anti-Halo	1.50	1.50
No. 2 S S Pan Halo	3.50	3.50
No. 3 Pan Halo	3.00	3.00

RATINGS:

	Weston	Scheiner
No. 1 Both Types	12-4	20-15
No. 2 S S Pan	50-32	26-23
No. 3 Pan	16-12	21-20

We Pay Postage on All Orders Except C.O.D.
RAINBOW LABORATORIES
STATEN ISLAND, N. Y.

YOUR MOVIES OF THE FAIRS
SHOULD HAVE THE BEST AVAILABLE
Movie Titles and Editing

We will give them the artistic titling they deserve—in tints, black and white or genuine Kodachrome. We'll edit them, too, if you wish, at reasonable hourly rates. Our skillful handling of your pictures gives assurance of results that will give you exceptional pride in their exhibition.

We will be glad to see you and serve you when you come to the Fair.

HORNE MOTION PICTURE SERVICE
9 E. 40th St. (Bet. Mad. and 5th Ave.)
New York City

BETTER MOVIES WITH BLACK & WHITE FILM
Reversible Film
25 Ft. Double 8mm
Including Processing
Rating: Weston 12, Scheiner 18
At your dealer or direct. Fast service—processing same day included at no additional cost.

98¢

BLACK & WHITE
VISICHROME-16
75 FOOT Double 8
8c per 100 ft. 8mm
35c per 100 ft. 16mm

• VISUAL INSTRUCTION SUPPLY CO.
1757 Broadway Box H9 Brooklyn, N. Y.

FINE MACHINE WORK
Turrets, Backwinds, Tilters, Lens Adaptations, 8mm Frame Enlargers, Focusers, Recorders, Sound Apparatus. Expert remodeling of cameras, lenses and projectors. Special Apparatus.

MacVAN MANUFACTURING CO.
3829 El Cajon Blvd. San Diego, Calif.
Courtesy to Dealers

Unusual
16mm and 8mm Films

"HER HOLLYWOOD TEST"
"DEATH IN THE AFTERNOON"
and other exciting subjects at
SPECIAL PRICES
Send Dime for Sample Film
Sensational Films
Box 1504 Hollywood, Calif.

Why use anything else when
TITLES BY PARK CINE
cast no more than ordinary titles.
Catalog Free on Request
PARK CINE LABORATORY
120 West 41st Street New York City

Cine Shop TITLES
The BEST THAT MONEY CAN BUY
Your inquiry is invited
Cine Shop
1812 PIEDMONT • CHARLESTON, WEST VA.

CLASSIFIED

ADVERTISING

EQUIPMENT FOR SALE

Filmo 75 with f/3.5 lens and case, \$32.50.
 Filmo 75 with f/1.9 Cinor lens and case, \$50.00.
 Filmo 70A with f/3.5 lens and case, \$29.50.
 Filmo 70A with f/1.9 Cinor lens and case, \$55.00.
 Filmo 70A with f/2.7 lens and case, \$37.50.
 Keystone A3 with f/3.5 lens, \$20.00.
 Keystone A3 with f/1.9 lens, \$46.50.
 Simplex CC f/1.9, \$47.50.
 Ensign Autokinecam f/3.5 lens, \$35.00.
 Victor 3 f/2.9 Trioplan and case, \$45.00.
 Cine Kodak B f/1.9 lens, \$47.50.
 Filmo DA f/2.7 lens and case, \$120.00.
 Filmo 70 E f/2.7 lens and case, \$80.00.
 Keystone A81, 750 watt, \$46.50.
 Keystone A75, 500 watt, \$39.50.
 Keystone A74, 300 watt, \$27.50.
 Keystone D64, 200 watt, \$19.50.
 Kodascope B, 200 watt 50 volt, \$35.00.
 Kodascope EE, 750 watt, \$45.00.
 Ampro A, 200 watt, \$32.50.
 Ampro K, 750 watt, \$67.50.
 Filmo 57 C, 250 watt, \$37.50.
 Filmo S, 500 watt, \$79.50.
 2" f/3.5 Cinor Telephoto, \$22.50.
 2" f/3.5 Wolkensak Telephoto, \$24.50.
 1" f/1.9 Cinor, \$25.00.
 2" f/3.5 Kodak Telephoto Cine Special, \$30.00.
 3" f/4.5 Graff Telephoto, \$20.00.
 1" f/1.8 B. & L. Lens, \$20.00.
 4" f/4 Dallmeyer Telephoto, \$20.00.

WILLOUGHBY'S, 110 West 32nd St., New York

• BASS SAYS: Some rare bargains for June and each with a money-back guarantee.

USED CAMERAS

Univex 8, f/1.9 lens, focusing mount, \$22.50.
 Cine Kodak 8, Model 25, f/2.7 lens, \$29.50.
 Paragon, f/3.5 lens, \$14.50.
 Keystone A-3, f/3.5 lens, \$19.50.
 Simplex 16mm Magazine, f/3.5 lens, \$22.50.
 Cine B, f/3.5 lens, \$24.50.
 Keystone A-7, f/3.7 lens, \$26.50.
 Cine Kodak Model E, f/3.5 lens, \$27.50.
 Filmo Model 75, f/3.5 lens, \$32.50.
 Victor 3, f/3.5 lens, \$42.50.
 Cine Model K, f/1.9 lens, \$42.50.
 Filmo 121 Magazine, Cooke f/2.7 lens, \$47.50.
 Cine Kodak, f/1.9 lens and case, \$59.50.
 Movikon 16, f/1.4 lens, metric marked, range-finder coupled, \$245.00.
 Cine Kodak Special, f/1.9 lens, carrying case, \$507.50.

USED PROJECTORS

Bell & Howell 8mm 122-B, 100-240 v., with case, \$87.50.
 Kodascope Model A, 200 watt, \$20.00.
 Keystone, 300 watt, \$24.50.
 Victor, 500 watt, \$37.50.
 Ampro Model A, 400 watt and case, \$44.50.
 Bell & Howell rebuilt, 400 watt, 16mm, and case, \$46.50.
 New Polaroid Fade-o-Scope, fits most cameras, highly efficient, \$18.75.
 New Book four-way Fader, spring driven, complete, fits most cameras, \$17.50.
 The new Revere Double 8 Camera with f/3.5 lens, \$29.50.
 New Revere Double 8 Turret Camera with f/2.5 lens, \$65.00.
 New Revere Double 8 Model B Projector, 500 watt, \$59.50.

UP-TO-THE-MINUTE TEXTBOOKS

Home Processing, all necessary information, by Harris, postpaid, \$2.00.
 How To Title Home Movies, postpaid, 50c.
 Trick Effects With the Cine Camera, postpaid, \$1.00.
 Exposing Cine Film, \$1.00, postpaid.
 Ideas for Short Films, \$1.00, postpaid.
 Mail your name for the great new 72-page Bass Cine Bargaingram No. 245, in preparation. It's free and no book like it anywhere. Ready soon.

BASS CAMERA COMPANY

Dept. HC 179 W. Madison St., Chicago, Ill.

• BOLEX H-8, Meyer f/1.5, \$195.00; Keystone R-8, 500-W Projector, \$33.00. Both like new, by original owner. BOX 295, Girard, Ohio.

8mm SLITTER

Slits perfectly 16mm width film to exact 8mm width. Die cast body with hardened steel cutting wheels. New price, each, \$2.50.

DEVELOPING RACKS

Stainless steel, take 30 feet 16mm or 8mm width film. Can be used in 11x14 or 8x10 flat trays respectively. Complete with loading stand, each, \$6.75. Specify type wanted.

At Your Dealer's or Direct

J. C. Haile & Sons

Motion Picture Dept.
 215 Walnut Street Cincinnati, Ohio

• Ten cents per word; minimum charge, \$2.00 cash with order. Closing date, tenth of preceding month. • HOME MOVIES does not guarantee goods advertised.
 • Send ads to 6060 Sunset Boulevard, Hollywood, California.

EQUIPMENT FOR SALE

• FULL LIST PRICE allowed for your Eastman Model 20 toward new Bell & Howell Sportster. List price allowed for your Kodascope Model E or EE toward Bell & Howell Filmo-Master. List price allowed for Sportster or Companion toward new Turret 8 camera or Bolex 8mm camera. List price allowed for your Keystone R-8, Kodascope 50, Revere or Model 70 Kodascope toward new Bell & Howell 8mm projector or new Ampro 8mm projector. Used: Bell & Howell Sportsster, with Wind-Bak for fades and dissolves, \$75.00; Bell & Howell Companion with Wind-Bak for fades and dissolves, \$49.50; Bell & Howell Turret 8 with Wind-Bak for fades and dissolves, \$140.00; 500 watt, 16mm Ampro projector, excellent condition, \$39.50; 1½" telephoto lens for Keystone 8mm, \$23.50; 30" x 40" beaded screen with tripod, \$8.95; 36" x 48" beaded screen with tripod, \$11.50; 39" x 52" beaded screen with tripod, \$13.50. Hundreds of other bargains. CONVENIENT TIME PAYMENTS MAY BE ARRANGED ON ANY NEW OR USED ARTICLE. Your used equipment is worth more in trade at NATIONAL CAMERA EXCHANGE, established 1914, 11 S. 5th St., Minneapolis, Minn.

• 1 Victor S.O.F. Model No. 24 Projector, \$160.00. 1 Victor 16mm Silent, with case, Model No. 11, \$55.00. 1 8mm Kodak Model 20 Projector converted for 200 watt lamp, \$12.00. 1 8mm Univex Camera and projector, \$13.00. 1 Kalart Synchronizer, \$8.50. 1 Besbee Universal Title Maker, complete with lights, \$12.00. BRUCK RADIO SERVICE, 201 Walnut St., Hamilton, Ohio.

Directory of Amateur Cine Clubs

• Continued from Preceding Page

VIRGINIA

LYNCHBURG: Hill City 8 Movie Club (8mm) — Nowlin Puckett, Corresponding Sec'y, 822 Floyd St. Meet once a month.

NORFOLK: Norfolk Amateur Movie Club (8mm and 16mm) — Claude D. McMillan, Jr., Sec'y, 720 Carolina Ave. Meets 3rd Tuesday.

WASHINGTON

SEATTLE: Northwest Amateur Cinema League — Carlos E. Grant, 915 Green Bldg., Seattle, Wash.

Roosevelt Movie Club (16mm) — Jayne Stokes, Sec'y, Roosevelt High School, 2032 Franklin Ave. Meet every other Wednesday.

★ Seattle 8mm Club (8mm) — W. B. Bowden, Sec'y, 546 Dexter Horton Bldg. Meet 2nd Tuesday each month.

TACOMA: Tacoma Cinema Club (16mm) — Don Flag, Sec'y, 829 S. Ferry St. Meet 4th Monday each month.

WALLA WALLA: Walla Walla Cinema Club (8mm and 16mm) — Cromie L. Wilson, Sec'y, 715 Catherine St. Meet 4th Monday.

WENATCHEE: Wenatchee Cine Club — Elwood Johnson, Sec'y.

YAKIMA: Yakima Amateur Movie Club (8mm and 16mm) — William Hassell, Pres., 1208 W. Yakima Ave. Meet 4th Wednesday.

Amateur Movie Club: Paul Thompson, Pres., 709 S. 4th St.

WEST VIRGINIA

HUNTINGTON: Huntington YMCA Amateur Movie Club (8mm and 16mm) — James Warfuel, Sec'y, 629 6th St. Meet each 3rd Friday.

TRIAD: Philadelphia: St. Vincent's Cinematic Club — E. Dietrich, Rt. 1, Box 93.

WHEELING: ★ Cinematography Group of the Ohio Valley Camera Club (8mm and 16mm) — R. E. Dempster, 162 15th St. Meet every other Friday.

WISCONSIN

FOND DU LAC: Fond du Lac Camera Club (8mm and 16mm) — Miss Mildred E. Weber, Sec'y, 333 S. Marr St. Meet 4th Monday each month.

MADISON: Cine 8 Club — Ruth Hoffman, Sec'y, 535 W. Dayton St. Meet 1st Tuesday each month.

Maple Bluff Camera Club — John B. Casoday, Sec'y, 1005 Power & Light Bldg.

MILWAUKEE: The Amateur Movie Society of Milwaukee (8mm and 16mm) — Miss Parmelia M. Mills, Sec'y, 530

ACCESSORIES

• MOVIE MAKERS: Process your titles and reversal film. Equipment, chemicals, instructions — 30' capacity double 8 or 16 — \$2.95 express. ROYCRAFT CO., Box 1810, Milwaukee, Wis.

• SAVE! CATALOG! Bargains galore; News Bulletins! New Accessories items! New "Arts" Line! Fast Service! Send Postal! PENNCRAFT, 423, Williamsport, Pennsylvania.

• MOVIE Cameras, Films, Projectors, etc., bought, sold, and exchanged. Big lists Free. Art samples, 25c. PEERLESS, Box 1310-H, Hollywood, Calif.

• RENT A CAMERA, Projector, Lights, Lenses, Tripods, for all 8, 16, 35mm movie productions. RCA Sound Camera, 400 ft. magazine, motor; Cine Special, 200 ft. magazine, motor; Bell & Howell; Victor; Eastman; Eyemos; Debie. Rentals by day, week, or long term. Closing out hundreds of items, still and movie cameras, accessories and supplies. Write for Free Bargain Bulletin. CAMERA MART, Dept. G, 70 West 45th St., New York.

• MODERNIZE your Eastman 20, 25, or 60 with a Windback. Make professional lap dissolves for \$15.00. Send stamps for information. MOVIE CAMERA SUPPLY CO., 1833 Beechwood, Highland Park, St. Paul, Minn.

• WINDBACK for Keystone, \$15.00. Wollensak Telephoto for Keystone or Filmo 8mm 1" f/3.5, \$19.95. 1" f/2.7, \$29.95. Turret, including 1" f/3.5 Telephoto, Keystone, \$34.95. Filmo, \$39.95. CUSTOM-BUILT CAMERA ACCESSORIES CO., 4124 Rawlins, Dallas, Texas.

FILM RELEASES (8 and 16mm)

• WRITE FOR our new 8mm rental catalog. Films shipped everywhere. No extra charge for shipping. We pay both ways, express or parcel post. ABBE FILMS, 1265 Broadway, N. Y. City.

• EXTRA SENSATIONAL — Latest release: "Bombs Over Europe!" in 8mm-16mm. Complete rental library. Prompt delivery. Films rented everywhere. Trades accepted. Bargains in silent and sound projectors. Free illustrated catalog (with sample art film 10c). GARDEN FILM SERVICE, 317 West 50th St., New York City.

• CASTLE FILMS Library. All latest releases for sale, 8mm, 16mm, Silent, Sound. Free catalog. RIEDEL FILMS, 2221 W. 67th St., Cleveland, Ohio.

• SOUND AND SILENT films exchanged, bought, rented, sold, bargains always. New free lists. FRANK LANE, 5 Little Bldg., Boston, Mass.

• UNUSUAL ART FILM catalog. Send 10c for sample and complete catalog. ERWINE'S CINE LABORATORIES, 143 No. Ninth St., Allentown, Pa.

FILMS

• MOTION PICTURE FILM, daylight loading, Weston 8, processing included, 100 ft. 16mm — \$2.00. 50 ft. 16mm — \$1.25. 25 ft. 8/8mm — 75c. Write for price list. RITTER FILM SERVICE, 629 Lyman Ave., Oak Park, Ill.

• "G" Film — 200 ft. 16mm, \$1.95. 100 ft. 8mm double, \$1.50. Single, 75c. Processing ½c foot. MGM PHOTO SERVICE, 1485 Oak, San Francisco.

• EASTMAN KODACHROME, fresh 8mm, 200 ft., \$8.00, including processing. Send stamp for information. COPE STUDIO, 3720 S. Figueroa, Los Angeles, Calif.

WANTED

• WE WILL PAY \$ \$ \$ \$ for new Movie Kinks and Gadgets that we can use for resale purposes. MIROTEX PRODUCTS, 6241 Southwood Ave., St. Louis, Mo.

• PUMP SHOTGUNS, target pistols, binoculars and medical microscopes accepted in trade on everything photographic, such as Leicas, Contax, Eastman and Bell & Howell motion picture equipment, Da-Lite Screens and Webster sound equipment including public address systems, amplifiers, etc. Write for catalog. NATIONAL CAMERA EXCHANGE, established in 1914, 11 S. 5th St., Minneapolis, Minn.

• USED 16mm S.O.F. 1-reel cartoons and comedies. Must preview before purchasing. Send lists and prices. BRUCK RADIO SERVICE, 201 Walnut St., Hamilton, Ohio.

• WANTED — Model 130-E Bell & Howell Filmosound projector. Magazine for Cine Special. 8mm Library subjects. BAYLIS, 224 Third St., Troy, N. Y.

• WANTED — 16mm S.O.F. Camera only. Used R.C.A. or what have you? Lowest price wins! C. I. W. SMITH, 257 Shenango, Sharon, Pa.

• DESIRE BORROW, lend, free: Travel, Circus, Sports, Foreign, Nature films (16mm, 8mm) or projectors. INVALID'S ASSISTANCE BUREAU, Box 34, Elmwood, R. I.

TITLING SERVICE

• PROFESSIONAL TITLES — plain or Kodachrome, 16mm — 8mm. Free Main and End titles. Write ORBIT FILMS, 5437½ Hollywood, Hollywood, Calif.

• SUNBEAM KODACHROME titles, 8 and 16mm. Professional, glowing colors. Sample free! W. C. KANE, 102 Gibbs St., Rochester, N. Y.

PROCESSING SERVICE

• REVERSAL OR NEGATIVE processing, 100 ft. 16mm, 75c; 50 ft. 16mm, 50c; 25 ft. Double 8mm, 35c; 25 ft. 8mm, 25c. RITTER FILM SERVICE, 629 Lyman Ave., Oak Park, Ill.

• FREE PROCESSING of all Univex Films. Complete details for a stamp. ERWINE'S CINE LABORATORIES, 143 No. Ninth St., Allentown, Pa.

ENLARGING SERVICE

• ALL 16MM positive frames enlarged to 2¼" x 3¼" negative and printed. Minimum order, four frames — 60c. Each additional, 15c. Each order of eight receives two 5" x 7" enlargements. Mail 10c ft. roll marked to LUSTIG'S, 800 Eighth Ave., N. Y. C.

BOOKS

• IMPROVE your photo technique with sensational handy reference book — MOVIE KINKS (2 volumes). Hundreds of new camera ideas. 25c per volume. HUDDLE PUBLISHING CO., 1329 Fourth St., S. E., Minneapolis, Minn.

PUERTO RICO

SAN JUAN: San Juan Camera Club — B. Cruz, Jr., P. O. Box 3183.



Good Movies Need Good Film

—CINÉ-KODAK FILM

UNIFORMITY, reliability, brilliant quality—these are the characteristics that have made Ciné-Kodak Film, 8 mm. and 16 mm., the standard film for movie makers. Film cost, of course, includes scientific processing of the film and its return, ready for projection.

Here are the Ciné-Kodak Films; there's a "right" emulsion for every type of movie making.

KODACHROME, the magnificent full-color film, is available in both 8 mm. and 16 mm. widths, in rolls and in magazines. 16 mm. prices: 100-ft. roll, \$8; 50-ft. roll, \$4.30; 50-ft. magazine, \$4.65. 8 mm., 25-ft. roll, \$3.40.

KODACHROME, TYPE A, is color balanced for color movies by Photoflood light. Available in the same sizes as regular Kodachrome and at the same prices.

SUPER-XX "PAN" is the high-speed black-and-white film for indoor movies or for shots wherever daylight is poor. 16 mm. only. The 100-ft. roll is \$6.75, 50-ft. roll, \$3.75, and 50-ft. magazine, \$4.

SUPER-X "PAN" is the favorite outdoor film for general work, accurately responsive to filters; yet it is fast enough for indoor

work, assuming ample lighting. A 16 mm. film. The price, per 100-ft. roll, is \$6; 50-ft. roll, \$3.25; 50-ft. magazine, \$3.50.

CINÉ-KODAK SAFETY (Panchromatic), an inexpensive, relatively slow film of good quality, for use when the special qualities of the other films are not required. A 16 mm. film, available only in 100-ft. rolls, at \$4.50.

8 MM. SUPER-X "PAN" is the speed film for 8 mm. camera owners, a brilliant, clean-cut film of ample speed for well lighted interiors and for the widest variety of outdoor work. The 25-ft. roll is \$2.25.

8 MM. "PAN" is the famous, fine grain film that made 8 mm. movies not only possible but popular. A beautiful, wide latitude, daylight film. Price, \$2.

EASTMAN KODAK COMPANY, ROCHESTER, N. Y.

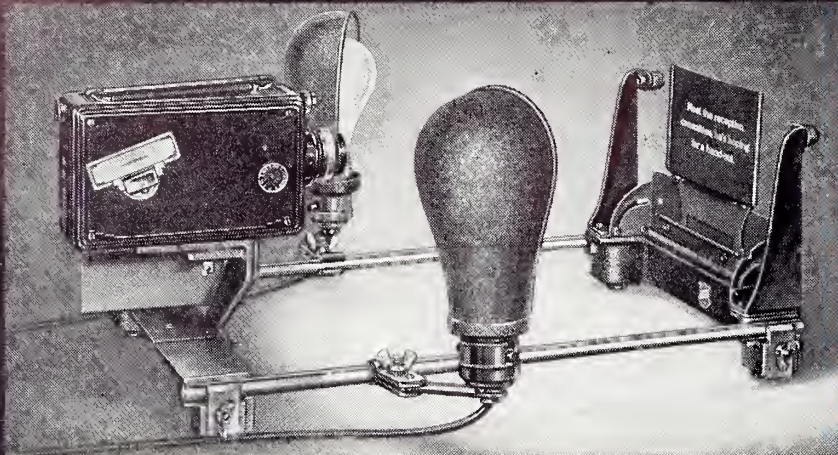

SIMPLE... EASY... SURE: Focusing the new B&H Titler is done with the lens focusing scale; distance is one foot. (If camera does not focus down to one foot, focus corrector is used.) Spacer rods hold camera mount and title card base in correct alignment and spacing. Reflectors are clamped to each rod where they may be moved about for various lighting effects. These reflectors use standard No. 1 Photoflood bulbs.

If you have a Filmo 141, or 70, or 121, here is the *Character Titler* that assures professional results. It provides means for attaching any one of the above Filmo Cameras at one end—while at the other end is the title card holder which is easily adjusted to align a test card before the camera viewfinder. When test card has been aligned and card holder locked in place, all title cards placed in the holder before that same camera will be correctly positioned with respect to the photographic lens.

For quicker, easier production of professional-quality titles...

NEW BELL & HOWELL CHARACTER TITLER

Accommodates
16 mm. *Filmo* 141, 70, and 121 Cameras

WHAT YOU CAN DO WITH THIS TITLER:

Filming possibilities with this new titler are practically unlimited. Whatever you can imagine—you can do. For example:



Title cards of any style — printed or hand lettered.

Animated titles in which movable letters are used.



Hand-written cards with fingers and pen shown in the act of writing.



Small scientific subjects such as flowers, insects, etc.

Still pictures and an endless variety of other possibilities.



...and for professional-quality movies at snapshot cost

BELL & HOWELL *Filmo* 8 mm. CAMERAS

MAKING movies with a Filmo 8 mm. Camera always surprises those who have never tried this most fascinating of hobbies with a Filmo. Precision-built by the makers of Hollywood's professional equipment, Filmo 8 mm. Cameras give you the last word in 8 mm. quality *at no more cost per movie scene than for a snapshot!* And so easy! Just press the button—*what you see, you get.* Lenses are color corrected. Governors assure constant speed through entire run. Shutters give uniform exposure over entire picture area. Filmo 8's provide extra speeds including slow motion. They get perfect pictures indoors or out... and they are all *basic* cameras with provision for special lenses and accessories to keep pace with your product. There are three Filmo 8 mm. models from which to choose—and each provides what thousands of seasoned movie makers believe is the absolute ultimate in 8 mm. camera value.



Filmo "Companion" 8
Palm-size, with F3.5 universal focus lens, only \$49.50.



Filmo "Sportster" 8
With fast Taylor-Hobson F2.5 universal focus lens, \$75.

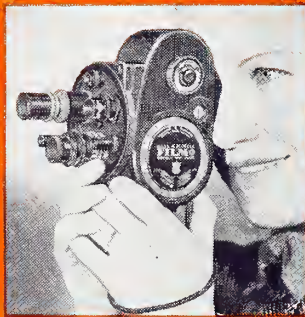

Filmo Turret 8
Most versatile of Filmo 8 mm. Cameras, with F 2.5 lens and matching viewfinder objective on three-lens turret, \$140.
Pictured here with rewind attachment for making lap dissolves and double exposures, \$37 extra.

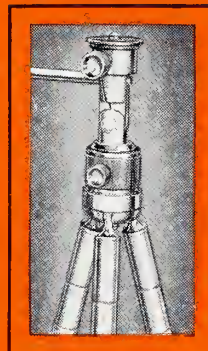

NEW HI-SET TRIPOD

This moderately priced new tripod provides a host of desirable features. Weighs only four pounds. Folds to only 27½ inches long, yet extends to 64 inches—no stooping. Telescoping legs lock *positively* at eleven different lengths, with ingenious new sliding-collar lock control. Removable pan-and-tilt head has independent lock on each movement and permits full 90° tilt. Tripod and head are entirely of metal, chromium plated over all. Complete, \$12.50. Without pan-and-tilt head, \$8.75.

New "Universal" Features for Immediate Release from Filmosound Library

(RENTAL OR SALE)

16 mm. sound films specially selected for family use.
"THAT CERTAIN AGE"—Deanna Durbin, Melvin Douglas
"FRESHMAN YEAR" "THE LADY FIGHTS BACK"
"IDOL OF THE CROWDS"
25 NEW "UNIVERSAL" SHORTS including "Going Places,"
Cartoons, and Thrill Specials

FILMSOUND LIBRARY CATALOG SUPPLEMENT 1940-A
Lists 150 new "independent" acquisitions. Send for it.

MAIL THIS COUPON for complete information. Bell & Howell Company, Chicago; New York; Hollywood; London. Est. 1907.

BELL & HOWELL COMPANY
1825 Larchmont Ave., Chicago, Ill.

Send details and prices on () new 16 mm. B&H Character Titler; () Filmo "Companion" 8; () Filmo "Sportster" 8; () Filmo Turret 8; () new Hi-Set Tripod. Include free list of () sound, () silent 16 mm. films for home showings.

Name.....

Address.....

City..... State..... HM 6-40

PRECISION-MADE BY

BELL & HOWELL

Price 25c

HOME MOVIES



Courtesy Golden Gate International Exposition

July . 1940

Hollywood's Magazine for the Amateur

Laughs and Thrills galore for Home Movie shows!



• Charlie Chaplin in "Sour Dough"

CHARLIE CHAPLIN'S early successes are still sure-fire entertainment wherever shown, and also include many old-timers such as Chester Conklin, Slim Summerville, Marie Dressler, and others. The following comedy shorts are recommended:

Charlie Takes Time Out	347-A	Charlie Gets Caught	344-A
Charlie Spills the Beans	348-A	Charlie Steps Out	345-A
Charlie in Sour Dough	349-A	Charlie, the Nurse Maid	346-A
100 ft. 16mm	\$2.50	50 ft. 8mm	\$1.25

SPECIAL Charlie Chaplin in "Dough and Dynamite"—Two reels 16mm silent \$20.00

"THE DOG FIGHT"

The thrills of an invading air armada in flight, plane-to-plane encounters in midair, takes you right into the pilot's seat behind crackling machine guns. Shows what is going on in the skies over Europe today. A film suitable for audiences young or old. In ordering specify No. 291-A.

100 ft. 16mm	\$2.50
50 ft. 8mm	1.25



•
At your dealer's,
ask for
"Screen Tested"
Hollywood Home
Movies . . . every
print perfect!
•

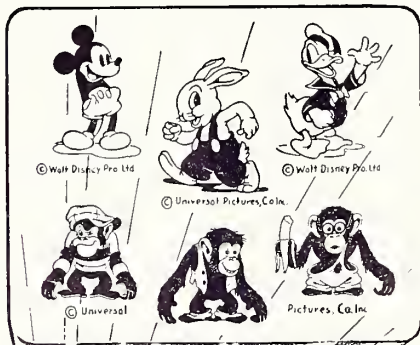

For the LAUGH in your Program —

slip a reel of Mickey Mouse, Donald Duck, Oswald Rabbit or Meany, Miny and Moe on your projector! An instant hit with any audience. Add these rib-tickling reels to your library today!

PRICES
Cartoon Films
100 ft. 16mm \$3.00
50 ft. 8mm \$1.50
Please specify catalog number when ordering

Mickey and the Dog Catcher	912-A
Mickey and Pluto	921-A
Donald Duck, the Ham Actor	914-A
Donald, the Auto Mechanic	913-A
Oswald's Goofy Gopher	22-A
Oswald's Ball Game	3-A
Meany, Miny, Moe—"Goofy Golf"	1207-A
Meany, Miny, Moe—"Beauty Shop"	1202-A

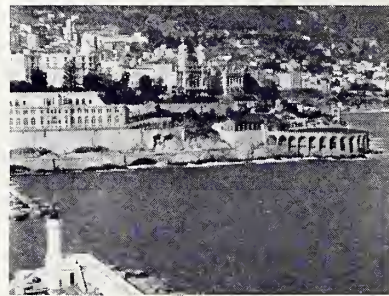

FRENCH RIVIERA

The playground of Europe flung along the southern coasts of France and Italy and one of the objectives in Italy's invasion of France. Shows the beautiful bays, the famous Casino, and the picturesque highways and promenades of this glamorous city. Subject No. 1070-B.

200 ft. 16mm—\$5.00 100 ft. 8mm—\$2.00

Distributed exclusively by SEEMANN'S, INC., Hollywood, Calif.

HOLLYWOOD FILM ENTERPRISES, INC.

6060 SUNSET BLVD. • HOLLYWOOD, CALIF.

JUL - 5 1940

©CIB 459784 *yz*



★ Shot of the Month...

ADVISORY EDITORS

GEORGE BURNWOOD
The 8-16 Movie Club, Phila., Pa.

JAMES BIALSON
Amateur Motion Picture Club of St. Louis

PAUL SNYDER
Norfolk Amateur Movie Club

EDNA RIEBETH
Minneapolis Cine Club

MARCISSA A. PELLETIER
Toronto Amateur Movie Club

EDNA NESTELL
Cinemon Club

CLAUDE W. A. CADARETTE
Los Angeles 8mm Club

FRED F. KAUFMAN
Indianapolis Am. Movie Club

MYRIL DVORAK
Suburban Amateur Movie Club

W. O. ROUNTREE
Bay Empire 8mm Movie Club

BERT B. GRIFFITH
Sunkist Movie Club

ARTHUR E. GIBBS
Portland Cine Club

W. A. HOOK
Seattle 8mm Club

W. EMERSON CLYMA
Detroit Society of Cinematographers

W. F. SISSEL
Austin Movie Club

W. THEO. ROTH
Sherman Clay Movie Club

W. EED E. SNYDER
Des Moines Y. M. C. A. Movie Club

W. R. C. ENION SMITH
Metro Movie Club of Chicago

W. MOSS BROWN
Dallas Cinema Club

W. PETER BEZEK
Chicago Cinema Club

W. RUSSELL A. DIXON
Pittsburgh Amateur Cinema Club

Entered as Second-Class Matter, May 6, 1938, at
the Postoffice at Los Angeles, California, under the
Act of March 3, 1879.
Subscription rates—U. S., \$2.00 a year. Canada,
\$2.00 a year. Foreign, \$3.00 a year. Single copies,
35c. Foreign single copies, 35c. Copyright, 1940,
by Ver Halen Publications. Advertising Rates on
Application.

home MOVIES

Copyright 1940 by Ver Halen Publications. No part of
magazine may be reprinted without specific permission.

CONTENTS FOR JULY, 1940

THE READER SPEAKS.....	318
INFORMATION PLEASE.....	320
WITH THE PRO-16'S.....	322
COATING LENS INCREASES ITS SPEED..... <i>By Henry M. Bray</i>	325
MOVIE OF THE MONTH..... <i>By J. H. Schoen</i>	326
HERE'S NEXT SUNDAY'S SHOOTING SCRIPT..... <i>By Curtis Randall</i>	328
BUILD THIS TURRET FOR YOUR KEYSTONE "8"!..... <i>By Jack Irwin</i>	330
MAKE WAY FOR HOME MOVIES IN YOUR NEW HOME PLANS <i>By Warren Garin</i>	332
HOME MOVIE SHOWS BRING CHEER TO OLD FOLKS <i>By Dr. A. K. Baumgardner</i>	334
WIND BACK, FADE, DISSOLVE, AND WIPE OFF WITH THIS GLORIFIED-16..... <i>By Arthur H. Hart</i>	335
SO YOU WANT TO KNOW HOW TO DO IT!..... <i>By Geo. W. Cushman</i>	336
SIMPLE TEST FOR HOMEMADE TELE-LENS..... <i>By Walter W. Light</i>	337
TITLE CENTERING GUIDES.....	338
TELL ME—HOW CAN I IMPROVE MY FILM?..... <i>By The Editors</i>	339
EXPERIMENTAL CINE WORKSHOP.....	340-41
IT'S NEW TO ME.....	342
TITLE EXPOSURE CHART.....	344
FILTER FACTOR CHART.....	346
EXPOSURE METER GUIDE.....	354
TITLE BACKGROUNDS..... <i>By Edmund Turner</i>	355

J U L Y
1940
NUMBER 7
VOLUME VII



★ Shot of the Month — Enlargement reproduced from frame
of Werner Henze's 16mm Kodachrome film, "Slabhappy." A
sunset shot pictorially perfect.

CHAS. J. Ver HALEN
PUBLISHER

C. J. Ver HALEN, JR.
ASSOCIATE PUBLISHER

ARTHUR E. GAVIN
EDITOR

OFFICE OF PUBLICATION
6060 Sunset Boulevard, Los Angeles, Calif.
Phone GRanite 5149

NEW YORK OFFICE
Everett Gellert, 62 West 45th Street
Vanderbilt 6-5254

CHICAGO OFFICE
C. N. Burris, 712 Wrigley Building
Whitehall 7784

RAY FERNSTROM
Technical Editor

GEORGE W. CUSHMAN

J. H. SCHOEN
Associate Editors

COUNT H. von SCHOENFELDT
Photographic Editor

C. E. BELL
Associate Photo Editor

L. C. BUSCHER
Art Director

SEYMOUR B. AGINS
Asst. Art Director

The NEW G-E

3 METERS IN 1

Covers brightness range
from .05 to 1700 candles
per sq ft



Meter No. 1: With hood off, the G-E exposure meter gives correct readings in brightness as low as .05 candle per sq ft. Scale is calibrated in standard foot-candle light units. By incident-light method, lowest reading gives correct exposure in conditions equivalent to scene brightness of .05 candle per sq ft or less.

Meter No. 2: With cover open, you can obtain accurate exposure readings under photo floods and on dark days. Those important medium-light readings are spread out over the full scale—makes it easy to get accurate readings.

Meter No. 3: With cover closed, the effective acceptance angle is 50 degrees horizontally and 30 degrees vertically. Gives correct exposure readings in light conditions up to scene brightness of 1700 candles per sq ft.

NEW ONE-HAND OPERATION

Molded to fit the hand. One finger controls calculator, cover, and new calculator lock for all bright- and medium-light readings. Large numerals and single light-value scale assure quick, accurate calculations. Ask your dealer for complete descriptive bulletin. Or write G-E Photo Data Service, Section A606-7, General Electric, Schenectady, N. Y.

GENERAL ELECTRIC



606-7M

The Reader



SPEAKS

About "Emblem" Idea---

Since the appearance in the May issue of Irwin Sipherd's suggestion for an emblem to be adopted by amateur movie makers, letters have been pouring in to the editor's desk applauding and supporting the idea. Some of the letters are reprinted below. (Meantime, HOME MOVIES is working on the idea and will have something definite to report real soon.)

Dear Sirs: In "The Reader Speaks" column of the May issue appears a suggestion which I think is great. As a member of the local police department, I come in contact with a great many people. I'm a rabid home movie maker too, and recently a young man from out of town came over to me to ask directions about town. During our conversation, it was revealed this young man was an amateur cinefilmer. As this topic was right up my alley, so to speak, we talked for quite some time on the subject. Boy! When I get talking home movies the other fellow doesn't get a chance!

To make a long story short, we became very friendly, have corresponded with one another and have borrowed each other's films.

— John A. Nystrom.

Gentlemen: I think the emblem or insignia idea, suggested in the May issue, is a splendid one, but don't limit it to clubs alone. There is no cine club within miles of where I live but I would like to be identified as an A. M. M. (amateur movie maker).

Would also like to add the suggestion of an automobile insignia, either as a radiator grill emblem or a windshield sticker.

— Howard G. Keene.

Gentlemen: The idea of an emblem for all home movie makers is great, and I would like to see HOME MOVIES push it through. As a further suggestion, how

about a miniature of the Lloyd Bacon Trophy made into a key or pin?

— John E. Fletcher.

Needs Film

This amateur, like many others who have responded so promptly and energetically to the Showings for Shut-Ins movement, is slowed down temporarily by lack of films. Possibly there are other amateurs, sympathetic with Reader McGrath's activity, who may be able to assist with loan of films.

Gentlemen: Your idea on showing films for shut-ins hit me like a "ton of brick" and I have started to do my part. But, like Stewart Ogg of Chicago (see May HOME MOVIES), I have run out of films to show, and the old budget won't stand any more. I have an 8mm projector and a 16mm combination silent and sound projector. If you can put me in touch with anyone having free films, I can stand the postage and two nights a week to bring some measure of cheer to shut-ins.

— Harry P. McGrath,
68 Lyman Street,
Worcester, Mass.

Swappers

Got some films you want to trade? Want to shoot some footage in exchange for footage you want? Here are some "swappers" requests:

Gentlemen: I would like 50 to 150 feet of 8mm Kodachrome of the San Francisco International Exposition. Will exchange equal footage of the New York World's Fair. Sample shots available at San Francisco.

— A. W. Horne,
39 Parkview,
Millburn, N. J.

Dear Sirs: I have about three feet of 8mm black and white news reel type shot, all closeups, of Governor James of Pennsylvania cutting the ribbon in the opening ceremonies at the Pennsylvania Building at the

• Continued on Page 353

PRE-RELEASE NOTICE!

Subject to receipt of complete, authentic motion pictures from Europe

CASTLE FILMS announces



"BATTLE FOR FRANCE"

16 & 8 MM MOVIES

Ask your Photo-Dealer for definite Release Date

When available, "Battle for France" will be released in five sizes at no increase in regular Castle Films prices!

ACCEPT NO SUBSTITUTE FOR CASTLE FILMS' NEWS PARADE!

CASTLE FILMS

30 ROCKEFELLER PLAZA
NEW YORK

FIELD BUILDING
CHICAGO

RUSS BUILDING
SAN FRANCISCO

16 MM	HEADLINE, 100 ft.	COMPLETE, 360 ft.	SOUND, 350 ft.
	\$350	\$875	\$1750
8 MM	HEADLINE, 50 ft.	COMPLETE, 180 ft.	
	\$175	\$550	

PHOTRIX CINE

A real movie exposure meter, made especially for movie work

THE movie camera owner needs a special exposure meter...he thinks in terms of operating speeds, not in exposure time... his main camera setting is the lens opening... his camera angle is small. That is why ordinary exposure meters are not satisfactory for motion-picture use. PHOTRIX CINE fills the need of movie camera owners... it is not a converted still picture meter, but has been designed, in every detail, for the special requirements of movie work.



HERE ARE ITS OUTSTANDING FEATURES:

- Movable scale of operating speeds for precise adjustment according to specific shutter speed of your movie camera.
- No setting between shots...reads lens opening directly.
- Sensitivity adapted to full range of light conditions occurring in cine photography.
- Tapered light chamber giving sharply defined light acceptance angle of 50 degrees.

The ideal exposure meter for amateur and studio use, with every movie camera, with all color and black-and-white films.

Top-grain cowhide zipper case, \$1.50

\$22.75

- RANGES**
- Brightness: 0.75 to 4500 cdl./sq. ft.
 - Lens Opening: F:1 to F:32
 - Light Acceptance Angle: 50°
 - Film Speed: 0.75 to 800 W., 8 to 33 SCH.
 - Operating Speed: 6 fr./sec. to 123 fr./sec.
 - Shutter speed at 16 fr./sec. adjustable from 1/25 to 1/50 sec.

MADE IN U. S. A. by craftsmen with more than 25 years experience in electrical precision instruments. Photrix Cine is reliable, sturdy... built for years of faithful service. At your dealers, or write Dept. P-7.

INTERCONTINENTAL MARKETING CORPORATION, 8 West 40th Street, New York

MORE OOMPH FOR YOUR HOME MOVIES

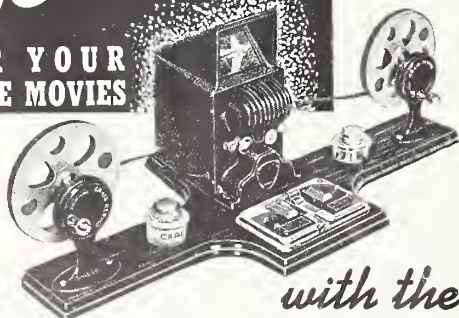

with the CRAIG PROJECTO-EDITOR

It takes proper **Editing** to make modern fast-moving, interest-sustaining movies. **ACTION-EDIT** your films the Hollywood Studio way — transform random shots into smooth-running sequences that everyone will enjoy seeing.

The Projecto-Editor provides a unique viewing method — allows careful inspection, slow motion if desired, of every movement on its brilliant miniature screen. Films may be readily removed from the polished guides for quick cutting and splicing.

At all dealers — Ask for demonstration.
8mm. model, complete . . . \$27.50
16mm. model, complete . . . \$49.50

CRAIG MOVIE SUPPLY COMPANY

1053 S. OLIVE ST. • LOS ANGELES, CALIF.

"Makes Editing a Pleasure"

- Craig Senior Rewinds \$4.50 each or \$9.00 the pair
- Craig Junior Splicer 8 or 16 mm., \$2.50
- Craig Junior Combination Complete, \$7.25
- Craig 16mm. Senior Splicer For sound or silent, \$10.00
- Craig Senior Combination Complete, \$19.50

Craig Safety Film Cement—25c

Information PLEASE

Animated Cartoons (A. R. Sanding, Washington, D. C.)

In making drawings on celluloid for animated cartoons, I find the ink runs. What ink do professionals use and what gauge celluloid do they use?

• READERS: This department is for your benefit. Send in your problems and our technical board of professional cameramen will answer your question in these columns. If an answer by mail is desired, enclose addressed stamped envelope.

Higgins Waterproof Ink and DuPont Celluloid — weight .005 — is used in the animated cartoon studios of Hollywood. The number of separate celluloid sheets or "cells" you may use for each shot will, of course, depend upon the action at hand. But it must be remembered that for each "cell" used, there is a change in density. So if you start out using, say four cells, you should continue using the same number throughout the picture in order to avoid changes in density or tone of the background.

Removing the Works (A. R. Thalbot, New York City)

Will you please advise how I can remove the mechanism from my Model 20 Eastman 8mm camera? This is the model without the interchangeable lens. Can the lens be detached?

In the April issue of HOME MOVIES, R. E. Merville described a method for removing the works from an Eastman 8mm camera. However, the camera he described had the removable lens. If you will carefully examine the construction of your camera, you will undoubtedly be able to solve the problem of the fixed lens. We know of no one who has attempted to dissect this particular camera thus far, and we therefore hesitate to offer any advice on the problems you may encounter — particularly as accurate replacement of the lens would be highly important to its successful operation.

Obviously, if the lens is replaced too near or too far away from the film plane — even a few thousandths of an inch — focus will be seriously affected. Unless the mechanism assembly can be removed with the lens in-

• Continued on Page 354

Sunset Shots (H. Bowen, Oakland, Calif.)

I would like to film a sunset with Eastman panchromatic film and Filmo "8" Sportster with f 2.7 lens. Please advise what exposure to use.

In view of the fact the sun will be the main subject of your picture, you cannot under-expose it. To obtain the effect of dusk or evening, close your lens down to its smallest stop — f/16. This will result in objects in foreground registering in silhouette and reduce exposure sufficiently to obtain an outline of the sun. If you have a filter, use it also, for additional shortening of exposure. Usually, however, the smallest stop on the camera will do the job.

After setting up your camera, check for too strong rays of sun striking the lens. Otherwise, your sunset shot may not be successful. If the sun in your sunset shot is too bright, it is advisable to move your camera slightly so that sun rays do not strike the lens directly. Use of a sun-shade for such shots is recommended.

HERE'S HOW!

Visiting one of the studios recently, we saw them shooting a huddle of football players in a novel manner. Instead of placing the camera on the ground and shooting into the players' faces, the camera was set up on a tripod and focused on a large plate glass mirror lying on the ground and tilted at a very slight angle. The players were grouped about the mirror in huddle formation and their reflection filmed by the camera.



Home Movies

MAGAZINE



**Subscription
Order Form**



HERE WE COME!
 START YOUR MOVIE CAMERA!



Only Motion Pictures

of your day at the beach can capture all of the action that you will want to record.

Full color or brilliant black and white 8mm movies can be made easily and economically with the Revere Double 8 Camera. Even a school child can load and thread the Revere and get beautiful, steady, theater-quality movies. Its exclusive sprocket control forms a loop in the film should the user forget to make one. Take-up spool does not snub film. Sprocket prevents film jamming.

Sighting through the large built-in viewfinder is simple too. Just press the button and your movie is made. Economical—20 or more action scenes from every reel. See Revere equipment at your dealer's! Mail coupon now for literature!

**Revere
 Double 8
 CAMERA**

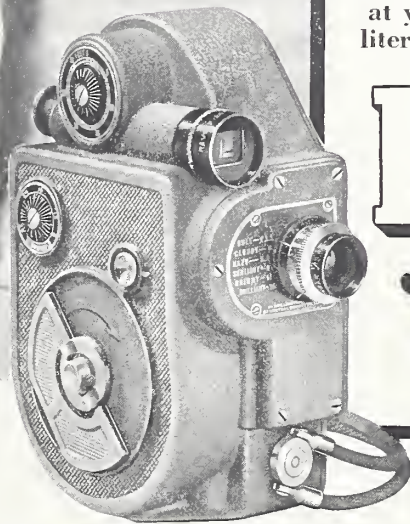

Licensed Under Eastman
 Spool and Spindle Patents

**REVERE 8 PROJECTOR
 SETS NEW STANDARD**

Check its feature and you will understand why Revere has had to greatly increase production capacity to catch up with the demand! 300-foot reels, double blower cooling system, enclosed film rewind, quiet, powerful AC-DC motor, large 15-tooth sprockets. Complete with 500-watt lamp and 1" F1.6 lens \$59.50

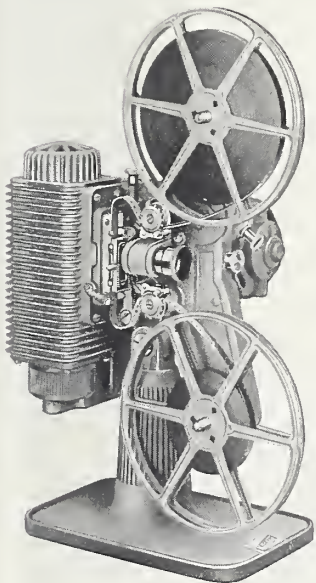

**REVERE MODEL 88
 DOUBLE 8 CAMERA**

—precision built to give you the steadiest and clearest home movies you have ever seen. It takes all double 8 film—full color or black and white. Eastman Type Spindles and Spools insure correct threading. Five speeds—8, 12, 16, 24, and 32 frames—and many other advanced features. Complete with Wollensak 12.5mm and F3.5 lens in removable universal focus mounting . . . \$29.50
 With F2.5 lens \$39.50

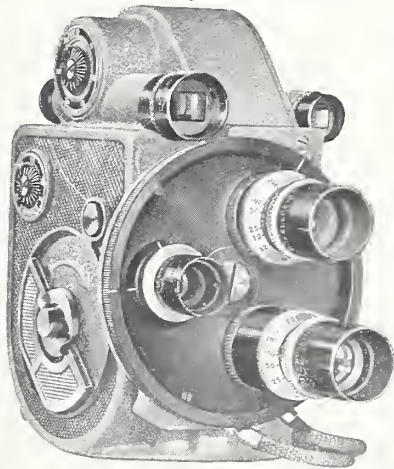

**REVERE MODEL 99
 TURRET CAMERA**

For maximum versatility at low cost here is a sensational value! The Model 99 has all the features of the Revere Model 88 plus a revolving 3-lens turret and an extra optical viewfinder for use with 1" and 1½" telephoto lenses. Complete with one Wollensak 12.5mm F2.5 lens . . . \$65.00

**REVERE SPROCKET
 FILM CONTROL**

forms a loop in the film automatically—prevents film jamming. An exclusive Revere feature.

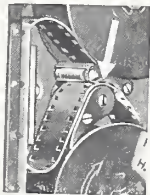

REVERE CAMERA COMPANY • CHICAGO
 PHILADELPHIA • KANSAS CITY • MINNEAPOLIS • LOS ANGELES • DALLAS

REVERE CAMERA COMPANY
 Dept. 7HM, 320 East 21st Street, Chicago, Ill.

Please send latest literature of Revere 8 motion picture equipment.

NAME _____

ADDRESS _____

CITY _____ STATE _____

For Canadian prices, write to Ryerson Film Service,
 299 Queen Street, West, Toronto



- 1 Provides an exclusive type of Automatic Film Protection that is fool-proof.
- 2 Assures unquestioned superiority of sound — eliminates flutter and "wows" — has improved sound optic, special high-amperage exciter and special speaker construction.
- 3 Projects silent, sound, colored, and black and white films without additional equipment — something no other projector can do.
- 4 Is simplified to insure easier setting up, threading and operation. Has convenient power rewind.



These and many other exclusive Victor features mean professional results and greater enjoyment. Your dealer will be glad to show you these advantages.

Victor is also the favorite projector for school and commercial use. The famous Victor Multiple Use Units feature: wider use for auditorium or outdoors, public address system, record playing and recording facilities, central radio and inter-room communication. WRITE TODAY for complete details. Victor costs no more than ordinary equipment.

VICTOR ANIMATOGRAPH CORPORATION

DEPT. B-1

DAVENPORT, IOWA

Ask Any Authorized Dealer

Vacation Bound?
TAKE ALONG YOUR CAMERA AND
TITLE AS YOU GO . . .

with a
BESBEE "Stick-On" Letter Set

- Record Every Shot on the Spot
- Avoid Splicing In Extra Titles

This year be ready to show your vacation shots completely titled the minute your film is processed — and save yourself a lot of work besides. Take along a Besbee STICK-ON Letter Set. Compose your titles while sequences are fresh in your mind with handy Besbee Letters (they stick anywhere) and shoot your titles as you go, easily and quickly. Eliminate the mess, fuss and expense of splicing in extra titles. Ask your dealer to show you a Besbee Set. Or send coupon for free samples.

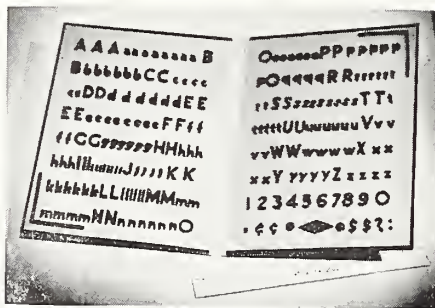

BESBEE TITLE LETTER SET NO. 59 (illustrated) includes 150 3/4-in. Rubber Capital Letters and Numerals. Complete, only \$5.25
 BESBEE TITLE LETTER SET NO. 58 includes 225 3/4-in. Capital and 1/2-in. Lower Case Letters. \$6.50
 Both Sets in Choice of Silver, Black, Blue, or Red

MAIL COUPON FOR FULL DETAILS

ALBERT SPECIALTY CO.
 231 S. Green St., Dept. —
 Chicago, Ill.

Please send me full details on the Besbee Home Movie Titling Aids checked below.

Samples and data on Besbee Title Letter Sets Information on Besbee Universal Title Maker Details on Besbee Trick Effect Easel

Name.....
 Address.....
 City..... State.....

OTHER BESBEE TITLING AIDS

- BESBEE UNIVERSAL TITLE MAKER — Unique device for making professional titles with ease. Complete with 10 accessories and instruction book.....\$12.50
 - BESBEE IMPROVED ILLUMINATOR — Practical device for illuminating titles.....\$5.50
 - BESBEE TRICK EFFECT EASEL — For scroll titles, flop-up and flop-down titles, turn-over and turn-around, and many other effects.....\$8.50
- ALSO Besbee Editing Sets, Trick Title Frames, Close-up Lens Adapters, Reel Clips, etc.



With the **PRO-16's**

Educationettes

William Evans, of Los Angeles, recently worked out a novel idea for short musical subjects to serve as "fillers" on educational and commercial film programs. Each subject, which carries the trade name of "Educationettes," runs approximately 150 feet and consists of scenic material appropriate for its musical accompaniment. Most recently completed are, "In A Monastery Garden," and "Londonderry Airs."

Photographic material is selected not only for excellence of composition, but for its adaptability to the theme music. For instance, "In A Monastery Garden" was composed of scenes of several California missions which are particularly rich in picture material.

Silent versions of "Educationettes" are also available for projection with phonograph records. Evans productions are via the negpos process. Lab work is by Modern Movies, Hollywood.

Peace

Louis Siminow, one of the pioneers in the use of 16mm cameras for producing commercial and educational pictures, has just completed a 400-foot silent film titled, "The American Peace Crusade." This production is intended for showing to churches and other groups interested in pictures on this subject. Siminow has been filming 16mm semi-commercial and educational films for the past ten years.

Safety

What makes a workman slip on a factory floor is being thoroughly investigated by a 16mm camera under the guidance of a Minneapolis commercial film producer. The film, which will include studies in slow motion and by animation, will be used by builders specializing in factory construction to aid them in improving the safety factor of factory floors in all lines of industry.

The result of this cine-

• News of readers' activities in business, school, and publicity film production.

matic research will also be made available to industrial managements for exhibition to their employees as a means of reducing accidents.

Power

The wide use of 16mm sound and silent films by public service companies as a means of building good will is becoming more general throughout the country. Fred K. Rockett, Hollywood, has just completed a 1200-foot 16mm Kodachrome picture for the California-Oregon Power Company. The production will be shown to groups residing within the territory serviced by the sponsors.

Birds

Film actor, Louis Hayward, long an avid amateur cinefilmer, recently made 16mm Kodachrome pictures of a pair of birds building a nest in a tree close to his bedroom window. Filming continued at intervals until Hayward had safely documented the complete story of the birds selecting the site, building their nest, laying and hatching the eggs, and the rearing of the young. Studio associates hearing friends praise the film for its vividness and continuity, urged a screening before a "shorts" producer. The producer acquired the film for a nature study subject and actor Hayward will collect royalties for his cinematic efforts.

Milk

Adequately titled, "Behind The Bottle," a 400-foot 16mm semi-commercial picture recently produced by W. R. Hutchinson, of Newburgh, N. Y., for a local milk distributor was offered in public preview to an enthusiastic audience last week. Hutchinson has not

• Continued on Page 351

"Preview" YOUR SUMMER MOVIES



ON THE **DA-LITE** GLASS-BEADED SCREEN

Reg. U. S. Pat. Off.

For **UTMOST CONVENIENCE**
Use the **DA-LITE**
CHALLENGER

Years ahead in design, the Challenger is the *only* screen with *square tubing* in tripod and extension rod to hold the case rigid — the *only* screen that can be *adjusted in height by releasing a spring latch* and raising the extension support. No separate adjustments of the case. Twelve sizes from 30" x 40" to 70" x 94" inclusive, from \$12.50* up.



THE DA-LITE JUNIOR

has the same high quality Da-Lite Glass Beaded surface as the Challenger. It may be set up on a table or hung on a wall. 4 sizes from \$2.00* up.



You need the *superior light reflective* quality of the Da-Lite Glass-Beaded surface to bring out the true colors, sharp details and full brilliance of *Kodachrome* pictures. Because Kodachrome film is more dense than black and white, it *requires a screen that reflects more light*. The *specially constructed* Da-Lite Glass-Beaded Screen reflects maximum light, yet without sparkling or glare. It brings out all of the shades of color pictures and all gradations of black and white. That is why Da-Lite, though making White and Silver screens, recommends its *glass-beaded* surface for all average requirements.

Ask your dealer for a demonstration. The Da-Lite *Beaded* surface challenges comparison with all other screens . . . beaded or otherwise. See also how *much easier* the "all-in-one" Da-Lite Challenger is to set-up — how durably it is made! Look for the exclusive *square* tubing that keeps the case aligned! Other styles also available. Write for literature now!

DA-LITE SCREEN COMPANY, Inc.
Dept. 7HM, 2723 North Crawford Ave. Chicago, Ill.

STEADY YOUR CAMERA WITH THE DA-LITE UNIPOD

Here is a support so light and easy to carry you will be sure to take it on every movie-making trip. It can be quickly put into service. And there are no parts to take off, carry and get lost. Two styles — No. 1 rests on the ground. No. 2 (shown here) rests against the body. Just the thing for your vacation! Get yours today. Only \$6.00.*

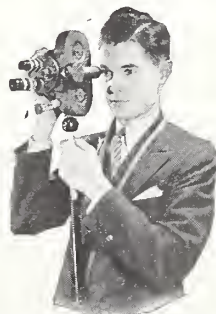

*Prices slightly higher on Pacific Coast.

DA-LITE SCREENS AND MOVIE ACCESSORIES



All Bull's Eyes?

GETTING perfect movies every time requires plenty of experience and ability. But, whether you are an expert or a beginner, you can always have the advantage of the dependable quality of Agfa amateur motion picture films.

We suggest these two fine Agfa 16mm. films for your use this summer:

Agfa Fine-Grain Plenachrome Reversible, an all-around outdoor film that combines speed, brilliant contrast, and an agreeably moderate price. Plenachrome pos-

sesses wide latitude and full anti-halo protection.

Agfa Panchromatic Reversible, a fast material, sensitive to all colors, that projects brilliantly and is also economical to use. We recommend it highly for a wide variety of subjects.

Get these two films at your dealer's today. Each is \$2.75 for 50-ft. and \$4.50 for 100-ft. rolls. Price includes processing and return postage. **Agfa Ansco, Binghamton, N. Y. Made in U. S. A.**

Agfa
16mm. FILMS

**PLENACHROME
AND
PANCHROMATIC**



HOME MOVIES

Published in Hollywood

JULY 1940

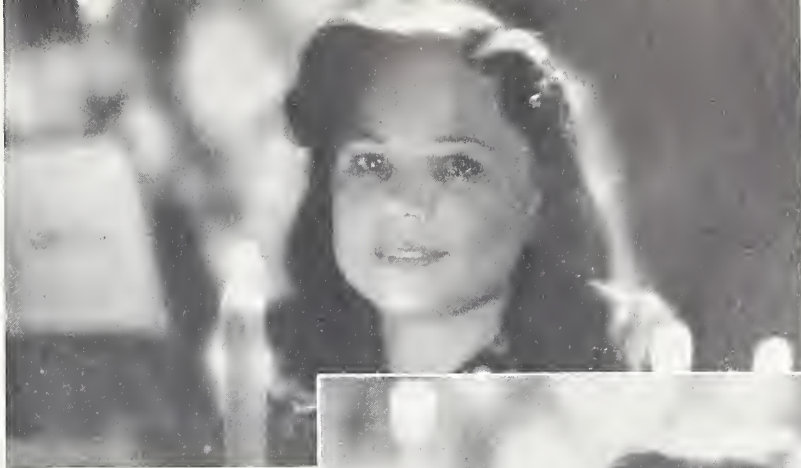

Authored by
HENRY M. BRAY
Vard Mechanical Laboratory

COATING LENS *increases its speed . . .*

ONE of the most interesting developments within recent years in the optical field is the new process of treating transparent materials to reduce reflections and increase light transmission.

There will be wide application for the process, but of immediate and exciting interest are the results being obtained with treated camera and projection lenses.

Lens designers and film manufacturers have battled light and optical corrections for years to make faster photography possible. The lens maker, calculating a lens with an increased aperture, finds it difficult to correct all aberrations without adding more elements to the lens. Thus, we have systems with as many as eight or even ten separate pieces of optical glass through which the light must pass.

It is well known that from 4 to 6 per cent of the incident light falling on an optical surface is lost by reflection. This is primarily true on the surface where the light passes from air to glass and glass to air. In lenses containing several air-glass surfaces, the loss of light is cumulative, *i. e.*, 95 per cent of the light hitting the first surface passes through, then 95 per cent of the original 95 per cent passes through the second, etc. Thus, the lens maker adding more elements to correct aberrations is faced with the cumulative loss of light resulting from the additional surfaces.

Now, attacking from a new front, comes the system of treating optical surfaces for reducing reflection and increasing light transmission.

As far back as 1892, H. Dennis Taylor, British lens designer, noticed the effect of tarnished sur-

faces on lenses. His tests showed more light was transmitted through a tarnished lens than through an untarnished one. He proceeded to attempt artificial tarnishing of lenses.

In 1916, Kollmorgen experimented with different chemicals to find means of etching optical glass. Doctors Kellner, Wright and Ferguson have done much work along this line.

MR. IRVING LANGMUIR started a project, subsequently worked on by Dr. Katherine Blodgett, using fatty acids to form a thin surface on glass. A thin film was built up on the glass by successive dippings into a tank of liquid on the surface of which an insoluble soap film one molecule thick was placed.

There are limitations to both the chemical etching and fatty acid process. In the former, only certain types of glass can be used, the efficiency of the treated surface is low, and the process can get out of control and ruin expensive optical elements. In the latter, the film is delicate and cannot be touched or cleaned, and will not stand heat.

Realizing the seriousness of the many limitations, Dr. John Strong began an investigation of

• Continued on Page 344

• Above: Two scenes from 35mm motion picture film, both made with same light source. Note increased exposure in lower photo made with treated lens. Below: Unretouched photographs of an airplane instrument and a simple magnifying glass, the glosses of which have been treated over one-half their area.

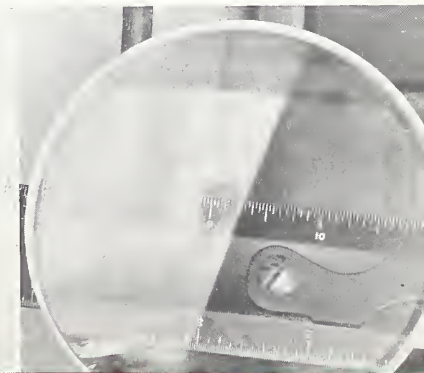



Happy the man, whose wish and care
A few paternal acres bound
Content to breathe his native air
In his own ground. P. 22.

MOVIE of the MONTH

Reported by
J. H. SCHOEN

WHAT constitutes a good home movie will forever be a debatable subject. Just as one may prefer a plate of good, home-baked beans to a planked steak, so it is that a simple, well photographed movie of scenes near and dear to us often makes a greater hit than a well planned scenarized story. Indeed some of the most interesting home movies reviewed during the past year were of quite ordinary subjects, but so carefully and painstakingly filmed, they became outstanding.

Such a film is "Song of the Soil," a 16mm Kodachrome production of E. C. Denny, Buffalo, New York, which runs 800 feet and which has been chosen by the Editors as "The Movie of The Month." "Song Of The Soil" will touch a nostalgic note in the memories of those privileged to view it, especially those fortunate to have been raised close to the soil on the farms and broad acres of New England.

Denny saw in the last remaining farming frontiers of his home state, opportunity to capture on cine film, scenes of rural life fast disappearing before the rapid onslaught of industrialization and because of the trend toward city living. He began with the spring planting and continued his cinematic recording of events clear up to harvest time. And this vast cavalcade of scenes is admirably tied together with titles in verse — excerpts from the poems of some of the world's most renowned authors. This alone must have been a tremendous task, involving as it did, considerable research. For each verse or stanza is decidedly fitting the sequence of scenes which it precedes.

The picture begins with scenes of ploughing and preparing the soil for planting. Then it moves along, taking us from one phase of farming or rural life to another. We are shown the animals of the farm in such delightful scenes as to make us wish to be there. In fact many of the pastoral scenes are so impressive they might well find a place in any art gallery.

CUT in occasionally are sequences showing activities of the people of the community: a children's garden party; the annual fair; and others. Then the story proceeds along to autumn, and shows the country side in all its autumnal splendor. The color of harvest time is evident in many sequences depicting the harvesting of grain, corn, grapes, and fruit. And there's a particularly homey closeup of a basket of delicious dusky-red apples that not only tantalizes the taste-buds but twangs at the heart-strings of those who remember such scenes as a child.

Remarkable is Denny's flair for camera-editing — the manner in which he thoughtfully photographed each important phase of his picture in

• Continued on Page 352

• Pictured here are enlargements from E. C. Denny's 16mm Kodachrome film, "Song of the Soil." At top is one of the many delightful poetic titles, and then reproductions of several of the colorful rural scenes for which this picture is noteworthy.

(Right)

SUNSET SILHOUETTE

An unusual blending of sky, landscape and water that makes a striking title background.

Photo by

A. R. Bowen





Authored by
CURTIS RANDALL



C. E. Bell

leaving nothing else to do but load your camera and get your friends together. The script follows:

"GOLD IS WHERE YOU FIND IT"

Scene 1: Fade-in. Medium long shot of outing group carrying lunch baskets, etc., leaving parked cars and walking toward picnic grounds in foreground.

Scene 2: Medium shot of several persons as they arrive at picnic tables in immediate foreground and begin emptying their baskets and boxes of lunches, table cloths, napkins, etc.

Scene 3: Medium shot of some of the people playing ball.

Scene 4: Medium shot of some of the people taking pictures.

Scene 5: Medium shot of some of the people playing cards.

Scene 6: Medium shot of some of the people eating lunch.

Scene 7: General long shot or slow panorama of entire group eating.

Scene 8: Medium closeup of Tom, who has finished eating, lazily picking his teeth and looking about restlessly, contemplating some excitement. Dick is seated near and is visible in the scene. Sudden change in expression as Tom sees something in distance. Cut to—(Note: Tom is addicted to vigorous picking of his teeth and has a toothpick in his mouth throughout the picture.)

Scene 9: Medium shot of small turbulent stream.

Scene 10: Back to scene 8, enlarged to a closeup of Tom. His expression suddenly changes from that of boredom to sudden interest. Moves to tap shoulder of Dick nearby.

Scene 11: Medium closeup of Tom and Dick. Tom taps shoulder of Dick, who is looking away momentarily, and says:

TITLE: "I've got an idea! C'mon with me."

Scene 12: Back to scene 11 as Tom finishes speaking. Dick responds to Tom's words and they both arise.

Here's next Sunday's SHOOTING SCRIPT!

WHEN friends are reluctant to turn out in a group for home movie filming, often they may be lured to join in a picnic. And then, while under the passive influence of the delectables within the picnic basket they become the most amiable of subjects for our cinefilming.

Here is a shooting script just made to order for a group of friends on a Sunday or week-end outing. The nice thing about it is that it may be adapted for just two people or two dozen, or—with slight changes—it may be filmed by husband and wife with the aid of a third party to assist at the camera and act the role of assayer.

"Gold Is Where You Find It" is an adaptation of a short scenario by Bill Disbrow of San Francisco and in no way resembles the Hollywood production of the same name. The story revolves around two male characters, Tom and Dick, who go along on a family outing, become bored, and set out to pan gold with picnic utensils in a nearby stream. They are soon rewarded with a gold "nugget" which they take to an assayer's office, only to learn that it is a gold filling from a tooth—a tooth of one of the embryo prospectors!

But all of the acting honors do not go to these two alone. There's a "spot"—and many of them closeups—for everyone in the party. The entire story may easily be filmed in a single day, and 200 feet of 16mm film or its equivalent in 8mm should handle the job nicely.

All of the necessary titles are printed on the opposite page, ready to shoot in a typewriter titler,

• Here is a corking scenario for grown-ups—one sure to bring enthusiastic approval from your friends. On the opposite page are all of the necessary titles, printed and ready to use in your typewriter titler. The one just beneath main title is for "cast of characters" or other credit titles.



Scene 13: Medium shot of picnic group as Tom and Dick casually arise and walk out of scene. Tom picks up plate and takes it with him. (This should be a good sized pie-tin or white enamelware dinner plate.)

Scene 14: Group of cars parked at picnic grounds. Tom and Dick enter scene. Tom opens trunk compartment of his car and brings out kiddies' play shovel. Gives shovel to Dick and bids him follow. The two walk out of scene.

Scene 15: Tom and Dick walking through underbrush toward stream.

Scene 16: Medium shot. Small stream in foreground. Tom and Dick come down to bank. Tom speaks:

TITLE: "I've heard there's a chance of finding gold in any kind of a stream. Let's try here."

Scene 17: Closeup of Tom and Dick as Tom finishes speaking. Dick agrees and they look down at stream for a place to start working.

Scene 18: Medium shot. Tom is digging gravel and filling pan. He shows Dick how to slosh the pan back and forth, occasionally dipping it into the water, then hands the pan to Dick. Dick starts to pan, washing gravel slowly in the customary manner. Tom retreats to loll nearby.

Scene 19: Medium closeup of Tom, studiously picking at an object in one of his back teeth. He bends down and takes a drink of the water in the stream, raises his head in a vigorous gargle, then spits the water into the stream at the very edge of the bank. Wiping his face, he turns to Dick and says:

TITLE: "Here, let me pan awhile."

Scene 20: Same as scene 19 as Tom finishes speech.

Scene 21: Medium shot of Tom and Dick. Dick empties pan rather carelessly and hands it to Tom, who moves up stream a bit and starts panning at point where he spit out water. (Follow Tom with slow panning movement.)

Scene 22: Closeup of Tom methodically panning.

Scene 23: Closeup of pan sloshing back and forth in Tom's hands.

Scene 24: Same as scene 22 — Tom shifting toothpick from one side of mouth to the other in rhythm with movement of pan.

Scene 25: Back to scene 21. Dick is lolling on the bank. Tom empties pan, rather disgustedly, scratches head and looks about for a more promising spot. Moves upstream about a foot and resumes panning.

Scene 26: Closeup of Tom panning. Dreamy expression on face. Suddenly, expression changes. He stares at pan in amazement. Cut to—

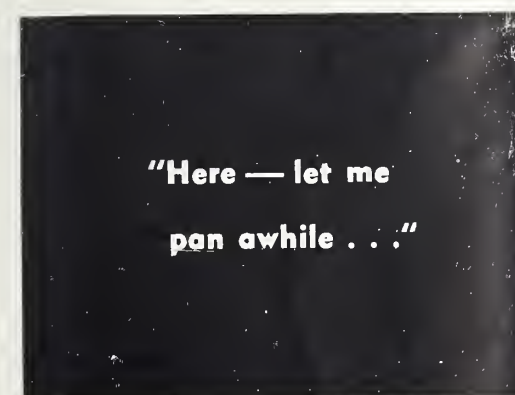
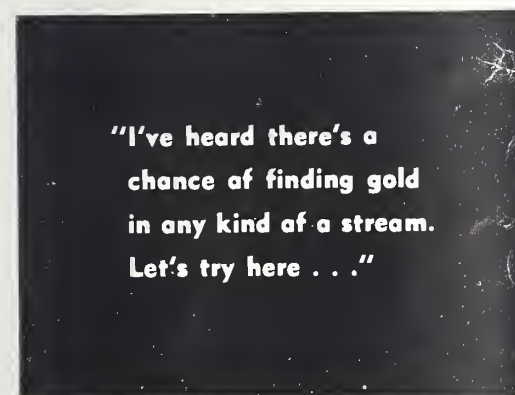
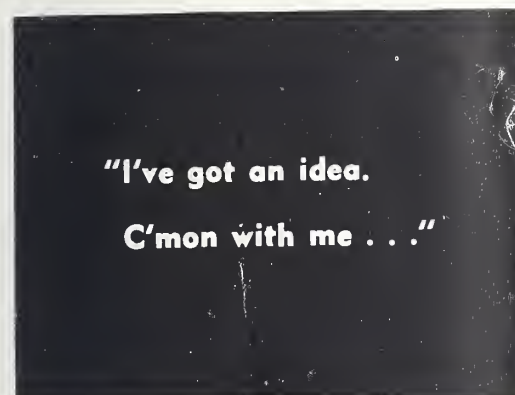
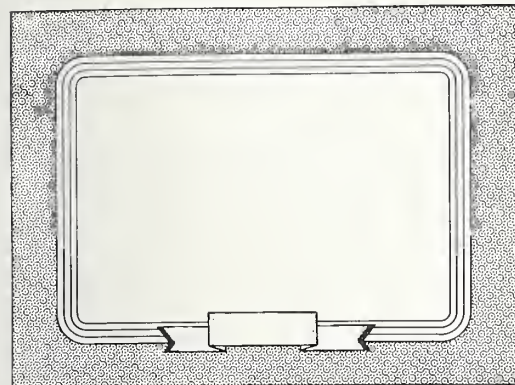
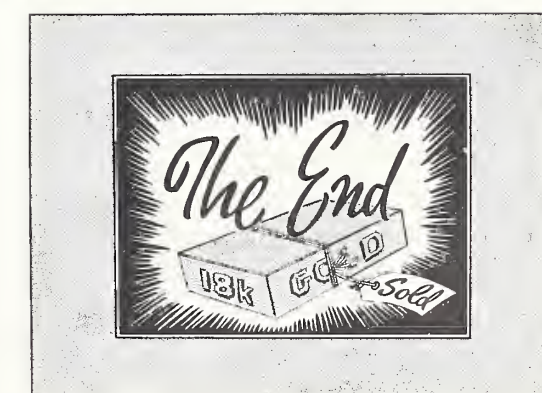
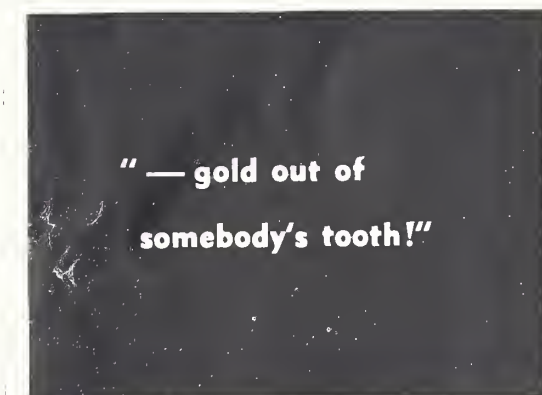
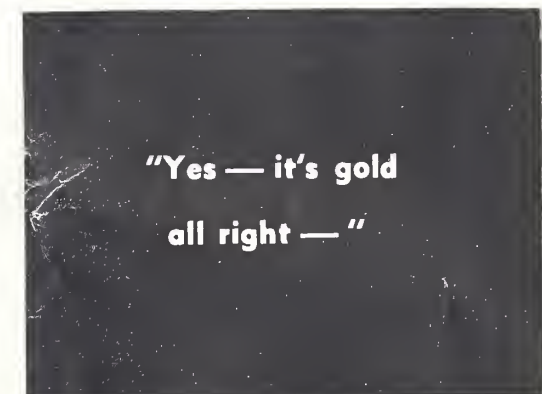

Authored by
JACK IRWIN



for their cameras, we prevailed upon Bauer to furnish complete details of the one he made, and these are transmitted in the set of plans on the opposite page which are drawn actual size. While dimensions are given, we advise that the amateur interested in building this lens-turret feel his way along and "cut his cloth" as he goes, rather than lay out the whole assembly at one time. This advice is particularly emphasized in the experiences of amateurs and specialists in custom-built equipment alike, who have found that gadgets

Build this TURRET for your Keystone "8"!

THERE has been a lot of activity among amateurs recently, designing and making practical turret fronts for the Filmo "8"; so much so, that several firms are now turning them out commercially. But in the meantime, the owners of Keystone "Eights" have not been asleep. They, too, have been dreaming and burning the garage-lights late into the night. And from among these emerged Leonard Bauer, Jr., of Philadelphia, with one of the niftiest two-lens turrets ever built for a Keystone "Eight"!

The whole assembly is attached to the camera with but two bolts; and the only other physical alteration necessary to the camera was the reaming out of the threads in the lens-seat. The lenses, mounted on the turret, fit snugly into the original lens opening of the camera. To interchange lenses, the turret is moved forward by means of a sliding spindle which draws the lens from the camera. The turret is then rotated until the other lens is in position, and then allowed to recede and lock in taking position. Further details of its operation may be had from studying the accompanying photos and drawings.

Bauer purchased all the materials necessary for building his turret from a local hardware store—pieces of brass, and a few bolts and machine screws. The cutting and shaping of the parts was done by him in his workshop, and it is probable that a local machinist aided with what little lathe work was necessary to form the spindle parts and countersink the turret-plate and lens retaining rings.

Knowing that many owners of Keystone "Eights" would like to make a similar lens-turret

of this kind invariably should be "tailored" to the camera for best results.

The starting point, in construction, is the mounting plate (Fig. 1). This is made from a piece of 1/16-inch sheet brass, cut, drilled and formed as shown. This is the piece that is bolted to the left side of the camera (on the door) by means of bolts at "A." The hole "C" is tapped to take the stud shaft "F" in Fig. 7. To this is mounted the round metal shim "B" shown in Fig. 4 which is made from a piece of brass 5/32-inch in thickness. Its purpose is to hold the revolving turret a sufficient distance from the mounting

• Continued on Page 347

• Pictured here are two views of Bauer's two-lens turret mounted on his Keystone "8"; also, a view of the unit before mounting. One of the most practical, the design of this lens turret is likely to be adapted to other cameras. Full size plans and details for construction appear on opposite page.

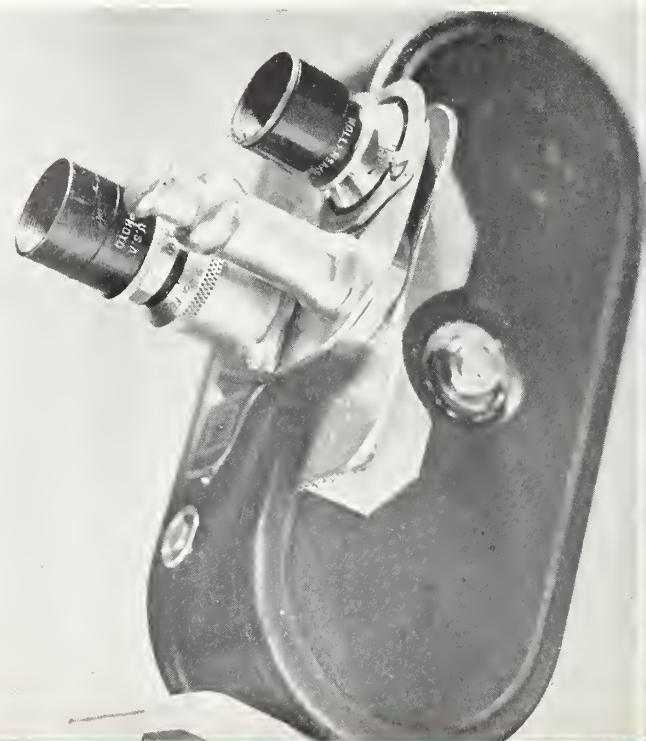

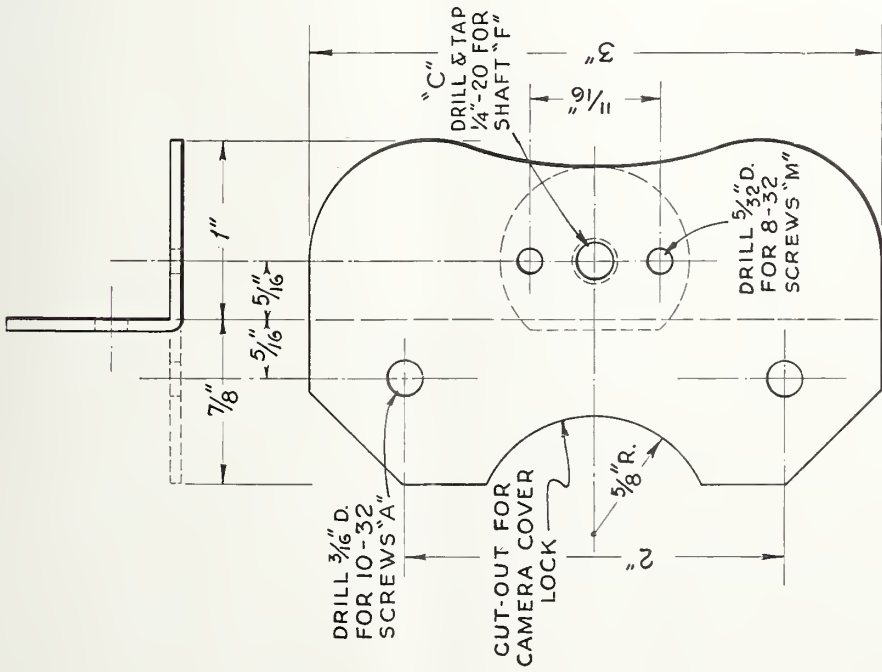

MOUNTING PLATE
Fig. 1

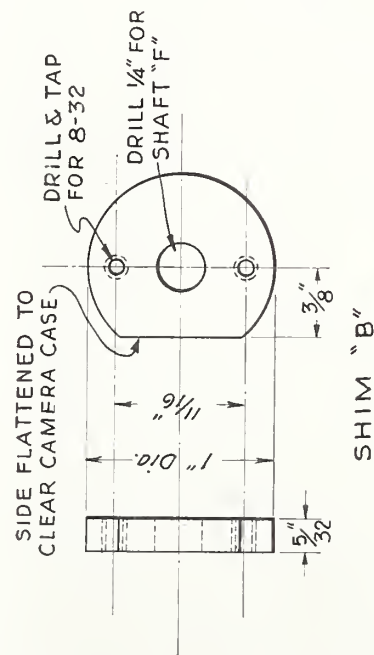

SHIM "B"
Fig. 4

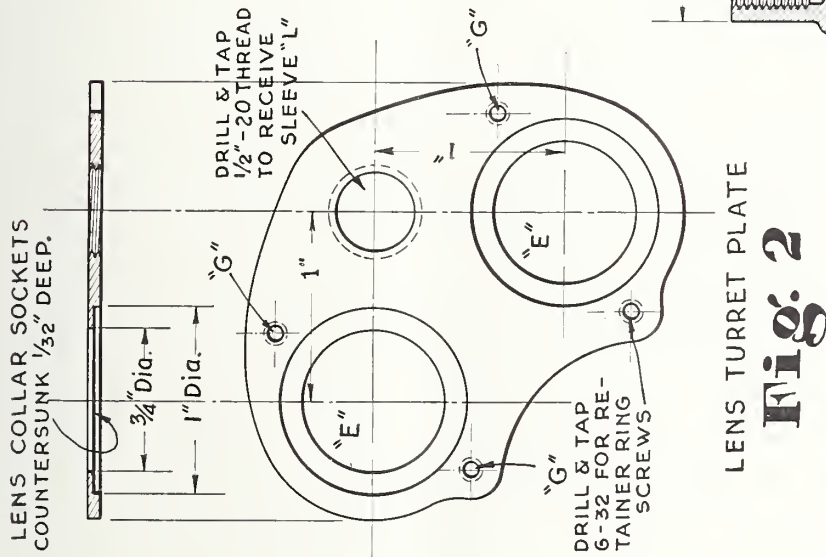

LENS TURRET PLATE
Fig. 2

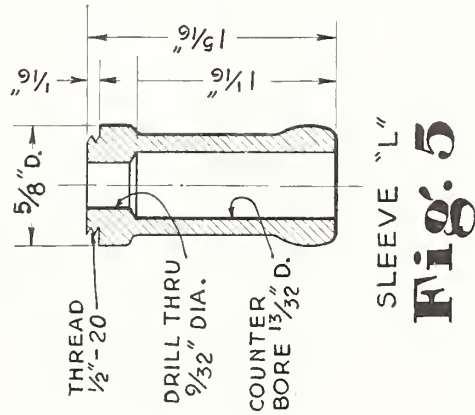

SLEEVE "L"
Fig. 5

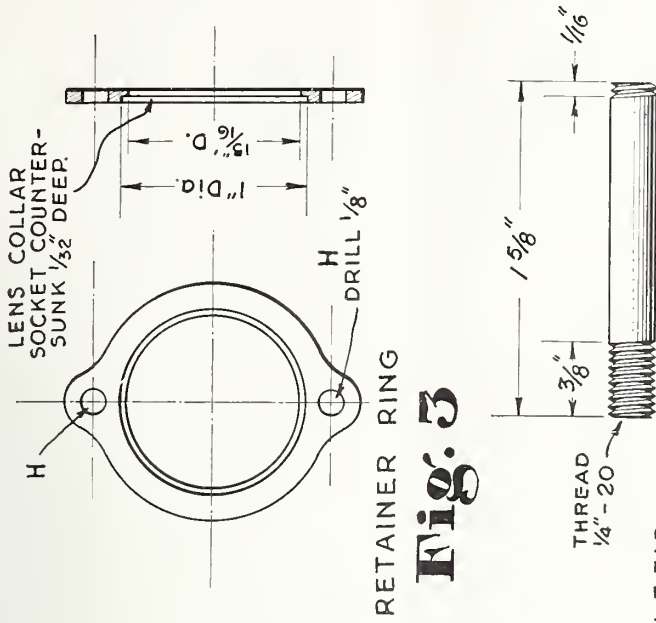

RETAINER RING
Fig. 3

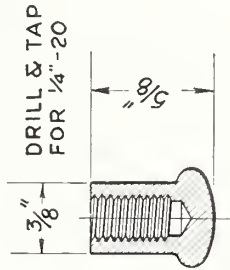

NUT "K"
Fig. 6

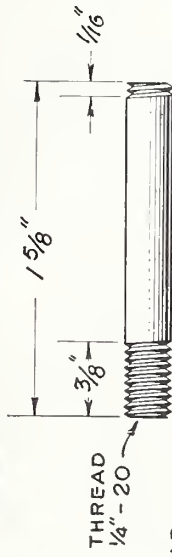

STUD SHAFT "F"
Fig. 7

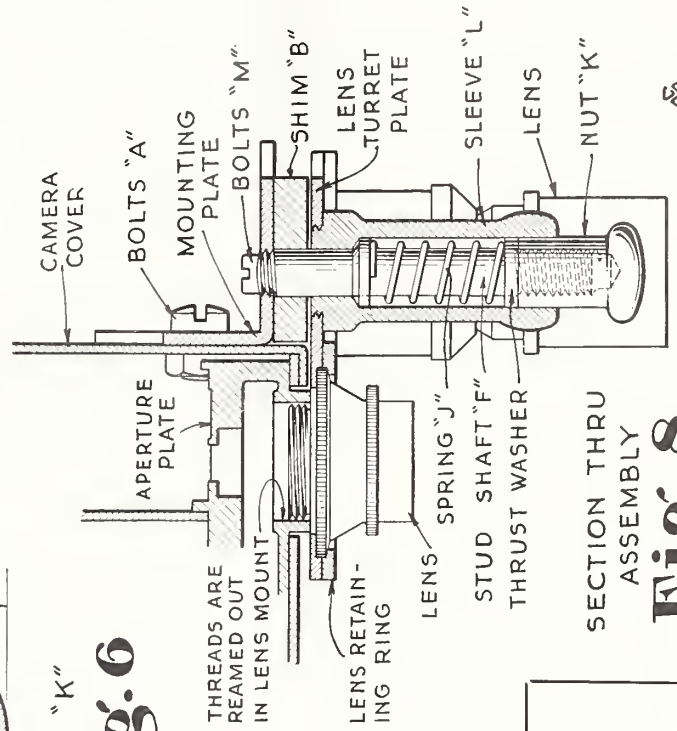

SECTION THRU ASSEMBLY
Fig. 8

FULL SIZE PLANS FOR
LENS TURRET
FOR
KEYSTONE "EIGHT"

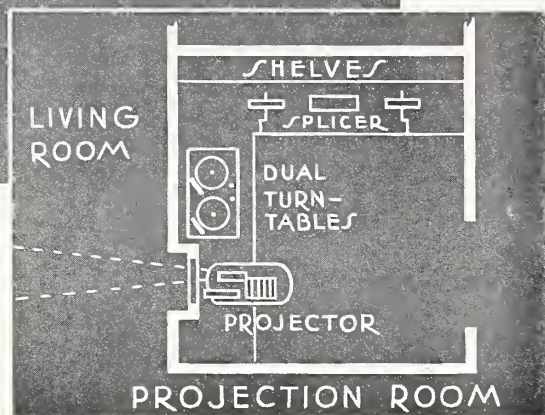
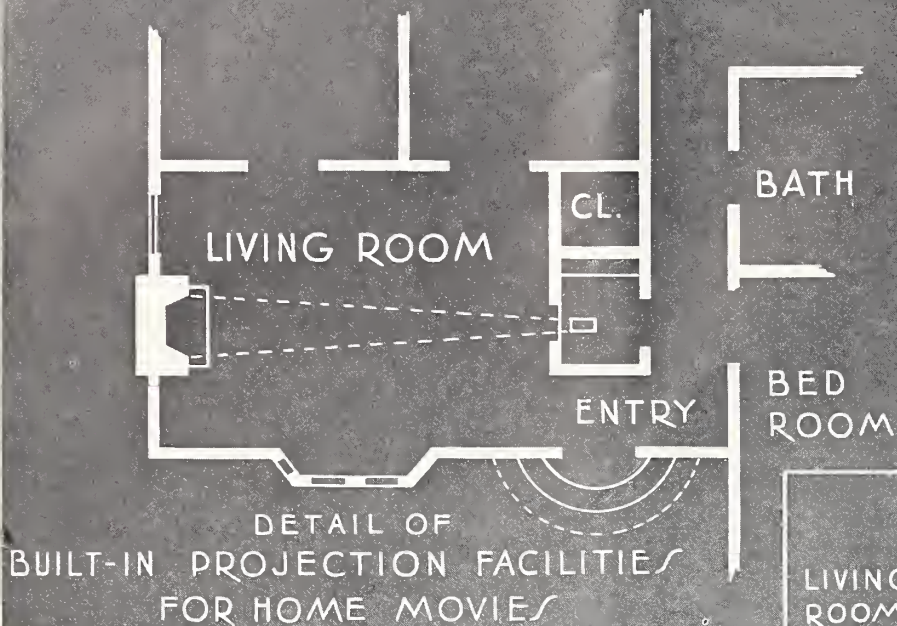

• Figs. 1 and 2: Floor plans provide for projection booth and fireplace with disappearing roller screen. Fig. 3: Showing mantel top open and built-in screen erected ready for use. Fig. 4: Detail showing how loudspeaker of sound system is built into fireplace beneath screen. Figs. 5 and 6: Basement projection booth and theatre of C. B. Stane, Toledo, Ohio. Fig. 7: Electrically controlled beaded screen installed in dining room of David A. Smart, Glenview, Ill. Figs. 8, 9, and 10: Private theatre and projection booth in attic of home of Hugh E. Geyer, New York City. Fig. 11: Showing "ironing board" principle of disappearing projection and sound equipment.

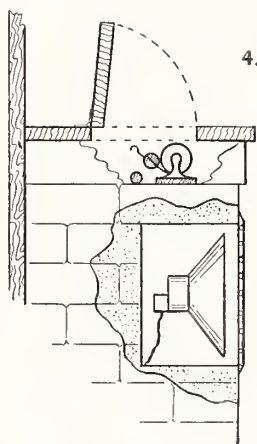
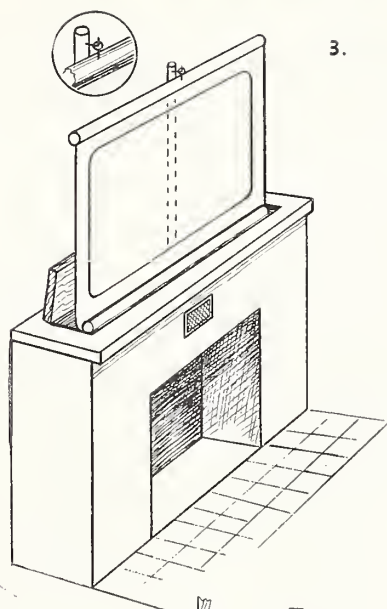

Make way for Home Movies

By WARREN GARIN

...we have built-in beds, kitchenettes, ironing boards, and shower-baths. Now comes built-in screens and projection booths!

WITH an increasing number of cineclickers planning new homes, more architects are offering innovations in home construction designed to increase the pleasure derived from home movies.

One of the cleverest arrangements for home movie screening was recently discovered on the drafting board of a Western architect. A closeup of the plan is reproduced in Figs. 1 and 2. Eliminating a linen closet in the hall and stealing a foot or two from the living room floor space, provides a combination projection room and cine workshop. There is ample room for projector, dual turntables, sound amplifying system,

editing board and film storage shelves.

Pictures are projected to the screen through a decorative niche which is built in over the fireplace at the other end of the living room. This screen, mounted on an ordinary spring window-shade roller, is recessed into the top of the mantel and concealed by a hinged lid as shown in detail in Figs. 3 and 4. When the screen is to be used, the hinged portion of the mantel top is raised and the screen unrolled and held upright by a simple wooden support which is hooked into the batten at top of screen. Immediately beneath the screen and recessed into the fireplace masonry, is the loudspeaker of the sound system which is permanently connected with the amplifier in the projection room.

From the living room, the niche through which pictures are projected looks like any modern decorative nook with shelves for holding small pottery, statuary, and knickknacks. The niche is closed at the back, except when films are to be shown — the back panel being divided in the center and made to slide open or closed as desired.

When the architect recovered from the deluge of enthusiasm shown for his plans, he revealed still another idea he developed — a sort of folding "ironing

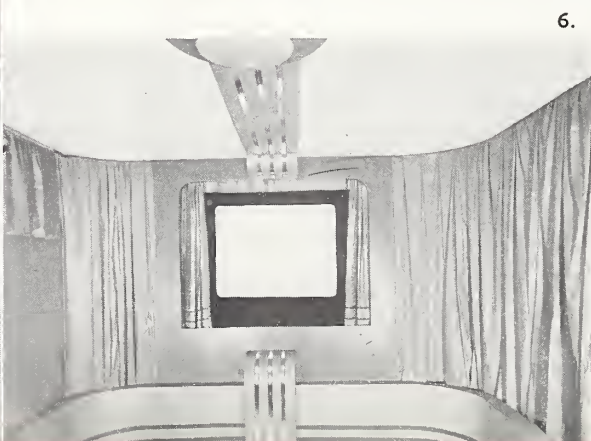
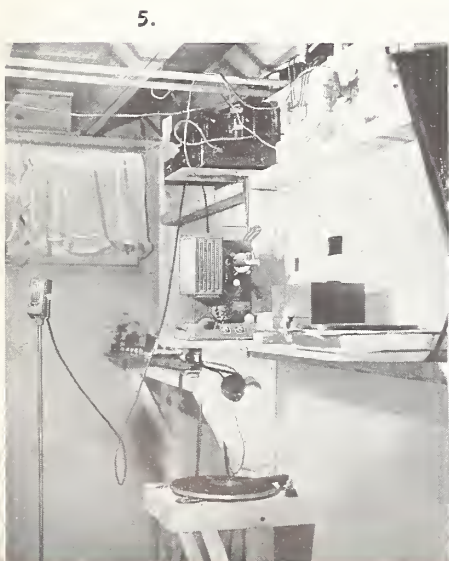



Courtesy Dalite Screen
7.

board" unit to house projector and turntables which could be built into a wall in the living room, and lowered easily into place for screening of movies with sound. This idea is illustrated in Fig. 11. To screen a home movie, the folding baseboard, to which projector and turntables are bolted securely, is lowered into position just like any built-in collapsible ironing board. The current and wiring for sound are permanently connected. Only the reels have to be mounted on the projector, the film threaded and projector started, in order to show the pictures. After the show is over, the unit folds up and into the wall. Special decorative treatment of the walls elev-

n your NEW HOME PLANS!

erly conceals any hint of this secret projection unit.

Where home plans include basement rooms or provide for ample attic space, a surprisingly few dollars will build a cozy private theatre complete with separate projection booth, regulation theatre seats, a stage with a screen that may be raised and lowered electrically, and a curtain which may be opened and closed from the projection booth. Such innovations have already been built into homes by amateurs where home movies were probably unknown or their importance overlooked at the time the home was built.

In Toledo, Ohio, C. B. Stone built a smart little theatre in the basement of his home which will accommodate an audience of 12. The stage, as shown in Fig. 6, was built of wallboard, inexpensive drapery materials, and metallic decorative strips. A davenport and an assortment of easy chairs take care of the seating. The color scheme is in shades of blue and old gold, according to Mr. Stone, with the floor finished in a tile red. Curtains in front of the screen are operated manually from the projection booth by means of pull cords strung on small pulleys and eye bolts.

The ceiling light is an indirect, two-

color neon tube which gives a soft glow to the room. There is also a red and a blue neon tubing behind the proscenium, each four feet long, which permit changing the color effect about the stage and screen.

Back in the projection booth, shown in Fig. 5, the projection, sound, and editing apparatus is conveniently arranged. A single turntable and a microphone take care of musical and speech accompaniment to Mr. Stone's screen shows.

Hugh E. Geyer, of New York City, utilized the space in the attic of his

• Continued on Page 343

8.



9.

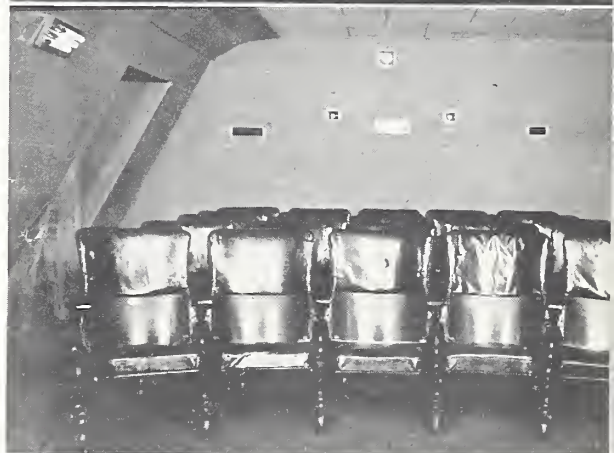

10.

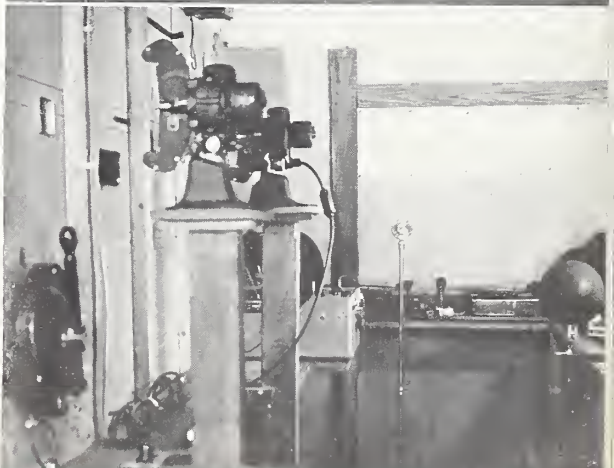

11.

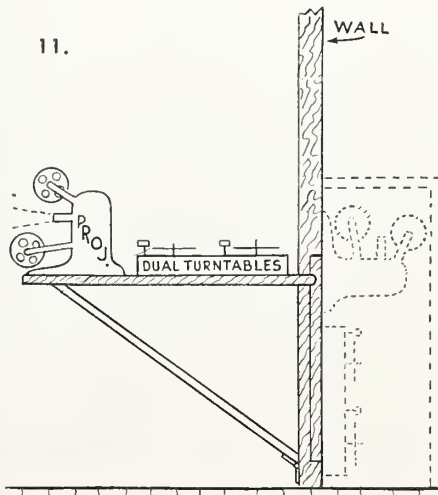

Authored by
 DR. A. K. BAUMGARDNER
 President, Peoria Cinema Club



Dick Whittington

Home movie shows bring cheer to **OLD FOLKS.** . . .

ONE cannot sprinkle the perfume of happiness upon others without spilling a few drops upon himself. This familiar quotation means much to those who have tried it. We enjoy more thoroughly that pleasure which we give, and what better way is there than through our amateur motion picture talents. Since the first article appeared in HOME MOVIES concerning the Shows for Shut-ins, it has been my pleasure to reflect upon the experiences which we in the Peoria Cinema Club had as early as two years ago in contributing to this cause. During one year we presented 48 programs to inmates and residents of institutions and it is my aim in this article to pass along those experiences for the common good of the cause, and invite any other clubs to use any of the suggestions which they care to adopt.

Upon our organization, two years ago, we decided that if we were to become a successful club holding an important place in the civic life of our city, we must contribute something to deserve that distinction. Our first activity as an organization was to contact four institutions through the Civic

• "The reward for the effort of showing these programs is worth far more than the time and trouble involved. The gentle pressure of a warm handshake . . . the pleasant and generous smiles . . . give a greater desire to further the project."

Federation of Women's Clubs who are responsible for entertainment in old people's homes. They were glad to have our help and arranged the dates for us and spoke to the officials in advance for proper facilities to present motion picture programs.

A peculiar situation became quite apparent at the start when we drafted members to present these programs, and worked out decidedly in our favor. There are many amateurs who are more interested in the projection of films than they are in the photographic work, while the reverse is true with other members. For those who are unable to stand the expense of film for photography, there is this opportunity for them to take an active part in the activities of the club work. Practically no expense is involved as far as the individual amateur is concerned in projecting a program.

The first problem to be considered was the program material and we contacted many sources of free film libraries which were available for express charges only. Since these films are returnable by express at one-half the shipping rate, it was rather economical for us to obtain an hour's program and give it two showings before returning it.

One must consider institutional life and some of its aspects when venturing upon an undertaking of this kind, and I shall point out a few of these briefly to illustrate how we were successful in our program without upsetting their routine. Among the residents of old people's homes, the most appreciative audiences are to be found. Quite different from the orphanages where children have many activities and forms of amusement, the elderly people have very little to distract their minds from their plight of ending their days in solitude. Motion pictures are more stimulating to them than any other form of amusement and they eagerly look forward to the evenings when a program is scheduled.

DUE to the necessity of order in institutional life, it is the custom for the residents to retire early. To meet this situation, we arranged for the same program to be presented in two institutions on the same evening. We had a projector, screen and operator stationed in each of the two places and started our first program at 6:30 with three 400 foot reels of 16mm library films. When the first reel was finished it was quickly rewound and hurried by automobile relay to the other institution several miles away where the crowd was assembled and waiting for the show to start. Another member waited for the second reel to be

• Continued on Page 348

Authored by
 ARTHUR H. HART
 Illustrations by Author

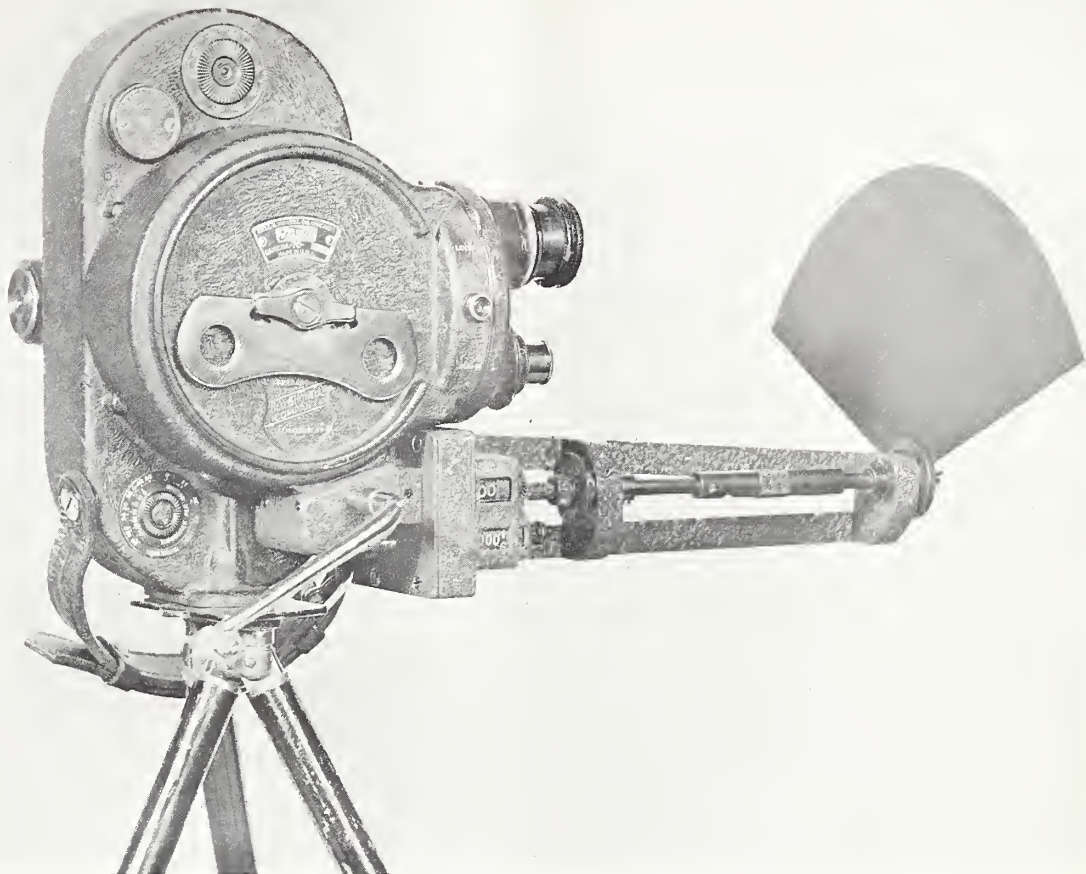

Wind back, fade, dissolve, and wipe off with this GLORIFIED—16 . . . !

AS long as I can remember, it had been my desire to own a cine camera that would produce all—or at least most—of the cinematic effects we see on the theatre screen. At the height of my yearning, an illness set in which cut deeply into my bankroll; so instead of purchasing an expensive camera I had to be content with a little 16mm camera of discontinued make which cost me \$20.00.

But this was far from the camera of my dreams; so an extended procedure of "trading-in" followed and eventually I became the owner of a Filmo Model "70." Many evenings followed which found me working in my shop, taking the camera apart and dissecting its innards in an effort to find simple ways and means for adding to it the special features I yearned for so long.

Probably the most important, was a means for making smooth lap dissolves with a minimum of trouble. At once, this meant the addition of a hand crank, a wind-back feature, and the means for coupling the camera mechanism to an arrangement of gears that would motivate the wipe-off device I had in mind. Necessary, too, would be the addition of footage counters which would keep track of the film in the wipe-off operations.

In due time, my ambitions became a reality. My camera, with the devices added as shown in the illustration on this page, began to take on a "glorified" appearance. More important, the devices were entirely successful.

After the hand crank shaft was extended through the camera case, I found it comparatively easy to couple to it the arrangement of gears encased in the housing shown immediately beneath the lens mounts at the front of the camera. The two Veeder counters shown were purchased in a bicycle shop for a few cents each and these serve the purpose of recording the footage used in the camera and also the footage involved in making a fade or dissolve, or more precisely, the footage involved in any operation controlled by the shaft protruding from it.

The shaft features a sliding coupling so that the wipe-off fan may be disconnected instantly without need of tools. The support which holds the shaft was easily constructed from metal and attached to the gear housing with machine screws.

WITH the completion and installation of the gear box it was discovered that, in order to crank the film backwards, it would be necessary to install some sort of an arrangement whereby the bottom take-up spool shaft would become inactive during this operation. It was found that otherwise, when the film was cranked backwards, the lower shaft turned at full speed and spun the film

• This is not a factory job but a conversion built by an amateur. The effects device is readily detachable and all of the equipment, including the camera, may be carried about in the compact case shown below.



• Continued on Page 350

Authored by
GEORGE W. CUSHMAN



C. E. Bell

So you want to know

HOW TO DO IT!

TWO departments in this magazine, "Information Please" and "Title Troubles," are maintained especially for answering questions from readers. Other departments, such as "The Experimental Workshop," "It's New to Me," and "Backyard Movies," also respond to letters from cinebugs asking for helpful data. All of this service is absolutely free. You do not have to join a club, association, or guild—you do not even have to be a subscriber to HOME MOVIES—in order to receive this free service. Just write a letter describing your problem or setting forth your questions, and the editors will reply, giving the necessary information.

One letter received recently contained 27 questions, and since most of them concerned vital phases of amateur movie making, HOME MOVIES believes that by publishing some of them here together with the answers, other amateurs will be benefited. The questions and answers follow:

Q. Is there any reversal formula which is strictly time and temperature that is better than the inspection method?

A. In this writer's opinion, the beginner at film developing will obtain good results most quickly by employing a good reversal formula by time and temperature. (Several have appeared in HOME MOVIES in the past and more will be found in the book, "How to Reverse Movie Film.") After two or three dozen rolls have been processed, the experience thus gained will permit the worker to tell,

to some degree of accuracy at least, how development is progressing. Development by inspection comes only with experience.

Q. Can panchromatic films be developed by reversal using the same formula, time, etc., and also must they be developed in total darkness?

A. Yes, panchromatic films can be developed by the same formulas as those used for positive emulsions, but the developing time will have to be doubled or even tripled in some cases. It is usually true that the faster the emulsion, the longer the development. It is best to develop all films in total darkness, but if a safelight is used, it should be of a color to which the film is least sensitive. Since panchromatic film is sensitive to all colors, but least sensitive to green, a weak green light may be used, the Wratten Series Filter No. 3 being recommended. Even with this light, it is best not to turn it on until the film is well into the first development, and even then it should be several feet away from the film.

Q. Many writers differ on the type and method of exposing film to the white light for the second exposure. What kind of light should be used, how far from the film should it be, and when and how should it be turned on?

A. Procedures vary on the method of second exposure. Some workers are using chemicals to accomplish this part of the process, but the majority still use light. A 60-watt lamp placed three or four feet away from the film can be turned on (after the film has been placed in the bleach) and left on for the remainder of the process. This seems to be the favored method among most workers.

Q. I want to find a formula that will give identical results each time, so that once the corresponding exposure is determined, I can be assured of the same results each time.

A. Any formula should give the same results each time if it is used the same way each time. Set up your own procedure as to time, temperature, etc., and stick to it with every roll you process. There is no reason why your results should not always be uniform. From this you can determine the correct speed rating of your film when processed in this way, and expect good results from then on.

Q. Are there any prepared developers on the market that are "tops" for first and second development? And can the same solution be used for both the first and second development, or should a fresh, full strength solution be used?

A. Some workers use D-72 diluted 1-1 or 1-2 with satisfactory results. Ready mixed reversal solutions have been advertised from time to time. However, the more favored formulas are not prepared and must be mixed by the amateur. Some formulas are strong enough to be used for the entire process, while others weaken so rapidly that a fresh solution is necessary. It is best to follow the instructions with each formula. Chemicals, it

• Whatever your cine problem may be, you're sure to find the answer in Home Movies magazine, its many departmental services, or in the many books available on the various phases of amateur movie making.

Authored by
WALTER W. LIGHT
Illustrations by Author

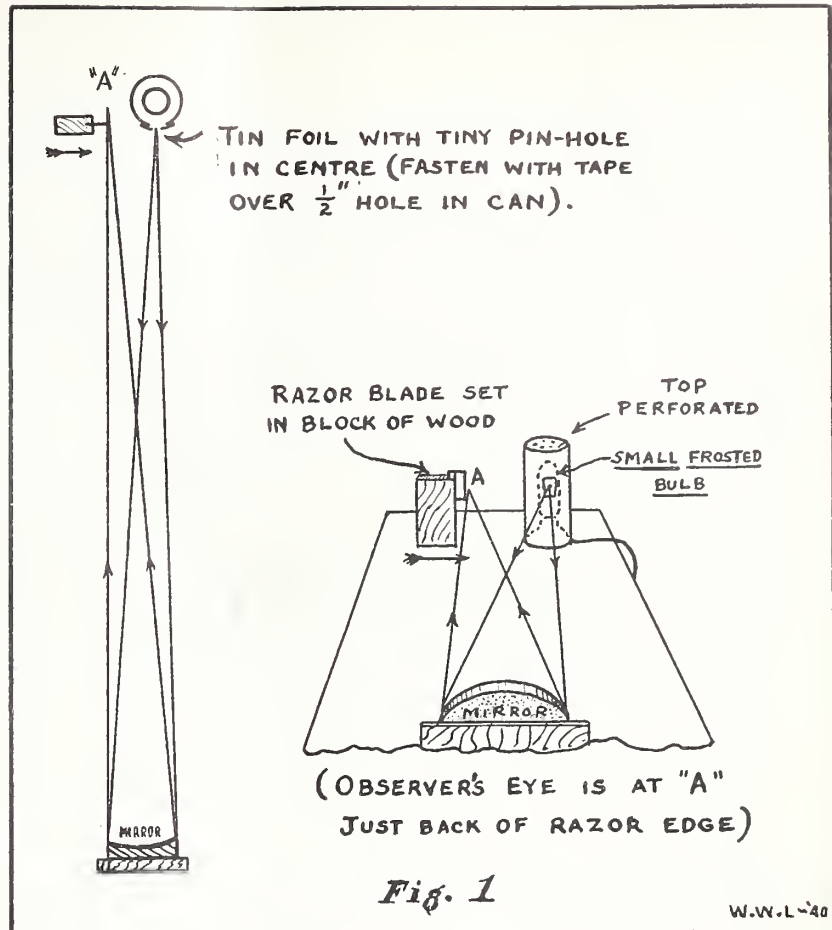

Simple test for homemade TELE-LENS . . .

AT the conclusion of the article in the June issue, which described a method for building an amateur telephoto lens on the principle of the reflecting telescope, we promised this month to describe a homemade apparatus for testing and determining the curve of the concave lens used in the telephoto. With this apparatus, one is able to make the well known Foucault test.

Figure 1 on this page shows the testing apparatus set up. The test should be made in semi-darkness. One eye is placed within an inch or so of the razor blade. The concave mirror—which is the “aluminized” lens from a pair of dime-store spectacles, as described last month—is adjusted so that it reflects the pinhole image back to the observer’s eye at “A.” The mirror should appear filled with light. If it does not, the testing apparatus is not at the proper distance, which must be the radius of curvature of the surface being tested (twice the focal length). Now while observing, slowly move the razor blade sideways toward the lamp and pinhole, so that it partially cuts the reflected cone of light rays. The mirror will seem to darken in places. See Figure 2, which shows some of the many possible curves. If shadows like A and B appear, the razor edge is not at the exact radius of curvature and should be moved a trifle nearer to or farther from the mirror.

It must be remembered that this simple apparatus is, in effect, a two-dimensional microscope with a magnifying power of over 100,000 diameters—hence the need for careful manipulation. All “bumps” or changes in curvature of the mirror’s surface are magnified by that amount. Sketch D represents a deep hollow in the center. E shows the appearance of a hill. H is a bumpy uneven surface, while I, J and K represent a true parabolic surface but with the razor edge at slightly different distances from the mirror. The curve should be smooth in every way. The depth of shading will vary with the F ratio of the mirror. A high speed mirror of f/4 to f/6 ratio shows much contrast between the light and dark parts, while at f/8 or more, the shadows are very faint—when the curve is correct.

SURFACES like F or G show astigmatism and should not be used. H is fairly good. D, E and L are poor. A brilliant ring of light at the left edge means the edge is “turned down,” and should be

• Top: Set-up for making Foucault Test. Sighting on lens from position “A” enables determining flaws and irregularities in lens surface. Below: Illustrations of types of reflections from various lenses. If position of razor edge “A” is changed to left of loup and sighting done from that position, all shadow designs will be viewed in reverse to those illustrated here.

• Continued on Page 349

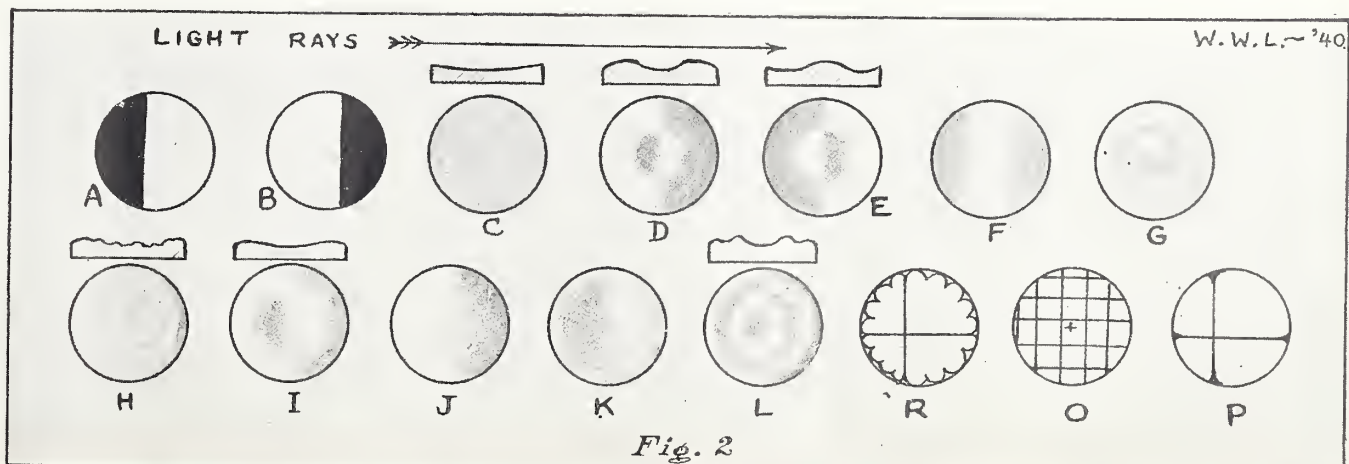
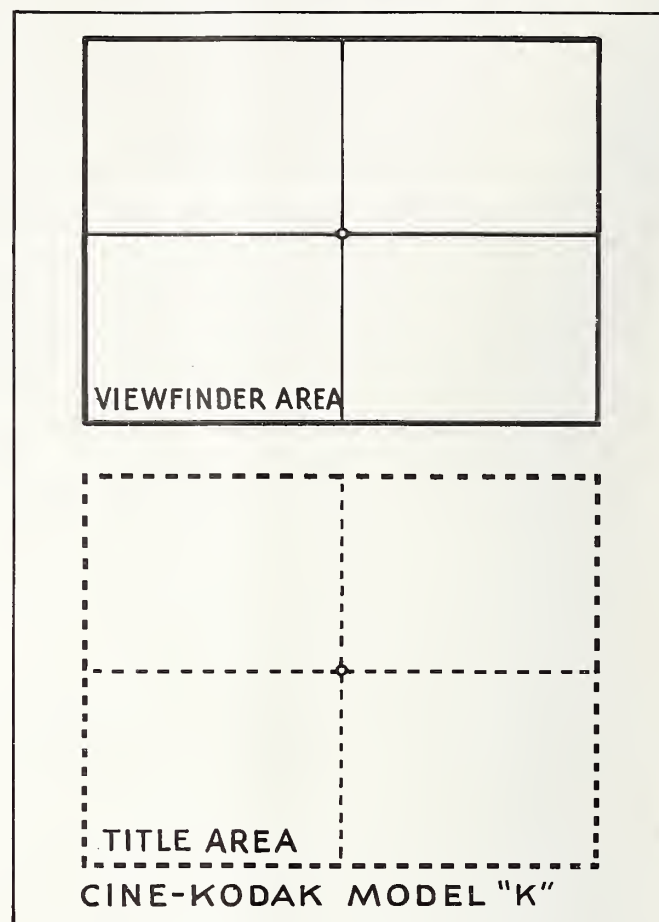
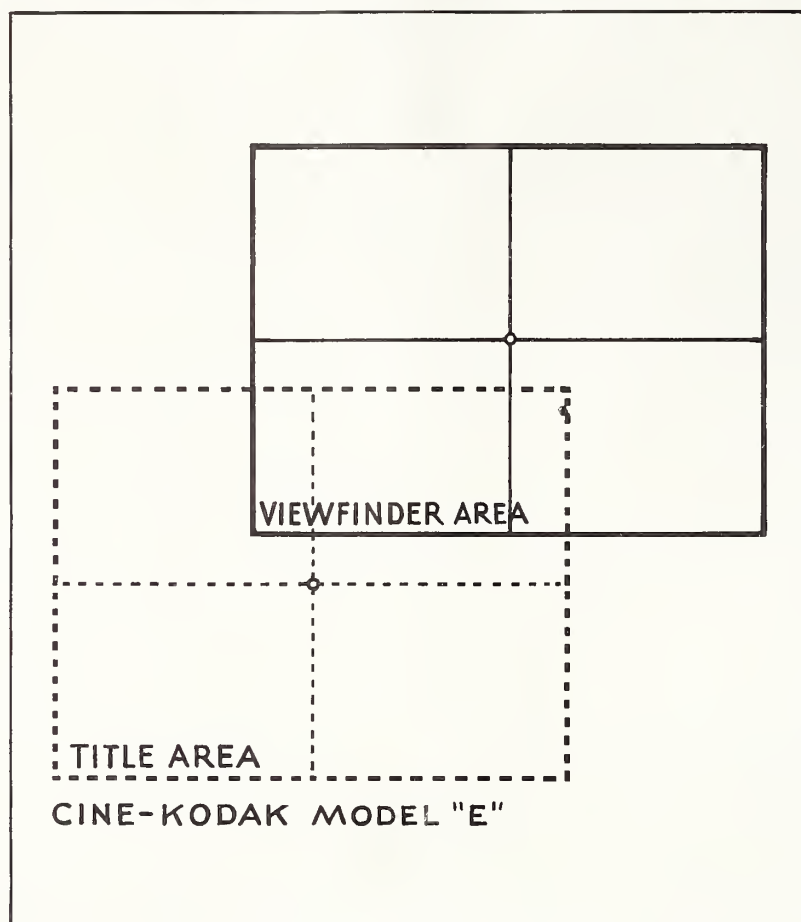

Fig. 2

TITLE CENTERING GUIDES



Last month we printed the first of a series of title centering guides for cine cameras. This month we print the remainder of the Cine Kodak series, and centering guides for other makes of cameras will follow in the next and subsequent issues.

These guides are drawn especially to correspond with size of title backgrounds which appear each month in HOME MOVIES and, of course, are adaptable to typewriter titlers with a focusing distance of 8" or to title making with camera equipped with a 5 diopter auxiliary lens and set up at a distance of 8"

from title card and guide. This has been proven the most accurate method of centering camera lens on title card.

By using these centering guides, the camera viewfinder is trained upon the square designated as the viewfinder area until it is focused squarely upon it. Then the camera is locked in position with full assurance that the lens is truly centered on the square encompassed by the broken lines which represents the title area.

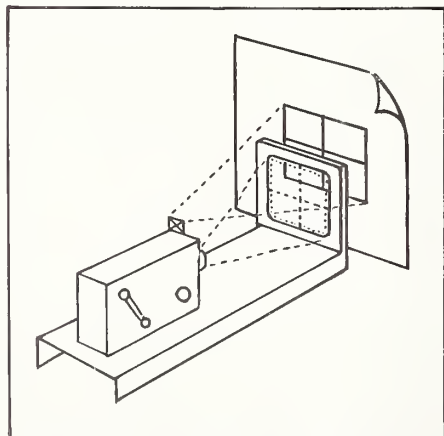

For typewriter titlers, insert guide in card holder, line up title area within opening of card holder. Then, sighting through viewfinder, line up camera with viewfinder area and lock in position.

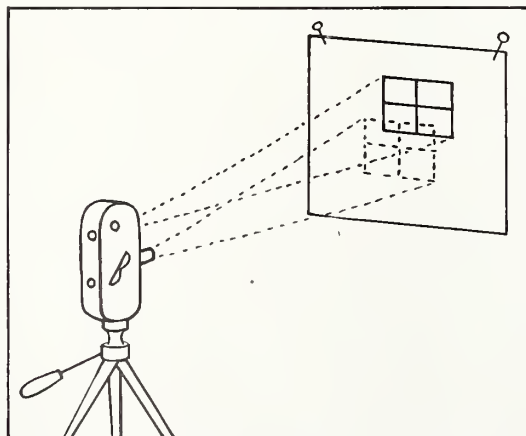

To shoot titles without a titler, place centering guide on wall and, with camera mounted on tripod, line up camera with viewfinder area and lock in place. Title card is placed over "title area."

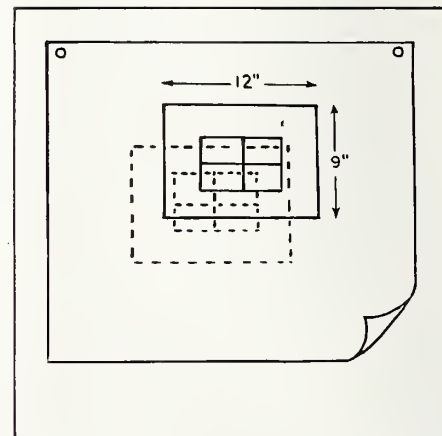

To convert guide for larger title cards, lay guide on a large sheet of paper, as shown, and expand each rectangle to required size, using the "center" point in each square as a basis to work from.

Reviews by
THE EDITORS



TELL ME— how can I improve my film?

AMATEUR filmmakers of home movies are invited to submit their films to the editors of HOME MOVIES for review and helpful criticism. Unless otherwise requested, reviews of films which we believe would benefit other amateurs, will be published each month. Films will be rated one, two, three or four stars, and films qualifying for two or more stars will receive an animated trailer indicating such award. Detailed reviews, with suggestions for improvement—if any—will be mailed to all amateurs submitting films.

When submitting your film for analysis, please advise make of camera, speed of lens, whether or not tripod was used, or if you used filters, exposure meter, or other accessories. While this information is not essential to obtain an analysis of your film, we would like to pass it on for the benefit of other amateurs who are invariably interested in what the other fellow uses in making his pictures.

Following are reviews selected for this month:

"TULIP TIME"

★★★

400 ft. 16mm Kodachrome — By T. D. S.

Continuity: Each year, the city of Holland, Michigan, celebrates its renowned Tulip Festival, an event which draws people from almost every state in the Union. Climaxing the gorgeous display of colorful tulips, are the festivals which begin with scrubbing of the streets by a host of citizens dressed in Dutch costumes. "Tulip Time" is a documentary of this event.

Documentary pictures of this kind are dependent a great deal upon clever titling in order to keep its audience well informed and to explain the rapid change of scenes. This cinefilmer used titles well. At the beginning, he introduced a series of short closeups of automobile license plates on cars from various states, each one filmed from a different angle. Next he introduced the various sections of the city and showed citizens of various ages dressed in Dutch costumes especially for the festival. Because of this special attention while film-

ing, the picture holds interest all the way. Definite continuity was established.

Editing: Notable is the manner in which this picture was edited so that none of the scenes run too long. The contrary is usually the stumbling block for most documentary films. A picture of this type that runs 400 feet must be cut "fast" in order to sustain interest. The locale must be shifted frequently, but with logic. All this has been deftly accomplished by this amateur.

Titling: Titles were composed with pictorial backgrounds of thematic subjects relating to the subject. Apparently most of the illustrations were clipped from seed catalogs and programs of the festival, and they were rather neatly arranged on the title cards.

Photography: Consistently good throughout. Scenes are well exposed and camera steady. Nothing could be suggested to improve this particular phase of the film especially where one must shoot things "on the run," so to speak, in an event of this kind.

Equipment: Cine Kodak with f/1.9 lens; Royal tripod; range finder; exposure meter; and Pola-Screen.

"ALONG FIFTH AVENUE"

★★★

100 ft. 8mm — By E. R.

Continuity: Starting from Washington Square in Metropolitan New York, this film takes us to Central Park with periodical stops affording opportunities to look over some of the sights of the city such as the Empire State Building, Flat Iron Building, and some of the important stores in the shopping district. Also, there are interesting shots of the flow of traffic along Fifth Avenue. We are shown Radio City and the people

● Pictured here are enlargements from 8mm and 16mm films reviewed on this page. Top: A scene from "Tulip Time." Also a scene from "Along Fifth Avenue." Below: A picture of "Sandy" and a pal from the 8mm picture, "Sandy Cat's Tale."



● Continued on Page 353

THE EXPERIMENTAL



Non-skid Tripod Base

A tripod "Y" has been used by the movie industry for years as a means of insuring against slippage of tripod when mounted on a smooth stone or wooden floor, but its possibilities seem to have been overlooked by the cine amateur.

Its construction consists of three strips of wood spaced radially 120° apart around a center block as shown in sketch. Blocks of wood, cut in shape of modified "V," are placed equidistant from the center. The radial pieces are attached to center block by means of

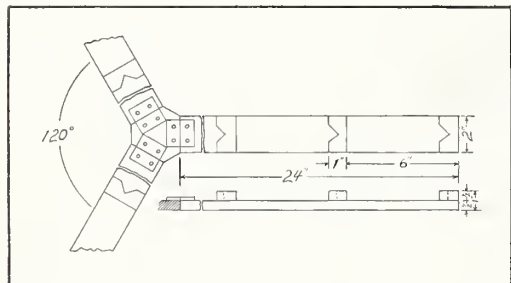

hinges, permitting folding of unit when not in use. Strips of rubber glued to bottoms of radial strips prevent scratching of floors.

In use, the "Y" is placed on the floor and the tripod legs inserted in the "V" blocks.

—Harold C. Martin.

CINEBUGS!

• If you have an idea for a gadget, trick, or shortcut in filming, titling, editing or processing home movies, pass it on to your fellow Cinebugs through these columns. If your idea is published you will receive two reels for your efforts. Extraordinary ideas will net you a roll of film.

Ideas not published will be held for future publication unless they duplicate ideas previously received. Endeavor also to send along photos or rough sketches illustrating your suggestions. There is no limit to number of suggestions you may submit.

Names and addresses of contributors of published ideas are furnished a prominent manufacturer interested in acquiring rights to saleable gadgets on a royalty basis.

Important: When submitting ideas, be sure to mention whether equipment you use is 8mm or 16mm, enabling us to promptly forward awards adaptable to your use.

Footage Gauge

Where a timing device or remote control is not available for starting and stopping your camera from a remote position, the following system will prove helpful, especially where you wish to make a scene with yourself walking into it.

By experimenting with a short strip of film and your empty camera you can determine how many turns of the winding key will operate the motor for a given footage. For instance, with my Bell & Howell 8, 3 1/2 turns of the winding key—that is, 3 1/2 turns after the camera is completely wound down—will expose just 2 feet of film. Allow the camera to run down completely on a previous shot, then wind it as follows for the desired footage:

1 1/2 turns	1 ft. of film
3 1/2 turns	2 ft. of film
5 1/2 turns	3 ft. of film
7 1/2 turns	4 ft. of film
9 1/2 turns	5 ft. of film

These figures are for a B. & H. double eight camera.

—Joe Orr.

Reflectopod

Here is a gadget I have found very useful in making indoor movies. It is a combined camera support and portable lighting unit. The tripod leg may easily be made from a piece of one-inch pine,

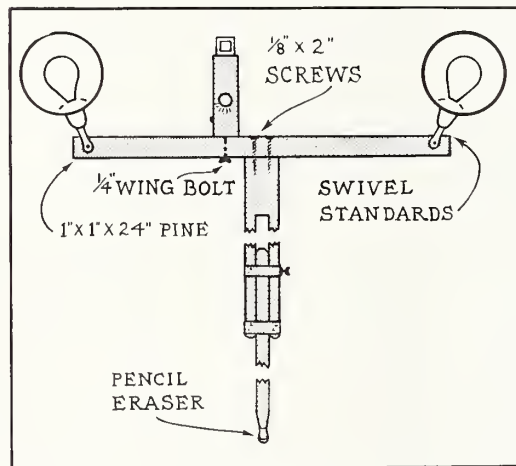

fashioned as shown in the drawing. At the top of this is attached a pine strip 1 x 1 x 24 inches. This is fitted with a quarter-inch bolt to hold the camera. At either end of this cross arm, photoflood lighting units are mounted. Those who do not already have the clamp type reflectors may build reflector units right onto the cross arms. Obtain two lamp sockets—the kind that have the brass "U" such as used on low-priced bridge lamps. The "U" is fastened to the cross arm so that it may be adjusted. Inexpensive reflectors, obtainable at the dime store, complete the Reflectopod.

—K. E. Nordvik.

Projector Case

Inexpensive suitcases obtainable from almost any dime store for about \$1.00 make acceptable carrying cases for home movie projectors. The handle should be removed and refitted at one end to facilitate carrying the case with projector in upright position. Many suitcases are sufficiently roomy to allow for built-in compartments for reels of film which may be made from 1/4" plywood and fitted into the case with glue and small brads. Only those suitcases with light wooden frames are suitable for carrying cases.

—Edith D. Thompson.

Stop Motion

Owners of early Keystone "8" cameras can obtain consistently even single frame exposure by the following method: Allow the motor to run down completely, then rewind one and one-half turns. This puts just enough pressure on the spring to permit flicking the starting button and getting a single frame exposure with exposure speed cut in half.

—Howard E. Foote.

Lens Caps

Small rubber bottle caps, such as are sold for sanitary capping of infants' feeding bottles make excellent lens caps for lenses 5/8" or larger in diameter. These caps are available from 5 and 10 cent stores.

—Peter Marra.

Substitute For Felt

Those who make their own sunshades, filter holders, or other gadgets that attach to the lens barrel, find need for use of felt to line these gadgets to prevent abrasion to lens or camera. Recently I was unable to purchase felt locally but at the "dime" store found a far superior substitute. On the counter devoted to "foot comfort" materials was found an adhesive strip called "moleskin"—soft on one side and with adhesive on the other. It adheres firmly and easily cut.

—Irving Vics.

Screen Tripod Mount

Here is a simple trick for owners of box screens who wish to use their tripods as a screen stand or support. I drilled three holes in a two-inch length of half-inch scrap iron and tapped out the center hole to fit the stud of a tri-

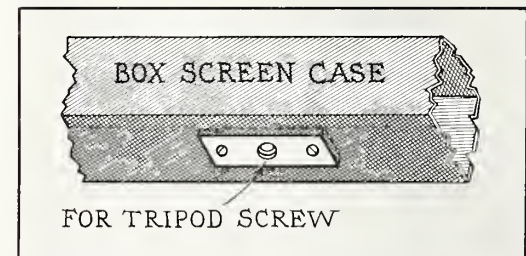

pod. The two outside holes were then counter-sunk for flat-head wood screws and the plate mortised into bottom of

C I N E W O R K S H O P

the screen case, as shown. By screwing the tripod head tightly against the plate, the screen is held rigid and height of screen may be regulated by adjusting tripod legs.

— P. F. Nelson.

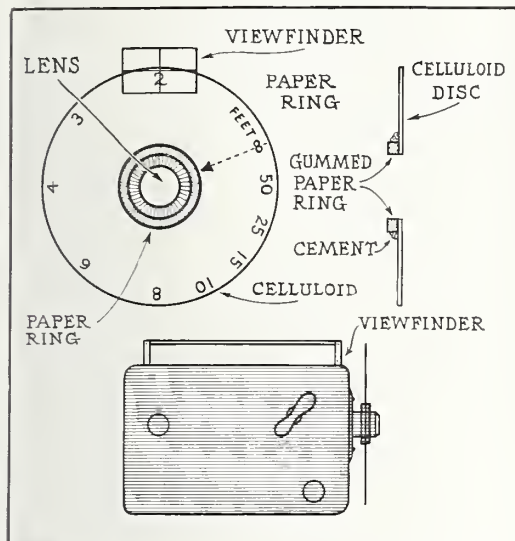

Focus Indicator

In using a camera with focusing type lens, and particularly when working at wide apertures, it is often desirable to change the focus of the lens as action approaches or leaves the camera. When camera is hand held, it is quite impossible to hold the camera, operate release button, and change the lens focusing ring without taking one's eye away from the viewfinder.

To make it a little easier to handle all this at once, I recently made an indicator that would show the focus setting in the viewfinder. A strip of gummed kraft tape one-eighth inch wide and about four feet long was moistened and wrapped around the focusing ring of my camera lens. When the wrapping was completed, there was formed a paper ring one-eighth inch wide and one-quarter inch thick, which was easily removed after drying. To the side of this ring I cemented a transparent celluloid disc with a radius equal to the distance from the center of the lens to the outside edge of the camera viewfinder. The center of the disc was cut out to permit lens to extend through it. Next, footage numbers, corresponding to those engraved on the lens, were inked in near edge of the disc and on the side facing camera viewfinder. Thus, while sighting through the viewfinder, the focus setting of lens may be observed; and where it is desired to change focus while shooting, the disc may be rotated until the desired footage mark appears in the viewfinder.

— Edwin D. Taylor.

New Toning Idea

Recently while watching an itinerant sidewalk photographer turn out some sepia toned snapshots, I discovered a

method for toning my cine films a pleasing sepia color. It involves washing the film in a solution of potassium sulphide. Sodium sulphide or ammonium sulphide will produce similar results. The strength of the solution is not so important. I used about a tablespoonful of the dry chemical to 32 ounces of water.

If you process your own film, just follow the regular reversal procedure up to the time of flashing. Then, instead of using a second developer, subject the film to the sulphide bath. Be sure to leave the film in the solution until all the white on the base side is darkened. This may take about 15 minutes or longer, depending upon strength of the solution.

Now, for those who wish to tone films by this method which are already fully processed, it is first necessary to completely wash away any remaining hypo with a solution composed as follows:

1 oz. potassium ferricyanide.

1 oz. potassium bromide.

32 oz. water.

Wash film thoroughly for fifteen minutes in this solution and then in clear running water before subjecting it to the sulphide toning bath.

— Glen Berwick.

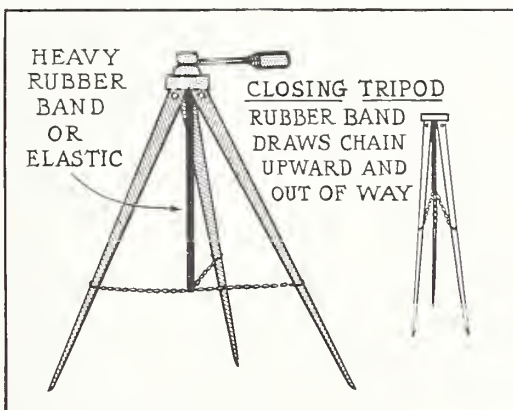

Chain Retractor

For those new type tripods with chains to check spreading of legs, here is an improvement designed to automatically retract the chains, keeping them from dangling and becoming tangled. Obtain a section of strand rubber such as is used for powering model airplanes. Fasten one end to the point where the three chains converge and the other to the tripod screw handle or top of tripod. As the tripod is folded, the rubber draws the chains up and out of the way.

— W. D. Garlock.

Auxiliary Lens Holder

A satisfactory auxiliary lens holder for cine camera lenses may be made with a piece of brass tubing, pair of tin snips, and a piece of adhesive tape. The tubing should be of light gauge and slightly smaller than diameter of lens mount. First slit the tubing and turn back edges about one-eighth of an inch.

gadgets, tricks and short cuts contributed by Cinebugs

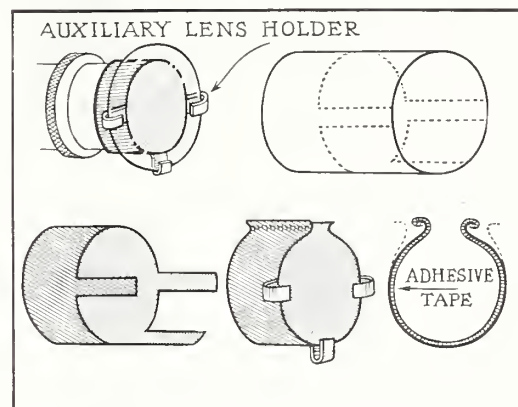

Next cut away sections of tubing as shown in sketch, leaving three prongs. These are bent in "U" shape, as shown, and act as retainers for holding the auxiliary lens. A strip of adhesive tape placed on the inside of tubing and folded over the turned edges prevents scratching of camera lens. The spring tension inherent in brass tubing will provide for snapping on lens holder over camera lens and holding it securely in place.

— W. F. Patrick.

Rewind Brake

A simple method of adding an effective brake to any rewind is shown in the accompanying photo. A piece of ordinary shoelace is looped over the rewind spindle and then spliced to a stout rubber band which is fastened to the workbench or editing board by means of a small hook as shown. Where increased braking surface is desired, use a piece of leather instead of the shoelace. Regulating tension of the rubber band will also affect braking results.

— W. O. Bell, M. D.



"IT'S NEW TO ME"

By CINEBUG SHOPPER

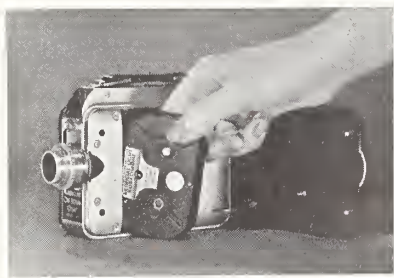

Magazine Eight

Champion of 8-millimeter home movie cameras is a new magazine-loading Cine-Kodak Eight, announced by the Eastman Kodak Company, Rochester.

The new Magazine Cine-Kodak Eight has all the features normally expected in a de luxe home movie camera of the larger 16-mm. size, plus a compactness and styling all its own. Smooth contours, metal parts in brush finish chromium and genuine black cowhide cover set it off at first glance.

Its features include: Three-second loading, with compact magazines, black-and-white or Kodachrome, that can be interchanged without loss of film. Each magazine carries a small indicator scale, on which to record what footage remains unused.

Additional features are, six interchangeable lenses; four filming speeds, 16 to 64 F.P.S.; clever masking finder; indicators and pulse button; choice of all filters and two fine carrying cases.



Victor Speaker Case

Of interest to the educational and industrial field in the showing of sub-standard films is the newly introduced Victor Two Speaker Unit, in one case under one handle. This arrangement permits use

of two speakers when they are required and has obvious portability advantages.

New engineering developments in Victor Animatophone units are also announced. The Model 40-A amplifier output has been doubled and Model 40-B has been increased 50 per cent. Both models have separate mike controls built in.



Lutrix Meter

Some photographers, when using an exposure meter, like to read combinations of exposure time and F:stop; others prefer to decide upon the shutter speed beforehand and only want to read the required lens opening. Lutrix exposure meter can be used with equal convenience for both reading methods. The standard computer with which the meter is equipped permits to read all usable combinations of exposure time and lens opening. An additional computer is furnished with the meter and can be fastened easily in place of the other one as illustrated here. When converted in this way, the exposure meter lends itself to pre-setting of the desired exposure time and indicates F:

stop directly. With the pre-setting computer, the meter is especially suited for cine camera work, no re-setting of the scales being required from one shot to the next.

Open House

Jacob Stein, manufacturer of the "A to Z" Home Movie Titling Outfits and Figuerettes, invite all movie makers to visit their pent-house studios atop the Flatiron Building, 175 Fifth Avenue, New York City, when visiting the New York's World Fair.

One of their staff will gladly demonstrate the easy "A to Z" way to title movies, and visitors will receive, free, a "Try It Yourself Kit." Another special offer to Fair visitors is free postage of the complete outfit to one's home, eliminating the necessity to carry packages while in the city.

Filmo Dual Sound

Bell & Howell recently announced they are offering a Dual Installation on Filmo-

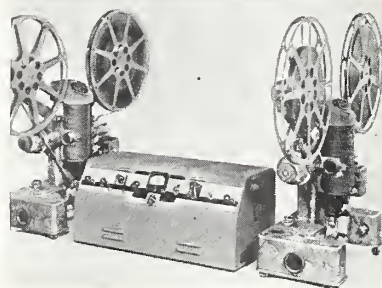

sound for their "Auditorium" Projector.

The automatic change-over, as illustrated here, permits the uninterrupted showing of 16mm film programs of any length.

Nuart Films

Nu-Art Films, Inc., announce the acquisition of exclusive 16mm rights to a series of two-reel sound comedies with stars of major importance. The first of these, *A Quiet Fourth*, featuring Betty Grable, was made available on June 1. Additional titles are

being released at two-week intervals.

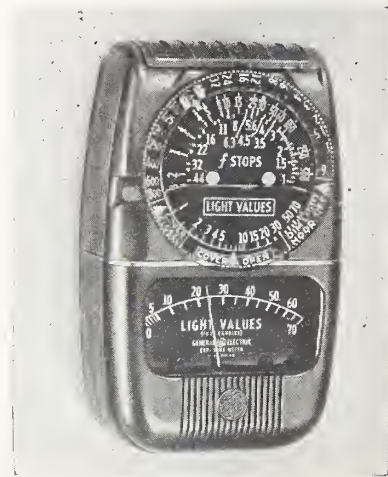

New G-E Meter

General Electric has introduced a new exposure meter—Type DW-48.

Many of the meter's new features are intended to simplify use of the device. It boasts a sure one-handed operation. This is reputedly made possible by special calculator arrangement, the spring-actuated cover, new locking device and the streamlining of the case.

Film Clips

The Leo Enterprises, St. Louis, Mo., are marketing an ingenious device for keeping spooled film from unravelling. It resembles a round wire paper clip, snaps over the edge of the reel and holds the film by means of a hook which extends down on the inside of the reel. Cost of Leo Film Clips is exceptionally low.

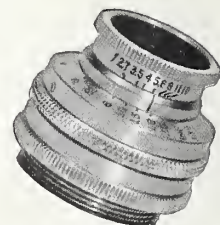

New Lens

Wollensak Optical Company announces for the movie ma-

ker who wants critical focusing a 15mm focus f/2.7 Cine Velostigmat Wide Angle lens in precision micrometer focusing mount. This new micrometer focusing can be set from 1 foot to infinity. Designed especially for 16mm cameras, this special lens can be used on the turret model cameras without interfering with the camera or without injury to lens.

Graphic-Reel

Superior Bulk Film Company, 188 West Randolph Street, Chicago, have introduced the Graphic-Reel, a complete home processing outfit for bulk movie film, including a drying rack, free booklet on home processing, special formulae. With this outfit, the cost of home movies is brought down to little more than that for still pictures.

Also, according to this manufacturer, the reversal of a roll of movie film is now said to become actually easier than to develop a roll of still film. The Graphic-Reel is so designed that even the newest amateur

can successfully process his own film the very first time he tries. The entire outfit comes completely set up and ready to use, and can be stored in a space no larger than 18 inches square. Using a standard 8x10-inch developing tray, only 1 quart of solution is required, or 2 quarts if a 10x12 tray is used. The reel holds 32 feet of 16mm or double 8mm film.

Fidelitone

Increasing interest on the part of amateurs in adding sound to home movies has increased demand for Fidelitone dual-turntable units, according to George K. Culbertson, manufacturer, Minneapolis. Fidelitone is a highly perfected portable sound unit that is as simple to operate as a radio, according to the makers. Outfit includes two turntables powered by strong constant speed motors, an efficient amplifying system, loudspeaker, and microphone—all encased in a sturdy carrying case no larger than a suitcase.

Make way for Home Movies

• Continued from Page 333

home to build a very attractive private theatre, pictured in Figs. 8, 9, and 10. According to Mr. Geyer, he designed, built and wired the theatre himself. Over 3000 square feet of celotex were used. A special heavy duty cable was installed to furnish power for projector, sound system and lights. Twenty-five theatre seats were purchased from a dealer in second-hand theatre equipment for 75 cents each.

In the projection booth is a very complete assembly of equipment—including two projectors, dual turntables, a complete Presto recording unit, and a dimming switch for proscenium and house lights. The projection booth also serves as a cine workshop. Among the extensive equipment for editing and titling home movies, is a Besbee Titler complete with all devices for trick effects.

Still other cine enthusiasts have provided for showing home movies in

their living room, den, or dining room with a minimum of preparation and confusion by the permanent installation of a screen in a convenient location within the house. In the home of David A. Smart at Glenview, Illinois, a large D-lite "Electrol" screen has been installed just above one of the spacious dining room windows, as pictured in Fig. 7. At the touch of a button, Mr. Smart can lower his screen for a showing of home movies, and by the same control, cause it to roll up and entirely disappear from view behind the panel which extends along the top of the walls of the room.

Where new homes are already under construction, there may yet be time to make the necessary alterations to include some of the innovations suggested here. But if building plans are still in the "dream" stage, now is the time to pencil in those added features that will make movie making and screening a pleasure.

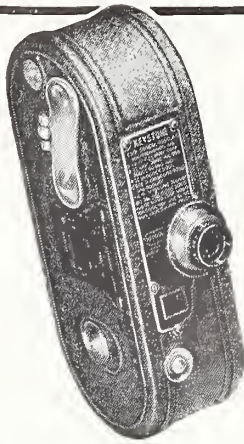

MODEL K-8

3 speeds . . . lens interchangeability . . . audible and visual footage indicator . . . uses either single or double-8 film.

\$26⁵⁰

With f/3.5 Lens

WINS CONTEST WITH KEYSTONE K-8

Here is still further proof of the precision construction and picture-taking ability of the inexpensive, pocket-size Keystone 8mm movie camera. Read what a contest winner says:

KEYSTONE MFG. CO.
Boston, Mass.
Gentlemen:
I was very surprised and pleased to find that my vacation film, "New England Holiday", was selected as one of the 12 best movies of the year by Home Movies Magazine.
Naturally I am proud of the honor, but I also realize that without proper equipment I would not have had the success I enjoyed. Friends marvel at the clearness and depth of the 8mm Kodachrome scenes, and are frankly astounded to learn that they were made with an inexpensive camera, the Keystone K-8, with a modest f/3.5 lens.
Sincerely yours
(signed) Albert F. Watts
89 Narragansett Rd., Buffalo, N. Y.

KEYSTONE MFG. CO.
288 A ST., BOSTON, MASS.

WHY MISS A SINGLE COPY?

Let HOME MOVIES come to you every month regularly by mail. Missing just one good idea may cost you more than the price of a year's subscription—\$2.00. Mail it today!

HOME MOVIES, 6060 Sunset Blvd., Hollywood, Calif.

COAST TO COAST PROCESSING SERVICE

NOW AVAILABLE TO USERS OF **SOLAR MOVIE FILM**

Now you can buy LOW COST FILM and save money without sacrificing that important advantage of QUICK PROCESSING SERVICE. Simply ask your dealer for SOLAR MOVIE FILM, take your pictures, and then send your film to the SOLAR processing station nearest you, per list enclosed with each roll. One of these processing stations is less than 24 hours from 90% of all movie camera fans in the U. S. Films are returned to you postpaid after only 1 day in our laboratory. If more convenient, order film from this ad and mention your dealer's name.

	Weston Rating	16mm 100 ft.	16mm 50 ft.	8mm 25 ft.	Dbl.
Solar ECONOMY Outdoor	8	\$2.50	\$1.75	\$1.00	
Solar SUPER Outdoor	12	2.95	1.95	\$1.39	
Solar HI-SPEED	24	5.50	3.25	2.00	

Prices include processing at any Solar Laboratory and return. Sold by over 300 leading dealers in 49 cities. Descriptive circular FREE upon request.

Dealers Wanted Write Quick

Solar Cine Products Inc.
3827 Archer Ave. Dept. 1A
Chicago, Illinois



SOLAR Movie FILM

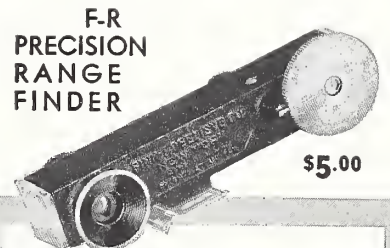

\$5.00

**DON'T GUESS—BE SURE!
GET FINER RESULTS**

For as little as \$6.00 the combined price of the F-R Precision Range Finder and the F-R Exposure Meter—you can provide yourself with the essential tools for eliminating the element of guess work from focusing and exposure problems. The F-R name—symbol of photography's truest value—unequivocally guarantees the dependability of these instruments.

\$1.00



F-R EXPOSURE METER

FINK-ROSELIEVE CO. Inc.
NEW YORK • CHICAGO • LOS ANGELES

THE Bolexmeter

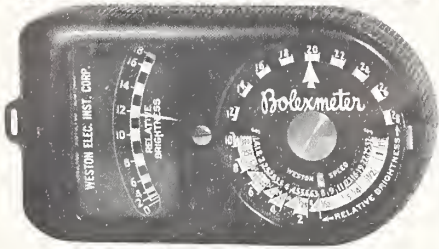

DOUBLE-DUTY DIAL GIVES QUICK READINGS FOR BOTH CINE AND STILL CAMERAS

THE NEW BOLEXMETER is the proved Weston "Master" exposure meter especially produced for the AMERICAN BOLEX CO. It has all the features of the famous "Master" plus the efficient, two-color, double purpose dial which was designed for use with BOLEX and all other cine cameras. Diaphragm stops in relation to cine camera speeds of 8 to 64 frames per sec. can be read directly. Dial also includes all shutter speeds and stops for still cameras.

See your dealer or order direct . . \$24

Bool CINE-FADER

PUTS 64 VARIETIES OF FADES & DISSOLVES

at your finger tips

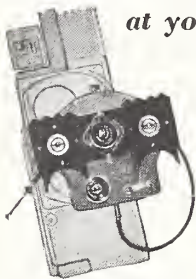

The handy Bool times and automatically makes by clockwork mechanism, all kinds of tricky effects "as you go." When operating there is no need to remove the eye from viewfinder. Bool also serves as filter holder.

FITS MOST EVERY MOVIE CAMERA AND PROJECTOR

Complete with extension tube, cable release, and instructions for operation..... \$17.50

Cinea FILM CEMENT

The only cement that is good for all kinds of film—acetate or nitrate—35 mm, 16 mm, or 8 mm. Cinea Cement is odorless, does not bleach color, is slow to evaporate from uncorked bottle yet joins film quickly and strongly. Bottle..... 25c

CINELAC PROTECTS YOUR FILM

against SCRATCHES, FINGER MARKS, CURL AND BRITTLINESS



CINELAC permeates and toughens the emulsion—seals in moisture—prevents excessive aging—protects negatives and cine film. No apparatus needed—easy to apply. 2 oz. bottle \$1.00

See your dealer or order direct from—

AMERICAN BOLEX COMPANY
155 EAST 44th ST. • NEW YORK, N. Y.

Coating lens increases speed

• Continued from Page 325

this phenomenon in 1935. In 1936, he described a process of evaporation and recondensation in a high vacuum of certain metallic fluorides to produce an effect similar to those produced with the fatty acid and chemical etching processes, but which would be independent of the chemical nature of the surface upon which it was to be applied and which could be removed when desired, leaving the glass in its original condition.

This process depends on the deposition of a very thin film of optical substance on the surfaces of the lens elements being treated. Dr. Strong made great progress with the process and the actual results with treated lenses is astonishing. Others, including Cartwright and Turner, have done much work with this process.

Treated lenses show many improvements. As a result of reducing the reflections and increasing the light transmission, there is an increase in photographic speed, resolving power and brilliance, together with greater contrast and better image quality.

In camera lenses, much of the light lost by reflection on the inner elements is re-reflected, finally finding its way to the film, not as useful light, but as flare and stray light. Too, light from other less intense sources reflects inside the lens in an identical manner, resulting in a large amount of light bouncing around inside the lens, finally reaching the film, not as detectable flares, but as a general veil of diffuse

light, which produces a general fog over the entire picture. Treated lenses reduce the amount of reflection on the inner surfaces, thus the intensity of the flares and the diffuse light and resulting fog is greatly diminished.

Low key shots show the improvement obtained with treated lenses to a high degree. Treated projection lenses show increased picture quality as well as 15 per cent to 40 per cent increase in screen illumination, depending upon the type and construction of the lenses.

Camera lenses have been shown as high as 36 per cent increase in light transmission, although the percentage of increase depends on the number of air-glass surfaces involved in the lens.

The treatment is equally effective on lenses used for color photography, as the treatment has only minute effect upon the color transmission of the lens and none upon the color correction. Due to the ultra-microscopic thinness of the deposited surface, the treatment has no effect upon the optical correction of a lens.

The treatment is not limited to new lenses, but can be applied to existing lens systems. This work is now available commercially.

The results being obtained by major motion picture studios and others would indicate that treated lenses mark a revolutionary milestone in the search for means of increasing the amount of light transmission in optical systems.

DUPONT REGULAR PAN

RICHMOND ROSS



On the Verge of Something Big

Discovering Regular Pan piles one surprise on top of another. When you buy a roll, you'll like the economical price. The speed is just right for outdoor movies. Bright scenes take f:16, your smallest opening. The panchromatic color response lets you use any type of filter.

Viewing movies on Regular Pan is another surprise. The wide latitude saves scenes that have been over or under exposed. An improved non-halation coat sharpens the detail. The complete removal of it in processing gives your pictures real sparkle and brilliance. Try Du Pont 16mm Regular Pan which "puts sunshine in your movies". Leading camera stores handle it—list price, \$4.50 for 100 feet.

Du Pont Film Manufacturing Corp., Inc.
9 Rockefeller Plaza New York, N. Y.



Puts Sunshine in Your Movies

CHART OF TITLING EXPOSURES
AT SIXTEEN FRAMES PER SECOND

FILM SPEED (Weston Mazda):	16	8	6	5
One No. 1 Photoflood in Reflector 9 inch from Title Board	F/10	F/7	F/6.3	F/5.6
Two No. 1 Photofloods in Reflectors 12 inch from Title Board	F/11	F/8	F/7.0	F/6.3
Two No. 1 Photofloods in Reflectors 15 inch from Title Board	F/ 9.0	F6/3	F/5.6	F/5
Two No. 1 Photofloods in Reflectors 18 inch from Title Board	F/ 8.0	F/5.6	F/5.0	F/4.5

Data based on exposure of 1/30th second.

Next Sunday's shooting script

• Continued from Page 329

Scene 27: Closeup of pan in Tom's hands with gold nugget glittering prominently among bits of wet gravel. Fingers enter scene and pick up nugget.

Scene 28: Back to scene 26. Tom looks up excitedly toward Dick and speaks:

TITLE: "Yipee! Look here!"

Scene 29: Medium shot of Dick lolling beside stream. At sound of Tom's words, he jumps up and rushes toward camera. Cut to—

Scene 30: Medium shot as Dick enters scene and examines nugget. Jubilantly they throw down their tools and rush up side of the bank and out of scene.

Scene 31: Tom and Dick rush excitedly toward camera, in direction of picnic group and out of scene. Underbrush near stream in immediate background.

Scene 32: Picnic grounds. Tom's and Dick's companions are lolling about, chatting, playing cards, etc. As Tom and Dick rush into scene jabbering excitedly about their discovery, all look up toward them, and several companions rise to their feet and gather about the two men to examine the nugget.

Scene 33: Closeup of Tom and Dick out of breath and surrounded by companions. Tom displays the nugget and speaks:

TITLE: "We've found gold—real gold!"

Scene 34: Back to scene 33 as Tom finishes speaking.

Scenes 35, 36, 37, 38 and 39: A series of flash-closeups of individual faces as they look on in amazement and say, "Gold!" (Use a different camera angle on each, preferably from a low position.)

Scene 40: Medium shot of Tom and Dick surrounded by excited companions. The two men walk hurriedly away and out of scene, as companions look after them in amazement and talk excitedly about the nugget.

Scene 41: Same as scene 14. Tom and Dick enter the scene, get into Tom's car and drive out of the scene. Fade-out.

Scene 42: Fade-in. Medium long shot. Curve in road. Tom and Dick in car round curve dangerously on two wheels as they speed on toward town. Fade-out.

Scene 43: Fade-in. Medium long shot exterior of assayer's office. Tom and Dick enter scene in car, stop, get out of car, and walk out of scene toward entrance of office.

Scene 44: Medium shot, exterior of assayer's office. Entrance in immediate background. Sign, "Assayer's Office" on door. Tom and Dick enter scene and proceed into office. Fade-out.

Scene 45: Fade-in. Tight closeup of assayer's face, with camera at low angle. He adjusts jeweler's inspection glass to his eye and closely studies gold nugget held in his fingers. After a moment he lifts glass from eye, looks toward Tom and Dick, out of scene; and speaks:

TITLE: "Yes, it's gold, all right—"

Scene 46: Short flashback to scene 45 as assayer finishes speaking. Cut to—

Scene 47: Closeup of Tom and Dick (heads and shoulders) as they hear assayer's words. They break into a loud whoop, throw arms about one another and begin to dance. Cut to—

Scene 48: Short flashback to scene 46. Assayer continues speaking:

TITLE: "—gold out of somebody's tooth!"

Scene 49: Short flashback to scene 48 as assayer finishes speaking and offers nugget back to Tom, out of scene.

Scene 50: Tom and Dick stop dancing abruptly as they hear assayer's words. Their expressions suddenly change to disappointment. Both look pathetically toward assayer, out of scene. "Gold out of a tooth!" says Tom. Slowly he removes toothpick from lips, then thrusts finger into mouth and feels of molars.

Scene 51: Closeup of Dick as he looks perplexed at Tom.

Scene 52: Back to scene 50. Tom withdraws finger

FOR YOUR "Stills"

BLACK AND WHITE • FULL COLOR

KODAK BANTAM (f/4.5)



• When you buy a "still" camera with which to supplement your home movie making, you want a compact camera of versatility—at a moderate price.

Kodak Bantam (f/4.5) is just that. It's palm size, easy to carry, simple to use. It gets fast-action shots, rainy day snaps, close-ups, indoor snapshots under Photofloods, and gorgeous Kodachrome full-color transparencies—all with equal ease. Costs but \$22.50.

SEE KODAK BANTAM (f/4.5) AT YOUR DEALER'S

Equipped with Kodak Anastigmat Special f/4.5 lens and accurate 1/200-second shutter. Has folding optical eye-level finder and convenient body shutter release. Modern photofinishing methods lead to black-and-white prints 2 3/4 x 4 inches. Ask your dealer to show you the Kodak Bantam (f/4.5).

Only Eastman Makes the Kodak

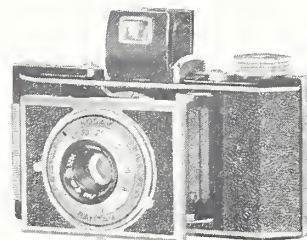

EASTMAN KODAK COMPANY, ROCHESTER, N. Y.

Filmo
Movie Equipment
Does Not Limit
Your Skill!

FILMO movie equipment imposes no restrictions upon your skill. The more advanced you become, the better the basically complete Filmo serves you. There are no limits to quality or variety of movies it lets you make. That's why Filmo owners are satisfied owners.

Make your next movie purchase a Filmo. Write today for free literature describing cameras, 8 mm., 16 mm., or 35 mm.; projectors, sound or silent; or any particular accessory in which you are interested. Most literature is in interesting, illustrated booklet form. Write for information today. Bell & Howell Company, 1825 Larchmont Ave., Chicago; New York; Hollywood; London. Since 1907 the largest manufacturer of precision equipment for motion picture studios of Hollywood and the world.

PRECISION-MADE BY

BELL & HOWELL



CRITICAL FOCUSING
IN A WIDE ANGLE LENS
FOR 16 MM CAMERAS

HERE'S the movie lens you've longed for... precise micrometer focus from 1 foot to infinity. Wide angle of view for confined space shots, interior shots, panoraming. 15mm focus, f2.7 speed, correction for good color and black and white movies under moderate lighting. For 16mm cameras (including turret). Economical, too. You'll need one this summer. Get it now.

WRITE
FOR
LITERATURE

Wollensak Optical Co., 509 Hudson Ave., Rochester, N. Y.

WOLLENSAK

The Next Time USE CONSUMERS' and you are sure of Good Pictures

Comero Hints and Full Photographic Information With Each Film



Fully Guaranteed . . .
As to Speed Rating
Excellent Quality
Fast Processing

Which Assures Satisfaction
to the Consumer

Complete Modern Mochine Processing
1,000,000 Feet Per Week Copocity
Under Expert Croftsmon Supervision

CONSUMERS' CAMERA FILMS Are Popular Priced

	16mm	100 ft.	50 ft.
Consumers' Ortho (18 Scheiners & Weston Daylight 8)		\$3.00	\$2.00
Consumers' Panchro (23 Scheiners, Weston Daylight 24, Tungsten 16)	5.00		3.00
Consumers' Colorcrome (18 Scheiner, Weston Daylight 8)	6.00		3.00

A Coloritone Process (Not a Natural Color)

DEALERS EVERYWHERE

Mail Orders Filled Promptly



Executive Offices
No. 1 PARK AVE., NEW YORK CITY

Orders and Inquiries Filled
Direct from Plant

RIDGEFIELD PARK, N. J.

slowly from mouth as he stares thoughtfully toward floor. Cut to—

Scene 53: Repeat of scene 19. (The mystery begins to unfold for Tom, as he remembers picking teeth, washing mouth, and spitting water into creek. It was here he lost the gold filling.)

Scene 54: Closeup. Water which Tom spits out, striking surface of creek at shallow spot, and with it the gold filling. Filling falls in comparatively shallow water so that it is readily visible.

Scene 55: Back to scene 52. Tom reaches out of scene toward assayer for the filling.

Scene 56: Tight closeup of Tom's hand taking gold filling from hand of assayer.

Scene 57: Same as scene 44. Tom, with Dick following, dejectedly exit from door of assayer's office, and walk slowly out of scene toward their car. Fade-out.

TITLE: The End.

As the gold "nugget" figures prominently in close-ups throughout the story, it is important that this bit of "property" be designed with considerable care. It may be fashioned from soft lead, wax, or any plastic mate-

rial, and should be equivalent in size and design to a good-sized gold filling. A coat of gold paint will give it the necessary glitter.

It is well to again emphasize the importance of another little "prop"—the toothpick. Be sure that Tom has one in his mouth in every scene in which he appears and that he uses it occasionally to pick at his teeth or to shift it about in his mouth vigorously. Make the toothpick evident at all times, as this "prop" is the medium which conveys how the loss of the gold filling occurred.

To those who may anticipate trouble in finding a suitable locale for the "Assayer's Office," the following suggestions are offered: The exterior of any small-town wooden store building could be used, and the sign, "Assayer's Office" could be painted on a cardboard panel and temporarily tacked on the door. On the other hand, with such a location unavailable, it is suggested that a jeweler's store be substituted. It is understandable that a jeweler would be qualified to pass judgment on a gold nugget.

The script from scenes 45 to 56 inclusive is especially written to eliminate neces-

We have a customer who
wants to buy

16mm KODACHROME

footage of unusual shots and scenes of general interest to rest of the world. Send films to us for preview by our customer. Accompany film with complete written description of subject. Photography must be good and film free from scratches. If interested, customer offers 25c a foot up, depending on subject value and interest.

Address

DEPT. "H"

EASTMAN KODAK STORES
643 South Hill Street Los Angeles, Calif.



CALLING ALL SCOTCHMEN!

THIS AD IS WORTH \$1.00

Honest! We must be crazy! We're extending our offer for one more month in order to acquaint more of you cine-bugs with our unique, guaranteed 24-hour laboratory service, our still and cine "premium" bargains, and complete stock of bulk and short subject motion picture films. "Spend" this ad as you see fit for anything in our latest catalogue. But hurry! Just Clip and Mail with Your Name and Address, and Specify Whether Single or Double 8mm, We'll Do the Rest. No Obligation, of Course. (This offer is valid until Aug. 15, 1940. Only one "gratis" June or July ad to a customer, please! Thank you!)

ESO-S PICTURES

"Quality 8mm Service"
3945 Central Sareet Kansas City, Missouri

TITLES make the picture!

. . . and MITTENS PIN LETTERS
make superb titles . . . clean-cut
plastic letters in a variety of sizes
and styles; also decorations.

Complete Sets

\$5.50
and Up

MITTENS LETTER COMPANY

REDLANDS, CALIFORNIA

NOTICE TO MOVIE FANS

If you take movies (8mm or 16mm) you simply cannot afford to be without a Free copy of the latest Photo Bargain Book now being distributed throughout the U. S. Lists all the best moving picture equipment from all the leading manufacturers, describes them. The prices save you money in many cases. You'll find the latest in lenses, screens, meters, projectors, cameras, film, titles, editing outfits, tripods, books on editing, tiling, etc. This Bargain Book is invaluable to you as an equipment REFERENCE book. Don't wait a day longer to send for your Free copy. WRITE us now.
CENTRAL CAMERA COMPANY
730 S. Wabash Dept. G-9 Chicago, Illinois

FILTER FACTORS FOR POPULAR 8MM AND 16MM REVERSAL CINE FILMS

FILM	Filter Description	K-1 Light Yellow	K-2 Medium Yellow	K-3 Dark Yellow	Aero 1 Light Yellow-Green	Aero 2 Medium Yellow-Green	G Orange	23-A Light Red
Cine Kodak "S".....	Daylight Mazda							
Cine Kodak "S" Super X	Daylight Mazda							
Cine Kodak "S" Safety....	Daylight Mazda	1.5	2.	2.	1.5	2.	2.5	3.
Cine Kodak "S" Super X...	Daylight Mazda	1.5	1.5	1.5	2.	1.5
Cine Kodak "S" Super XX	Daylight Mazda							
Agfa 16mm Plenachrome...	Daylight Mazda	2.	5.	...	2.	4.
Agfa 16mm Panchromatic...	Daylight Mazda	2.	3.	...	3.	4.
Agfa 16mm Triple "S" Pan	Daylight Mazda	1.5	2.	...	1.2	2.	2.	2.
Agfa 16mm Hypan.....	Daylight Mazda	1.5	2.	...	1.2	1.5	2.	3.
Agfa 16mm Twin-8 Hypan.	Daylight Mazda	1.5	2.	...	1.2	1.5	2.	...
Gevaert Panchro Super....	Daylight Mazda	1.4	2.	2.8	2.	2.8	2.8	8.
Gevaert Panchro Microgran	Daylight Mazda	1.4	1.4	2.	2.	4.
Gevaert Orthochromatic....	Daylight Mazda	1.4	2.	2.8	2.	2.8	2.8	8.
Dupont Regular Pan.....	Daylight Mazda	2.	8.	11.	4.
		1.4	2.
		2.	2.5	4.	2.	3.2	4.	6.3

Note: All figures are approximate. Figures such as 2.2 may be considered as 2, and 1.25 as 1.5 (or 1 1/2), and etc.

Kodachrome
MAPS • Charts • FINE TITLES
Geo. W. Colburn Laboratory
Special Motion Picture Printing
1197 Merchandise Mart, Chicago

sity of making interior shots. You will note all of these scenes are closeups, presumably taken within the assayer's office; but by making them "tight" closeups—that is, with the heads or heads and shoulders filling the screen—what little background may be evident will not expose the fact the shots were made out of doors, provided they are shot against a dark background and with the lighting coming from one side into the characters' faces. Overhead light should be well diffused or eliminated entirely, in order to create the illusion of an interior shot.

Eight Turret

• Continued from Page 330

plate to allow for the threaded portion of the inactive lens, and to furnish a bushing or base for the turret to swing upon. It also holds the pin on which the turret swings.

The next step is to lay out and cut the lens-turret plate. See Fig. 2. A hole is drilled and tapped at "D" to take the threaded end of the sleeve "L" which will be described later. The holes "E" are drilled to accommodate the shouldered portions of the lenses. These holes are countersunk 1/32 of an inch as shown, the diameter of which depends upon measurements of the lenses to be used. Four holes are drilled and tapped, as shown at "G" to take No. 6-32 brass screws that hold the lens retaining rings in place.

The lens retaining rings, shown in Fig. 3, are shaped

NEW CLUBS FORMING

• Amateur movie makers interested in becoming a member of a new cine club now being organized in Racine, Wis., are requested to communicate with John R. Kibar, 721 High Street, of that city.

• Cine amateurs residing in vicinity of Chicago's west side who are interested in joining a new cine club now forming are requested to communicate with John E. Fletcher, 108 No. Lamont Avenue; phone Columbus 0939.

• San Francisco 8mm, 16mm and 9 1/2mm cinefilmmers interested in becoming members of a new amateur cine club to be known as the Westwood Movie Club, are requested to communicate with Don S. Campbell, 1164 Portola Drive, San Francisco, Calif.



16mm

AMBERTINT

**Quality Outdoor Film
at Extremely Low Cost**

Fine grain, semi-ortho, large latitude—half stop either way—the OUTDOOR sensation film of the 20th Century. AMBER tint of film "different" and pleasing. Amazing low price includes machine processing. **\$2⁰⁰** SHOOT MORE OUTDOOR ACTION FILM AT LESS COST. 100-ft. roll.....

Order Direct
AMBERTINT not sold at dealers. Order several rolls direct—save money. Not made in 8mm nor sold in bulk.

California Buyers Include Sales Tax

Write for Big Free Bulk Film Catalog



HOLLYWOODLAND STUDIOS
THE WEST'S GREATEST FILM MAIL ORDER HOUSE
SOUTHGATE, CALIFORNIA

SAFE SUMMER STORAGE

FOR YOUR FILMS
in your own home

VAPORATE your films NOW—for protection against summer's sticky humidity.

Better photo finishers offer you VAPORATE Permanent Protection against climate, wear, scratches, oil, dirt, water, and finger marks on your still films.



VAPORATE
FILM TREATMENT

VAPORATE CO., INC. 130 W. 46th St. New York City	BELL & HOWELL CO. 1801 Larchmont Chicago 716 No. La Brea Hollywood
--	--



FADES, WIPES Can be added to your Reels after Processing WITH FOTOFADe on black and white or color films. Price \$1.00. Waterproof Wipeoff Tape, 60c per roll. Complete Fotofade Kit \$1.60

CINETINTS for coloring your 16mm or 8mm film. Set of six colors \$3. At your Dealer or direct.

DYE RESEARCH LABORATORIES
318 Jackson Street
Los Angeles, Calif.

Why use anything else when

TITLES BY PARK CINE

cast na mare than ordinary titles.

Catalog Free on Request

PARK CINE LABORATORY

120 West 41st Street New York City

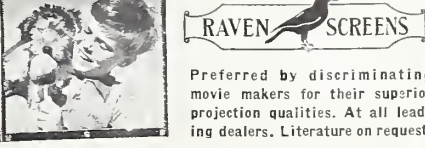

Preferred by discriminating movie makers for their superior projection qualities. At all leading dealers. Literature on request.

RAVEN SCREEN CORP., 314 East 35th St., New York

DRESS UP YOUR MOVIE TITLES

"A to Z" Figurines
for MOVIE TITLE BACKGROUNDS

30 subjects in color. Reusable. Sticks to any surface. Complete assortment \$1. At your dealer or send direct.

JACOB STEIN (Mr.), Dept. F3
175 Fifth Ave. New York, N.Y.

from 1/16-inch brass material. The hole and the countersunk area will also depend upon the size of the lenses to be used. The purpose of countersinking these rings as well as the turret plate, is to permit mounting the lenses on the plate in a manner that will allow them to seat properly against the camera case as shown in Fig. 8. The two holes drilled at "H" accommodate the 6-32 machine screws referred to above.

This brings us to the construction of one feature which at first may seem difficult—the sleeve with which to lift and rotate the turret (Fig. 5). It consists of the stud-shaft "F"; the sleeve "L"; the spring "J" which pushes the turret-plate against the camera, insuring proper seating of lens; and the nut "K". Unless the amateur has access to a lathe and, of course, is skilled in its use, it will be necessary to have these parts turned out by a machinist. The cost will be nominal.

With the parts made and ready for assembling, the stud-shaft "F" is screwed into the mounting plate and shim "B," fastened with bolts "M." The sleeve "L" is then screwed in place in the hole "D" of turret-plate; and this assembly is then mounted on the stud shaft—the spring "J" inserted in the sleeve and the nut "K" screwed on tightly. Thrust washers may be used at each end of the spring to give a smooth turning action.

Before the turret can be mounted on the camera, it will be necessary to remove the threads from the lens seat in the camera as shown in Fig. 8. This is best done on a lathe. Just the threads should be removed—no more—allowing the lens in the turret-plate to enter freely, yet fit snugly without any possible side play.

With all of the parts machined and assembled as directed, the turret unit is ready to be put together and mounted on the camera. The size and kind of bolts used to attach the mounting plate to door of camera is immaterial. Make sure, however, they do not protrude into the camera beyond the nuts. File off any extensions, and paint bolts

Attention!

8mm CAMERA OWNERS



A Fortunate Purchase!

A fortunate purchase enables us to offer these high grade telephoto lenses to owners of 8mm movie cameras. They are attractively priced at a time when precision equipment of this type is harder than ever to get. A rare opportunity to obtain an excellent lens at a tremendous saving.

Special Mounts to Fit the Following Cameras:

**BELL & HOWELL FILMO
KEYSTONE
REVERE BOLEX**

Specify style of mount when ordering. Quantity limited.

1 1/2-in. Britor F2.7 \$29.50
1 3/8-in. Hugo Meyer F1.5 . . . 59.50
1 5/8-in. Hugo Meyer F1.5 . . . 62.50

If it's photographic, you'll find it at

Willoughbys

32d St. near 6th Ave., New York
World's Largest Camera Store
Built on Square Dealing

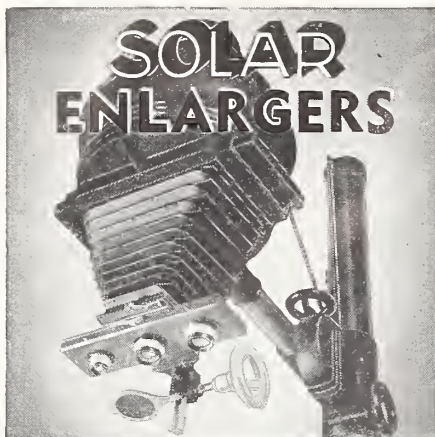

SOLAR ENLARGERS

For "PRIZE WINNING" Prints
Study These Outstanding Features
 • Of perfect design • Horizontal and Vertical Projection • Easy to focus • Double Adjustable Bellows • Interchangeable Lens Boards • Dustless Negative Carriers • For 35mm. to 5x7 films • May be used as a camera • With or without condenser • Perfect ventilation, ENLARGING TREATISE HM740 FREE

Burke & James, Inc. 225 W. Madison St. CHICAGO, ILL.

Golden Gate International Exposition

16mm Films—Three 100-ft. reels professionally taken. No titles except heading and end, thus no waste footage.
REEL 1—General views. Oakland Bay Bridge, Tower of Sun, Fountains, Buildings, etc.
REEL 2—Continuation of reel 1 plus scenes in Gay Way.
REEL 3—Night Photography. The Fair in all its splendor. General views of the Gay Way.
 Each reel is complete, though you can add one to the other and not duplicate. These are black and white, specially priced at Reels 1, 2 or 3, 100 ft. \$1.95. Please specify when ordering whether you want Reel 1, Reel 2, or Reel 3.
NATURAL COLOR PRINTS—Full color Kodachrome showing the fair in all its beauty. Only color can do justice to the magnificent settings of the fair. 100 ft. 16mm, \$9.00. 8mm black and white available as follows: 50 ft. 8mm, \$1.75; 180 ft., 8mm, \$5.50.

HOLLYWOODLAND STUDIOS
 "The West's Greatest Film Mail Order House"
 South Gate Dept. 107 California

FINE MACHINE WORK

We install backwinds on Eastman, Bell & Howell, Keystone, Univex, Victor, Revere, and other cameras, and install frame counters on other backwinds. Backwinds from \$10.50 up.

Turret installations of Filmo Double 8, \$28.75, Victor Model 3, \$30.50, and on others at proportionate prices.

Special Apparatus and Lens Alterations

MacVAN MFG. CO.
 3829 EL CAJON SAN DIEGO

DON'T PAY HIGH PRICES FOR FILM BUY ONYX 8 FILM FOR LESS

100 ft. 16mm \$2.00
 25 ft. double 8 \$1.00
 30 ft. for Univex 50c

Minimum Order \$1.00

Reversal Free of Charge

Write for price list of all types and grades of film. Processing chemicals for Home use.

KENWOOD FILMS

1231 E. 46th St. Chicago, Ill.

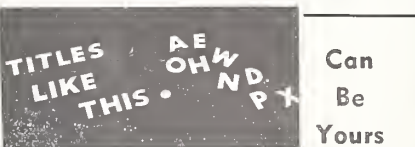

Full 122 pieces for \$1.00. Letters 1 inch in height, made of stiff polished coated cardboard—all die cut. Come in 6 colors—red, green, yellow, blue, black and white. Least expensive yet best type of letters for photographic titles and quotations, etc. Send check, money order or \$1.00 today . . . letters shipped immediately, postpaid.

Rich Mfg. Co.
 364 Atlantic Ave. Boston, Mass.

and nuts with flat black paint.

The lenses are mounted on the revolving turret by means of the retaining rings illustrated in Fig. 3. Properly mounted, the surface of the lens base should be flush with the back surface of the turret plate so that when the lens is in place, it will fit properly in the lens seat of the camera.

With the turret mounted ready for use, the next step is to make a few test shots to determine if the lenses are seating properly—particularly the telephoto lens—as any deviation from center will throw the picture off center as compared to that seen in the viewfinder. A close check of the seating of each lens should correct any error in focus. Where the lens appears to be seated at a slight angle, this may be corrected by re-milling the countersunk area in the turret-plate and lens-ring, or by slightly

bending the turret-plate.

Many will wish to have this turret unit finished in keeping with the trim of their camera. Remove the lenses, replacing the lens-retaining rings, and send the whole unit complete with all screws and bolts to a plater's for a dull nickel finish. After this, the final step will be to mask off the front element of the camera viewfinder to correspond with the areas of the extra lenses to be used in the turret. This may be done by removing the hinged film gate within the camera, and with a small dental mirror in place behind a piece of frosted film held against the film aperture, focus the lens until the image is seen in the mirror. The corresponding area may then be marked upon a piece of amber celluloid cemented over the front viewfinder element, and then cut out with a razor blade.

Movies Cheer Old Folks . . .

• Continued from Page 334

shown at the first place and rapidly took it to the second showing where, if schedules were carefully planned and no delays were experienced, it was ready to go on the machine by the time he arrived. The third reel followed later in the same manner and by 8:30 we were through and still had the evening for ourselves. I might add at this point, that the maintenance of the relay schedule provided as much fun and pleasure as the actual presentation of the program.

We went through some anxious moments at the second institution many times waiting for our relay to show up and upon one occasion a new member lost himself somewhere between the two, but finally arrived and the show continued. It was amusing many times to see one member running breathlessly from his car which he hardly had time to stop, in order to rush the film to the projectionist who was also sweating blood to keep his show on schedule. We later provided the second projectionist with a roll of movies from some club member, if not his own, to

use in an emergency, altho we seldom had to use it.

There is another phase to this plan of Shows for Shut-Ins. I wonder how many who read this article can guess why movies are more valuable entertainment than any other to old folks. These same institutions have many other types of entertainment brought to them, mainly juvenile acts from the dancing studios, but the attendance is never as great as on the evenings when pictures are shown. These old people stay in their rooms in amazingly large numbers when children perform but turn out 100 per cent for the movie show.

I went to considerable trouble to analyze this situation merely to satisfy my own curiosity and discussed it with the residents themselves as well as the heads of the homes. These old people do not usually have control over their own situation and are more often the victims of peculiar circumstances. First of all, their families are broken and scattered and those which are not do not always retain the loyalty and respect

FADES LAP-DISSOLVES WIPES VIGNETTES



OPERATED BY CLOCKWORK
 —over-ready, small, light (4 oz.), compact, easy to operate, efficient, and durable.

Price \$9.95 Includes Adapter, Wipe Disc, and Cable Release

Accessories
 FADE DISC \$1.95
 VIGNETTER \$2.95
 Extra ADAPTERS 95c and up
 SPECIFY CAMERA AND LENS
 From Your Dealer or Direct
BAIA MOTION PICTURE ENGINEERING
 8044 Hardyke Detroit, Mich.

Do as Hollywood Does—Hand-letter your TITLES

"A to Z" TITLING OUTFIT

• Beautiful hand-lettered titles can be made in several colors or black and white with this easy tracing method. No loose letters—every title different—professional results. **AMERICA'S ONLY SCRIPT TITLE MAKER.** At your local dealer or send \$2.00.
 • FREE "Try It Yourself Kit" JACOB STEIN (Mir.) 175 Fifth Ave., Dept. H 14 New York City



BETTER MOVIES

WITH **BLACK & WHITE FILM** 16mm—100 Ft. Reversible Film **\$1.98** Including Processing Rating: Weston 12, Scheiner 18 At your dealer or direct. Fast service processing same day included at no additional cost.
 • VISUAL INSTRUCTION SUPPLY CO. 1757 Broadway Box H9 Brooklyn, N. Y.

BETTER Home Movies

Write when you use Wonderlite Photo Lamps for our price list.
WONDERLITE CO. 14-H Northfield Ave. WEST ORANGE, NEW JERSEY

PROCESS YOUR MOVIES

With Roycraft equipment, home processing is easy. Have the pleasure of developing your own movies and save on film. Complete set, including chemicals and instructions; capacity 30 ft. single 8, double 8 or 16mm \$2.95. Develops titles, too. Write for circular.
ROYCRAFT COMPANY
 Dept. 22, Box 1810 Milwaukee, Wisconsin

GENUINE KODACHROME TITLES

16MM—As Low as 60c—8MM With Your Color Backgrounds Exclusive With **ORBIT TITLES** 5437 1/4 Hollywood Blvd. Hollywood, Calif.

Cine Shop TITLES The BEST THAT MONEY CAN BUY Your inquiry is invited **Cine Shop** 1812 PIEDMONT • CHARLESTON, WEST VA.

for them that they deserve. Juvenile acts bring to mind too many memories of their own grandchildren which could be pleasant in other surroundings but serve as bitter reminders of their situation. I have seen many tears fall from the eyes of the most emotional ones when a perfectly beautiful juvenile act was being given and many of them turn their heads away trying desperately to steel themselves against some sad or unpleasant memory. I have letters from the heads of some of these groups to verify this fact and all of them have told me that of all the entertainment available they prefer pictures.

In the selection of programs, many of the free films are of the commercial variety, advertising some product or process of manufacture and these are all of good entertainment value; but occasionally we found it necessary to censor our program because of propaganda material or religious and political restrictions. In general, however, most all of the free programs are acceptable, but the most popular of all seem to be the travel films. Government films and those available from tourist agencies, railroads, airlines, etc., are by far the best for this purpose.

The peculiar reward for the effort of showing these programs is worth far more than the time and trouble involved. The gentle pressure of a warm handshake from any number of these people has left me speechless many times. The pleasant and generous smiles and thank-yous which followed every one of these programs gave me a greater desire to further the project but unfortunately we had to temporarily discontinue it, due to the expense which our small membership could not afford.

I made an attempt to solicit aid from merchants, offering publicity in return but somehow could not arouse sufficient interest to maintain a regular schedule. Since that time, our membership has grown to the point where we cannot take any additional applications, and we are prospering nicely. Now we will probably resume this activity, assuming the expense from

THRIFTY FILM Quality

**At Last!
16MM CINE FILMS PRICED
TO FIT YOUR PURSE**

Thrifty films save you 50% on your film cost. Three splendid films to choose from—each a leader in its class. And now the surprise—look at these prices!

THRIFTY ORTHOTYPE \$1.60

For OUTDOOR . . . non-halation base, fine grain, fast, Weston 8—the film you've been wanting to find at an unheard-of low price. Machine processed. Per 100 ft. rolls.....

THRIFTY PANCHROMATIC \$3.75

Use for all types of shooting. High-speed Weston 16 daylight—10 photofloods, machine processed. Per 100 ft. rolls.

THRIFTY SUPER-PANCHROMATIC \$4.25

Super-fast; high sensitivity, requiring minimum of light. Weston 30 daylight—32 photofloods, machine processed. Per 100 ft. rolls.

THESE PRICES INCLUDE EVERYTHING

Daylight loading, processing, and return postage. All films are machine processed.

You Wonder Why Our Prices Are So Low? Because our sales are direct from manufacturer to consumer. You save the sales commission paid the distributor, jobber, and the retailer. This means a 50% saving to you without sacrificing quality in any way. Order immediately and enjoy your camera—join the thousands of fans who are availing themselves of Thrifty savings.

THRIFTY BULK FILM

With this issue we enter the bulk film field. Write for catalogue and note these low prices.

100 ft. double 8mm semi-ortho... \$1.19
100 ft. straight 8mm semi-ortho .75
100 ft. 16mm semi-ortho..... \$1.19

All above are laboratory packed and prices do not include processing.

California customers please include 3% sales tax. No C.O.D. orders unless accompanied by \$1.00 cash with order.

Sold and Processed Only by

THRIFTY FILMS

Drawer 98, Watts Station, Los Angeles, Calif.

NEW 8-16mm "CINE-SCOPE" POCKET-VIEWER \$1.00



MAGNIFIES 36 TIMES AREA
Optically-ground lenses insure a large, clear-cut image. Adjustable. Film is slipped in, at the side. Groove holds film in position (see photo). A \$3.50 value—GOING FAST at \$1.00.

A REAL NECESSITY—ORDER NOW!
State 8 or 16 mm. Enclose dollar-bill and dime post. (DON'T SEND STAMPS.)
Designed by: E. M. LIEBSCHER, Opt. Engr.
157-pc. "moderne" TITLING-SET, \$1.95
3/4 in. high—3/4 in. thick of cast-white DENTAL plaster. "Third dimension," NO PINS. Regular price, \$4.00 per set. Has letters, figures, etc. 157 pcs. Shipped ins. exp. (chgs. approx. 35c). DIME BRINGS SAMPLES—NO STAMPS. FREE! "Table of sizes" CHART with ALL orders (while they last). Reg. \$1. Gives "field-sizes" at various distances. "CAMERA SPECIALTIES"

P. O. Box 3182 Hollywood, Calif.

our treasury which we are well able to do.

I like to think that our present success is partly due at least to our philanthropic attitude. We have had a worthy cause, have suffered many hardships as a new organization and were attempting to handle a problem which we could not afford; but the dividends are now coming back with increased interest and we find that we must have a waiting list for new members with our present facilities.

If it should be my lot to spend my declining years in an institution, with long days and lonesome nights, with a mind befuddled with the past, with a heart twisted and torn by the loss of my family and friends, I sincerely hope that those last days of waiting for that life beyond the stars can be made happier, easier, more endurable by some such worthwhile cause. If at that time, some one will sprinkle the perfume of happiness upon me, he will be rewarded just as I have been, and I'll be able to share his pleasure, too, seeing him spill those few drops upon himself.

Tele-lens test . . .

• Continued from Page 337

blocked out with a diaphragm if the surface is otherwise acceptable.

Heat from the hand or breath, or change in room temperature is enough to change the curve temporarily, so it is wise to leave the mirror on its stand a few minutes before testing.

If the mirror can be made to appear like C in Figure 2, when the razor cuts the cone of light days in half, the mirror is spherical. This is the best curve next to a true parabolic surface for our telephoto mirror, and a spectacle lens or other concave surface that tests up this close will give good definition. If it appears like I, J and K it will be much better and may be very close to a true parabola. However, if the shadows are too dark, the surface may be a "hyperbola" or "over-corrected."

J and K show two extreme views of a parabolic

GREAT VALUES OUT OF NEW FREE LAFAYETTE CATALOG

REELS AND CANS

Reel values! Made of heavy aluminum. Patented sprocket device accommodates every type reel arm. Humidars of heavy gauge aluminum.

8 mm. Reel	29¢ Each 6 for 1.69
8 mm. Can	
16 mm. Reel	39¢ Each 6 for 2.27
16 mm. Can	



REEL CLIPS
8 mm.—6c ea.
12 for 67c
16 mm.—8c ea.
12 for 89c

FILM STORAGE CHESTS



8 MM. 6-Reel Capacity	\$1.85
12-Reel Capacity	\$2.55
16 MM. 6-Reel Capacity	\$2.25
12-Reel Capacity	\$2.95

FILM CEMENT

1 oz. bottle	18¢	4 for	69¢
1/2 oz. bottle	9¢	4 for	29¢

ORDER NOW!

Economy

TRIPOD SCREEN

Superfine quality 30x40 inch tripod screen. A new patented fabric surface processed to act as a light filter, giving intense light without glare. Sets up easily and quickly. Non-scratch rubber feet.

ONLY \$4.89

CLIP YOUR ORDER TO COUPON

Save time and money! Just enclose this ad, or any part, or note attached to coupon, along with your check or money order. Mark each item you desire and mail today.

ALL MERCHANDISE GUARANTEED

SEND FOR THIS BIG FREE CATALOG!

IT'S BRAND NEW!

A whole book of great values in photography! Complete, up-to-the-minute, packed with all the latest nationally advertised cameras and equipment. It's money-saving! Send coupon for your FREE copy at once!



LAFAYETTE CAMERA

DEPT. 80F—100 SIXTH AVE., NEW YORK, N. Y.

I ENCLOSE \$..... RUSH MY ORDER

PLEASE RUSH FREE CATALOG No. 81

NAME _____

ADDRESS _____

CITY _____ STATE _____

8mm — MOVIE FILM — 16mm
CINECHROME—Weston 8—Semi-Ortho Fine Grain
 Non-Halation Outdoor Film—High Quality
 30 ft. Single 8 \$.75
 33 ft. Double 8 1.25
 100 ft. 16mm 3.00
 Reversal Processing and Postage Included
 5 Rolls or More, 10% Discount
 State Name of Camera

8mm — BULK MOVIE FILM — 16mm
 Complete New Reversal and Title Instructions Free with Film Orders. Separately, 25¢ each. Cash, Check or Money Order for Quick Service. Remit 1/3 with C.O.D. Orders. Special Delivery, 15¢ extra.

NEW SUPER PANCHRO REVERSAL

Weston 24-16—Anti-Halo Backing		
400 ft.	100 ft.	33 ft.
Double 8	\$13.00	\$3.60
Single 8	7.00	2.90
16mm	11.60	3.25

NEW MICROGRAN PANCHRO

Weston 12-8—Anti-Halo Backing		
400 ft.	100 ft.	33 ft.
Double 8	\$11.80	\$3.30
Single 8	6.75	1.85
16mm	11.50	3.15

NEW HIGH SPEED ORTHO

Weston 16-6—Anti-Halo Backing
 Prices Same as New Microgran Panchro
 These 3 New Reversal Films are Provided with SPECIAL BLACK ANTI-HALO BACKINGS. Daylight loading without leaders, scored for easy separation.

WESTON 8 SEMI-ORTHO REVERSAL

Weston 8-3 Darkroom Loading—Lab. Packed		
400 ft.	100 ft.	33 ft.
Double 8	\$ 4.00	\$1.50
Single 8	2.75	1.00
16mm	4.00	1.15

Clear, Lavender, Amber, Blue, Yellow in 16mm.
 Only Clear and Lavender 8mm Scored.

CINECHROME REVERSAL

Weston 8-2—Violet Non-Halation Base		
400 ft.	100 ft.	33 ft.
Double 8	\$ 5.75	\$1.75
Single 8	3.50	1.15
16mm	5.25	1.50

SUPER CINEPAN PLUS

Weston 50-40—Violet Non-Halation Base		
400 ft.	100 ft.	33 ft.
Double 8	\$13.50	\$3.85
Single 8	7.00	2.15
16mm	12.50	3.50

CINE-KODAK POSITIVE TITLE FILM

Weston 6 (Mazda), Darkroom Loading, Lab. Packed		
400 ft.	100 ft.	33 ft.
Double 8	\$ 4.10	\$1.35
Single 8	2.15	.90
16mm	4.00	1.00

Clear, Purplehaze, Yellow, Red, Amber, Special Blue.
 Also DuPont Lavender, Pink, Light Amber.

CAMERA SPOOLS WITH CANS—Each

Double 8	\$.35	Keystone St. 8	\$.35
Univex 8	.20	16mm	.50
Filmco St. 8	.50	16mm	.60
EXTRA CANS, Double 8 and Straight 8 size	.05		
100 ft. and 50 ft. 16mm size	.10		
Non-Humidor, 400 ft. 20c; 6 for	1.00		

MISCELLANEOUS

BAIA Precision All Metal 8mm Slitter	\$2.50
FOTOFAD DYE, for making Chemical Fades	1.00
FOTOFAD WIPE-OFF TAPE, per roll	.60
CINEPRINTS, 6 Colors and Instructions	3.00
DUPONT VISCOSE SPONGES, each	.35
HOW TO TITLE HOME MOVIES, book, each	1.00
HOME MOVIES, Back Issues, 1936-37-38-39	.15
Back Issues, 1940, each	.30
TITLE DEVELOPER, tubes, each make 16 oz.	.15

FILM PROCESSING—PER ROLL

Reversal			Title Developing		
	100 ft.	33 ft.		100 ft.	33 ft.
Double 8	\$2.00	\$.85	\$1.75	\$.75	
Single 8	1.00	.35	.75	.40	
16mm	1.50		1.25		

WE STOCK EVERY MAKE FILM

Write for Complete NEW Price Lists
 A PERSONAL MOVIE SERVICE
 Telephone LIncoln 1207

W. STUART BUSSEY FILM LAB.

17 E. St. Joseph St. Indianapolis, Ind.

mirror. The amount of "correction" can be found by putting a piece of paper under the block of wood that holds the razor blade and marking these two positions with a sharp pencil. The distance between the two lines is the difference in radius of curvature of the central and outer zones of the mirror. The line nearest the mirror is the R. of C. of the central zone, unless the mirror is an oblate spheroid, which would cause the lines to be reversed in position.

The radius of the mirror squared, divided by the radius of curvature equals the true correction of a perfect parabolic surface. Thus, a mirror 4" diameter (2" radius) of 20" focal length (f/5 or 40" R. of C.) should have a correction of 1/10 of an inch. Anywhere between 1/8" and 1/12" would give good definition. This "correction" value is exactly twice the depth of the concavity which is 1/20th of an inch for the 4" f/5 mirror.

Whether an amateur uses a concave spectacle lens or grinds his own for use as the reflecting element in his telephoto lens, the test just described will enable him to insure selecting a lens with the best reflecting surface. Obviously, low-priced spectacle lenses cannot always be counted upon to be 100 per cent perfect. But such lenses are more readily within the means of the average amateur; do the job well when the concave surface is as near 100 per cent parabolic as is possible to get; and therefore, their use is recommended. It is advisable to purchase several; silver or "aluminize" them as described last month, then subject each to the Foucault test in order to determine which is best suited optically for your reflecting telephoto lens.

(NOTE: In last month's article, the word "convex" was incorrectly used in the seventh paragraph on page 285 to describe a lens. The lens surface should have been correctly described as "concave."—EDITOR.)

Glorified Sixteen . . .

• Continued from Page 335

off the spool, leading to jamming. How this was accomplished will be described later.

Accessories which mount on the gear box and couple to the shaft for the making of wipes and fades, are so designed that no tools are required in mounting or demounting them. This is a decided advantage when we consider that the less equipment one has to carry the better.

The design of the wipe-

off fan and bracket is such that wipe-offs may be made with the camera mounted on tripod or held in the hand, either with equal ease. Moreover, the one fan blade serves for the wipe-on and wipe-off operation.

The next important adjunct to this "Glorified Sixteen" is a means for making fades and dissolves by automatically opening and closing the lens diaphragm through the gear arrange-

• All Amateurs, whether subscribers of HOME MOVIES or not, are invited to submit their films to the editors for review and helpful criticism. Unless otherwise requested, reviews of some of the films which we believe would benefit other amateurs will be published each month.

Reviewed films will be rated one, two, three, and four stars, and films qualifying for two or more stars will receive, free, an animated leader indicative of such award. Detailed reviews, with suggestions for improvement—if any—will be mailed to amateurs submitting their films.

Exceptional films qualifying for

the distinction of the "Movie of the Month" will be treated in detail in a feature length article in a following issue of HOME MOVIES. In addition, a certificate evidencing the award of "Movie of the Month" and a special animated "Movie of the Month" leader will be returned with such films after review.

When submitting films for review and analysis, please advise make of camera, speed of lens, whether or not tripod was used, or if you used filters, exposure meter, or other accessories. While this information is not essential to obtain analysis of your film, we would like to pass it on for the benefit of other amateurs.

Bulk Film Gives You Big Savings in Footage Costs



Shoot More Film for Less Money

Use 8mm BULK FILM 16mm

Fine grain, Semi-ortho, Non-halation Weston 8. For titles or reversals. Lab. packed. Free formulas each order. All film guaranteed fresh stock—not re-perforated positive. Calif. buyers include sales tax.

SPECIAL PRICES THIS MONTH

400 ft. STRAIGHT 8mm for UNIVEX, KEYSTONE, etc.	\$2.99
800 ft. 8mm in dbl. 8mm widths for all dbl. 8mm cameras	\$3.99
400 ft. 16mm	\$4.19

Above prices good only to August 15 and by mail order only. None sold over counter at these prices.

SPOOLS—Univex, 5 for \$1.00. Dbl. 8mm, ea., 40c. 50 ft. 16mm, ea., 40c. 100 ft. 16mm, ea., 50c.

Write for Big Free Bulk Film Catalog

HOLLYWOODLAND STUDIOS
 THE WEST'S GREATEST FILM MAIL ORDER HOUSE
 SOUTHGATE, CALIFORNIA

Your Own Metal Title Letters

Ask for Samples of the Most Beautiful Capital and Lower Case Letters Made

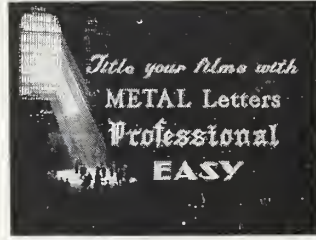

Complete Sets in Wood Case, 222 Pcs. . . . \$7.16
 126 Caps Only . . . \$4.28
 AN INTERESTING ADDITION TO YOUR MOVIE HOBBY
 Specify White or Black Letters
KNIGHT & SON, INC. P. O. Box B, Seneca Falls, N.Y.

MOVIE FILM Reg. Weston 8 Super Pan
 16mm, 100 ft. \$1.79 12 24
 16mm, 50 ft. 1.19 1.39 2.19
 Dbl. 8mm, 25 ft. .98 1.19 1.39

Not to be confused with bulk film. Each roll complete on daylight loading spool in metal container in mailing carton. Prices INCLUDE high grade processing service 24 hours in our laboratory. Supplied in 3 popular types: REGULAR semi-ortho; SUPER full-ortho, non-halation, wide latitude, PAN is extremely fast, panchromatic, very fine grained.

ORDER TODAY DIRECT FROM THIS AO
 Orders for 2 rolls or more, accompanied by \$1, may be sent C. O. D. for balance.

ESSCO FILM PRODUCTS
 Dept. HM
 6117 SO. CAMPBELL AVE. CHICAGO, ILL.

NEW CATALOG FREE
 Offering all standard makes of new and used movie and still cameras and equipment. Discounts from 15% to 30%. EASY TERMS.
 Serving the Nation from the Nation's Capital
BRENNER PHOTO CO.
 943 Penna. Ave., N. W. Washington, D. C.

75c 50 Ft. Buy 25 Ft. \$1.25
 Now! Dbl. 8mm Dbl. 8mm

Weston 8 **BARGAINS** Weston 24
G ON G FILMS SUPER G
FILM FILM
 Unspooled, To Save You Money. All Prices Include (Full Panchro-Processing and Postage matic, A.H.)
M-G-M PHOTO SERVICE
 100 Ft. 1485 Oak 100 Ft. \$3.95
 16mm San Francisco 16mm

FILMS FOR RENT
 16MM SOUND - 16MM SILENT - 8MM SILENT
 Send for Free Gigantic Catalogue
 Listing over 3500 subjects.
IDEAL PICTURES CORPORATION
 28 East Eighth Street, Chicago
 and
 2402 West 7th Street, Los Angeles, Calif.

MAKE YOUR OWN TITLER!
 For all types of titles, close-up and copy work. Complete kit of finished parts—optically ground lens—easy instructions. Assemble in 15 minutes! Money Back Guarantee. State camera model. Distinctive Title Card—"Photography by (your name)"—35c

ORDER DIRECT FROM
HOLLYWOOD MOVIE SUPPLY COMPANY
 NORTH HOLLYWOOD • CALIFORNIA

ONLY \$1.65 IN KIT FORM
 FOR ALL 8 or 16 MM CAMERAS

Film Clips
 MOVIE REEL FILM CLIP WITH THE LION GRIP
 CLIPS ON REEL
 FITS EITHER 8 OR 16mm
 2 DOZ. FOR \$1.00
 POST PAID
LEO ENTERPRISES.
 BOX NO. 2228 ST. LOUIS, MO.

.. TITLES ..
BACKGROUNDS FREE

25c UP TO 10 WORDS EACH ADDITIONAL WORD 2c

FILM IN BULK
 LABORATORY PACKED 400 ft. 200 ft. 100 ft.
 16mm ORTHO—West. 8 3.50 2.00 1.25
 SUPER Panchromatic, West. 24 10.00 6.00 3.50
 8mm Double ORTHO—West. 8 (Scored) 3.50 2.00 1.25
 SUPER Panchromatic—West. 24 10.00 6.00 3.50
 REVERSAL PROCESSING—100 Feet or Less 75c

Reducing ★ Enlarging
 ILLUSTRATED CATALOGUE
GENERAL CINE SERVICE
 204H East 18th St., New York

• We want suggestions and ideas for random "back-yard" filming; also for simple home movie scenarios. Those which are published will bring the contributors either a 100-ft. 16mm or a 50-ft. 8mm film subject selected from the advertisements or catalogues of any library or producer-advertiser in HOME MOVIES magazine. For ideas that can be adopted to a feature length article we will reward the contributor with two rolls of panchromatic film. Address your suggestions to **BACK-YARD MOVIES**, care of HOME MOVIES, 6060 Sunset Boulevard, Hollywood, Calif.

ment already described. Cams are so designed as to allow correct closing of the lens iris for a given footage. Should it be desired to make a lap dissolve, the cam which closes the iris from the exposure required to infinity is chosen. For example, the first scene to be lapped, requires an exposure of f/8. The "f/8 to O" cam is placed on the shaft. When the moment arrives to start the fade, the button controlling the effects shaft is pressed which sets in motion the cam controlling and closing the iris, while at the same time one footage counter is keeping track of the amount of film that will have to be wound back.

The fading in of the next scene is handled in a similar manner. However, suppose the second scene requires a different exposure—say f/11. Then the cam marked "O to f/11" is placed on the shaft with the control in the "On" position. Starting the camera, the cam opens the lens from "O" to f/11 in exactly the same amount of time—and for the exact amount of footage—as was required for the fade-out in the first operation at f/8. The auxiliary or effects footage counter records the footage involved at all times so there can be no error in determining either the starting or stopping points in a fade or dissolve.

The third important feature built into this camera is a mask slot for holding an assortment of masks behind the camera lens. Masking at this point is far more accurate than when done with devices held in front of the lens. Twenty-eight masks have been made to

COMPLETE EQUIPMENT FOR HOME PROCESSING YOUR MOVIE FILMS

Develop your own movie film. Save money. Get professional results. Use low cost equipment and supplies from "Home Processing Headquarters." Anyone can do it.

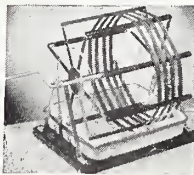

SAVE \$3.00
Genuine GRAPHIC REEL, regularly \$12.50, now in kit form at a saving. Easily assembled in 10 minutes. A complete processing outfit for movie film. Drying rack and directions included. Now only..... **\$9.50**

PROCESSING POWDERS

Complete set famous Graphic Reversal Processing Powders, including 2-in-1 developer, bleach, clearing bath, Special fixer and hardener. Makes 1/2 gallon each solution..... **\$1.35**

HOW TO DO IT!
Home processing made easy. Complete instructions including plans and directions for making your own processing drum, tank, drying rack, etc..... **25¢**

Write for Prices on Bulk Film, Processing and Supplies
SUPERIOR BULK FILM CO.
"Home Processing Headquarters"
188 W. Randolph St. Dept. HM7 Chicago, Ill.

DO FILTER FACTORS FLOOR YOU?

... then ask about the new HARRISON Duraline FILTER SET—4 Filters, a Holder and Shade to meet 92% of all your requirements. With compact leather case—Easy instructions. New low prices. See them at your dealer today! ... Or write for folder.

HARRISON & HARRISON
Optical Engineers
8351 SANTA MONICA BLVD. HOLLYWOOD, CALIF.

8M RAINBOW 16M

Vacation Specials on Anti-Halation Base Films

	25'	100'
	8mm	16mm
No. 1 A. H.	\$.95	\$ 1.90
No. 2 A. H.	1.60	4.25
No. 3 A. H.	1.40	3.50

Postage and Processing Included
WESTON RATINGS
No. 1—12-4 No. 2—50-32 No. 3—24-16
10% off on six rolls or more.

RAINBOW LABORATORIES
STATEN ISLAND, N. Y.

16 M M TITLES

Let FILMACK MAKE YOUR 16 mm TITLES And Announcements

We'll make your titles snappy, artistic, colorful... and put punch and showmanship in every foot. PROFESSIONAL WORK
The same fine service FILMACK supplies to thousands of theatres.
Send Trial Order or Write for Free Catalog

FILMACK LABORATORIES
840 So. Wabash Ave. Chicago

GLASS-BEADED MOVIE SCREENS
Easily Made!

Make your own sparkling beaded screens—at a fraction of their usual cost! Crystal beads can be applied to cloth, cardboard or almost any smooth surface. Complete directions with each point (No fractions of pounds sold.)
Glass Beads to cover 20 sq. ft. (1 lb.). Finest Size \$1.95

D. GARD, C-5, 54 WEST 74TH ST., NEW YORK CITY

date, some of which include horizontal, vertical, diagonal right and left, four quarter divisions, keyhole, oval, diamond, binocular, telescope, four-quarter diagonals, and etc.

Another useful feature is a special safety slide lever which was installed in front of the camera to control the starting button. Engraved on the camera case opposite the lever are marks indicating three separate stops or positions of the lever. Moved into first position, the lever locks the release button so that no film can be accidentally exposed while handling the camera. Second position brings the hydraulic catch into play to retain the starting button in operating position. The third position cancels action of the hydraulic catch—important where single frames are to be exposed, in that the possibility of exposing more than one frame at a time is avoided.

No doubt there are many amateurs owning model "70" Filmos who would like to "hop" them up with devices similar to those just described. In next month's issue, we shall tell how to remove the mechanism from the model "70", and explain step by step the construction of each of the devices described.

Pro - 16's . . .

• Continued from Page 322

only given his production a good title, but has created a swell 16mm Kodachrome picture. "Behind The Bottle" will be widely used by educational and service groups in the communities serviced by the sponsor.

War Pix

Newsreels recently revealed that the British Air Force is using 16mm cameras mounted on fighting planes for recording graphically the results of battles with enemy planes. Cameras are ingeniously mounted and are pre-set so that the pilot or observer does not have to touch the camera in any way during flight. The camera works automatically, exposing film only as the craft's machine guns are fired. When each ship returns, the film is quickly removed from the cameras, developed, and studied.

NEW FUN for dull days

Get G-E Photofloods and get busy!

PRICES SHARPLY REDUCED!

- G-E No. 1 now **15¢**
- G-E No. 2 now **30¢**
- G-E No. R-2 (reflector) now **85¢**
- G-E No. 4 now **\$1.20**

G-E DAYLIGHT PHOTOFLOODS

- G-E No. 1-B now **30¢**
- G-E No. 2-B now **60¢**
- G-E No. 4-B now **\$1.75**

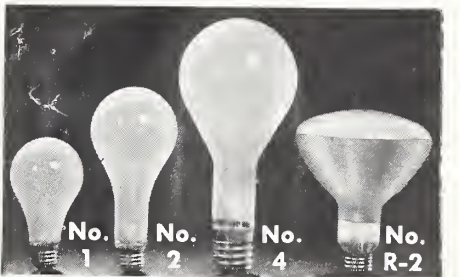

"STILL" NEWS!

- Prices also reduced on G-E MAZDA Photoflash lamps
- No. 5 (the amazing midget) . . **13¢**
 - G-E No. 11A **13¢**
 - G-E No. 21 **15¢**
 - G-E No. 16A **15¢**
 - G-E No. 31 **23¢**

GENERAL ELECTRIC MAZDA PHOTO LAMPS

Take Your MOVIES with



Write Today for Free Offer—Limited
A FULLY GUARANTEED PRODUCT
It is easy to take GOOD PICTURES with
MOVIE MASTER CAMERA FILMS
FAST PROCESSING SERVICE

	100 ft.	50 ft.
Movie Master Ortho.....	\$2.50	\$1.50
18 Scheiners, Weston Daylight 8		
Movie Master Panchro.....	\$4.25	\$2.50
23 Scheiners, Weston Daylight 24, Tungsten 16		
Movie Master Colorone.....	\$6.00	\$3.00
A Colorone Process (Not Natural Color)		

MOVIE MASTER FILM CO.
Ridgefield Park, N. J.

FADE-O-SCOPE

**Camera Dissolve With
Genuine POLAROID Lenses**
IMPROVES your pictures 100% with
finest professional fades, lap dissolves
and other advantages.

• Write today for details and new
SPECIAL PRICE offer.

FADE-O-SCOPE, Inc.

200 FIFTH AVENUE, NEW YORK, N. Y.

THE NEW
"CRITIC"
MODEL 40

\$18.75
Perfect exposures because
of light acceptance
angle of the "Louvre"
construction.

DeJur AMSCO CORPORATION
SHELTON, CONNECTICUT

BETTER MOVIES
WITH
BLACK & WHITE FILM
Reversible Film
25 Ft. Double 8mm
Including Processing **98¢**
Rating: Weston 12, Scheiner 18
At your dealer or direct. Fast service
processing same day included
at no additional cost.

• **VISUAL INSTRUCTION SUPPLY CO.**
1757 Broadway Box H9 Brooklyn, N. Y.

IN PHILADELPHIA
CAMERAS
and Everything Photographic
KLEIN & GOODMAN
18 S. 10th STREET

LEARN PHOTOGRAPHY
Thorough, practical training
For pleasure or career. All phases
of photography. Commercial, News,
Portrait, Advertising, Motion Picture,
Color. Teaching staff of noted
authorities. 30th year. Send for
e Booklet.
New York Institute of Photography
10 West 33 Street (Dept. 114) New York City

So you want to know how!

• Continued from Page 336

will be found, are much cheaper than film, and if the expense must be cut down, it is better to economize on the latter.

Q. How little developer can I use? Is a quart enough for a hundred feet, or must I use more?

A. This again depends on the strength of the formula. Usually this will be sufficient, unless the formula used states otherwise. But in any event make sure the solution covers the film.

Q. I understand I can reverse the standard brands of film now on the market in an emergency and get good results. I understand I would save no money, as the processing is included in the price. But if I do, what difference would I encounter?

A. You would encounter practically no difference, since the procedure is the same. Some films have an anti-halation backing, but with some formulas this comes off during developing or bleaching. If this doesn't remove it, wood alcohol will.

Q. I see many companies advertising panchromatic bulk film for sale. Will these reverse, and what results can I expect as compared to films including processing?

A. The difference will be that between your ability to process a film and that of the big companies who have thousands of dollars worth of expensive, automatic equipment, not to mention years of experience in doing this type of work. Some amateurs who have been reversing their own films for years can approach the professionally reversed film in quality, but he is an exceptional amateur indeed who expects professional results on his first six dozen rolls. This doesn't mean your results won't be any good, for the film is good film. It all depends on your ability to reverse the film as to how good the results will be.

Q. Can any reversal film be used as a positive in printing from a negative?

A. As far as your question goes, the answer is yes, but you gain nothing in doing so. In order to get a

positive print, you wouldn't reverse the film, for this would give you your negative image again. Also, the reversal film is much more expensive, and anyway, positive film is made for just this purpose, so why use anything else?

Q. Is DK-20 a good negative developer? What is better? And what is the best developer for the positive print?

A. Yes, DK-20 is a good developer, being very fine grain in nature, and this is necessary in cine film. D-76 has been a favorite of many for years and, in fact, any fine grain negative developer is usable. The manufacturer of each positive emulsion has a formula for its development and this is recommended for best results. D-16 is probably the most used.

Q. Does the revolving reel take more or less developing time than when the film is completely submerged? Which is the better?

A. The amateur will probably find the revolving drum more suitable, since it requires much less solution, and will be found easier to use in general. For the laboratory using developers day after day, the tank is probably better, but for those using the equipment only a few times each week or month, the drum is better.

Movie of Month

• Continued from Page 326

extraordinarily complete sequences. A long shot introduces the locale or subject, then a succession of medium and closeup shots brings us right up close to the subject. Invariably the camera position is frequently changed to enliven the tempo of the sequence.

There is the sequence relating to jack-o-lanterns. The beginning scene shows two youngsters in the field selecting their pumpkins from beneath a shock of corn-stalks where they were gathered during harvest. Then we see the youngsters

coming toward the camera in a semi-closeup, carrying the pumpkins. The little girl stumbles and falls, and begins to cry. Denny, ever alert, continued to shoot; worked into a closeup of the little girl in tears; to add materially to the sequence. Then he proceeded on, following the children as they walked toward the house where a man is prepared to transform the pumpkins into jack-o-lanterns. Gradually, Denny moved into the scene, until he finally captured in close-up, the cutting of the jack-o-lantern's eyes, nose, and mouth to form the face on the golden-yellow pumpkin.

"Song Of The Soil" is a fine example of good sequence building, due, as already stated, to Denny's flair for camera-editing, and also to careful cutting at the editing board. Not one scene is too long, and there are frequent changes in camera angle to make each sequence interesting. Another particularly noteworthy sequence was that of an elderly woman weaving. That considerable study was given to composition of the initial scene is at once apparent. The sequence opens with a medium long shot of the woman seated at the loom. Two lamps placed artistically at either side of her, greatly enhanced composition. Then in a succession of medium and closeup shots, and not a few changes of camera angle, we are shown the complete operation of the loom.

Generally speaking, the photography is exceptionally good. Exposure is uniform, and good composition is evident in every sense. Titling is well done. A folding "typewriter" titler was used. The cards were printed on letterpress and appropriate illustrations added to each with pen and ink.

"Most of this film," relates Denny, "was taken on trips during my vacation late last summer. I decided to make a picture of scenes and activities near home. All of the scenes were taken within a radius of five miles. During the time of filming, which covered approximately six months, I had a good many interesting experiences. My friends cooperated splendidly and it was quite a revelation

ORDER FOR SUBSCRIPTION

Home Movies Magazine

12 MONTHS FOR \$2.00 IN U. S.

In Canada, \$2.00; Foreign—\$3.00

SPECIAL OFFER: 3 Years for \$5.00 in the U. S.

HOME MOVIES

60 Sunset Blvd.

Hollywood, Calif.



Send to.....

Address

City..... State.....

New Renewal Gift

Send to.....

Address

City..... State.....

New Renewal Gift



Enclosed find \$..... Date..... 19.....

Sent in by.....

Address

City..... State.....

NO SUBSCRIPTIONS ACCEPTED FOR LESS THAN ONE YEAR





GOERZ KINO-HYPAR LENSES



f:2.7 and f:3
For regular and color movies of surprising quality—high chromatic correction...
Focal lengths 15mm to 100mm—can be fitted in suitable focusing mounts to Amateur and Professional Movie Cameras.



GOERZ Reflex FOCUSER

— Patented —

For 16mm Movie Cameras—voids PARALLAX between finder and lens—provides full-size ground-glass image magnified 10 times. Adaptable to lenses 3" and up. Also useful as extension tube for shorter focus lenses for close-ups. Extensively used in shooting surgical operations, small animal life, etc.



GOERZ Parallax-Free FOCUSER and FIELD FINDER CONTROL

No more off-center pictures, for Filmo 121 and Simplex-Pockette magnifies 4 and 8x.

For Detailed Information Address Dept. HM-7

C. P. Goerz American Optical Co.
317 East 34th St., New York
American Lens Makers Since 1899

the variety of interesting things which they could do to produce movie material."

"Song Of The Soil" is a splendid example of what can be accomplished with ordinary subjects and material in order to form an interesting movie. It is a pattern that might be studied and followed by those amateurs who sometimes hesitate to film a movie for competitive purposes believing it beyond their abilities and accomplishment. Denny's movie is, indeed, a repetition of proof—in unusual form perhaps—that the simple things are what make life worth while. Yes, and often the most delightful home movies.

fact, in all the southern states), California and Illinois, to make some pictures for me. I will supply film.

—James Y. D. Kim, Box 247, Wahiaua, Oahu, T. H.

Tell me how...

• Continued from Page 339

skating upon its miniature ice rink. The picture closes with scenes showing a couple riding through Central Park in a horse-drawn hansom cab—one of the few remaining landmarks of early day New York

Editing: Editing is well done. Scenes are kept right down to the minimum in footage for acceptable screening. Pictures of this kind can be dull if scenes run too long. At best, such scenes can be only impressionistic to those unfamiliar with New York City. Of note is the inter-cutting of close-ups of people walking, between long shots looking down the avenue.

Titling: A few more titles could be used especially after the picture gets beyond the first twenty or thirty feet, in order to explain location and details of many

Reader Speaks...

• Continued from Page 318

New York World's Fair in 1939. What is offered in exchange?

—Harold Georgens, 3622 205th Street, Bayside, L. I., New York.

Editors: Would you kindly publish the following in HOME MOVIES? I would like to contact some 8mm fans living in New York, Washington, D. C., Georgia (in

SOME PEOPLE LIKE TO PAY MORE

... because they think price is the only indication of value. Here's a case that proves the exception. It's KIN-O-LUX—embodying all the requirements for finer movie-making... comparable to other films selling many times higher.

Be convinced. Go to your dealer today and ask for



KIN-O-LUX No. 1 offers brilliancy, latitude, tonal fidelity and anti-halation backing. Scheiner 16; Weston 8. 100 ft. \$3.00

and

KIN-O-LUX No. 2 is fine-grain, semi-chromatic and has greater speed and wider latitude than No. 1. Scheiner 18; Weston 12. 100 ft. \$3.50

for

OUTDOORS

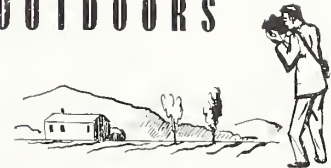

KIN-O-LUX No. 3 supersensitive over the entire range of the visible spectrum. Preferred by movie-makers for performance and an ultimate perfection that cannot be surpassed. Daylight Emulsion Speeds: Scheiner 26; Weston 50. Tungsten Speeds: Scheiner 24; Weston 40. 100 ft. \$6.00 50 ft., \$3.50

for

INDOORS



All film prices include processing, scratch-proofing and return postage

Write for Booklet M7

KIN-O-LUX
16 MM REVERSAL FILM
KIN-O-LUX, INC.
105 W. 40th ST., N. Y. C.

DON'T WAIT!

Get Acquainted NOW with the **A-B-C**

of Dependable 16mm Reversal Film

- PEERLESS A—A reliable high-grade outdoor film. Moderately priced, yet superior in rendering high-quality results. Weston 6, Scheiner 16.....\$2.00
- PEERLESS B—A non-halation base outdoor film. More highly sensitive than Peerless A, yielding excellent results. Weston 12, Scheiner 18.....\$2.75
- PEERLESS C—A perfectly balanced panchromatic fine grain film for indoor or outdoor use. Thoroughly non-halation, producing brilliant pictures. Weston 24-16, Scheiner 23-21.....\$3.50
- PEERLESS CX—This high speed film is absolutely essential under poor light conditions and is especially recommended for indoor work when best possible results are desired with insufficient lighting. Weston 32, Scheiner 24.....\$4.50

All items above supplied on 100 feet daylight loading spools.

Above Prices Include Processing and Postage

Complete Professional Laboratory Service for the Amateur Movie Maker

All Prices Apply to Finished Film Per Foot

- 35mm Negative to 16mm Positive.....\$.03
- 35mm Positive to 16mm Positive......04
- 35mm Positive to 16mm Negative......05
- 16mm Negative to 16mm Positive......025
- 16mm Positive to 16mm Positive......035
- 16mm Negative Developed......015
- 16mm Positive Developed......01

Minimum Charges on Any Above Order, \$1.00

- 16mm Negative to 8mm Positive......03
- 16mm Positive to 8mm Positive......04
- 16mm Positive to 8mm Negative......06

Minimum Charge on Any Above Order, \$1.50

- 8mm or 16mm Panchromatic Reversed (100 ft. or less).....\$1.00
- 8mm or 16mm Ortho, Reversed (100 ft. or less)......75

FREE BOOKLET RS—Our specially low priced list of laboratory packed film.

Write for **BOOKLET FL**—Our complete list of 8mm and 16mm library subjects for sale or rent. Sound or silent.

Peerless Camera & Film Service
7-11 West 45th Street NEW YORK CITY
11 River Drive PASSAIC, N. J.

Movie of the Month

Each month the Editors of HOME MOVIES select the best picture sent in for analysis and designate it "The Movie of the Month." This movie is given a detailed review and a special leader is awarded the maker.

This award does not affect the eligibility of such films for entry in the annual HOME MOVIES CONTEST. They are automatically entered for rejudging with those films submitted especially for the annual contest. Films awarded the honor of MOVIE OF THE MONTH during past 12 months are:

1939

AUGUST: "New England Holiday," produced by Albert Watts, Buffalo, N. Y. 8mm Kodachrome picture, 800 ft.

SEPTEMBER: "Within the Garden Gates," produced by Murray Beliz, Sacramento, Calif. A 200-ft. 8mm Kodachrome film.

OCTOBER: "Hummingbirds," filmed by Richard L. Cassell, D.D. S., Los Angeles, Calif. A 16mm Kodachrome film, 400 ft. in length.

NOVEMBER: "Esquire's Escape," produced by Clarence M. Aldrich, Long Beach, Calif. A 16mm picture 800 ft. in length.

DECEMBER: "Souvenir," produced by Harold E. Remier, Hollywood, Calif. A 100-ft. 8mm Kodachrome film.

1940

JANUARY: "The Cauldron," produced by Dr. R. E. Gerstenkorn, Beverly Hills, Calif. A 16mm picture 400 ft. in length.

FEBRUARY: "Whistling Wings," produced by W. H. Nordin, Austin, Minn. A 16mm Kodachrome picture, 400 ft. in length.

MARCH: "Checking Off the Budget," produced by B. W. Johnson. An 8mm Kodachrome film, 1000 feet in length.

APRIL: "El Lobo," produced by Demetris Emanuel. A 16mm picture, 400 feet in length.

MAY: "From A to Z," produced by Vernon Altree, Stockton, Calif. A 16mm Kodachrome film, 400 feet in length.

JUNE: "Peetie," produced by Edmund Turner, Detroit, Mich. A 16mm Animated Cartoon, 400 feet in length.

JULY: "Song of the Soil," produced by E. C. Denny, Buffalo, N. Y. A 16mm Kodachrome film, 800 feet in length.

PHAOSTRON
ELECTRIC EXPOSURE METER
For Slides or Movies
Ask your dealer, or write:
PHAOSTRON CO. • ALHAMBRA, CALIF.

Bass proudly displays his rabid interest in this new



RCA 16MM SOUND PROJECTOR
750 watt lamp, 10 watt output; input jack for mike or records; lifelike reproduction; easily portable; F1.65 lens; take up and rewind for 400, 800, 1200 and 1600 ft. reels. A beautiful precision job, for silent and sound; \$300

WRITE FOR FREE LITERATURE
The above is a fit companion to our famous
RCA 16MM SOUND ON FILM CAMERA

Gets professional results; hundreds of satisfied users.
NEWSREEL MODEL: With 1 in. F.3.5 lens, batteries, ready to use **\$250**

COMMERCIAL MODEL: Motor drive, three-stage amplifier, complete **\$965**



Write for New Free CINE BARGAINGRAM No. 245

Bass CAMERA CO. Dept. H. M.
179 W. MADISON ST. CHICAGO, ILL.

CORONA 8MM 16MM
BETTER REVERSIBLE FILMS
16MM 100 FT.

Corona Semi-Ortho \$2.00
(Weston Day 8, Tung 2)

Corona Super-Ortho Anti-Halo \$3.70
(Weston Day 16, Tung 6)

Corona Super Pan Anti-Halo \$4.00
(Weston Day 24, Tung 16)

Films spooled for daylight loading. Above prices include processing and return postage.

SAVE \$\$\$
WITH GEVAERT FILM IN BULK
Double 8 Scored and 16mm

PANCHRO SUPER REVERSAL, ANTI-HALO
Weston 100 Ft. 2 Rolls
16mm \$3.15 \$6.00
24-16 \$3.50

ORTHO REVERSAL, ANTI-HALO
16mm 16-6 \$2.80 \$5.25
Double 8 16-6 \$3.00

PANCHRO MICROGRAN, ANTI-HALO
Weston 12-8 - Same price as Ortho Reversal.

CORONA SEMI-ORTHO - WESTON DAY - 8
(Double 8 Scored or 16mm)

100 ft. \$1.25 400 ft. \$4.00
Bulk prices do not include processing. Test strip service up to 10 ft. 25c. Write for special club offer.

REVERSAL PROCESSING - 16MM and 8MM
100 ft. 85c 50 ft. 65c 25 ft. 50c

All Orders Shipped Postpaid Except C.O.D.
CORONA FILM LABORATORIES
200 East 34th St. Brooklyn, N. Y.

THALMETAL TRIPOD for VALUE
When you buy a Thalmetal Tripod you get a lot for your money. Metal and wood construction—all standard Thalhammer features—economically priced at \$14.00. Ask your dealer today.



THALHAMMER COMPANY
1015 W. SECOND ST., LOS ANGELES, CALIF.

EDIT AND TITLE YOUR FILMS AT ZENITH CINEMA SERVICE
5011 North Sawyer Ave., Chicago
Complete stock of home movie equipment—new and used. Large selection of film subjects to rent. Write for free catalog.
"The Home of Movies"

REDUCTIONS ENLARGEMENTS DUPLICATES



GEO. W. COLBURN LABORATORY
1197 MERCHANDISE MART CHICAGO

BRITELITE - TRUVISION
America's foremost line of motion picture screens, spotlights, reflectors, paper safes, etc.

Write for complete details.
MOTION PICTURE SCREEN AND ACCESSORIES CO., INC.
351 West 52nd St., New York City



of the scenes that follow. While there are quite a number of titles in this picture, still there is a feeling of let-down about the middle of the picture because of lack of titles at this point.

Photography: A good job with the camera with a nice average of good exposures and frequent change of camera angles keep the viewer interested until the end. Evidently this filmer knew that filming a subject of this kind from the same sort of camera set-up throughout, would make a dull picture. Variety proved the spice of the picture.

Equipment: Cine Kodak "60"; tripod; and meter.

"SANDY CAT'S TALE" ★★★
400 ft. 8mm Kodachrome — By A. W. M.

Continuity: Story interest was built up in this picture by the simple expedient of introducing a cat—"Sandy"—early in the picture and having it speak the descriptive titles which are plentiful throughout the picture. The cat relates how it was adopted into the family, and then describes the many doings and escapades of members of the family, not infrequently touching upon the personal history or idiosyncrasies of each. Also, scenes are introduced in which the cat does not appear at all, such as of outings or of the baby, merely by a continuation of the spoken titles.

The idea of having the cat tell the story is novel

in itself and adds interest. Through this medium, it was possible to cut in scenes of many kinds that might otherwise seem irrelevant to the picture.

Editing: As editing a picture of this type must be carefully done in conjunction with smart titling, it is a credit to this filmer that he did an excellent job in this department.

Titles: Titling technique has already been described. The title cards were very neatly composed, with white letters over a patterned orange-colored background. Exposure was very good.

Photography: This filmer was a little off on his exposure in several instances, excusable perhaps, when one considers how elusive cats can be when one tries to film them. Invariably they move outside the range of lights just as the camera is started. Noticeable, too, was the fact camera was a bit unsteady at times.

Information please

• Continued from Page 320

tact, we would strongly recommend turning the job over to someone more experienced in working over cine cameras, such as Philip Baia, or the McVan Manufacturing Company, the addresses of which we shall be glad to supply upon request.

Exposure Meter Guide

CORRECTED JUNE 1, 1940

	SCHEINER		WESTON OR GE			SCHEINER		WESTON OR GE	
	Day	Mazda	Day	Mazda		Day	Mazda	Day	Mazda
AGFA					GEVAERT				
16mm SSS Pan.	29	27	100	64	Super Reversal.	23	21	24	16
16mm Hypan.	24	23	32	24	Panchro.	20	18	12	8
16mm Panchromatic.	21	20	16	12	Ortho.	21	17	16	6
16mm Supreme Pan. Neg.	27	25	64	40	GENERA				
16mm Finopan Neg.	23	21	24	16	Meteorpan.	23	21	24	16
16mm Positive.	12	8	3	..	Normal Panchromatic.	20	18	12	8
16mm Plenachrome.	20	..	12	..	Super Ortho.	21	17	16	6
8mm Twin-8 Hypan.	23	21	24	20	Movetone Ortho.	19	13	10	3
8mm Filmopan.	18	16	8	5	Semi-Ortho.	18	12	8	2
DUPONT					KIN O LUX				
Reversal Pan.	21	19	16	10	No. 1.	16	..	6	..
Regular Pan Neg.	20	18	12	8	No. 2.	18	16	12	..
Superior Pan Neg.	24	21	32	20	No. 3.	26	24	50	40
Positive.	12	..	2	1-6	CONSUMERS				
EASTMAN					Ortho.	18	..	8	..
16mm Super XX Pan.	100	64	Panchro.	23	21	24	16
16mm Super X Pan.	24	23	32	24	Colorchrome.	18	..	8	..
16mm Safety.	20	18	12	8	HOLLYWOOD				
16mm Sound Pan.	23	21	24	16	S. S. Pan.	26	25	50	40
16mm Pan. Negative.	23	21	24	16	Pan.	21	20	16	12
16mm Positive.	16	10	5	3	Semi-Ortho.	18	12	8	2
8mm Super X Pan.	23	21	24	16	UNIVEX				
8mm Regular Pan.	18	16	8	5	Standard.	17	14	6	..
Kodachrome (8 & 16mm).	18	14	8	3*	Ultrapan.	20	18	12	6
Kodach. "A" (8 & 16mm).	18*	21	8*	12					

*With filter.

Good Movies at Low Cost!
"OATEO"
"REVELATION"
8mm—MOVIE FILM—16mm

REVELATION No. 1—Weston 12—Scheiner 20. SEMI-ORTHO—FINE GRAIN. A better, non-halation outdoor film. Provides wide latitude and softness—sharp, clean, professional quality pictures.

30 ft. single 8mm \$.75 each
25 ft. double 8mm 1.25 each
50 ft. 16mm 1.50 each
100 ft. 16mm 2.50 each
5 rolls or more each item, 10% discount.

Reversal Processing and Postage Included

REVELATION No. 2—Weston 50—Scheiner 26. PANCHROMATIC. A super-sensitive, non-halation film—fine grain, extremely high speed. Clear, beautiful pictures, either indoors or out. Color balanced.

30 ft. single 8mm \$.85 each
25 ft. double 8mm 1.75 each
50 ft. 16mm 2.25 each
100 ft. 16mm 4.00 each
5 Rolls or More Each Item—10% Discount

Reversal Processing and Postage Included

For Economical Outdoor Film
"Sun Amber"—16mm
A Reversible Safety Film—Weston 6
50 ft. 16mm \$1.00 per roll
100 ft. 16mm 2.00 per roll

Reversal Processing and Postage Included

POSTPAID—ORDER NOW—C. O. D. orders, postage extra. Remit 1/3 with C. O. D. orders. (Calif. buyers include sales tax.)

SAVE MONEY—LOAD YOUR OWN
8mm—BULK FILM—16mm
PRICES ON REQUEST

PACIFIC COAST FILM CO.
1510 N. Sierra Bonita Hollywood, California

NEED A SPOTLIGHT?



Here's your chance to buy an adjustable professional spotlight in black crackle finish—fine looking unit with adjustable professional utility floor stand for only \$7.50. Unit comes complete with money-back guarantee with the exception of a 250-watt bulb.* Send your check, money order or \$7.50 today and spotlight will be shipped immediately postage prepaid.

*Bulb is \$1.40 extra.

RICH MFG. CO.
Photographic Supplies & Equipment
364 Atlantic Ave. Boston, Mass.

8mm SLITTER
Slits perfectly 16mm width film to exact 8mm width. Die cast body with hardened steel cutting wheels. New price, each, \$2.50.

DEVELOPING RACKS
Stainless steel, take 30 feet 16mm or 8mm width film. Can be used in 11x14 or 8x10 flat trays respectively. Complete with loading stand, each, \$6.75. Specify type wanted.

At Your Dealer's or Direct
J. C. Haile & Sons
Motion Picture Dept.
215 Walnut Street Cincinnati, Ohio

Special Constructions
TO HELP YOU MAKE UNUSUAL MOVIES THIS SUMMER
Backwinds — Frame Counters — Magazines for Greater Film Capacity
Single Frame Release Attachments
Reconditioning and Repair on All Movie Cameras and Projectors
MERCURY MOVIE EQUIPMENT REPAIR CO.
1133 Broadway, N. Y. Chel. 2-5962

Use **GENERA** PDQ REVERSAL PROCESSING POWDERS
Reverse your Films for Projection—Anyone can do it.
Clearing 25c; Hardener 15c; Set, postpaid, \$1.20.
No. 2 set—1 gal. size: PD12 Developer 95c; Bleach 25c; Clearing 40c; Hardener 25c; Set, postpaid, \$1.85.
Simplified Processing Outfits including our Prepared Powders: For 35mm and 8mm, \$3.35, postpaid; 16mm, \$4.95, express. Instructions included.
Reducing Powders for dense films, 1 gal. size, 35c
Write for FREE CATALOGUE and Bulk Film Prices

FROMADER GENERA PRODUCTS, Davenport, Iowa

CLEAN FILMS PROJECT THE BEST PICTURES



Use Our Dry Film Cleaner—Price \$3.95 Postpaid
FISHER MFG. CO.
17 Main St. E. Dept. 61-V Rochester, N. Y.

TITLE Backgrounds

By EDMUND TURNER

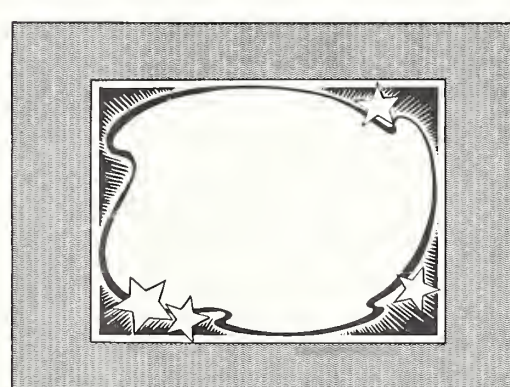
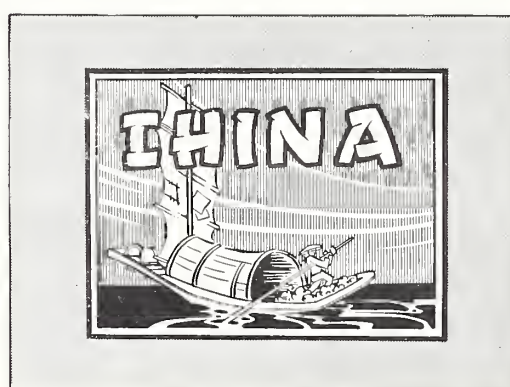
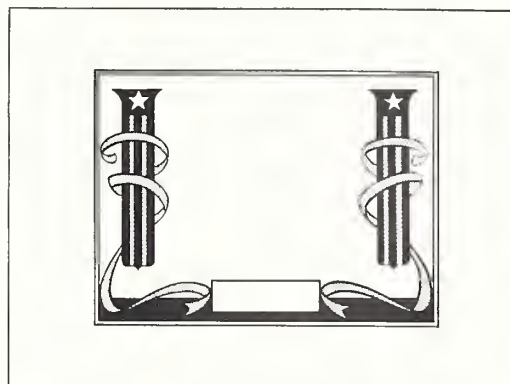
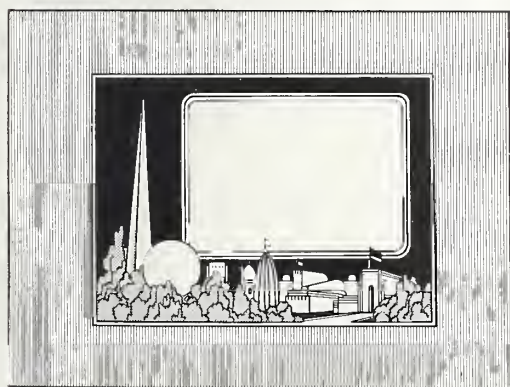

WITH travel and vacation filming now in full swing, we present this month a number of titles designed to meet the requirements of our readers at this time. Starting out with a title for the month of July, we find this one appropriate for a caption of one's miscellaneous filming activities for this month.

The title "Music" is one that might be used in a number of ways—for a movie depicting playing of musical instruments, a short on the history of music, and of course a scenic film scored to music. The title for Yellowstone Park will probably meet the needs of the greatest number of cinebugs. Yellowstone is the mecca of thousands of cameraists each summer and many fine home movies are made here.

The fourth title card is appropriate for descriptive titles for New York World's Fair films, while the fifth is one that will be welcomed by every cinebug whose film shows extend beyond one reel of film.

Title number six is the main title for World's Fair films. The letters have been left open to allow for tinting or coloring. The next title background is suitable for sub-titles of almost any type of home movie films. Those whose travels have carried them to China and of course who returned with movies of this interesting land will find use for the next title. And after the particularly decorative sub-title card that follows, is another "end" title, of which amateurs cannot have too many.

HOME MOVIES welcomes suggestions from its readers regarding other title backgrounds, the size and arrangement of the backgrounds as they are published now, or any ideas that might improve this service to the amateur movie maker.

CLASSIFIED

ADVERTISING

EQUIPMENT FOR SALE

● BASS SAYS: Independence of worry when you buy from BASS. Money-back guarantee.

USED CAMERAS

8mm Bolex, latest model with Plasmat F:1.9, focusing mount, \$195.00.
16mm Simplex Pockette Magazine, Ilex F:3.5 lens, \$22.50.
16mm Cine Kodak Model B, F:3.5 lens, \$22.50.
16mm Cine Kodak Model M, F:3.5 lens, \$24.50.
16mm Filmo 75, 100 foot, Cooke F:3.5 lens, \$29.50.
16mm Cine Kodak Model K, F:3.5, focusing, \$39.50.
16mm Simplex Pockette, F:1.9 Kodak lens, focusing mount, \$55.00.
16mm Cine Kodak Model K, F:1.9, focusing, \$60.00.
16mm Cine Kodak Magazine, F:1.9 lens, focusing mount, \$82.50.
16mm Movikon 16, Sonnar F:1.5 lens, \$257.50.
16mm Cine Kodak Special, latest model, 1-inch F:1.9 lens, \$307.50.

LENSES

1" Bausch & Lomb F:1.9 Tessar, focusing C mount, \$20.00.
1" Berthiot Tele F:1.9, focusing C mount, \$32.50.
1 1/2" Wollensak F:3.5 for Bell & Howell 8, \$34.50.
2" Berthiot Tele F:3.5, focusing C mount, \$25.00.
3" Berthiot Tele F:3.5, focusing C mount, \$35.00.
3 3/4" Cooke F:3.3, focusing A mount and filter, \$55.00.
4 3/4" Carl Zeiss Tele-Tessar F:6.3, focusing C mount, \$37.50.
6" Dallmeyer F:4.5 telephoto, A mount, \$37.50.

FADE-OUTS AND EFFECTS

Fadette, fits most lenses, complete \$5.95.
Bool-Fader, a big seller, complete 64 effects, \$17.50.
Fade-O-Scope, a new polaroid fader, \$18.75.

USED PROJECTORS

16mm DeVry Model C, 250-watt, motor drive, \$18.75.
16mm Kodascope Model A, 200-watt, \$22.50.
16mm Keystone A-S1, 750-watt, \$44.50.
16mm Kodascope EE, 750-watt, \$44.50.
16mm Ampro Model A, 400-watt, complete with case, \$45.00.
16mm Bell & Howell Model 57G, 250-watt, with case, \$45.00.
16mm Bell & Howell Showmaster, 1600-foot reels, 750-watt, with case, \$135.00.

SOUND PROJECTORS

The new RCA 16mm S. O. F. Model PG, 170, 750-watt, complete, \$300.00.
The new Revere Double 8 Camera with F:3.5 lens, \$29.50.
New Revere Double 8 Turret Camera with F:2.5 lens, \$65.00.
New Revere Double 8 Model B Projector, 500-watt, \$59.50.

UP-TO-THE-MINUTE-TEXT-BOOKS

Home Processing, all necessary information, by Harris, postpaid, \$2.00.
How to Title Home Movies, postpaid, 50c.
Trick Effects with the Cine Camera, postpaid, \$1.00.
Exposing Cine Film, \$1.00, postpaid.
Ideas for Short Films, \$1.00, postpaid.
The new 72-page Bass Cine Bargaining No. 245 will be ready soon. Largest Cine catalog in the world. Mail name for copy.

BASS CAMERA COMPANY

Dept. HC 179 W. Madison St., Chicago, Ill.

● FULL LIST PRICE ALLOWED FOR: Eastman Model 20 toward a new Bell-Howell Sportster. Kodascope EE toward Bell-Howell Filmo-Master. Filmo-Master 16mm projector toward Bell-Howell Filmosounds. Eastman 8mm Model 25 or Bell-Howell Sportster toward a Bell-Howell Turret or an 8mm Bolex. 500-watt Keystone toward a new Bell-Howell 8mm projector. Bell-Howell Sportster with Wind-Bak, \$75. Bell-Howell Companion with Wind-Bak, \$49.50. Bell-Howell Turret with Wind-Bak, \$129.50. \$369 Bell-Howell Filmosound, factory new guarantee, \$250. Eastman Model B1.9 100' 16mm camera, \$42.50. Eastman Magazine f:1.9, \$75. Eastman Model 50 Kodascope, \$25. \$215 Eastman Model L, 750-watt lamp and case, \$79.50. 1" f:1.3 Laack lens, \$39.50. 15mm f:1.5 Dallmeyer lens, \$49.50. 16mm Bolex, Hektor f:1.4 lens and case, \$175. 3" f:4 Wollensak lens, \$29.50. 30x40 beaded screen with tripod, \$7.95. 36x48 beaded screen with tripod, \$10.50. 39x52 beaded screen with tripod, \$12.50. USED: Victor Model 24-B sound projector, \$97.50. 16mm Ampro, silent, 750-watt Model K, 1600' arms, \$97.50. Hundreds of other bargains. Write NATIONAL CAMERA EXCHANGE, established 1914. 11 So. 5th St., Minneapolis, Minn.

● 16mm CONTINUOUS Sound and Picture Printer; also prints double-8. In perfect condition, \$225.00. BOX 10, HOME MOVIES, 62 W. 45th St., New York City.

● Ten cents per word; minimum charge, \$2.00 cash with order. Closing date, tenth of preceding month. ● HOME MOVIES does not guarantee goods advertised.
● Send ads to 6060 Sunset Boulevard, Hollywood, California.

EQUIPMENT FOR SALE

● MOVIE CAMERAS

Filmo 70-D turret (black), f:3.5 \$90.00
Filmo 70-D turret (black), FF f:3.5 Zeiss WA, 4" Zeiss telephoto FF 1" f:3.5 \$153.00
Victor 4 turret (brown), \$95, 3-year factory guarantee \$64.75
Victor 5 turret (black) with f:1.9 \$85.95

USED SOUND PROJECTORS

Complete, ready to run, fully guaranteed.
RCA 500W, reg. \$400.00 \$ 98.50
RCA 750W, Senior, output 18W, reg. \$575.00 \$195.00
Victor 24C, 750W, output 15W, reg. \$565.00 \$224.75
Victor 25 AC-DC, 750W, output 8W, reg. \$410.00 \$159.00
Mogull-Duplex, like new demonstrator, reg. \$410.00 \$260.00

PROJECTOR SPECIALS

16mm \$98 DeVry, professional quality \$ 27.50
8mm Filmo, like new \$ 79.50
16mm (\$10) Excel, BRAND NEW, motor driven \$ 3.49
Victor 22, 1600-ft. demonstrator, reg. \$175.00 \$109.50

SCOOP!

New Copies New York School of Photography Home Course on Professional Motion Picture Operation and Projection, 60 lessons, complete with charts, diagrams, reg. \$38.00 \$3.95

MOVIE PRINTER

16mm Step Printer, with motor, 400-foot capacity, perfect condition, was \$200.00 \$88.00

FILM RENTAL LIBRARY

1940 edition 16mm Silent Catalog, just off press!
1940 additions 16mm Sound Library now ready! Copies Free!

EXTRA!

Full list allowed for Cine Kodak 20 on purchase of new Filmo Sportster!

EASY PAYMENTS

\$1.00 down buys any new or used item. Balance in small monthly payments.
MOGULL'S, 55 West 48th, New York

EQUIPMENT FOR SALE

● PRACTICALLY new 16mm Bell & Howell "Diplomat" model projector, cost \$198.00. Will sacrifice for \$140. GERRIT LOKKER, 32 East 19th St., Holland, Mich.

● VICTOR Model 36 sound projector, like new. List price, \$345.00. Only \$200.00 cash. E. M. STEACY, 3675 Clay St., San Francisco.

● BOLEX—brand new Model H—8mm with Meyer Kino-Plasmat f/1.5 lens, \$189.50. FLANAGAN, 5 Richardson St., Providence, R. I.

● LATE MODEL slightly used 8mm Bell & Howell, turret, with Cooke lens. Will sacrifice for cash. G. J. GLUPKER, 45 East 21st St., Holland, Mich.

● TELEPHOTO for Keystone or Filmo 8mm, 1" f/3.5 Wollensak, \$19.95; 1" f/2.7, \$29.95; 2" f/3.5, \$34.50; Berthiot 1 1/2" f/3.5, \$26.50; 1" f/1.9, \$34.50; Keystone 8mm camera with windback, f/3.5, \$34.50; f/2.7, \$39.95; f/1.9, \$59.50. CUSTOM-BUILT CAMERA ACCESSORIES COMPANY, 4124 Rawlins, Dallas, Texas.

PROCESSING SERVICE

● 8mm DUPLICATES, 3c ft. Intensifying, reducing, 2c ft. Processing 8-8, 40c. Single 8, 25c. CINE-FOTO, 128 Wilson, Springfield, Ohio.

ACCESSORIES

● BUILD 16mm Continuous Printer. Complete drawings, \$1.00. LOUIS L. KAHL, 77 N. Elm St., Wallingford, Conn.

● MOVIE Cameras, Films, Projectors, etc., bought, sold, and exchanged. Big lists Free. Art samples, 25c. PEERLESS, Box 1310-H, Hollywood, Calif.

● 8mm-16mm MOVIE Equipment, bargains. Art sample, 10c. Lists Free. Write wants to EDCCO, 199 West Broadway, Paterson, N. J.

● MOVIE MAKERS! Process your title and reversal film. Equipment, chemicals, instructions—30' capacity double 8 or 16—\$2.95, express. ROYCRAFT CO., Box 1810, Milwaukee, Wis.

ACCESSORIES

● RENT A CAMERA, projector, lights, lenses, tripods, for all 8-16-35mm movie production. 16mm Sound RCA, Cine Special, all finest equipment for rentals by day, week, or long term. We buy, sell, exchange all motion picture equipment, new or used—Bell & Howell, Eastman, Victor, Keystone. Closing out still cameras, supplies, accessories. Write for Bargain Bulletin. CAMERA MART, Dept. G, 70 West 45th St., New York City.

● TELEPHOTO Lens Special! List \$50.00, 1-inch F/1.5 for Keystone, Revere, Cine 8 cameras. Bargain price, \$12.50. MALENA CO., 616 Market St., Philadelphia, Pa.

FILM RELEASES (8 and 16mm)

● EXTRA SENSATIONAL—Latest release: "Bombs Over Europe!" in 8mm-16mm. Complete rental library. Prompt delivery. Films rented everywhere. Trades accepted. Bargains in silent and sound projectors. Free illustrated catalog (with sample art film 10c). GARDEN FILM SERVICE, 317 West 50th St., New York City.

● SOUND AND SILENT films exchanged, bought, rented, sold. Bargains always. New free lists. FRANK LANE, 5 Little Bldg., Boston, Mass.

● WRITE FOR our new 8mm rental catalog Films shipped everywhere. No extra charge for shipping. We pay both ways, express or parcel post. ABBE FILMS, 1265 Broadway, N. Y. City.

● A REAL Opportunity! Closing out a number of 16mm sound and silent films at very attractive rates. Send for list today. INSTITUTIONAL CINEMA SERVICE, INC., 1560 Broadway, New York City.

● LATEST 8-16mm Professional releases. 8mm films rented and exchanged. NIAGARA HOME MOVIE SUPPLY, 360 Auburn Ave., Buffalo, New York.

FILMS

● 8mm-16mm FILMS, Bulk and Processing. Full line of movie equipment, cameras, projectors, bargains! R. C. CAMERA PHOTO SUPPLY, 3357 East 66th St., Cleveland, Ohio.

● MOVIE SHOP Special—100 ft. 16mm Rapid outdoor film, including processing, \$1.95. Free Lists. MOVIE SHOP, 838 Broadway, Bayonne, New Jersey.

ENLARGING SERVICE

● ALL 16mm positive frames enlarged to 2 3/4"x3 3/4" negative and printed. Minimum order, four frames, 60c. Each additional, 13c. Each order of eight receives two 5"x7" enlargements Free! Mail 100-ft. rolls, mark frames with thread. LUSTIG'S, 800 Eighth Ave., New York City. All postpaid.

TITLING SERVICE

● ANIMATED Cartoon Titles, Title Cards, Sepia Toning. Send for Catalog. NATIONAL MOVIE SERVICE, 1461 S. W. 1st St., Miami, Fla.

● 8mm TITLES by Lamar. Stock and custom-made titles. Free catalog. (Dealers' inquiries invited.) RIEDEL FILMS, 2221 W 67th St., Cleveland, Ohio.

MISCELLANEOUS

● BACK ISSUES "Home Movies" magazine—January, February, March, April, and May, 1940—25c per copy while supply lasts. HOME MOVIES, 6060 Sunset Blvd., Hollywood, Calif.

BOOKS

● Are you a "beginner" in the ranks of amateur movie makers? Would you like to know how to use your camera to the very best advantage, yet avoid the mistakes and wasted film that so often results from lack of knowledge of fundamentals of cine camera operation? Then order a copy of "How to Use a Movie Camera." Just 50c, and well worth it.

Would you like to learn how to process your own movie film so that you can buy inexpensive film in bulk? Let us send you "How to Process Home Movie Film," a book chock full of instructions and advice by experts plus complete, easy-to-understand plans for building your own simple processing equipment. Sent postpaid for 50c.

Would you like to know how to make your own titles? What equipment to use—what exposure to use—all about auxiliary lenses—title areas, etc.? Would you like complete plans for building a very simple and versatile home movie titler? Then send for "How to Title Home Movies"—the latest and one of the most authentic books ever written on the subject. Price, \$1.00 per copy. We pay the postage.

VER HALEN PUBLICATIONS

6060 Sunset Blvd. ● Hollywood, Calif.

MOVIE CLUBS

Order One of These Handsome Binders For Your Club's Issues of HOME MOVIES!

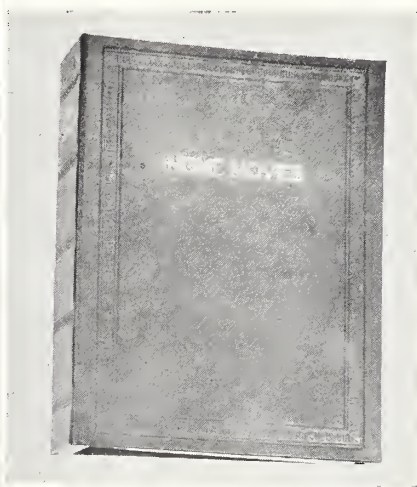

Holds twelve issues of the "new" HOME MOVIES magazine, each of which may be easily inserted or removed. Insures against loss and mutilation of pages. A welcome addition for your club library.

\$1.25

Postpaid

HOME MOVIES

6060 Sunset Boulevard

Hollywood, California

When you want to know **HOW!**

THERE'S so much satisfaction in movie making when you have books that tell you how to do a thing — that answer the numerous problems present in filming, processing, editing, and titling home movies. Here, indeed, are the very books every cinefilmer needs.



A new handbook for the beginner. Takes up where your camera instruction book leaves off. Contains essential data on fundamentals of making good home movies, boiled down in one small, easy-to-read volume. Makes clear the use of lenses, threading of camera, setting exposure, correct focusing, etc.; points out mistakes to avoid. Per copy.....

50c

The leading textbook for the amateur on reversing home movie film. Over 5000 copies sold to date! Illustrates and describes how to build home processing equipment; gives all the popular reversal formulas; and tells how to intensify or reduce over- or under-exposed films. Get this book today and start processing your own films. Per copy.....



50c



The latest, most complete book on titling home movies, which includes complete plans for building the renowned Home Movies Titler, Title Area Chart, Lighting Chart, Diopter Lens Chart, How to Make Trick Titles, Data on Use of Shims for ultra-closeups, etc. Approximately 100 pages jam packed with vital information. Per copy.....

\$1.00

Title Backgrounds



Put class into your titles with these artistic printed title cards. 25 titles—each one different—designed especially for "typewriter titlers." Cards for main, credit, and end titles. Choice of two assortments: No. 1, for Black and White movies; and No. 2 for Kodachrome. Be sure to specify! 25 cards for.....

50c

If your dealer cannot supply you with any of these books or title backgrounds, send your order, together with check or money order, direct to

VERHALEN PUBLICATIONS

6060 SUNSET BOULEVARD

HOLLYWOOD, CALIFORNIA

Get there

with a

Ciné-Kodak TELEPHOTO



In the line-up of six lenses are, left to right, the 76 mm. (3 inch) $f/4.5$, price \$38.50; the 50 mm. (2 inch) $f/1.6$, price \$80; the 114 mm. ($4\frac{1}{2}$ inch) $f/4.5$, price \$53.50; the 63 mm. ($2\frac{1}{2}$ inch) $f/2.7$, price \$53.50; the 152 mm. (6 inch) $f/4.5$, price \$78.50; and the 102 mm. (4 inch) $f/2.7$ lens, price \$68.50. In the row of three units are the standard 25 mm. (1 inch) $f/1.9$, the accessory lens adapter for Magazine Ciné-Kodak, price \$6.50; and the 15 mm. $f/2.7$ focusing wide-angle lens, price \$47.50.



LEAP over the crowd, over the side lines and into the heart of the action for thrilling close-ups . . . close in on camera-shy subjects from afar . . . don't let distance defeat you; make an asset of it.

With a Ciné-Kodak telephoto or long-focus accessory lens, the scope of your movie making is importantly widened. For you have not only the "seven league boots" of cinematography; you have a lens of superb quality and workmanship. Your telephoto shots are clear, crisp, and beautiful as well as far-reaching.

For the famous 16 mm. Ciné-Kodaks—Magazine Ciné-Kodak and Model K—there are six available long-focus lenses and a 15 mm. wide-angle lens. For Ciné-Kodak Eight, Model 60, there's a $1\frac{1}{2}$ -inch telephoto. And for the Magazine Ciné-Kodak Eight, there are five long-focus lenses, available as accessories.

Select a Ciné-Kodak accessory lens and begin your conquest of a whole new world of movie-making opportunities.

EASTMAN KODAK COMPANY
ROCHESTER, N. Y.

AUG -5 1940

©CIB 463584



★ Shot of the Month...

home MOVIES

Copyright 1940 by Ver Halen Publications. No part of magazine may be reprinted without specific permission.

CONTENTS FOR AUGUST, 1940

RAY MERVILLE—IN MEMORIAM.....	362
THE READER SPEAKS.....	364
WITH THE PRO-16'S.....	366
PERSPECTIVE AND BALANCE CHIEF FACTORS IN GOOD COMPOSITION By Count H. C. A. Von Schoenfeldt, A.R.P.S.	369
CLUB'S CINEMATOGRAPHY COURSE IMPROVES MEMBERS' TECHNIQUE.....By Dr. A. K. Baumgardner	370
CHICAGO CINEFAN'S HOME THEATRE TOPS THEM ALL! By W. F. Scranton	372
RUNNING GAGS AND TIE-IN SHOTS MAKE VACATION FILMS COMPLETE.....By Ray Fernstrom	374
VARY CAMERA SPEED FOR TRICKS, SMOOTHER ACTION By Stanley E. Andrews	376
TITLE COMPOSITION SIMPLE AS A, B, C!...By George W. Cushman	377
TITLE CENTERING GUIDES FOR FILMOS.....	378
HOMEMADE GADGETS FOR FILMING UNDER WATER By S. J. Williams	379
LET'S GET ACQUAINTED WITH OUR CAMERA LENS! By R. S. MacCollister	380
PLANS AND DATA FOR BUILDING THE "GLORIFIED 16" By Arthur H. Hart	381
SKI PICTURE—MOVIE OF THE MONTH.....By J. H. Schoen	382
TELL ME—HOW CAN I IMPROVE MY FILM?..Reviews by the Editors	383
EXPERIMENTAL CINE WORKSHOP.....	384
IT'S NEW TO ME!.....	386
EXPOSURE METER GUIDE.....	391
TITLE BACKGROUNDS.....	399

★ Shot of the Month—A nice study in composition by Walter P. Downs, Montreal, Canada.

CHAS. J. Ver HALEN
PUBLISHER

C. J. Ver HALEN, JR.
ASSOCIATE PUBLISHER

ARTHUR E. GAVIN
EDITOR

OFFICE OF PUBLICATION
6060 Sunset Boulevard, Los Angeles, Calif.
Phone GRanite 5149

NEW YORK OFFICE
Everett Gellert, 62 West 45th Street
Vanderbilt 6-5254

CHICAGO OFFICE
C. N. Burris, 712 Wrigley Building
Whitehall 7784

RAY FERNSTROM
Technical Editor

GEORGE W. CUSHMAN
J. H. SCHOEN
Associate Editors

COUNT H. von SCHOENFELDT
Photographic Editor

C. E. BELL
Associate Photo Editor

L. C. BUSCHER
Art Director

ADVISORY EDITORS

GEORGE BURNWOOD
The 8-16 Movie Club, Phila., Pa.

JAMES BIALSON
Amateur Motion Picture Club of St. Louis

PAUL SNYDER
Norfolk Amateur Movie Club

ME RIEBETH
Minneapolis Cine Club

CRISSE A. PELLETIER
Toronto Amateur Movie Club

L. NESTELL
Cinemen Club

MAUDE W. A. CADARETTE
Los Angeles 8mm Club

FRED F. KAUFMAN
Indianapolis Am. Movie Club

RIL DVORAK
Suburban Amateur Movie Club

O. ROUNTREE
Bay Empire 8mm Movie Club

BERT B. GRIFFITH
Sunkist Movie Club

THUR E. GIBBS
Portland Cine Club

Y A. HOOK
Seattle 8mm Club

EMERSON CLYMA
Detroit Society of Cinematographers

F. SISSEL
Austin Movie Club

THEO. ROTH
Sherman Clay Movie Club

ED E. SNYDER
Des Moines Y. M. C. A. Movie Club

C. ENION SMITH
Metro Movie Club of Chicago

MOSS BROWN
Dallas Cinema Club

ER BEZEK
Chicago Cinema Club

SSELL A. DIXON
Pittsburgh Amateur Cinema Club

Entered as Second-Class Matter, May 4, 1938, at Postoffice at Los Angeles, California, under the Act of March 3, 1879. Subscription rates—U. S., \$2.00 a year. Canada, \$3.00 a year. Foreign, \$3.00 a year. Single copies, 10c. Foreign single copies, 35c. Copyright, 1940, Ver Halen Publications. Advertising Rates on Application.

THE NEW G-E METER

Geared for Every Kind of Light

Covers Brightness Range from .05
to 1700 Candles per Square Foot

Just as your car has three forward gears to handle wide variations in speed, your G-E exposure meter is geared to cover three ranges of light—low, medium, and high. This gives you clear, distinct readings over a light range from .05 to 1700 candles per sq ft. Each kind of light—low, medium, and high—utilizes the complete light-value scale.

LOW:

With hood off, utilizing the incident-light method, the G-E exposure meter gives readings in brightness as low as .05 candle per sq ft.



SECOND:

With cover open, those important medium-light readings, such as under photo floods and on dark days, are spread out over the full scale.

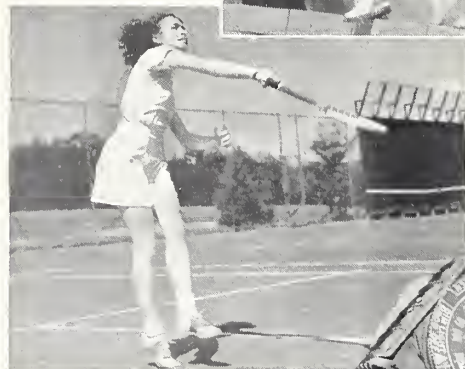

HIGH:

With cover closed, the effective acceptance angle is 50° horizontally and 30° vertically. Gives correct exposure readings up to scene brightness of 1700 candles per sq ft.

NEW ONE-HAND OPERATION

Molded to fit the hand. One finger controls calculator, cover, and new calculator lock. Ask your dealer for bulletin. Or write G-E Photo Data Service, General Electric, Schenectady New York.



GENERAL  **ELECTRIC**



Ray Merville

AS IT must to all men, death came to Ray Merville.

To the thousands of amateur cine fans the country over, he was the king of home movie gadgeteers. Thousands of readers of HOME MOVIES gained much from Ray Merville. His "Dream Camera" will long be discussed and remembered by the present crop of cinefilmmers. He "glorified" the 8mm camera. Ray Merville was so strongly entrenched in his favor of 8mm film that to him all other sizes—even 35mm—was inferior in many respects.

Ray Merville was a true hobbyist. He would talk about amateur movies to interested listeners until the wee hours of the morning—until long after daylight if you stuck with him. And even while he was hospitalized, he planned new cinematic conquests, sketching new gadgets for his camera while propped up in bed. His last letter hinted of a "bug-o-graph"—a gadget that would enable filming

small insects, even the proverbial "gnat's eyebrow"! Ray knew optics well. It was his profession, having been associated the greater part of his commercial life with prominent optical manufacturers.

But during his free moments he devoted his attention to the hobby he loved so well—home movies. In due time he came to HOME MOVIES as one of its associate editors. He became the father-confessor, champion, and patron saint of the 8mm movie maker. Sound for 8mm, in fact all 8mm problems, were his forte.

It was Ray Merville who developed the first successful gadget for photographing night shots of the San Francisco Fair in Kodachrome, following a casual report in HOME MOVIES that this could not be accomplished successfully. Ray Merville believed it could be done. He tackled the problem and designed a gadget that would drive an 8mm cine camera at the slower

• Continued on Page 398

CASTLE FILMS

EXCLUSIVE-AUTHENTIC

16 AND 8 mm MOVIES



Every projector owner can now obtain this amazing record of a tragic chapter in modern history—order "Battle For France" today at your photographic dealer.

Daring under-fire motion picture record showing:

Heroic evacuation of Dunkerque under terrific land and sky fire!

Nazi air fleet bombs Paris environs.

France's heroic armies retreating over devastated and flooded countryside.

Thousands of civilians fleeing under terror of Nazi air and tank stampede.

Famed Maginot line evacuated.

Paris surrendered.

BATTLE

FOR

FRANCE

AND FATAL END

Send this Handy Order Form to your photographic dealer NOW

Please send Castle Films' BATTLE FOR FRANCE in the size and edition checked below.

16 mm SIZE			8 mm SIZE	
Headline 100 Feet	Complete 360 Feet	Sound 350 Feet	Headline 50 Feet	Complete 180 Feet
\$3.50	\$8.75	\$17.50	\$1.75	\$5.50

Name _____

Address _____

City _____ State _____

B-8

CASTLE FILMS

30 ROCKEFELLER PLAZA
NEW YORK

FIELD BUILDING
CHICAGO

RUSS BUILDING
SAN FRANCISCO



Presenting
KIN-O-LUX

RATINGS

**No. 3
GOLD
SEAL**

**WESTON TUNGSTEN 100
SCHEINER TUNGSTEN 29°**

Created for indoor use, KIN-O-LUX No. 3 Gold Seal is a new, finer film for every occasion (except bright sunlight) where speed and quality are the first essentials. Compare the finer results attained with KIN-O-LUX No. 3 Gold Seal with those of any other make. Let that test prove to you why its superiority is unquestioned, its moderate price reflects true value, and why you can buy it at leading dealers everywhere.

100 feet \$6.00 50 feet \$3.50

For real movie pleasure always—ask for these other KIN-O-LUX films too:

KIN-O-LUX No. 1 (Green Box)		KIN-O-LUX No. 2 (Red Box)		KIN-O-LUX No. 3 (Lavender Box)	
Weston 8	Scheiner 18°	Weston 12	Scheiner 20°	Weston 50	Scheiner 26°
100 ft. \$3.00	50 ft. 2.00	100 ft. \$3.50	50 ft. 2.50	100 ft. \$6.00	50 ft. 3.50

ECONOMY • RELIABILITY • FINER RESULTS

Write for Booklet H8

KIN-O-LUX, INC. 105 West 40th Street, New York City

**MORE
OOMPH
FOR YOUR
HOME MOVIES**

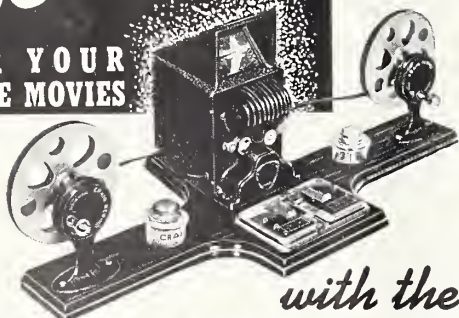

with the
CRAIG PROJECTO-EDITOR

It takes proper **Editing** to make modern fast-moving, interest-sustaining movies. **ACTION-EDIT** your films the Hollywood Studio way — transform random shots into smooth-running sequences that everyone will enjoy seeing.

The Projecto-Editor provides a unique viewing method — allows careful inspection, slow motion if desired, of **every** movement on its brilliant miniature screen. Films may be readily removed from the polished guides for quick cutting and splicing.

At all dealers — Ask for demonstration.
8mm. model, complete . . . **\$27.50**
16mm. model, complete . . . **\$49.50**

CRAIG MOVIE SUPPLY COMPANY

1053 S. OLIVE ST. • LOS ANGELES, CALIF.

"Makes Editing a Pleasure"

Craig Safety Film
Cement—25c



Craig Senior Rewinds
\$4.50 each or \$9.00 the pair

Craig Junior Splicer
8 or 16 mm., \$2.50

Craig Junior Combination
Complete, \$7.25

Craig 16mm. Senior Splicer
For sound or silent, \$10.00

Craig Senior Combination
Complete, \$19.50

The Reader



SPEAKS

Technical Correction

We are indebted to this reader for correct specifications of a machine screw to fit the tripod mounting of cine cameras — so often referred to by amateurs submitting ideas for the *Experimental Cine Workshop*.

Dear Sirs: In Fred Ward's suggestion appearing in the *Experimental Workshop* department of the April HOME MOVIES, he states ". . . hole 'A' takes a quarter-inch thumb screw with a No. 24 thread." This should properly read "No. 20 thread." Also, at "C," instead of 7/32-inch diameter drill, I think a No. 7 drill would be correct, and this hole should also be tapped for a quarter-inch No. 20 thread thumb or machine screw.

— Peter Gunderson.

Approves

Here's a letter from just one of the hundreds of readers who have written us approving of the emblem idea for cinefilmmers and offering additional suggestions:

Gentlemen: Please let me add my hearty approval of the emblem idea as outlined in the May issue. I also like the suggestion of an automobile insignia as recently suggested by reader Howard Keene. Another thought comes to my mind. Why not also make available a ring with this same emblem on it?

— G. Douglas True.

A New Swap Idea

This reader offers a suggestion for broadening the swap service sponsored by this department each month:

Dear Sirs: A great many amateur movie fans buy commercial, scenic, comedy, and art films. I have quite a number of four hundred foot reels that I would be glad to exchange permanently or loan in return for loan of films of equal footage from other cine fans. I might suggest that some

sort of a service of this kind be carried on through your office to the mutual advantage of readers.

— C. A. Starkweather.

Explanation

Through a last minute editorial adjustment, the article, "Amateur Builds 200-ft. 8mm Film Magazine," which appeared in the June issue, was cut deeper than anticipated, resulting in the omission of pertinent information asked by this reader:

Gentlemen: After reading the article in the June issue about building a 200 ft. magazine for an 8mm camera, I fail to understand how the film is unloaded in daylight, nor do I see the practicability of having to run the film on 25 foot spools and then removing them as they are filled.

— S. J. Hutchins.

Ans.—25-foot camera spools are not used with this set-up. The bulk film is wound upon a regular 200 foot projection reel and after being threaded through the camera, leads to another 200 foot pro-

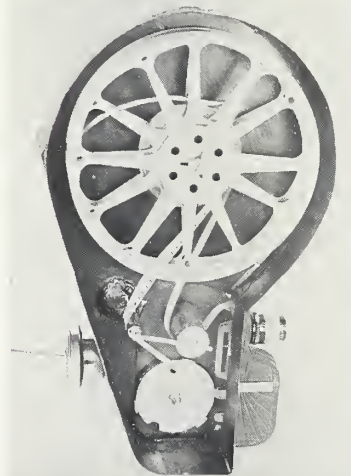

jector reel which revolves on a spindle adjacent to the supply reel as shown in the accompanying illustration. Using the projection reels, the film must necessarily be loaded and unloaded in the darkroom. Where daylight

• Continued on Page 399



Home Movies

MAGAZINE



**Subscription
Order Form**



MOTION

MAKES YOUR PICTURES REAL -



**TAKE ALL OF IT
IN COLOR MOVIES!**

WITH THE **5-SPEED** **Revere**
Double 8
CAMERA

Why be satisfied with "still" pictures? Take continuous motion—your children while they are playing—your friends in action on the beach. Record permanently action scenes you may wish to keep fresh in your memory. With the Revere Double 8 Camera you can take brilliant life-like movies in full color or black and white just by pressing a button. The Revere gives you clear, steady movies that you can project life size, yet it uses economical 8mm film. Even a school child can load and thread the Revere and get beautiful theatre-quality movies. Positive re-wind—no snubbing of film—has fast or slow motion features. See this marvelous instrument at your dealer's today! Mail the coupon below for full details!

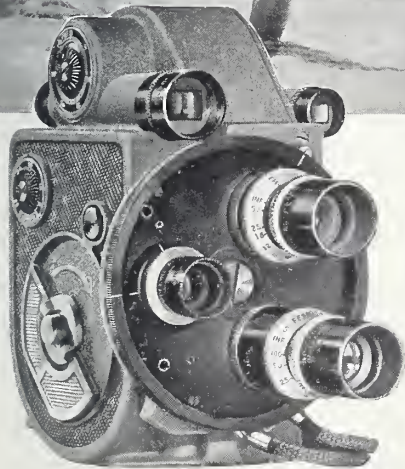

Licensed Under Eastman
Spool and Spindle Patents

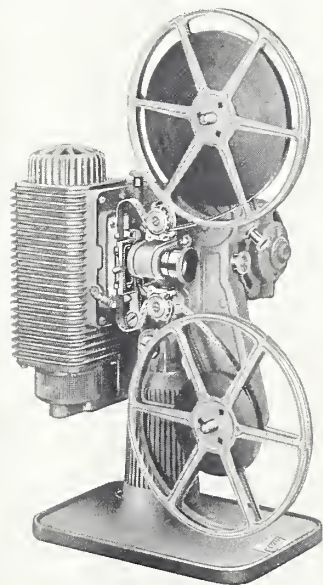

Revere Model 99 Turret Camera

You can now own a "Turret 8" at a reasonable price—and see those distant action scenes—by revolving turret head instantly. The Revere Model 99 has all the features of the Model 88 plus a "precision-built" revolving 3-lens turret and extra optical view finder for use with 1" and 1½" telephoto lenses. Complete with one Wollensak 12.5mm
5 lens \$65.00

Revere 8 Projector

Your dealer will demonstrate its brilliance, steadiness and ease of operation. A scientific optical system with 500-watt lamp and 1-inch lens that does wonders for your color and black and white pictures. 300-foot reels, double blower cooling system, enclosed film rewind, powerful, quiet AC-DC motor and many other features. Complete with 500-watt lamp and F1.6 lens \$59.50

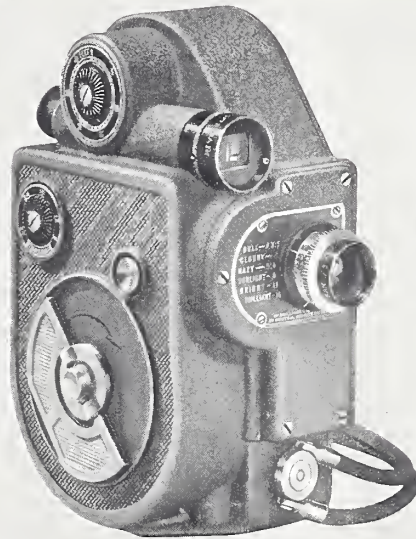

**Revere Model 88
Double 8 Camera**

This versatile camera takes ACTION as you want it—normal, ultra fast or in slow motion. 5 speed shutter and movement control. Large eye-piece in built-in, no-glare view finder. Everything you see in the view finder will be in the picture. Complete with Wollensak 12.5 mm. F 3.5 lens in removable universal focus mounting—\$29.50. With F 2.5 lens—\$39.50.

**Revere
Sprocket
Film
Control**

forms a loop in the film automatically—prevents film jamming. An exclusive Revere feature.



REVERE CAMERA COMPANY · CHICAGO
PHILADELPHIA · KANSAS CITY · MINNEAPOLIS · LOS ANGELES · DALLAS

REVERE CAMERA COMPANY
Dept. 8HM, 326 East 21st Street, Chicago, Ill.

Please send latest literature of Revere 8mm motion picture equipment.

NAME _____

ADDRESS _____

CITY _____ STATE _____

*For Canadian prices, write to Ryerson Film Service,
299 Queen Street, West, Toronto*

PHOTRIX CINE

**A real movie exposure meter,
made especially for movie work**

THE movie camera owner needs a special exposure meter...he thinks in terms of operating speeds, not in exposure time... his main camera setting is the lens opening... his camera angle is small. That is why ordinary exposure meters are not satisfactory for motion-picture use. PHOTRIX CINE fills the need of movie camera owners... it is not a converted still picture meter, but has been designed, in every detail, for the special requirements of movie work.



HERE ARE ITS OUTSTANDING FEATURES:

- Movable scale of operating speeds for precise adjustment according to specific shutter speed of your movie camera.
- No setting between shots... reads lens opening directly.
- Sensitivity adapted to full range of light conditions occurring in cine photography.
- Tapered light chamber giving sharply defined light acceptance angle of 50 degrees.

The ideal exposure meter for amateur and studio use, with every movie camera, with all color and black-and-white films.

Top-grain cowhide zipper case, \$1.50

\$22.75

RANGES
 Brightness: 0.75 to 4500 cdl./sq. ft.
 Lens Opening: F:1 to F:32
 Light Acceptance Angle: 50°
 Film Speed: 0.75 to 800 W., 8 to 33 SCHL.
 Operating Speed: 6 fr./sec. to 128 fr./sec.
 Shutter speed at 16 fr./sec. adjustable from 1/25 to 1/50 sec.

MADE IN U. S. A. by craftsmen with more than 25 years experience in electrical precision instruments. Photrix Cine is reliable, sturdy... built for years of faithful service. At your dealers, or write Dept. P-8.



INTERCONTINENTAL MARKETING CORPORATION, 8 West 40th Street, New York

With the PRO-16's

Hollywood Goes 16mm

Over the ever-changing horizon of commercial and theatrical movie production looms a new and important phase portending a still greater era for 16mm films. Continued narrowing markets for the product of Hollywood's independent film producers has started many printing features and shorts on 16mm film for commercial and road-show exhibition.

A ready market is being found for these films among small independent exhibitors operating in small communities where regulation theatres are not required for their screening, and where the usual fire ordinance restrictions do not apply to safety film exhibition. It is not unlikely that, with the growth of this movement which could easily provide ample films for multi-feature programs, new theatres screening substandard films exclusively will spring up from coast to coast—especially in towns and communities where big theatre interests have manipulated seating and fire restrictions in their favor, and to the disadvantage of the independent theatre owner.

For more than two years, small independent film exhibitors with little more than an automobile, a dozen reels of film, and a sound projector, have been touring open air shows and making good money at it. And from these proving grounds among the rutabagas, the echo of their success has reached Hollywood and given it an idea—an idea that may be worth money, and lots of it.

For one thing, Kodachrome will make possible the production of 16mm entertainment films at a fraction of Technicolor cost and without the expensive equipment necessary for the latter—a factor which has lent great impetus to production of 16mm industrial films in recent months.

Those engaged in production of 16mm commercial and educational films will see in this new trend possibility of extending their tal-

• News of readers' activities in business, school, and publicity film production.

ents and facilities to include production of entertainment films as well.

Opportunities

Possibly the most important stepping stone leading to professional movie production for the advanced amateur is the filming of educational pictures. This field, growing in importance daily, offers the greatest opportunities. Notwithstanding the vast amount of material now available as educational and instructional films, there is an unabated demand for good teaching films produced from the viewpoint of the teacher, and less with a commercial or propaganda slant.

Here again, Kodachrome plays an important part in that it makes the teaching film more natural and vivid. This gives the average cine-filmer who has mastered Kodachrome a leg up on many already established educational movie producers who film in 35mm and then reduce to 16mm. Incidentally, HOME MOVIES' current amateur contest reveals an astounding improvement in amateur Kodachrome picture making, proving that the serious-minded amateur's technique has reached a degree of perfection paralleling the professionals.

Medical

Dr. Joel Pressman, husband of film star Claudette Colbert and famous as a throat specialist, has registered many delicate operations on 16mm Kodachrome. A number of his films are being duplicated for distribution and exhibition among medical institutions.

Slot Machine Movies

Further proof of successful production of commercial films directly on substandard widths is the report that many producers engaged in filming the long heralded slot machine mov-

• Continued on Page 398

4 STAR



Titler

For Year 'Round Filming Activity

After the winter title-making season, use it for ultra-closeup filming of plants, flowers, insects and other nature studies!



Adjustable camera base accommodates every make of 8mm, 9½mm, and 16mm camera. Alignment and centering of titles is simple and accurate. Title board is readily adjustable to either small typewritten or large 9"x12" title cards.



Will make practically every wanted kind of standard movie title, including zoom titles, wipe-off titles, etc. Additional accessories, available at small cost, make possible scroll, flop-over, superimposed titles and others.

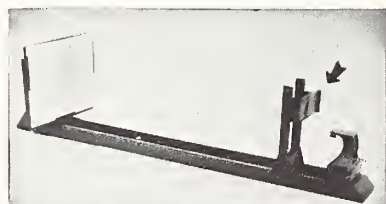

• Top—Titler complete with supplemental lens holder and built-in wipe-off device. Below—Showing scroll device in place. An invaluable accessory well worth the price—\$4.50.

\$13.75

Lights, \$4.50 Extra

HOLLYWOOD CINE PRODUCTS CO.

3221 South Figueroa Street

Los Angeles, Calif.

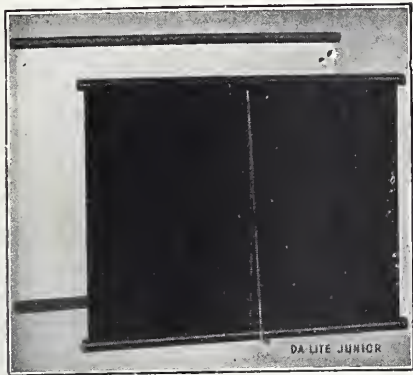

DA-LITE JUNIOR SCREEN

This model is a "junior" in size and type of mounting only. In picture quality, it equals the highest priced screens in the Da-Lite line. Four sizes from \$2.00* up. The 30" x 40" is only \$5.00*.

DA-LITE CHALLENGER

This model, shown at right, consists of a Da-Lite Glass Beaded surface in a metal case to which a tripod is pivotally and permanently attached. It is a complete, compact unit, easy to carry and easy to set up anywhere — the only screen with square tubing to hold the case in perfect alignment. Twelve sizes, including square sizes 30" x 40" to 70" x 94" inclusive from \$12.50* up.

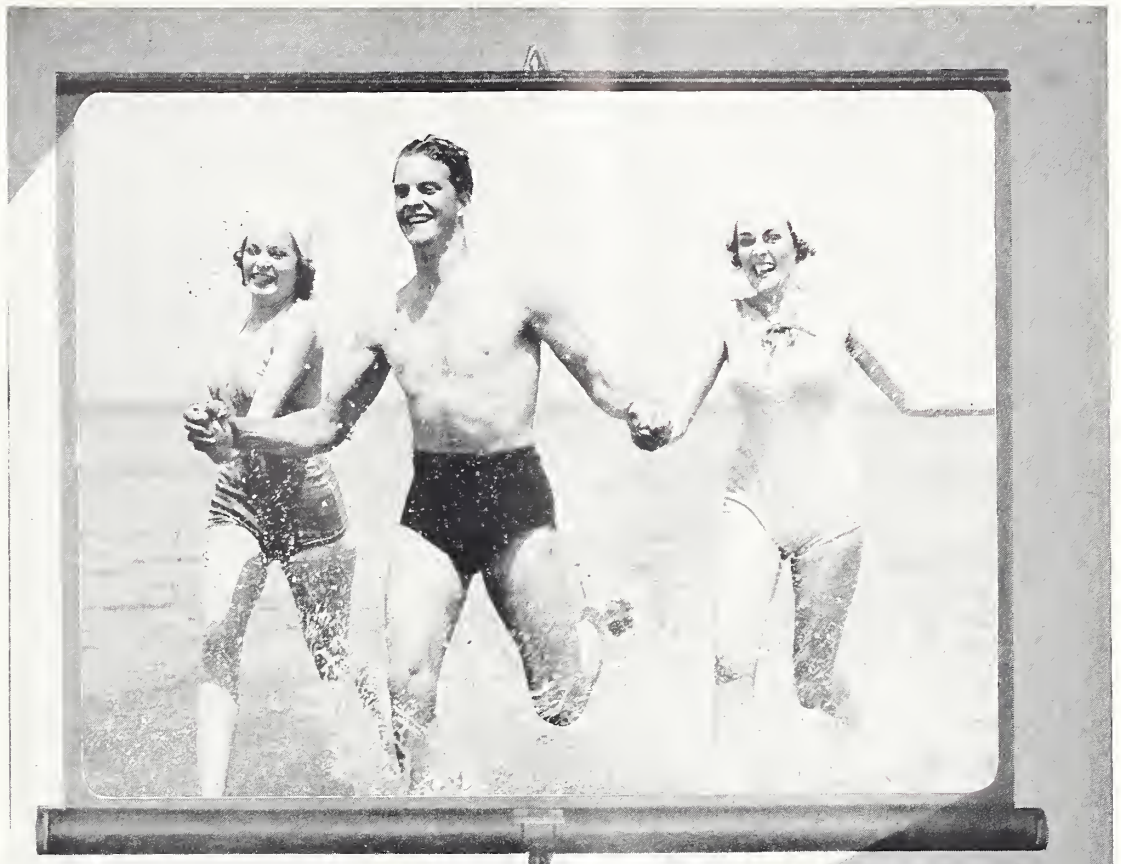

LET'S SEE IT AGAIN!

YOUR FRIENDS SAY....

When You Show Your Movies
ON A **DA-LITE** GLASS-BEADED SCREEN



Reg. U. S. Pat. Off.

The greater light reflective quality of the Da-Lite Glass Beaded Screen can make a marvelous difference in the quality of your home movie shows. If you are now using a makeshift screen or if your present screen has become streaked or yellowed with age, even the most carefully taken pictures will not look bright or clear. Make your own comparison! Send for a free swatch of a Da-Lite Glass Beaded Screen and put it beside your present screen. The greater brilliance of the Da-Lite Glass Beaded surface will amaze you.

Also compare Da-Lite Glass Beaded Screens with other screens, beaded or otherwise! The specially constructed Da-Lite Beaded surface reflects the maximum of light, yet without sparkling or glare.

This is because of Da-Lite's exclusive processes of treating the fabric, and superimposing the millions of tiny glass beads so uniformly over the entire screen area. Your Kodachrome pictures especially need this brighter light reflective surface. Natural color films, being more dense than black and white film, require more reflected light. The Da-Lite Glass beaded surface not only reflects more light but has excellent diffusive qualities which makes it ideal for general use in connection with all types of movie and slide projectors which have Mazda lamps.

Get your new Da-Lite Glass Beaded Screen at your dealer's today and see how much more pleasure your movie shows bring to family and friends. Write for descriptive literature.

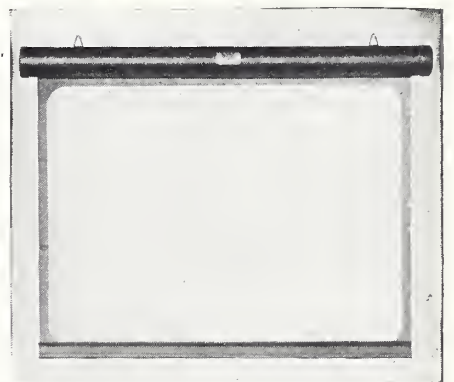

DA-LITE MODEL B

This popular-priced hanging screen has a metal case to protect the Da-Lite Glass Beaded fabric when not in use. Twelve sizes including square sizes from 22"x30" to 63"x84". From \$7.50* up.

*Prices slightly higher on Pacific Coast.

DA-LITE SCREEN CO., INC.

2723 N. Crawford Ave.

Dept. 8HM

Chicago, Illinois

DA-LITE SCREENS AND MOVIE ACCESSORIES

An Emblem of Fellowship

A VAST fraternity of amateur movie makers have spoken. In the hundreds of letters addressed to the editors of Home Movies, they have expressed a common desire to fraternize—to become better acquainted with their brother hobbyists.

And so, Home Movies, as ever champion of the amateur cinefilmer, has undertaken to make another of his wishes come true. The move for a unified nation-wide organization of movie amateurs and a suitable pin or emblem to identify it has become a reality. The groundwork for this new organization—the REEL FELLOWS—has been laid. Dies for the emblems have been completed.

REEL FELLOWS will be a strictly independent group of amateurs, for amateurs. Sole purpose of the organization will be to further the pleasure of amateur movie making with a greater accent upon a wider and more beneficial contact with one another.

REEL FELLOWS is a friendly name that just fits this friendly, chummy, coast-to-coast organization of movie amateurs. There won't be any secret passwords or handshakes—just your REEL FELLOW emblem to identify you.

The REEL FELLOWS will be legion. You'll meet them wherever you go—New York, Kansas City, or San Francisco. They'll give you a friendly lift with your problems. Perhaps you'll save a valuable shot for a brother REEL FELLOW with a timely tip on exposure. You'll make a lot of new friends, interesting friends with a kindred hobby—making movies.

In the September issue of Home Movies we will tell you more about the REEL FELLOWS and reveal the handsome emblem of this important new movie amateur organization of which every cinefilmer is invited to become a member.

HOME MOVIES

Published in Hollywood

AUGUST 1940

Authored by

COUNT H. C. A. VON SCHOENFELDT, A.R.P.S.

COMPOSITION is, as a rule, very important to the still photographer. If the cinefilmer is able to produce a pleasing continuity or plenty of action, he will still have a picture that will be interesting. Composition in the movie film is usually only a secondary factor. But every movie amateur some time or other shoots scenery, where neither story nor action play a vital part. Composition enhances this type of movie.

In recent motion picture epics, action has frequently been subordinated in favor of composition. For instance, in "Gone With The Wind," many hundreds of feet were devoted to beautiful scenery, exquisitely photographed and made beautiful by careful composition.

To the photographer gifted with an artistic eye,



Von Schoenfeldt

PERSPECTIVE *and* BALANCE *chief* factors in good composition

good composition is instinctive. Those not thus blessed, have to learn the rudiments of composition by practice and by following certain fundamental rules.

The photographer, especially the amateur, when afield, has a number of things on his mind. He does not like to be bothered with too much theory when photography is only a hobby. To simplify the matter of composition the photographer who uses a movie camera does not have to remember more than three factors that more or less rule composition.

The dictionary tells us that to compose is to put things in their proper order. All we have to know is what is meant with proper order. Of course, if we are out to photograph scenery, we can hardly be expected to move around the different objects that we want to include in our picture. We have to do the moving. We must select the most advantageous place to set up our camera.

The three things we should strive to obtain in our picture are, Perspective, Balance and Suitable

Background as surroundings to our main object of interest.

Perspective or depth is highly important in any picture. The eye is able to clearly distinguish the third dimension in any scene. But when we photograph that scene and later project it on our screen, that third dimension no longer exists. A movie screen is a flat surface and has only two dimensions. All talk about three dimensional movies is sheer nonsense as long as those pictures must be projected upon a flat screen. We might be able to obtain projection that resembles three dimensions, but in reality it will remain two-dimensional.

Even if we could make three-dimensional stereoscopic movies, it would be rather expensive and

• In composing the above picture, the camera was moved back and swung slightly to the right in order to include a part of the ship's deck and rigging in the scene. Perspective was thus added and the picture properly balanced against the vast expanse of water that might otherwise have appeared in the foreground.

• Continued on Page 390

PEORIA CINEMA CLUB

INCORPORATED UNDER THE LAWS OF THE STATE OF ILLINOIS

School of
Cinematography

Peoria, Illinois

This is to Certify that

has satisfactorily completed the Course of Cinematography as prescribed by the Peoria Cinema Club and has been in attendance at all lectures, demonstrations, and laboratory experiments and is hereby recognized as a

Master of Amateur Cinematography

Given this _____ day of _____ nineteen hundred and forty.

DIRECTOR

DIRECTOR

PRESIDENT

DIRECTOR

SECRETARY

PROGRAM CHAIRMAN

teur Cinematography. Each lecture was confined to one and a half hours after which there was a demonstration covering the subject. Our entertainment and amateur films were saved to show after this program as a relaxation.

By commencing with elementary lens structure, we led the way from the very start for the inexperienced beginner up through the more complicated subjects and were pleasantly surprised to find we were all growing together. Many advanced

Club's CINEMATOGRAPHY course

improves members' technique . . .

NO doubt there are many amateur movie fans throughout the country who have taken the responsibility of forming clubs for the purpose of fostering the hobby of cinematography in their respective localities. The problems of stimulating interest in the hobby are many but more important are those problems of maintaining that interest once it is aroused. Many amateurs join a club with an intense desire to learn more about motion picture work while there are many who join bringing with them the experience of several years filming to their credit.

The beginner usually feels very modest when he realizes that he cannot converse in the same language with the advanced amateur and if there is nothing to correct this situation, he soon loses interest and drops out. On the other hand, the advanced amateur frequently finds there is no advantage in associating with beginners who know nothing of the technical details concerned with the hobby and soon detaches himself after he has shown his pictures to the group and has nothing else to offer. We, in the Peoria Cinema Club had this problem to face and devised an original scheme to make our meetings interesting to all and awarding recognition to those who became a part of the plan. In the past year, which was our first to try this plan, we have had great success and find that now there are more people eager to join us than we can accommodate.

We formed the School of Cinematography, a subsidiary of our club and planned six lectures, one each month, as a course of amateur cinematography leading to the degree of Master of Ama-

ateurs found they were getting new ideas to supplement their original techniques while the beginners were getting the complete data on all that was vital to successful film work.

Our first lecture entitled "Light and Lenses" dealt with simple optics, covering simple lens structure and the properties of light. The rules for auxillary lenses and the proper uses of standard lens equipment was thoroughly presented. Simple formulae brought about a better understanding of what a lens can be expected to do and also what it cannot do. Being a graduate in Optometry, I was able to make this a very interesting lecture bringing out many theories of light and lens adaptation which are not usually applied to photography. Various lenses were used in our laboratory demonstration to cast images of various sizes at different distances to illustrate the limits of lens powers.

Having traced the light through the various elements of a lens system, our next lecture was devoted to Emulsions and Exposure. This followed in proper order to show what happened to that

• Continued on Page 396

• At the club's annual banquet, certificates are awarded to those completing the lecture series. Those receiving certificates are given an opportunity to deliver one lecture of the following year's series. This is one requirement to gain further recognition — that of "Advanced Amateur."

(Right)

THE ABSORAKA RANGE

of the Rockies made a thrilling backdrop for this scene of a snow-fed creek. Use this picture as a title background for your vacation film.

Photo by

Ross Madden





1.

2.

Chicago cinefan's

HOME THEATRE

Authored by
W. F. SCRANTON

THERE were lavish bath-tubs in many American homes long before Cecil DeMille made them famous in motion pictures. But it remained for DeMille to make America bath-tub conscious with the super-colossal bathroom sets which he personally designed for many of his now famous pictures.

And just as Mr. DeMille led the way with glorified bathrooms, Frederik A. Chramer, genial host of the famous Kungsholm Restaurant in Chicago, has set the pace for super-colossal home movie theatres. Indeed, Mr. Chramer's theatre probably out-colossals any private home theatre built so far in America.

Here, indeed, is a really perfect home movie theatre and no matter how wild one's imagination runs, this theatre surpasses anything yet dreamed of. Consider first the home in which it is built. The beautiful Leander McCormick Mansion, designed in 1887 by Stanford White, the internationally renowned architect. At Rush and Ontario Streets, just off Chicago's Michigan Boulevard, this house has stood virtually unchanged by the passing parade of a great city. In rooms which once echoed the music of famous string trios or the golden voices of reigning opera stars, stately walls today look down upon a scene of the same gracious living for which they were built.

• Magnificent in every detail is this lavish private theatre situated on the fourth floor of historic Chicago mansion. It boasts a complete soundproofed projection booth with dual sound equipment and mechanical control of stage curtains and lighting.

The building itself is unique, for each brick came from Belgium, separately wrapped in straw, as bottles of rare wines are wrapped. The massive carved oak doors of the entrance on Ontario Street, beautiful in their elaborate detail, were brought from Naples, as were the heavy iron knockers which adorn them. Exquisitely carved oak and Honduras mahogany woodwork surmount the stately walls.

In this setting of quiet dignity, the famous Kungsholm restaurant is providing fare for the sort of people to whom eating is an art and a luxury. And in this setting, Mr. Chramer, in pursuance of his hobby, decided to create for the entertainment of his family and friends, a perfect

4.

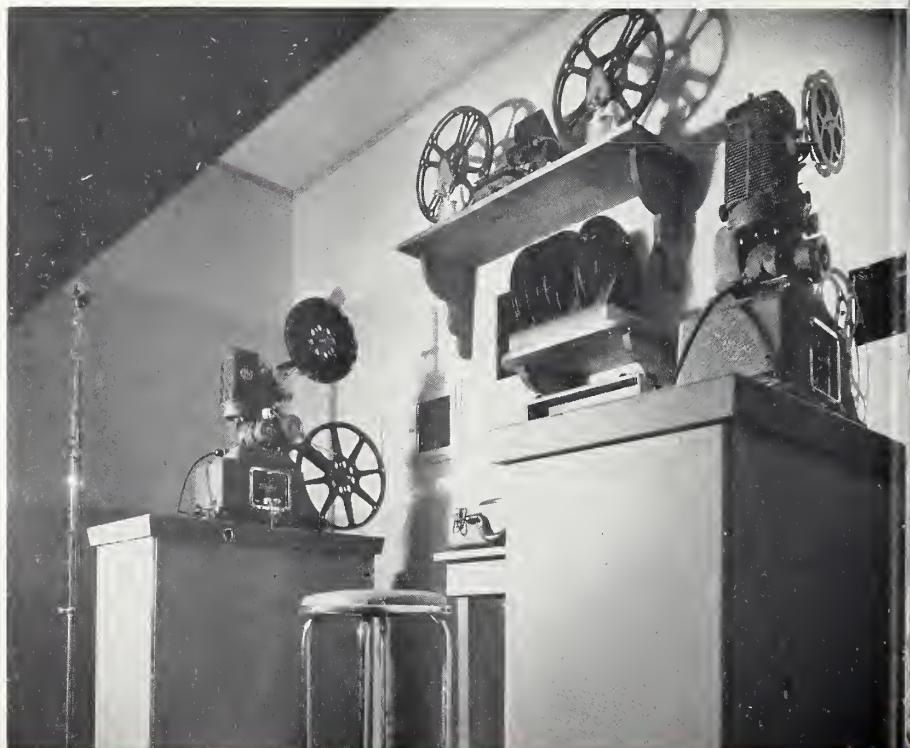

home theatre for the projection of 16mm films.

Illustration No. 3 shows the floor plan of the project which Mr. Chramer has named the "Ampro" theatre because of his selection of Ampro equipment for the projection room. This deluxe movie theatre occupies the fourth floor, which was once the private ballroom of the McCormick residence.

Entering from the old grand stairway there is a spacious lounge, treated in an atmospheric design. (Illustrations Nos. 1 and 3.) The entire ceiling is painted a deep Italian blue. The North, West and South walls have a neutral painted background with artistic decorative motives incorporated to break the plainness of the room. These motives are carried out in pastel blue and rust shades in contrast to the yellow draperies trimming the windows and cased openings. The entire floor is carpeted, the background color being rust, with the rope motif in a sand color and the leaf design in a deeper tone rust. All reed furniture and leather unholstered chairs are finished in a sand color, with the seat covers in a patterned two tone blue. East wall and portion of ceiling above is finished with decorative Nu-Wood material in

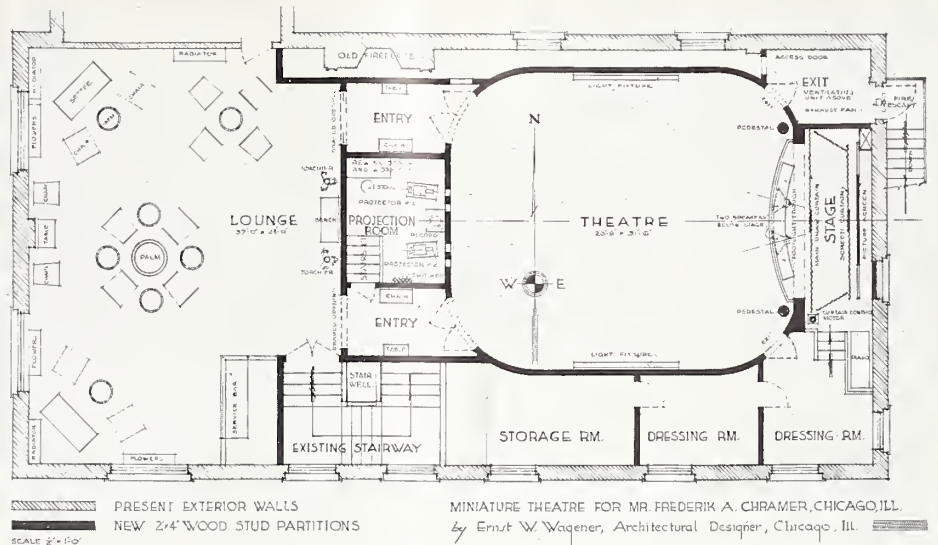

3.

booth enables the operator to keep a continuous check on the sound reproduced in the auditorium. Auxiliary equipment also includes a film rewriter, a film editor and a ventilation system for the booth. A complete complement of ruby signal lights indicate which electrical circuits are in operation at any time.

The projectors are permanently mounted on wood pedestals of hollow construction. All wiring is concealed within these pedestals and underneath the floor so that the projection room presents a remarkably clear appearance, free from the usual entangling wires.

All surfaces in the Projection room are finished in sheet-rock and are painted in three shades of warm grey, with the trimming in black and rust. The projection and observation ports are glazed in order to prevent any noise from entering the theatre proper. A series of switches are located on the South wall, controlling the sound, projection, theatre lights, footlights and curtain control motor which is operated by remote control. Projection room floor is covered with battleship linoleum in a bluish grey.

The walls forming the theatre are built away from the exterior walls, due to the fact that the exterior windows could not be disturbed, and furthermore the acoustical problem was a serious factor. By building an additional wall 18 inches

• Continued on Page 391

• Above is the floor plan of Chramer's private home movie theatre showing how it was constructed within the walls of his home. It features a generous lounge for guests as well as dressing rooms for performers when stage shows are presented.

ps them all...!

light ivory and variegated buff shades. Torchiers in front of East wall are finished in antique bronze, adorned with blue and yellow silk shades to harmonize with the two fixtures hung from the ceiling. The graceful palm tree lends a distinct beauty to the atmosphere in this room.

Directly off the South entry is the Projection room (Illustration No. 4) which houses two Amprosound projectors, an automatic repeating turntable unit and a complete changeover device to enable the operator to run a continuous show without an interruption for the changing of reels.

Electrical equipment is also provided controlling the mechanical raising and lowering of the curtain in front of the screen. A monitor speaker in the



6.



Jack Treacy



Ross Madden

loading the automobile with luggage and of close-ups of one of the wheels in motion has become pretty well outmoded as a means of conveying the start of a vacation trip. Clever cinefilmmers have created new and novel ways for getting their travel or vacation film off to a flying start.

One amateur we recall opened his celluloid travelogue with a closeup of a map of the United States spread upon a table. The hand of one person enters the scene and traces a line with one finger across the map from east to west. The hand of an-

Running gags and tie-in shots make **VACATION**

AMONG the many vacation films which the editors of HOME MOVIES have been privileged to review during recent months, were several notable for their innovation in treatment. By the inclusion of clever running gags or through a series of tie-in shots, these otherwise ordinary vacation films became outstanding examples of excellent picture making.

Authored by
RAY FERNSTROM

Beginning the vacation picture with shots of

other enters the scene to interrupt, and traces a line from the Canadian border to the Gulf of Mexico, implying that an argument is in progress as to the route to be taken.

Next the hands are seen drawing straws. Then the winning hand enters the scene with a pencil and draws a heavy line on the map from north to south, indicating the course of the trip. This sequence ends in a fade, and then a fade-in of the initial travel scene follows corresponding with the starting point on the map.

Still another amateur devised an interesting method of showing on a map the travel route taken on his vacation. The route was indicated by a wide stripe painted between the points of interest on a map. A miniature automobile was moved along this stripe by means of a fine thread to indicate progress of the trip. This could also have been done by stop-motion or single-frame photography.

Another filmer indicated the various towns and cities through which he traveled with inserts of highway markers shot closeup and invariably at a low or unusual angle that lent a dramatic touch.

The use of tie-in shots, which may be filmed along the way or after returning home, will give added punch to any vacation movie and provide continuity for the usual collection of more or less unrelated scenes filmed in the course of one's vacation. Of the several films notable for clever tie-in shots is "Slabhappy," produced during his last

Chas. Herbert





Ross Madden

vacation by Werner Henze of St. Louis. Henze opened his picture with shots of a youth thumbing a ride, followed by shots showing the youth being given a lift by the Henze's at a point along the route of their trip. Thereafter, this lad speaks all the titles describing the points of interest visited and appears often in scenes with Mr. and Mrs. Henze.

"Checking Off The Budget," described as The Movie Of The Month in the March issue of HOME MOVIES, is an excellent example of employing gag

FILMS complete . . .

and tie-in shots to keep a lengthy vacation film interesting. B. W. Johnson, together with his wife, filmed this clever movie and conceived the novelty shots after they had covered several hundred miles of their projected trip. It seems their budgeted vacation funds began to dwindle faster than anticipated, and this furnished the idea for the gag shots which later were to make this movie so interesting.

The gag idea was as follows: Johnson, as "Mr. Budget," prepares a budget sheet covering proposed expenditures for their vacation. As they proceed along the way, expenses prove greater than expected. "Mr. Budget" is shown many times poring over the budget sheet, writing in a \$5.00 expenditure where only a \$2.00 one was planned, etc. Eventually his cash on hand is exhausted and "Mrs. Budget" suggests writing checks, bringing about an overdraft of his bank account. Re-

• Continued on Page 393



Ross Madden

Schusler Crail



Chas. Herbert

• Regardless of the locale or whether your vacation movie is filmed "off the cuff" or from a well-planned script, the injection of a little light comedy by means of running gags will make it more interesting. Tie-in shots, often filmed after returning home, will enable you to edit your vacation pictures into a tight little continuity.

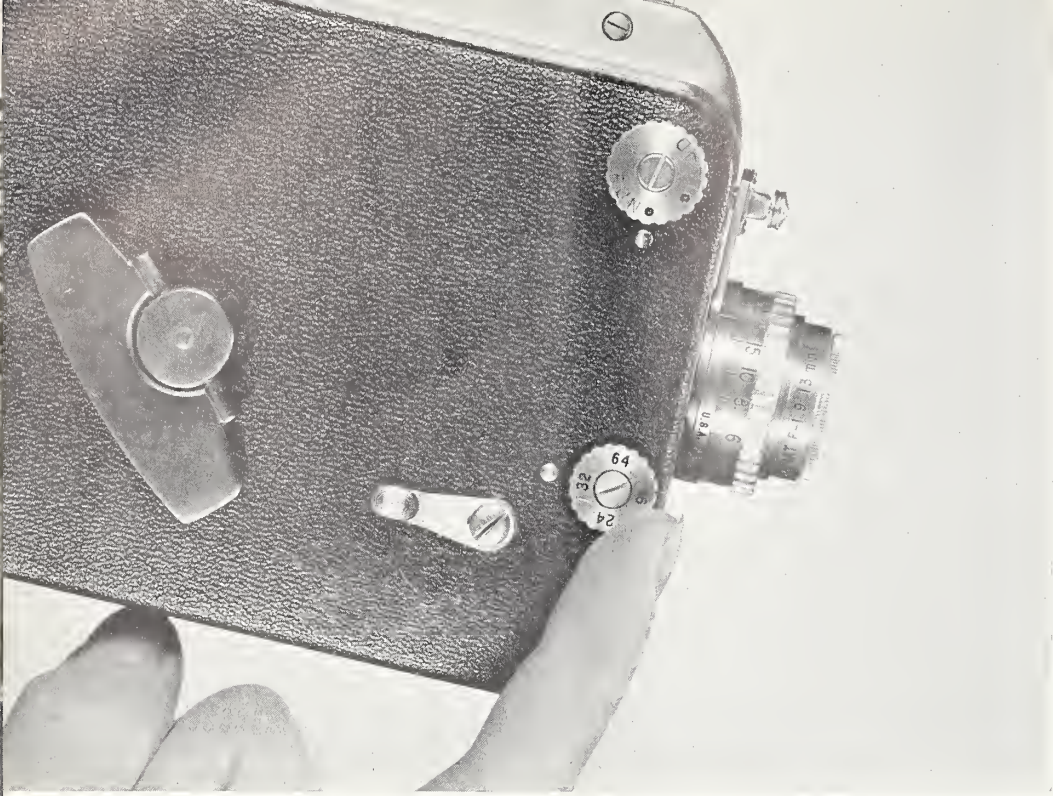

Vary CAMERA SPEED

for tricks, smoother action

IT is surprising how many people, in buying a motion picture camera, absolutely insist they must have one with several speeds. They know a multi-speed camera is a nice thing to have, but haven't the foggiest notion of what the additional speeds are for, or how to use them.

The two principal things to bear in mind when taking shots at other than normal speed are: (1) That the lens opening must be changed accordingly — one stop smaller than normal for eight frames a second, half a stop larger for twenty-four frames, one stop larger for thirty-two frames and two stops larger for slow motion, or 64 frames per second. (2) That the number of seconds used in taking a shot should vary according to the camera speed — twice the normal time should be used when shooting at eight frames, two-thirds as long for twenty-four frames, half as long for thirty-two frames, and a quarter as long for slow

motion. For instance, if it is wished to take a shot to last ten seconds on the screen, it should be taken for twenty seconds at eight frames, or five seconds at thirty-two frames.

To consider the different speeds separately, we have first, the eight-frame per second speed. This is perhaps the most useful of all the speeds, with the exception of the normal speed of 16 frames per second.

The eight-frame speed has three general purposes:

First: For single frame exposures on cameras with no special device for this purpose. By setting the camera at the eight frame speed and giving a quick press on the release button, one can get a single frame exposure without the danger of exposing two or three frames as frequently happens when using the sixteen frame speed. Interesting pictures of buds opening, storm clouds rolling up, etc., can be made by this method.

Second: To give longer exposure when the largest lens opening is not sufficient for prevailing light conditions. The eight frame speed will have the effect of doubling the speed of the film, or of giving one stop larger opening than the lens is equipped with, as it affords a 1/15 second shutter speed on a camera having a shutter speed of 1/30 second at normal sixteen frame speed.

Third: To speed up action, either for humorous effects or because of the nature of the picture desired. There are many types of shots that are improved by being taken at eight frames, even though there is ample light for normal exposure. For instance, a steamer leaving a pier, or coming into a pier, should always be taken at eight frames, because its movement is so slow. Slow-moving animals are usually improved on the screen by using this speed; and in marine pictures the sea will appear to be rougher because the waves will move faster as though a stronger wind is blowing. Aeroplanes will sometimes appear more graceful when their action is speeded up. A long shot of any-

• Continued on Page 394

• Nearly all modern cine cameras now afford a variety of camera speeds, with the speed control clearly marked and easily accessible. To use these speeds successfully, one must understand ratio of increase or decrease necessary in exposure. Stanley Andrews explains this in his article.

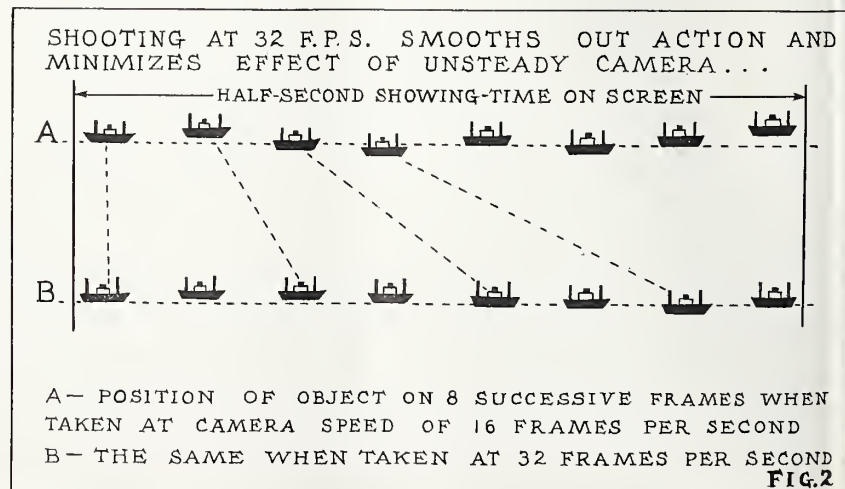
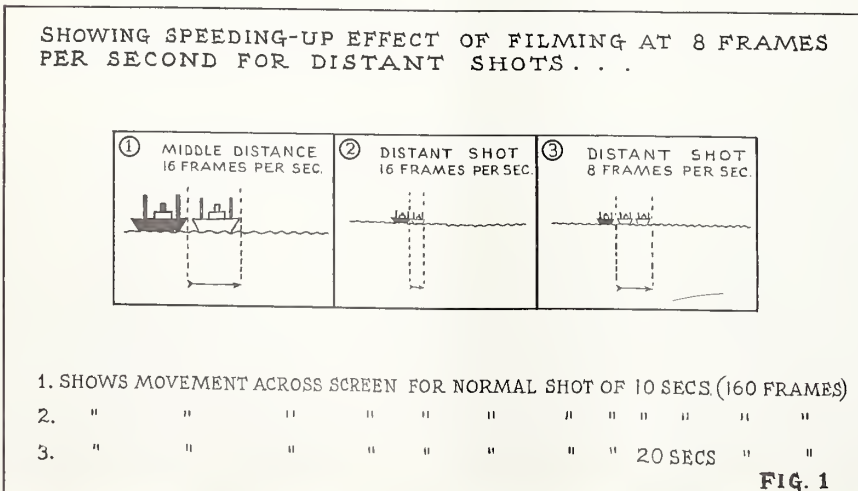

Authored by
GEORGE W. CUSHMAN

TITLE COMPOSITION *simple as a-b-c!*

NOW that the film has been shot, let's write and shoot those titles. Very few movies are complete without titles. Sounds a bit contradictory, perhaps, but it's true. Why? For the answer, consider for a moment what a title is and why it is used.

The ideal motion picture would be one which tells its story so efficiently, so completely, that any titled explanation would be superfluous. Once in a great while a picture like that is seen, but not very often. Its story is complete, perfect, self-revealing.

However, such a picture, as every amateur who has tried to make one knows, is the exception, not the rule. And so, the vast majority of movies, amateur and otherwise, must depend upon titles to tell the story completely.

Take, for example, the ordinary vacation film of which so many thousands of feet will be exposed this summer. When the weary traveler has returned home and his films are projected for the first time, he recognizes every scene he has shot, every person he has photographed, every action that takes place. "Why do I need titles?" he reasons. "I know every shot—I exposed the roll myself." That's very true, and for his own satisfaction and future screenings, he doesn't need titles.

But suppose he sends his vacation reels to Cousin Henry in Texas, who, incidentally, has never seen the country appearing in the films. The amateur says, "I'll just send Henry a line telling him where the scenes were taken and who those other people are." And as soon as those lines are written, Mr. Amateur has a fine set of titles—titles which he said the film didn't need. Now, if he would put them on celluloid and place each one before the scene it describes, his vacation film would be much nearer completion.

However, he chooses not to go to all this "bother" (not knowing that the making of titles is one of the most fascinating parts of his hobby) and sends the reel and letter down to Cousin Henry.

Cousin Henry reads the letter, then views the film. If his northern relative has done a good job of describing the scenes in the letter, Cousin Henry enjoys the film completely, returns it with his compliments. But the great odds are that several questions will arise in his mind—questions that are

not answered in the letter which accompanied the film, questions which the film leaves unexplained.

The chances are that when the film is returned he'll write his friend who made the picture and ask him about certain incidents in the picture. The answers which the amateur sends back are obviously necessary to the complete understanding of this film and should be used as additional titles.

Here, then, are two methods for writing titles for a film—one, write out a description of the scenes as though writing a letter, and second, use the answers to questions asked by friends who view the film.

MANY amateurs believe that the best person to assist in the writing of titles is an expert or advanced movie maker. This may or may not be true. When asked to view a film with the thought of writing titles in mind, the advanced worker is likely to turn critic and comment on the film as to its faults, strong points, bad points, composition,

• Continued on Page 387

• Ask a friend to sit in while you project your film and let him ask questions. Jot down the answers to his questions on a pad of paper and you have the essence of your titles.



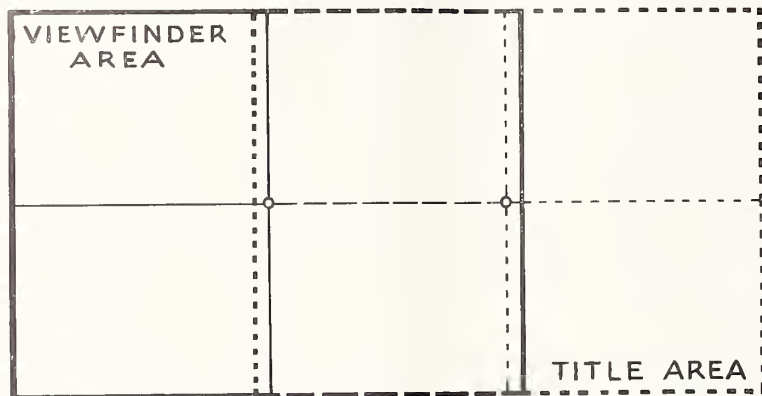

FILMO 70 SERIES

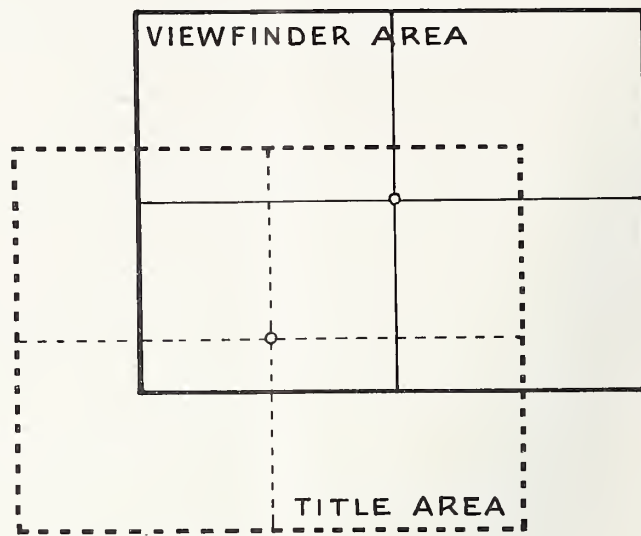

FILMO TURRET "8"

Title centering guides for FILMOS...

THIS month we publish the first three title centering guides of the Bell & Howell camera series. The first applies to all cameras in the model 70 series; the second, to the Turret 8 model; and the third, to the single lens 8mm camera.

Full instructions for using these guides are illustrated and described below. The guides are especially drawn to correspond with size of the title backgrounds which appear in HOME MOVIES each month. This is the size that fits most typewriter-type movie titlers. Without a titler, of course, these guides make it possible to shoot titles of any size, simply by lining up title card as shown here and using an auxiliary lens before the camera lens. In such instances, of course, the camera should be mounted upon a tripod or other similar fixed support.

Centering guides for other Filmo models will appear in the August issue, to be followed by guides for other cine cameras. Guides for Eastman Cine Kodaks appeared in two groups — in the June and July issues.

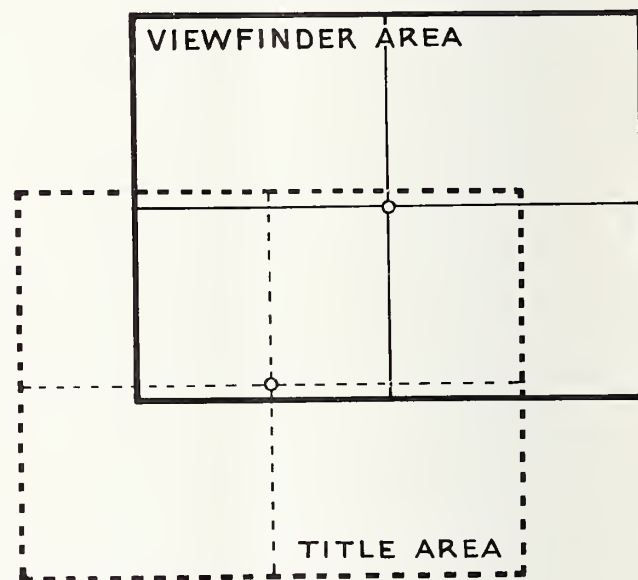

FILMO SINGLE LENS "8"

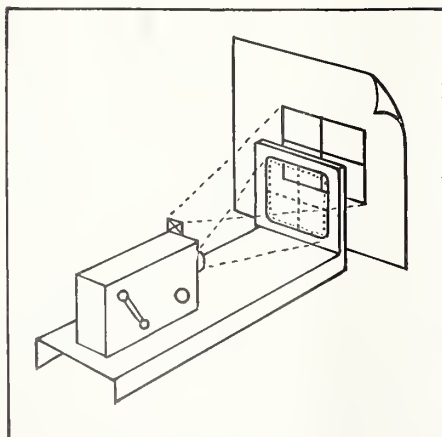

For typewriter titlers, insert guide in card holder, line up title area within opening of card holder. Then, sighting through viewfinder, line up camera with viewfinder area and lock in position.

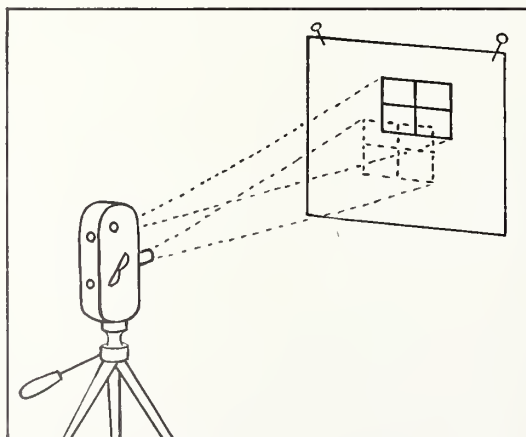

To shoot titles without a titler, place centering guide on wall and, with camera mounted on tripod, line up camera with viewfinder area and lock in place. Title card is placed over "title area."

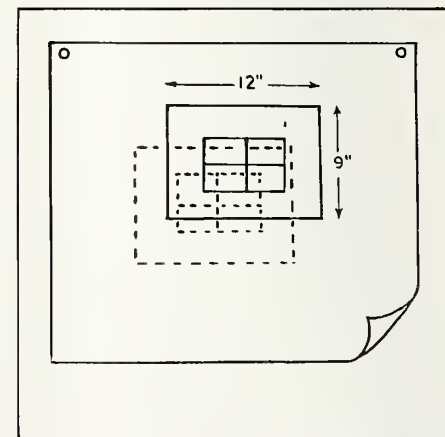

To convert guide for larger title cards, lay guide on a large sheet of paper, as shown, and expand each rectangle to required size, using the "center" point in each square as a basis to work from.

Authored by
S. J. WILLIAMS

SHOTS of swimming, diving, and especially under-water swimming, made from the fish's viewpoint, with the camera's eye under water, are a sure-fire way of adding novelty to any film, professional or amateur. What's more, making these unusual shots isn't nearly as tricky as it sounds.

Sometimes you don't even need to put the camera under water! If your object is such that it can be shown in obliquely-angled shots, all you need is a simple gadget which is, in effect, a greatly overgrown sunshade. Just make a big, watertight tube — either conical or pyramidal as you may prefer — long enough to reach from the camera's lens to a point a few inches below the surface of the water, as illustrated in Fig. 3.

At this lower end, provide an appropriately-sized window of clear plate glass through which to

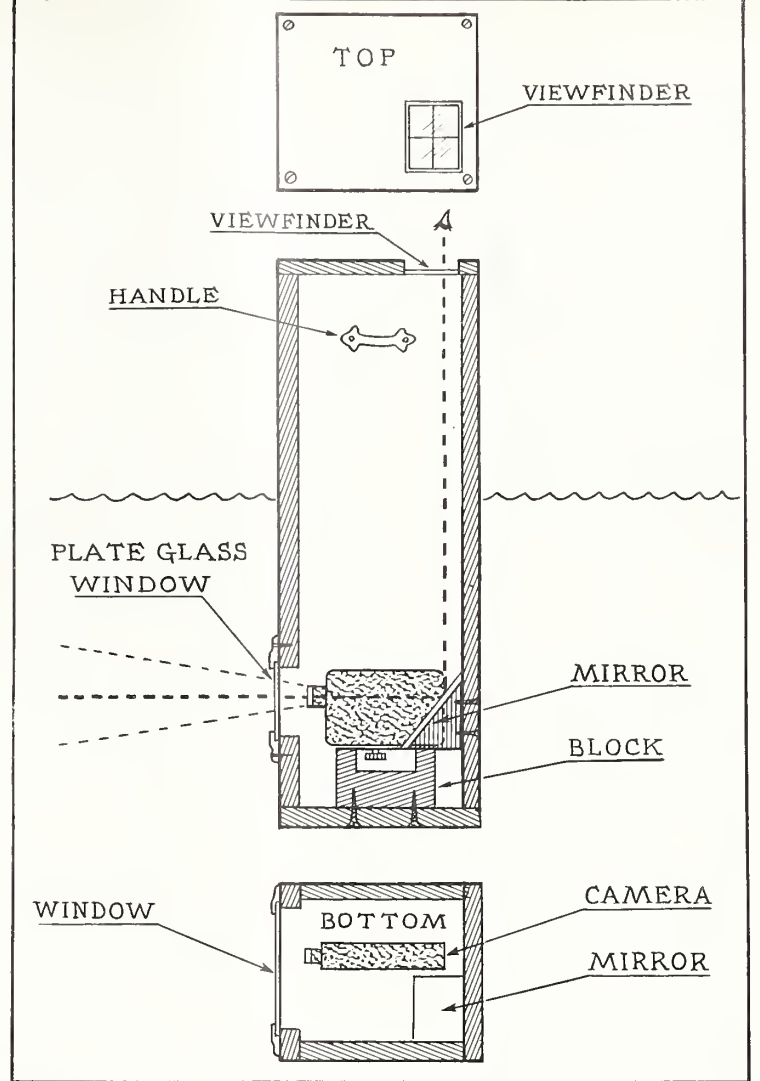

Fig. 1

Homemade gadgets for filming

UNDER WATER . . .

shoot. Seal this to the tube with a good, watertight joint.

In use, simply slip the gadget on the camera, and hold it so that the lower end of your "waterscope" is several inches below the surface — deep enough so it won't be uncovered by any waves or the splashes that your subjects may make. Then shoot; that's all there is to it!

But this oblique viewpoint can't always fill the bill. Much more often it will be necessary to have the camera aimed in a horizontal direction, but still well below the surface.

One of the simplest gadgets ever made for this

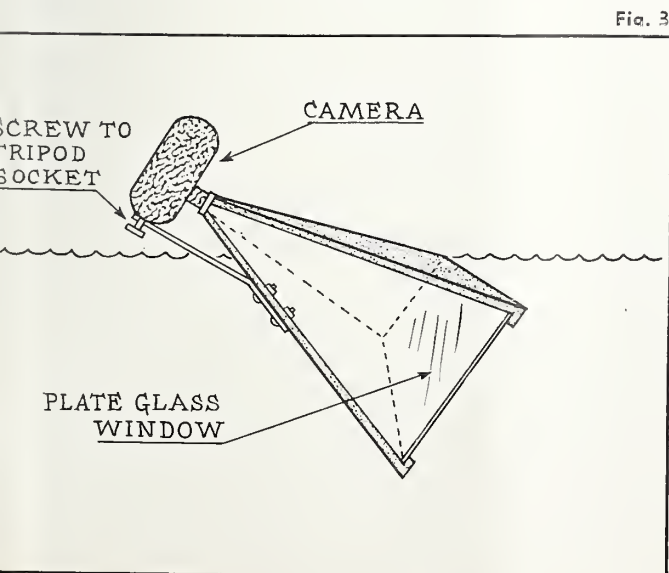

Fig. 3

purpose was the one that newsreel "ace" Ray Fernstrom improvised when he was filming the 1932 Olympic Games. Ray wanted some under-water shots of the swimming and diving events, but the officials refused to give him permission to don a diving suit and personally take the camera under water.

None the less, Ray had to have those shots — and he wasn't going to let a little thing like an official ban stop him!

He hunted up an old automobile inner-tube and cut it apart so that instead of having a circular tube, he had a long, straight one. At one end of this he provided a wooden block on which to mount his camera. Attached to this block was an upright, wooden pole, by which the gadget could be let down into the

• Continued on Page 392

• The gadgets illustrated here were designed for shooting home movies under water. They may easily be built by any amateur and will open up a new and interesting field of movie making.

Fig. 2

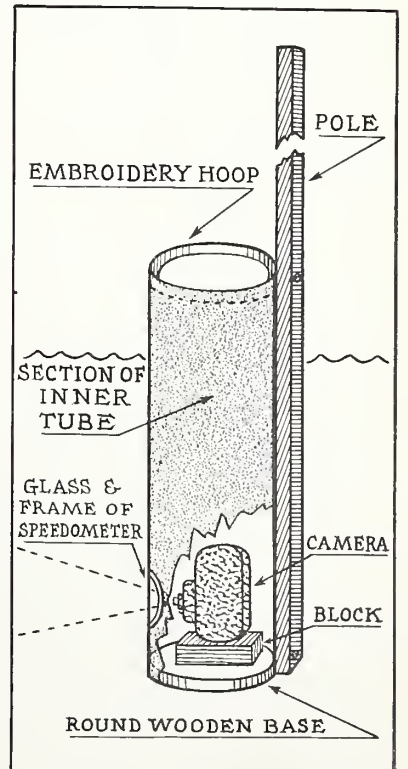

Authored by
R. S. MACCOLLISTER



Let's get acquainted with our CAMERA LENS!

THE time has come, the walrus said, to speak of many things; of shoes, and ships, and sealing wax; and cabbages and kings."

It's also high time to speak of photographic lenses. Far too little has been said about them heretofore; and much that has, was so written that few ordinary mortals could understand it, let alone those just starting to pit their brains against the seemingly baffling problems of cinematography.

Therefore, it has been decided to present, in this and subsequent issues of HOME MOVIES, articles on lenses, written simply, clearly, and completely — leaving out none of the steps to understanding so frequently omitted in the usual lens literature. It is of little use to discuss, learnedly, and with sesquipedalian, jawbreaking words, the finer details of the qualities and characteristics of anastigmat lenses, without a lot of discussion of the essentially simple principles used in those lenses. The average cinebug gets little information out of statements frequently seen in lens catalogues to the effect that "corrections for zonal errors are carried out in a certain lens to a high degree," or other sentences of the same caliber.

However, once the basic principles are put into print, and some discussion has taken place as to the application of these principles to the designing of lenses, the cinebug will be able to appreciate the fact that such information about zonal aberration means simply that there will be no "dud" position in the range of stops on that lens; and this type of information will prove of great value to him. It will give him an appreciation of the qualities and may, perhaps, save him from "stinging" himself in a future lens purchase through lack of correct information.

Lenses are, in themselves, quite intriguing.

• To know lenses—their basic fundamentals, what makes them "tick," and what various makes and sizes will accomplish—is one of the essentials of a good cinematographer.

And, popular supposition to the contrary notwithstanding, quite understandable. They are, to say the least, fearfully and wonderfully made. The accuracy which must be maintained in the manufacture of lenses is far finer than that in almost any other manufactured product. Precision workmanship in automobiles and other mechanical products is well known to everybody. The common conception is that many of these articles are built with the ultimate of accuracy. Yet, the accuracy built into the finest of modern automobiles is crude compared to that used in making an inexpensive f/3.5 one inch lens for a cinecamera.

Engineers use one ten-thousandth of an inch as their unit of precision in designing and building fine, accurate machine work. Lens designers use a unit known as the millimicron, which is one twenty-five-millionth of an inch long, in measuring the characteristics of the glasses used in making lenses. Opticians have to grind the surfaces of lenses the designers ask them to make so that they are not more than one-millionth of an inch away from the proper curve. When it is realized that the human eye, at best, has difficulty seeing one two-hundredth of an inch ten inches away, it is quickly apparent that one-millionth of an inch is far beyond what passed for accuracy before. As for the millimicron, it may be just as well not to try to visualize it.

Lenses made with this accuracy must necessarily be placed in lens mounts made with comparable precision, and the cameras on which they are to be used must be as well made, or the user cannot get out of the lens all the quality built into it. This is one of the reasons why the cost of modern movie cameras may seem high. Actually, considering the care which must go into the manufacture of the complicated optical system of a movie camera, the price is very moderate.

BEFORE the craftsmen who actually make the lenses can go to work, much tedious mathematical calculation must be run through in the designing room. Actually, it takes a full year for a lens computer, working with calculating machines and assistants, to work out the design of a fine aperture anastigmat lens.

The mathematical calculation of lenses is of little concern to the average amateur, nor will it be expounded at length in these articles. However, in order to understand better how to use the lenses of a camera, and to appreciate more fully the precise way such lenses work, a study of the prin-

• Continued on Page 397

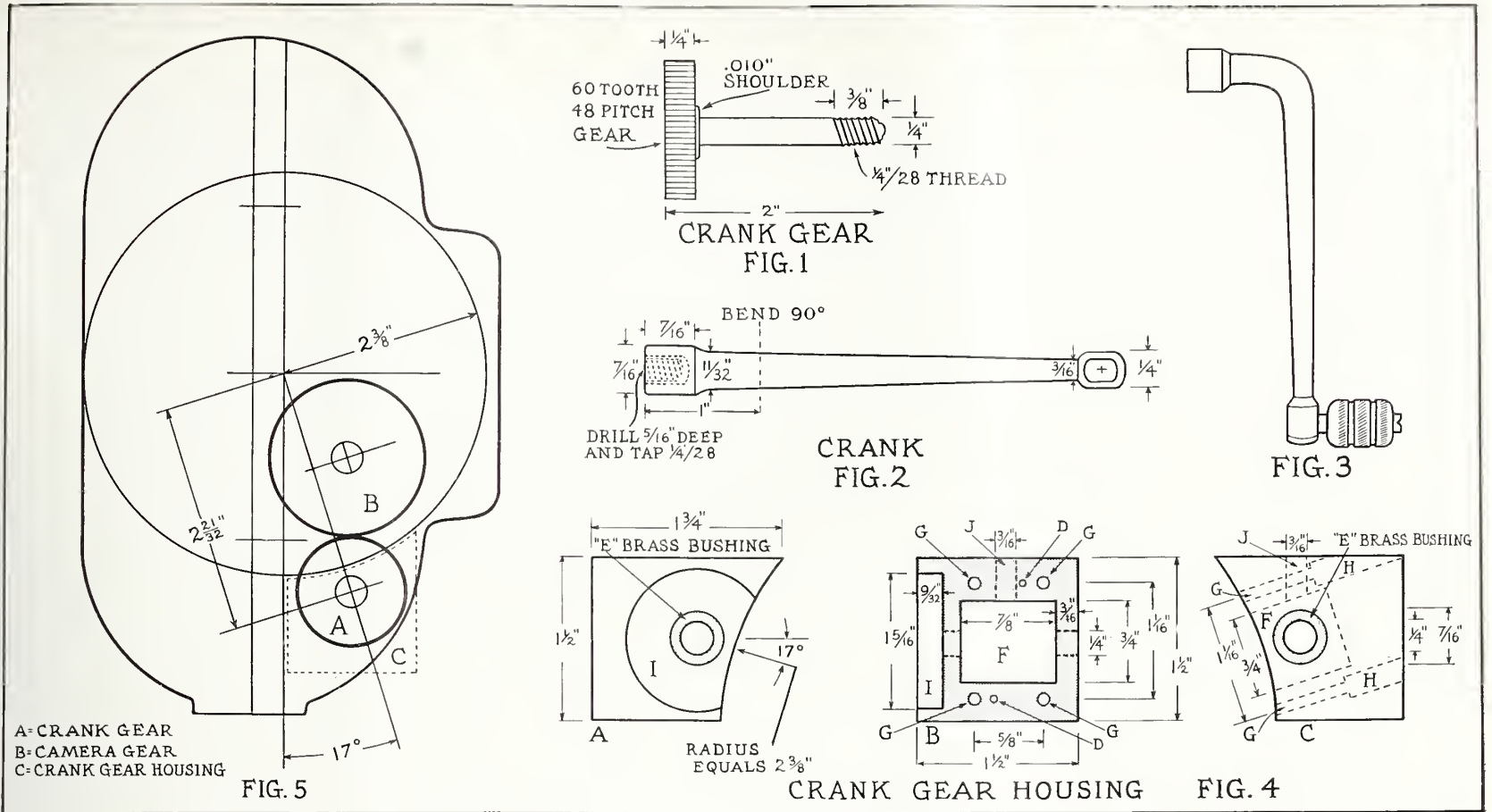

Plans and data for building

the "GLORIFIED 16"

IN the June issue, we introduced the "Glorified Sixteen" — a 16mm Filmo which had been improved with home-made apparatus and attachments that made possible the making of fades, dissolves, and wipe-offs with the precision of a professional camera. This month, description of the actual work involved in making this conversion begins and will continue in subsequent issues until all of the improvements have been described in detail.

The Filmo "70" series consist of three models—the model 70-A, the 70-D, and the 70-DA. Therefore, before proceeding with advice on how to disassemble the motor mechanism of these cameras, it is advisable to describe briefly the relative difference in the construction of each.

Model 70-A was the first Filmo. It has a single lens, with the speed control adjustment and motor governor on the mounting plate in front of the camera. Models 70-D and 70-DA are equipped with a three lens revolving turret. The governor is built in with the main mechanism and the speed control is located just to the rear of the footage counter. There is still another model — the 70-E which is a combination of the model 70-A and the 70-D, except that it provides for mounting a single lens. The governor is located in the same position as on the models 70-D and 70DA. The importance of mentioning these features will be better understood upon taking the camera apart.

We'll take the model 70-A first. To strip the works from the camera case, first and most important is to allow the motor to run down completely. Then remove the lens, and the door to the film chamber. Then place the camera on its back—

that is, with the lens mounting plate up. Remove the four small screws from the plate which will enable removing it from the camera case. But first, cover the starting button with one hand while removing the plate as there is a spring behind the starting button which will cause it to pop out as the plate is removed and the release trigger disconnected. Should the mounting plate not come off freely, reach into the film chamber side and give it a little push.

With the mounting plate removed together with the governor, observation of the gear that drives the shutter spindle will reveal a hole about 1/8" in diameter. A small hook should be fashioned from a piece of stiff wire and inserted in this hole so that when the motor spring is re-wound, the gear will lock. With the hook in place, wind the motor spring to full tension. Then lay camera on side with the film chamber up and remove the four screws that fasten the mechanism to the camera case. The mechanism should slip out of the case freely.

Another good precaution is to place a sheet of newspaper beneath the camera before removing the works in order

Authored by
ARTHUR H. HART

• Below: Partly machined casting for crank gear with gear and spindle in place. When finished, top will be machined to fit cantour of camera case and edges rounded for appearance. This is the unit illustrated in detail above in Fig. 4.

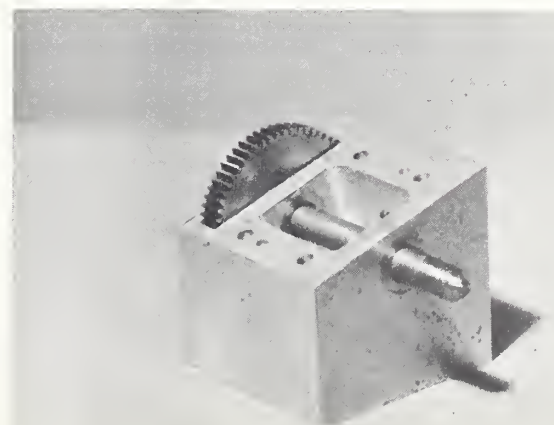

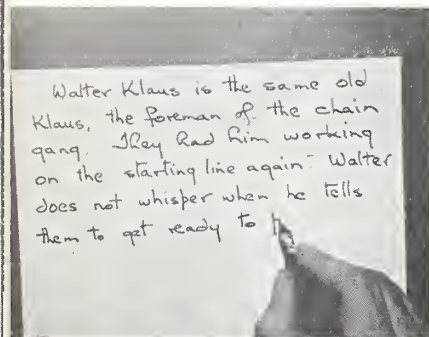

Ski picture voted

MOVIE of the MONTH

Reported by
J. H. SCHOEN

PERHAPS it was the pleasant cooling effect of beautiful snow scenes screened on a steaming July afternoon that influenced the editors in awarding the Movie Of The Month to "St. Margarets," a 300 foot 16mm Kodachrome picture by Gordon MacCormack. Yet, reviewed at any time—summer or winter—the sheer beauty of its carefully filmed scenes of skiers gracefully skimming over snowy mountain trails would cop the honors for this picture.

A masterpiece in color cinematography, "St. Margarets" is a highly interesting documentary of a group of Canadian skiers in interclub competition. It is interesting first because it embodies a subject full of action, and second, because of the obvious care with which camera angles and setups were chosen by the photographer. We'll venture to say that MacCormack spent several days before actually filming this picture, scouting the spots on which he would set up his camera in order to capture action of the skiers against the landscape at its most colorful moments—brief intervals in which the winter sun would be at just

the right angle to backlight mounds and hillocks of glistening snow and cast shadows of the slender trees across the winding ski trails.

The picture opens with a beautiful main title, commercially made and very artistic. This is followed by a sequence of scenes showing members of the ski club arduously ascending the mountain side to the top where the ski race is to start. In finely edited order, there follows intimate closeups of the starter calling to the skiers to make ready; of one skier waxing the running surface of his blades; and of still another snapping the ski clamps in place about his boots.

Following this is a shot of the starter, stop watch in hand, giving the "go" signal. Then a quick cut to the first contestant as he shoves off for the descent. From here on, it is a succession of shots of the skiers whizzing perilously around glistening white ski trails. In many, the camera follows the skier in a highly professional manner, keeping him right in the center of the frame as he executes single and double turns and sometimes a spill.

Without color, of course, the reproductions on this page from MacCormack's film fail to do his picture full justice. However, it may be seen that he is no slouch when it comes to composition. There are a number of scenes where the low descending sun casts long shadows of trees across the ski trail, lending a colorful contrast to an already colorful scene as each skier skims by, throwing a plume of snow high into the air behind him. The sun, backlighting the snow-covered hillocks, tinges the crest of each with a fringe of sparkling diamonds. All of this was here for other cinefilmmers to shoot, but it remained for the cinematic and artistic-minded MacCormack to recog-

• All of the pictures above are enlargements from Gordon MacCormack's 16mm Kodachrome film, "St. Margarets," voted The Movie Of The Month. It is a highly interesting document of a Canadian ski meet, and a masterpiece in color cinematography.

Reviews by
THE EDITORS



TELL ME — *how can I improve my film?*

EVERY amateur movie maker is invited to submit his films to the editors of HOME MOVIES for review and helpful criticism. This free service is offered to all and may enable the amateur to improve his home movie filming, editing, and titling.

As an added service, all films are subjected to a special safety cleaning process before returned. Following are reviews of some of the interesting films submitted recently:

"ARREST BILL JOHNSON!"

400 ft. 16mm — By R. F. G., New York City.

★★★

Continuity: An amateur movie club and a little theatre group joined forces to produce this picture. Of the two, the movie club's efforts predominated as evidenced by the high degree of technical perfection of the picture. The yarn concerns a young lady of wealth and Bill Johnson, a poor but honest garage owner. Their amorous affairs are forbidden by the girl's father. Result: Girl meets boy — on the sly.

One day father misses the 8:45, takes a stroll through the town to kill time, and happens upon the lovers. He attacks Bill, whereupon Bill utters a remark, that is used later to cast suspicion upon him.

Later, a carload of gangsters drive up to Bill's garage to ask directions to a certain mountain where they have arranged for a secret hideout. In short order we discover they intend to kidnap Bill's girl and hold her for ransom. With the aid of the butler, the deed is accomplished after the father is felled with a blackjack in a brief struggle in the garden of his home. Naturally, after father comes to, he suspects Bill of the dastardly deed and sics the police on him. "Arrest Bill Johnson!" is the order to all officers, and in no time at all, Bill is answering questions at police headquarters. But Bill remembers photo of wanted crooks in a recent newspaper; recalls their similarity to gangsters who stopped at garage for information; adds two and two together to give police clue that brings them to the mountain hideout.

Meantime, Bill's hired man has taken the lead

in the picture, and closes in a rush at the finish by aiding Bill in rescuing the girl. Of course, the butler is unmasked and trundled off to jail; and Bill wins the girl, and squares himself with her dad.

Only weakness in the plot is that hero, Bill, is secondary in the climactic rescue of the girl. His assistant takes the show away from him. Stories of this kind depend mostly upon acting ability of entire cast to hold interest. One or two mediocre actors can pull the interest way down, spoil the best of efforts.

Watch bracelet, which formed basis of clue to crooks, overemphasized. Also, butler drew revolver before it was evident that he knew what was going on.

Editing: Material was very well edited. The whole is a very ambitious production, and highly commendable for the excellence of technical treatment given it by this group. Special attention given to such incidents as in one shot the train is shown coming in from one direction, and then, in departing, moving in opposite direction.

Titling: Titling was very good. They were used only where necessary, were well worded, and excellently photographed.

Photography: Was very fine with consistently good expo-

• Continued on Page 398

• Top: Reproduction of enlargement from 16mm film, "Arrest Bill Johnson." Bottom: enlargements from frames of "After Midnight" and "Baat Fever," both 8mm home movies.



THE EXPERIMENTAL

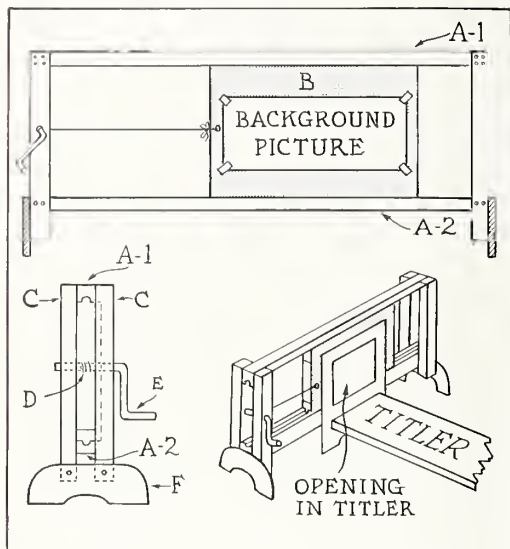

Titling Device

This gadget, which I call a panoramic transport, is a big help in making titles with moving backgrounds. It enables me to provide moving backgrounds of ornamental wallpaper or of scenes clipped from magazines, etc., by slowly and evenly moving them across the title area behind the title text. Carefully done, the results are equal to double-exposed titles.

The two horizontal tracks "A-1" and "A-2" and the sliding member "B" are made from pieces of tongue and groove flooring — the members "A-1" and "A-2" from the grooved edge and the member "B" from the tongued edges. Section "B" is composed of two tongued sections joined together.

The sections "A-1" and "A-2" are supported by the members "C" which in turn are supported by the cleats "F." The track formed by the grooved "A" members should be waxed to facilitate smooth operation of member "B" when fitted to the track. The "A" section should be not less than 15 inches long to insure sufficient space in which to move a lengthy illustration or background. The hand crank "E" may be formed of a short length of heavy wire or annealed iron rod with a hole bored at "D" to take the end of the cord which

is attached to one end of the panel "B." Thus, by turning the crank, the panel "B," on which the title background is attached with small bits of adhesive tape, is moved slowly from right to left when placed behind the card holder of the titler as shown. The title text, of course, must be lettered on glass, celluloid, or cellophane and placed in the title card holder in front of the background. Where both right and left movement is desired, another crank must be located at the right end of the frame, and a cord connected to it from the opposite end of the sliding panel.

— L. W. Hills.

Titler—Matte Box

For filming special effects, I converted my Cine Kodak titler (any small typewriter titler would do) into a matte box. First I made a hood of cardboard, as shown in the sketch, and fitted it between the camera lens and the title card holder. Masks were then cut from cardboard and painted black with liquid shoe polish. The openings in these masks represent keyholes, binoculars, etc., and in order to use, the masks are inserted in

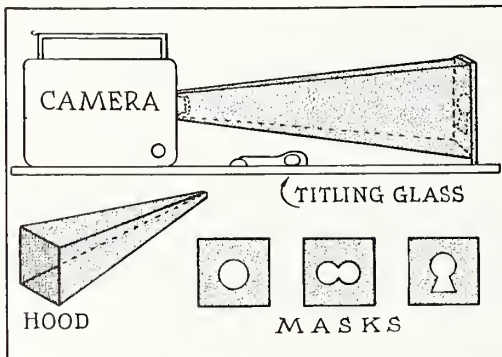

the title card holder and centered. The scene is photographed through the mask to give the desired effect.

— John C. Hoster, Jr.

Trick Gadget

As a means for rotating the camera to obtain novel whirring effects on the screen, here is a gadget which I believe will prove more satisfactory and easier to build than that suggested in the May issue of HOME MOVIES.

By mounting it on a tripod and then securing the camera to it, the camera may be moved axially with the lens to produce such effects as earthquakes, rocking of a boat or automobile, or the dizzy effect of being struck a knockout blow in a boxing match.

As shown in Fig. 1, the assembly consists of an L-shaped support "A"; another L-shaped support for the camera "B"; and the rotating disc "C." The L-shaped members should be made from strap iron or brass one-quarter inch thick. It is important that they be bent exactly at right angles to insure accu-

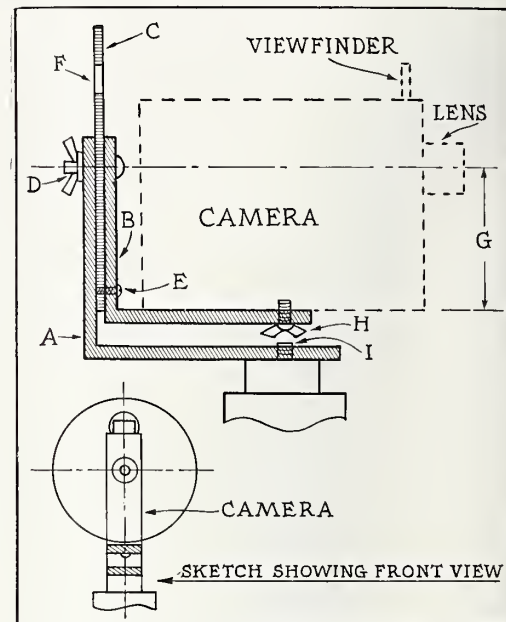

rate rotation of camera so that the lens will remain centered on object during rotation.

The disc "C" may be of metal or plywood and should be secured to the member "B" by means of a machine screw shown at "E." The disc is the means by which the camera is rotated, and in order to provide for sighting through the viewfinder during slight right or left movement of camera, a hole is provided in the disc at "F" which is in line with the camera viewfinder. Dimensions depend entirely upon make of camera to be used. Most important to consider is that distance indicated at "G" which insures camera swinging on the lens axis. Holes drilled and tapped at "H" and "I" provide for attaching camera and tripod respectively.

— L. E. Baty.

Projection Aid

This photo shows a combination pilot light and extension cord reel which I recently made from materials obtainable at any hardware or variety store. The reel ends are made of two aluminum discs, although plywood would serve just as well. The core of the reel is a piece of rounded wood with the center drilled out to allow for countersinking the twin electrical outlet. Into one of the outlet receptacles is plugged a night light with switch. The other receptacle



CINEBUGS!

• If you have an idea for a gadget, trick, or shortcut in filming, titling, editing or processing home movies, pass it on to your fellow Cinebugs through these columns. If your idea is published you will receive two reels for your efforts. Extraordinary ideas will net you a roll of film.

Ideas not published will be held for future publication unless they duplicate ideas previously received. Endeavor also to send along photos or rough sketches illustrating your suggestions. There is no limit to number of suggestions you may submit.

Names and addresses of contributors of published ideas are furnished a prominent manufacturer interested in acquiring rights to saleable gadgets on a royalty basis.

Important: When submitting ideas, be sure to mention whether equipment you use is 8mm or 16mm, enabling us to promptly forward awards adaptable to your use.

C I N E W O R K S H O P

takes the plug of the current feed line. The reel holds 25 feet of insulated cord and after detaching the night light, fits snugly into my projector case. It is a handy gadget to have when movie shows are frequently given away from one's home where current source and light for threading projector is not always convenient.

—Paul V. White.

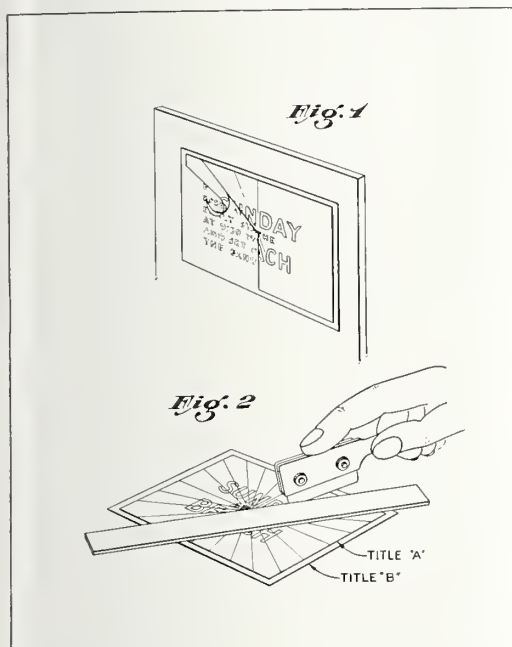

Wipe-Offs

Here is a simple method of making highly effective wipe-off titles. Letter the two title cards, then mount title "A" over title "B" with rubber cement, making sure that the two surfaces to be joined are entirely covered with cement. Next, place the joined cards on a flat surface and with a thin razor blade in a holder drawn against a ruler or straight-edge, cut the title card "A" into sections as shown in Fig. 2, cutting as many strips as frames you wish the wipe-off effect to consume. Make certain the cuts are deep enough to completely sever the top card.

With the title cards thus prepared, place them in titler and start the camera, running it long enough to enable reading text of title card "A." Then stop camera, remove the first strip, and expose another frame. Continue this single frame action until all of the strips have been removed, wiping off title "A" and revealing title "B." A third title may likewise be exposed by wiping off title card "B" by the same method.

—Chas. A. Munz.

Film Tinting

Where tinting of films in light pastel tones is desired, I found ordinary Tintex dyes gave very good results. The Tintex is mixed with water according to directions on the package. Film should be immersed in cold water before placing

in the Tintex bath, which should likewise be cold. The longer film remains in the bath, the deeper the tone. This idea is particularly adaptable to tinting titles for Kodachrome film.

—Harry Ulbricht.

Drying Rack

In a pinch, a birdcage may be put to good use as a drying rack in developing titles or processing cine film. After removing the bird, also remove the perches, etc. With most cages a round stick may be thrust through the cage from top to bottom and bound in place with adhesive tape. A piece of cardboard into which a hole is bored for the stick may be placed over bottom of the cage in place of usual bottom plate. It may not roll as evenly as a regulation drying rack, but in an emergency it's o. k.

—Edward Harris.

Reel Labels

A neat label for cine reels, either 8mm or 16mm, may be typed on ordinary paper, then pasted on the reel. To insure adhesion to the aluminum surface and for permanency, cover the label with a strip of clear scotch tape that is wide enough to overlap the paper label on all sides.

—B. Barney.

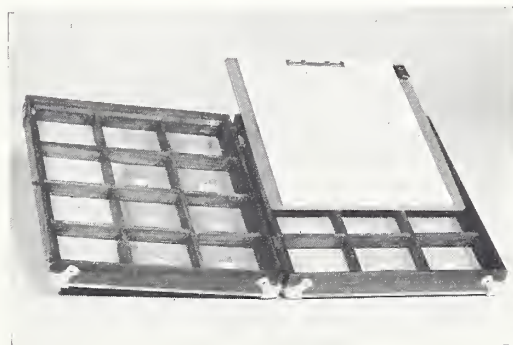

Editing Case

The photo shows a film editing case that I recently made which provides for holding 24 coils of film and a supply of forms for recording descriptions of scenes. The case was made from quarter-inch plywood and finished with luggage protectors at the corners and a small hasp. The dividers were also made from plywood. Each compartment is numbered by means of a small tab pasted in the center. As a film is broken down, the separate scenes are placed in the compartments and a description of same written on one of the record forms. Should an interruption occur during editing, the case may be folded and stored away without disturbing the arrangement of scenes as the panel, which holds the record forms, keeps the two groups of films separated and in place.

—A. W. Wiggins.

gadgets, tricks and short cuts contributed by Cinebugs

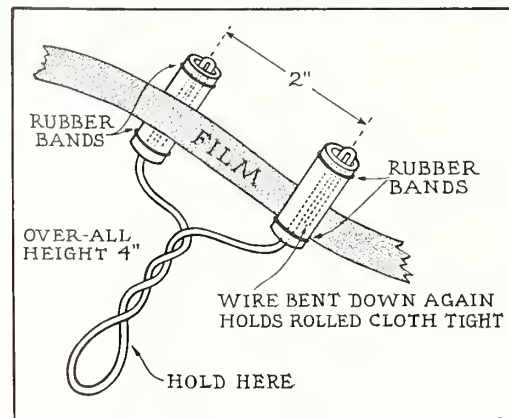

Film Cleaner

Here is a gadget I made for cleaning my cine films. It consists of a handle made from stout wire and twisted to shape as shown. Rolls of soft cloth are wrapped on each stem and the wire turned down to secure the material from unravelling. This cleaning device is used in conjunction with projection or re-winding of films. A small quantity of film cleaning fluid or carbon tetrachloride is applied to the cloth pads. As the pads become too soiled, a portion of the cloth is unrolled and discarded.

—Russell Meyer.

Reflectors

Very efficient reflectors costing but a few cents each can be made for any home movie titler from tinware or aluminum pans obtainable from most variety store counters. All that is needed is to drill or cut out a hole near edge of the pan to allow it to fit snugly over a light socket, and the addition of a regular lamp-shade spring clamp that provides for clamping reflector to photoflood lamp. The lamp-shade clamp is also obtainable from the variety store, and may be attached to the center of the pan by means of a small bolt.

—Joseph Doczy.

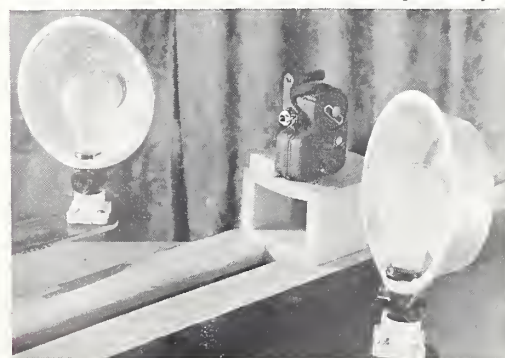

"IT'S NEW TO ME"

By CINEBUG SHOPPER



New Filmo Surprises

Out of the Bell & Howell plant in rapid succession has emerged a number of new cine products. Recently announced was their new intermittent "Filmotion" viewer (see bottom cut) for 8mm and 16mm films which shows movies on a ground glass viewing screen. Featured is a film marking device for slitting edge of film to indicate frame to be cut during editing.

Next is the Filmo Fader (above) for making fades and

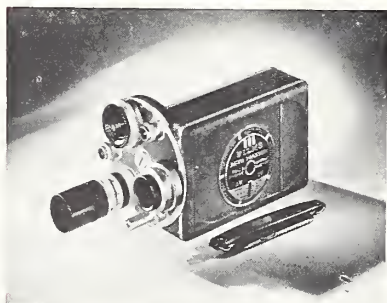

dissolves with any model Filmo camera. Fades are made with a rotating disc which is graduated from opaque black to clear and then back again to opaque. It may be operated with hand-held cameras as well as those mounted on tripod.

Important camera news of the month is the new 16mm Filmo "Auto Master" (above, center), first multi-lens mag-

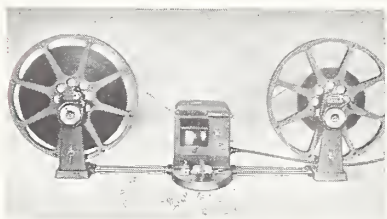

azine loading camera in the industry. A magazine camera with a turret front, it offers instant use of three lenses. Also featured are automatically positioned viewfinders, interchangeable film magazines and freedom from sprocket threading. This new model is a successor to the Filmo model 141, it is said.

Processing Outfit

Hollywood Cine Products, Hollywood, announces a new processing outfit for amateurs who wish to reverse their own films or develop positive titles. It is constructed of wood and finished in acid-resistant paint. The complete outfit consists of developing reel, stand, drying rack and stand, two shatter-proof 8"x10" photo trays, and complete instructions for use, including formulas. Capacity of both developing reel and drying rack is 34 feet of double 8mm or 16mm film.

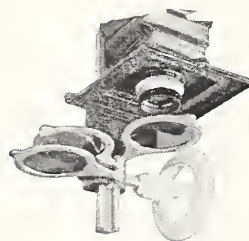

Tri-Color Filter Set

Color-minded still photographers will be interested in announcement of Burke & James, Inc., New York City, of their new tri-color filter set for the Solar enlarger. The set includes three Wratten filters in standard colors of red, blue, and green for color separation work. The entire unit replaces the regular ruby filter on the Solar enlarger. A touch of the finger changes from one filter to another.

New Cine Kodak

An f/1.9 model of the Cine Kodak "E" (formerly available with only an f/3.5 lens) is announced by Eastman Kodak Company. This popular Cine Kodak includes among other features a choice of three film-

ing speeds; a fully inclosed viewfinder placed close to the lens for minimum parallax; a footage indicator which shows at the edge of the viewfinder field; a simplified gate for easy loading; and an exposure lever which can be locked. The camera takes either 50 or 100 foot rolls of film. Provision is also made for interchange with other Cine Kodak lenses of wide angle or longer focal length.

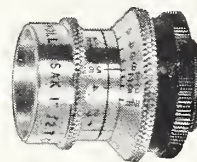

8mm Telephoto

Wollensak Optical Company, Rochester, N. Y., announce a new telephoto lens for 8mm cameras. Specifications: 1 in., f/2.7, and equipped with micrometer focusing mount and iris diaphragm to fit 8mm Keystone, Revere, Bolex and Emel cameras. This lens is said to give double the magnification of the usual 12½ cine lens.

Camera Improvements

Mercury Movie Equipment Repair Company, New York City, is extending its custom camera rebuilding service, making it available to cine fans from coast to coast.

Among the special devices which they now build are: Backwinds and frame counters; single frame release attachments; external film magazines; electric motor camera drives; turrets and lens adapters; internal masks for partial exposures; and sound on disc conversions for 8mm and 16mm cameras and projectors.

Latest Castle Film

Castle Films announce now ready for distribution their newest film on European events—"Battle for France"—available in 8mm and 16mm widths.

"Battle for France" is said to be a highly dramatic, au-



thentic movie record of the fall of a great republic. Brave efforts of Allied forces to stem the onrushing tide of Nazi hordes in Belgium are shown, then the preliminary bombing of Paris, and eventually the complete collapse of France.

According to Castle Films, the making of this picture had cameramen closer to the front and more action was filmed than in any other assignment so far.

New Catalog

A "Summer Specials" edition of the well-known Central Bargain Book is now available for distribution, states an announcement of the Central Camera Company of Chicago. Like all previous Central Bargain Books, this one includes many thousands of items in the photographic field regularly carried in stock by this 41-year-old firm. It features products particularly in demand during summer months.

Bolex-Bromm Titler

American Bolex Company announces it will now distribute exclusively the new Brown Micro-Matic Titler. Constructed entirely of metal, this new titler offers many outstanding features. It may be used in either vertical or horizontal position and accommodates either 8mm or 16mm cameras

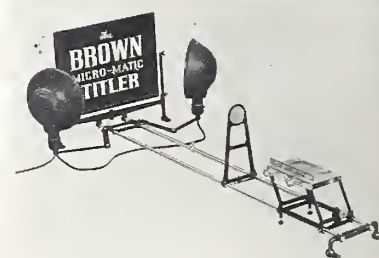

of any make. Title centering is simplified and titles may be made from small hand-lettered or typewritten cards or from title cards up to 9"x12" in size. Two reflectors for photoflood lamps are supplied and the extension arms permit lights to be adjusted behind title card as well as in front for transparent effects.

Titling . . .

• Continued from Page 377

etc., forgetting that title-writing is the task at hand.

For this reason, then, it is usually best to ask someone entirely unfamiliar with amateur movie making to view the film. A total stranger is recommended, when such can be secured. The person chosen should be someone unacquainted with the subject matter of the film, and be instructed to ask all the questions he cares to about the film, no matter how simple or commonplace they may seem. He should be urged to ask them at the moment they come to his mind—while the film is being projected—and not wait until after the picture is over.

The amateur sits with pencil and paper in hand, writing down not the questions the onlooker asks but the answers to these questions. These answers will prove to be the best titles anyone could desire.

Many times some of these answers will appear to be answered by the film, and consequently a title will not be needed. It is this point the amateur should bear in mind most carefully, that often a scene or bit of action which appears very plain and obvious to the maker of the film is not at all clear to the audience.

In case of doubt as to the necessity of a title at some controversial point, many amateurs ask three or four persons to view the film at different times, again requesting that they ask questions about anything in the film at any time. The answers are jotted down, and a comparison of them is made. If the same answer appears all four times, there is no doubt that it must be

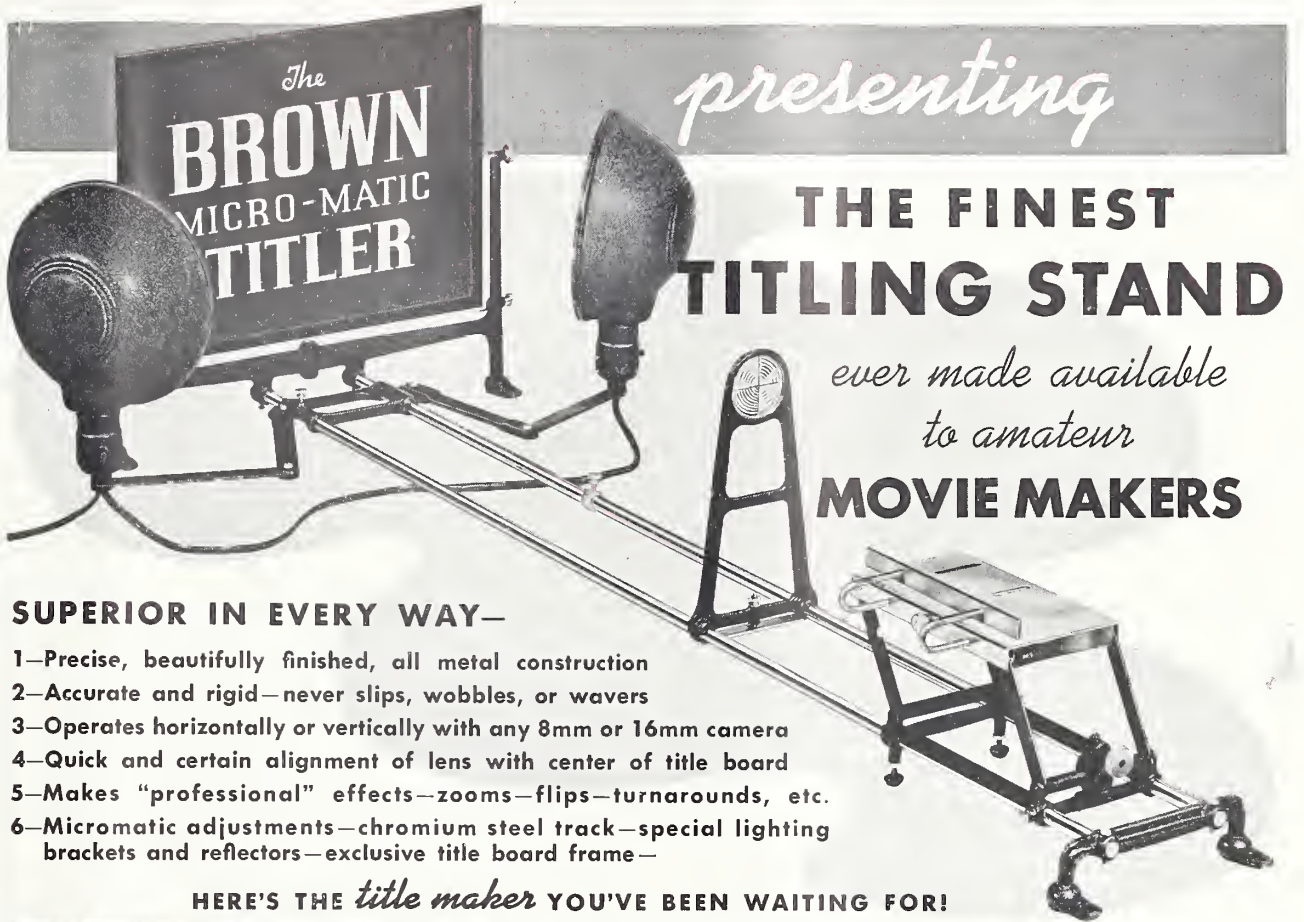

THE FINEST TITLING STAND ever made available to amateur MOVIE MAKERS

SUPERIOR IN EVERY WAY—

- 1—Precise, beautifully finished, all metal construction
- 2—Accurate and rigid—never slips, wobbles, or wavers
- 3—Operates horizontally or vertically with any 8mm or 16mm camera
- 4—Quick and certain alignment of lens with center of title board
- 5—Makes "professional" effects—zooms—flips—turnarounds, etc.
- 6—Micromatic adjustments—chromium steel track—special lighting brackets and reflectors—exclusive title board frame—

HERE'S THE *title maker* YOU'VE BEEN WAITING FOR!

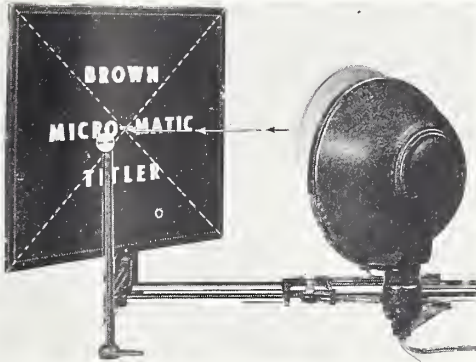

Makes TITLES the CERTAIN way

THE BROWN MICRO-MATIC TITLER is not just another contraption to confound the amateur—it is a completely designed and precisely built instrument which, for the first time, provides the movie maker with the means for making the finest titles at minimum expense and effort.

Precision and accuracy of adjustment are of paramount importance in a title maker. In providing these features to a degree never before made available, the BROWN TITLER has filled an urgent need. The BROWN can be dismantled quickly and stored in small space—but it will always retain its accuracy and rigidity when re-assembled for use. There is no other title maker like the BROWN.

Next to accuracy and neatness the most desired quality in movie titles is *variety* and the

COMPLETE SET INCLUDES
 BROWN TITLER STAND . . . 9" x 12"
 TITLE FRAME . . . CLEAR AND OPAL
 GLASS PANELS . . . CORK PANEL . . .
 VERTICAL PIVOT BEARING . . . TWO
 HORIZONTAL BEARINGS . . . TURN-
 AROUND AND FLIP-OVER STOP . . .
 ZOOM STOP . . . TWO SPECIAL LAMP
 REFLECTORS . . . ADJUSTABLE LAMP
 BRACKETS . . . SOCKETS . . . EXTENSION
 CORD . . . MICROMATIC ADJUSTABLE
 CAMERA TABLE . . . TARGET SIGHT
 AND AUXILIARY LENS HOLDER . . .
 FIELD CHART FOR LENSES . . .
 AND FULL INSTRUCTIONS . . . \$27.50

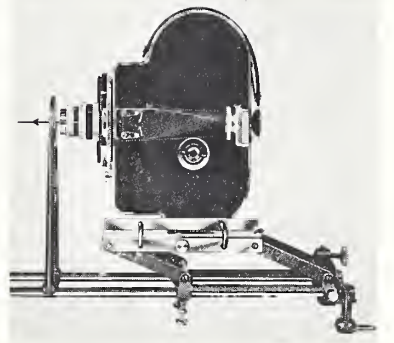

working range of the BROWN. At 31" when stopped down to F/8 or F/11, even fixed focus lenses will produce needle sharp titles.

An actual hand, writing titles can be photographed easily, of course. The BROWN TITLER is always a precise copy stand and is readily adaptable for photographing many small subjects at close distances. When used in a vertical manner the movable parts of the BROWN all can be locked in desired positions.

BROWN incorporates those features of design which provide the greatest opportunity for creating "professional" effects—projection shots—animations—back-lighted titles—zooms, etc.

Any cine camera fits on the BROWN. Titles the size of a small calling card (2" x 2 5/8") and small type up to large letter sizes on the 9" x 12" board all are within the 31"

Designed for performance, and precision-made of quality materials—
 It's fully guaranteed—so, when you get a title maker, get a BROWN

See your local dealer or write direct to:

AMERICAN BOLEX COMPANY
 155 EAST 44th STREET • NEW YORK, N. Y.

used. Answers which appear only once are not so important. The worker who uses this system will be surprised at the number of identical questions asked by the different onlookers.

More and more filmers are writing out their continuities before they start to film them.

Many times the script is complete with titles worded exactly as they are to appear in the finished film. For some strange reason, a movie seldom looks the same on the screen as it does in the script. Many sequences which appeared strong in the script are mediocre when projected, and vice versa. Titles

often have to be re-written. Some will be found not to be needed at all, while other times additional titles will have to be inserted. For this reason it is best to leave all titles until the last. After the film has been edited, the titles called for in the script can be compared with the projected action and the necessary changes made.

DU PONT

REGULAR PAN

C. K. KELLY

**Puts
Sunshine
in Your
Movies**

Outdoor Speed

The speed of Regular Pan is just right for Summertime use. Bright scenes take f:16, the smallest opening on your lens.

Wide Latitude

You get a whole roll of good shots with this versatile film. Its wide latitude corrects for common exposure errors.

Panchromatic

Sensitive to all colors of light, Regular Pan produces beautiful cloud effects when used with a filter.

Brilliant Projection

Complete removal of the non-halation coating in processing gives your pictures plenty of sparkle and brilliancy.

Economical

Priced to fit a budget, Regular Pan stretches your dollar over more feet of film. Sold by all leading camera stores.

\$4.50 100 ft.

DU PONT
FILM

Du Pont Film Mfg.
Corp., Inc.
9 Rockefeller Plaza, N.Y.C.

"Glorified Sixteen . . ."

• Continued from Page 381

to catch the graphite that may be loose and fall out from between the coils of the spring.

As the works are removed from the case, dunk it in a can of gasoline, washing off all graphite, etc. The wire hook may now be removed from the gear by applying a little pressure on the winding key. The motor spring may be gradually run down by rotating the gears or by using the key. The motor mechanism is now ready for study, and the camera case ready for cutting the slot to accommodate the new crank gear as shown at "A" in Fig. 5. But before this slot is cut, the crank gear, handle, and the crank gear housing should first be constructed and fitted to the camera case.

The details of the crank gear and the crank and handle are amply explained in Figs. 1, 2, and 3.

Details of the crank gear housing are shown in Fig. 4. This unit may be ma-

chined from a piece of cast aluminum according to the dimensions given. The top of the unit is machined on a curve in order to fit snugly against the camera case of the model 70-A. This feature is altered slightly for other models.

The block of aluminum should be machined to measure 1½"x1½"x1¾". The angle of 17° is measured on the long side and the radius of 2⅜" is turned. Next, lay out the markings for the mounting screw holes, as shown at "G," drill the holes and countersink them deeply as shown at "H," sketch "C," Fig. 4.

The unit should now be fitted to the camera case as shown by the dotted lines in Fig. 5. The crackle finish should be scraped from the case at this point and the surface rubbed down smoothly. With the machined unit held firmly in place against the spring housing of the camera case, mark the case with a long, sharp instrument inserted

Movie of the Month

• Each month the Editors of HOME MOVIES select the best picture sent in for analysis and designate it "The Movie of the Month." This movie is given a detailed review and a special leader is awarded the maker.

This award does not affect the eligibility of such films for entry in the annual HOME MOVIES CONTEST. They are automatically entered for rejudging with those films submitted especially for the annual contest. Films awarded the honor of MOVIE OF THE MONTH during past 12 months are:

1939

SEPTEMBER: "Within the Garden Gates," produced by Murray Beliz, Sacramento, Calif. A 200-ft. 8mm Kodachrome film.

OCTOBER: "Hummingbirds," filmed by Richard L. Cassell, D.D. S., Los Angeles, Calif. A 16mm Kodachrome film, 400 ft. in length.

NOVEMBER: "Esquire's Escapade," produced by Clarence M. Aldrich, Long Beach, Calif. A 16mm picture 800 ft. in length.

DECEMBER: "Souvenir," produced by Harold E. Remier, Hollywood, Calif. A 100-ft. 8mm Kodachrome film.

1940
JANUARY: "The Cauldron," produced by Dr. R. E. Gerstenkorn, Beverly Hills, Calif. A 16mm picture 400 ft. in length.

FEBRUARY: "Whistling Wings," produced by W. H. Nordin, Austin, Minn. A 16mm Kodachrome picture, 400 ft. in length.

MARCH: "Checking Off the Budget," produced by B. W. Johnson. An 8mm Kodachrome film, 1000 feet in length.

APRIL: "El Lobo," produced by Demetris Emanuel. A 16mm picture, 400 feet in length.

MAY: "From A to Z," produced by Vernon Altree, Stockton, Calif. A 16mm Kodachrome film, 400 feet in length.

JUNE: "Peetie," produced by Edmund Turner, Detroit, Mich. A 16mm Animated Cartoon, 400 feet in length.

JULY: "Song of the Soil," produced by E. C. Denny, Buffalo, N. Y. A 16mm Kodachrome film, 800 feet in length.

AUGUST: "St. Margarets," produced by Gordon MacCormack, Montreal, Canada. A 16mm Kodachrome film, 400 feet in length.

8mm — MOVIE FILM — 16mm

CINECHROME—Weston 8—Semi-Ortho Fine Grain
Non-Halation Outdoor Film—High Quality
50 ft. Single 8 \$.75
33 ft. Double 8 1.25
100 ft. 16mm 3.00
Reversal Processing and Postage Included
5 Rolls or More, 10% Discount
State Name of Camera

8mm — BULK MOVIE FILM — 16mm

Complete New Reversal and Title Instructions Free with Film Orders. Separately, 25c each. Cash, Check or Money Order for Quick Service. Remit 1/3 with C.O.D. Orders. Special Delivery, 15c extra.

NEW SUPER PANCHRO REVERSAL

Weston 24-16—Anti-Halo Backing
400 ft. 100 ft. 33 ft.
Double 8 \$13.00 \$3.60 \$1.30
Single 8 7.00 2.00 .80
16mm 11.60 3.25

NEW MICROGRAN PANCHRO

Weston 12-8—Anti-Halo Backing
400 ft. 100 ft. 33 ft.
Double 8 \$11.80 \$3.50 \$1.20
Single 8 6.75 1.85 .70
16mm 11.50 3.15

NEW HIGH SPEED ORTHO

Weston 16-6—Anti-Halo Backing
Prices Same as New Microgran Panchro

These 3 New Reversal Films are Provided with SPECIAL BLACK ANTI-HALO BACKINGS. Daylight loading without leaders, scored for easy separation.

WESTON 8 SEMI-ORTHO REVERSAL

Weston 8-3 Darkroom Loading—Lab. Packed
400 ft. 100 ft. 33 ft.
Double 8 \$ 4.00 \$1.50 \$.60
Single 8 2.75 1.00 .40
16mm 4.00 1.15

Clear, Lavender, Amber, Blue, Yellow in 16mm.
Only Clear and Lavender 8mm Scored.

CINECHROME REVERSAL

Weston 8-2—Violet Non-Halation Base
400 ft. 100 ft. 33 ft.
Double 8 \$ 5.75 \$1.75 \$.75
Single 8 3.50 1.15 .50
16mm 5.25 1.50

SUPER CINEPAN PLUS

Weston 50-40—Violet Non-Halation Base
400 ft. 100 ft. 33 ft.
Double 8 \$13.50 \$3.55 \$1.45
Single 8 7.90 2.15 .80
16mm 12.50 3.50

CINE-KOOLAK POSITIVE TITLE FILM

Weston 6 (Mazda), Darkroom Loading, Lab. Packed
400 ft. 100 ft. 33 ft.
Double 8 \$ 4.10 \$1.35 \$.60
Single 8 2.15 .90 .40
16mm 4.00 1.00

Clear, Purplehaze, Yellow, Red, Amber, Special Blue.
Also DuPont Lavender, Pink, Light Amber.

CAMERA SPOOLS WITH CANS—Each

Double 8 \$.35 Keystone St. 8 \$.35
Univex 8 20 16mm, 50 ft.50
Filmo St. 8 50 16mm, 100 ft.60
EXTRA CANS, Double 8 and Straight 8 size05
100 ft. and 50 ft. 16mm size 1.00
Non-Humidor, 400 ft. 20c; 6 for 1.00

MISCELLANEOUS

BAIA Precision All Metal 8mm Slitter \$2.50
FOTOFADÉ DYE, for making Chemical Fades 1.00
FOTOFADÉ WIPE-OFF TAPE, per roll60
CINETINTS, 6 Colors and Instructions 1.00
DuPont VISCOSÉ SPONGES, each35
HOW TO TITLE HOME MOVIES, book, each 1.00
HOME MOVIES, Back Issues, 1936-37-38-3915
Back Issues, 1940, each30
TITLE DEVELOPER, tubes, each make 16 oz.15

FILM PROCESSING—PER ROLL

	Reversal	Title Developing
Double 8	100 ft. 33 ft. 100 ft.	33 ft.
Single 8	\$2.00 \$.65 \$1.75	\$.75
16mm	1.00 .35 .75	.40
	1.50	1.25

WE STOCK EVERY MAKE FILM
Write for Complete NEW Price Lists
A PERSONAL MOVIE SERVICE
Telephone Lincoln 1207

W. STUART BUSSEY FILM LAB.
17 E. St. Joseph St. Indianapolis, Ind.

HYPER CINOR 8MM.

WIDE ANGLE

LENS Attachment

CAPITAL CAMERA EXCHANGE

1003 PA. AVE., N.W.
WASHINGTON, D.C.

HYPER CINOR gets you a WIDER ANGLE with your OWN 8 mm camera lens
• Doubles the angle without loss of lens speed
In stock for immediate delivery for use on the following 8 mm cameras • Bolex • Bell & Howell • Keystone • Revere • Univex • Eastman Model 60 and 90. Write for our special bargain list of used items.

\$39.75

Your Own Metal Title Letters

Ask for Samples of the Most Beautiful Capital and Lower Case Letters Made

Titler your films with

METAL Letters

Professional

EASY

Complete Sets in Wood Case, 222 Pcs. . . . \$7.16
126 Caps Only . . . \$4.28
AN INTERESTING ADDITION TO YOUR MOVIE HOBBY
Specify White or Black Letters
KNIGHT & SON, INC. P. O. Box B, Seneca Falls, N.Y.

in the holes "G" (just described) for drilling corresponding holes for the mounting screws. Drill and tap for 4-36 screws.

The machined unit, which we shall refer to henceforth as the crank gear housing, should now be mounted in place against the spring housing of the camera. This will enable us to determine correct position of the crank gear "A," the calculation of which is illustrated in Fig. 5. With the gear housing properly marked, it is removed from the camera case and a hole 7/16" in diameter drilled clear through the housing at the point of marking. Then a piece of brass rod is fitted into either side, as shown at "E," and a quarter-inch hole bored in each to form bearings for the crank gear spindle. Next turn in the recess "I" for the gear as shown in Fig. 4. This should be 1-5/16" in diameter and 9/32" deep.

Fig. 4, "B" and "C," show dimensions for the sump or recess "F" to be milled in the gear housing. It is here that the bevel gears will be mounted on the crank gear spindle and on the shaft extending through the opening "J" to the secondary gear box—all of which is to be described later. Incidentally, in laying out this shaft hole, it will be noted that no dimensions are shown other than the shaft diameter. To arrive at the correct placement point, a line should be scribed through the center of the crank gear shaft hole around to the front face of the crank gear housing. A line should then be scribed up and down that conforms to the center of the sump, as shown in Fig. 4, "B" and "C." Cut the shaft hole with a 11/64" drill, then ream it to a finished fit with a 3/16" reamer. With this completed, the crank gear and spindle may be fitted to the housing.

The next step is to fit the crank gear housing, together with the gear, to the camera case. Before this can be done, a hole must be cut in the camera case to allow the crank gear to enter and mesh with the larger gear shown at "B" in Fig. 5. A simple method for accurately marking the area to be cut out on the camera case is to apply a heavy coat of light colored paint to the top

surface of the gear housing illustrated in sketch "B" in Fig. 4. By screwing the gear housing in place, an outline of the housing will be imprinted upon the camera case, leaving the area indicated at "I" blank. This is the area to be cut out of the camera case, and which will admit the crank gear to contact the large gear of the camera mechanism. The paint applied to the gear housing, and also that imprinted upon the camera case, may be removed while still wet with a rag saturated in gasoline.

The camera is now ready for replacement of the motor mechanism, and with this done, the gear housing may be bolted into place with the gear meshing with the camera gear as shown at "A" and "B" in Fig. 5. A very small amount of backlash should be felt between the gears, but if too much prevails, it is advisable to re-align the gear housing for a closer fit of the gears by moving the housing forward and re-drilling the mounting holes to take larger screws. If fit of the gears is too tight, then the housing should be moved back and the mounting holes re-drilled accordingly.

With the entire crank gear assembly accurately fitted and in place, pilot pins should be inserted into the camera case to engage the guide holes in the gear housing shown at "D" in Fig. 4. Position for drilling holes for the pins in the camera case may be determined by following the method described earlier—that of applying paint to the top surface of the gear housing and imprinting the surface design on the camera housing. This will leave an imprint of the guide pin holes which should be drilled to a depth of 1/8". Into these holes drive two steel pins, rounded on the ends that enter the gear housing. These pins will insure accurate alignment of the gear housing each time it is attached to the camera, insuring proper mesh of the gears.

Next month we shall describe construction of the secondary gear box which is attached to the front of the crank gear housing, and which controls operation of the effects devices for fades and wipe-offs.

"Into the Corral"
By H. R. Crandall,
using Kodak
Panatomic-X Film



Good Work Is a Graflex Habit

CONSISTENTLY good work becomes habitual, with a Graflex. Its instant adaptability is one of the reasons. For example, on most models you have your choice of twenty-five focal plane shutter speeds and "time."

And because you see your picture in the hooded ground glass up to the instant of exposure, your compositions are readily

and easily determined, your picture sense becomes keener.

The Series B revolving back Graflex shown above is available in three sizes, 2 1/4 x 3 1/4, 3 1/4 x 4 1/4, and 4 x 5. With f/4.5 Kodak Anastigmat lens and Film Pack Adapter, the prices are, respectively, \$91, \$107, and \$128. Accessory telephoto lenses are instantly interchangeable.

Graflex and Speed Graphic Cameras are made by the Folmer Graflex Corp.

EASTMAN KODAK COMPANY, ROCHESTER, N. Y.

AND NOW... for Cine' Fans!

THE WESTON *Master*
CINE'
EXPOSURE
METER
(Model 720)

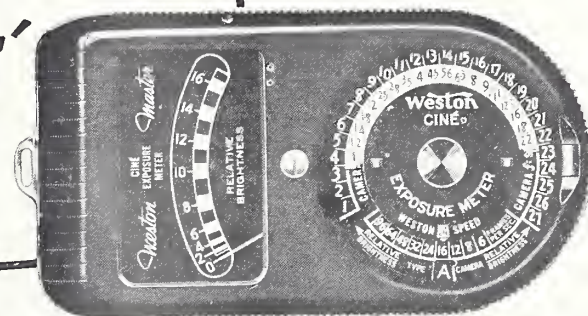

Here's the news ciné fans have been waiting for...news which means *better exposures* for both black and white and color movies! » » » It's the new Master Ciné Exposure Meter...incorporating all the advantages, all the advanced design features, of the famous Master Universal Model...but especially adapted for utmost convenience and simplicity in movie making.

It has the Master's legible and automatic "High Light - Low Light" scales...for easier, quicker reading! It has *far more* sensitivity than is needed, even when the highest speed film, slowest shutter speed, and the fastest lens equipment are used. It

has a highly selective, sharp-cutting viewing angle...essential for correct ciné exposures outdoors, and especially for color work. In addition, it has WESTON's exclusive "pre-set" exposure dial. This eliminates any manipulation while taking a picture; for film speed, shutter speed, and camera type, all are set in advance! » » » You will want the complete facts on this aid to better movie making. Visit your dealer's today for a demonstration; or write direct for illustrated bulletin... Weston Electrical Instrument Corporation, 585 Frelinghuysen Avenue, Newark, N. J.

—WESTON Exposure Meters—

GREAT VALUES OUT OF NEW
Free
LAFAYETTE CATALOG

FILM CEMENT

1 oz. bottle 18¢ 4 for 69¢

1/2 oz. bottle 9¢ 4 for 29¢

**CRYSTAL BEADED SCREEN**

This practical, easily handled 30 x 40 crystal beaded screen features a complete lack of halation from front or sides. Has 4 times the reflectibility of an ordinary screen. Roller type. Metal post support.

ONLY \$4.49**REELS AND CANS**

Reel values! Made of heavy aluminum. Patented sprocket device accommodates every type reel arm. Humidars of heavy gauge aluminum.

8 mm. Reel 29¢ Each
8 mm. Can 6 for 1.6916 mm. Reel 39¢ Each
16 mm. Can 6 for 2.27**REEL CLIPS**
8 mm.—6c ea.
12 for 67c
16 mm.—8c ea.
12 for 89c**CLIP YOUR ORDER TO COUPON**

Save time and money! Just enclose this ad, or any part, or note attached to coupon, along with your check or money order. Mark each item you desire and mail today.

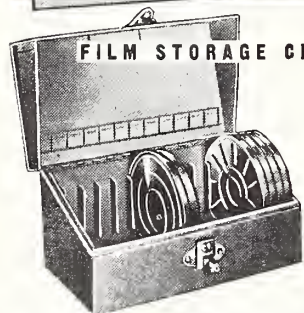
ALL MERCHANDISE GUARANTEED**FILM STORAGE CHESTS**

8 MM.
6-Reel Capacity
\$1.85
12-Reel Capacity
\$2.55
16 MM.
6-Reel Capacity
\$2.25
12-Reel Capacity
\$2.95

ORDER NOW!**SEND FOR BIG FREE CATALOG!****IT'S BRAND NEW!**

A whole back of great values in photography! Complete, up-to-the-minute, packed with all the latest nationally advertised cameras and equipment. It's money-saving! Send coupon for your FREE copy at once!

Lafayette Camera

NEW YORK
CHICAGO
ATLANTA
BOSTON
NEWARK
BRONX, N. Y.
JAMAICA, L. I.

LAFAYETTE CAMERA
DEPT. 80H—100 SIXTH AVE., NEW YORK, N. Y.

I ENCLOSE \$ RUSH MY ORDER
 PLEASE RUSH FREE CATALOG No. 81.

NAME

ADDRESS

CITY

STATE

Perspective, Balance — factors in Composition . . .

• Continued from Page 369

troublesome. We have to think of other means to approach a third dimensional effect. Let us consider an example. Standing on a mountain top we admire the beautiful vista that opens up before our eyes. We raise the camera to our eye and shoot a couple of feet. When we later project our film, we are greatly disappointed. The whole scene looks flat and nothing like the vista we remember.

First of all we saw the scene in three dimensions and we have projected it only in two. Second, when we were standing on that mountain we admired the scene because we unconsciously compared the distance of the far-away mountains with some object close by. Maybe it was from our eyes to the ground, maybe to a tree on our right. But we had something with which to compare that distance far away.

We need such comparison in our two-dimensional picture. And as a rule it can be easily obtained. Perhaps only a few steps back would bring a boulder or a tree into the foreground, or a person or a railing. The accompanying photograph illustrates this point. Note how the camera was moved back and swung slightly to the right in order to get a part of the ship's rigging and deck in the foreground. By bringing some object into the foreground it serves as a comparison to objects in the distance and thus imparts a sense of depth to the scene.

This practice does not apply to distant views alone. The same rule applies to any scenic picture. We need a definite foreground. We have to compose our scene in two or more planes with one or more objects appearing prominently between the immediate foreground and the background. The theatrical director uses this method to increase the depth of his stage for outdoor scenes. He uses "wings," thus building his scene in two or more planes, creating the illusion of depth.

In some cases this might be impossible to accomplish.

For instance, in photographing a building, should a tree or a lamp-post not be at hand, take an angle shot of the building and the picture will have far more perspective than if photographed straight on.

The second important factor in composition, Balance, is perhaps the most difficult

In every picture there is, as a rule, one outstanding object. Every scene will have a certain point that first attracts the eye, and the picture should be built around this object. The main rule in handling the main object is never to place it in the center of the picture except when it calls for absolute symmetry and where the photographer wants to reproduce symmetry in his picture. Do not think that a human face is symmetric. According to the teachings of the artists of old Greece, this main object of interest should be placed between two-fifths and one-third from either side of the picture, horizontally and vertically.

The same rules apply to scenic vistas where there is no special object of interest, its only prominent feature being the horizon line. If the foreground is the main interest in the picture, the horizon should be somewhere about that distance from the upper edge of the picture. If the sky with beautiful cloud formations is of main interest, then place the horizon at that same distance from the bottom edge of the picture. But the line of horizon in such a scene should never divide the picture in half.

It is very essential that the eye should be lead into the picture and not out of it. For instance, roads, rivers, brooks, and so on should never lead out of a picture. In other words, they should come into the picture in its lower half, and even if stretching across the whole picture and out again it has lead the eye into it to begin with. Slanting and diagonal composition in pictures is much approved as are figures that, with an imaginative eye, may be construed as geometric or alphabetic in form.

The proper background and surrounding to the main object of interest is a factor often sinned against. If the photographer hopes to get satisfactory pictures, he should first analyze what he is going to take. If a scene has a definite main object of interest the picture should be taken so that

The WINNERS of the 1940 ANNUAL HOME MOVIES CONTEST

. . . will be announced in the September issue.

The number of entries far surpassed those of last year. Not only has HOME MOVIES' annual contest become the major competition among amateurs, but the awards are greater—more significant.

This year, in addition to the usual awards already announced, HOME MOVIES will give special recognition to those amateurs whose films display particular skill in the various branches of cinematic art—photography, editing, titling, animation, etc. Separate trophies are to be awarded for outstanding achievement in each.

Next month we shall publish the names of the contest winners, together with a description of and illustrations from each of the winning pictures.

Again this year, Lloyd Bacon, Warner Brothers' ace director, will award the major prize—the Lloyd Bacon Trophy.

to set to rules. Not that rules are lacking. On the contrary, there are so many that few can learn them all. It is balance in the picture that makes it most pleasing to the eye, and therefore it is the most important factor in composition. It is the factor where an artistic eye plays its part. An artist recognizes immediately if a scene is balanced or not, and a sixth sense leads him to the spot from where he can obtain a picture with best composition.

HOME MOVIES FOR AUGUST

BETTER MOVIE FILM

8MM at LOW COST 16MM

4-STAR REVERSAL PROCESSING gives results identical with more expensive film.

"Dated REVELATION" REVELATION No. 1—Daylight 12. Semi-ortho, fine grain.

★ 30 ft. single 8mm.....\$.75 each 25 ft. double 8mm.....1.50 each

★ 25 ft. 16mm.....1.75 each 100 ft. 16mm.....3.00 each

★ 25 ft. double 8mm.....\$1.00 each 50 ft. 16mm.....2.00 each

★ 50 ft. 16mm.....2.75 each 100 ft. 16mm.....4.50 each

★ A Reversible Safety Film—Weston 6 50 ft. 16mm.....\$1.00 per roll

PACIFIC COAST FILM CO.

1510 No. Sierra Bonita Hollywood, Calif.

16mm Sound on Film

- "Border Menace" "Phantom Cowboy" "Western Racketeer" "Border Guns"

Western Features 6 Reels Each

Starring

BILL CODY TED WELLS JIMMY AUBREY FRANKLIN FARNUM WILLIAM DESMOND WALLY WALES

PARK CINE LABORATORY

120 West 41st St. New York City

8mm SLITTER

Slits perfectly 16mm width film to exact 8mm cutting. Die cast body with hardened steel cutting wheels.

DEVELOPING RACKS

Stainless steel, take 30 feet 16mm or 8mm width film. Can be used in 11x14 or 8x10 flat trays respectively.

At Your Dealer's or Direct

J. C. Haile & Sons

Motion Picture Dept.

215 Walnut Street Cincinnati, Ohio

object is brought out to the best advantage. More than anywhere else this is of great importance when shooting movies of people.

The author remembers viewing a family film some years ago where a proud father bragged about the marvelous movies he had taken of his youngster.

ing fight. Sometimes they were in the picture, sometimes not; but when they were out of the scenes, the eye was drawn to that corner of the screen where they were apt to appear again.

All of these things can be so easily avoided if cinefilmmers will think first and then shoot. It will save a lot of film and a great deal of disappointment if just these three factors are kept in mind: perspective, balance, and a brief analysis of the picture before shooting.

Chicagoan's Theatre . . .

Continued from Page 373

away from the exterior wall it creates an air space between these walls which improved the acoustics approximately 25 per cent.

The theatre measures 26' 9" in width x 31' 6" in length by 12' 10" in height and is carpeted with the same material as the lounge.

are light ivory with the balance of the surfaces down to the wainscot in five shades of buff. Eighty per cent of the ceiling is light ivory to create height and reflect light.

Exposure Meter Guide

CORRECTED JUNE 1, 1940

Table with columns for Scheiner (Mazda, Day) and Weston or GE (Mazda, Day) for various film types like AGFA, Dupont, Eastman, Gevaert, General, Kinolux, Consumers, Hollywood, and Univex.

THE Bolexmeter

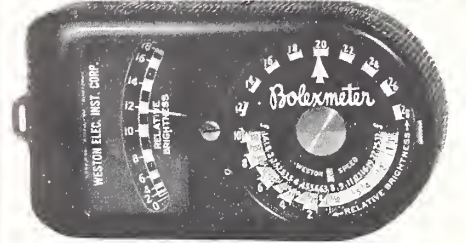

DOUBLE-DUTY DIAL GIVES QUICK READINGS FOR BOTH CINE AND STILL CAMERAS

THE NEW BOLEXMETER is the proved Weston "Master" exposure meter especially produced for the AMERICAN BOLEX Co.

See your dealer or order direct . . \$24

Bool CINE-FADER

PUTS 64 VARIETIES OF FADES & DISSOLVES

at your finger tips

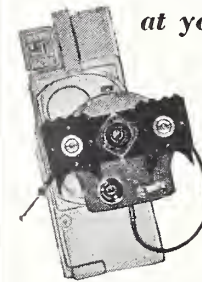

The handy Bool times and automatically makes by clockwork mechanism, all kinds of tricky effects "as you go."

FITS MOST EVERY MOVIE CAMERA AND PROJECTOR

Complete with extension tube, cable release, and instructions for operation..... \$17.50

Cinea FILM CEMENT

The only cement that is good for all kinds of film—acetate or nitrate—35 mm, 16 mm, or 8 mm.

CINELAC PROTECTS YOUR FILM

against SCRATCHES, FINGER MARKS, CURL AND BRITTLINESS

CINELAC permeates and toughens the emulsion—seals in moisture—prevents excessive aging—protects negatives and cine film.



See your dealer or order direct from—

AMERICAN BOLEX COMPANY 155 EAST 44th ST. • NEW YORK, N. Y.

Advertisement for DeJur-Hmsco Corporation Model 40 camera with image of the camera and lens.

SPECIAL CONSTRUCTIONS FOR YOUR CAMERA

- BACKWINDS FRAME COUNTERS FILM MAGAZINES TURRETS INTERNAL MASKS SINGLE FRAMERS

MERCURY MOVIE COMPANY 1133 Broadway New York City



IT'S HERE!

"O-o-o-oh!"
"A-a-a-ah!"
"Beautiful!"

Now you can screen such scenes —easy!

Gives 2X magnification on 8mm film; doubles size of image without great sacrifice of field. Graduated micrometer mounting focuses from one foot to infinity. Fine for huge close-ups (macro - photography). Color-corrected. Probably the ideal telephoto lens for general cine work. Fast for rainy days, dim woodlands, interiors. At dealers or direct postpaid (or C.O.D.). Money-back **\$37⁵⁰** guarantee.

1" FOCUS
f2.7
Cine Telephoto
FOR 8 MM

Write for free literature.

WOLLENSAK OPTICAL CO., 510 Hudson Ave., Rochester, N. Y.

WOLLENSAK

100 ft. — 16mm

THRIFTY FILM

\$1 60

Thrifty Films save you 50% on your film cost. Three splendid films to choose from—each a leader in its class. And now the surprise—look at these prices!

THRIFTY ORTHOTYPE **\$1 60**
For OUTDOOR... non-halation base, fine grain, fast, Weston 8—the film you've been wanting to find at an unheard-of low price. Machine processed. Per 100 ft. rolls.....

THRIFTY PANCHROMATIC **\$3.75**
Use for all types of shooting. High-speed Weston 16 daylight — 10 photofoods, machine processed. Per 100 ft. rolls.....

THRIFTY SUPER-PANCHROMATIC **\$4.25**
Super-fast, high sensitivity, requiring minimum of light. Weston 50 daylight — 32 photofoods, machine processed. Per 100 ft. rolls.....

THESE PRICES INCLUDE EVERYTHING

Daylight loading, processing, and return postage. All films are machine processed.

You Wonder Why Our Prices Are So Low?

Because our sales are direct from manufacturer to consumer. You save the sales commission paid the distributor, jobber, and the retailer. This means a 50% saving to you without sacrificing quality in any way. Order immediately and enjoy your camera—join the thousands of fans who are availing themselves of Thrifty savings.

California Buyers Please Include Sales Tax

Sold and Processed Only by

THRIFTY FILMS

Drawer 98, Watts Station Los Angeles, Calif.

rect. On each side of the stage opening there is a white pedestal supporting a spun aluminum vase, finished to harmonize with center fixture. These vases are illuminated and controlled from the same switch operating the center fixture.

The seats and tables in the auditorium can be placed at will as the occasion warrants. This room is ventilated by an exhaust system, pulling air through two grilles in front of stage apron and four grilles located on North and South

walls. Two speakers are located below stage, concealed by grilles and set on a proper angle to insure the best result.

The stage consists of two complete drapery settings, including one pair main draw curtains hung from an all-steel noiseless track, electrically operated by remote control from the projection room. The screen curtain is also hung from a light steel track and is hand operated by a series of pulleys and cords from the stage to the projection room. The 8' x 10' glass-

beaded screen and screen masking frame is mounted permanently. Black velour is used for screen masking. The recessed footlight trough is wired for three colors and controlled from the projection room.

All in all, a visit to this perfect home movie theatre is a thrilling experience that one long remembers. In its technical perfection, rich colorings, and impeccable taste—Mr. Chramer's "Ampro" theatre should serve as an ideal and inspiration for those cinebugs who plan to build a private movie theatre within their homes.

Gadgets for filming under water . . .

• Continued from Page 379

water or raised clear. (See Fig. 2.)

Directly in front of the lens was a round, glass port-hole, made by cementing a disc of glass taken from an old automobile speedometer, using the original frame which held the glass in the speedometer for the mount. All of it, however, was thoroughly cemented to make it waterproof.

The shooting was simplicity itself. He knew where his swimmers and divers would come; all that was necessary was to stand at the edge of the plunge and at the right moment, shove his pole beneath the water, twitch the shutter-release wire, and let the camera grind away!

Sometimes, however, a simple device like this isn't quite enough for the purpose. For instance, Fernstrom's improvisation made no provision for following the action through any sort of a finder. But this can be managed easily enough by making a sturdier, more permanent gadget of wood, as shown in Fig. 1.

Make a long, narrow wooden box, long enough to reach the desired depth, and rather more than large enough to hold your camera. Provide an ample-sized plate-glass window through which to shoot, and whatever type of mechanical or electrical remote-control gadget is best adapted to starting and stopping your particular camera from a distance.

Now for the finder! There are several ways to take care of this. Sometimes you can solve the problem by simply placing a mirror behind the camera's finder, slanted backward at a 45° angle, so that it reflects the finder's image up to the operator at the top of the box.

But this has the disadvantage of a very small image, and also one that in many cases is inaccurate due to the distance between finder and eye. The best method is to provide a larger, frame-type finder that can be seen more easily from the top of the tube.

For this, make the window at the bottom of the camera-box at least twice as large as is otherwise necessary. Put the camera in place, and beside it place a fair-sized mirror, tipped backward so it reflects an image of what is visible through the window to you at the top of the box.

Do this *before* you have put the back side onto the box. Now, checking each step by sighting through the lens and ground-glass, if your camera permits such focusing, mark off that part of the window in front of the mirror an area which, when seen from above through the mirror, coincides with the field shown in the finder. Mark this off with strips of black friction tape fixed to the inside of the window. Be sure, of course, that this tape doesn't crowd over into that part of the window through

which the camera shoots, so it would get into the picture. Then finish assembling your camera-tube, putting the back side into place. Now when you look down the tube, you will see in the mirror the image of what your lens is filming, outlined in the square of black tape. It may not be the most accurate of finders, but for most purposes, it will prove decidedly adequate.

The chief photographic problem is the refraction of the water—the same phenomenon that makes a stick stuck into the water seem bent at an angle.

This alters both lens-angle and focus. It greatly narrows the angle covered by any lens. Therefore always use the shortest-focus lens possible; if you are shooting 16mm., by all means use a 15mm or 20mm lens. If you are shooting 8mm, it will help a lot if you can use one of the wide-angle attachments now available.

Refraction greatly alters the focus, too. A safe rule to follow in all under-water filming is to set your focus at *two-thirds* of the actual distance. If the actual distance is 9 feet, set your lens for 6 feet; if it is actually 12 feet, set the lens at 8 feet, and so on.

Most under-water shooting will be fairly close shots, anyway, for neither your eye nor the camera can see very far under water. How far will depend entirely on the clearness of the water, which varies according to

FADES LAP-DISSOLVES WIPES VIGNETTES

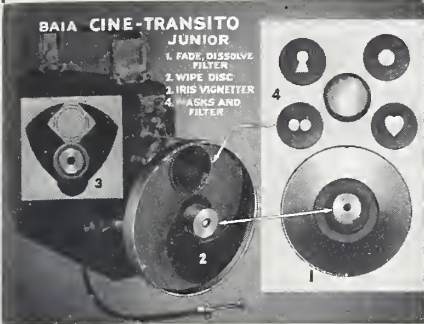

OPERATED BY CLOCKWORK
—ever-ready, small, light (4 oz.), compact, easy to operate, efficient, and durable.

Price \$9.95 Includes Adapter, Wipe Disc, and Cable Release

Accessories

- FADE DISC \$1.95
- VIGNETTER \$2.95
- Extra ADAPTERS 95c and up

Specify camera and lens
From Your Dealer or Direct
BAIA MOTION PICTURE ENGINEERING
8044 Hardyke Detroit, Mich.

The NEW Improved HOLLYWOOD "CINESCOPE"



8mm-16mm Film **POCKET VIEWER**, Reg. Price \$1.50
OUR NEW LOW PRICE . . \$1.00 POSTPAID
SPECIAL FEATURES—Will not scratch film . . . pre-focused for normal vision . . . adjustable for abnormal vision . . . large, precision eye-lens . . . well made, will last for years . . . film is held in position by groove . . . can be mounted on editing boards . . . special "light diffusion" screen . . . professional appearance.
State 8mm or 16mm When Ordering
Above Viewer **FREE** with Any \$10.00 Order
HOLLYWOOD STUDIOS
"The West's Greatest Film Mail Order House"
Southgate, California

BETTER HOME MOVIES With BLACK and WHITE FILM

REVERSIBLE FILM 25 ft. Double 8mm Including Processing **98¢**
Rating: Weston 12, Scheiner 18.
At your dealer or direct. Fast service processing same day included at no additional cost.

VISUAL INSTRUCTION SUPPLY CO.
1757 Broadway Box H9 Brooklyn, N. Y.

16mm PROFESSIONAL TITLES

by **FILMACK**

Sound or Silent

Filmack supplies 16mm titles with theatrical appearance . . . no order too large or too small. Editing and complete Laboratory Service.

KODACHROME TITLES
Send for Free Catalog

SEND A TRIAL ORDER

FILMACK LABORATORIES
831 SO. WABASH AVE. • CHICAGO, ILL.

location, time and other circumstances.
The clearness of the water governs the exposure, as well. Naturally, if the water is clear, you can stop your lens down more than you could if the water were cloudy. With reasonably clear water and good lighting conditions, though, you'll be surprised how much it is possible to stop down. Exactly how much had better be determined by tests, for it is difficult, if not impossible to use a meter

under water, and water conditions and illumination vary so much that no generalization is practical. The best hours for under-water filming, by the way, are those between 10 A.M. and 2 P.M. on bright sunny days. Between these hours, with good sunlight and clear water you may be sure of getting excellent under-water movies in black-and-white, and if the water is really clear, in Kodachrome as well.

Vacation film ideas . . .

• Continued from Page 375

turning home, "Budget" is arrested, charged with issuing worthless checks. In order to obtain his release, "Mrs. Budget" is obliged to use the money which she had secretly saved from her grocery allowance for the purchase of a fur coat.

As they went along, Mrs. Johnson made the tie-in shots of her husband as he frequently checked over the budget sheet. After their return, the opening and closing sequences were staged which showed "Mr. and Mrs. Budget" planning their vacation and arranging the budget; the arrest of "Mr. Budget"; and then of "Mrs. Budget" hurrying with the money to bail him out of jail. This idea might well be adapted by any filmer.

Subsequently we reviewed another vacation film with a similar gag-shot theme. In this instance the filmer used the idea of giving rubber checks. The checks were actually printed on thin sheets of rubber. After a check was given to an inn or a gas sta-

tion attendant, this filmer would show a closeup of the party stretching the check. Eventually, of course, the vacationer was shown in the toils of the law—the same as "Mr. Budget."

Another vacation picture, "New England Holiday," filmed by Albert Watts, featured clever running gag-shots of a girl—one of their party—eating a hot dog. The picture was a scenic of the many interesting places visited during a tour of New England, and the gag-shots were cleverly intercut at intervals to balance the preponderance of strictly scenic material. These gag-shots—a closeup from a low angle—of the girl eating a hot dog was a contrasting note to the many scenes wherein delicious food was shown as, for instance, the preparing of meals by the entire party as they camped along the way; or the fine shots of the New England clam bake. In each instance, as others in the party were shown enjoying an appetiz-

The WILLO CINE TRIPOD

A Tripod of Exceptional Quality at Only

\$14.75



A strong, durable all-metal tubular tripod—rigid enough to meet the exacting demands of press photographers!

Ready for action in a flash. The tubular sections are instantly locked at any length by turning the legs clockwise, and a special locking device controlled by the knobbed handle prevents legs from spreading.

Universal Pan and Tilt Top allows you to tilt and turn the camera smoothly to follow the subject, or lock the camera at any angle.

Alternating points, for indoor and outdoor use. Both handles fit under tripod head for convenience in carrying.

Three sections, weight 5 lbs. 24 3/8 inches folded, 59 3/8 inches fully extended.

Carrying Case \$3.50

Mail Orders Filled
Write Dept. H. M. C.

Willoughbys

32nd St. Near 6th Ave., N. Y.
World's Largest Camera Store
Built on Square Dealing

• All Amateurs, whether subscribers of HOME MOVIES or not, are invited to submit their films to the editors for review and helpful criticism. Unless otherwise requested, reviews of some of the films which we believe would benefit other amateurs will be published each month.

Reviewed films will be rated one, two, three, and four stars, and films qualifying for two or more stars will receive, free, an animated leader indicative of such award. Detailed reviews, with suggestions for improvement—if any—will be mailed to amateurs submitting their films.

Exceptional films qualifying for

the distinction of the "Movie of the Month" will be treated in detail in a feature length article in a following issue of HOME MOVIES. In addition, a certificate evidencing the award of "Movie of the Month" and a special animated "Movie of the Month" leader will be returned with such films after review.

When submitting films for review and analysis, please advise make of camera, speed of lens, whether or not tripod was used, or if you used filters, exposure meter, or other accessories. While this information is not essential to obtain analysis of your film, we would like to pass it on for the benefit of other amateurs.



NOW
 Go RCA all the way
 with Bass
**TAKE "SOUND" AND
 SHOW "SOUND"**
**RCA 16MM SOUND ON FILM
 CAMERA**
 Doing professional work all over the world;
 distributed by BASS.
NEWSREEL MODEL:
 1-inch F:3.5 lens, batteries and mike \$250
COMMERCIAL MODEL:
 3-stage amplifier \$965
RCA 16MM SOUND PROJECTOR
 750-watt lamp, 10-watt output. F:1.65 lens,
 2 cases. A big value at \$300
 Write for New Free CINE BARGAINGRAM No. 245
Bass CAMERA CO. Dept.
 179 W. MADISON ST. H. M.
 CHICAGO, ILL.

THRIFTY BULK FILM
 Write for Catalog and
 Note These Prices

100 ft. double 8mm semi-ortho.....	\$1.19
100 ft. straight 8mm semi-ortho.....	.75
100 ft. 16mm semi-ortho.....	1.19
Dbl. 8mm empty camera spools.....	.30
Univex straight 8 empty camera spools	.15
100 ft. 16mm empty camera spools....	.40
Slitters for slitting unscored double 8mm film, formerly \$1.50, now only	.79

All above film is laboratory packed and prices do not include processing.

California customers please include 3% sales tax. No C.O.D. orders unless accompanied by \$1.00 cash with order.

THRIFTY FILMS
 Drawer 98, Watts Station Los Angeles, Calif.



RAVEN SCREENS
 Used exclusively in the Kodak Cavalcade of Color at World's Fair. At all leading dealers. Literature on request.

RAVEN SCREEN CORP., 314 East 35th St., New York

75c	50 Ft. Dbl. 8mm	Buy Now!	25 Ft. Dbl. 8mm	\$1.25
Weston 8 G FILM	BARGAINS ON G FILMS		Weston 24 SUPER G FILM	
Unspooled, To Save You Money. All Prices Include Processing and Postage (Full Panchromatic, A.H.)				
M-G-M PHOTO SERVICE				
\$1.50	100 Ft. 16mm	1485 Oak	100 Ft. 16mm	\$3.95

GLASS-BEADED MOVIE SCREENS
 Easily Made!

Make your own sparkling beaded screens—at a fraction of their usual cost! Crystal beads can be applied to cloth, cardboard or almost any smooth surface. Complete directions with each pound. (No fractions of pounds sold.)
 D. GARD, C-6, 54 WEST 74TH ST., NEW YORK CITY

Glass Beads to cover 20 sq. ft. (1 lb.). Finest Size \$1.25

REDUCTIONS ENLARGEMENTS DUPLICATES
GEO. W. COLBURN LABORATORY
 1197 MERCHANDISE MART CHICAGO

ing meal, this girl would be shown eating a hot dog. These were tight close-ups, filmed after the party returned from their trip. The gag was the result of an experience at a wayside inn when one of the girls ordered only a hot dog while the others ate a regular meal.

Of course, many amateurs begin their vacations with filming plans well prepared and these bring back pictures filmed in fairly good sequences and continuity. One amateur selected the title, "Idle Days," for his vacation film and took a cue from the title in making his picture. It had a noticeable peacefulness about it completely in tune with its title. The transition from one scene or sequence to another was smoothly executed by means of clever camera manipulation and use of fades. The scenes themselves were of peaceful things—cool mountain scenery; pleasant countrysides; cows grazing

lazily in a scenic meadow, etc.

This picture was an excellent example of what can be done when one sets out to make a picture that expresses a particular mood. The filmer wanted to instill in his picture the impression of calmness, and succeeded. He did not seem to hurry at any point, nor did he seem to tarry.

Frequently vacation pictures run hundreds of feet longer than they should. Either there is too much footage devoted to scenes or there are a great many unnecessary and uninteresting scenes. Perhaps the most important thing to remember in shooting movies during our travels is this: Give a thought before shooting. If the scene encompasses something unusual or picturesque you wish to remember, or if it portrays something especially interesting you will want to show to your friends, then shoot it!

If a subject is at all inter-

esting, then it calls for a closeup. So, instead of wasting too much footage on a single long shot, introduce it with a brief medium or long shot, then follow with one or more closeups.

Of course, the method of "polishing up" vacation movies after returning home is by no means a job that can be accomplished in a single afternoon. It will come only after our films have been projected over and over again, edited and re-edited, until we have a well-conceived idea what additional scenes should be shot to make them complete and interesting to others as well as ourself.

The fact should not be overlooked that essentially it is a vacation record and that shots taken during the travel are still the main substance of the film. The added shots will be the fruits of our artistic efforts—a little gag here and there that will give our friends a laugh and send them away praising our picture.

Vary your camera speed

Continued from Page 376

thing moving in the distance can usually be taken to advantage at the eight frame speed, provided there is no movement in the foreground that would spoil the picture by comparison (see Fig. 1).

However, one should not proceed to take shots at the eight frame speed in a haphazard manner. There are a number of things which should be taken into consideration when using this speed. For instance, in shooting a moving object, within, say, 25 feet of the camera, unless it is moving very slowly, it should be moving toward the camera, not across from side to side. At eight frames the camera must be held twice as steady as for normal shooting, and a tripod should always be used when available, or the camera rested on a solid support, as all camera movement is accentuated when the picture is shown on the screen. Any jiggling movement is rather hard on the eyes of the audience. Never use this speed when panning unless a tripod equipped with a device for giving a very smooth slow

swing of the camera is available, otherwise the picture will move across the screen in a series of small jerks.

There is no need to dwell on the sixteen frame speed, as that is the normal speed familiar to all of us.

The twenty-four frame speed is for much the same uses as the thirty-two frame speed (explained in the next paragraph), only to a lesser degree. One would use it to shoot objects moving at a fairly fast speed, but not at what one would consider as high speed, unless the moving object is coming toward the camera, in which case the reduction in the speed is not so noticeable on the screen as when the object crosses the screen from side to side. This is an excellent speed to take movies of people diving from a springboard. When it is not desired to slow up the action, and yet the advantages of the thirty-two frame speed are wanted, this twenty-four frame speed serves as a compromise. Some amateurs use twenty-four frames all the time, instead of the standard sixteen, as

it smooths out any slight camera movement, and also makes moving objects clearer. This is also the standard speed for sound or for shooting pictures to which a sound track will subsequently be added.

The thirty-two frame speed is the speed to use for very fast moving objects, not too distant, going crossways to the field of vision, such as a train passing by. The action will be slowed up considerably on the screen, but that is better than looking at a high speed blur, as would result from the use of the sixteen frame speed. This thirty-two frame speed is the proper one to use for the floats of a parade, when taken from the sidewalk, or similar closeup position. Instead of moving across the screen jerkily and none too clear, the thirty-two frame speed will make the movement smooth and distinct, and will give the audience a better view of each float. Of course, if these shots are taken from a little distance away, such as from the top of a building, then the normal sixteen frame speed is

16mm

AMBERTINT

Quality Outdoor Film at Extremely Low Cost

Fine grain, semi-ortho, large latitude—half stop either way—the OUTDOOR sensation film of the 20th Century. AMBER tint of film "different" and pleasing. Amazing low price includes machine processing. **\$2⁰⁰** SHOOT MORE OUTDOOR ACTION FILM AT LESS COST. 100-ft. roll.....

Order Direct
 AMBERTINT not sold at dealers. Order several rolls direct—save money. Not made in 8mm nor sold in bulk.

California Buyers Include Sales Tax

Write for Big Free Bulk Film Catalog

HOLLYWOODLAND STUDIOS
 THE WEST'S GREATEST FILM MAIL ORDER HOUSE
 SOUTHGATE, CALIFORNIA

It's Brand New!



"KNOBBY"

CAMERA HANDLE

If you own a movie or candid camera, you need a KNOBBY! Screw the handle into your camera, slip the strap over your wrist, and use it at picnics, airport, races, ball park, etc. Only one shooting trip is necessary to make it a "must" among your accessories. It's easy to get steady pictures with a KNOBBY! Impossible to drop your camera with a KNOBBY! IDEAL FOR AN APPRECIATED GIFT! Postpaid \$1.00

Knobby Camera Accessories
 Box 211 Kent, Ohio

.. TITLES .. 16mm

BACKGROUNDS FREE

UP TO 10 WORDS EACH ADDITIONAL WORD 2c

FILM IN BULK

LABORATORY PACKED	400 ft.	200 ft.	100 ft.
16mm ORTHO—West. 8	3.50	2.00	1.25
SUPER Panchromatic, West. 24	10.00	6.00	3.50
8mm Double ORTHO—West. 8 (Scored)	3.50	2.00	1.25
SUPER Panchromatic—West. 24	10.00	6.00	3.50
REVERSAL PROCESSING—100 Feet or Less 75c			

Reducing ★ Enlarging

ILLUSTRATED CATALOGUE

GENERAL CINE SERVICE
 204H East 18th St., New York

FILMS FOR RENT

16MM SOUND - 16MM SILENT - 8MM SILENT

Send for Free Gigantic Catalogue
 Listing over 3500 subjects.

IDEAL PICTURES CORPORATION
 28 EAST 8TH STREET, CHICAGO
 411
 2402 West 7th Street, Los Angeles, Calif.

IN PHILADELPHIA

CAMERAS

and Everything Photographic

KLEIN & GOODMAN
 18 S. 10th STREET

correct. Normal speed should also be used for shots of people marching, bands, etc., otherwise the march would become a dead march.

When making pan shots, the thirty-two frame speed is by far the best speed to use, provided there is no movement which would be spoiled by being slowed down; if there is such movement, then split the difference and use twenty-four frames. The essentials of panoraming are smoothness and slowness. Both these essentials are none too easy to achieve with sixteen frames unless very great care is exercised, but at thirty-two frames they are achieved mechanically with just ordinary care. The thirty-two frame speed is a good speed to use when shooting from a moving automobile or rear of a train or, in fact, from any vibrating surface such as the deck of a ferry boat

(see Fig. 2), as the invariably present jiggling motion is not nearly so hard to look at on the screen when spread out over twice as many frames as normal. Remember, at higher camera speeds the effect of camera movement is reduced in the same way that it is accentuated by use of the slow eight frame speed.

The slow-motion speeds of sixty-four, and sometimes seventy-two frames a second, are probably the least useful of any, and these speeds are limited mainly to novel effects and trick photography. They are useful for checking errors in a golf swing; in solving a conjurer's sleight-of-hand tricks, etc. But as the running of a camera at these high speeds racks the mechanism of the camera, and as there is usually some wastage of film, it is advisable to use slow motion only occasionally.

Movie of the month . . .

• Continued from Page 382

nize and capture it with his camera.

MacCormack describes the skiing event as it progresses by inter-cutting at intervals inserts of a letter addressed to a friend—using these instead of conventional titles. They were exceptionally well staged and photographed. The writing was clear and sharp and easily read on the screen. Once or twice we felt some inserts did not remain on the screen long enough to be comfortably read; the text of some were a little lengthy.

First shot of the letter followed the main title and told about the annual ski meet. It gave the audience an immediate starting point from which to follow the picture. Then as the picture unfolded, subsequent titles described feats of various contestants appearing in the succeeding scenes. Undoubtedly it was MacCormack's desire to identify each of the contestants appearing in his film which accounted for the great number of inserts of the letter. Ordinarily, one would not like to see so many, especially in an action picture of this kind. All in all, however, this feature of the pic-

ture was well executed and offers an excellent example of how a series of related scenes of a given subject may be tied closely together to form an interesting picture.

The letter, which accompanied MacCormack's picture, tells of the equipment used in its making—a model "K" Cine Kodak with an f/1.9 lens; tripod; and a General Electric exposure meter. MacCormack relates that in spite of his exposure meter, about 80 per cent of the shots were made without referring to it—undoubtedly because of the fast action constantly before him which afforded little opportunity to take readings, and because he has by this time, like most seasoned amateurs, learned to judge light conditions with considerable precision after taking an initial reading.

The high excellence of exposure throughout the picture is worthy of more than ordinary note and this, together with MacCormack's general camera technique enabled him to produce a picture that is, from a photographic viewpoint, absolutely tops.

For Good Pictures



Camera Hints and Full Photographic Information with Each Roll of Films

Complete Modern Machine Processing Under Expert Craftsman Supervision

	16mm	100 ft.	50 ft.
Consumers' Ortho (18 Scheiners & Weston Daylight 8)		\$3.00	\$2.00
Consumers' Panchro (23 Scheiners, Weston Daylight 24, Tungsten 16)	5.00		3.00
Consumers' Colorcrome (18 Scheiner, Weston Daylight 8)	6.00		3.00

A Colorcrome Process (Not a Natural Color)

At Your Dealer, or Write Direct

Consumers' Film Products CORPORATION

RIDGEFIELD PARK, N. J.

GOERZ KINO-HYPAR LENSES

f:2.7 and f:3

For regular and color movies of surprising quality—high chromatic correction . . .

Focal lengths 15mm to 100mm—can be fitted in suitable focusing mounts to Amateur and Professional Movie Cameras.



GOERZ Reflex FOCUSER

— Patented —

For 16mm Movie Cameras—voids PARALLAX between finder and lens—provides full-size ground-glass image magnified 10 times. Adaptable to lenses 3" and up. Also useful as extension tube for shorter focus lenses for close-ups. Extensively used in shooting surgical operations, small animal life, etc.



GOERZ Parallax-Free FOCUSER and FIELD FINDER CONTROL

No more off-center pictures, for Filmo 121 and Simplex-Pockette magnifies 4 and 8x.

For Detailed Information Address Dept. IIM-8

C. P. Goerz American Optical Co.
 317 East 34th St., New York
 American Lens Makers Since 1899

Take Your MOVIES with



Write Today for Free Offer—Limited A FULLY GUARANTEED PRODUCT It is easy to take GOOD PICTURES with

MOVIE MASTER CAMERA FILMS
FAST PROCESSING SERVICE

	100 ft.	50 ft.
Movie Master Ortho.....	\$2.50	\$1.50
18 Scheiners, Weston Daylight 8		
Movie Master Panchro.....	\$4.25	\$2.50
23 Scheiners, Weston Daylight 24, Tungsten 16		
Movie Master Colortone.....	\$6.00	\$3.00
A Colortone Process (Not Natural Color)		

MOVIE MASTER FILM CO.
Ridgefield Park, N. J.

Cinematography course . . .

• Continued from Page 370

light when it struck the emulsion and how it can be controlled to do the things we want it to do.

The third lecture was devoted to methods of altering that light by the control of filters and was entitled Filter Factors. A very effective demonstration was developed by projecting various colored lights and intercepting them with filters.

The fourth lecture, entitled Title Technique, dealt with all known methods of title making, with a reel of sample titles to illustrate each method. As a laboratory study, we followed the lecture with actual title work. We photographed a title on positive film, developed it, and projected it on the screen in 40 minutes.

"Interior Illumination," the subject for the fifth lecture, gave positive information for the proper control of lighting equipment, giving each light a name and position and showing why each unit is used. Demonstrations were made to create the desirable effects as well as the undesirable ones.

The last lecture, entitled Camera Control, was very valuable in establishing rules for the proper manipulation of the camera, attention being given to all adjustments in the order of their importance. Many rules were given so that by adopting them it would be impossible to overlook any important adjustment.

This course of six lectures covered all that was important for successful amateur work and the picture work of our members has improved tremendously with the progress of the lecture series.

Aside from the value to the individual members, there was a definite value to the club. The first rule for participation was perfect attendance at all lectures to qualify for the certificate. This in itself was a great help to the club, as we were always lecturing to capacity groups. Each member signed the registration book at each meeting as evidence of his attendance, and upon

the completion of the course it was a simple matter to see who had qualified for the honor of the award.

We had as many as fifty at each meeting, but of this number, twenty-three had perfect attendance for the entire series.

It was quite surprising at the start how loyal our members became in attending regularly, but it was more effectively demonstrated by the increase in members at each meeting.

At our annual banquet in May, the certificates were awarded to those who had completed the lecture series and this celebration in itself served a valuable purpose in inspiring those members who had not attended regularly to be sure to do so next year.

The lecture series for next year's course is now being planned, and each of those who were awarded the diploma this year will be given an opportunity to deliver one lecture of the series. This is one requirement to gain further recognition, as we plan to develop these people next year into Advanced Amateurs. Aside from the one lecture presentation, they are required to attend all other lectures and produce a finished picture, any length on any subject, but completely titled and edited according to the accepted rules and form. An entire year is allowed for this work, so that when we hold our anniversary banquet next year we will award the Advanced Amateur certificates in addition to the Master certificates.

So far this plan has met with unanimous approval and is very effective in giving all members an opportunity to participate in the activities of the club. All members are interested and curious about each other's work, as well as their own, and we benefit mutually by the plan. The course has been carefully planned to have the subjects in proper order so that advancement in technique is progressive. Many of our new members who came to us with



Something New! HURRY!

Home Movie Makers:

Make Your Next Amateur Reel from a Professional Script! . . .

YOU be the director. Relatives and friends can be the cast. You may be surprised by discovering a potential film star among them. Anyway, everyone will get a big thrill out of this NEW IDEA.

Send \$1 Today for a Copy of the "Shooting" Script of "WHAT A PICNIC!"

Written by a professional Hollywood scenarist to be filmed at a family picnic and ALL FOR DOUBLE-FUN. For 8mm or 16mm camera. Filmed titles FREE with all scripts. A real REEL service FOR YOU.

Send for Our FREE Catalogue of Other Scripts designed to double your film fun.

Home-Movies Script Service
P. O. Box 1218 (Dept. 2) San Francisco, Calif.

Be First With This. HURRY!



MOVIE FILM	Reg. Weston 8	Super Pan	Weston 24
	\$1.79		
16mm, 100 ft.		\$2.19	\$3.69
16mm, 50 ft.	1.19	1.39	2.19
Dbl. 8mm, 25 ft.	.98	1.19	1.39

Not to be confused with bulk film. Each roll complete on daylight loading spool in metal container in mailing carton. Prices INCLUDE high grade processing service 24 hours in our laboratory. Supplied in 3 popular types. REGULAR semi-ortho; SUPER full-ortho, non-halation, wide latitude. PAN is extremely fast, panchromatic, very fine grained.

ORDER TODAY DIRECT FROM THIS AD
Orders for 2 rolls or more, accompanied by \$1, may be sent C. O. D. for balance.

ESSCO FILM PRODUCTS
Dept. HM
6117 SO. CAMPBELL AVE. CHICAGO, ILL.

DO FILTER FACTORS FLOOR YOU?

...then ask about the new HARRISON Dureline FILTER SET—4 Filters, a Holder and Shade to meet 99% of all your requirements. With compact leather case—Easy instructions. New low prices. See them at your dealer today! ... Or write for folder.

HARRISON & HARRISON
Optical Engineers
8351 SANTA MONICA BLVD. HOLLYWOOD, CALIF.

Kodachrome
MAPS • Charts • FINE TITLES
Geo. W. Colburn Laboratory
Special Motion Picture Printing
1197 Merchandise Mart, Chicago

8mm Bulk Film 16mm
Lowest Prices
Write for Catalogue
HOLLYWOODLAND STUDIOS
Southgate California

RESERVE NOW
YOUR COPY OF CINE SHOP'S Latest TITLE CATALOG OUT SEPT. 1st
Cine Shop TITLES
1812 PIEDMONT • CHARLESTON, WEST VA.

SAFE SUMMER STORAGE FOR YOUR FILMS
in your own home

VAPORATE your films NOW—for protection against summer's sticky humidity.

Better photo finishers offer you VAPORATE Permanent Protection against climate, wear, scratches, oil, dirt, water, and finger marks on your still films.

VAPORATE
PEERLESS FILM TREATMENT

VAPORATE CO. INC. 130 W. 46th St. New York City
BELL & HOWELL CO. 1801 Larchmont Chicago
716 No. La Brea Hollywood

FINE MACHINE WORK
We install backwinds on Eastman, Bell & Howell, Keystone, Univex, Victor, Revere, and other cameras, and install frame counters on other backwinds. Backwinds from \$10.50 up.

Turret installations of Filmo Double 8, \$28.75. Victor Model 3, \$30.50, and on others at proportionate prices.

Special Apparatus and Lens Alterations

MacVAN MFG. CO.
3829 EL CAJON SAN DIEGO

THALMETAL TRIPOD
FOR VERSATILITY AND VALUE

Pan-tilt head, sturdy metal and wood legs, beautiful appearance and other standard Thalhammer features make this one of the world's finest tripods. Economically priced at \$14.50. See it at your dealer's today.

THALHAMMER COMPANY
1015 West 2nd St. Los Angeles, Calif.

GUARANTEED—To read lower lowlight and higher highlight intensities more accurately than any other Meter... regardless of price.

PHAOSTRON
ELECTRIC EXPOSURE METER
For Stills or Movies
Ask your dealer... or write:
PHAOSTRON CO. ALHAMBRA, CALIF.

ORDER FOR SUBSCRIPTION

Home Movies Magazine

12 MONTHS FOR \$2.00 IN U. S.

In Canada, \$2.00; Foreign—\$3.00

SPECIAL OFFER: 3 Years for \$5.00 in the U. S.

HOME MOVIES
100 Sunset Blvd.
Beverly Hills, Calif.



Name.....
Send to.....

Address.....

City..... State.....

New Renewal Gift

Name.....
Send to.....

Address.....

City..... State.....

New Renewal Gift



Enclosed find \$..... Date.....19.....

Sent in by.....

Address.....

City..... State.....

NO SUBSCRIPTIONS ACCEPTED FOR LESS THAN ONE YEAR





little knowledge, being new owners of equipment, have expressed their satisfaction by stating that any one of the lectures have been worth the year's membership dues. One of the most evident values of this plan has shown itself in the progress made in the film work of these members. Some of our new amateurs have brought some startling results of their work and credit the course for this improvement.

This idea has worked so well for us that we are proud to pass it along for other clubs to follow. Many are able to improve upon it possibly, but in any form it is more enjoyable because of the systematic presentation of information which all can use.

The officers and members agree that this plan has been the making of our club, as the supply of information from manufacturers is rather limited and not always available. By developing our own course, we have retained a personal interest among the membership due to curiosity and a desire to learn all that is possible.

Members are more eager to renew their memberships as the first requirement is good standing or paid-up dues. This eliminates a delinquent list completely, as no credit for the lecture material can be given to one who is in arrears.

There are many advantages to this plan, each of which manifests itself as time goes on. Our members have left for vacations with more assurance for the filming of more enjoyable pictures than they could possibly have had otherwise, and we are expecting to see some beneficial results in our fall showings when we resume our indoor work again.

SOLAR Movie FILM

BUY IT AT YOUR DEALERS

	Weston	16mm	16mm	8mm
	Rating	100 ft.	50 ft.	25 ft.
Solar ECONOMY Outdoor	8	\$2.50	\$1.75	
Solar SUPER Outdoor	12	2.95	1.95	\$1.39
Solar HI-SPEED	24	5.50	3.25	2.00

Prices include processing at the SOLAR processing station nearest you, per list enclosed with each roll. One of these processing stations is less than 24 hours from 90% of all movie camera fans in the U. S. Films are returned to you postpaid. If more convenient, order film from this ad and mention your dealer's name. Sold by over 300 leading dealers in 49 cities. Descriptive circular FREE upon request.

Dealers Wanted Write Quick

Solor Cine Products Inc.
3827 Archer Ave. Dept. 1A
Chicago, Illinois

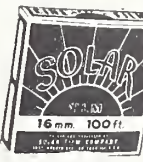

\$1250 BEADED SCREENS NOW \$4.95

New 30"x40" 3-way tripod screens by well known manufacturer. Stand on tripod, hang on wall, or use with easel on table. Black crackle finish, dustproof metal case. High quality crystal beaded surface with black border. Slight imperfections, hardly noticeable, guaranteed not to impair projection qualities. Otherwise perfect condition. Only 97 available at this give-away price. Your chance to get a QUALITY SCREEN at a spectacular saving. Order today direct from this ad. P. O. B. Chicago.



While 50 Wall Models Last \$2.95 Each
COMPLETE WITH TRIPOD TABLE EASEL WALL CASE
Made to sell for \$12.50

Send For Free Circulars on Bulk Movie Film... Processing Service... Home Movie Equipment and Supplies
SUPERIOR BULK FILM COMPANY
"Home Processing Headquarters"
Dept. HM 8 188 W. Randolph St. CHICAGO

DON'T PAY HIGH PRICES FOR FILM BUY ONYX 8 FILM FOR LESS

100 ft. 16mm	\$2.00
25 ft. double 8	\$1.00
30 ft. for Univex	50c

Minimum Order \$1.00
Reversal Free of Charge

Write for price list of all types and grades of film. Processing chemicals for Home use.

KENWOOD FILMS
1231 E. 46th St. Chicago, Ill.



A DIME A DAY BRINGS FUN TO STAY
New Revere Cameras are ready for immediate shipment. Own and enjoy home movies on Don's Bargain Book now being distributed throughout the U. S. Lists all the best moving picture equipment from all the leading manufacturers, describes them. The prices save you money in many cases. You'll find the latest in lenses, screens, meters, projectors, cameras, film, titlers, editing outfits, tripods, books on editing, titling, etc. This Bargain Book is invaluable to you as an equipment REFERENCE book. Don't wait a day longer to send for your Free copy. Write us now.

don elder's home movies
739 BOYLSTON ST., BOSTON, MASS.

NOTICE TO MOVIE FANS

If you take movies (8mm or 16mm) you simply cannot afford to be without a Free copy of the latest Photo Bargain Book now being distributed throughout the U. S. Lists all the best moving picture equipment from all the leading manufacturers, describes them. The prices save you money in many cases. You'll find the latest in lenses, screens, meters, projectors, cameras, film, titlers, editing outfits, tripods, books on editing, titling, etc. This Bargain Book is invaluable to you as an equipment REFERENCE book. Don't wait a day longer to send for your Free copy. Write us now.

CENTRAL CAMERA COMPANY
220 S. Wabash Dept. H-9 Chicago, Illinois

MAKE YOUR OWN TITLER!

For all types of titles, close-up and copy work. Complete kit of finished parts—optically ground lenses—easy instructions. Assemble in 15 minutes! Money Back Guarantee. State camera model.

ONLY \$1.95 IN KIT FORM
For All 8 or 16 MM CAMERAS

HOLLYWOOD MOVIE SUPPLY COMPANY
NORTH HOLLYWOOD • CALIFORNIA

Camera Lenses ...

Continued from Page 380

principles of lens action and construction should be made.

Like the Bible, this discussion should start at the very beginning. That beginning, in photo optics, is light. Some understanding of light and its action will help more than anything, not only one's understanding of lenses, but also the practice of many other functions in photography.

Light, like sound, scientists agree, is a wave motion. There is no definite proof one way or another, but the weight of the evidence lies on the side of the wave motion theory. This means that light is very similar to the waves caused by dropping a rock in a still pool of water.

Instead of being waves in water, however, light is wave motion in ether, an all-pervasive substance which is again theoretical; but by saying that ether does exist, science can explain more of light's actions and makeup than by any other theory. Ether is everywhere; on earth, in the sun, in the air and sky, in interstellar space, in everything. It cannot be weighed, tasted, smelled, felt, nor heard.

Light travels in this medium with unbelievable speed—186,000-odd miles per second. It could go around the earth seven times in one second, and it takes about eight minutes to reach us from the sun. It may be wondered what the speed of light has to do with catching your neighbor's golf-stroke on film. It is brought in as one of the bricks in the base of the pyramid of information being built in this discussion, and will be heard of again right soon.

Light also travels at this tremendous speed in this mysterious medium in perfectly straight lines—until it is bent by some transparent body, sent back on itself by reflection, or passes very close to a sharp thin opaque edge. Thus, light originating from some source—a candle flame, a white-hot lamp filament, or the sun—

For Salon Quality in Your Exhibition Prints —USE A SOLAR

A Solar will give you Salon quality in all your enlargements... it will bring out the full pictorial quality of every negative. Its perfected light and optical system along with its wide flexibility in adjustments make Solar the choice of the man who knows enlargers. Models available to cover negatives from 35mm. to 5x7 in. Priced from \$39.50 to \$112.50. Enlarging Treatise HM840 free.

BURKE & JAMES, Inc.
223 W. MADISON ST. • CHICAGO, ILLINOIS

Golden Gate International Exposition 16mm Films

Four 100-ft. reels. No titles except heading and end.
REEL No. 1—Gen. views, Oakland Bay Bridge, Tower of Sun, Fountains, Buildings, etc.
REEL No. 2—Continuation of reel No. 1.
REEL No. 3—Continuation of reel No. 2.
REEL No. 4—Night photography. The Fair in all it's glory! General views of the Gay Way.

Each reel complete, but you can add one to the other without duplication. **BLACK AND WHITE** specially priced at **\$1.95** each

Please Specify When Ordering, Reels You Desire

NATURAL COLOR PRINTS

Full color Kodachrome showing the Fair in all it's beauty.
100 ft. 16mm. **\$9.00**

8mm BLACK AND WHITE

50 ft. \$1.75 180 ft. \$5.50
(8mm is not as yet available in color)
California Buyers Include Sales Tax

HOLLYWOODLAND STUDIOS
"The West's Greatest Film Mail Order House"
SOUTHGATE BOX 14 CALIFORNIA

TITLES LIKE THIS

Can Be Yours

122 pieces for \$1.00! Letters and numbers 1 inch high, made of stiff polished coated cardboard—all die cut. In 6 colors—red, green, yellow, blue, black and white. Least expensive yet best type of letters for photographic titles and quotations. etc. Send check, money order or \$1.00 today... complete units shipped immediately, postpaid.

Rich Mfg. Co.
364 Atlantic Ave. Boston, Mass.

16mm Movie Makers Attention!

Skillful, specialized editing and titling of your 16mm films, Black and White or Color.

Write for Full Details
MARTIN R. HUGHSON
141 Brantwood Road Snyder, New York

EDIT AND TITLE YOUR FILMS AT ZENITH CINEMA SERVICE

5011 North Sawyer Ave., Chicago

Complete stock of home movie equipment—new and used. Large selection of film subjects to rent. Write for free catalog.
"The Home of Movies"

LEARN PHOTOGRAPHY from Experts

Thorough, practical training. For pleasure or career. All phases of photography. Commercial, News, Portrait, Advertising, Motion Picture, Color. Teaching staff of noted authorities. 30th year. Send for Free Booklet.

New York Institute of Photography
10 West 33 Street (Dept. 114) New York City

NEW CLUBS FORMING

- There's a new amateur club forming in Oshkosh, Wis. 8mm and 16mm cinefilmmers in this vicinity interested in joining are requested to communicate with Edward L. Fredrick, care Winnebago State Hospital, Winnebago, Wis.
- Cineclickers of Baltimore, Md., interested in forming an amateur cine club are urged to communicate with Richard J. Magruder, Jr., 2510 Talbot Road, Baltimore. This invitation is open to both 8mm and 16mm cine fans.

NEW 8-16mm "CINE-SCOPE" POCKET-VIEWER \$1.00

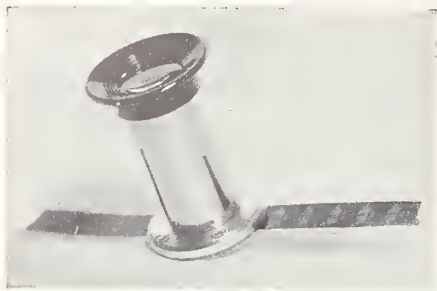

MAGNIFIES 36 TIMES AREA
Optically-ground lenses insure a large, clear-cut image. Adjustable. Film is slipped in, at the side. Groove holds film in position (see photo). A \$3.50 value—GOING FAST at \$1.00.

A REAL NECESSITY—ORDER NOW!
State 8 or 16 mm. Enclose dollar-bill and dime post. (DON'T SEND STAMPS.)
Designed by: E. M. LIEBSCHER, Opt. Engr.
157 pc. "moderne" TITLING-SET, \$1.95
3/4 in. high—3/8 in. thick of cast-white DENTAL plaster. "Third dimension." NO PINS. Regular price, \$4.00 per set. Has letters, figures, etc. 157 pcs. Shipped ins. exp. (chs. approx. 35c). DIME BRINGS SAMPLES—NO STAMPS. **FREE!** "Table of sizes" CHART with ALL orders (while they last). Reg. \$1. Gives "field-sizes" at various distances. "CAMERA SPECIALTIES"
P. O. Box 3182 Hollywood, Calif.

We have a customer who wants to buy

16mm KODACHROME

Footage of unusual shots and scenes of general interest to rest of the world. Send films to us for preview by our customer. Accompany film with complete written description of subject. Photography must be good and film free from scratches. If interested, customer offers 25c a foot up, depending on subject value and interest.

Address
DEPT. "H"

EASTMAN KODAK STORES
643 South Hill Street Los Angeles, Calif.

8M RAINBOW 16M

Vacation Specials on Anti-Halation Base Films

	25'	100'
	8mm	16mm
No. 1 A. H.	\$.95	\$ 1.90
No. 2 A. H.	1.60	4.25
No. 3 A. H.	1.40	3.50

Postage and Processing Included
WESTON RATINGS
No. 1—12-4 No. 2—50-32 No. 3—24-16

10% off on six rolls or more.

RAINBOW LABORATORIES
STATEN ISLAND, N. Y.

FACTORY OUTLET SALE ON BEADED SCREENS

Custom built deluxe box screens beaded with automatic arms. \$7.50; 30x30 beaded screens, tripod model, \$3.98; beaded screens, size 30x40, complete with carrying case, \$2.75.

All Shipments F.O.B. New York
WHOLESALE CAMERA SUPPLY COMPANY
29 W. 34th St. Dept. H New York City

ABSOLUTELY FREE 5,000 "A TO Z" MOVIE TITLING TRY-IT-YOURSELF KITS

Also Sample "Figurette" FREE
Send Today - Keep the Kit - It's Yours
JACOB STEIN, Mfr.
175 Fifth Ave. Dept. H 16 New York

BRITELITE-TRUVISION

America's foremost line of motion picture screens, spotlights, reflectors, paper safes, etc.

Write for complete details.
MOTION PICTURE SCREEN and ACCESSORIES CO., INC.
351 West 52nd St., New York City

emerges from that source in all directions in straight lines and continues in straight lines until it is reflected into a new path, bent around a corner by some thin, sharp edge such as a lens diaphragm; and then finally absorbed into some opaque body, ending its career, on the average, at the ripe old age of something like one-millionth of a second!

Except in rare cases, the recording of objects on film by means of photography is accomplished by reflected light. Since objects absorb more or less of the light that falls upon them, the amount of light reaching the film through the camera lens varies according to the reflective properties of the objects being photographed and produces a negative composed of light and dark areas of varying intensities. These are the highlights and shadows and are the basis of the picture.

Given a light-sensitive medium (the photographic film) and an object illuminated by a light source, it is only necessary to have a lens properly mounted in a light tight box in order to have the bare essentials of a camera.

There remains, therefore, only the examination in detail of the manner in which the lens forms an image of the object on the surface of the sensitized film, in order to proceed toward a complete understanding of the most basic of all the principles of photography—lens action.

Pro-16's . . .

ies are doing so on 16mm. The fact that most of these are musical proves, too, that sound recorded directly on 16mm is now accepted as equal in quality to that on 35mm.

Cartoons

Walter Lantz, noted Hollywood creator of many famous animated cartoon characters, is now engaged in producing animated cartoons directly on 16mm film for the ever-growing sub-standard film market. While such production especially for the 16mm market is new, Lantz's filming of cartoons in 16mm is not. Prac-

tically every major 35mm Lantz cartoon production is first filmed in 16mm for study and possible improvement before finally shooting it in 35mm for theatrical release.

Merville . . .

Continued from Page 362
speed, and consequently longer exposure, required for adequately exposed Kodachrome night shots. So successful was this gadget, one San Francisco firm rented Merville's camera to make pictures of the Fair for commercial release. It was the only 8mm camera of that make capable of shooting at the required exposure.

Shortly before his passing, Ray Merville, together with four or five other amateurs who delighted in taking things apart and putting them together again, formed the "Gadgeteers Club" in San Francisco.

Ray Merville will be remembered for his willingness to help the other fellow, to discuss his problems and to go to any length to find the right answer to a problem if he did not already have it. In a few words, those who knew Ray Merville not only liked and admired him, but also respected him for his knowledge and ability.

We'll miss Ray Merville.

Can I Improve My Films . . . ?

Continued from Page 383

sure, frequent change of pace and camera set-ups for long, close, and medium shots. Particularly notable was this filmer's flair for "camera-editing."

"AFTER MIDNIGHT" ★★★

175 ft. 8mm
By W. T. O'D., San Francisco

Continuity: This picture rates three stars particularly for the special effects employed which are among the best seen in an amateur picture for sometime. It is evident that the story was purposely conceived to enable this amateur to use several gadgets for making trick and special effects. The picture opens with several

TITLES
make the picture!
... and MITTENS PIN LETTERS make superb titles . . . clean-cut plastic letters in a variety of sizes and styles; also decorations.
Complete Sets \$5.50 and Up
MITTENS LETTER COMPANY
Redlands, California

Use **"PEERLESS" DEPENDABLE** 16mm REVERSAL FILM
A \$2.00 B \$2.75 C \$3.50 CX \$4.50
Weston 6 Weston 12 Weston 24 Weston 32
Furnished on 100-ft. daylight loading spools, including same day processing.
8mm REVERSAL FILM
A 1.25 B 1.50 C 2.00 CX 2.50
Complete Professional Laboratory Service for the Amateur
8mm 16mm 35mm
Peerless Camera and Film Service
7 W. 45th St., N. Y. C. 11 River Dr., Passaic, N. J.

Guaranteed 24-Hour PROCESSING
EXCLUSIVE with Eso-S Pictures is the modern soft-flash system reversal process which insures an even, correctly tone-balanced, fine-grain reel of films consistently!
Double 8mm, up to 34 feet..... 45c
Single 8mm, up to 34 feet..... 25c
Univex Std. and U. P., and ALL Eso-S single 8mm films..... 15c
These prices apply to all bulk films, including the new Gevaert Ortho, Microgan and Super Panthro, DuPont, Eastman positive, and our own complete line of reversal films.
REELS AND CANS RETURNED WITH THE FINISHED FILMS UPON REQUEST
ESO-S PICTURES
"Quality 8mm Service"
3945 Central Street Kansas City, Missouri

CORONA 8mm 16mm
BETTER REVERSIBLE FILMS
Super Pan Anti-halo 24-16 \$ 4.00
Super Ortho Anti-halo 16-6 \$ 3.70
Semi Ortho Outdoor 8-2 \$ 2.00
Double 8, 25 ft. 1.00
1.45 1.00
Above includes processing and daylight spooling.
BULK FILMS—16mm; Dble 8 Scored
16mm, 100 ft. \$ 3.15 \$ 2.80 \$ 1.25
16mm, 400 ft. 11.50 10.80 4.00
Dble. 8, 100 ft. 3.50 3.00 1.25
Dble. 8, 400 ft. 13.00 11.50 4.00
Above prices do not include processing.
Fine Grain Pan (12-8) Same Price as Super Ortho
REVERSAL PROCESSING—16mm and 8mm
100 ft.85c 50 ft.65c 25 ft.50c
All orders shipped postpaid except C. O. D.
Corona Film Laboratories
200 East 34th St. Brooklyn, N. Y.

BETTER Home Movies
when you use **Wonderlite Photo Lamps**
Write for Our Price List
WONDERLITE CO. 14-H Northfield Ave. WEST ORANGE, NEW JERSEY

Patents and Trade Marks
Patent and profit by your inventions. Protect your most valuable assets. . . . Expert personal service.
LESTER L. SARGENT
Registered Patent Attorney
1115 K St., N. W. Washington, D. C.

good night scenes of a city, showing the blinking lights on theatre marques, etc. A cut to a theatre entrance shows a couple coming out, and then getting into a taxi. We see them next in a restaurant, and the lady orders broiled lobster against the advice of her escort. The couple leave, and we next see the girl bidding good night to her escort at the entrance of her apartment.

In her apartment, the words of caution of her escort against eating lobster preys on the girl's mind. She becomes jittery at every little noise and shadow. Her fright increases when she sees in her mirror, what appears to be the shadow of a man outside her window. It proves to be an article of clothing hung out on a line.

After retiring, the girl has difficulty getting to sleep, and then dreams of burglars, murderers, etc. Suddenly she awakens with a start and sees the vision of a huge lobster above her head—one of the nice jobs of superimposition accomplished by this filmer. Came the dawn and the girl arises, swearing never more to eat lobster at midnight.

Editing: The picture is well cut and interesting angles are given when needed to increase interest. In the restaurant sequence, the camera is moved frequently from one side of the table to the other to add interesting angles of study to the characters in the play. Nice lap-dissolves, smoothly executed, add to the quality of the editing in indicating lapse of time.

Titling: Good. Here, also, lapdissolves are used. Some are a bit over-exposed; but as a whole they are o.k.

Photography: On the average, very good. Some of the exteriors in the restaurant were a bit underexposed; but the wide expanse of scene that it was necessary to light undoubtedly made it difficult to obtain adequate exposure without use of super XX film.

"BOAT FEVER" ★★★
175 ft. 8 mm — By E. J., Los Angeles.

Continuity: In the opening scene is planted the idea which ties the succeeding boat scenes together. Two men are seen leisurely examining a catalog of boats. The question arises whether one of them is to buy a sail or motorboat. The two de-

cide to visit a lake, look over the boats, and then make a decision. After their arrival, we see them admiring a sleek motorboat, and this is followed by a great number of scenes of the boat in action on the water, and some fine water skiing scenes.

At the close of the picture, we still do not know what is their decision. No sail boats were shown, and therefore it would probably have been better to indicate at the beginning that they were going to the lake for a demonstration of motorboats. Just an explanatory title or two would have helped the continuity considerably.

Editing: As a whole, the picture is well edited. Early scenes could be shortened somewhat as they tend to slow up arrival at the main theme of story.

Titling: The few titles were well lettered, nicely centered, and well exposed.

Photography: Is very good throughout. Good exposure, some very fine angle shots, and some swell dramatic views of the speeding boats and of the water skiers.

Reader Speaks . . .

• Continued from Page 364

loading or unloading is essential, the sides of the reels may be covered with discs cut from heavy black paper and glued in place. We sincerely regret the omission of this vital information in the original article and invite any reader interested in building such a film magazine to write us for any further details that may be desired.

• We want suggestions and ideas for random "backyard" filming; also for simple home movie scenarios. Those which are published will bring the contributors either a 100-ft. 16mm or a 50-ft. 8mm film subject selected from the advertisements in HOME MOVIES magazine.

For ideas that can be adapted to a feature length article we will reward the contributor with two rolls of panchromatic film. Address your suggestions to BACKYARD MOVIES, care of HOME MOVIES, 6060 Sunset Boulevard, Hollywood, Calif.

TITLE Backgrounds

By EDMUND TURNER

Although the title backgrounds which appear on this page are designed to fit the average 8mm and 16mm "typewriter" style titler, they are adaptable for use with any size and make of titler simply by having the illustrations copied and enlarged to the required size. You can do this yourself with your still camera, or you can have it done by photostat process by any blueprinting firm. This also applies where reduction in size is desired.

• • •

Where only a slight enlargement in size of title card over the size of these backgrounds is required, you will find it expedient to paste the backgrounds over cards cut to desired size from colored, tinted, or patterned stock. This will give you a border of an additional tone which will prove very pleasing in appearance, and will solve that problem of white space around title where title background fails to fit your titler exactly.

• • •

HOME MOVIES title backgrounds are now available in packets of 25 assorted cards for either black and white or Kodachrome films. The Kodachrome assortment is printed in colored inks on a variety of tinted papers, offering the amateur a splendid series of multi-colored art backgrounds for his titles. Order direct from HOME MOVIES, enclosing 50 cents for each set desired.

• • •

HOME MOVIES welcomes suggestions from readers for title backgrounds and supplemental title captions. Send us your ideas.

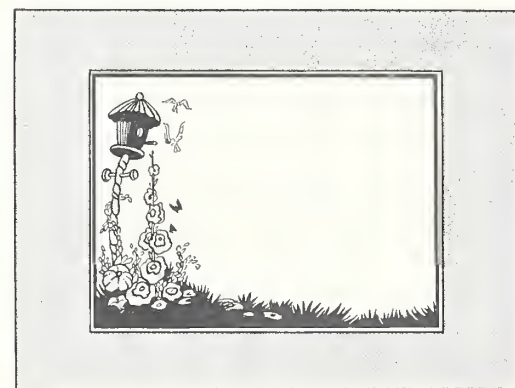
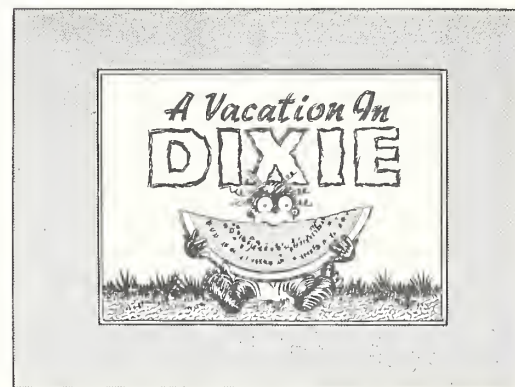

CLASSIFIED

ADVERTISING

EQUIPMENT FOR SALE

● BASS SAYS: August is a good trading month. Here are some splendid values sold on a money-back guarantee:

USED CAMERAS

Filmo 70-DA, brown, Cooke F:3.5, Wollensak F:1.5, Zeiss Telephoto, like new, with case, \$215.00.
Cine Kodak Special, latest model, 1" F:1.9, 3/4" Tele F:4.5, \$332.50.
Filmo 75, 16mm, Cooke F:3.5 lens, \$39.50.
Simplex Pockette 16mm F:3.5 lens, \$22.50.
Filmo Magazine Model 141, 1" Wollensak F:1.5 lens, \$104.50.

LENSES

1" Berthiot Cinor F:1.9, focusing "C" mount, including Hyper-Cinor attachment for wide angle, Ampli-Cinor for telephoto, all fits on same lens, unusually efficient, \$87.50.

FADE-OUT AND EFFECTS

Fadette, fits most lenses, complete, \$5.95.
Bool-Fader, a big seller, complete 64 effects, \$17.50.
Fade-O-Scope, a new Polaroid fader, \$18.75.

NEW EQUIPMENT

The new RCA 16 mm S.O.F. Model PG 170, 750 watt, complete \$300.00.
The new Revere Double 8 Camera with F:3.5 lens, \$29.50.
New Revere Double 8 Turret Camera with F:2.5 lens, \$65.00.
New Revere Double 8 Model B Projector, 500 watt, \$59.50.
Mail your name for the forthcoming new 80-page greatest of all Cine Bargainers.

BASS CAMERA COMPANY

Dept. HC 179 W. Madison St., Chicago, Ill.

● FULL LIST PRICE ALLOWED FOR: Eastman Model 20 toward a new Bell-Howell Sportster. Kodascope EE toward Bell-Howell Film-Master. Eastman 8mm Model 25 or Bell-Howell Sportster toward a Bell-Howell Turret or an 8mm Bolex. 500-watt Keystone toward a new Bell & Howell 8mm projector. NEW MAGAZINE CINE FIGHT FOR IMMEDIATE DELIVERY. Full list price for your Model 20 or 25 Eastman, for Keystone F:3.5 or F:2.7, or for Bell-Howell Companion toward this camera. AS NEW: Bell-Howell Sportster with Wind-Bak, \$75. Bell-Howell Companion with Wind-Bak, \$49.50. Bell-Howell Turret with Wind-Bak, \$129.50. Eastman 16mm Magazine, F:1.9, \$75. 1" F:1.3 Laack Lens, \$39.50. 15mm F:1.5 Dallmeyer lens, \$49.50. 3" F:4. Wollensak, \$29.50. 30x40 beaded screen with tripod, \$7.95; 36x48, \$10.50; 39x52, \$12.50. USED: Victor Model 24-B sound projector, \$97.50. 16mm Ampro, silent, 750-watt Model K, 1600' arms, \$97.50. Hundreds of other bargains. Write NATIONAL CAMERA EXCHANGE, established 1914, 11 So. 5th St., Minneapolis, Minn.

● 16MM ENLARGER. Made by Eastman, with projector for lamphouse. Gives enlargement approximately 4x5 of your 16mm frame. Can also be used as viewer for editing. Originally sold for \$90.00. The first \$20.00 takes it. Perfect condition. Box RR, Home Movies Magazine, 6050 Sunset Blvd., Hollywood, Calif.

● WE BUY, SELL, exchange all motion picture equipment, new or used, Bell & Howell, Eastman, Victor, Keystone. Closing out still cameras, supplies, accessories. Write for Bargain Bulletin. We rent cameras, projectors, lights, all accessories, 8, 16, 35mm in metropolitan area only. CAMERA MART, Dept. G, 70 West 45th St., New York.

● FULL price for your Eastman 20, Keystone 3.5, or Revere 3.5 on Eastman Magazine 8. Bolex H-16, Hektor lens, slightly used, including DeLuxe case, \$229.00. Eastman model B with F:1.9 lens, combination case, \$47.50. Better deal at FINNS, 118 So. Robert St., St. Paul, Minn.

● FOR SALE—Eastman 8mm model 60, F:1.9 and 1 1/2 inch F:4.5 telephoto. Can't be told from new! L. J. MURPHY, Box 818, Anderson, Ind.

● PROJECTOR, combination 16mm and 8mm Ditmar. You can show either 16mm or 8mm pictures on this 500-watt projector. Switchover very simple. Original price more than \$200.00. For quick sale, \$125.00, A-1 condition. Box RT, Home Movies Magazine, 6060 Sunset Blvd., Hollywood, Calif.

● BOLEX 8 with 1/2", 1", and 2" lenses, filters, case. Take your camera part payment. Box 47, Scottsbluff, Nebr.

● AMPRO PROJECTOR—Practically new, 16mm, 750-watt, pilot light, new bulb, fully reconditioned. Cost \$175, will sacrifice for \$95.00. Box 5, HOME MOVIES, 6060 Sunset Blvd., Hollywood, Calif.

● PAILLARD BOLEX Headquarters for the West is Morgan Camera Shop. Try the multi-featured Bolex 16mm or 8mm camera before buying. See them at 6262 Sunset Blvd., Hollywood, California.

● Ten cents per word; minimum charge, \$2.00 cash with order. Closing date, tenth of preceding month. ● HOME MOVIES does not guarantee goods advertised.
● Send ads to 6060 Sunset Boulevard, Hollywood, California.

EQUIPMENT FOR SALE

● MOVIE Cameras, Films, Projectors, etc., bought, sold, and exchanged. Big lists. Free. Art samples, 25c. PEERLESS, Box 1310-H, Hollywood, Calif.

● TELEPHOTO LENS SPECIAL—List \$50.00. 1 inch F:1.5 for 8mm Keystone, Revere, Bolex, Emel cameras. Use with black and white, colored films. Bargain, \$12.50 C.O.D. \$1.00 deposit. MALENA CO., 616 Market St., Philadelphia, Pa.

EQUIPMENT FOR SALE

● TURRETS for Keystone 8mm including 1 1/2" F:3.5 telephoto, \$39.50. Same for Filmo, \$46.50. WINDBACKS for Keystone, \$15.00. Filmo, \$19.95. CUSTOM-BUILT CAMERA ACCESSORIES CO., 4124 Rawlins, Dallas, Tex.

● 4 STAR ★★★★★ movie products are designed to fill your cine needs. 4 STAR Movie Screens in standard sizes, prices from \$3.95 up. Special sizes to fit your home theatre needs can be made up at reasonable prices on order. Hollywood Cine Products Co., 3221 South Figueroa, Los Angeles, Calif.

BOOKS . . . that tell you how!



A new handbook for the beginner. Takes up where your camera instruction book leaves off. Contains essential data on fundamentals of making good home movies, boiled down in one small, easy-to-read volume. Makes clear in easy-to-understand terms the use of lenses, threading of camera, setting exposure, correct focusing, etc., and points out mistakes to avoid that will save many dollars in wasted film. Per copy.....

50c



The latest, most complete book on titling home movies which includes, in addition to complete plans for building the renowned Home Movies Titler, such data as Title Area Chart, Lighting Chart, Diopter Lens Chart, How to Make Trick Titles, Data on Use of Shims for ultra-closeups, etc. There's approximately 100 pages jam packed with vital information for every amateur movie maker. Price

\$1.00

per copy.....

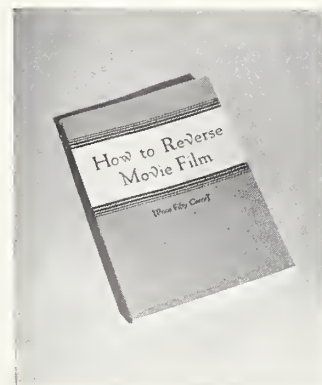

The leading textbook for the amateur on the subject of reversing home movie film. Over 5000 copies sold to date! Illustrates and describes how to build home processing equipment; gives all the popular reversal formulas; and tells how to intensify or reduce over- or under-developed films. Get this book today and start processing your own films for greater economy and pleasure in home movie making. Per copy.....

50c

per copy.....

VER HALEN PUBLICATIONS
6060 Sunset Boulevard • Hollywood, Calif.

FILM RELEASES (8 and 16mm)

● SOUND AND SILENT films exchanged, bought, rented, sold. Bargains always. New free lists. FRANK LANE, 5 Little Bldg., Boston, Mass.

● HIGHEST PRICES paid for 16mm subjects, comedies, features. 7-reel programs rented anywhere. ASHA FILMS, 785 St. Johns, Brooklyn, N. Y.

● CASTLE FILM library, 8mm, 16mm bulk film. Bargains in cameras and projectors, Keystone, Univex, Excel, and Victor lines. R. C. CAMERA & PHOTO SUPPLY CO., 3357 East 66th St., Cleveland, Ohio.

● UNUSUAL ART film catalog. All latest releases. Send 10c for sample. ERWINE'S CINE LABORATORIES, 143 No. 9th St., Allentown, Pa.

● WRITE FOR our new 8mm rental catalog. Films shipped everywhere. No extra charge for shipping. We pay both ways, express or parcel post. ABBE FILMS, 1265 Broadway, New York City.

TITLING SERVICE

● 16MM SERVICE. Titles, 4 for \$1.00. Toned for Kodachrome, 3 for \$1.00. Title cards ready for shooting. L. J. WHITEMAN, 312 East 7th St., Clovis, N. Mex.

● 8MM TITLES by Lamar. Stock and custom-made titles. Free catalog. (Dealers' inquiries invited.) RIEDEL FILMS, 2221 West 67th St., Cleveland, Ohio.

● DON'T leave those vacation films and valuable family record films go untitled. Write for our illustrated (FREE) literature showing the beautiful professional titles you can make easily with Pin Letters. Letters are available in sets or can be purchased individually. PIN LETTERS are made in all sizes from 3/4" to 9". Write now to Mittens Letter Co., Dept. HM, Redlands, California.

FILMS

● MOTION PICTURE FILM, daylight loading, Weston 8, processing included, 100 ft. 16mm—\$2.00. 50 ft. 16mm—\$1.25. 25 ft. 8/8mm—75c. Write for price list. RITZER FILM SERVICE, 629 Lyman Ave., Oak Park, Ill.

PROCESSING SERVICE

● 8mm DUPLICATES, 3c ft. Intensifying, reducing. 2c ft. Processing 8-8, 40c Single 8, 25c. CINE-FOTO, 128 Wilson, Springfield, Ohio.

WANTED

● CASH FOR your silent features, comedies, cartoons, serials, and educational. Submit list and prices today. INSTITUTIONAL CINEMA SERVICE, INC., 1560 Broadway, N. Y. C.

ENLARGING SERVICE

● ALL 16mm positives enlarged to 2 3/4 x 3 3/4" negative and printed. Minimum order 4 frames, 60c, on 100-foot roll. Each additional, 13c. Tie Thread to frame chosen. LUSTIG'S, 800 Eighth Ave., N. Y. C.

CAMERAS AND PHOTO SUPPLIES

● MAKE money in photography. Learn quickly at home. Easy plan. Previous experience unnecessary. Common school education sufficient. Interesting booklet and requirements free. AMERICAN SCHOOL OF PHOTOGRAPHY, 3601 Michigan Ave. Dept. 263C, Chicago, Ill.

MISCELLANEOUS

● BACK ISSUES "Home Movies" magazine—January, February, March, April, and May, 1940—25c per copy while supply lasts. HOME MOVIES, 6060 Sunset Blvd., Hollywood, Calif.

● AVOID MISTAKES! Save money and film by taking proven short cuts. "MOVIE KINKS"—the movie maker's series of manuals were specially prepared to meet the need for a simple and concentrated reference set for the amateur movie maker. "Movie Kinks" are academic textbooks written so the amateur can readily grasp every principle. Collect the series! Per copy 25c.

● ART BACKGROUNDS for your home movie titles—25 of them already printed ready to use in your typewriter titler. Available in two sets—No. 1 for black and white movies; No. 2 in colors for Kodachrome. Be sure to specify which set desired. Price, each set, 25c—prepaid.

● KEEP EVERY issue of Home Movies in good condition in a sturdy and attractive leatherette binder. Holds 12 issues of the new size. Each issue readily inserted or removed. Sent postpaid for \$1.25.

● ANIMATED CARTOONS is the title of a new book which shows you how to draw cartoons for animated movies. Written and compiled by Walter T. Foster, one of Hollywood's foremost animators. One of the best aids for the serious amateur interested in animation. Mailed prepaid for \$1.00.

Reader's Service Bureau
HOME MOVIES MAGAZINE
6050 Sunset Blvd. Hollywood, Calif.



Open the hinged side of the camera ...

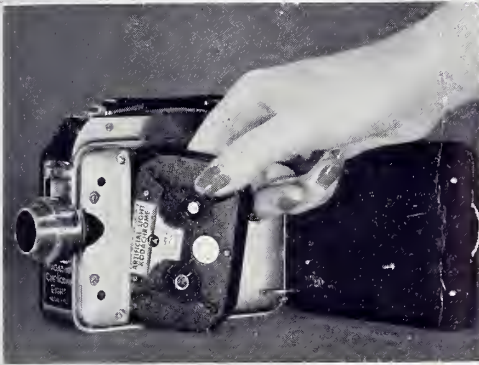

Insert a magazine of Ciné-Kodak Eight Film ...

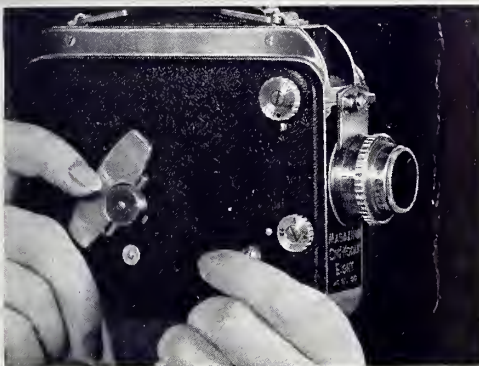

Close the camera, and you're ready to make movies.

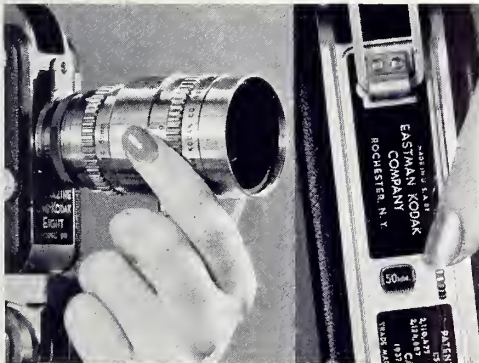

You have a choice of accessory lenses; view finder adapts accurately for each.



Any of four useful operating speeds, including "slow motion," may be used.



It's New... It's Unique...

MAGAZINE CINÉ-KODAK EIGHT

HERE'S the biggest 8 mm. home movie news since the "Eight" itself—a camera that loads with magazines of film, thereby eliminating all film threading.

It is not merely a convenient, easy-to-use camera; it is an immensely capable and versatile movie maker, incorporating features which make it unique among 8 mm. cameras.

Its standard lens is a remarkably fine Kodak Anastigmat 13 mm. $f/1.9$; and it takes five accessory lenses which can make close-ups of long shots and otherwise extend the scope of your movie making. The enclosed view finder adjusts accurately to show the correct field for each lens.

You have your choice of four operating speeds—16, 24, 32, and 64 frames per second.

Ciné-Kodak Super-X Panchromatic Film and both types of Kodachrome are available in 25-foot magazines (which are run through twice, in the usual "Eight" fashion) at \$2.50 and \$3.75, respectively, processing included. Each gives you the movie equivalent of 100 feet of 16 mm. film.

See this superb new camera at your dealer's. It's a fascinating piece of work. It is priced at \$97.50.

To own it means 8 mm. movie making on a wholly new scale.

EASTMAN KODAK COMPANY, ROCHESTER, N. Y.

Presenting the *NEW* **FILMO AUTO LOAD**

... a 16 mm. Motion Picture
Camera of Superb Crafts-
manship and Advanced
Flexibility

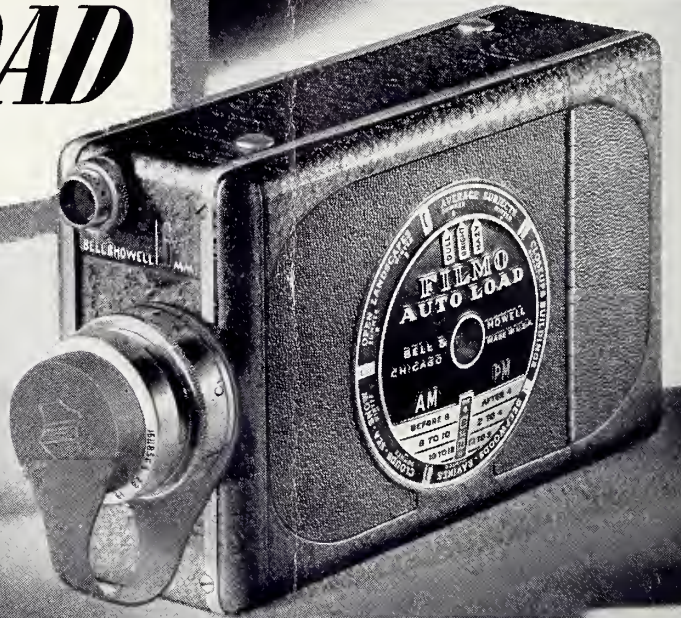

Effortless Loading—Loading is so easy that it can be done while wearing gloves. Simply slide the pre-threaded film magazine into place. Mid-reel changes from black-and-white to color film

may be made without fogging a single frame. A new unmistakable exposure chart gives readings at a single setting for both color and black-and-white film.

FOR those who delight in the possession of finer things, this new *Filmo Auto Load* Motion Picture Camera exemplifies the superb craftsmanship for which Bell & Howell is world famous. In addition to workmanship that makes no compromise with perfection in any detail, Filmo Auto Load presents a host of exclusive, advanced features that materially contribute to camera flexibility . . . simplify the making of finer motion pictures.

An improved viewfinder, enclosed and protected, gives an exceptionally brilliant image—and *what you see, you get*. Loading is effortless—just slide the pre-threaded film magazine into place. A new, unmistakable exposure chart gives readings at a single setting

for both color and black-and-white film. With four speeds and single frame exposure, and with a fast, color-corrected lens instantly interchangeable with a full range of special-purpose lenses, Filmo Auto Load is a basic camera that will meet your present and future needs. It is the personification of efficient simplicity, precision-built by the makers of Hollywood's professional motion picture equipment. It places no hurdles in the path of the beginner . . . imposes no limitations upon the most advanced skill . . . provides easy mastery of every picture opportunity.

Filmo Auto Load "Speedster"—identical twin of Filmo Auto Load except that it provides speeds of 16, 32, 48, and 64 instead of 8, 16, 24, and 32. Both are priced the same:

- With Taylor-Hobson 1-inch F 2.7 universal focus lens \$115.00
- With Bell & Howell 1-inch F 1.9 focusing lens 127.50
- With Taylor-Hobson 1-inch F 1.5 focusing lens 160.50
- Steady-Strap Handle included with camera

See the premier showing of this fine new motion picture camera at your dealer's now—or mail the coupon for complete details, Bell & Howell Company, Chicago; New York; Hollywood; London. *Established 1907.*

Image Brilliance Increased 250%!

An improved viewfinder increases the brilliance of the image two and one-half times—a wonderful aid when filming in poor light. This enclosed, protected viewfinder, being of the "positive" type, prevents errors in composition due to eye parallax. Operator, below, is holding camera by the new Steady-Strap Handle, an accessory which permits swinging the camera into instant action.

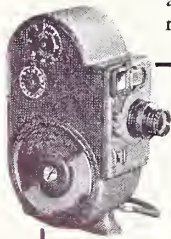

Filmo "Companion" 8 Makes Movies at Snapshot Cost

Press the button—*what you see, you get*. Black-and-white or full, natural color; four speeds including slow motion; device for animating cartoons; provision for adding accessories.

PRICE \$49⁵⁰

PRECISION-MADE BY

Bell & Howell

BELL & HOWELL COMPANY
1825 Larchmont Ave., Chicago, Ill.
Send complete details of the () new Filmo Auto Load
16mm. Motion Picture Camera; () Filmo 8 mm. Cameras.

Name

Address

City.....State.....

HM 8-40

September . 1940

Price 25c

HOME MOVIES



• Herman Bartel, New Rochelle, N. Y., winner Lloyd Bacon Trophy, Home Movies 1940 Amateur Contest.

STARTING: Educational Films Section -

**THIS
ISSUE**



Now—

NEW SERIES

Mickey Mouse
and

Donald Duck

films for

HOME MOVIES

By

HOLLYWOOD FILM ENTERPRISES, INC.

“Exclusive Licensee of Walt Disney’s Films for Home Use”

FLASH! An entirely new series of Walt Disney Productions in both 8mm and 16mm films for home movies—available for delivery Sept. 15.

Get ready now to enjoy this NEW parade of Walt Disney celebrated characters—Mickey Mouse, Donald Duck, Pluto, Goofy, Mickey’s and Donald’s nephews and all the others. Place your order now to assure first release on these exclusive new films.

Write for the big list of new subjects. 16mm films will be available in 25’, 50’, 100’ and 200’ length; 8mm films in 25’, 50’ and 100’ length, and every film will be screen-tested to assure perfect projection.

Order from your dealer TODAY.

Exclusive Distributors . . . SEEMANNS, INC.

6628 Santa Monica Blvd., Hollywood, California
In San Francisco—86 Third Street

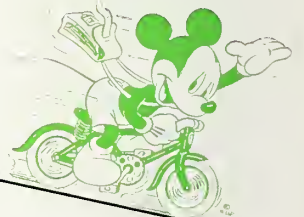

READY
for delivery
SEPTEMBER 15
Orders Filled in
Rotation
ORDER TODAY

HOLLYWOOD FILM ENTERPRISES, INC.

6060 SUNSET BLVD. • HOLLYWOOD, CALIF

SEP - 4 1940

©ClB 467411 ✓✓

VP

home MOVIES

Copyright 1940 by Ver Halen Publications. No part of magazine may be reprinted without specific permission.



★ Shot of the Month . . .

ADVISORY EDITORS

- GEORGE BURNWOOD**
The 8-16 Movie Club; Phila., Pa.
- JAMES BIALSON**
Amateur Motion Picture Club of St. Louis
- FRANK SNYDER**
Norfolk Amateur Movie Club
- HELEN RIEBETH**
Minneapolis Cine Club
- ALICE CISSE A. PELLETIER**
Toronto Amateur Movie Club
- ALAN W. NESTELL**
Cinemen Club
- ALFRED W. A. CADARETTE**
Los Angeles 8mm Club
- ALFRED F. KAUFMAN**
Indianapolis Am. Movie Club
- ALVIN DVORAK**
Suburban Amateur Movie Club
- ALAN D. ROUNTREE**
Bay Empire 8mm Movie Club
- ALBERT B. GRIFFITH**
Sunkist Movie Club
- ALFRED HUR E. GIBBS**
Portland Cine Club
- ALFRED A. HOOK**
Seattle 8mm Club
- ALFRED EMERSON CLYMA**
Detroit Society of Cinematographers
- ALFRED F. SISSEL**
Austin Movie Club
- ALFRED THEO. ROTH**
Sherman Clay Movie Club
- ALFRED D. E. SNYDER**
Des Moines Y. M. C. A. Movie Club
- ALFRED C. ENION SMITH**
Metro Movie Club of Chicago
- ALFRED MOSS BROWN**
Dallas Cinema Club
- ALFRED ER BEZEK**
Chicago Cinema Club
- ALFRED SSELL A. DIXON**
Pittsburgh Amateur Cinema Club

CONTENTS FOR SEPTEMBER, 1940

INFORMATION PLEASE.....	406
TITLE TROUBLES.....	408
BACKYARD MOVIES.....	410
WHAT TYPE FILM SHOULD I USE?..... <i>By S. J. Williams</i>	413
ANNOUNCING HOME MOVIES 1940 CONTEST WINNERS!.....	414
LIGHT AND LENSES IN CINE PHOTOGRAPHY <i>By Dr. A. K. Baumgardner</i>	418
HOME-MADE WIND-BACK FOR LESS THAN FIVE DOLLARS <i>By W. C. Kane</i>	420
FILM THIS SIMPLE ANIMATED CARTOON..... <i>By Walter W. Light</i>	422
TITLE CENTERING GUIDES.....	424
PRO RESULTS WITH AMATEUR EQUIPMENT IN HOME PROCESSING <i>By H. W. McConnell</i>	425
TELL ME — HOW CAN I IMPROVE MY FILM?.. <i>Reviews by the Editors</i>	426
HERE ARE DETAILS OF GEAR BOX FOR THE GLORIFIED SIXTEEN <i>By Arthur H. Hart</i>	427
EXPERIMENTAL CINE WORKSHOP.....	428
IT'S NEW TO ME..... <i>By Cinebug Shopper</i>	436
TITLE EXPOSURE CHART.....	445
DIRECTORY OF AMATEUR CINE CLUBS.....	453
TITLE BACKGROUNDS.....	455

EDUCATIONAL FILMS SECTION

1600 SCHOOLS SERVICED BY V. I. E..... <i>By Wm. J. Inskeep</i>	430
PLANNING THE SCHOOL FILM..... <i>By Godfrey M. Elliott</i>	431
EDUCATIONAL FILM TREATMENTS.....	432
NEW EDUCATIONAL RELEASES.....	437

★ Shot of the Month—Typical of enhanced effect obtained with use of filter.

CHAS. J. Ver HALEN
PUBLISHER

C. J. Ver HALEN, JR.
ASSOCIATE PUBLISHER

ARTHUR E. GAVIN
EDITOR

RAY FERNSTROM
Technical Editor

GEORGE W. CUSHMAN

J. H. SCHOEN
Associate Editors

COUNT H. von SCHOENFELDT
Photographic Editor

C. E. BELL
Associate Photo Editor

L. C. BUSCHER
Art Director

OFFICE OF PUBLICATION
6060 Sunset Boulevard, Los Angeles, Calif.
Phone GRanite 5149

NEW YORK OFFICE
Everett Gellert, 62 West 45th Street
Vanderbilt 6-5254

CHICAGO OFFICE
C. N. Burriss, 712 Wrigley Building
Whitehall 7784

Registered as Second-Class Matter, May 6, 1938, at Postoffice at Los Angeles, California, under the Act of March 3, 1879.
Subscription rates: U. S. \$2.00 per year. Canada and Foreign Countries, \$3.00 per year. Single copies 25c. Canadian and Foreign single copies \$1.00.
Copyright, 1940, by Ver Halen Publications.
Advertising rates on application.

**SEE THIS NEW
MODEL • A-82 • 16 MM
IT HAS
EVERYTHING
plus BRILLIANT and QUIET
PERFORMANCE**

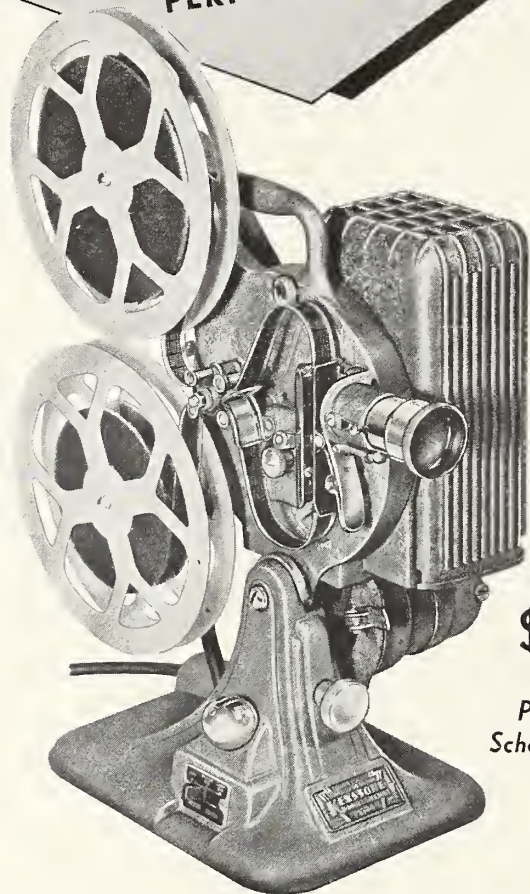

\$74.50
Perfect for Homes,
Schools and Churches

- ★ REVERSE PICTURES
- ★ COVERED REEL ARMS
- ★ 750 WATT LAMP
- ★ STILL PICTURES
- ★ AUTOMATIC LEVER RE-WIND

- ★ SILENT FINGER MOTION
- ★ COOL LAMP HOUSE WHEN RUNNING REVERSE
- ★ f.1.6 WOLLENSAK LENS
- ★ CENTRALIZED CONTROLS
- ★ SLOW SPEED FLICKERLESS PICTURES
- ★ PILOT LIGHT

and many other features listed in our literature

AMERICA'S LARGEST PROJECTOR LINE
KEYSTONE
KEYSTONE MFG. COMPANY • BOSTON, MASS.

Information PLEASE

"Syncing" Sound" (Gordon Prentice, Detroit, Mich.)

I recently purchased one of the new combination radio-phonograph-recorders—frankly, in order to make recordings for my home movies. However, I find that invariably the records I made of strictly commentary dialogue do not always keep time with my projector—or perhaps I should say my projector does not keep time with the record. At any rate, although I cut the record while projecting the film, sometimes the record will play and be satisfactorily synchronized with projection of the film, and then the next time projection seems to get ahead of the record. This, in spite of the fact that record and film are always started at exactly the same point at the same time.

Ans. This is a problem that will be encountered by many amateurs who are purchasing recorders for the purpose of making their own sound discs for home movies. You see, the phonograph and recorder turntables turn at absolute constant speed, being powered with synchronous motors, while the average projector is powered by an ordinary electric motor whose speed is governable by a rheostat. The trick, of course, is to get the projector turning first at the right speed to correspond with playing of the record and then to control it so it will be constant.

It was recently reported that one amateur corrected this trouble by hooking up a regular phonograph stroboscope disc to his projector and in this way he was able to "tune" his projector and turntable at the same speed. He would watch the stroboscope, after starting the projector motor, and adjust the rheostat until the stroboscope showed the projector was turning at the required speed.

• READERS: This department is for your benefit. Send in your problems and our technical board of professional cameramen will answer your question in these columns. If an answer by mail is desired, enclose addressed stamped envelope.

Hypersensitizing (John Alden, Houston, Texas)

Since reading your article on Hypersensitizing in the June issue, I have been told that equally good results may be obtained by hypersensitizing film after it has been exposed. Can you verify this?

The many requests we have received for further information regarding hypersensitizing film with mercury as a result of R. S. MacCollister's article in the June issue of HOME MOVIES prompts us to reprint our original instructions as they appeared in the February, 1938, issue of this magazine:

"Photographers who have wished for still greater speed than modern emulsions can provide will be interested in the new and practical method of dry hypersensitizing with mercury vapor recently published in the Journal of the Society of Motion Picture Engineers (Vol. XXVIII, No. 2). The new method, which is the result of experiments carried out by Drs. F. Dersch and H. Duerr at the Agfa-Ansco Research Laboratories in Binghamton, is extremely simple and surprisingly effective, giving from 50 to 150 per cent increase in emulsion sensitivity.

"To effect the hypersensitizing, wrapped or unwrapped film is merely placed in a sealed container with a small amount of liquid mercury (0.5 gm.) or silver amalgam containing a high percentage of mercury. The film is allowed to stand at room temperature from 36 hours for loose or unwrapped material to about a week for wrapped or tightly spooled film. The sensitizing action of the mercury vapor is reported

• Continued on Page 452

nt
in
h-
ai
ur
ff
d
d

cke
the
old
ts
pr-
os
pr-
ve
er
v-
h
Z
e
Z
I
V
i
e
e

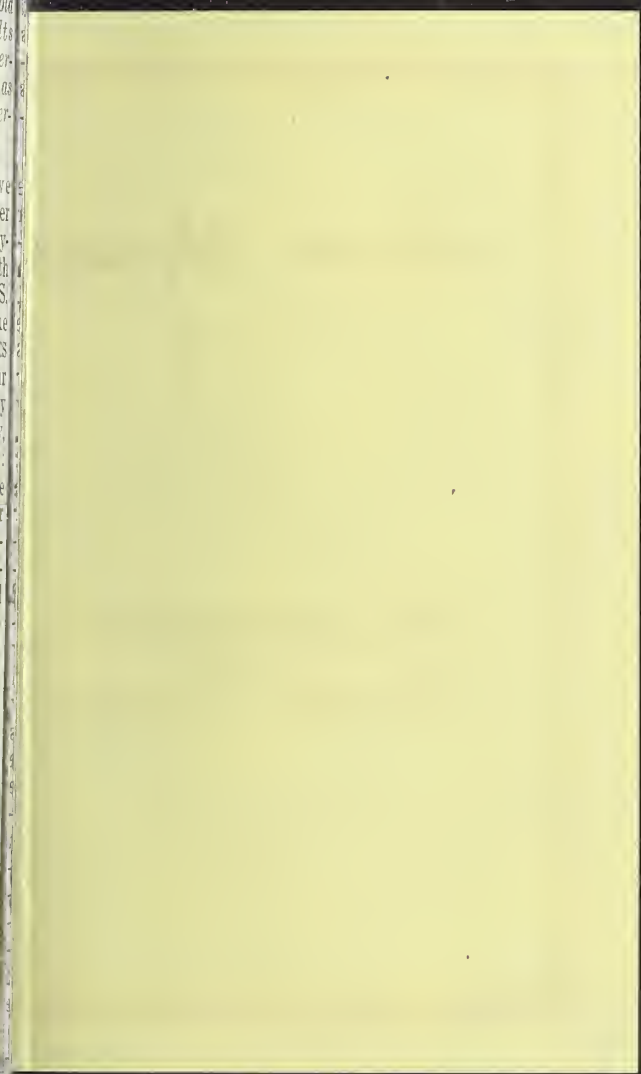

Home Movies

MAGAZINE



**Subscription
Order Form**





NOTHING finer than these new movies has ever resulted from the skilled efforts of Castle Films' professional camera staff and experienced editors! Each one marks a new, high achievement in the production of home-movies! Because of their extra excellence, each deserves a special niche in all 16 and 8 MM. movie collectors' libraries! New thrills and delights await all owners of Castle's 1940 Fall productions; and our great volume allows your ownership of these newest movies at surprisingly low cost!

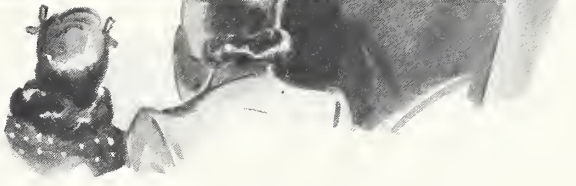

Highlights from our new Fall Films include these four unusual pictures



"WINGS OVER WORLD WONDERS"

The experience of a life-time! A sky-tour over the world! Swooping westward from New York, dipping down to fly the narrow airplanes of the Grand Canyon, soaring

above the Pacific's clouds to New Zealand's peaks and Japan's Fujiyama! You'll get a breath-taking planes-eye view of Europe's majestic Alps and great cities, you'll thunder over Niagara and see Egypt as it looks from the air! A picture that makes the flying carpet of legendry come to life for you in the intimacy of your own living room. Every shot is a photographic gem.



"COME BACK TO IRELAND"

Enchanting Erin, island of the beautiful lakes of Killybegs and the picturesque low-backed car! Visit, via this thrilling film, little thatch-roofed cottages and simple fisherfolk, stop in at Galway on market-day and

enjoy the fun at Blarney Castle! Marvel at the beautiful Shannon and the dramatic contrasts between the storied Ireland of song and verse and the alert and progressive Ireland of today!



"A THRILL A SECOND"

A pulse-beating, hair-raising action movie unlike any other ever produced! Men and women with nerves of steel tempt fate in about every way ever devised in the quest for new sensations! Always with danger around the corner, these dare-devils generally emerge winners. Chills, excitement, spills and risks, sixty to a minute, in the fastest-moving of all home-movies!



"MEXICO"

Monumental reminders of native Indian and foreign conqueror's civilizations share honors with the Mexico of the Twentieth Century! Picturesque natives and awesome scenery flash before your entranced eyes. You'll see the capital city's great cathedral and market place; you'll see Popocatepetl and the "place of the flowers", famed Xochimilco! You'll know intimately the pulse-beat and heart-throb of this land and people below our borders!

Get the new 1940-1941 Castle catalogue, illustrating and describing a hundred Castle films of world news, sports, travel, oddities and fun cartoons! Just off the press! It's free! Send for your copy now!



CASTLE FILMS, INC.

30 Rockefeller Plaza, New York City

Please send without cost your new 1940-41 Castle Films' catalogue.

Name _____

Address _____

City and State _____

B-9

CASTLE FILMS

30 ROCKEFELLER PLAZA
NEW YORK

FIELD BUILDING
CHICAGO

RUSS BUILDING
SAN FRANCISCO

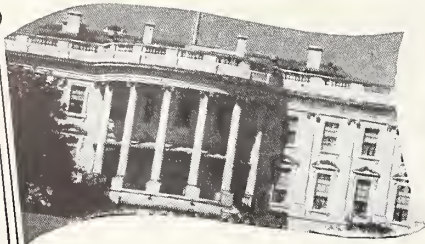

Democrats!

Republicans!

Americans!

HAVE YOU EVER SEEN THE HEARTBEAT OF DEMOCRACY?

You Should—and You Can in This Stirring Official Home Movie “Mr. President”

16mm - 8mm

Not the story of 1 president—but the story of the last 43 years and our last 8 presidents! Carrying you through prosperity and depression, peace and war . . . years that have tested “The American Way.” Woven around a central setting of the Cradle of Democracy, the White House!

See 8 famous presidents in action! McKinley, Theodore Roosevelt, Taft, Wilson, Harding, Coolidge, Hoover, Franklin D. Roosevelt! • Follow their historic careers! • See how they handled problems like those facing us today! • See how we were guided through two of our greatest wars!

Order This Official Film Today From Your Photographic Dealer!

	16mm	8mm
Feature	360 feet \$9.75	180 feet \$5.50
Short	100 feet 3.50	50 feet 1.75
Sound-on-film	350 feet 17.50	

FREE: Write for New Illustrated Catalogue of Official Films' Productions for 1940-41.

Insist on

OFFICIAL FILMS

330 WEST 42ND STREET, NEW YORK CITY

In Canada, GENERAL FILMS, 1924 Rose Street, Regina, Saskatchewan

• **TITLE TROUBLES.** •

By GEORGE W. CUSHMAN

IF YOU have any questions concerning titles or title making, Mr. Cushman will be glad to help you. You can address him in care of this magazine or direct to his home address, 3425 Witmer Parkway, Des Moines, Iowa. Include all the information you can, such as type of film used, illumination, developer, etc. Don't forget to enclose a self-addressed, stamped envelope for your reply.

ture in the camera made as large as that in the projector. You might trust this to a good machinist, but it would be safer, no doubt, to send it to the manufacturer for this alteration. Only other suggestion would be to make all your titles on reversal film, thus a black but unnoticed frame line would result.

Q. I have always developed titles under a red safelight, but understand the yellow light is better. Is this true, and if so, why? Where can I get one of the right kind?—V. P. L., Billings, Mont.

Q. I would like to make a title on a cloth background but do not know how to go about it. What kind of lettering would be best?—C. V. W., Raleigh, N. C.

A. Some workers prefer the yellow light, since it is easier to judge contrast as the film develops than with the red light. Usually, any light that is safe for enlarging paper is safe for positive film, since the emulsions are very similar. I would suggest you get Eastman's series OA safelight for this purpose.

A. There are several ways of doing this. I shall mention a few and you can take your choice. One method would be to take a picture of the cloth material and make an enlargement of it. The enlargement can be made to any desired size, and the weave of the cloth enlarged to any desired proportion. You can make the enlargement as dark as desired by over-printing it. Upon this enlargement the title is printed with white ink, paint or water color.

Q. The positive titles made with my 8mm camera show a white frame line when projected. If the line shows at the top and I frame it out, it appears again at the bottom. Titles made on reversal film do not show this line, and I am wondering what causes it. Any help would be appreciated.—J. D. S., Cincinnati, Ohio.

If the cloth is dark, you can photograph it direct with the movie camera, rewind the film, and re-expose a second time on the lettering. (In the latter instance the lettering should be white on a very black background—the blacker the better.) If the cloth is of light material, you will have to underexpose one or two stops so that the cloth will be darker than the letters.

A. The trouble lies in the fact that the aperture in the film gate of your projector is larger than the aperture in the film gate of your camera, consequently your projector shows more than your camera takes in. The reason titles on reversal film did not trouble you is that when reversed the frame line is black and did not show on the screen; but no doubt it is there, just the same.

If you plan to use positive film, you might take a picture of the cloth on process film with a still camera. The resulting negative should be developed very slightly, or until the image is barely visible. When dry, this negative is placed over the title, which this time should be black letters on very white paper. The single exposure is made on positive film, resulting in white letters on the cloth background.

My only suggestion would be that you have the aper-

• Continued on Page 452



Presenting

KIN-O-LUX

No. 3
GOLD SEAL

RATINGS

**WESTON TUNGSTEN 100
SCHEINER TUNGSTEN 29°**

(No outdoor ratings)

Created for indoor use, KIN-O-LUX No. 3 Gold Seal is a new, finer film for every occasion (except bright sunlight) where speed and quality are the first essentials. Compare the finer results attained with KIN-O-LUX No. 3 Gold Seal with those of any other make. Let that test prove to you why its superiority is unquestioned, its moderate price reflects true value, and why you can buy it at leading dealers everywhere.

100 feet \$6.00 50 feet \$3.50

For real movie pleasure always—ask for these other KIN-O-LUX films too:

KIN-O-LUX No. 1 (Green Box)	KIN-O-LUX No. 2 (Red Box)	KIN-O-LUX No. 3 (Lavender Box)
Weston 8	Weston 12	Weston 50
Scheiner 18°	Scheiner 20°	Scheiner 26°
		Weston Tun. 40
		Scheiner Tun. 24°
100 ft. \$3.00	100 ft. \$3.50	100 ft. \$6.00
50 ft. 2.00	50 ft. 2.50	50 ft. 3.50

ECONOMY • RELIABILITY • FINER RESULTS

Write for Booklet H9

KIN-O-LUX, INC. 105 West 40th Street, New York City

SEE
THE "STAR"
OF YOUR MOVIES

*at His Brightest
and Best!*

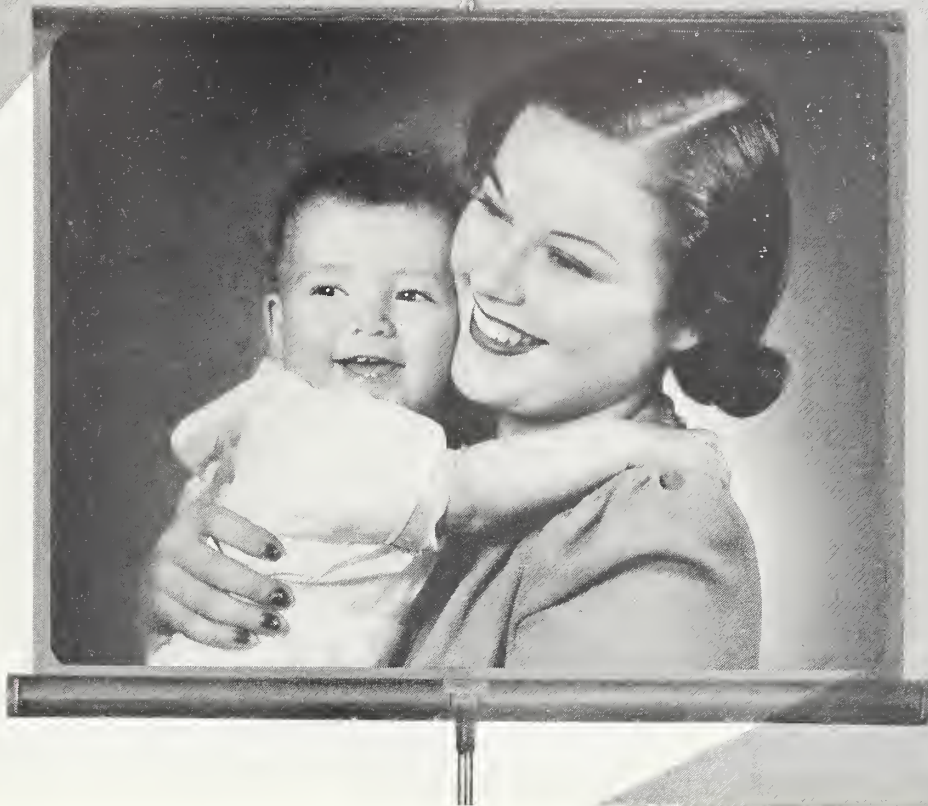

USE A



Reg. U. S. Pat. Off.

GLASS-BEADED SCREEN!



DA-LITE STANDARD
CHALLENGER

THE DA-LITE
CHALLENGER

Can be set up anywhere in
15 seconds; yet folds com-
pactly for easy carrying.

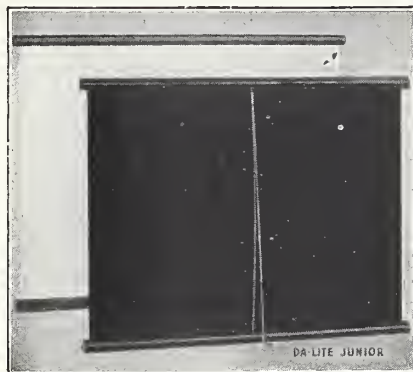

DA-LITE JUNIOR

Da-Lite Junior serves as a table model or hanging screen. From \$2.00* up.

Da-Lite Model D is housed in a leatherette-covered carrying case. 10 sizes: 22" by 30" to 72" by 96". From \$14.00* up.

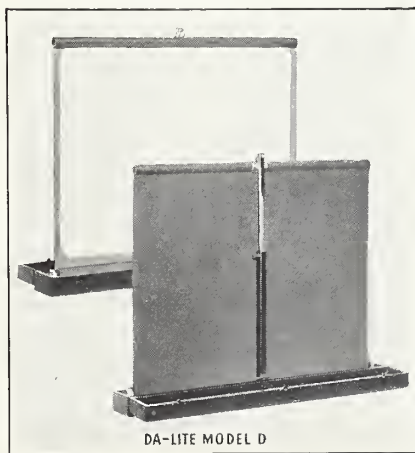

DA-LITE MODEL D

The Challenger is different from any other tripod screen. It alone has *square tubing* in the tripod and extension support to hold the screen rigid and perfectly aligned. It alone has the handle mounted on a sturdy bracket encompassing the case. Fully adjustable in height. Twelve sizes (including square and rectangular shapes) from 30" by 40" to 70" by 94". From \$12.50* up.

Da-Lite Model B (not shown here) is spring-roller-mounted in a metal case, with hooks for hanging. 12 sizes: 22" by 30" to 30" by 84". From \$7.50* up.

*Prices slightly higher on Pacific Coast.

YOU need the superior light reflective qualities of Da-Lite's specially constructed Glass-Beaded surface to bring out the full brilliance, depth, and gradation of tone in black and white film.

The extra light reflection of the Da-Lite Glass-Beaded surface is even more important when you show Kodachrome pictures. Kodachrome being more dense requires greater screen brilliance to bring out the true colors. Ask your dealer for a Da-Lite Glass-Beaded screen. For utmost convenience choose the Challenger. It can be set up instantly anywhere. Get your Da-Lite screen now and see the "star" of your movies at his brightest and best! Write for literature!

DA-LITE SCREEN COMPANY, INC.

*Manufacturers of Theatrical and Non-Professional
Screens with All Types of Surfaces and Mountings*

Dept. 9HM, 2723 N. Crawford Ave.

Chicago, Ill.

DA-LITE SCREENS AND MOVIE ACCESSORIES



THE UTMOST IN A SOUND MOTION PICTURE PROJECTOR

- ★ **Assured Film Protection**—Patented Safety-Trip immediately stops machine. To be found only on this equipment. With Offset Film Loop that eliminates damaging film pressure and side sway.
- ★ **Stationary Sound Drum** — Unequalled sound quality—no moving parts—No adjustment necessary for color or black and white.
- ★ **"Spira-Draft" Forced Cooling** — insures greatest lamp economy and safety.
- ★ **Flickerless Shutter** — unsurpassed clarity of pictures. Safety shutter for stills.
- ★ **Film Reverse** — Pressing one lever reverses film for reviewing. No rethreading necessary.
- ★ **Easy Accessibility** — to spotlessly clean all working parts. No special tools required.
- ★ **Multiple Use**—For classroom, auditorium, dances, outdoor events — with interchangeable units that mean Greater Economy and Widest Utility.



In no other equipment regardless of price can all of these advance features be found. Write today for complete description of these and other features.

VICTOR ANIMATOGRAPH CORPORATION
Dept. B-1 Davenport, Iowa

BACKYARD MOVIES

Ideas for Short Films

Dinner at Twelve

Recently I was at a friend's home for dinner where ten others were present. I wanted to make movies and to include everyone present in the scenes, so I worked out the following continuity.

The filming was started with a closeup of a kitchen clock showing time, 10 minutes to 12. This was followed by a shot of the lady of the house in her kitchen preparing dinner. Outside the house and in the garden were the guests doing various things, so I made brief shots of the various persons or couples in semi-closeups as follows: Mr. Brown sawing wood; three children playing marbles; a couple in a secluded nook; two girls going to the well for water; three ladies admiring flowers; etc.

Next, a shot of the clock showing 12 o'clock. Then a picture of Mrs. Brown stepping out on the porch and calling "Dinner's ready!" Then I made shots showing each group previously mentioned as they abruptly stopped whatever they were doing and hurried toward house. Two shots of each group were made — first, a shot of them starting to run, and second, a shot of them entering the house. The final shot is of a dog running and entering the house last. This last shot was made from a low camera angle.

Additional shots could be made of the guests about the dinner table if equipment is available for indoor lighting.

— Dean Smith.

Cine-Philatelist

I collect postage stamps and use my cine camera instead of a stamp album. Instead of collecting the stamps and placing them in a book, I photograph them, then film a short story built around the history or symbolism of each stamp or about the person or place pictured thereon. More recently I have placed emphasis upon dramatization of the important historical events which made the place or person pictured famous. I open each sequence with a

closeup of the stamp. This is followed by a brief description in writing, giving name, birthplace, date of death, profession, and the incident that made the particular character on the stamp famous. And finally, the dramatization of the incident.

— Harold Weigner.

Odd Shots

The following is an "odd-shot" continuity which I have used with success:

Scene 1: Closeup of child's hand taking new pencil out of pencil case.

Scene 2: Closeup of child's hand sharpening pencil in pencil sharpener.

Scene 3: Closeup of same hand writing or printing a letter.

Scene 4: Medium shot of child seated at desk or table, and writing.

Scene 5: Closeup of beginning of letter: "Dear Cousin: We miss you very much. I know you miss us too, so I'm writing about some of the things that have happened here recently. The other day my brother Robert—" (Fade in to suitable odd-shot scene).

After each sequence of odd-shots, splice in a continuation of the letter. Phrases such as, "Do you remember the time that—", or, "I'll never forget the day that—", etc., can precede each sequence. Now and then cut in a scene showing the child writing or sharpening the pencil with the main object of showing the pencil getting shorter and shorter, until it is so small the child can hardly write with it.

As a running gag, have the child break the pencil lead frequently. The closing scenes show the child yawning, then dozing off to sleep with head on desk.

— Max A. Goldberg.

MORE OOMPH FOR YOUR HOME MOVIES



with the

CRAIG PROJECTO-EDITOR

It takes proper **Editing** to make modern fast-moving, interest-sustaining movies. **ACTION-EDIT** your films the Hollywood Studio way — transform random shots into smooth-running sequences that everyone will enjoy seeing.

The Projecto-Editor provides a unique viewing method — allows careful inspection, slow motion if desired, of every movement on its brilliant miniature screen. Films may be readily removed from the polished guides for quick cutting and splicing.

At all dealers — Ask for demonstration.
8mm. model, complete . . . \$27.50
16mm. model, complete . . . \$49.50

CRAIG MOVIE SUPPLY COMPANY

1053 S. OLIVE ST. • LOS ANGELES, CALIF.

"Makes Editing a Pleasure"

Craig Senior Rewinds \$4.50 each or \$9.00 the pair

Craig Junior Splicer 8 or 16 mm., \$2.50

Craig Junior Combination Complete, \$7.25

Craig 16mm. Senior Splicer For sound or silent, \$10.00

Craig Senior Combination Complete, \$19.50

Craig Safety Film Cement—25c



• For filming ideas that can be adapted to a feature length article we will reward the contributor with two rolls of panchromatic film. Address your suggestions to BACKYARD MOVIES, care of HOME MOVIES, 6060 Sunset Boulevard, Hollywood, Calif.

**"NOW WATCH ME CLIMB
THE FENCE, Daddy"**



"Show Treasured Movies Brighter"

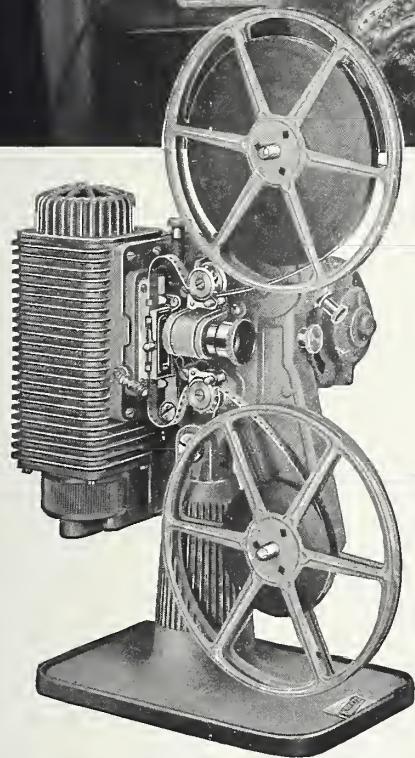

Revere Model 80
Series B 8mm Projector
Complete with 500-watt lamp and
1" F.1.6 lens, **\$59.50**

WITH THE
Revere
& Projector

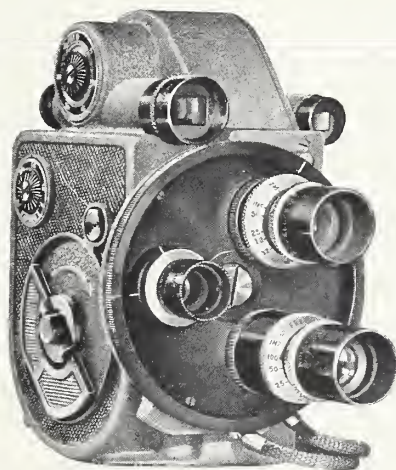

Your 8mm color or black and white movies of important events—picnics, outings, parties, etc.—will bring you greater pleasure than ever when shown with the Revere 8 Projector. This powerful instrument, with its 500-watt lamp and F. 1.6 lens, makes every shot brighter and clearer. Pictures are steadier, too, thanks to Revere's duplex shuttle film movement with its 10½ to 1 ratio.

Treasured films of your children, parents or friends—pictures that could never be replaced—are carefully handled by the Revere. Its large 15-tooth sprockets have roller guides to prolong film life. Cool air is blown not only against the lamp but against the film. Easily threaded and simple to operate. Rheostat speed control. Clutch control for projection of still pictures. Automatic rewind—all enclosed—motor driven—no belts. 300-foot reels. See the Revere Projector and Revere Motion Picture Cameras at your dealer's. Mail coupon below for complete facts now!

**You're Ready for "Anything"
With the Revere Turret Camera**

Model 99 has all features of Model 88 plus revolving 3-lens turret, extra optical viewfinder for telephoto lens. Special lenses available—1" F2.7,

1½" F 3.5, 12.5mm F1.9 focusing mount. Complete with one Wollensak 12.5mm F 2.5 lens, **\$65.00.**

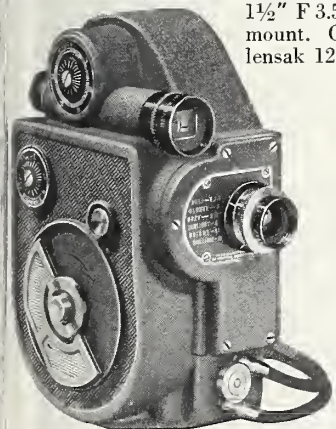

*Licensed under
Eastman Spool &
Spindle Patents*

**Take Better Color or Black and
White Movies with the
Revere Model 88!**

This palm-size double 8 camera has five speeds, large eye piece in no-glare built-in viewfinder, exclusive Revere Sprocket control and many other advanced features. Complete with Wollensak 12.5mm F3.5 lens in removable universal focus mounting, **\$29.50.** With F2.5 lens, **\$39.50.**



**REVERE Sprocket
Film Control** forms a loop in the film automatically . . . prevents film jamming. An exclusive Revere feature.

REVERE CAMERA COMPANY · CHICAGO
PHILADELPHIA · KANSAS CITY · MINNEAPOLIS · LOS ANGELES · DALLAS

REVERE CAMERA COMPANY
Dept. 9HM, 328 East 21st Street, Chicago, Ill.

Please send latest literature of Revere 8mm motion picture equipment.

NAME _____

ADDRESS _____

CITY _____ STATE _____

For Canadian prices, write to Ryerson Film Service,
299 Queen's Street, West, Toronto



Think you'll get it, Pete?

PETE'S probably pretty worried—for he certainly isn't getting his cracker the easy way.

Are *you* sure that you're not getting your movies the hard way too? Are you always certain of the best possible results? . . . You'll get better movies and get them more easily if you use the right film. Choose from Agfa's many fine amateur movie films:

FOR 16 mm. CAMERAS:

Triple S Pan Reversible, for indoor use and slow-motion work under light conditions requiring extreme speed.

Hypan Reversible, especially designed for outdoor work where brilliant contrasts are desired.

Panchromatic Reversible, an exceptionally good value as a fast, brilliant film.

Fine-Grain Plenachrome Reversible, an excellent outdoor medium of ample speed at a moderate price.

FOR DOUBLE-8 mm. CAMERAS:

"Twin Eight" Hypan Reversible, provides exceptional speed, fine grain and brilliant gradation—ideal for either indoor or outdoor use.

"Twin Eight" Panchromatic Reversible, nearly as fast as "Twin Eight" Hypan—giving brilliance, fine grain and high resolving power at low cost.

See these films at your dealer's. They'll help you get your movies the easy way!
Agfa Ansco, Binghamton, New York.

Agfa

16 mm. and 8 mm.

Film

MADE IN U. S. A.



HOME MOVIES

... Published in Hollywood

SEPTEMBER

1940

Authored by
S. J. WILLIAMS

What type **FILM** should I use . . . ?

WHEN home movie-making was born, some seventeen years ago, selecting the right film with which to load your camera was the easiest part of cinefilming. There was only one type to choose from! But today — well, a glance through the advertising pages of HOME MOVIES will show why one of the questions most frequently asked by the magazine's readers is, "What type of film should I use?"

As a matter of fact, though, this question can be answered much more easily than might at first appear. It's simply a matter of fitting the film to the requirements of the particular job in hand.

In spite of the bewilderingly great number of black-and-white film types available, they all fit into one or another of three broad groups—"color-blind" films, "ortho" films, and "pan" films. The chief differences between them are in their speed, or the amount of light needed to produce a normal exposure; their color sensitivity, or the way they "see" colors; and, of course, their cost.

The cheapest films are the so-called "color-blind" types. Most of these films consist actually of slow, positive emulsions of much the same character as the printing papers used for printing still negatives. They are sensitive chiefly to blue and ultra-violet light, and are virtually blind to all the other colors — hence the term "color-blind." They are generally quite slow, ranging in speed from Weston 4 to 8.

The "ortho" types are more or less comparable to the old-fashioned "standard" or "NC" type of still-camera roll-film. They do quite a bit better at "seeing" colors; they are not only sensitive to the ultra-violet and blue, but to the greens and yellows, too. Some of the best ortho types, the so-called "chrome" types, can even record a surprising amount of the orange. These films are a good deal faster than most of the "color-

blind" variety, ranging in speed from Weston 8 to Weston 16.

The aristocrats of filmdom are the "pan" types. The term "pan" is an abbreviation of panchromatic, which comes from two Greek words meaning "all colors," which is quite correct, for these films are capable of seeing and reproducing in relatively correct black-and-white values all of the visible colors — blue, green, yellow, orange, red and their intermediate shades. The "pan" family are faster, too, ranging in speed from Weston 8 to Weston 100 or more.

Now, what do all these facts mean in terms of practical picture-making? What are the cinefilming jobs for which these films are suited? Let's follow an imaginary scene through, and see how each type of film would record it. A pretty girl is always a good subject — so let's imagine a pretty girl wearing a pair of red slacks and a yellow blouse,

• Continued on Page 451

• Below: Examples of results to be obtained from use of various films. Girl is dressed in red blouse. Clear blue sky in top background. From left to right: Photo made with positive film. Note general over-all foggy effect due to lack of non-halation backing on film. Center photo made with ortho film. Non-halation backing makes for sharper detail. Right photo made with pan film. General improved color rendition is readily evident; also sharper detail due to ability to use smaller stop with faster emulsion.





GRAND PRIZE

Home Movies 1940
Amateur Contest
Awarded to Herman
Bartel for his picture

"ANGELS ARE MADE OF WOOD"

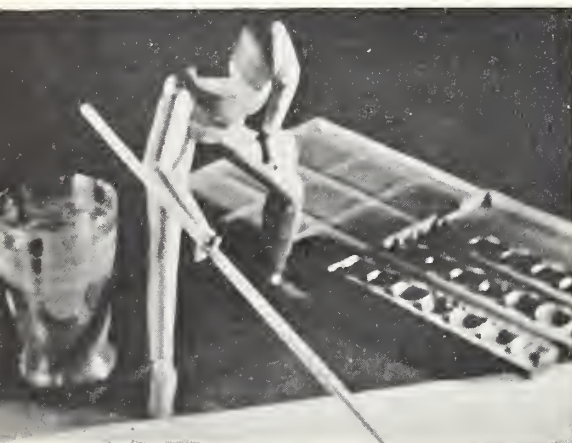
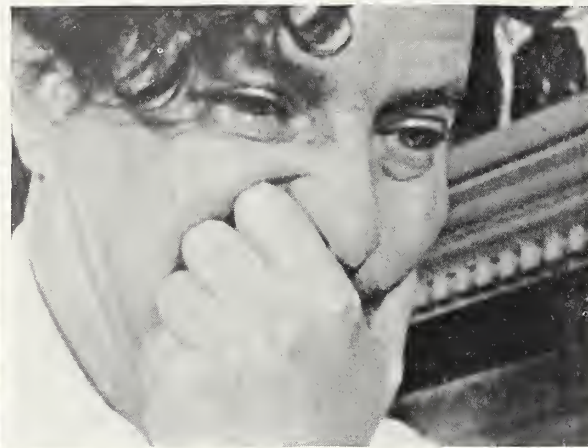

Announcing Home Movies' 194

AMATEUR movie making, now one of America's greatest hobbies, becomes even more important as results of HOME MOVIES' Annual Amateur Contest is announced. The number of entries in the 1940 contest exceeded those of last year by over one thousand. Increase in multi-reel pictures and wider use of color film indicates mounting enthusiasm in the individual cinefilmer. Two first prizes were captured by dentists, suggesting some great cinematic minds become more potent midst the whirring of dental drills. An actor—fashioned of wood—co-star of the Grand Prize film—looms

a new threat to Charlie McCarthy!

Even more significant is the fact serious amateur cinefilers are developing a technique distinct from that of theatrical picture producers. There is definitely not a tendency to imitate Hollywood picture making, but rather to make motion pictures with a new accent on pantomime as means of amplifying the story without a plethora of descriptive titles. This interesting amateur development is definitely evident in the first and second prize winning films in the Scenario Class.

But before delving further into merits of the

• Below, scenes from prize winning films in Scenario Class: Left to right—"Will and the Way," second award; "Diary," third award; and "Press Time," fourth award.





1st AWARD

*Documentary Class,
Home Movies 1940
Amateur Contest
Awarded to Richard
L. Cassell, D. D. S.
for his picture . . .*

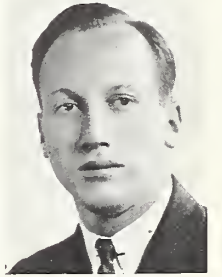

"HUMMING BIRD"

individual films, let us list here the prize winners together with the names of their producers:

Grand Prize

Angels Are Made of Wood, 200 feet 8mm, by Herman Bartel, New Rochelle, New York. Also the first prize winner in the Scenario Class. Award: Lloyd Bacon Trophy and Craig Projecto-Editor.

Scenario Class

2nd Place: *Will and the Way*, 200 feet 8mm, by Chester Glassley, Dallas, Texas. Award: Commander Exposure Meter.

3rd Place: *Diary*, 300 feet 8mm, by Harold E. Remier, Los Angeles, Calif. Award: Seemann Titler.

3rd Place: *Christmas Capers*, 200 feet, 16mm, by Erma Niedermeyer, Milwaukee, Wis. Award: Four-Star Beaded Screen.

4th Place: *Cat Tales*, 200 feet 8mm, by Mildred J. Caldwell, Long Beach, Calif. Award: Besbee Effectograph.

Honorable Mention

All Is Forgiven, 175 feet 8mm, by Harold Last, Milwaukee, Wis.

An Anaesthetic Fantasy, 300 feet 8mm, by Ernest Kremer, Flushing, New York.

Beautiful Allentown, 200 feet 8mm, by Arthur W. Heydt, Allentown, Penn.

Behind the Bottle, 400 feet 16mm, by Wm. R. Hutchinson, Newburgh, New York.

• Below, scenes from prize winning films in Documentary Class: Top — "St. Margarets," second award. Bottom, right — "Romance of the River," third award; and "Song of the Soil," fourth award.

CONTEST WINNERS...!

4th Place: *Press Time*, 1250 feet 16mm, by Rockville Cinema Club, photographed by Harry S. Smith, Rockville Center, N. Y. Award: Four-Star Titler.

Documentary Class

1st Place: *Humming Bird*, 400 feet 16mm, by Dr. Richard J. Cassell, D.D.S., Los Angeles, Calif. Award: Victor Model 3 Cine Camera.

2nd Place: *St. Margarets*, 400 feet 16mm, by Gordon MacCormack, Montreal, Canada. Award: Bool Cine-Fader.

3rd Place: *Romance of the River*, 400 feet 16mm, by Tom Swaja, Des Moines, Iowa. Award: Four-Star Beaded Screen.

4th Place: *Song of the Soil*, 700 feet 16mm, by E. C. Denny, Buffalo, New York. Award: Besbee Ediscope.

Family Films Class

1st Place: *Christmas Well Spent*, 175 feet 8mm, by Dr. J. Allyn Thatcher, D.D.S., San Francisco, Calif. Award: Thalmetal Tripod.

2nd Place: *Checking Off the Budget*, 1000 feet 8mm, by Bruce W. Johnson, Rockford, Ill. Award: 12 rolls Agfa Cine Flm.

By Rocket to the Moon, 650 feet 16mm, by Samuel H. Gould, Chicago, Ill.

California's Southland, 750 feet 16mm, by Mildred Greene, Long Beach, Calif.

Christmas 1939, 400 feet 16mm, by J. B. Headley, Roswell, New Mex.

El Lobo, 400 feet 16mm, by Demetris Emanuel, Los Angeles, Calif.

Flaming Canyons, 300 feet 16mm, by Charles and Robert Coles, New York City.

From A to Z, 400 feet 16mm, by Vernon Altree, Stockton, Calif.

• Continued on next page



1st AWARD

Family Films Class,
Home Movies 1940
Amateur Contest
Awarded to J. Allyn
Thatcher, D.D.S.,
for his picture . . .

"CHRISTMAS WELL SPENT"



Staff of Life, 700 feet 8mm, by Jack L. Krapp, Cleveland, Ohio.

Tally-Ho, 400 feet 16mm, by A. L. O. Rasch, Philadelphia, Pa.

The Thirty-Niners, 200 feet 8mm, by Al Morton, Salt Lake City, Utah.

Whistling Wings, 350 feet 16mm, by W. H. Nordin, Austin, Minn.

Achievement Awards

For Photography: To Dr. R. E. Gerstenkorn, Beverly Hills, Calif., for his 400 foot 16mm picture, "The Cauldron."

For Editing: To A. O. Jensen, Seattle, Wash., for his 300 foot 8mm picture, "Driftwood."

For Titling: To Clarence A. Aldrich, Long Beach, Calif., for his 400 foot 16mm picture, "Susanna."

For Sound: To Dan Billman, Jr., Minneapolis, Minn., for his 1200 foot 16mm picture, "Black Cousins."

For Technical Achievement: To Edmund Turner, Detroit, Mich., for his 400 foot 16mm Animated Cartoon, "Peetie."

For Outstanding Club Achievement: To the Peoria Cinema Club, Inc.

THE Lloyd Bacon Trophy goes to a film that definitely establishes a new trend in amateur movie making — "Angels Are Made of Wood" — outstanding entry in the Scenario Class. It is a phantasy, delightful as it is unique. In planning this picture, Herman Bartel sought to tell a story through the medium of subtle pantomime. There are no descriptive titles. And none are needed. Clever camera angles, an abundance of closeups, and well-planned lighting concentrate attention in such a manner as to make the story as readily understandable as though filmed with sound.

"Angels Are Made of Wood" is a story of a commercial artist, temporarily frustrated in an attempt to execute a rush order for advertising illustrations. After many efforts, inspiration fails him. He retires in disgust, seeking solace in a bottle of rum.

While he sleeps, "Dodo," the wooden manikin on his desk suddenly comes to life. Summoning brushes, paper, and water-colors, which assemble mysteriously before him, "Dodo" completes the set of illustrations, then returns to a state of immobility on the desk. When the artist arises the next morning, he is as joyful as he is surprised upon finding the illustrations completed. Grateful, the artist rewards "Dodo" with a paternal hug, and a bottle of beer.

The manikin sequence, of course, was done in stop-motion photography. But this is no ordinary effort in animation. It is probably the finest amateur accomplishment of its kind to come to attention thus far. Timing of each movement is perfect — nothing haphazard; no jerky action — indicating that considerable study and calculation were devoted to its execution.

And if there were any awards in this contest for acting achievement, one of them most certainly would go to Harry Etchell, cast as the artist

Genesis, 75 feet 8mm, by Harry A. Downard, Jr., Sacramento, Calif.

Heart Trouble, 400 feet 8mm, by Harold Witt, Santa Ana, Calif.

It May Happen to You! 200 feet 8mm, by Wm. Wade, Los Angeles, Calif.

Jello Again! 150 feet 16mm, by Carl Anderson, Los Angeles, Calif.

Mexican Silhouette, 1000 feet 16mm, by Clement K. Chase, Tucson, Ariz.

Miracle of Spring 200 feet 16mm, by Wm. F. Small, Newburgh, New York.

Pioneer Daze, 575 feet 16mm, by John Phillips, Winnipeg, Canada.

Rats In Spats, 800 feet 16mm, by Irvan L. Spence, Los Angeles, Calif.

Rubout of Dan McGrew, 300 feet 8mm, by John W. Talbot, Huntington Park, Calif.

Slab Happy, 400 feet 16mm, by Werner Henze, St. Louis, Mo.

Snow White and the Seven Dwarfs, 150 ft. 8mm, by Albert Watts, Buffalo, New York.

● Below are pictured scenes from prize winning films in the Family Films Class: Left to right — "Christmas Capers," third award; "Checking Off the Budget," second award; and "Cat Tales," fourth award.

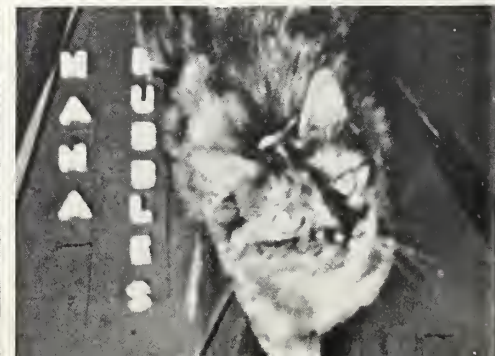

in this picture. His fine performance contributes much to its success.

Added drama was injected in the animated sequence by clever use of colored lighting played upon the manikin; the lifelike poses and action portrayed by it; plus highly commendable cutting.

MISSING first place in the Scenario Class by an eyelash, is Chester Glassley's "Will and the Way" — extremely well photographed, enacted, and edited. The story concerns a young couple who, as Winchell would say, are "blessed eventing." The young wife, accompanied by her husband, visits the doctor for an examination. The doctor, something of a drunkard, proves extremely annoying to the young wife and she flees from his office in tears, declaring she will not have him for her doctor. Subsequently the couple read of a noted obstetrician arriving in the city and famous for his "\$1000 per baby fee." The husband assures his wife that if she wants this doctor to attend her, he'll scrape up the money somehow.

He enters one contest after another — newspaper, pie eating, motorcycle hill climbing, and eventually a boxing contest. In time he accumulates \$300.00 which he offers as an advance payment to the noted obstetrician, who has kindly agreed to bring the baby.

The baby is born, and the doctor, taking a liking to the struggling young couple, returns the \$300 as a gift for the baby.

This picture is notable for its original story, excellent photography, editing, and titling, and by no means least — the acting ability of every member of its cast.

Glassley had an entry in last year's contest and barely missed out in the finals. This year he came back again and with a determination worthy of the success he has achieved. "I'm back again this year for a try at one of the major prizes," he wrote in a letter which accompanied his film. "I've put everything I've got in another original yarn. In preparing my script, I resolved to stick to medium shots and close-ups. Practically every scene is filmed at a distance of fifteen feet or less." Glassley, too, had a will and the way.

THIRD place in the Scenario Class was captured by "Diary," produced by Harold Remier, for whom making good movies is a habit, and whose fine picture, "Souvenir," was the Movie of the Month for December, 1939. "Diary" portrays some of the glamour of the period between 1860 and 1890 and is particularly notable for its authentic costumes and the painstaking care Remier followed in obtaining settings and locales corresponding to that period.

A woman grown old, reads from a frayed old diary, and we see enacted scenes of her life during Civil War days. After the war, she marries, and together with her husband, moves to the West. In Colorado, her husband discovers a rich vein of silver, becomes wealthy and subsequently interested in another woman. There is a parting, followed by a panic in the silver market, bankruptcy for the husband, and eventually reconciliation.

Incomparable photography and camera technique, good editing and titling, and a deft handling of cast, mark this picture definitely as one of the best of the year. Commendable, too, is the musical score of recordings selected by Remier for this picture.

IMPRESSIVE indeed was the ambitious entry of the Rockville Cinema Club, "Press Time," running 1250 feet in length, and receiving

fourth award in the Scenario Class. Aply photographed by Harry S. Smith, "Press Time" is a yarn about a newspaper reporter whose sleuthing abilities lead to the capture of a band of notorious crooks. At the same time it provides a very complete and interesting account of how a great daily newspaper is edited, published, and distributed. This picture is well acted, directed, and photographed with titling and editing highly commendable.

IN the Documentary Class, the First Award went to Dr. Richard L. Cassell's noteworthy picture "Humming Bird," which many readers will remember was reviewed at length as the Movie of the Month for October, 1939.

Only those privileged to review this film could appreciate the infinite patience and perseverance that was necessary in its filming. A humming bird when full grown is a small object indeed, but Dr. Cassell brings them right up close in this picture—closer than we might ever get to them otherwise. The picture is a complete study of Humming Birds from nesting to rearing of the young, and is a fitting record highly recommended for educational use.

SECOND place winner in the Documentary Class went to "St. Margarets," also a Movie of the Month, and reviewed in the August, 1940, issue of HOME MOVIES. A masterpiece in color cinematography, this picture is one of the most vivid documents of skiing ever reviewed by this publication. It is notable for the obvious care in which camera angles and settings were chosen by the filmer; the manner in which the camera follows the skiers in flight; and the fine tight continuity in which it was edited and deftly tied together with descriptive titles formed by inserts of a letter addressed to a friend.

NO better example of a complete amateur-produced movie will be seen for a long time than "Romance of the River," filmed by Tom Swaja, and awarded third prize in the Documentary Class. Photographed entirely on positive film, it was processed, toned and tinted by Swaja. He also hand-lettered all of the titles and photographed and developed them. In fact, he made everything but the film.

"Romance of the River" is a brief history of a river. Describing its origin, it depicts a stream from midwinter throughout the seasons and returning again to its frozen state in December. There are many beautiful shots throughout this picture and fades and dissolves are judiciously used to emphasize transitions in time and action.

ANOTHER Movie of the Month came back for a second curtain bow in this contest — "Song of the Soil" — described in the July issue of HOME MOV-

• Continued on Page 440



• Above: Handsome trophy awarded in this contest for outstanding achievement in the following: Photography, Editing, Titling, Sound, and Technical Accomplishment. Below: Trophy awarded Peorio Cinema Club for outstanding club achievement.



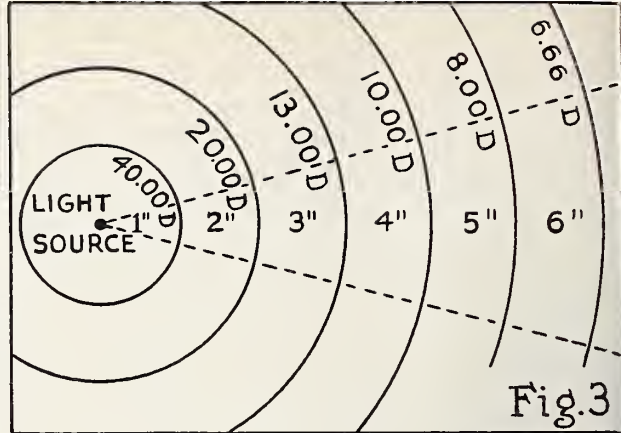
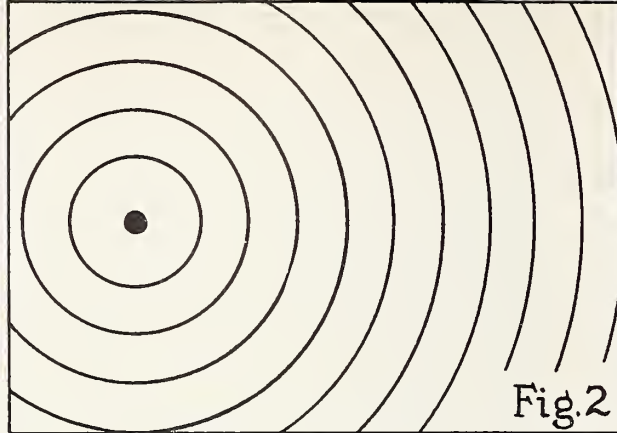
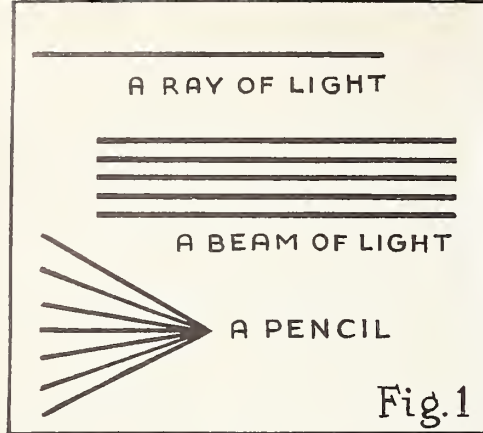

LIGHT and LENSES in cine photography...

Authored by
DR. A. K.
BAUMGARDNER

THIS is the first lecture of the School of Cinematography, an enterprise of the Peoria Cinema Club instituted for the purpose of bringing the new members up to the level of the more advanced amateurs, as described in HOME MOVIES last month. It is necessarily very elementary in nature and may not appeal to the advanced amateur, but for that vast number of new owners of cine equipment who may be eager to learn the fundamentals, it serves as an important stepping stone to better cine work.

If we are to learn how to control light, it is quite important that we become familiar with its properties, noting along the way what we can do with it and what we cannot do, analyzing the media through which it passes and studying the methods by which we can alter that light to produce the effects most desirable for our purpose. Light is that force which is capable of exciting a stimulation upon the retina of the eye to produce what we know as vision. Photographically, we substitute a sensitive emulsion for the retina and record permanently that impulse of light. We must think in terms of light, regarding any object which we attempt to photograph. The subject is rendered visible by its ability to reflect or absorb light which is thrown upon it, light colored portions reflecting and dark colored portions absorbing. It is this reflected light, in its various tones of density which reach the camera and from that point must be controlled to produce a picture.

Light travels in one of three forms, viz., Beams, Rays or Pencils. A ray of light is the smallest conceivable portion or imaginary line. A beam is a collection or bundle of parallel rays. A pencil is a

collection or bundle of converging or diverging rays. (See Fig. 1.)

Inasmuch as we are not always dealing with parallel rays of light, but more frequently with pencils, we must compute the values of those pencils systematically to bring them to a focus. For this purpose, we refer to the "Wave Theory" which is an optical law. It is well to draw somewhat on one's imagination to create a perfect understanding of the Wave Theory. If we throw a pebble into a pool of water, circular waves are thrown in all directions. The wave nearest the pebble has the shortest radius of curvature or the greatest strength of curvature. Each wave outside of this, decreases because of a longer radius until it travels so far that it has practically no curvature at all.

When this wave travels so far that its curvature is so slight that it can only be computed by fine mathematics, we consider it as a plane wave. This point would indicate infinity, considering the pebble as a light source. (See Fig. 2.) In elementary optics, we usually use a lighted candle to indicate the source of light and compute the value of the wave by the distance it travels.

THUS, when the wave has traveled 1 inch it is said to have a wave value of 40 dioptries. When it has traveled 2 inches it has a value of 20 dioptries; 3 inches away it equals 13 D; 4 inches away, 10 D., and so on. The distance divided into 40 produces the dioptric value of the light wave, based upon the radius of curvature (see Fig. 3). It may be well here to review the definition of a dioptry,

• "If we are to learn how to control light, it is important we become familiar with its properties. Light travels in one of three forms: Beams, Rays, or Pencils."

• Continued on Page 442

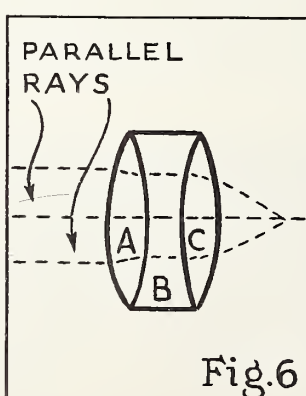
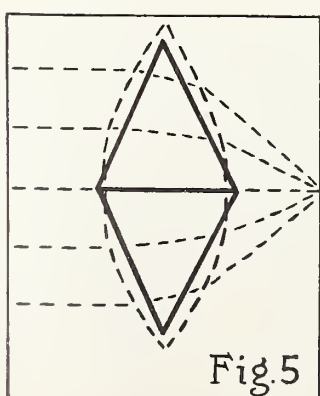
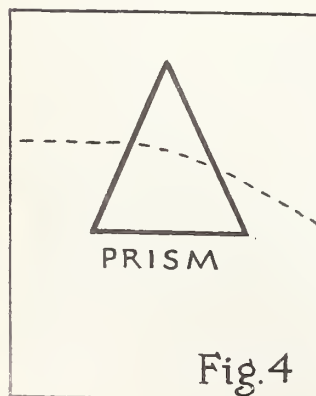

(Right)

LAKESIDE

Possessing all the elements of a well composed picture, this photo also makes a particularly pleasing background for home movie titles.

Photo by F. Levi





Fig. 1

wards when the back-wind is operated.

Most of the parts can be secured from Eastman Kodak Company, 343 State Street, Rochester, New York, or through any one of their dealers. The parts and prices are as follows:

Winding Handle Complete, part No. 40224
(Shown in sketch III as "B")..... \$2.00
Winding Handle Knob Stud, part No.
25929. (Shown in sketch III as "A").. \$.35
Winding Handle Knob Cell Assembly,
part No. 41056..... \$.20
Three No. 0-80 screws for above cell..... \$.10

After obtaining the above, the next step is to secure the following pieces of round brass rod,

Home-made WIND-BACK for le

Authored by
W. C. KANE

THE author wanted to make lap dissolves on 16mm film. He had a model "K" Cine-Kodak, but lacked the wherewithal to purchase a Cine-Kodak Special or other camera with the wind-back feature.

This simple adaptation of the model "K" resulted. Although the film is not rewound on the supply reel but loops back into the camera, as shown in Fig. 5, it has worked perfectly for wind-backs up to three feet, which is more than ample for lap dissolves and many trick effects of double exposure. It would not be difficult to remodel the camera further to take up the wound-back film onto the supply reel. In fact, this was part of the original plan, but the simpler arrangement works so well that the author is going to take his time in

working out a simple clutch connecting the supply and take-up reels.

A disengaging device for the intermittent claw is not necessary, as the wind-back handle operates directly off the center sprocket of the camera mechanism. Thus the claw works the same in reverse as in forward movement, pushing the film back-

for which the cost will be about 15 cents:

$\frac{3}{4}$ inch diameter, 2 inches long.

$\frac{1}{8}$ inch diameter, 2 inches long.

If one has a small lathe he can do the necessary machine work himself. If not, any machinist will do the work on the $\frac{3}{4}$ -inch round rod for about 75 cents. Chuck the $\frac{3}{4}$ -inch round rod in a lathe; drill the exact center and tap with an 8-32 tap; turn down the outside diameter of the rod to $\frac{11}{16}$ inch; face the end square; and cut off a disc $\frac{1}{8}$ inch thick. While you are at it, cut off two or three discs $\frac{1}{8}$ inch in thickness, just in case you make a mistake later on. Take one of these discs and drill two $\frac{1}{8}$ -inch holes as shown in Fig 3 (part "F").

Now, remove the cover of the model "K" and using this disc as a template, centered on the film sprocket, mark the location of the $\frac{1}{8}$ -inch holes on the top of the sprocket. Drill two $\frac{5}{32}$ -inch holes, $\frac{3}{16}$ -inch deep, in the top of the sprocket where marked. These holes will take the pins of the drive disc "F", shown in Fig. 3, which will be described next.

CUT two $\frac{3}{8}$ -inch lengths of the $\frac{1}{8}$ -inch round brass rod and sweat with solder into the $\frac{1}{8}$ -inch holes in the brass disc, "G", having the ends of the rods flush with the face of the disc on one side. Round off with a file, the protruding ends of the pins. Sandpaper smooth and clean, the flat surface of the disc where the pins are flush.

Make a template of heavy paper, as shown in Fig. 2, cutting it accurately on the outside lines. Place this template on the inside of the model "K" cover and slide it up to the front of the cover so

Fig. 2

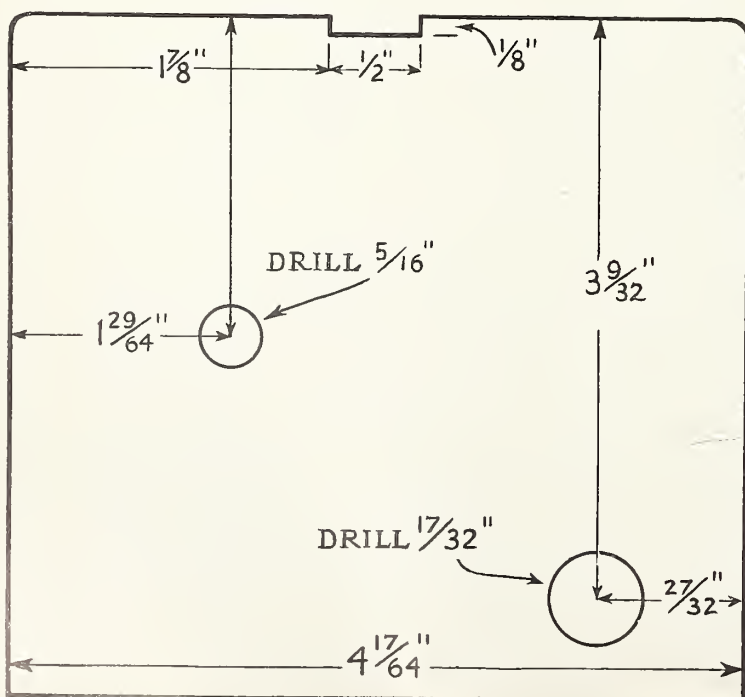

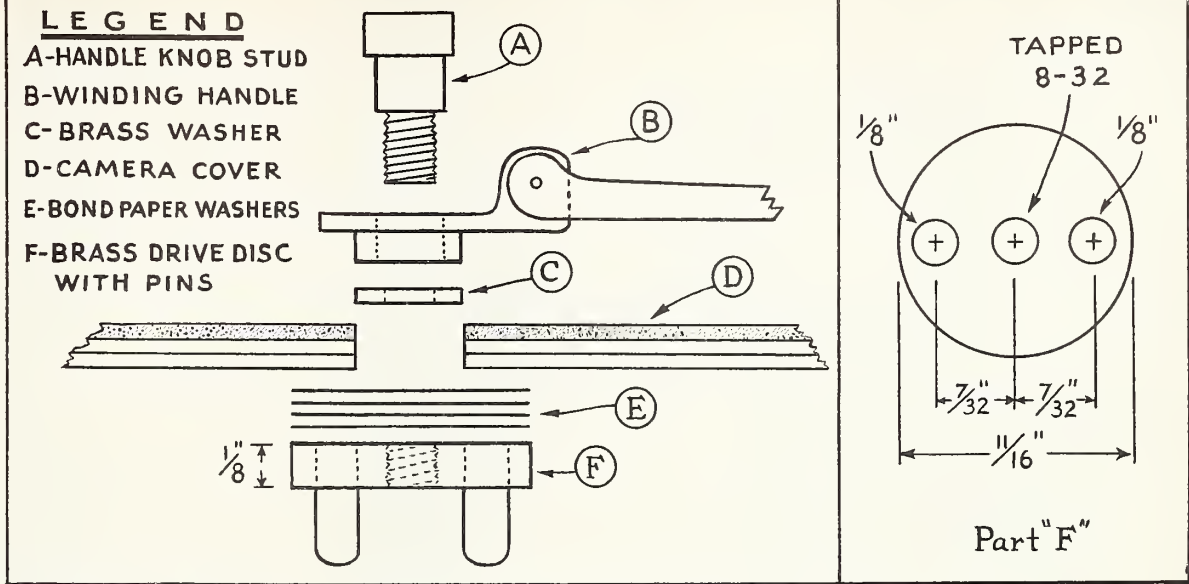

Fig. 3

that it is snug. With a centerpunch, mark through the paper the centers of the two holes to be drilled.

Using a 1/8-inch drill, drill through the cover where the 5/16-inch hole is indicated. Replace the cover on the camera and check to see that the hole comes exactly over the center of the film sprocket. If it is off center slightly, remove the cover and use a small round file to center the hole exactly, then drill out to 5/16". Wrap fine sandpaper around a 1/4" drill or round stick and slightly enlarge this hole until the round part of the winding handle, as shown in Fig.

the end of the coil spring off the winding handle so that there is no spring action.

The wind-back, as shown in Fig. 1, is now ready for use in making fades or dissolves. To determine footage consumed in making a fade, fold the wind-back handle onto the stud (in regular winding position) and count the revolutions of the handle as the scene is taken. One complete revolution represents eight frames of film exposed.

In order to wind back the film, leave the handle in the same position over the stud. Hold the wind-back crank securely, then press on the camera release button and wind back the same number of revolutions as were counted in making the fade. It is necessary to press the camera release button in order to free the internal mechanism so the wind-back handle will turn.

USE of this wind-back is limited only when the camera spring is completely wound. If an attempt is made to wind back the film when the motor spring is wound tight, the mechanism will not turn. And to force it might damage the camera motor. Bear in mind therefore not to wind the motor spring completely prior to winding back the film after a fade.

While some amateurs may wish to use a winding knob for this wind-back instead of the crank assembly suggested here, the crank makes for a much neater and more practical job, folding back neatly against the camera case when not in use. This thought is passed along for those owners of the model "K" who also have a carrying case for this camera; for a wind-back knob, if too large, would render the carrying case unusable unless the knob was demountable.

• By studying the illustrations presented here, owners of model "K" Cine-Kodaks may easily install a simple and inexpensive wind-back for turning back film in making wipe-offs or dissolves.

an five dollars....

3, fits well but does not bind in the hole.

Use a 17/32" drill for the other hole to be drilled in the cover, and if necessary enlarge this hole with a round file until the winding handle knob cell fits snugly. With a razor blade or sharp pen knife mark the outline of the cell flange on the cover leather. Cut through and remove this circle of leather so that the flange fits down on the aluminum of the cover. Mark the places for the three flange screws so that the spring in the cell is toward the 5/16" hole. Drill these screw holes with a 3/64" drill and tap with a No. 0.80 tap. Fasten the cell in place with the three screws.

THE wind-back is now ready to assemble, as shown in Fig. 3. Part "C" is a brass washer for No. 6-32 screw, drilled out with a 5/32" drill. Parts "F" are bond paper washers soaked in lubricating oil, 11/16" outside diameter, 5/16" inside diameter. These can be cut out of paper with a sharp knife. Use as many as necessary to secure a good fit without binding. After assembly, slip

Fig. 4

Fig. 5

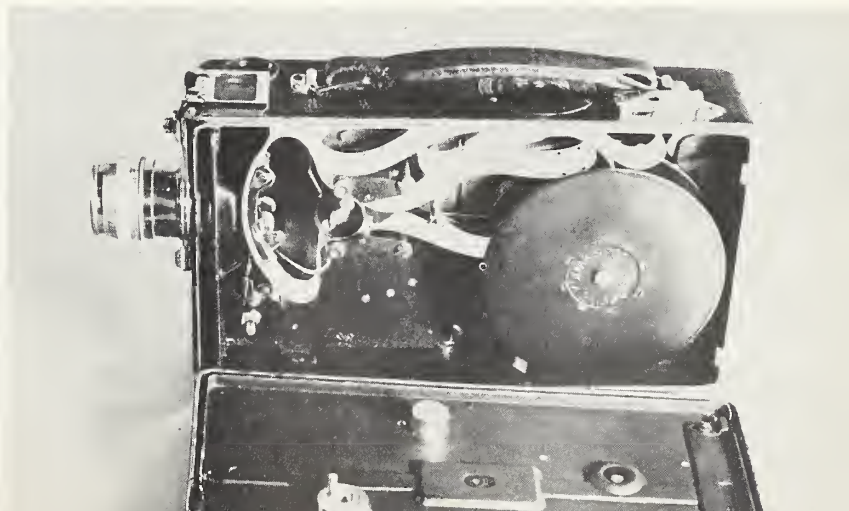
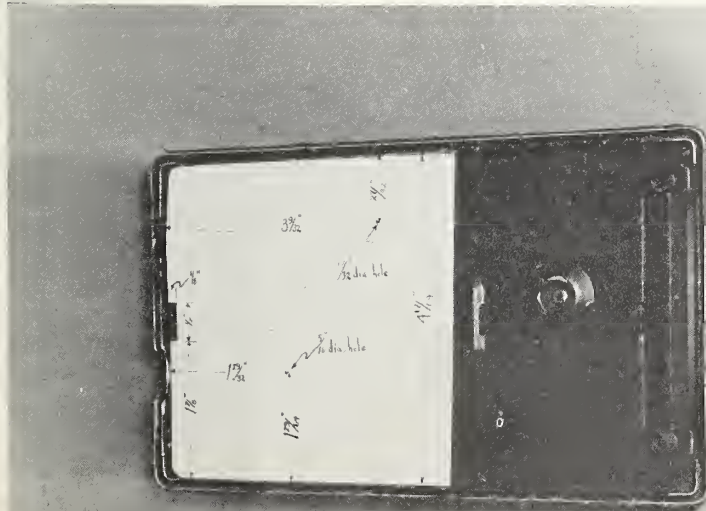

Authored by
WALTER W. LIGHT

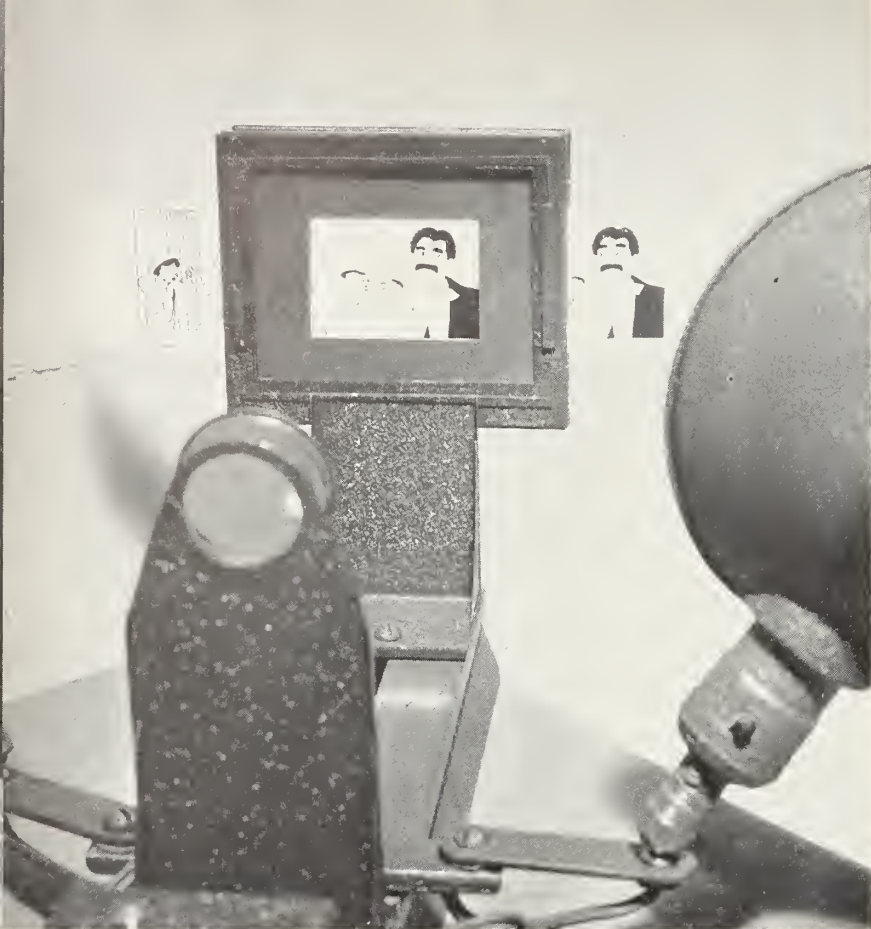

Film this simple

ANIMATED CARTOON...!

THIS month HOME MOVIES presents a new idea in animated cartooning for the home movie fan. With the aid of only a movie camera and a titler, a complete animated cartoon film can be made from the cartoons on the opposite page and those which will be presented in the next two issues of HOME MOVIES. If photographed in a typewriter titler according to instructions, an interesting 4 to 5 minute film should result from the complete series of cartoons. The story is complete with titles and no editing should be necessary on the finished film. For simplicity, all action has been reduced to fundamentals.

It will be noted that all cartoons are reproduced without shading. Shading is not necessary but can be filled in with a soft pencil or gray watercolors if desired. It can also be colored for use with Kodachrome. Practice on other illustrations in this magazine with colored crayon pencils, etc., until smooth, even colors can be obtained. For a black and white version, low-cost positive film is best, although any type of film is satisfactory if properly exposed and processed. If film is to be home processed, aim for contrast in both negative and print.

Those who do not have a printer for the negative-positive method, or have experience with direct-positive processing, may use the following method:

Copy the cartoons with a fairly large still cam-

era on process or any slow, ortho type film so as to get transparent negatives of the illustrations the size required for your titler. Place these in the titler and use an even light source some distance behind the cartoons. The exposed 8mm or 16mm film can then be developed the same as an ordinary title, using only developer, hypo and water, and the result is a positive film image ready for projection! To save the cost of process film, use enlarging or any smooth finish sensitive paper in the still camera for paper negatives (cover up the red window with tape). Put these in the titler and photograph on movie film as above, but with the light source in normal position.

If desired, the titles may be photographed and developed separately and inserted later. Put a fade-in at the beginning of the first title and a fade-out at the end of the last one. However, the titles can be animated along with the cartoons by finding the number of seconds required to read

each one slowly and multiplying by 16. Exposures would vary too much if the titles were taken at normal movie speed and the cartoons exposed by single frames all on the same roll—unless one remembers to change the aperture the proper amount each time (usually one stop). Black album paper can be drawn across in front of, and in contact with, the titles in various directions for wipe-off effects to take the place of a fade. (If animated, move the album paper not over 1/16 inch and expose two frames in each position.)

Now for the cartoon instructions.

THE cartoons and titles have been reproduced for average titlers. If too small, copy and enlarge them. If too large, draw new guide lines accurately on each cartoon and title the size of the opening in your titler. Also, if needed, masks can be cut from album paper and fastened to the titler card holder with scotch tape. This will mask out any excess space at the edges and also give new guide lines for centering.

Cut the cartoons in horizontal strips—then glue them into one long strip. They can be moved back and forth in the titler this way instead of changing each one separately. Each cartoon must be centered and straight or the pictures will jump around on the screen. Use the lines around the

• Above: Showing method of filming illustrations on opposite page by means of small typewriter titler. Full instructions for photographing each sketch are contained in this article.

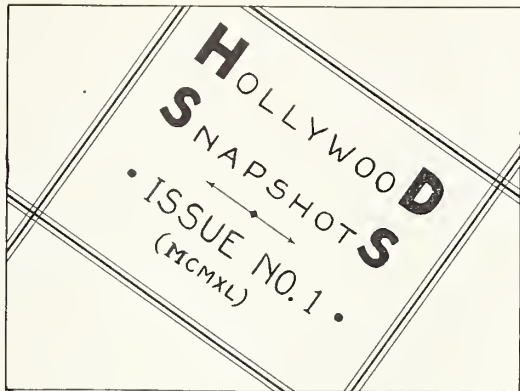
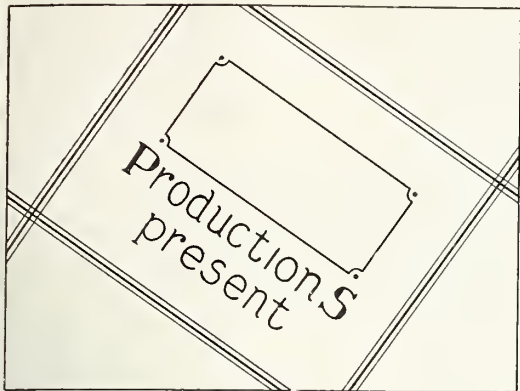

Scenes of favorite movie stars at work and at play . . .

On Hollywood Boulevard our cameraman sees two of the screen's greatest lovers . . .

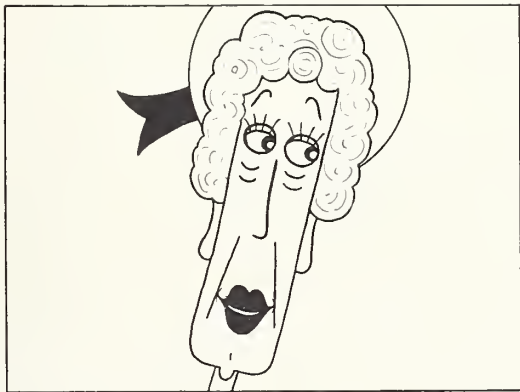
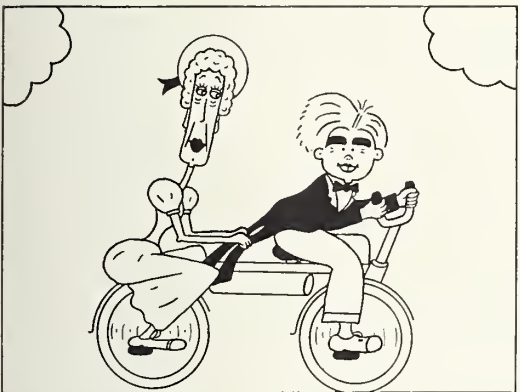
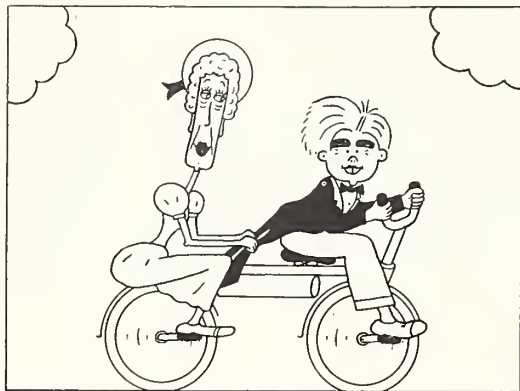
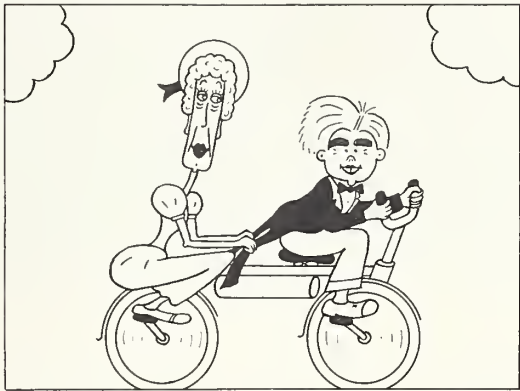

Presenting those famous musicians . . .

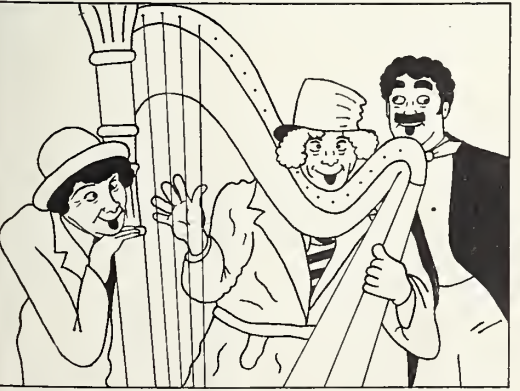

TITLE CENTERING GUIDES

PUBLISHED this month are the remaining two title centering guides of the Filmo series, and the first — and probably the most important — of the Keystone series, that for the Keystone “8”. These guides are especially drawn to fit the average typewriter titler and may be used in conjunction with the Title Backgrounds, published each month in HOME MOVIES, as a means of accurately centering same.

To use with typewriter titlers, insert guide in card holder, line up title area within opening of card holder. Then, sighting through viewfinder, line up camera with viewfinder area and lock in position.

To shoot titles without a titler, place centering guide on wall and, with camera mounted on tripod, line up camera with viewfinder area and lock in place. Title card is placed over “title area.”

To convert guide for larger title cards, lay guide on a large sheet of paper and expand each rectangle to required size, using the “center” point in each square as a basis to work from.

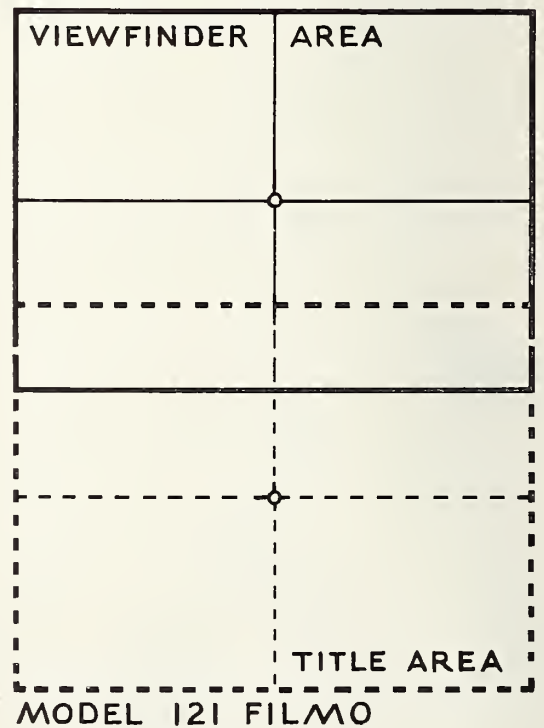
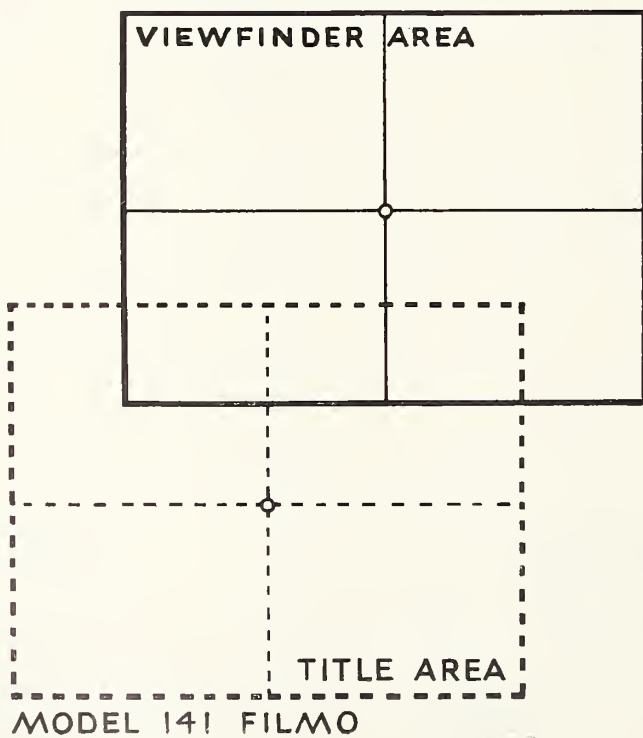
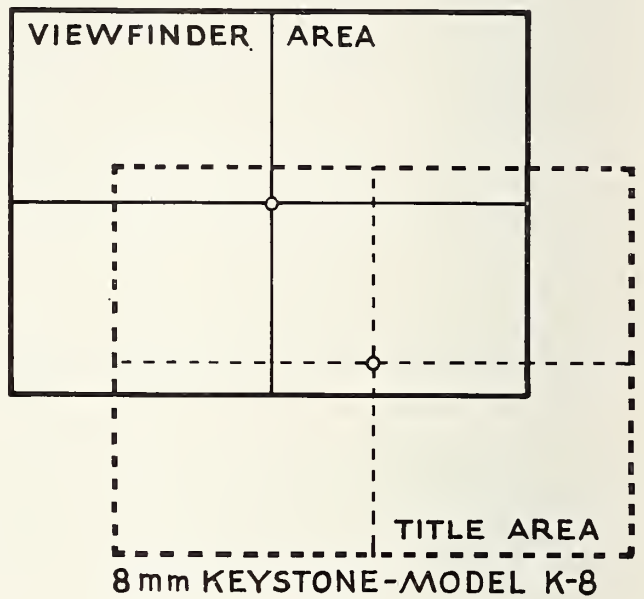

Authored by
H. W. McCONNELL

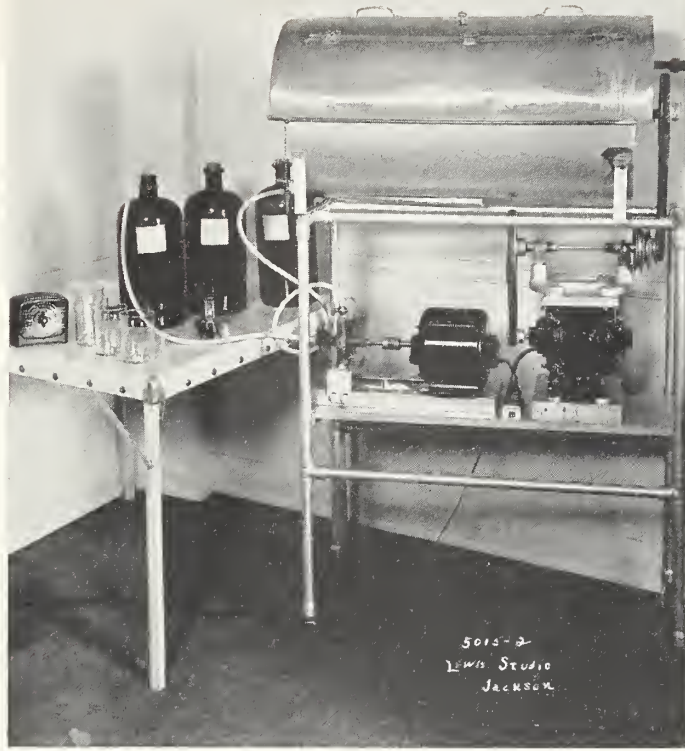

FIG. 1.

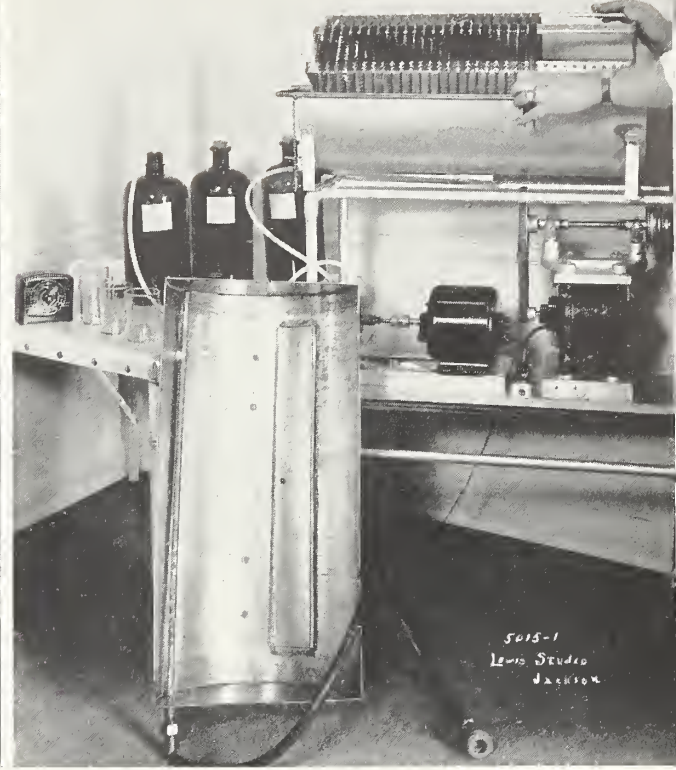

FIG. 2.

Pro results with amateur equipment in

HOME PROCESSING

HOME processing of amateur movies has been the subject of much discussion over a period of years. Lately, however, it has taken on added importance and an increasingly large number of amateurs have expressed their desire to enter this fascinating branch of movie-making. Many formulas have been offered and varying types, shapes and sizes of equipment—some constructed of wood, others of metal—have been advocated as best for the particular job on hand. Each innovation offered has, to some extent, improved the chances of the amateur processor to improve his technique and to add a little more professional touch to his work. There is still room for great improvement.

This opinion is based on experience gained through several years of intensive search for the best methods of home processing. I had experimented with first one type of equipment and then another and had thoroughly investigated each new "discovery" as presented to the amateur over a period of three or four years. Still not being satisfied with the results obtained, I decided to do a little experimenting on my own behalf. The goal was to build equipment that would handle one hundred feet of 16mm film and produce a more professional-like job while still expressing a little individuality.

The result was the elaborate all-metal home processing outfit you see pictured here. Obviously the better the equipment, the higher quality processing will be obtained. Although the illustrations are practically self-explanatory, further description here may make for more clarity. The tubular stand makes for portability of the unit and I can move it into the kitchen or bathroom for a few hours' work and back to the store-room with very little trouble.

Of primary importance is construction of the tank and drum, both of which are made of stain-

less steel. Inside diameter of the tank is 26½" x 13½" x 6½". The cover measures 29" x 14" x 8". The hinged window on the cover measures 25" x 3". At the bottom of the left end of tank is an opening for draining the solutions. This may be fitted with an ordinary cork, or with a small pet cock where a centrifugal pump is to be used for filling and emptying the tank. This latter feature is a luxury, of course, and not essential to efficient operation of the apparatus.

However, while we're talking about it, we might as well describe this feature more fully. The centrifugal pump is operated by a separate motor, working independently of the rest of the mechanism as may be seen in Fig. 1. Tubes connect pump with the tank and the solution supply. To fill the tank with one of the solutions the tubes are connected as shown, the motor started, and in a jiffy the liquid is transferred from the bottle to the tank. To return solution to the bottle, the tubes are merely reversed at the connections on the pump and the pump started again. Without this mechanical feature, the solutions are changed in the usual manner—gravity for emptying, and the old "heave-ho" method of pouring it in the tank as needed.

Around the edge of the tank is a narrow ledge or lip so constructed to permit cover to fit tightly over it and thus keep out the light during that period of the processing.

The processing drum is 25 inches long.

• Photos above show well designed home processing equipment that may easily be built by any amateur. Below is suggested form for keeping record of processing and formula tests.

FIG. 3.

#1 TEST STRIP	#2 TEST STRIP	#3 TEST STRIP	#4 TEST STRIP
TIME - 6 MINUTES	TIME - 5 MINUTES	TIME - 4 MINUTES	TIME - 3 MINUTES
TEMP. _____	FORMULA _____		
TEMP. _____			
RESULTS _____			
SCALE OF FILM _____			
SOLUTION BATHING _____			
POSTAGE _____			
REMARKS _____			

• Continued on Page 46

Reviews by
THE EDITORS

TELL ME — how can I improve my film?

AMONG the hundreds of films submitted in HOME MOVIES 1940 Amateur Contest were many that gave the final winners a close run for honors. Many that were edged out in close "photo-finishes" were good pictures, lacking perhaps adequate titling or editing, or were deficient from point of photography. Every film was carefully reviewed by the editors and then returned to its producer together with a written analytical criticism.

During the next few months, some of the most important of these reviews will be published for what valuable information they may contain for other amateurs. The reviews selected for this month are as follows:

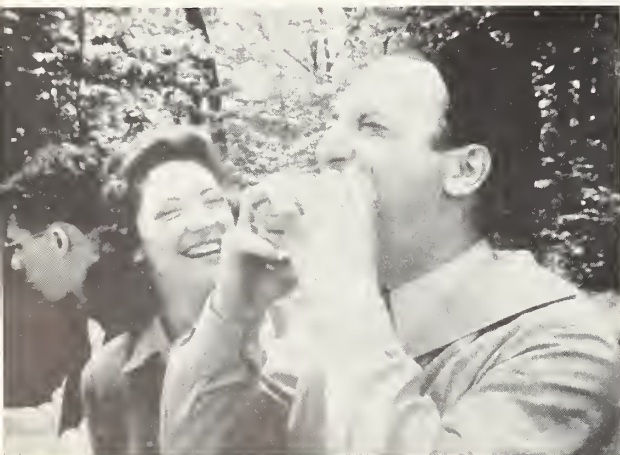

"FLOPS OF '40"

★★★

350 ft. 16mm Kodachrome
By W. J. V'B., Mass.

Continuity: This picture is a record of a skiing expedition in the New England States. It opens with a skier or two zooming into the picture and out again. Then a closeup of the title of the film written in the snow. There follows a number of shots of the group loading their automobile with skiing equipment several shots

shots taken along the way, and then the arrival at the scene of the ski meet.

From here on there is a series of shots of people skiing; some of the group being drawn up-hill by the ski-tow; and then more scenes of the skiers whizzing along ski trails after leaving the mountain top.

Editing: Is very good with regard to length of scenes. There are many closeups of skiing feet, some beautiful long shots. The shots are varied to hold interest. However, with the splendid material at hand, it would be possible — with some rearrangement of scenes — to obtain greater continuity in the picture as a whole.

Photography: With the exception of one or two slightly over-exposed scenes, photography is excellent — some of the most picturesque ski-shots ever to come to the attention of the reviewers. The camera following of the skiers as they whizzed along the snow-covered mountain trails is a fine piece of work — a task rather difficult considering the rapid movement of the skiers. But this cine-filmer kept them right in the center of his viewfinder all the time. Exposure and focusing is exceptionally good.

Titling: Additional titling would give this picture more continuity — tie it together more to make a continuous story. Remarks about the people skiing would have helped to make an audience feel acquainted with the skiers and cause it to take a greater interest in the picture.

Equipment: Keystone A-7 camera, Albert-Royal tripod, Kodachrome film, and blue-base film for titles.

"PICNIC DAZE"

★★★

350 ft. 16mm — By G. B., Pennsylvania.

Continuity: This picture, produced and enacted by members of a cine club, is a story of an artist invited to attend a picnic. The story opens amid a good deal of slap-stick comedy of himself and a girl bumping heads. He drops his equipment and there is some confusion about him getting settled in the rumble seat of the car, and when he does, all of the picnic paraphernalia and lunches are piled on top of him. He's the "goat" of the outing. It is he that pays the entrance fees to the picnic grounds, etc.

This phase was rather difficult to co-ordinate with the balance of the picture. Thereafter, the picture increases in interest and story value. An interesting sequence is when the artist is busily sketching and a lot of kibitzers stop to interrupt

• Above — Enlargement from scene of "Flops of '40," 16mm Kodachrome ski picture. Left — Scenes from "Picnic Daze" and "Song of Autumn."

• Continued on Page 445

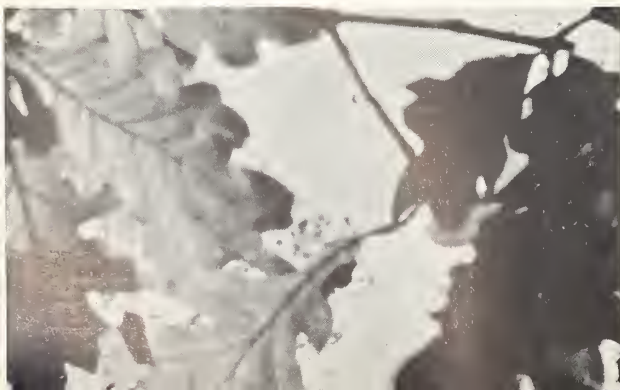

Authored by
ARTHUR H. HART

WE continue this month with details for machining and assembling the crank gear case for the "Glorified 16," and advance a step further to the construction of the effects gear box. This latter unit is joined in the crank gear case by means of a shaft and set of bevel gears as shown in Fig. 11 below.

Obtain one pair of No. G-462 Boston brass bevel gears. Trim off 0.063 inch from the bearing face of each as shown in Fig. 8, then bore out the hole in one of the gears to 15/64ths of an inch and finish cut with a 1/4-inch reamer. The other gear is left its original diameter of 3/16th of an inch.

Looking into the gear sump from the rear it will

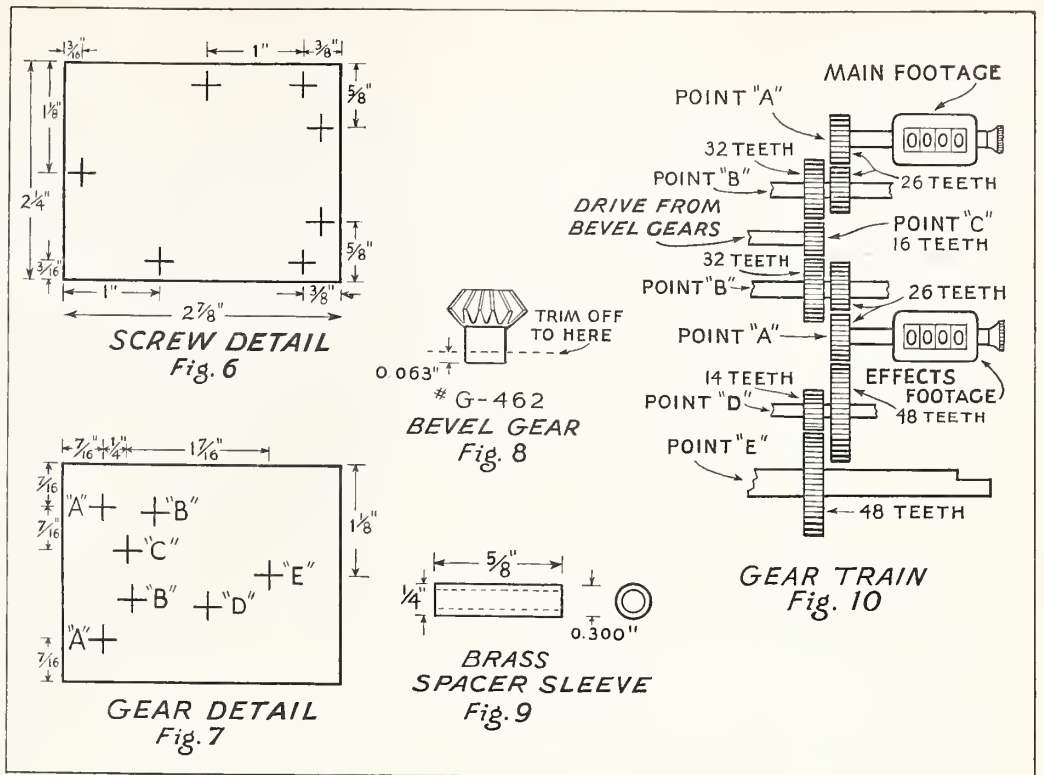

Here are details of gear box for the "GLORIFIED 16"

be noted that the forward wall of the crank gear case slants away the deeper it goes down. To present a good back bearing for the front bevel gear, it is necessary that a portion of this wall be milled flat so that it will be 90 degrees to the 3/16-inch hole coming through from the front.

To accomplish this, a small flat-faced end miller with a 3/16-inch hole through it is used. This miller should be about 0.425 inches in diameter and about 1/2 inch long and have a set screw in it so that it may be fastened when placed on a shaft.

Place a short length of 3/16-inch rod through the hole in the front of the crank gear housing and slide the miller on the shaft tightening the set screw. The projecting shaft can then be placed in a drill-press and rotated while the housing is held in the hand. Milling of the bearing face is about right when a full face shows.

Trial of placing the bevel gears in position will be a close indication of whether or not the depth is correct. Next a spacer sleeve is made of brass. Dimensions are as follows: Length, 5/8 inch, inside bore, 1/4 inch, and outside diameter 0.300 inch. (See Fig. 9.) This spacer sleeve serves to keep the bevel gear on the crank gear shaft from meshing too deep with the gear on the forward shaft.

The bevel gears, if all dimensions have been fol-

lowed correctly, will fit either for right or left hand rotation of the forward shaft. However, assembly should be made so that the bevel gear on the crank shaft is on the left, or closest to crank shaft drive gear. Fig. 11 shows the assembled bevel gears in the crank gear housing.

Attention is now turned to construction of the housing for the effects gear, to be attached just under the lens mount. This housing measures 2 7/8 inches long, 2 1/4 inches high, and 5/8 inch thick, and is made up of three pieces: two steel plates 1/16 inch thick each and an aluminum spacer 1/2 inch thick. In cutting these plates and spacer to size, it will be well to allow from 1/16 inch to 1/8 inch larger in dimensions so that when the plates are screwed to the spacer, the whole assembly can be turned and squared up.

Fig. 6 shows dimensions for laying out the screw holes. After laying out, clamp the two plates together and drill the holes with a No. 43 drill.

• Continued on Page 444

• This is the third installment of Arthur Hart's account of building a "Glorified 16," wherein he treats in detail the construction of the gear box for controlling the dissolve and wipe-off effects devices. Pictured below is the crank-gear case with shaft and gears added for turning the gear box; and at the left, all the parts ready to assemble the gear box.

Fig. 12

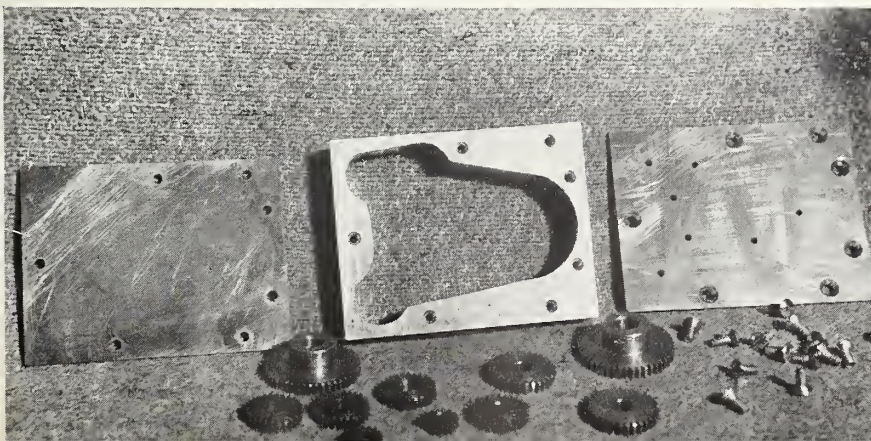
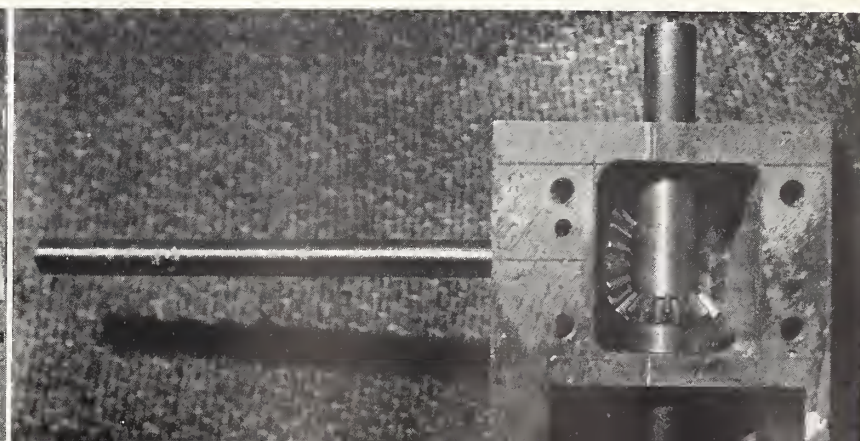
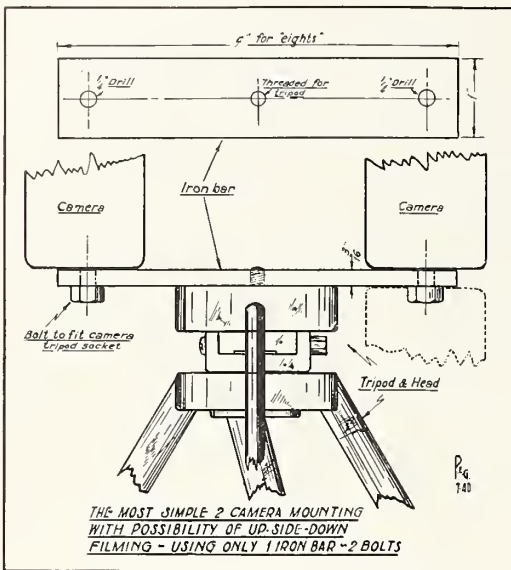

Fig. 11



THE EXPERIMENTAL



THE MOST SIMPLE 2 CAMERA MOUNTING WITH POSSIBILITY OF UP-SIDE-DOWN FILMING - USING ONLY 1 IRON BAR - 2 BOLTS

Dual Tripod Head

For the amateur who has occasion to shoot with two cameras at the same time—an “eight” and a “sixteen”; two eights; or one camera filled with black and white film and the other with Kodachrome, etc.—here is a simple gadget for the tripod head that will make the task easier. It consists of a piece of quarter-inch strap iron into which is drilled three holes as shown. The center hole is tapped to take the tripod’s screw, and the remaining two are drilled large enough to provide for quarter-inch No. 20 machine bolt which secures the camera in place.

An additional feature is that one or both cameras may be mounted upside down, as shown by dotted lines, adding further to the versatility of this gadget.

— P. E. Gatewood.

Prevents Scratching

In spite of careful cleaning of film gate of my projector, I have found that emulsion particles soon collect again and scratch my films. To remedy this, I now use ordinary ferrotype polish. Rubbed on the film gate with a small piece of chamois, one polishing serves for an indefinite period. Scratches have ceased to be an annoyance.

— Fred Bisbee.

CINEBUGS!

• If you have an idea for a gadget, trick, or shortcut in filming, titling, editing or processing home movies, pass it on to your fellow Cinebugs through these columns. If your idea is published you will receive two reels for your efforts. Extraordinary ideas will net you a roll of film.

Ideas not published will be held for future publication unless they duplicate ideas previously received. Endeavor also to send along photos or rough sketches illustrating your suggestions. There is no limit to number of suggestions you may submit.

Important: When submitting ideas, be sure to mention whether equipment you use is 8mm or 16mm, enabling us to promptly forward owords adaptable to your use.

Saves Cement

For those who use film splicing cement only at intervals, cement may be kept from evaporating through the cork by sealing with ordinary paraffine. Heat a quantity of paraffine in a small metal container until it becomes liquid. Then, after tightly screwing cap or cork on cement bottle, immerse top of bottle into hot paraffine to a point below the cap. This will seal the cap until needed for use again. This sealing process may be repeated as often as necessary. Do not have paraffine too hot and use the customary precautions in heating same as prescribed when using this material in canning.

— Joe Woodburn.

Reel Containers

Cans or containers for small reels of either 8mm or 16mm film, i.e., 25 and 50 foot, are available from most drug stores in the form of “ointment tins.” These come in a number of sizes and many have a paper disc inset in the lid which provides for labeling of film.

— Wm. McGee.

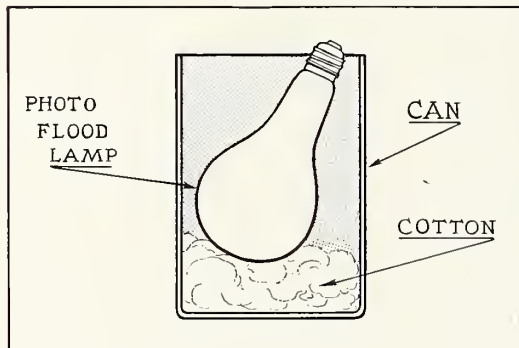

Photo Lamp Protection

For safe storage of photoflood lamps, I place them in individual tin cans from which the covers have been entirely removed. In the bottom of each can, I place a wad of cotton which acts as a cushion against any shock resulting from moving the lamps about during period of storage.

— Harold J. Fraulob.

Gas Pipe Rewinds

I made a satisfactory pair of film rewinds from a variety of $\frac{3}{8}$ " gas pipe fittings as shown in the accompanying sketch. Materials required were as follows: For heads (A), two $\frac{3}{8}$ " tees; stems (B), two $\frac{3}{8}$ " x 4" nipples; bases (C), two iron plates $\frac{1}{4}$ " x 2" x 2"; shafts (D), two pieces of $\frac{3}{8}$ " welding rod $3\frac{3}{4}$ " long; cranks (E), two pieces of $\frac{1}{8}$ " welding rod 4" long; one pound of babbitt metal; four $\frac{3}{8}$ " iron washers (F), and four $\frac{1}{8}$ " cotter keys (G).

The parts were fitted together as

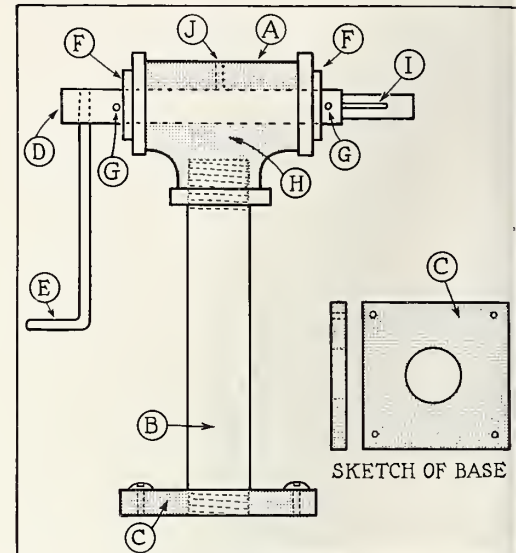

shown in the sketch. After centering shaft in tee, the molten babbitt metal is poured around it at (H) and allowed to harden. This forms a bearing for the rewind spindle to turn upon and keeps the spindle action smooth. A small piece of wire is soldered in place on the rewind spindle as shown at (I) which fits keyway of reel. A $\frac{1}{8}$ " hole should be drilled as shown at (J) to provide for oiling. The base (C) may be tapped to take threaded end of section (B) or it may be welded to this member.

— W. L. V. Cling.

Switch Saves Lamp

Owners of models 70 or 80 Kodascopes who would like to install 300-watt lamps in same way may do so by adding an additional switch which permits turning off projector light during rewinding. This allows lamp to cool, prolonging its life considerably.

I purchased a double-pole, single-throw toggle switch, rated 5 amp at 110 volts, for 75c from an electrical shop. Removing lamp housing of projector, I drilled a hole as shown in photo to receive shank of the switch. To make connection, I cut wire from lower end of resistor and soldered it to switch. Circuit was completed by soldering another wire from second switch connection to the resistor.

— Frisco Roberts.

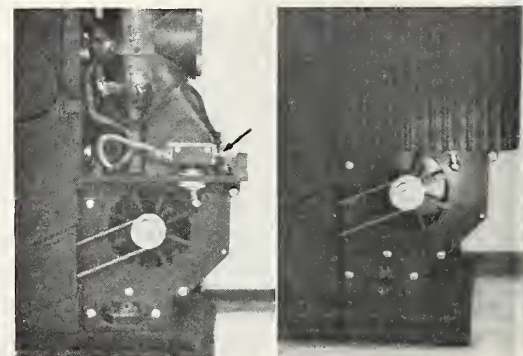

C I N E W O R K S H O P

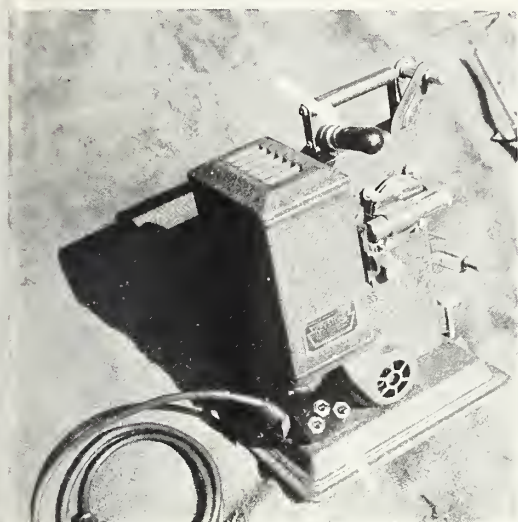

Automatic Pilot Light

The accompanying diagram shows how I installed a pilot light on my model J-8 Keystone projector and rewired same so that pilot light automatically goes off when projection lamp is turned on, and vice versa. Almost any make of projector without this feature may be rewired for the same result by following the accompanying wiring diagram.

Here is a list of materials required: 3 toggle switches; 1 candelabra lamp socket; 1 candelabra base lamp; 3 feet lamp cord; 1 piece of brass $2\frac{1}{2}'' \times 3\frac{1}{2}'' \times \frac{1}{32}''$.

The three switches are grouped together on the small panel made from the strip of brass. The pilot light is mounted at the top of projector as shown in photo. The arrangement provides for: Separate switch for pilot light. Pilot

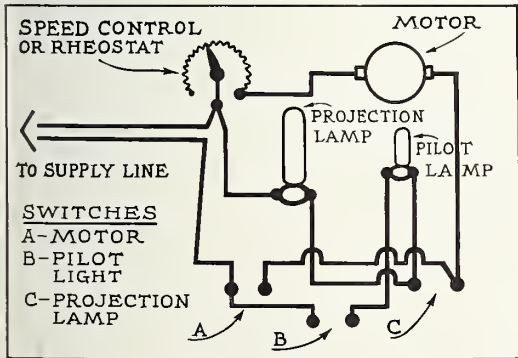

light is extinguished when projection lamp switched on. Pilot light automatically comes on when projection lamp is switched off. Projection lamp will not light when motor is not running.

—J. L. Leonard.

Telephoto Lens

Illustrated is an inexpensive telephoto lens which I made for my model "E" Cine Kodak. The part "A" which screws into the camera was made in a machine shop. The remainder, I built myself — using chromium plated plumbing tubing. The ends of the tubes were "squared up"

in a lathe. Tubes "B" and "C" were turned to provide a snug, easily sliding fit. (Their length depends upon focal length of lens to be used.) Tube "B" was made 5" long; tube "C" 2" long. The lens "D" was an anistigmat from an old folding Kodak, 6" focus.

The shutter was discarded and the lens mounted within the tube with the diaphragm intact. The diaphragm lever is shown at "E". Lens was cemented in place with liquid solder.

To determine focusing marks for lens, I took my camera into the field, mounted the telephoto lens, and with a strip of frosted film over the film gate, focused the lens upon objects at various distances. Footage marks were then scratched on the lens barrel as shown at "F". This focusing was done with the lens "wide open" in order to insure a crisp, sharp focus.

To compensate viewfinder for this telephoto lens, a mask was made of a

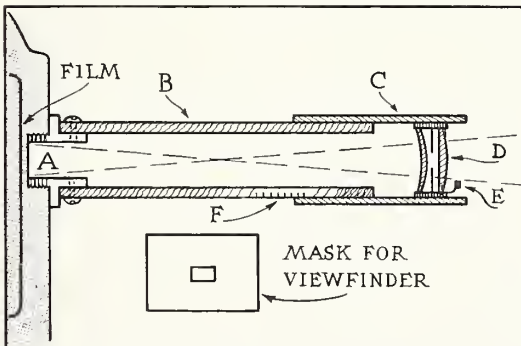

small rectangle of sheetmetal, in the center of which was cut a hole corresponding to the field covered by the lens. This mask was made to fit over viewfinder when this lens was in use.

—Owen Wilson.

Absorbs Noise

To deaden the sound of a too-noisy projector, place a pad of sponge rubber beneath it. These pads are obtainable in the five and ten-cent stores at small cost. They are particularly effective in absorbing projector noise when recordings are played simultaneously.

—Fred Grosse.

Projector-Editor

I rigged up my projector as an "action-editor" as shown in the accompanying sketch. Upon a pine baseboard I mounted a reflecting unit consisting of a mirror set at right angles and held in position by a metal upright. The mirror, which I obtained from a discarded handbag, was mounted in a metal frame or sheath. This was first soldered to the upright.

At the base of the upright, I built a box of plywood about 4" square and about 3" deep. Inside this box at the bottom, a sheet of dull white paper was placed to serve as a screen. Thus, with

gadgets, tricks and short cuts contributed by Cinebugs

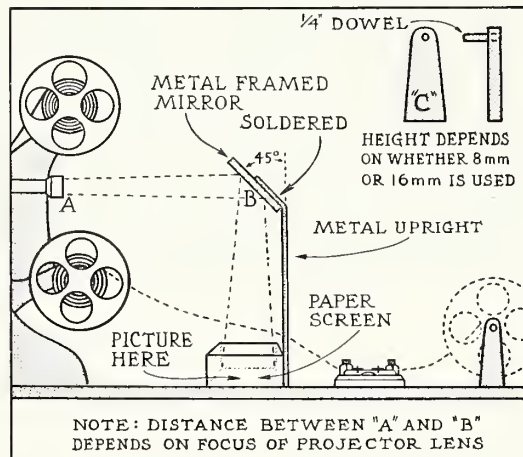

the projector in place and with the light beam focused on the mirror, the image is reflected down into the screen within the box. The box serves to keep sidelight from screen, making projected image more readily visible when used in a fully illuminated room.

To the right of the "screen," I mounted my splicer; and beyond it, an upright and spindle to hold the take-up reel of film during splicing operations. As soon as splice is completed, take-up reel is returned to projector.

—Russel Meyer.

Matte Box for "8"

Photo shows a matte box I constructed from plywood for my 8mm camera and also some of the many masks which I made from the same material. The box is mounted on a base board with a hole for mounting camera by means of tripod screw. Box fits snugly against camera lens in this position. In front, I built a slide to accommodate the masks, and you will note a small metal "stop" at the right end which insures placing masks accurately before the lens — especially

• Continued on Page 452

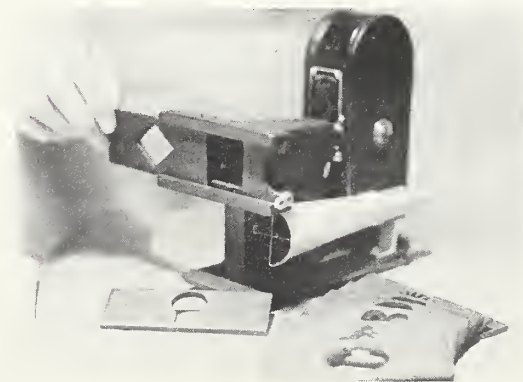



1600 SCHOOLS *serviced* by Ohio V. I. E. . .

WM. J. INSKEEP

IN 1916, a small-town teacher in Mingo, Ohio, became interested in tinkering with moving picture machines. Observation of his pupils had shown him that a considerably higher degree of interest was displayed in subjects in which the text books were well illustrated, or in projects wherein tangible subjects or illustrations of the matters under discussion could be used. He finally installed a 35mm projector in his school, and

began renting stock educational films for it.

A rousing reception greeted this pioneer effort in visual education in Ohio. National publications heralded it as the first practical project of its kind in the country, and the community was delighted with the response which was produced in the children's attitude toward subjects with which the visual idea was used. The school movie became a community institution; community theatrical performances were put on, charging a small admission, with such success that the venture provided funds, not only to support educational pictures for the school's use, but to completely equip the school's science and home economics libraries, playgrounds and several other activities.

Other schools nearby followed suit, and soon a miniature circuit was organized, through which pictures were routed and shipped,

though under the burden of a tremendous cost in rental fees. In 1927, the Ohio State Department of Education realized the merit of the efforts made by the individual schools, and formally created a department of Visual Education, taking the local projects under the wing of the state department. More films were becoming available without, by then, from the Federal Government and from business firms, which could be had for the payment of the transportation costs; still, without an acknowledged and reliable source of income, this was too much of a burden on the state educational funds. In an effort to lower the distribution cost, the state created divisional depositories, where films could be stocked and shipped out to schools, lessening the distance for their transportation. However, in 1931, when the depression hit the school fund, the department was finally discontinued.

The activities of B. A. Aughinbaugh, the Mingo school teacher who had pioneered visual education and who was not supervisor of the state department of visual education, were not discontinued, however. He continued his activities in correlating the local projects, advising on methods and treatment, and working for a sound visual educational program for Ohio. During this period a valuable film slide lecture of Ohio's history and resources was prepared.

In 1935, the new day for visual education in Ohio dawned, when a new law was enacted, finally creating a definite source of income for visual education activities. Half of the State censorship fees, less only operating costs, were definitely ear-marked for use in disseminating information about Ohio, and in cre-

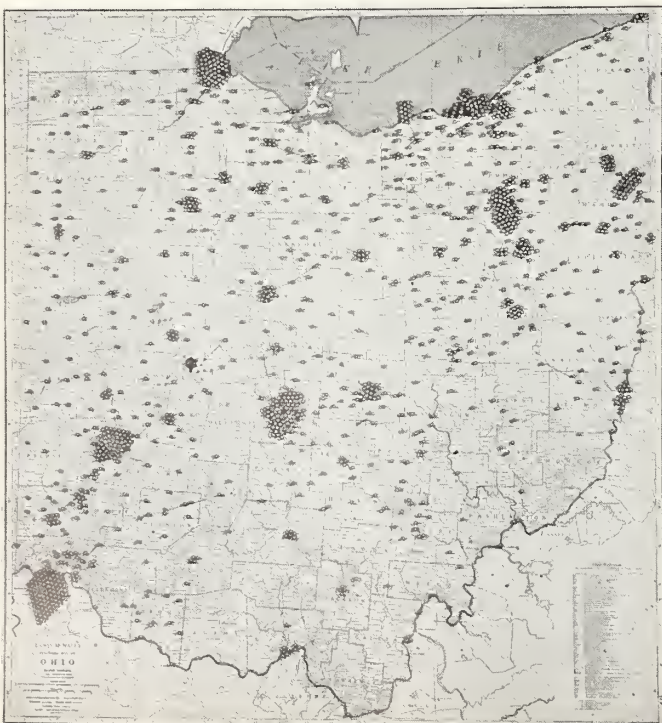

• Above—Slide and film inspection section and shipping department of the Visual Instruction Exchange, Ohio State Department of Education. Left—1600 mapstacks mark the schools in Ohio receiving V.I.E. Service.

• Continued on Page 438

• The school may turn its efforts toward producing a public relations film—a film designed to acquaint parents with the school's work.



Photos courtesy Los Angeles City Schools

Planning the SCHOOL FILM . . .

GODFREY M. ELLIOTT

THE resolution to make an educational movie does not immediately start the camera turning. Before final planning can take place, it must be determined what kind of a movie is to be made. By way of suggestion, one might review briefly the most prevalent types of school movies that are now being produced on amateur basis.

The word movie instantly brings to mind something fashioned after the Hollywood product, the entertainment or story type. The school organization may have in mind the dramatization of some well-known piece of literature or it may intend to produce a film based on original outline. Regardless of what sort of a story plot is to be filmed, consideration must be given to the availability of

actors, settings, scenic props, costumes, and similar factors.

A second type of movie often produced by schools is the newsreel, built primarily for showing to the student body and with only slight regard for permanent value. The newsreel plans must take into account such things as the importance of the events and persons to be filmed, their timeliness, and their relative importance to the prospective audience, as well as the time lapse between the filming and the first public showing.

The school may approach its problem by deciding to produce a teaching film. In this classification are found the films used to supplement classroom instruction, those used for occupational guidance, and the films built for the purpose of orienting the new student in his

new surroundings. Films of the instructional type are usually concerned with local problems, problems that have not been covered by commercial productions.

Finally, the school may turn its efforts toward producing the public relations movie, a film designed to acquaint parents with the school's work. This type of film usually sets out to answer three questions: what is the school doing, how is it doing it, and why is it being done?

For the specific purpose of permitting an illustration, it will be assumed that the school has decided to produce a public relations movie. The first step, then, is to determine just what is to be filmed.

• Continued on Page 448



EDUCATIONAL FILM TREATMENTS



Our Constitution

By H. G. HILTON
Oklahoma Public School System

THIS picture was used with particular reference to stressing the events leading up to the formation of the Constitution, with Washington, Hamilton, and Monroe being played up as nation builders, and was keyed strongly in a number of classes as illustrating the fundamentals of democracy.

All teachers saw the film before classroom showing, and each department developed its own classroom follow-up. Social science and history department laid emphasis on the principles underlying the actions of the early patriots, and the chronology of the events. The music department took this occasion to stress the songs, "America," "The Star-Spangled Banner," "God Bless America," "America the Beautiful," "Columbia, the Gem of the Ocean," and "Battle Hymn of the Republic." Words found in the film for emphasis by the spelling teacher were: constitution, convention, economics, politics, continental, congressional, personalities, foundations, civil. A study of colonial costumes and wigs grew out of the film for the home economics department, and the showing of the picture was used as the basis of a declamation series of famous historic speeches in the public speech department. Preparatory work was simple, consisting mainly of a sketch of events leading up to the revolution, taxation

without representation, and the Boston Tea Party. The unfair attitude of the British government in that time was played down, emphases being placed on the fact that the trouble lay with the ruler, George III, rather than with the English people. This was important in the formation of correct attitude toward the British Empire today.

Points covered in the follow-up were: 1. Why was a new Constitution necessary? 2. What social, economic and political factors forced the fathers of the country to call a convention? 3. What were the conflicting plans submitted to the convention for a Constitution? 4. What were the compromises?

The development of the American "Bill of Rights" as in the first ten amendments was studied as an outgrowth of the showing of the film.

Canals of England

By H. G. HILTON

PARTICULAR attention was given to the preparation for this picture, due to the unusual interest in England and geography of areas involved in the European war. Though not primarily a part of the picture, the subjects of the history and customs of England come up naturally in the film, and were seized upon as

a very timely opportunity for application to a wide variety of studies, including composition, science, geography, sociology, history.

Preparatory to showing the film, the instructor made careful preparations, beginning with a close study of the map of England to instill a good impression of England's geography. Points of interest appearing in the picture were studied particularly. Political developments from the year 1760 were discussed, and attention was given to the farm life in England. Magazine articles on the subject were used as corollary text in furnishing a background for the picture.

In showing the picture, emphasis was laid on the significance of the canals and their commercial uses in the present economic situation of England, so as to bring home the importance of inland shipping in a national economy under stress. Commentary was made, too, on the colloquial sounds used with the film: lowing of cattle, harbor traffic, canal locks opening and closing. Points developed after the picture were: 1. What effect did the canals have on the commercial development of Great Britain? 2. How do the English rural sections differ from our rural areas, and how are they alike? 3. What damage would bombings do to the canal system?

Another topic which formed the basis of an entire discussion was the Grand Union Canal connecting Birmingham with London, and its importance in wartime. A classroom project developed was the making of an enlarged map of the canal regions.

Sound Waves and Their Sources

By JOHN J. MARTIN

Woodlawn High School, Birmingham, Ala.

WHILE the outline and presentation of a film must remain flexible, and probably no two teachers would use the same outline for the same film, at the same time certain principles should be followed in any presentation to make it a worth-while activity rather than a mere recreation period or vacation from study for the pupils. The pupils' anxiety to "have a picture shown" in class cannot always be interpreted as a welcomed release from classroom work, but should serve as a constant reminder to the teacher that it may become just that to the pupils if the presentation and follow-ups are not carefully laid out and geared to the class. The first step in planning the treatment is a three-point consideration: the preliminary preparation, showing of the picture, and the follow-up.

After previewing the picture, the

teacher should make a list of the most important points in the picture, and prepare a more or less extemporaneous class discussion of them, having a brief outline before him with footnotes and source material. These points can be used to form the basis of a classroom discussion, without the pupils' knowing that they have come from a coming picture, so that the pupils will approach the picture with a working thought-knowledge of the essential content, but without their viewpoint being colored with the knowledge that the discussion is a prelude to a picture.

After the showing, the follow-up should comprise a class discussion or a written lesson. The first need is for them to be allowed to ask questions about points not entirely clear to them in the picture; too often this is overlooked and a complete understanding is not accomplished. The next point is what was of greatest interest to each pupil. The follow-up should be culminated in a pre-directed digest of all important points in the picture, planned and recapitulated by the teacher. If possible, a second showing should follow this.

For the film, "Sound Waves and Their Sources," the following outline was prepared for the preliminary discussion: the follow-up conformed closely to the pattern of the preliminary discussion, with more detailed information being drawn out.

OUTLINE

1. Preliminary preparation: discussions of the following:
 1. Production of sound waves.
 - a. Kinds and sources—vibrating forks, vibrating air columns, vibrating discs, vibrating strings (or vocal cords).
 2. Propagation of sound.
 - a. Speed.
 - b. Molecular activity.
 - c. Condensation.
 - d. Rarefaction.
 3. Recording of sound.
 - a. Oscillograph.
 - b. Oscilloscope.
 - c. Analysis of sound.
 4. Wave patterns
 - a. Music.
 - b. Noise.
 - c. Pitch.
 - d. Overtones.
 - e. Wavelength.
 - f. Reflection.
 - g. Absorption.
 5. Frequency.
 - a. Harmony.
 - b. Discord.
 - c. Audio frequency.
 - d. Radio frequency.
 - e. Beats.
 6. Practical applications.
 - a. Imposed on electrical current by microphones.
 - b. Imposed on radio waves by tubes.
 - c. Imposed on light waves by photoelectric cells.
2. Showing.
3. Follow-up.

Alaska's Silver Millions

By H. G. HILTON

THE film, "Alaska's Silver Millions," furnished by the American Can Company, when properly subdivided and treated, furnished excellent study material in several different branches of the Oklahoma City schools' curriculum. The film itself is the story of Alaska, the location, size, distance from the United States, relationship to the United States, sections of the country, original cost to the United States, and the story of the vast salmon industry.

Studying the film before showing it to the pupils, the instructor saw possibilities of embodying several lessons in its showing. It was decided to make two general units of study out of the picture: (1) The geography of Alaska and (2) The salmon industry. These were for the primary use of the social studies department and the geography unit during the course of study on Alaska. Other departments finding this treatment suitable for their purposes were the literature unit, which used the film as a basis for the encouragement of reading books such as Anne Lindbergh's "North of the Orient" and Jack London's "Call of the Wild." The spelling teacher found about thirty words that could be stressed from the standpoint of spelling and definition, such as pulp, latitude, glacier, spawn, iceberg, volcano, species, seine.

The pupils were then prepared for the picture, by a preliminary study of Alaska. Points of interest which would be shown in the picture were pointed out on maps, and discussed in detail. The history of Alaska was discussed, and the relation of the \$30,000,000 a year that

the salmon industry brings in to the original purchase price discussed. Material from the *National Geographic Magazine* was brought in to lay a groundwork of climate and people.

Since the picture is a sound picture, with Father Bernard Hubbard, the "Glacier Priest," acting as narrator, the picture was then shown without comment. After the showing, the pupils were invited to write down and discuss topics in which they were particularly interested. Among the chief topics were: a. a group of three went to work on a relief map of Alaska made of papier-mache; b. another group started an Alaska scrapbook from magazines and newspapers; c. another group began research for a report on the gold rush; d. another group took up mathematical geography: the latitude and longitude of Alaska, the International Date Line, area in square miles, mean temperature, and altitude; e. several groups started a study of the salmon production industry. The salmon section of the film was then shown a second time.

A test was then given the pupils along the following lines:

1. Alaska is a (a) state, (b) territory, (c) county, (d) republic, (e) belongs to Russia.
2. The Aleutian Islands are famous for their (a) factories, (b) rice fields, (c) volcanoes, (d) salmon runs, (e) government.

This selective answer type of examination was given covering all essential data covered in the film with very gratifying results.

Birmingham System Successful Despite Lack of Definite Budget

THE city school system of Birmingham, Ala., is one of those which follows the "mandatory system of decentralization," mandatory because there is a total lack of earmarked funds for sustaining visual education equipment and film rentals for the classes employing visual aids. Under the existing regulation, not a dollar may be diverted from the general school fund for such equipment.

Pending an adjustment of this condition, the independent factors in the Birmingham system have developed a well-defined system of cooperation and financing which has enabled the schools to continue an increasing campaign of employment of visual aids, despite the lack of coordination and formal financial support.

The basis of this plan is the old laboratory fee which has always been charged in most general science and biology

classes to cover the cost of chemicals and apparatus. The visual aid section in Birmingham has been loosely appended to the science departments, and laboratory fees graduated from 25c to \$1 are collected from the pupils, according to the number of years of science each has had. This fund is labeled "laboratory fees," and must be stretched to cover a wide variety of equipment and material.

In order to stay within these slender means, the teachers concerned with vis-

• Continued on Page 448

• HOME MOVIES invites educators as well as producers and distributors of educational films to submit treatment data or information on changes in treatment of any educational films.

OUR GIGANTIC 21st ANNIVERSARY

It lists 1000 16mm sound features and thousands of shorts; also a large library of 16mm and 8mm silent subjects!

Never has such a library of non-theatrical subjects been gathered together under one roof. Every kind of entertainment subject available!

• FOLLOWING ARE A FEW OF OUR 16mm SOUND FEATURES SUITABLE FOR SCHOOLS

ABRAHAM LINCOLN
AFFAIRS OF SUSAN
AFRICAN HOLIDAY
AIRMAIL
APRIL ROMANCE
BAREFOOT BOY
BATTLE OF GREED
BEFORE THE WHITE MAN CAME
BEYOND BENGAL
BIG CAGE
BLAZING BARRIERS
BOY OF THE STREETS
BREAKUP
BRIDES OF SULU
BRIDGE OF SIGHS
BRING 'EM BACK ALIVE
BROKEN MELODY
BURIED ALIVE
CALIFORNIA STRAIGHT AHEAD
CALLING OF DAN MATTHEWS
CAROL OF THE MOUNTAINS
CAVALCADE OF CIVILIZATION
CIVILIZATION
COME ON, TARZAN
COUNTY FAIR
COUNSELLOR-AT-LAW
COUNT OF MONTE CRISTO
CRIME OF DR. CRESPI
CRUSADER
CZAR TO LENINE
DARK SANDS
DAUGHTER OF THE REGIMENT

DEAD MEN TELL NO TALES
DIAMOND JIM
DON QUIXOTE
DRAKE THE PIRATE
EAT 'EM ALIVE
EUROPE AT WAR
EXPLORERS OF THE WORLD
FARGO EXPRESS
FORBIDDEN TERRITORY
FOUND ALIVE
FOUR DAYS WONDER
FRESHMAN YEAR
GIRL OF THE LIMBERLOST
GLORY TRAIL
GOD'S COUNTRY AND THE MAN
GOOD FAIRY
GREAT IMPERSONATION
HARMONY LANE
HEALER
HITLER—BEAST OF BERLIN
HONOR OF THE MOUNTED
HOOSIER SCHOOLBOY
HOOSIER SCHOOLMASTER
HUMAN SIDE
I CONQUER THE SEA
I COVER THE WATERFRONT
IDOL OF THE CROWDS
IMITATION OF LIFE
ISLAND CAPTIVES
JANE EYRE
JAWS OF THE JUNGLE
JUVENILE COURT

KATHLEEN
KEEPER OF THE BEES
KILLERS OF THE SEA
KING OF THE SIERRAS
LADY OF THE LAKE
LADY TUBBS
LAILA
LAST DAYS OF POMPEII
LAST OF THE MOHICANS
LAW COMMANDS
LAW OF THE 45's
LET'S SING AGAIN
LETTER OF INTRODUCTION
LIFE AND LOVES OF BEETHOVEN
LIFE RETURNS
LITTLE RED SCHOOLHOUSE
LOST IN THE STRATOSPHERE
MAD ABOUT MUSIC
MAGNIFICENT OBSESSION
MAKE A WISH
MAN'S BEST FRIEND
MARINES ARE COMING
MATTO GROSSO
MELODY LINGERS ON
MEN OF IRELAND
MERCY PLANE
MINE WITH THE IRON DOOR
MY MAN GODFREY
MY OLD KENTUCKY HOME
MY PAL, THE KING
NAGANA

NAVY SECRETS
NEWSBOY'S HOME
OLD CURIOSITY SHOP
OLD HOMESTEAD
OLD LOUISIANA
OLIVER TWIST
PARADISE ISLE
RANGLE RIVER
RAW TIMBER
RED SALUTE
RENFREW OF THE ROYAL MOUNTED
ROAD BACK
ROMANCE OF THE LIMBERLOST
SAMARANG
SECRET OF STAMBOUL
SHE SHALL HAVE MUSIC
SKULL AND CROWN
STUDENT ROMANCE
SUDAN
SUTTER'S GOLD
SWING THAT CHEER
TARZAN'S REVENGE
THREE KIDS AND A QUEEN
TUNDRA
WANDERING JEW
WEDDING OF PALO
WHEN KNIGHTS WERE BOLD
WHERE THE BUFFALO ROAM
WILLIAM TELL
WINGS OF ADVENTURE
WITH WILLIAMSON BENEATH THE SEA

• A few of our foreign language films available:

CZECHOSLOVAKIAN
THE GAY HOSTESS INN
INSPECTOR GENERAL
FRENCH
CARNIVAL IN FLANDERS
HEART OF PARIS
THE PEARLS OF THE CROWN
THE MIRACLE OF FAITH
LIFE AND LOVES OF BEETHOVEN
MAYERLING
END OF A DAY
VOLGA BOATMAN
ESCAPE FROM YESTERDAY
SOUS LES YEUX—D'OCCIDENT
A NOUS LA LIBERTE
LIFE OF PASTEUR
MARSEILLAISE
THE PURITAN
CRIME AND PUNISHMENT
BIZARRE BIZARRE
THEY WERE FIVE
GRAND ILLUSION
SPANISH
LA LLORONA
LA ISLA MALDITA
EL HEROE DE NACAZARI
JALISCO HUNCA PIERDE
LOS MILLONES DE CHAFLAN
DOS MUJERES Y UN DON JUAN
LA ZANDUNGA

UNA LUZ EN MI CAMINO
BEYOND BENGAL
THE ADVENTURES OF CHICO

GERMAN
THE GIRL FROM THE REEPERBAHN
CONCERT IN TYROL
AN ORPHAN BOY OF VIENNA
COBBLER CAPTAIN OF KOEPENEK
MAKING OF A KING
EMIL UND DIE DETEKTIVE

ITALIAN
OTHELLO
DON BOSCO

YIDDISH
JOSEPH IN THE LAND OF EGYPT
SACRIFICE OF ISAAC
DREAM OF MY PEOPLE

NORTHERN LANGUAGES
LAILA (Swedish)
WEDDING OF PALO (Eskimo)

ORIENTAL LANGUAGES
ETERNAL QUEST (Japanese)
SONG OF CHINA (Cantonese)

POLISH
TEN WHO WERE CONDEMNED
YOUNG FOREST

• Samples of 3-reel sound pictures for schools:

NORTH SEA
CAVALCADE OF AMERICA
KAMET CONQUERED
SURFACE CHEMISTRY
ROBINSON CRUSOE
THIS IS CHINA
TRAILING THE JAGUAR
FISH FROM HELL
ITCHY-SCRATCHY
FIVE FACES
CHILD OF MOTHER INDIA

THE DEVIL'S PLAYGROUND
TRAGEDY OF MT. EVEREST
EVOLUTION
DEATH DRUMS OF NEW GUINEA
HISTORY OF AVIATION
RIO ROOSEVELT
LAND OF GIANTS
TODAY WE LIVE
THE NEGRO FARMER
FLOOD WEATHER
HELL BELOW ZERO

• A few 4-reel 16mm sound pictures available for school use:

BONNIE SCOTLAND CALLS YOU
ATOMS AND MOLECULES
THE VOICE OF INDIA

FRANCE (in color)
THE PENTHOUSE OF THE GODS
(In color)

IDEAL PICTURES

HOME OFFICE: 28 East Eighth Street, Chicago, Illinois

ATALOG IS NOW READY . . . !

SMASH . . . ! go rental prices!

• We will not be undersold, thus we have made drastic slashes in many rental prices. You can now rent a complete nine-reel program of 16mm sound film as low as \$5.00 per day and \$10.00 per week on contract.

Hundreds of one-reel pictures on every conceivable subject



• Robert Donat in "Count of Monte Cristo."

What Stars They Include . . . !

JOHN BARRYMORE
PAT O'BRIEN
EDWARD ARNOLD
JEAN ARTHUR
HERBERT MARSHALL
ADOLPHE MENJOU
JAMES CAGNEY
CLAUDETTE COLBERT
CHARLIE McCARTHY
EDGAR BERGEN
VICTOR McLAGLEN
WILLIAM POWELL
CAROLE LOMBARD
ROBERT TAYLOR
IRENE DUNNE
MICKEY ROONEY
DEANNA DURBIN
CONSTANCE BENNETT
VIRGINIA BRUCE
MARGARET SULLIVAN

Some 2-Reel Pictures For School Use:

LOUIS PASTEUR	OUR WILD LIFE RESOURCES	STUDY IN INFANT BEHAVIOR
PURITANS OF MASSACHUSETTS	SUGAR IN THE EVERGLADES	STORY OF THE SPONGE
COLONY	HIGHWAY BEAUTIFICATION	LIFESAVING
CUBA BEYOND HAVANA	MANCHUKUO	REMBRANDT
CONQUEST OF THE ALPS	GRASS	OUR CONSTITUTION
MAGIC STRINGS	WITH CHINA AT THE FRONT	
WASHINGTON	LAND OF SHALIMAR	
ZITARI	EARTHQUAKES	
THUNDER OVER THE ORIENT	FINGERS AND THUMBS	
INCA—CUZO	MITES AND MONSTERS	
TAXCO	MONKEY INTO MAN	
VIERNES DEL DELORES	ZOO BABIES	
THEODORE ROOSEVELT	COVER TO COVER	
MANGA	HIGHWAY MANIA	
SEA KILLERS	SEA OF STRIFE	
SNOW AND ICE	THE CICADA	

YOUR BIG CATALOG IS NOW READY! SEND FOR IT!

ORPORATION . . .

PACIFIC COAST OFFICE: 2402 West Seventh Street, Los Angeles, California

"IT'S NEW TO ME"

... News of new equipment as seen at the National Photographic Dealers' Association Convention in Chicago ...

By CINEBUG SHOPPER

The Trade Show held this year in conjunction with the National Photographic Dealers' Association Convention at Chicago, August 19 to 23, revealed many new and interesting accessories and equipment for the amateur movie maker.

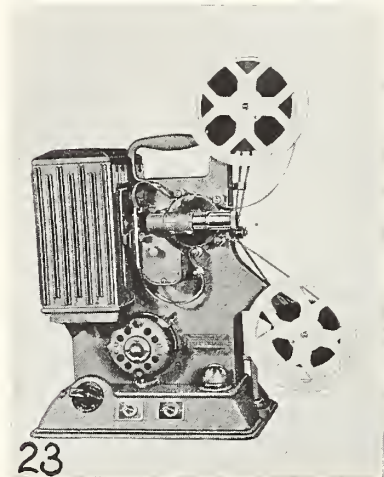

● Keystone's 8mm Projector

Of the Keystone line of cameras and projectors which was featured in a very complete display, the model R-8 8mm projector was the center of interest. Claimed as the only 8mm projector selling under \$70 possessing so many features, it also boasts accommodation for 300 and 400 foot reels, permitting the projection of a continuous 33-minute show without changing reels.

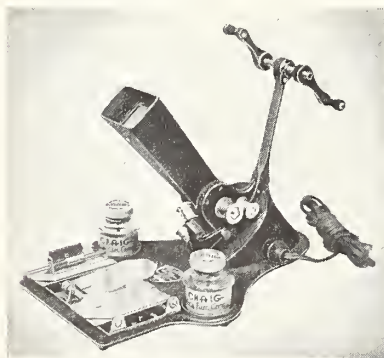

● New Craig 16mm Editor

An accessory destined to receive a lot of attention from amateurs this fall is the new Craig 16mm Junior Editor, which is priced at a figure to fit the average cinefilmer's pocketbook.

This new editor incorporates

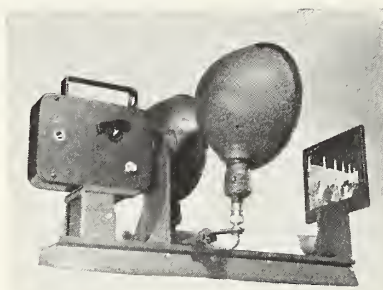

● 4-Star Titleer

the famous rotary projection principle. Its action-editing feature permits careful inspection—slow motion if desired—of every movement on its brilliant miniature screen. It is available with or without the Craig Senior splicer.

Hollywood Cine Products, Los Angeles, introduced their latest 4-Star "Titleer"—a new compact titler for 8mm and 16mm films said to be the result of collaboration between Hollywood Studio technicians and an advanced amateur

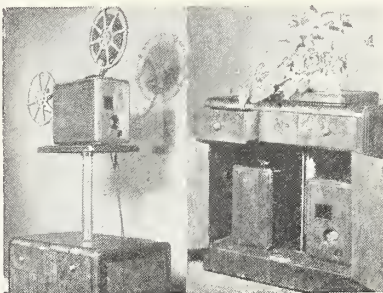

● Filmo Projector Cabinet

movie maker. Featured are: Larger title area, permitting shooting titles at 4, 6, 8 and 12 inches, with a complete set of auxiliary lenses for each of the given distances; facilities for making Zoom titles; simple alignment system; and adaptability to making ultracloseup shots of objects.

Priced well under the \$10 mark, lights and professional attachments may be had for a few dollars extra.

Bell & Howell displayed their latest Projector Cabinet, a valuable two-in-one home movie accessory which serves both as a storage place for cine equipment as well as a stand for placing the projector in the most advantageous position for use in the home.

Chief feature of the cabinet is the elevating projector base. A sturdy steel column within the cabinet is manipulated by turning a crank which raises or lowers the platform as required. It will elevate to a maximum height of 56 inches.

Finished in polished walnut, it is equipped with concealed wheels to make it easily mobile. Total weight of cabinet is said to be approximately 125 pounds.

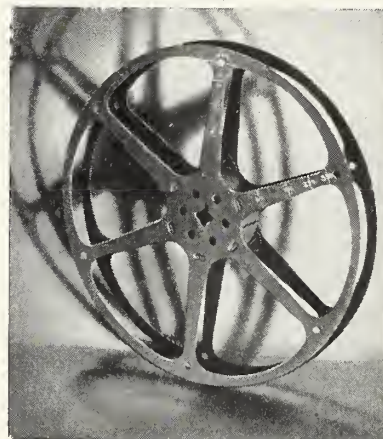

● New B. & H. 400' Steel Reel

Bell & Howell also displayed latest addition to its line of Filmo steel projection reels—a 400-foot unit for 16mm film. Flanges of this steel model are rigid enough to hold film in perfect alignment and to prevent binding of film on reels during projection. This new steel reel will fit the regular 400-foot 16mm aluminum film humidor cans. Selling only slightly higher than the aluminum reels, the greater protection offered by the steel reel is certain to be attractive to appreciative amateur filmers.



● Besbee Pocket Title Letters

Albert Specialty Company, Chicago, whose display includ-

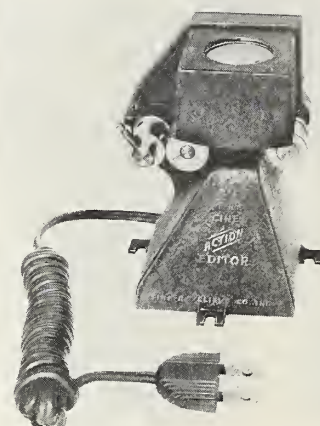

● F-R Action Editor

ed many interesting items for the cine fan, was rewarded by considerable interest from amateurs for the Besbee Pocket Title Letter set. This outfit makes possible the use of small movable title letters with typewriter titlers. The set includes a background with features that permit clamping it to small titlers; a complete font of miniature metal letters, and tweezers for selecting and arranging the letters in place on the title board.

A mask is also furnished with the outfit, which enables user to line up the title borders and keep title within the limits of the camera field.

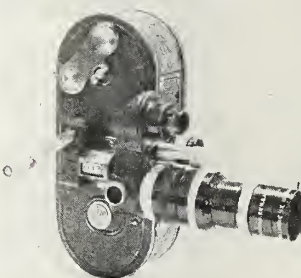

● MacVan Turret and Backwind

Still another film editing device to hit the market for fall distribution is the new Fink-Roseleive Cine ACTION-Editor. Patterned after the editing machines used in the cutting rooms of Hollywood studios, this new editor is said to contain features usually found only in machines selling many times higher. (This one will retail for less than \$10.) Some

retail for less than \$10.) Some of these features are: Permitting films to be edited while actually moving or stationary; viewing the film magnified four times its size; simplicity in operation and the use of low wattage lamp which gives essential illumination without excessive heat.

MacVan Electric Co., San Diego, Calif., specialists in turrets, backwinds, lens mounts, etc., for cine cameras, have recently developed a series of custom-built accessories for the Keystone 8. Illustration shows a three-lens turret with erect image focuser built for this model camera which is also equipped with backwind and frame counter. This company specializes on custom-built accessories and alterations for cine cameras of all makes, 8mm or 16mm.

Color Film Library

Recognizing the great interest shown in color films which possess such great realism and vivid beauty, Walter O. Gutlohn is rapidly increasing its color film library. They have just issued a comprehensive folder descriptive of their well-known color library of 16mm sound and silent pictures.

Among the outstanding color films listed are the newest releases, including three silent films on South America, one reel each, entitled: "East Coast of South America," "West of the Andes," "The Windward Island," and two sound subjects, "Waltz of the Flowers" and "Jefferson and Monroe," one reel each.

A copy of this folder of 16mm color films can be secured by writing to Walter O. Gutlohn, Inc., 35 West 45th Street, New York.

Film Process

Used successfully by motion picture producers and film laboratories for fourteen years, the O'Sullivan Film Process is now available to professional and amateur photographers. This process is said to preserve film indefinitely, add definition, and prevent fading and bleeding of color emulsions. It is further claimed to be impervious to heat, cold, moisture, dryness and oil.

NEW Educational RELEASES

MIRACLE OF THE MEADOWS

20 Minutes — 16mm — Sound. Donavin Miller Productions, Hollywood, Calif. Covers the entire process of production of both raw and pasteurized milk, treating at length the processes of production, certification and pasteurization. Included are continuity and narration sheets.

MILK

10 Minutes — 16mm — Sound. Donavin Miller Productions, Hollywood, Calif. A primary teaching film in which the logical sequences of scenes are far more educational than an actual trip through the farm. This picture shows the production of certified raw milk on a modern dairy farm. It is especially prepared and edited for young children studying the home, food, and community services. Continuity and narration sheets available.

AIRLINER

20 Minutes — 16mm — Sound. Donavin Miller Productions, Hollywood, Calif. Not a technical film of aviation, but depicts the modern air transport in actual service. Shows the latest developments in modern air transport, air terminals, traffic control, and inspection and servicing of motors, etc. Shows many important things the passengers themselves do not see or know.

AWAY WITH THE WIND

360 Feet and 100 Feet Silent 16mm; also 350 Feet Sound. Official Films, New York. This is a story of the sea, of sailboats, motorboats, surfboards, and hydroplanes. Thrilling scenes from famous yacht races. All the thrills and beauty of the sea from moonlight sailing to the pounding of thousand horsepower motors.

FOLLOW THRU

360 Feet and 100 Feet 16mm Silent; also 350 Feet Sound. Official Films, New York City. A fine picture on the subject of golf which takes you from the rock-bound coast of California's Pebble Beach, to Pinehurst—the golfing center of the world. Includes scenes of Tommy Thompson in zooming drives that have made him famous; iron plays of Dick Metz; and spectacular plays by Horton Smith.

PRESIDENTS OF THE UNITED STATES

9 Minutes—400 Feet 16mm—Sound. Official Films, Inc., New York City. Presents in chronological order, closeups of the Chief Executives of the United States with a synchronized commentary providing basic data on the incumbency of each.

CHAMPIONSHIP BASKETBALL

10 Minutes—400 Feet 16mm—Sound and Silent. Official Films, Inc., New York City. Analyzed by Nat Holman, head basketball coach, City College of New York,

three important factors are discussed: offense, defense, and fundamentals. Those interested in basketball cannot help but benefit from this highly instructional film.

HIGHLIGHTS OF LINCOLN'S CAREER

12 Minutes—400 Feet—16mm—Sound. Nu-Art Films, Inc., New York. A compilation of the most dramatic and historically significant moments from D. W. Griffith's 10-reel production, "Abraham Lincoln." Edited expressly for classroom use by Dr. Frederick Houk Law, who also prepared a study guide for the film. Bound to leave, in memory of the student, after-images which can readily become anchors for factual data supplied by the instructor.

HUNGARY

800 Feet—16mm Color—Silent. Walter O. Gutlohn, Inc., New York, N. Y. This film shows colorful Budapest and the countryside of Hungary. We see the Hortabagy, or great Hungarian Plains, with their picturesque cattlemen, the magnificent horses and cattle, peasants in native costume dancing the Csardas, and the beautiful resorts and lake country.

DENMARK

800 Feet—16mm Color—Silent. Walter O. Gutlohn, Inc., New York, N. Y. A camera trip through this peninsula country showing colorful scenes of the changing of the guard, the King's birthday celebration, and a yacht basin. Included are interesting views of churches and statues with emphasis on points of architectural interest.

ESTONIA

400 Feet—16mm Color—Silent. Walter O. Gutlohn, Inc., New York, N. Y. Scenes in Narva and in the capital city of Tallinn contrast with views of country estates. We also see folk dances and athletic games among the school children.

WINGS OVER WORLD WONDERS

400 and 100 Feet 16mm Silent; 360 Feet 16mm Sound. Castle Films, New York, N. Y. Most novel tour of the world ever filmed. A journey in the clouds over many continents. Flying westward from New York, one gets bird's-eye view of thundering Niagara, Yosemite, Grand Canyon, New Zealand's Alps, Fujiyama, the Sahara, Pyramids, Rome, London, and Paris. A film that reveals new beauties in scenes that have become familiar when seen from the ground.

COME BACK TO IRELAND

400 and 100 Feet 16mm Silent; 360 Feet 16mm Sound. Castle Films, New York City. An intimate visit amidst the white,

• Continued on Page 450

Push the button!
Out comes the film
from the new

DECO EJECTOR FILM LIBRARY

(for 8 and 16mm movie reels and cans)

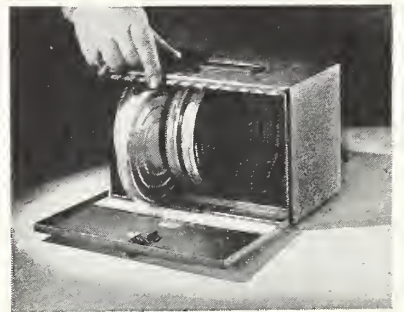

Compact, convenient, safe storage for your movie films. In use, select the film you want, push the button, and the selected film is automatically ejected.

All steel welded construction makes this Film Library strong and dust-proof; safety catch and key lock protect films.

For greater filing convenience, there is an outside and an inside removable index; uniform recesses for stacking; and a full length hinge.

The Deco Film Library is hand-somely finished in a durable brown wrinkle finish, has a recessed carrying handle and felt feet.

8mm CHEST

Capacity:
12-200 foot reels with or without cans

\$3.95

16mm CHEST

Capacity:
12-400 foot reels with or without cans

\$4.75

Willoughbys

110 West 32nd Street, N. Y.

World's Largest Camera Store
Built on Square Dealing

THE Bolexmeter

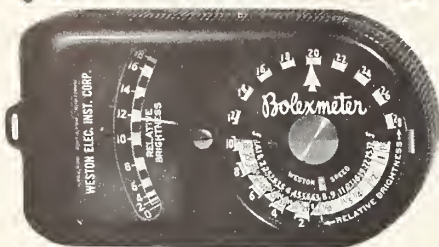

DOUBLE-DUTY DIAL GIVES QUICK READINGS FOR BOTH CINE AND STILL CAMERAS

THE NEW BOLEXMETER is the proved Weston "Master" exposure meter especially produced for the AMERICAN BOLEX Co. It has all the features of the famous "Master" plus the efficient, two-color, double purpose dial which was designed for use with BOLEX and all other cine cameras. Diaphragm stops in relation to cine camera speeds of 8 to 64 frames per sec. can be read directly. Dial also includes all shutter speeds and stops for still cameras.

See your dealer or order direct . . . \$24

Bool

CINE-FADER

PUTS 64 VARIETIES OF FADES & DISSOLVES

at your finger tips

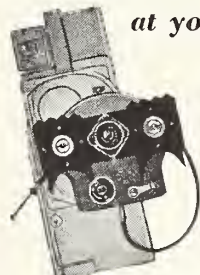

The handy Boole times and automatically makes by clockwork mechanism, all kinds of tricky effects "as you go." When operating there is no need to remove the eye from viewfinder. Boole also serves as filter holder.

FITS MOST EVERY MOVIE CAMERA AND PROJECTOR

Complete with extension tube, cable release, and instructions for operation..... \$17.50

Cinea FILM CEMENT

The only cement that is good for all kinds of film—acetate or nitrate—35 mm, 16 mm, or 8 mm. Cinea Cement is odorless, does not bleach color, is slow to evaporate from uncorked bottle yet joins film quickly and strongly. Bottle..... 25c

CINELAC

PROTECTS YOUR FILM

against SCRATCHES,
FINGER MARKS, CURL
AND BRITTLINESS

CINELAC permeates and toughens the emulsion—seals in moisture—prevents excessive aging—protects negatives and cine film. No apparatus needed—easy to apply. 2 oz. bottle \$1.00



See your dealer or order direct from—

AMERICAN BOLEX COMPANY
155 EAST 44th ST. • NEW YORK, N. Y.

1600 Schools Serviced by V. J. E. . .

• Continued from Page 430

ating and maintaining a suitable collection of visual aids for school loan.

Black slates are rapidly bowing to white screens in Ohio's entire school system now, and under Supervisor Aughinbaugh, the visual education department has the largest exchange of films and slides for distribution of any state in the country, valued at \$300,000. A net-work of 1600 schools which blanket the state eagerly take advantage of the system.

The re-created office today boasts 600 motion pictures, with a total of 2500 reels. The total number of lantern slide sets comes near the 7000 mark. Subjects run the educational gamut through citizenship, fine arts and crafts, geography, history, zoology, literature, transportation, biology, chemistry and foreign languages. The nerve center of the entire state system is in the central office in Columbus, where 18 full-time employees are required to carry on the maintenance, replenishment, booking and shipping operations involved in conducting the department. No sub-stations are necessary for the distribution of the materials, since Columbus is the geographical center of Ohio.

The operation of the system is simplicity itself. A 146-page glossy paper catalogue is issued every two years by the central office, listing and cataloging the aids it has available. These are distributed to every school in Ohio. Additions, discontinuances and replacements are announced through periodic bulletins. When a school wants a film, it fills out an "order" form, and mails it to Visual Aid headquarters, stipulating the date the material is wanted. If possible this date is met; if not, an alternative may be sent if the requisition specifies, or the school will be notified in time to alter its plans accordingly. The participating school pays only the mailing costs, which may run from eight to forty-six cents.

And costs, surprisingly, Aughinbaugh points out, are vastly lower than the cost of books. A film seven years old, having been booked 20 times per year, has been booked a total of 140 times. There are always at least two showings made, bringing the total up to 280. An average of 100 pupils are present at each showing, presenting a circulation of 28,000 exposures to individual pupils through a seven-year career of a single film. The cost of the film being about \$24, this presents a per-pupil circulation cost of 8½ hundredths of a mill. Contrast-ed with the same statistics taken from public libraries, where the average book, with a 60-loan life, costing \$1.50, involves a per-person circulation cost of 2½ cents, the cost is infinitesimal.

Local schools participating in the state service operate and plan their own schedules independently, adapting their films and treatments to best suit their individual classes and problems. They make their own arrangements for projection equipment, and are secured in various ways. In some of the communities, the school fund budget extends to equipping a projection room or a portable projector. In some instances, the graduating classes are making a practice of donating some piece of visual aid equipment. Some schools employ outside fund-raising activities, and other projectors are financed by the students themselves, in class-room projects and collections. In some instances, a local system will secure a portable projection outfit, and shunt it from school to school.

Commenting on the success of Ohio's visual education system, E. N. Dietrich, Ohio Director of Education, says, "The experimental stage has passed and the service is reaching into every county, city and exempted school district of the state. Where the exchange formerly had a few hundred prints of films for distribution, it now has

thousands, and where it once filled a hundred bookings a month, it now fills many times that many.

"The most remarkable feature has been the universal approval of not only the service itself, but also of the manner in which it has been conducted. In any project as relatively new as this, much shifting and changing might be expected, but it has been proven that the original set-up in this exchange service provided for all future details, so that the expenses have taken place without disturbance. Visual education is here to stay, and teachers and school systems who fail to recognize this fact will handicap their own progress and that of the classes under their direction."

An extension of the growth of visual education in Ohio is the big-city systems, which operate independently of the state exchange systems, though having access to its facilities. At the Educational Museum in the Gladstone School, of the Cleveland School System, is a tremendous storehouse of visual aid material. Director William M. Gregory has 1300 films, 450 sound and silent projectors, 20,000 photographic negatives, 162,000 slides, 3,000 sets of mounted pictures, and 3,000 specimen exhibits.

PICNIC

• Sponsored by HOME MOVIES Magazine, the Associated Southern California Movie Clubs will hold a picnic September 22, 1940, at Recreation Park, Long Beach, California.

Members of all amateur movie clubs in Southern California are cordially invited to attend, bring their friends, and be prepared for a big day.

Arrangement Committee is composed of officers of the Long Beach Cinema Club, and the Entertainment Committee, of officers of the Los Angeles 8mm Club. Those interested in attending are requested to communicate with members of either of these committees.

This picnic is to become an annual event, under the sponsorship of HOME MOVIES, and will be held at a different location each year as decided upon by officers of the various clubs.

PACIFIC HOUSE CINEMA
CONTEST

PACIFIC HOUSE, at the Golden Gate International Exposition, San Francisco, extends a cordial invitation to all amateurs to show their home movie films (both 16mm and 8mm) in the Cinema Contest held in the Conference Room of the Theme Building at Treasure Island on the following dates. Material treating the topics mentioned below will be acceptable on the dates mentioned:

Monday, September 2—8mm and 16mm films. All subjects.

Wednesday, September 4—Slides. All subjects.

Monday, September 9—8mm and 16mm films. All subjects.

Wednesday, September 11—Slides. All subjects.

Monday, September 16—8mm and 16mm films. All subjects.

Wednesday, September 18—Slides. Final invitational showing.

Monday, September 23—8mm and 16mm films. Final invitational showing.

A set of the Covarrubias Map Reproductions will be awarded as the grand prize for the Pacific House Cinema Contest. Each Monday and Wednesday evening a single Covarrubias map reproduction will be given to the winner.

Film This
Cartoon . . .

• Continued from Page 422

edge as a guide. The easiest way is to line up the four corners.

Fill in the space in the first title with your own name. Now photograph the first four titles in order. The first cartoon scene of the two subjects on a bicycle is composed of three pictures. Photograph 10 to 20 frames of the first one, setting the camera for half speed (if possible) and touching and releasing the exposure lever quickly so that only one frame at a time is exposed. No harm will result if one misses now and then, because of the speed at which they are projected.

Remember, a smaller lens opening is needed for black and white cartoons than for most subjects. Now expose three frames of the second cartoon, next three frames of the third cartoon—then go back to the first cartoon and expose three more frames, and so on for several seconds (exposing a total of 100 to 200 frames for this scene).

The action in this scene can be made to go faster, slower or in reverse according to the number of frames that are exposed each time and the order in which they



presenting

THE FINEST TITLING STAND

*ever made available
to amateur*

MOVIE MAKERS

SUPERIOR IN EVERY WAY—

- 1—Precise, beautifully finished, all metal construction
- 2—Accurate and rigid—never slips, wobbles, or wavers
- 3—Operates horizontally or vertically with any 8mm or 16mm camera
- 4—Quick and certain alignment of lens with center of title board
- 5—Makes “professional” effects—zooms—flips—turnarounds, etc.
- 6—Micromatic adjustments—chromium steel track—special lighting brackets and reflectors—exclusive title board frame—

HERE'S THE *title maker* YOU'VE BEEN WAITING FOR!

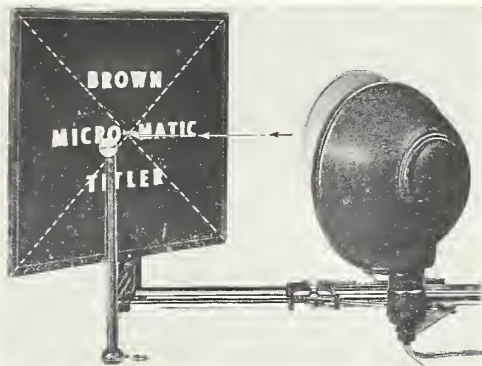

Makes TITLES the CERTAIN way

THE BROWN MICRO-MATIC TITLER is not just another contraption to confound the amateur—it is a completely designed and precisely built instrument which, for the first time, provides the movie maker with the means for making the finest titles at minimum expense and effort.

Precision and accuracy of adjustment are of paramount importance in a title maker. In providing these features to a degree never before made available, the BROWN TITLER has filled an urgent need. The BROWN can be dismantled quickly and stored in small space—but it will always retain its accuracy and rigidity when reassembled for use. There is no other title maker like the BROWN.

COMPLETE SET INCLUDES

BROWN TITLER STAND . . . 9" x 12"
TITLE FRAME . . . CLEAR AND OPAL
GLASS PANELS . . . CORK PANEL . . .
VERTICAL PIVOT BEARING . . . TWO
HORIZONTAL BEARINGS . . . TURN-
AROUND AND FLIP-OVER STOP . . .
ZOOM STOP . . . TWO SPECIAL LAMP
REFLECTORS . . . ADJUSTABLE LAMP
BRACKETS . . . SOCKETS . . . EXTENSION
CORD . . . MICROMATIC ADJUSTABLE
CAMERA TABLE . . . TARGET SIGHT
AND AUXILIARY LENS HOLDER . . .
FIELD CHART FOR LENSES . . .
AND FULL INSTRUCTIONS . . . \$27.50

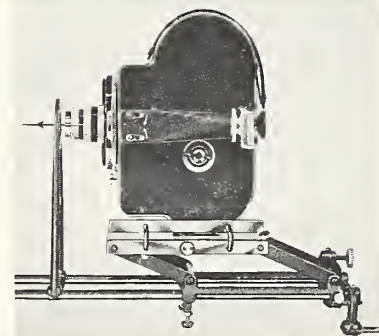

9"x12" board all are within the 31" working range of the BROWN. At 31" when stopped down to F/8 or F/11, even fixed focus lenses will produce needle sharp titles.

An actual hand, writing titles can be photographed easily, of course. The BROWN TITLER is always a precise copy stand and is readily adaptable for photographing many small subjects at close distances. When used in a vertical manner the movable parts of the BROWN all can be *locked* in desired positions.

Next to accuracy and neatness the most desired quality in movie titles is *variety*, and the BROWN incorporates those features of design which provide the greatest opportunity for creating “professional” effects—projection shots—animations—back-lighted titles—zooms, etc.

Any cine camera fits on the BROWN. Titles the size of a small calling card (2"x2 $\frac{5}{8}$ ") and small type up to large letter sizes on the

Designed for performance, and precision—made of quality materials—
It's fully guaranteed—so, when you get a title maker, get a BROWN

See your local dealer or write direct to:

AMERICAN BOLEX COMPANY
155 EAST 44th STREET
NEW YORK, N. Y.

Playtime is Movie Time



Get G-E PHOTOFLOODS and film priceless shots . . .

Some of the most priceless pictures you'll ever shoot are sequences of your children at play. Make sure of crisper, clearer pictures . . . **INDOORS.** Use G-E MAZDA Photoflood lamps to light the scene. These are the same high-efficiency type lamps that the big movie studios use . . . made to fit *your* needs. They are grand for color or black-and-white. Get some today and get better shots.

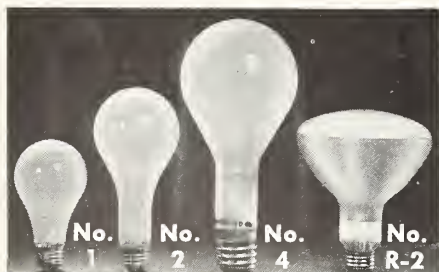

NEW LOW PRICES

G-E No. 1 . . . 15¢ G-E No. 4 . . . 1.20
G-E No. 2 . . . 30¢ G-E No. R-2 . . . 85¢
(a handy extra light)

GENERAL ELECTRIC
MAZDA PHOTO LAMPS

are taken. If 1 or 2 frames of each cartoon are exposed in the order 3-2-1, -3-2-1, etc., the bicycle will appear to go backwards rapidly. If several frames are exposed of one of the cartoons, the bicycle will appear to stop for a short time. Exposing one frame of each cartoon in the order 1-2-3, -1-2-3, etc., will cause the bicycle to go forward very rapidly. Experiment with all the possible variations of action, always keeping in mind the fact that 16 frames represent one second's projection time—8 frames equal one-

half second on the screen, etc.

The same rules apply to the other cartoons. Speed of the action is varied by the number of frames alternately photographed. Any desired pause in the action is accomplished by simply photographing one cartoon for several frames. The closeup of Miss Oliver has no motion and should be photographed so as to run about 3 or 4 seconds (48 to 64 frames). Next, the two cartoon closeups of Mr. Rooney are photographed 1, 2 or 3 frames at time, alternately,

for several seconds running time on the screen. Then go back to a short closeup of Miss Oliver and follow this with a short repeat scene of the two on the bicycle. This completes the first sequence.

The same rules apply to the second sequence—the Marx brothers. Expose the two cartoons of each scene alternately and for various speed effects. Make repeat scenes as desired.

Next month we shall present the second group of cartoons and titles and, the following month, the remainder of the series.

1940 Contest Winners . . . !

• Continued from Page 417

IES. This picture received Fourth Prize in the Documentary Class.

Sensitively planned it is superbly titled in verse with excerpts from renowned poems. This picture begins with spring planting and continues a record of home-spun scenes and events clear up to harvest time. Photography is excellent as is the editing. And from the first frame until the final fade-out, this effort is stamped unmistakably with a genuine creative spirit.

IN the Family Films Class, "Christmas Well Spent," filmed by Dr. J. Allyn Thatcher, D.D.S., of San Francisco, captured the first prize. No finer example of human interest in a Christmas picture has been seen in a long time. The story concerns two youngsters bent on buying gifts for their parents. Breaking open their pig bank, its contents are found lacking. They set out together to mow lawns and do other odd neighborhood chores to swell their shopping funds.

With a fair sum accumulated they set out on Christmas Eve to buy gifts, but find the wares offered by the attractive jewelry and camera stores far beyond their means. Of course, the dime stores supply the answer and they hurry home to wrap the gifts. Christmas morning they enter the living room, carrying their gifts to mother and dad much to the delight of all.

Christmas pictures may come and go; but for origi-

nality and artistry "Christmas Well Spent" will remain in a class by itself.

CHECKING Off the Budget" is another Movie of the Month to ring the bell in this contest, carrying off Second Prize in the Family Film Class. Regrettable is the fact space does not permit a more elaborate review, for "Budget" is one of the finest vacation films ever made.

Practically the first picture of any length filmed by Bruce Johnson, it displays an uncanny flair for originality, and a skill in filming interestingly what it takes to make a more than ordinary home movie. In short, "Checking Off the Budget" is an account of a vacation trip wherein a budget sheet plays an important part. Ere much of the trip is behind them, the Budgets find expenses far above those anticipated when the budget is planned, and Mr. Budget is frequently shown writing in a \$5.00 expense item where only a \$2.00 expenditure was planned.

Eventually they run out of cash, and at the insistence of carefree Mrs. Budget, they write checks for the remainder of the trip. Upon arriving home, there's an officer waiting to trundle Mr. Budget off to jail for issuing worthless checks.

The family name is saved, however, when Mrs. Budget rescues hubby from jail by making good the checks from a secret fund she had accumulated for the purchase of a new fur coat.

THIRD place in the class of Family Films went to Erma Niedermeyer of Milwaukee for her delightful picture, "Christmas Capers." An ambitious and consistent producer of good home movies, this is Miss Niedermeyer's latest cine production. It embraces the capers of a family at Christmas time. Each becomes overanxious to learn what Santa left in their respective stockings, hung over the fireplace the night before. One by one they arise before dawn and remove their gifts only to be startled by some other member of the family about to enter the room. Each one seeks refuge behind the living room divan and when the last member of the family enters and finds a live pickaninny in her stocking, they come from behind the divan and join together in a rollicking fadeout.

ONE of the most interesting pictures in the contest was "Cat Tales," filmed by Mildred J. Caldwell of Long Beach, Calif. This picture was awarded Fourth Prize in the Family Films Class and is an exceptionally well photographed account in color of the antics of a group of kittens. It is noteworthy for the artistic and colorful settings prepared for the kittens, and for the unusual arrangement of titles, some of which involved the appearance of one of the kittens.

Space does not permit at this time, an adequate ac-

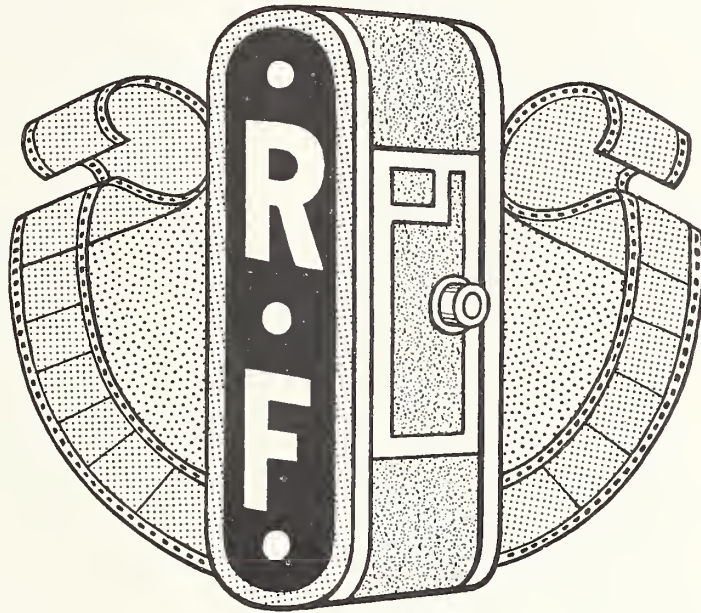

Emblem of the Reel Fellows— An Organization of Movie Amateurs

Within the next few months, this attractive emblem will shine from the coat lapels of thousands of amateur cinefilers the country over. It will appear a finely embossed insignia on the cameras of these cine fans, and again in special leaders attached to their films.

And the REEL FELLOWS—vast organization of movie amateurs—will be launched and well on its way, paying dividends in new acquaintances, new friendships, and a wider knowledge of amateur movie making.

REEL FELLOWS, sponsored exclusively by HOME MOVIES, will be a non-profit organization. Pins, camera insignias, and leaders will be made available at cost.

Every amateur cinefilmer will want to join the REEL FELLOWS. Every amateur cinefilmer is invited to become a member of the REEL FELLOWS. Complete details for membership application will be announced in October.



You Need

O'Sullivan Film Process

Now Available to
Professional and Amateur
Photographers

- Preserves Film Indefinitely.
- Adds Definition; prevents fading and bleeding on all color film.
- Impervious to heat, cold, moisture, dryness, oil and grease.
- Glass-like finish prevents sweating and rotting.
- Will not scratch, peel or blister.

Used Successfully for 14 Years
by Motion Picture Producers, film laboratories,
libraries, industrial manufacturers.

1 Reel 50 to 200 feet 8mm . . \$.50
1 Reel 200 to 1600 feet 16mm . . 1.50

See Your Dealer or Write to
O'SULLIVAN FILM PROCESS
5184 Santa Monica Blvd. Hollywood, Calif.

count of the merits of those films selected for Honorable Mention. However, we should like to touch upon the achievement awards, the first of which went to Dr. R. E. Gerstenkorn for photography in his very excellent documentary picture "The Cauldron," previously reviewed as a Movie of the Month.

Award for Editing went to A. O. Jensen of Seattle for his picture, "Driftwood," a scenarized movie in which appears a girl, Miss Arlene Osthoff, who is a sure bet for some Hollywood talent scout. Jensen's editing of this picture probably surpasses anything entered in the contest; and while it is highly commendable in other departments, still it lacked just enough to keep it out of the money in the regular Scenario Class.

The award for Sound went to Dan Billman, Jr., for the fine musical score of phonograph records prepared by him for showing

with his picture, "Black Cousins." In the closing sequences, the musical score of this picture increases its interest tremendously.

To Clarence Aldrich goes the award for Achievement in Titling for the splendid titles executed for his picture, "Susanna." A full account of his methods will appear in HOME MOVIES at a later date.

For Technical Achievement in the production of "Peetie," a 400-foot animated cartoon, Edmund Turner has been tendered a special award. This picture was reviewed in detail in the June issue and is an excellent job of animated cartooning for an amateur.

A special award was bestowed upon the Peoria Cinema Club, of Peoria, Ill., for outstanding achievement among clubs. This organization, as reported in the August issue of HOME MOVIES, conducts a School of Cinematography for its members which has proven

one of the most successful methods of holding a membership together as well as proving a valuable service to its members.

This particular award is to be perpetuated and made a part of HOME MOVIES' yearly amateur contest.

So many excellent films were submitted, that we should like to have awarded prizes to all. But none need become discouraged. For like Chester Glassley, who entered last year's contest with only nominal success only to "click" this year with one of the best films in the contest, every amateur has an equal chance.

Whether your picture is fifty or five thousand feet; or filmed on positive stock or Kodachrome; these details have no bearing whatever on the outcome. It's what you put into your picture in intelligent effort, originality, and artistry that counts. We sincerely hope every contestant will enter again next year.

Light, Lenses, in cine photography . . .

• Continued from Page 418

which is the unit of lens measurement. A dioptré is that power which is capable of focusing parallel rays of light to a point of 1 metre or 40 inches.

The same system by which dioptric values are given to lenses is used to determine the wave value of light so that it is easy to calculate the auxiliary lens values by the wave theory. Hence, a 1 dioptré lens will focus parallel rays of light at 40 inches (1 metre), while a 2 dioptré lens focuses the same rays at 20 inches, and so on. Here the same formula applies, dividing the dioptric value into 40 gives the focal length of the lens.

If we use a simple prism as an illustration, we find that incident light traveling through the prism is bent toward its base or thick edge. (See Fig. 4.) A convex lens therefore is a combination of prisms with their bases adjoining and with the dioptric curves added as in Fig. 5. Notice how the rays of light are bent toward the thickest portion of the lens to produce a focus. The greater the curve, the more abrupt

will the bending of the light be or the shorter the focus. In lenses of the simple type, there is considerable distortion or aberration at the edges, increasing with the degree of curvature. For this reason it is necessary to construct a lens system made up of several elements to offset this aberration in the strong lens units such as are used as standard equipment on our cameras.

Fig. 6 shows a lens system to illustrate this idea. A convex lens of a given density of glass is used as the first element (A) and because of the aberration at the margins, we place a concave lens of greater density next to it as the second element (B) to bend the rays back slightly before passing into the next element (C) which is also convex of the density of element A. In this manner both the chromatic and spherical aberration is greatly reduced although there is no method by which it can be eliminated entirely. In our standard lens systems, there is inserted usually between two of the elements the iris diaphragm which is primarily used to

cut out this distortion around the margins. This is the method by which we obtain depth of focus.

A simple experiment to prove the efficiency of the diaphragm may be made with any magnifying lens. Puncture a plain cardboard with a darning needle to produce a hole in the card a little larger than a pinhole. By holding the lens close to the eye and viewing some object across the room, it will be noticed that there is considerable blur, but by placing the card with the small opening flat against the lens and then placing it close to the eye the image will sharpen greatly. However, at the same time one can note that there is considerable light lost as the image will be sharp but not so bright.

This shows the need for increasing the light if small apertures are to be used to obtain definition. It also shows the value of stopping down the aperture in order to obtain a picture free from the marginal aberration. Considering that we are using a fixed focus lens system, the apertures are nec-



GOERZ

KINO-HYPAR LENSES

f:2.7 and f:3

For regular and color movies of surprising quality—high chromatic correction . . .

Focal lengths 15mm to 100mm—can be fitted in suitable focusing mounts to Amateur and Professional Movie Cameras.

GOERZ Reflex FOCUSER

— Patented —

For 16mm Movie Cameras—voids PARALLAX between finder and lens—provides full-size ground-glass image magnified 10 times. Adaptable to lenses 3" and up. Also useful as extension tube for shorter focus lenses for close-ups. Extensively used in shooting surgical operations, small animal life, etc.



GOERZ Parallax-Free FOCUSER and FIELD FINDER CONTROL

No more off-center pictures, for Filmo 121 and Simplex-Pockette magnifies 4 and 8x.

For Detailed Information Address
Dept. HM-9

C. P. Goerz American Optical Co.
317 East 34th St., New York

American Lens Makers Since 1899

essarily small to prevent the introduction of marginal distortion and if desired to use larger openings we must use focusing mounts to sharpen within critical adjustments the exact focal length of the lens in relation to the object to obtain a clear image.

If a camera lens is set for infinity, and it is desired to photograph an object 40 inches from the camera, we must use an auxiliary lens of 1 dioptré. If the object is 20 inches away, we use 2 dioptrés. For 13 inches we use 3 dioptrés. This in accordance with the system of the wave theory, is the artificial means of rendering those rays parallel before entering the lens of the camera. Many amateurs are bewildered many times about the proper placing of the auxiliary lens and for those who have not yet had the opportunity to experiment successfully with auxiliary lenses there is a little advice which may be well applied. The important factor to consider is the distance of the auxiliary lens to the object, computing it according to the above system.

Theoretically, it makes no difference how far back the camera lens is from the auxiliary as long as the distance

is correct from the auxiliary to the object. You will note that I say theoretically because it is not *practical* to have it too far away from the camera lens. The reason for this is that even though the focus will be sharp with the camera lens some distance back, there will be introduced reflections and highlights from the auxiliary itself. For this reason it is advisable to place the auxiliary as close as possible to the camera lens.

An experiment to prove this point may also be made with a simple magnifier. Place a magnifying lens at the proper distance from any object to bring it into sharp focus, standing it upright in a fixed position before a printed page will do. Now back up across the room to any distance and you will note that the object still remains sharp because the rays of light passing through are parallel. This is a valuable tip for those pictures in which you wish to show someone using a magnifier to view a specimen of interest. If the focal length of the magnifier is determined and the distance maintained from the object to be magnified then it can be photographed clearly.

Many amateurs obtain as-

Movie of the Month

Each month the Editors of HOME MOVIES select the best picture sent in for analysis and designate it "The Movie of the Month." This movie is given a detailed review and a special leader is awarded the maker.

This award does not affect the eligibility of such films for entry in the annual HOME MOVIES CONTEST. They are automatically entered for rejudging with those films submitted especially for the annual contest. Films awarded the honor of MOVIE OF THE MONTH during past 12 months are:

1939

OCTOBER: "Hummingbirds," filmed by Richard L. Cassell, D.D. S., Los Angeles, Calif. A 16mm Kodachrome film, 400 ft. in length.

NOVEMBER: "Esquire's Escapade," produced by Clarence M. Aldrich, Long Beach, Calif. A 16mm picture 800 ft. in length.

DECEMBER: "Souvenir," produced by Harold E. Remier, Hollywood, Calif. A 100-ft. 8mm Kodachrome film.

1940

JANUARY: "The Cauldron," produced by Dr. R. E. Gerstenkorn, Beverly Hills, Calif. A 16mm picture 400 ft. in length.

FEBRUARY: "Whistling Wings," produced by W. H. Nordin, Austin, Minn. A 16mm Kodachrome picture, 400 ft. in length.

MARCH: "Checking Off the Budget," produced by B. W. Johnson. An 8mm Kodachrome film, 1000 feet in length.

APRIL: "El Lobo," produced by Demetris Emanuel. A 16mm picture, 400 feet in length.

MAY: "From A to Z," produced by Vernon Altree, Stockton, Calif. A 16mm Kodachrome film, 400 feet in length.

JUNE: "Peetie," produced by Edmund Turner, Detroit, Mich. A 16mm Animated Cartoon, 400 feet in length.

JULY: "Song of the Soil," produced by E. C. Denny, Buffalo, N. Y. A 16mm Kodachrome film, 800 feet in length.

AUGUST: "St. Margarets," produced by Gordon MacCormack, Montreal, Canada. A 16mm Kodachrome film, 400 feet in length.

SEPTEMBER: "Angels Are Made of Wood," produced by Herman Bartel, New Rochelle, N. Y. An 8mm Kodachrome film, 200 feet in length. (Winner Lloyd Bacon Trophy, 1940 Amateur Contest.)

Movie Maker's Fine "Still" Camera

... gives you
color shots, too



KEEPING in mind its price . . . only \$14.50 . . . look what you get when you choose a Kodak 35, f/5.6:

A compact, convenient-to-carry little "still" camera that makes smart, splendid snapshots in black-and-white . . . and gorgeous full-color Kodachrome transparencies . . .

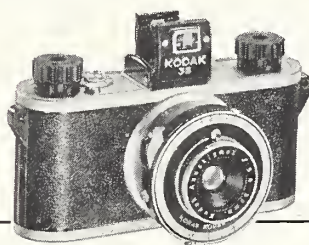

KODAK 35 (f/5.6)
only \$14.50

Sole leather field cases, \$4.50, \$6.50

You get a Kodak Anastigmat f/5.6 lens; 1/100 Kodex shutter; Eastman precision construction throughout . . .

You get fingertip focusing, from 4 feet to infinity; folding optical eye-level finder; automatic exposure counter; device to center film accurately for each exposure; one-piece bottom and back that slides off for easy loading . . .

And finally, though your black-and-white negatives are regular 35-mm. size (about 1 x 1½ inches), modern photo-finishing methods lead to big 2¾ x 4-inch prints. At your dealer's.

ONLY EASTMAN
MAKES THE KODAK

EASTMAN KODAK COMPANY, ROCHESTER, N. Y.

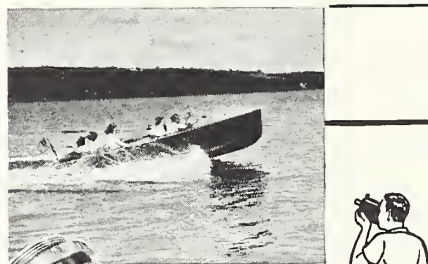

HAVE A
SPEEDY LENS
FOR COLOR MOVIES

f1.5

CINE VELOSTIGMAT HERE'S the lens to give you gorgeous full-detail color shots — indoors or out. A Wollensak f1.5 Cine Velostigmat is ultra-fast with plenty reserve speed to conquer adverse lighting—ideal for black-and-white woodland shots, evening scenes, dim interiors. Fine optics give rich, brilliant details. In 1" and 2" focus f1.5 for 16mm, ½" focus f1.9 for 8mm. Economical, too.

WRITE FOR
LITERATURE



WOLLENSAK OPTICAL CO.
511 Hudson Ave., Rochester, N. Y.

WOLLENSAK

Filmo
Movie Equipment
Does Not Limit
Your Skill!

FILMO movie equipment imposes no restrictions upon your skill. The more advanced you become, the better the basically complete Filmo serves you. There are no limits to quality or variety of movies it lets you make. That's why Filmo owners are satisfied owners.

Make your next movie purchase a Filmo. Write today for free literature describing cameras, 8 mm., 16 mm., or 35 mm.; projectors, sound or silent; or any particular accessory in which you are interested. Most literature is in interesting, illustrated booklet form. Write for information today. Bell & Howell Company, 1825 Larchmont Ave., Chicago; New York; Hollywood; London. Since 1907 the largest manufacturer of precision equipment for motion picture studios of Hollywood and the world.

PRECISION-MADE BY

BELL & HOWELL



Thalhammer Easel Tripod with Projection Platform

This Single Tripod is a PROJECTOR TABLE— CAMERA TRIPOD— and EASEL SUPPORT

By attaching a hardwood veneer Projection Platform the Thalhammer Easel Tripod serves as a vibrationless, rigid table for portable projectors. Equipped with a Professional Tilthead, it becomes a sturdy studio tripod. With other attachments it is an excellent Artist's Easel Support. This strong, "Rigidized" tripod stand is adjustable to any height from 40 to 60 inches, and locks positively in position. Sure-Foot Points provide a secure grip on any surface. Price with Projection Platform \$22.50; with Professional Tilthead, \$32.50.

See It at Your Dealer's Today



THALHAMMER CO.

1015 W. 2nd St. • Los Angeles, Calif.

TURRET

For Your

KEYSTONE "8"

Including Wollensak Telephoto in focusing mount.

1 1/2 in. F:3.5.....\$42.50

1 in. F:2.7.....\$42.50

1 in. F:3.5.....\$34.50

Windback and hand crank, \$15.00

Money-Back Guarantee

Write for Details

**CUSTOM-BUILT
CAMERA ACCESSORIES CO.**

4124 Rawlins

Dallas, Texas



**GET OUR PRICES FIRST
BEFORE YOU BUY ANY
MOVIE EQUIPMENT**

U. S. MOVIE SUPPLY

7420 West 7 Mile Road
Detroit, Michigan

sorted lenses from various sources and could use them for auxiliary lenses if they could only compute their power. Simple spectacle lenses or inexpensive magnifying lenses are often satisfactory if properly used. There is a simple method of computing the power in order to place it at the proper distance from the object to make it serve as an auxiliary lens. To determine the focal length of a lens we are trying to find out at what distance it will focus parallel rays of light. Hold a white card in one hand and cast an image upon it by holding the lens in the other hand until the image is the sharpest obtainable and free from blur. The object should be at infinity, however, and because of this it is well to focus the rays of the sun. When the image upon the card is sharp, measure the distance from the lens to the card, which is the focal length. With this distance determined, place your auxiliary lens close to the camera lens which should be set for infinity and you are then

ready to photograph any object at that same distance.

In theoretical discussions, we hear much about the circles of confusion. This is an imaginary abstract term to most amateurs and is seldom understood thoroughly. The circle of confusion can be actually seen by a simple experiment and more properly understood. To prepare for this experiment, place four lighted candles in a row, spacing them about an inch apart. Have the room darkened sufficiently to cast a focus of the lighted candles upon a white card by the use of an auxiliary lens. While the images will be inverted, get them in sharp focus by moving the lens back and forth. Now that they are in sharp focus, slowly move the lens forward until the candle flames swell into small circles. By continuing to move the lens forward, you will note that the circles begin to overlap, destroying the detail of their own image as well as the one next to it. It finally becomes such a blurred mass that one could not determine what the image

represents. This shows why sharp focus must be maintained within the tolerance of the circle of confusion for that particular lens. It explains also why we cannot take a blurred picture (out of focus) and sharpen it in projecting by refocusing. If the circle of confusion is destroyed in taking the picture, it must remain blurred.

Many amateurs have tried to sharpen a picture on the screen, using the logic that if the focus was deficient in photographing, it should be possible to compensate for that blur by bringing it back with the projection lens. Unfortunately this is not possible, as the blur on each point of focus represented by the circle of confusion, remains in the picture exactly as photographed. This is an effective method of considering the importance of care and patience in properly applying auxiliary lenses. We shall later deal with advanced lens study and consider the more common adjustments of camera equipment.

Gear Box for Glorified "16"

• Continued from Page 427

together and drill the holes with a No. 43 drill. The top plate is then taken and placed on top of the aluminum spacer and the same holes drilled through it. Lightly countersink each hole on both sides of the spacer, then tap for 4-36 thread.

Take the two steel plates and redrill the screw holes with a No. 32 drill and countersink front and back plates for a 4-36 oval head screw. The plates are now ready to be screwed to the spacer using 4-36 by 1/4" ovalhead screws.

Fig. 7 shows layout for holes to be bored through plate for the gear axles. It will be noted that only points "A," "C" and "E" have dimensions shown, "B" and "D" being omitted. This is because it is rather difficult to accurately show measurements from the side of the case or between the holes, as a difference of 0.010 inch might present considerable trouble in the meshing of the gears.

Before proceeding further

perhaps it might be well to become a little more familiar with how gears work. There are many kinds of gears—round ones, square ones, oval, oblong, eccentric, etc., some of which perform items of almost unbelievable possibilities. However, all used here are round and will present little or no trouble.

Gears are spoken of in terms of pitch diameter—that is, the number of teeth per inch of diameter. If a gear has 16 teeth in it and the distance from half the height of one tooth across the center of the gear to half the height of the tooth on the opposite side is one inch, it is known as a 16-pitch or has a pitch diameter of 16. Should the distance be only 1/2 inch, the pitch diameter would then be 32. This would mean that the teeth would be half the size or twice the number, hence 32.

The gears used in the effects box are of a 48 pitch; knowing this, it becomes a relatively simple matter to find the distance between

two gears only by knowing the number of teeth. Knowing the pitch and the number of teeth, one can find the pitch diameter by dividing the number of teeth by the pitch.

Example: Pitch 48, teeth 48; $48 \div 48 = 1$, or pitch diameter of 1 inch. Should two such gears be placed together, the distance between their centers will be exactly 1 inch.

Example: Pitch 48, teeth 24; $24 \div 48 = 1/2$, or pitch diameter of 1/2 inch. Placing a 48-tooth with a 24-tooth to find the distance between centers will be— $1/2" + 1" \div 2 = 3/4"$ between centers. Thus it becomes a relatively simple matter to find the correct distance to place an intermediate gear between two given distances where other gears are placed.

Fig. 10 shows the actual placement and size of gears used in the case. This showing will simplify matters so that a better understanding will be gained in observing

Quality Bulk Movie Film

8mm • 9½mm • 16mm • 35mm

Complete New Reversal and Title Instructions Free with Film Orders. Separately, 25c each. Cash, check or money order for quick service. Deposit \$1.00 required with C. O. D. orders. Special delivery, 15c; air mail, 50c extra. Overpayments refunded or credited.

SUPER CINEPAN PLUS REVERSAL
Speed 50-40 - Non-Halation Base

	400 ft.	100 ft.	33 ft.
Double 8	\$13.50	\$3.85	\$1.45
Single 8	7.00	2.15	.80
16mm	12.50	3.50

SUPER CINEPAN REVERSAL
Speed 24-16 - Non-Halation Base

	400 ft.	100 ft.	33 ft.
Double 8	\$12.00	\$3.35	\$1.25
Single 8	6.50	1.90	.70
16mm	11.75	3.25

CINEPAN REVERSAL
Speed 12-8 - Non-Halation Base

	400 ft.	100 ft.	33 ft.
Double 8	\$11.50	\$3.25	\$1.25
Single 8	6.20	1.80	.65
16mm	11.25	3.15

CINECHROME REVERSAL
Speed 8-2 - Non-Halation Base

	400 ft.	100 ft.	33 ft.
Double 8	\$ 5.75	\$1.75	\$.75
Single 8	2.50	1.15	.50
16mm	2.25	1.10

SPEED 8 SEMI-ORTHO REVERSAL
Speed 8-2 - Non-Halation Base

	400 ft.	100 ft.	33 ft.
Double 8	\$ 4.00	\$1.50	\$.60
Single 8	2.75	1.00	.40
16mm	4.00	1.15

Clear, Lavender, Amber, Blue, Yellow in 16mm. Only Clear and Lavender 8mm Scored. Daylight Loading with Processing Included for Bulk Films, add amounts given below, per roll.

Double 8mm, 65c Single 8, 35c 16mm, \$1.50

CINE-KODAK POSITIVE TITLE FILM
Darkroom Loading, Laboratory Packed

	400 ft.	100 ft.	33 ft.
Double 8	\$ 4.10	\$1.35	\$.60
Single 8	2.15	.90	.40
16mm	4.00	1.00

Clear, Purplehaze, Yellow, Red, Amber, Special Blue. Also DuPont Lavender, Pink, Light Amber.

CAMERA SPOOLS WITH CANS—Each

Double 8	35	Keystone St. 8	35
Univex 8	20	16mm, 50 ft.	60
Filmo St. 8	50	16mm, 100 ft.	60

EXTRA CANS, Double 8 and Straight 8 size, .05
100 ft. and 50 ft. 16mm size, .10
Non-Humidor, 400 ft. 20c, 6 for, 1.00

PRECISION PERFORATING
16mm Films for Use in Double 8 Cameras
50 ft., \$1.00 100 ft., \$1.50 400 ft., \$4.50
Satisfactory in all cameras except Keystone K-8

MISCELLANEOUS

BALA Precision All Metal 8mm Shtter	\$2.50
FOTOFADE DYE, for making Chemical Pades	1.00
FOTOFADE WIPE-OFF TAPE, per roll	.60
CINETINTS, 6 Colors and Instructions	3.00
DUPONT VSCOSE SPONGES, each	.35
HOW TO TITLE HOME MOVIES, book, each	1.00
HOME MOVIES, Back Issues, 1936-37-38-39	.15
Back Issues, 1940, each	.30
TITLE DEVELOPER, tubes, each make 16 oz.	.15

FILM PROCESSING—PER ROLL

	Reversal	Title Developing
	100 ft. 33 ft.	100 ft. 33 ft.
Double 8	\$2.00 \$.65	\$1.75 \$.75
Single 8	1.00 .35	.75 .40
16mm	1.50 .	1.25 .

WE STOCK EVERY MAKE FILM
Write for Complete NEW Price Lists
A PERSONAL MOVIE SERVICE
Telephone Lincoln 1207

W. STUART BUSSEY FILM LAB.
17 E. St. Joseph St. Indianapolis, Ind.

how the placements are fold-
ed when in the case. Point
"C" is a 16-tooth gear on
the end of the shaft that
comes from the bevel gears.
Points "B" are two sliding
shafts. The upper one which
drives the main footage
counter slides back and
forth so that the counter
may be reset to zero. Point
"D" is an intermediate idler
gear which in turn drives
"point "E," or the effects
shaft, while the lower point
"B" serves to start and stop
point "E" at will.

GEAR REQUIREMENTS

Points	Gear No.	Teeth	Pitch Diameter
A	G-137	26	0.541"
B	G-137	26	0.541"
B	G-138	32	0.666"
C	G-132	16	0.333"
D	G-130	4	0.292"
D	G-142	48	1.000"
E	G-142	48	1.000"

With this data one is now
able to find the intermediate
points "B" and "D" shown
in Fig. 7. Between points A
and B it will be noted from
Fig. 10 that two 26-tooth
gears mesh. Adding their
two pitch diameters together
and dividing by two gives
0.542". Set a pair of divid-
ers to 0.541" and with one
leg at point A, scribe a circle.

How Can I Improve Film?

• Continued from Page 426

him in his work. A union
man calls out a picket line
against him. He is obliged
to take refuge in a tree and
when his girl friend at-
tempts to pass a piece of
cake to him, he drops the
plate upon her giving her a
blackeye. The girl's brother
then threatens to beat him
up and parades back and
forth beneath the tree, wait-
ing for him to come down.
When he does, there is a
chase, ending in the artist's
capture. The girl comes to
his rescue as he is receiving
a pummeling at the hands
of her brother.

The brawl ends, all eat
their lunches, and every-
body seems to be happy.
Then a little girl enters the
scene, bringing the artist's
sketch. There is a fade to a
scene within an art gallery.
And then we find the art-

Between points B and C
is a 16-tooth gear meshing
with a 32-tooth gear. Add
their pitch diameters to-
gether, 0.666" and 0.333",
which equals 0.999", divid-
ed by two is 0.4995" or ½".
Set the dividers to ½" and
with one leg at point C,
scribe a circle. Where the
two circles cross determines
point B. Follow this same
procedure to determine
point D.

Fig. 12 shows the gear
box unit before assembly
with the front and back
plates, the spacer plate and
all the necessary gears and
screws, but not the gear
spindles. Next month we
shall picture and describe
method of assembling the
gears and of mounting the
frame counters to the com-
pleted gear box. (This is the
third of a series of articles
on the "Glorified 16," which
describes how amateurs
may add a series of gadgets
to the series No. 70 Filmo
for making wipe-offs and
dissolve effects. Copies of
issues containing the first
and second articles are avail-
able.—EDITOR.)

ist's sketch on display, and
the artist proudly parading
before it with chest thrown
out and a conceited expres-
sion on his face. The girl
enters the scene. Proud of
his artistic accomplishment,
she throws her arms about
the artist, striking the pic-
ture with her arm, causing
it to come crashing down
upon the artist.

The picture closes with a
closeup of the picture frame
about the artist's neck.

Comedies are the most
difficult of pictures for ama-
teurs to make as so much
depends upon clever acting.
When such pictures are
undertaken, for the most
part they should be kept
right down to fast action.

In this instance, it was
felt that the first part of the
picture was over-done. If
the very first scene of the

GREAT VALUES OUT OF NEW

Free

LAFAYETTE CATALOG

FILM CEMENT

1 oz. bottle 18c 4 for 69c
½ oz. bottle 9c 4 for 29c



CRYSTAL BEADED SCREEN

This practical, easily handled
30 x 40 crystal beaded screen
features a complete lack of hal-
ation from front or sides. Has 4
times the reflectibility of an
ordinary screen. Roller type.
Metal post support.

ONLY \$4.49

REELS AND CANS
Reel values! Made of heavy alum-
inum. Patented sprocket device
accommodates every type reel
arm. Humidors of heavy gauge
aluminum.

8 mm. Reel 29c Each
8 mm. Can 6 for 1.69

16 mm. Reel 39c Each
16 mm. Can 6 for 2.27

REEL CLIPS
8 mm.—6c ea.
12 for 67c
16 mm.—8c ea.
12 for 89c

CLIP YOUR ORDER TO COUPON

Save time and money! Just enclose this
ad, or any part, or note attached to
coupon, along with your check or money
order. Mark each item you desire and
mail today.

ALL MERCHANDISE GUARANTEED

FILM STORAGE CHESTS

8 MM.
6-Reel Capacity \$1.85
12-Reel Capacity \$2.55
16 MM.
6-Reel Capacity \$2.25
12-Reel Capacity \$2.95



ORDER NOW!

SEND FOR BIG FREE CATALOG!

IT'S BRAND NEW!

A whole book of great values in photography!
Complete, up-to-the-minute, packed with all the
latest nationally advertised cameras and equip-
ment. It's money-saving! Send coupon for your
FREE copy at once!

Lafayette Camera

NEW YORK
CHICAGO
ATLANTA
BOSTON
NEWARK
BRONX, N. Y.
JAMAICA, L. I.

LAFAYETTE CAMERA
DEPT. 80J—100 SIXTH AVE., NEW YORK, N. Y.

I ENCLOSE \$ RUSH MY ORDER
 PLEASE RUSH FREE CATALOG No. 81.

NAME
ADDRESS
CITY STATE

CHART OF TITLING EXPOSURES

FILM SPEED (Weston Mazda):	16	8	6	5
One No. 1 Photofood in Reflector..... 9 inch from Title Board	F/10	F/7	F/6.3	F/5.6
Two No. 1 Photofoods in Reflectors..... 12 inch from Title Board	F/11	F/8	F/7.0	F/6.3

Something New and Novel for

HOME MOVIE-MAKERS

Professional Hollywood
Manuscripts for Amateur
Cinematographers

Ideas and Stories for Every Family
Occasion in Standard "Shooting"
Continuities, Simplified

With FILMED TITLES, ready to splice in;
complete sets of TITLE CARDS, ready for
home filming; YOUR NAME on a Pro-
duction Title Card; and CLEVER SMALL
"PROPS" to double your fun, ALL AT NO
ADDITIONAL COST!

Send 10c today for a special Screen-
Credit Title Card, bearing your name
as producer or cinematographer, and
ready for home filming.

And See Our Catalogue

Home-Movies Script Service

P. O. Box 1218 (Dept. 3)
SAN FRANCISCO, CALIFORNIA

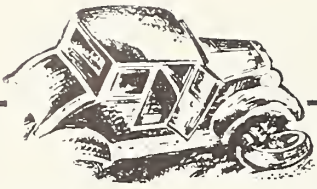

YOUR CAR NEEDS ALL 4 WHEELS

• And your motion picture films need all 4 FEATURES of ADEQUATE FILM PROTECTION.

1. INTERNAL SOFTNESS
To resist heat and dry air.
2. EXTERNAL TOUGHNESS.
To resist scratches and stains.
3. SURFACE LUBRICATION.
To resist wear and sprocket-strain.
4. PERMANENT IMPREGNATION.
To resist loss of protection in cleaning.



Any three features without all 4 are no better than three wheels on your car. Genuine impregnations, with SEPARATE chemical vapors, each doing its SEPARATE job, give you effective 4 FEATURE FILM PROTECTION against CLIMATE, WEAR, SCRATCHES, OIL, DIRT, WATER and FINGER MARKS.

Better Photo Finishers Offer VapOrate protection for still negatives.



VAPORATE CO., INC. 130 W. 46th St. New York City
BELL & HOWELL CO. 1801 Larchmont Chicago 716 No. La Brea Hollywood

\$1250 BEADED SCREENS NOW \$495

New 30"x40" 3-way tripod screens by well known manufacturer. Stand on tripod, hang on wall, or use with easel on table. Black crackle finish, dustproof metal case. High quality crystal beaded surface with black border. Slight imperfections, hardly noticeable, guaranteed not to impair projection qualities. Otherwise perfect condition. Only 97 available at this give-away price. Your chance to get a QUALITY SCREEN at a spectacular saving. Order today direct from this ad. F. O. B. Chicago. White 50 Wall Models Last \$2.95 Each

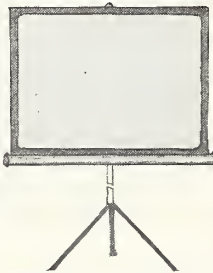

COMPLETE WITH TRIPOD TABLE EASEL WALL CASE Made to sell for \$12.50

Send For Free Circulars on Bulk Movie Film . . . Processing Service . . . Home Movie Equipment and Supplies
SUPERIOR BULK FILM COMPANY
"Home Processing Headquarters"
Dept. HM 9 188 W. Randolph St. CHICAGO

BETTER MOVIE FILM 8MM at LOW COST 16MM

4-Star Reversal Processing gives results identical with more expensive film. Done in a modern Hollywood laboratory by Film Studio Experts. Thermomatic development control of each individual roll is your assurance of snappy, sparkling pictures. No need to pay more for film when 4-Star Processing gives you the best results.

REVELATION No. 1		REVELATION No. 2	
Semi-ortho		Panchromatic	
Daylight 12	Daylight 50 - Tungsten 20	30' single 8mm . . . \$1.00 ea.	30' single 8mm . . . \$1.00 ea.
25' double 8mm . . . 1.50 ea.	25' double 8mm . . . 2.00 ea.	50' 16mm 1.75 ea.	50' 16mm 2.75 ea.
100' 16mm 3.00 ea.	100' 16mm 4.50 ea.		

2 rolls or more each item, 10% discount.
Including 4-Star Reversal Processing and Postage
Postpaid—order now! C. O. D. orders, postage extra.
Remit 1/3 with C. O. D. orders. (Calif. buyers include sales tax.) Save Money—Load Your Own 8mm-Bulk Film-15mm. Prices on request.

☆ PACIFIC COAST FILM CO. ☆
1510 No. Sierra Bonita Hollywood, Calif.

artist painting could be eliminated and a retake made showing artist and the girl starting out on a picnic and a day of sketching, followed by sequences in which they find themselves in the midst of the picnickers, the story would move faster and arrive at the essential part much quicker.

Editing: The outstanding part of this picture is its technical side—the editing, titling, and photography. The chase scene was a bit over-extended. Recommend would be a closeup showing the artist's feet tripping followed by a long shot showing him sprawled on the ground.

Titling: All titles were well composed and excellently photographed.

Photography: Is above average with "on the nose" exposure and a good steady camera evident throughout.

Equipment: Two cameras were used — an Eastman "K" and a Victor No. 4. Also used was a tripod, exposure meter, regulation makeup, and Super X film.

"SONG OF AUTUMN" ★★★
125 ft. 8mm Kodachrome
By C. C. H., Illinois.

Continuity: This is a cine story of the startling colors that autumn brings to foliage. Fortunately, this filmer did not restrict his filming to static shots of trees, leaves, and shrubs to tell his story. He introduced people into the picture at frequent intervals to give added interest. They are not too

closely associated with the story, but come into the picture frequently — sometimes just their feet walking through a mass of colorful leaves, or perhaps just their hands and arms handling the boughs of trees or shrubs.

At still another point, people enter the scene and are pictured preparing a picnic luncheon amid a background of colorful trees. The story ends with scenes of leaves being raked into piles and burned.

Editing: This is a well cut picture. It moves from scene to scene just rapidly enough to hold good interest. Notable was the intercutting of the closeups of feet tramping through the leaves, then from the leaves to the trees, etc.

Photography: Commendable is the good exposure throughout and fine framing of scenes. We liked the shot of the people eating where the branch of a tree was used in the foreground and yet the people were clearly visible at a medium distance. Ordinarily, this shot might have been made with the colorful foliage in the background. Reversing the order of things in this instance was good cinema and lent artistry to the picture.

Titling: Main title was photographed over a colored photo of wild ducks in flight. Opening rolling or "scroll" title was typewritten, well worded, and almost poetic in description.

Home Processing . . .

• Continued from Page 425

There are 10 cross members 1 inch wide, spaced with pegs of stainless steel, as may be seen in Fig. 2. These pegs or "dividers" prevent the film from overlapping during the processing operations. The shaft of the drum rests in brass bushings which insures smooth action at all times. This drum is rotated by means of a one-sixth horsepower electric motor and the reduction drive shaft as shown in Figs. 1 and 2. Without the motor, of course, the drum may be rotated by means of a hand crank; but the motor drive really pays for itself in the

end. It leaves you free to better inspect the film or to attend to other details during the processing period. Another important feature of this construction is that but three pints of solution are required.

For those amateurs who already have attempted the processing of home movie films, interest in this home processing equipment may end here; but for the amateur on the verge of entering this new and fascinating phase of home movie making, we shall proceed to describe the use of this equipment and give a brief

100 ft. — 16mm

THRIFTY FILMS

\$160

Thrifty Films save you 50% on your film cost. Three splendid films to choose from—each a leader in its class. And now the surprise—look at these prices!

THRIFTY ORTHOTYPE \$160
For OUTDOOR . . . non-halation base, fine grain, fast—the film you've been wanting to find at an unheard-of low price. Machine processed. Per 100 ft. rolls.....

THRIFTY PANCHROMATIC \$3.75
Use for all types of shooting. High-speed Weston 16 daylight—10 photofoods, machine processed. Per 100 ft. rolls.....

THRIFTY SUPER-PANCHROMATIC \$4.25
Super-fast; high sensitivity, requiring minimum of light. Weston 50 daylight machine processed. Per 100 ft. rolls.....

THESE PRICES INCLUDE EVERYTHING

Daylight loading, processing, and return postage. All films are machine processed.

You Wonder Why Our Prices Are So Low?

Because our sales are direct from manufacturer to consumer. You save the sales commission paid the distributor, jobber, and the retailer. This means a 50% saving to you without sacrificing quality in any way. Order immediately and enjoy your camera—in the thousands of fans who are availing themselves of Thrifty savings.

California Buyers Please Include Sales Tax
Sold and Processed Only by

THRIFTY FILMS

Drawer 98, Watts Station Los Angeles, Calif.

HOME MOVIE-MAKERS: They made "GRAPES OF WRATH" in Hollywood, and now, at your home, YOU can film

Shapes of Bath

And you'll have an uproariously funny motion picture of a rendezvous with the **Bawth**, exposing what **shape** your home folks are really in! You film from a professional script, written exclusively for amateur cinematographers, and we furnish filmed main title and ending, all ready to be spliced in, plus 12 title cards, ready for home photographing—this whole service complete for only \$2.

SEND TODAY FOR OUR FREE CATALOG OF OTHER SCRIPTS, ALL DESIGNED TO DOUBLE THE FUN OF MAKING HOME MOVIES.

And while it's still good weather, why not stage the most unique and laughable picnic of your life by filming our script, "WHAT A PICNIC!" Send \$1 today for this script. Filmed main title, ready to splice in, and 5 title cards you can film, go with this one at no extra cost.

WRITE US about our special service in writing scripts to your order, based on your own ideas and to fit the personalities of your own folks. Novel plots and new shots.

Home-Movies Script Service

P. O. Box 1218 (Dept. 2) San Francisco, Calif.

Your Own Metal Title Letters

Ask for Samples of the Most Beautiful Capital and Lower Case Letters Made

Title your films with METAL Letters Professional EASY

Complete Sets in Wood Case, 222 Pcs. . . . \$7.16
126 Caps Only . . . \$4.28
AN INTERESTING ADDITION TO YOUR MOVIE HOBBY
Specify White or Black Letters
KNIGHT & SON, INC. P. O. Box B, Seneca Falls, N. Y.

description of the home reversal process.

With the lights extinguished, the film is wound upon the drum. Any of several expediences may be used to fasten the end of the film to the drum, most of which have been illustrated and described in previous issues of this magazine. I fasten a rubber band to the end of the film by forming a small loop at the end and closing it with a small stapling machine. The rubber band is then fastened to a hook on the side of the drum, and serves to apply just enough tension to the film to keep it taut during processing. After the film is completely wound on the drum, the end is fastened to a rubber band, as explained before, and this is made fast to another hook on the drum.

Just before the end of the film is reached, it is advisable to clip a short length—say about 12 or 15 inches, to be used as a test strip. On the worktable should be placed four water tumblers, a photographic timing clock, thermometer, small flashlight, and last but really indispensable, a work sheet (see Fig. 3) for keeping a record of the tests. The test strip processing must also be done in darkness. Separate the 12 or 18 inch strip of film into four equal parts and number each 1, 2, 3, and 4, respectively. With a stapling machine this can be done by clipping one, two, three staples, etc., to the strips thus numbering them in a manner that enables identifying them readily in the dark.

Now, into each tumbler, pour a quantity of developer. Place No. 1 test strip in No. 1 tumbler. With the aid of the time clock and at the expiration of one, two, and three minute intervals, place the other three strips in the three remaining tumblers. When a total of six minutes has elapsed since the placing of No. 1 strip in developer solution, remove all test strips. Wash them thoroughly and continue the reversal process, putting the films through the subsequent steps of bicromate bath; wash thoroughly; bisulphite bath; wash thoroughly; redevelop; and wash. After the strips have been in the bicromate bath two minutes, bright lights may be turned on. At this

ENTERTAINMENT
16MM
SOUND ON FILM
EDUCATIONAL

The **TREND**
calls for
COLOR FILMS

in 16mm
Sound and Silent

The expanding Gutlohn color film library has recently added the following subjects: EAST COAST OF SOUTH AMERICA, WEST OF THE ANDES, THE LESSER ANTILLES, one reel each—silent. SINGAPORE and JAVANESE ENCHANTMENT, two reels each—silent. BALINESE RHAPSODY, one reel—silent. Other new releases are: WALTZ OF THE FLOWERS and JEFFERSON AND MONROE, one reel each—sound.

JUST OFF THE PRESS!

A comprehensive folder in color, descriptive of our library of 16mm color films, sound and silent. Yours for the asking.

1500 subjects available for rental or sale to home users. Send for catalog.

WALTER O. GUTLOHN, Inc.
35 W. 45th St., Dept. B-9, New York

SOLAR
Movie **FILM**

BUY IT AT YOUR DEALERS

	Weston	16mm	16mm	8mm	Dbl.
	100 ft.	50 ft.	25 ft.	25 ft.	
Solar ECONOMY Outdoor . . . 8	\$2.50	\$1.75	-----		
Solar SUPER Outdoor . . . 12	2.95	1.95	\$1.39		
Solar HI-SPEED . . . 24	5.50	3.25	2.00		

Prices include processing at the SOLAR processing station nearest you, per list enclosed with each roll. One of these processing stations is less than 24 hours from 90% of all movie camera fans in the U. S. Films are returned to you postpaid. If more convenient, order film from this ad and mention your dealer's name. Sold by over 300 leading dealers in 49 cities. Descriptive circular **FREE** upon request.

Dealers Wanted
Write Quick

Solar Cine Products Inc.
3827 Archer Ave. Dept. 1A
Chicago, Illinois



FILM LIBRARY

SEND NOW FOR ZENITH'S
NEW 1941 CATALOG—

containing scores of new comedies, travelogues, and current event pictures—in 8, 16mm silent and 16mm sound. For rental and outright sale. Write now for your copy.

OUR STUDIO is completely equipped for editing, titling, cleaning and Vaporating your films.

COMMERCIAL MOTION PICTURES

With over 16 years' experience in filming 16mm professional pictures, our staff is able to solve your picture problem at either factory, wedding, or social function.

Get on Zenith's Mailing List by Writing Now for Zenith's New 1941 Catalog (Available—End of September)

ZENITH CINEMA SERVICE
5011 N. Sawyer Ave., Chicago, Ill.
"Fine Movies Since 1924"

25¢ Kodak Finishing 25¢
Any 6 or 8 exp. roll dev. and printed for only 25¢. Quality guaranteed. None finer. Bring in or mail.

Extra Prints—122 or smaller, 3c each, 35mm enlarged to 4x5, 5c each. Write for complete price list.
THRIFTY PHOTO SERVICE
10364 State Street Lynwood, Calif.

stage in the process, check temperature of the developing solution in the tumblers and note same on work sheet.

Next remove the test strips and select the one which shows the most satisfactory results. The number markers—in this case the staples—will identify each strip. Note on the work sheet length of time the selected strip was immersed in the developer.

With the correct temperature and developing time thus determined, processing of the film, now on the drum, may proceed. And this brings us to the subject of formulas and method of processing:

DEVELOPER

Sodium Sulphite . . .	60	Grams
Elon	2.5	Grams
Hydroquinone . . .	10	Grams
Sodium Carbonate . .	48	Grams
Potassium Bromide . .	1.5	Grams
Water	1	Quart

Develop for six minutes at 65 degrees, then wash film thoroughly for at least five minutes in clear, running water.

BLEACH

Potassium Bichromate	7.6	Grams
Sulphuric Acid	10	CCs
Water	1	Quart

Bleach film for five minutes, then wash in running water until clear.

CLEARING BATH

Sodium Bisulphite . . .	23	Grams
Water (32 ounces) . . .	1	Quart

Clear film five minutes. Wash thoroughly. Flash film with No. 1 Photoflood one minute. Redevelop for five minutes with first developer. If the above has been carried out as specified, hypo will not be necessary. After this has been completed, in case the film is weak or has been over-exposed, use the following formula:

Potassium Bromide . . .	7.5	Ounces
Mercuric Chloride . . .	7.5	Ounces
Water	32	Ounces

Bleach until film is thoroughly white. Wash and redevelop.

If under-exposed or too dense, bleach with the following formula:

(a) Potassium Ferricyanide25	Ounce
Water	32	Ounces
(b) Hypo Crystals	6.75	Ounces
Water	32	Ounces

Immerse film in A until reduction is sufficient; then immerse film in B for five minutes and wash.

It is important that all solutions—including wash water—be maintained at the proper temperature established by the test strip processing.

DU PONT
REGULAR
PAN

W. JEAN ROMAIN

16 MM Fills Your Screen with Sparkling Movies

Brilliance—Regular Pan "puts sunshine in your movies". Removal of the non-halation backing in processing clears the film so the maximum amount of light passes through when projecting.

Speed—For outdoor movies, the speed of Regular Pan fits the "f" range of your lens. Bright scenes take your smallest opening.

Pan Sensitivity—Regular Pan is sensitive to light of all colors. You can use it with filters, or to take pictures in the reddish light of early morning and late afternoon.

Double Economy—The budget price of Regular Pan stretches a dollar over more feet of film. The wide exposure latitude gives you more good scenes per roll.

DU PONT FILM MANUFACTURING CORP., INC.
9 ROCKEFELLER PLAZA NEW YORK, N. Y.

\$4.50
100 Feet includes Reversal Processing

Take Your MOVIES with



Write Today for Free Offer—Limited
A FULLY GUARANTEED PRODUCT
 It is easy to take GOOD PICTURES with
MOVIE MASTER CAMERA FILMS
 FAST PROCESSING SERVICE

	100 ft.	50 ft.
Movie Master Ortho.....	\$2.50	\$1.50
18 Scheiners, Weston Daylight 8		
Movie Master Panchro.....	\$4.25	\$2.50
23 Scheiners, Weston Daylight 24, Tungsten 16		

Complete Assortment of 16mm and 8mm Subjects
 Prices and Catalogue on Request

MOVIE MASTER FILM CO.
 Ridgefield Park, N. J.

DO FILTER FACTORS FLOOR YOU?

...then ask about the new **HARRISON Durafine FILTER SET**—4 Filters, a Holder and Shade to meet 99% of all your requirements. With compact leather case—Easy instructions. New low prices. See them at your dealer today! ...Or write for folder.

HARRISON & HARRISON
 Optical Engineers
 8351 SANTA MONICA BLVD. HOLLYWOOD, CALIF.

FINE MACHINE WORK

We install backwinds on Eastman, Bell & Howell, Keystone, Univex, Victor, Revere, and other cameras, and install frame counters on other backwinds. Backwinds from \$10.50 up.

Turret installations of Filmo Double 8, \$28.75. Victor Model 3, \$30.50, and on others at proportionate prices.

Special Apparatus and Lens Alterations

MacVAN MFG. CO.
 3829 EL CAJON SAN DIEGO

25¢ Kodak Finishing 25¢

Any 6 or 8 exp. roll dev. and printed for only 25¢. Quality guaranteed. None finer. Bring in or mail.

Extra Prints—122 or smaller, 3¢ each. 35mm enlarged to 4x5, 5¢ each. Write for complete price list.

THRIFTY PHOTO SERVICE
 10364 State Street Lynwood, Calif.

Patents and Trade Marks

Patent and profit by your inventions. Protect your most valuable assets... Expert personal service.

LESTER L. SARGENT
 Registered Patent Attorney
 1115 K St., N. W. Washington, D. C.

MAKE YOUR OWN TITLER!

For all types of titles, close-up and copy work. Complete kit of finished parts—optically ground lens—easy instructions. Assemble in 15 minutes! Money Back Guarantee. State camera model.

Distinctive Title Card—"Photography by (your name)"—35¢. For All 8 or 16 MM CAMERAS

HOLLYWOOD MOVIE SUPPLY COMPANY
 NORTH HOLLYWOOD • CALIFORNIA

Birmingham's Visual System . .

• Continued from Page 433

ual education are required to determine well in advance, for an entire year, the schedule of their wants in the way of rental films and projection equipment. Following this procedure, the teachers meet each summer, schedule their plans for the succeeding year, and work out a carefully timed outline of films, after a round table discussion of the merits of the various films and their applications.

An outgrowth of these conferences was the establishment of exchange systems between various schools near to one another, usually two schools forming a unit, for film rental cooperation. Each school schedules about 30 films, and each checks the other's schedule before the films are contracted for, to be sure there is no duplication. They then exchange films for a showing of each unit, bringing the total of showings for each school up to 60, with expense to each of only 30.

So far, the majority of these films have come from

a distribution center operated by the University of Georgia, rental being about \$1, plus two-way transportation charges. This fall, however, the Birmingham schools expect to take another step in instituting a plan similar to that used by Birmingham Southern, a local college. Each school, either elementary or high, will contract for the use of 60 films per year for \$50, postage included. The local police department has a lecturer who will visit all schools and fill in with a film and lecture on safety, using the municipality's equipment. Another source available to the school is the city health department, which furnishes films both locally prepared and those rented or obtained gratis by the department from other sources. By diligently using these facilities, the Birmingham school system has maintained an unbroken and increasing use of visual education equipment despite the lack of a definite fund for equipment and rentals.

Planning school film . . .

• Continued from Page 431

"What shall we film?" might be answered by "What do parents want to see?", for after all it is toward an adult audience that this type of film will be directed.

The public relations film may give a general survey of the school's activities, or it may limit itself to showing the nature and importance of some specialized branch of work. After this decision has been made comes the problem of constructing the synopsis. The synopsis is the bare outline of the film idea. Here, for example, is the synopsis of a typical school film of the public relations type: "BUSY HANDS"

Produced by the Oakvale Schools, Oakvale, W. Va. (Length—400 Feet)

I. SYNOPSIS
 1. Introductory Sequence (in color) :

The picture opens by showing a small boy sprawled in the grass on the front

lawn. As we look over his shoulder, we see that he is looking at a large book whose title is "Busy Hands." The boy opens the book, page by page, to expose the introductory titles. Page 4 shows an enlarged photo of the school building. Boy looks at it, day-dreams, then falls asleep (fade out). The camera fades in on a shot of the school building (same as enlarged still). The boy appears in front of the building, registers surprise at finding himself there, then enters the front door.

2. Grade Two:
 The boy is seen in front of the classroom door. He stops, opens the door a few inches, and peeks in. We move in and see the pupils at work. Two boys are painting the roof of the playhouse. The boy joins them. Two girls are stuffing oil-cloth animals with sawdust.
 3. Grade Three:

NEW FLOODLIGHTING in ONE HAND



OPENS NEW INDOOR FIELD FOR AMATEURS

Stop missing the best shots

- Easily carried everywhere—about the size of a portable typewriter.
- Opens into two units. Uses six No. 1 photoflood bulbs delivering 4500 watts.
- Holds other photo equipment.
- For still, movie and color shots—provides even, wide-angle flood, bringing out all tones.
- Dim-high switch saves bulbs and current.
- Price \$11.95 east of Rockies.

See Dealer or Write
LIVINGSTON SALES CO.
 Dept. HM9, Poquonock, Conn.

8M RAINBOW 16M

Vacation Specials on Anti-Halation Base Films

	25'	100'
	8mm	16mm
No. 1 A. H.	\$.95	\$1.90
No. 2 A. H.	1.60	4.25
No. 3 A. H.	1.40	3.50

Postage and Processing Included
 WESTON RATINGS
 No. 1—12-4 No. 2—50-32 No. 3—24-16

10% off on six rolls or more.

RAINBOW LABORATORIES
 STATEN ISLAND, N. Y.

8mm SLITTER

Slits perfectly 16mm width film to exact 8mm width. Die cast body with hardened steel cutting wheels. New price, each, \$2.50.

DEVELOPING RACKS

Stainless steel take 30 feet 16mm or 8mm width film. Can be used in 11x14 or 8x10 flat trays respectively. Complete with loading stand, each, \$6.75. Specify type wanted.

At Your Dealer's or Direct

J. C. Haile & Sons
 Motion Picture Dept.
 215 Walnut Street Cincinnati, Ohio

Buy GENERA in BULK

DOUBLE 8 SCORED

SEPARATES WITHOUT SLITTING

Single 8, Double 8 & 16 M

LOAD YOUR OWN SPOOLS and Save Money
 A FINE GRAIN REVERSIBLE OUTDOOR Semi-Ortho Film. Used in Cine Kodaks, Keystone, Victor, Filmo and 8mm Univex, etc. Also suitable for titles. Processing simplified by use of Prepared Powders. FREE Film Processing Instructions with each order.

200 ft. 8 in dbl. \$1.50 post-Keystone 35c
 25 ft. dble. 8mm "REFILL" without leaders. 50¢ ptd. Eastman 40¢
 100ft. straight 8 for Univex and Filmo, \$1.00 ptd.
 100 ft. 16mm on paper sp. for 16 cameras, \$1.25 ptd.

Simplified Processing Outfits incl. Prepared Powders. For 30 ft. single 8, \$3.35, ptd.; Dbl. 8 & 16, \$4.95. Write for Big Bargain Catalog, our processing prices.

FROMADER GENERA CO., Davenport, Iowa

EXPERT PHOTOGRAPHY MADE EASY

Successful photography as a career, for sparetime earnings or as a hobby—made easy through New York Institute Training! Practical, thorough, personal coaching by leading photographers. Fascinating field. Splendid opportunities: Commercial, News, Portrait, Motion Picture, Advertising and Color Photography. Personal attendance and Home Study Courses. Booklet FREE! N. Y. Institute of Photography, Dept. 114, 10 West 33rd Street, New York, N. Y. (30th Year.)

The boy is seen outside another classroom door, peeking in. Children are at work on a Pilgrim unit. Among the things we see here are a girl working on a poster, a boy cutting and putting together a Pilgrim hat, and a group of boys at various stages of their work in building a small log house for the sandtable.

4. Geography 7:

The boy stops in front of the bulletin board, looks at the high school class schedule, and locates this class. We go into this classroom. Students are working on the southeastern area of the United States. We see them at the globe and wall maps, constructing a large wall map and notebook maps of this area, examining typical products such as citrus fruits, cotton, rice, etc.

5. Woodwork 9:

As the boy peeks into the shop door we move in where students are seen at work in the machine room. We pick up a student handling a piece of rough lumber and follow him through the essential machine and hand-tool operations, finishing, painting, etc., to the completion of a porch swing.

6. Home Economics 10:

The boy peeks in at the kitchen door. Girls are in the process of preparing and serving a lunch. We follow breadmaking from mixing to baking. We see girls preparing salads. The dining table is being set. We follow the lunch from serving to clearing away of the dishes.

7. Grade Six:

The boy peeks in at this door, and we see students doing research work in encyclopedias and the classroom library. We see them putting into practice the library rules they have learned.

8. Grade Five:

As the boy looks in at the door, we move into the room where a closeup of the bulletin board identifies the work in progress as a unit on the Orient. We see such typical hand activities as assembling a picture scrapbook on the Orient, making a Japanese kite, making a Chinese coolie hat, learning to use chopsticks, and making a pair of Oriental wooden sandals.

9. Concluding Sequence (in color):

A closeup of the ringing

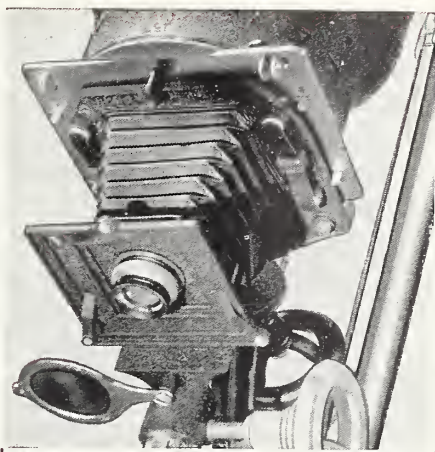

SOLAR ENLARGERS

Bring out the hidden beauty of your negatives with Solar's perfected light and optical system. Precision construction with adjustable double condensers—dustless negative carriers and other exclusive features. Seven models cover negative sizes from 35mm. to 5x7 inches . . . meet every requirement for "Prize Winning" enlargements.

Valuable Enlarging Treatise HM940 FREE.

BURKE & JAMES, Inc.

223 W. MADISON ST. CHICAGO, ILLINOIS

BETTER HOME MOVIES
With **BLACK and WHITE FILM**

REVERSIBLE FILM 25 ft. Double 8mm Including Processing Rating: Weston 12, Scheiner 18. At your dealer or direct. Fast service processing same day included at no additional cost.

Black-White 16mm—100 ft. Reversible Film Incl. Processing \$1.98 Rating: Weston 12, Scheiner 18. At your dealer or direct. Fast service processing same day included at no additional cost.

Black-White 8mm—100 ft. Reversible Film Incl. Processing \$1.98 Rating: Weston 12, Scheiner 18. At your dealer or direct. Fast service processing same day included at no additional cost.

VISUAL INSTRUCTION SUPPLY CO.
1757 Broadway Box H9 Brooklyn, N. Y.

Wherever You Roam . . .

you bring back fond memories . . . if the old exposure meter was doing its stuff . . . and you remembered to load up the camera. Whatever you forget, don't forget to send for my

BASS Bargaingram

Lists thousands of unforgettable camera items. Mention STILL or MOVIE preference. Both editions FREE.

BASS CAMERA CO. Dept. H. M.
179 W. MADISON ST. CHICAGO, ILL.

DON'T PAY HIGH PRICES FOR FILM

BUY ONYX 8 FILM FOR LESS

NON-HALO

100 ft. 16mm	\$2.15
25 ft. double 8	1.10
30 ft. for Univex	60c

Minimum Order \$1.00

Reversal Free of Charge
Write for price list of all types and grades of film. Processing chemicals for Home use.

KENWOOD FILMS
1231 E. 46th St. Chicago, Ill.

REDUCTIONS
ENLARGEMENTS
DUPLICATES

GEO. W. COLBURN LABORATORY
1197 MERCHANDISE MART CHICAGO

recess bell introduces scenes of recess period activity on the playground. The boy is seen playing with a group of small children. He starts wandering from one playgroup to another. Very nonchalantly he breaks up several groups. He walks through a marble game and scatters the marbles. He walks in front of a batter just beginning to swing at home plate. He repeats at other places. Boys of one group start after him. Others join in from all sides. The boy is hemmed in on all sides by threatening boys. They rush him (quick fade-out). We fade back in on the first scene. The boy is asleep, his head on the title book. He awakens, remembers where he is, then turns the last page to expose the end title. THE END.

After the synopsis comes work that must be delegated to the crew member who has had some camera experience. This is the breaking down of the synopsis into the continuity, or directions which the camera crew will follow. For purposes of comparison, the home economics sequence (number six) in the above synopsis would be broken down for continuity somewhat as follows:

- CONTINUITY**
- Home Economics Sequence No. 6
- Scene 1: A closeup of the classroom door shows a plate with the word "Kitchen."
- Scene 2: Closeup of mimeographed assignment sheet showing, "Friday—The luncheon menu which you completed yesterday will be prepared and served to Group 2 today."
- Scene 3: Long shot of girls working at cooking tables.
- Scene 4: Medium shot of instructor conferring with table group.
- Scene 5: Closeup of a finger going down the typed menu card.
- Scene 6: Medium shot of student arranging salad plate.
- Scene 7: Closeup of student cutting biscuits.
- Scene 8: Long shot of students setting luncheon table.
- Scene 9: Medium shot of student arranging silver at table.
- Scene 10: Closeup of

FADES LAP-DISSOLVES WIPES VIGNETTES

BAIA CINE-TRANSITO JUNIOR
1. FADE, DISSOLVE FILTER
2. WIPE DISC
3. IRIS VIGNETTER
4. MASKS AND PLATES

OPERATED BY CLOCKWORK
—ever-ready, small, light (4 oz.), compact, easy to operate, efficient, and durable.

Price \$9.95 Includes Adapter, Wipe Disc, and Cable Release

Accessories
FADE DISC \$1.95
VIGNETTER \$2.95
Extra ADAPTERS 95c and up

Specify Camera and Lens From Your Dealer or Direct

BAIA MOTION PICTURE ENGINEERING
8044 Hardyke Detroit, Mich.

THE NEW "CRITIC" MODEL 40

\$18.75

Perfect exposures because of light acceptance angle of the "Louvre" construction.

DeJUR-AMSCO CORPORATION
SHELTON, CONNECTICUT

Golden Gate International Exposition 16mm Films

Four 100-ft. reels. No titles except heading and end.

REEL No. 1—Gen views, Oakland Bay Bridge, Tower of Sun, Fountains, Buildings, etc.
REEL No. 2—Continuation of reel No. 1.
REEL No. 3—Continuation of reel No. 2.
REEL No. 4—Night photography The Fair in all its glory! General views of the Gay Way.

Each reel complete, but you can add one to the other without duplication. **BLACK AND WHITE** specially priced at each \$1.95

NATURAL COLOR PRINTS
Full color Kodachrome showing the Fair in all its beauty. 100 ft. 16mm \$9.00

8mm BLACK AND WHITE
50 ft. \$1.75 180 ft. \$5.50
California Buyers Include Sales Tax

HOLLYWOODLAND STUDIOS
"The West's Greatest Film Mail Order House"
SOUTHGATE CALIFORNIA

THRIFTY BULK FILM

Write for Catalog and NOTE THESE PRICES

100 ft. double 8mm semi-ortho	\$1.19
100 ft. straight 8mm semi-ortho75
100 ft. 16mm semi-ortho	1.19
Dbl. 8mm empty camera spools30
Univex straight 8 empty camera spools15
100 ft. 16mm empty camera spools40

Slitters for slitting unscored double 8mm film, formerly \$1.50, now only .79

All above film is laboratory packed and prices do not include processing.

California customers please include 3% sales tax. No C.O.D. orders unless accompanied by \$1.00 cash with order.

THRIFTY FILMS
Drawer 98, Watts Station Los Angeles, Calif.

RESERVE NOW

Cine Shop TITLES

YOUR COPY OF CINE SHOP'S latest **TITLE CATALOG** OUT SEPT. 1st

Cine Shop
1812 PIEDMONT CHARLESTON, WEST VA.

ORDER NOW!
ONLY A FEW MORE LEFT
HYPER CINOR 8 M M
WIDE ANGLE LENS
ATTACHMENT



Money Back Guar. \$39.75
Send Money Order or Check

- Focus from 2 1/2 feet to infinity.
- Double the angle without loss of lens speed.
- Get a field twice as high, twice as wide with your own 8 m/m lens.

Fits the following 8mm cameras: Bolex, Keystone, Univex, Revere, Emel, and Eastman 80 and 90 and Filmo 8's.

CAPITAL CAMERA EXCHANGE
Washington's Original Camera Exchange Store
1003 Pennsylvania Ave., N.W. Wash., D.C.
Write for Free Catalogue of Camera Bargains

For Good Pictures
Ask for

Consumers Film Products CORPORATION

COMPLETE LINE OF 16mm AND 8mm CAMERA AND PROJECTION FILMS
At Your Dealer, or Write Direct
RIDGEFIELD PARK, N. J.

16MM AMBERTINT

Fine grain, semi-ortho, large latitude—half stop either way—QUALITY film at low cost.

Amber tint of film pleasing and different. Price includes machine processing. Not sold by dealers, in bulk or 8mm size. Order direct. 100-ft. roll only **\$2.00**

California Buyers Include Sales Tax
WRITE FOR BIG FREE BULK CATALOG

HOLLYWOODLAND STUDIOS
THE WEST'S GREATEST FILM MAIL ORDER HOUSE
SOUTHGATE, CALIFORNIA

NOTICE TO MOVIE FANS

If you take movies (8mm or 16mm) you simply cannot afford to be without a Free copy of the latest Photo Bargain Book now being distributed throughout the U. S. Lists all the best moving picture equipment from all the leading manufacturers, describes them. The prices save you money in many cases. You'll find the latest in lenses, screens, meters, projectors, cameras, film, titlers, editing outfits, tripods, books on editing, titling, etc. This Bargain Book is invaluable to you as an equipment REFERENCE book. Don't wait a day longer to send for your Free copy. Write us now.

CENTRAL CAMERA COMPANY
230 S. Wabash Dept. 1-9 Chicago, Illinois

★ TITLES
★ REDUCING
★ ENLARGING
★ BULK FILM
★ REVERSE PROCESSING

16mm
Write for ILLUSTRATED CATALOGUE

8mm
GENERAL CINE SERVICE
204H 18th St. New York

FOTOFADE

FADES, WIPES Can be added to your Reels after Processing WITH FOTOFADE on black and white or color films. Price, \$1.00. Waterproof Wipeoff Tape, 60¢ per roll. Complete Fotofade Kit.....\$1.60

CINETINTS for coloring your 16mm or 8mm film. Set of six colors, \$3. At your Dealer or direct.

DYE RESEARCH LABORATORIES
518 Jackson Street Los Angeles, Calif.

CLEAN FILMS PROJECT THE BEST PICTURES



Use Our Dry Film Cleaner — Price \$3.95 Postpaid
FISHER MFG. CO.
17 Main St. E. Dept. 61-V Rochester, N. Y.

hands arranging flowers at table.

Scene 11: Closeup of bread being removed from electric oven.

Scene 12: Long shot of Group 2 being seated at table.

Scene 13: Medium shot of student being served first course (fade).

Scene 14: Fade in on closeup of hands removing last course dish.

Scene 15: Medium shot of table being cleared.

Scene 16: Medium shot of student washing dishes. Left hand carries washed plate out of view to left.

Scene 17: Closeup picks up hand (scene 16) as it deposits dish in rinsing water.

Scene 18: Medium shot of student at drainboard drying dishes.

Scene 19: Long shot of student placing dishes in cupboard and closing the doors.

This sequence would run approximately 80-100 feet of 16mm film, while it may be noted in the synopsis given above that the entire film was one reel (400 feet) in length. One reel of 16mm film is most certainly the advised length for the school's first film. Concentration of energies and funds on a good production at this length will produce far more satisfactory results than will over-ambitious attempts at longer films.

Educational film releases . . .

• Continued from Page 437

thatched cottages, lakes, rivers and great cities of the Emerald Isle. A jaunt with genial hosts out to peat fields, and then with stock and produce to market at Galway. A stop-over along the coast to visit with fisher-folk. The beautiful lakes of Killarney and the river Shannon with a look at Blarney Castle.

MEXICO

400 Feet and 100 Feet 16mm Silent; 360 Feet 16mm Sound. Castle Films, New York City. Buried civilizations of a glorious past, cradles of art and culture in the Americas, monumental reminders of native Indian and foreign invaders' artistry . . . all mingle with Twentieth Century Mexico in a richly fulsome movie. Exotic scenic vistas, palaces and temples, and sites of lovely legend and historic lore, such as Xochimilco, the "palace of flowers," and the temple of Quetzacoatl.

THE ARKANSAS TRAVELER
1 1/2 Hours — 16mm — Sound. Films, Inc., New York City, N. Y. The Arkansas Traveler is a sincere human, down-to-earth family picture of small town life, starring Bob Burns, Fay Bainter, and Irvin S. Cobb. Extremely interesting from a vocational standpoint. Study guides are being prepared.

PURITANS OF MASSACHUSETTS COLONY
2 Reels—16mm—Sound. Audio Film Libraries, Bloomfield, N. J. Covers the life, customs, government, religion, education, homes and occupations of the Puritans in Massachusetts about 1645. The characters are portrayed by costumed actors, and dialogue as well as narrative is used to give realism to the subject.

THE LAST WILDERNESS
1690 Feet — 16mm — Sound. Eastin Pictures, Inc., Davenport, Iowa. Armed only with a bow and arrow, Howard Hill, holder of many world championships in archery, heads an expedition into America's most inaccessible wilds, where the animal life which once overran the continent is still plentiful. The film

which records his adventures contains many demonstrations of his uncanny skill with his ancient weapons, but is also notable for its magnificent pictures of wild animal life and little known scenic wonders. Bears, buffalo, deer, antelope, elk, moose, bighorn sheep, wildcats, and many other animals are shown in their natural surroundings. A drama of the wilds is woven into the picture, adding interest and a measure of suspense. A mother bear is slain by an outlaw bear, and Hill adopts her two clownish, roly-poly cubs. He resolves to track down the killer, and eventually finds the dangerous beast and brings him down with his bow and arrow.

LORNA DOONE

3170 Feet — 16mm — Sound. Eastin Pictures, Inc., Davenport, Iowa. This is a brilliant and faithful picturization of Richard D. Blackmore's great tale of the strange and eventful romance of Jan Ridd, the yeoman farmer, and Lorna Doone, member of a dreaded outlaw family. The setting is the English Exmoor in the days of the Stuart kings, and among the many memorable portions of the picture are the romantic meeting of Jan and Lorna, the furious jealousy of Carver Doone, the forays in Devon in the days of Charles II, the Doone's attack on the Ridd farmstead, the rising of the exasperated country-folk and the defeat of the outlaws, the knighting of Jan Ridd by James II in a glittering ceremony at Whitehall, the wedding of Jan and Lorna at Oare church, the wounding of the bride on the altar steps by Carver Doone, and the epic fight between Jan and Carver in the Black Bog.

BIRDS IN THE SPRING

8 Minutes — 16mm — Color, Sound. Kodascope Libraries Division, Eastman Kodak Stores, New York City. This is one of the few Disney Cartoons in color available in 16mm film. In the bright springtime, three birds are born. One of them strays away and after several thrilling experiences, returns home.

Cinea 30
FILM SPLICER
HANDLES BOTH 8 and 16mm SOUND and SILENT FILM



It's the best! It is expertly designed for efficiency and precision built to make all splicing easy, fast, and accurate. All of the working parts are held under steel spring tension. When properly made, Cinea splices are neat and strong..... \$10.00

See your dealer or order direct from—
American Bolex Company
155 East 44th Street • New York, N. Y.

CORONA 8mm 16mm

BETTER REVERSIBLE FILMS

	Panchro Super	Micro-gran Anti-halo	Semi-Ortho Outdoor
16mm, 100 ft.	24-16	12-8	8-2
Double 8, 25 ft.	4.00	3.70	\$2.00
	1.60	1.45	1.00

Above includes processing and daylight spooling.

BULK FILMS—16mm, Dble 8 Scored

16mm, 100 ft.	\$ 3.15	\$ 2.80	\$1.25
16mm, 400 ft.	11.50	10.80	4.00
Dble. 8, 100 ft.	3.50	3.00	1.25
Dble. 8, 400 ft.	13.00	11.50	4.00

Above prices do not include processing.

Super Ortho (16-6) same price as Microgran.

REVERSAL PROCESSING—16mm and 8mm

100 ft.	85¢	50 ft.	65¢	25 ft.	50¢
---------	-----	--------	-----	--------	-----

All orders shipped postpaid except C. O. D.

Corona Film Laboratories
200 East 34th St. Brooklyn, N. Y.

TITLES BY PARK CINE

Complete Titles on appropriate backgrounds to professionalize your home movies. Compose your own TITLES... we hand-set them on backgrounds you select from our catalogue, sent you FREE on request.

Yet these artistically photographed Titles cost no more than typewritten Titles. Priced at 25c for genuine hand-set printed Titles and only 35c for Art Background Titles.

PARK CINE LABORATORY
120 West 41st St. New York

GLASS-BEADED MOVIE SCREENS
Easily Made!

Make your own sparkling beaded screens—at a fraction of their usual cost! Crystal beads can be applied to cloth, cardboard or almost any smooth surface. Complete directions with each pound. (No fractions of pounds sold.)

Glass Beads to cover 20 sq. ft. (1 lb.).
Finest Size \$1.25.

D GARD, C-7, 54 WEST 74TH ST., NEW YORK CITY

HOT OFF THE PRESS
16mm SILENT AND SOUND-ON-FILM
RENTAL LIBRARY CATALOGUE
Films Shipped Anywhere—Large Selection
Write Today for Your Copy

NATIONAL CINEMA SERVICE
71 Telegram Sq. New York City

"It Always Gets the Picture"
G FILM
DESTROY THE FIFTH COLUMN OF HOME MOVIE FAILURES

100' 16mm (inc. Proc., postpaid)	\$1.50
100' Dble. 8mm (inc. Proc., postpaid)	1.75
100' Sgls. 8mm (inc. Proc., postpaid)	1.00

Unspooled to Save You Money Scheiner 18

M-G-M PHOTO SERVICE
1485 Oak Street San Francisco

IN PHILADELPHIA
CAMERAS
and Everything Photographic
KLEIN & GOODMAN
18 S. 10th STREET

What Film Should I Use?

• Continued from Page 413

against a background of green shrubbery and a blue sky.

Shooting with the "color-blind" film, which is rather slow, a generous exposure must be given. Assuming an average light condition which would give a light-value reading of 160 on a Weston meter, this film, with an average speed of Weston 4, would demand an exposure (at the average cine-camera shutter speed of 1/30th second) of f:4.5.

The girl herself would look reasonably natural in this shot. Of course, the red of her lips would photograph very dark—almost black, in fact—but as the picture as a whole would be pretty contrasty, this wouldn't be too noticeable. The shot, if properly exposed and processed, would have plenty of snap and sparkle.

But, the red slacks would appear a jet black, while the yellow blouse would be a rather dark gray. The green foliage would also be dark—almost black. The blue sky would be a clear, blank white; if there were any clouds in it, they'd be lost against the white background. If the background included what the exposure guides classify as a "distant landscape," most of the distance would be swallowed up in hazy indefiniteness. Incidentally, if the pretty model should have any freckles, this film will make them stand out prominently.

Now, shooting the same picture with one of the ortho types, the model's lips would still be black. So would her red slacks. The freckles would still be prominent. The yellow blouse would be a medium light gray, but still a good deal darker than it appears to the eye. (By the way, the human eye is most sensitive to yellow; that is why several railroads use yellow instead of red for danger signals, and the top wings of army airplanes are painted yellow—a color that can be seen at a greater distance than any other.)

Photographed on ortho film, the green foliage would be quite a bit lighter than it was in the shot on the "color-

blind" film, but still a good deal darker than seems natural. The blue sky would still be a blank white, against which no clouds would be visible. The extreme distance would be lost in the haze. Assuming an average speed of Weston 10, the exposure would be cut to f:7.

There would be this advantage, however: With this type of film a yellow filter can be used to lighten up the dark-green foliage a bit, and to pull down the white rendition of the sky to a gray, against which the clouds would be visible. The filter would also help to reveal a bit more of the extreme distance. The whole picture would be more natural, and the effects more controllable.

Now shoot the scene again on a "pan" film. Things begin to look much more as we're accustomed to seeing them. The girl's lips would become a natural, darkish gray—exactly how dark depending on the shade of lipstick she favors, and upon the precise type of film used. The red slacks would become a nice intermediate gray definitely more suggestive of the visual brilliance of their red color. The yellow blouse would appear much lighter—a light gray. The green shrubbery would lighten up several shades to a medium gray, much closer to their normal visual brilliance. The blue sky would become a medium light gray, in some cases pretty close to the gray obtained using an ortho film and a yellow filter. The clouds would be nicely visible. The extreme distance would clear up a great deal. The girl's freckles would almost disappear. The exposure (assuming an average film speed of Weston 24) would drop to f:11.

And with "pan" film it is possible to employ all sorts of useful filterings. A yellow filter would lighten the yellow blouse and slightly lighten the green foliage, while darkening the sky several shades, making the clouds stand out better and revealing the extreme distance more clearly. An orange filter would carry these

changes still farther, incidentally completely eliminating the lady's freckles. A red filter would bring the blue sky down to an extremely dark gray, or even a midnight black, while turning the red slacks a very pale gray—almost white—making the yellow blouse appear white, and in some cases lightening the rendition of some of the greenery. (It would, by the way, "wash out" the model's red lips to an almost pure white and would change the face-tones to an unnatural chalky shade.) A green filter would tone down the reds considerably, leave the blue sky quite light, and lighten up the green foliage considerably.

To sum things up, for shooting ordinary action (not extreme distant scenic landscapes) outdoors, where snappy, clearly recognizable pictures are desired, and the finer gradations of color rendition are of secondary importance, the outdoor "color-blind" films will serve excellently . . . and permit shooting several times as many scenes for your money.

For a more natural appearing picture, in which the black-and-white rendition of the various colors is closer to the way the eye sees them, use an "ortho" or "chrome" type of film. Plenty of cinefilmmers—discerning ones, too—use a film of this type for all their outdoor filming, and like it, because it gives them really fine pictures and at the same time saves them money.

For results more nearly comparable with what one sees on the professional screen, with a generally softer, more pleasing contrast with the black-and-white rendition of color-values almost perfectly matched to their actual visual brightness, use the "pan" types. These films will undeniably give the most perfect quality and the widest scope in playing around with filters; naturally, one has to pay for these advantages.

Further explanation of various type films will be continued next month.

F-R
PRECISION
RANGE
FINDER

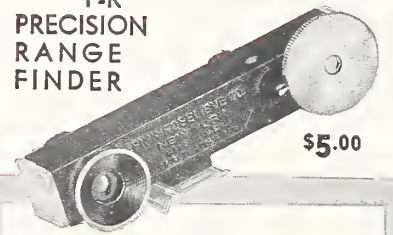

\$5.00

DON'T GUESS—BE SURE!

GET FINER RESULTS

For as little as \$6.00 the combined price of the F-R Precision Range Finder and the F-R Exposure Meter—you can provide yourself with the essential tools for eliminating the element of guess work from focusing and exposure problems. The F-R name—symbol of photography's truest value—unequivocally guarantees the dependability of these instruments.

\$1.00



F-R
EXPOSURE
METER



MOVIE FILM	Reg. Weston 8	Super Weston 12	Pan Weston 24
16mm, 100 ft	\$1.79	\$2.19	\$3.69
16mm, 50 ft.	1.19	1.39	2.19
Dbl. 8mm, 25 ft.	.98	1.19	1.39

Not to be confused with bulk film. Each roll complete on daylight loading spool in metal container in mailing carton. Prices INCLUDE high grade processing service 24 hours in our laboratory. Supplied in 3 popular types. REGULAR semi-ortho; SUPER full-ortho, non-halation, wide latitude. PAN is extremely fast, panchromatic, very fine grained.

ORDER TODAY DIRECT FROM THIS AD
Orders for 2 rolls or more, accompanied by \$1, may be sent C. O. D. for balance.

ESSCO FILM PRODUCTS
Dept. HM
6117 SO. CAMPBELL AVE. CHICAGO, ILL.



RAVEN SCREENS

Used exclusively in the Kodak Cavalcade of Color at World's Fair. At all leading dealers. Literature on request.

RAVEN SCREEN CORP., 314 East 35th St., New York

ABSOLUTELY FREE
5,000 "A TO Z" MOVIE TITLING
TRY-IT-YOURSELF KITS
Also Sample "Figurette" FREE
Send Today - Keep the Kit - It's Yours
JACOB STEIN, Mfr.
175 Fifth Ave. Dept. H-17 New York

8mm Bulk Film 16mm
Lowest Prices
Write for Catalogue
HOLLYWOODLAND STUDIOS
Southgate California

BRITELITE - TRUVISION
America's foremost line of motion picture screens, spotlights, reflectors, paper safes, etc.
Write for complete details.
MOTION PICTURE SCREEN and ACCESSORIES CO., INC.
351 West 52nd St., New York City

Presenting

A MOVIE A MONTH

For 8 and 16mm Fans

A new plan entitling members to an extremely low cost viewing service.

Complete Edition Castle Films

8mm for as low as 35c

16mm for 70c

AND THAT'S NOT ALL

You receive one headline edition free. You select it and own it.

IT'S A GREAT SERVICE

Write Now for Further Details

Movie a Month Association
Box 524 Reynoldsville, Pa.

The Service That Saves

The NEW Improved
HOLLYWOOD "CINESCOPE"



8mm-16mm Film POCKET VIEWER, Reg. Price \$1.50
OUR NEW LOW PRICE . . . \$1.00 POSTPAID
SPECIAL FEATURES—Will not scratch film . . . pre-focused for normal vision . . . adjustable for abnormal vision . . . large, precision eye-lens . . . well made, will last for years . . . film is held in position by groove . . . can be mounted on editing boards . . . special "light diffusion" screen . . . professional appearance.
State 8mm or 16mm When Ordering
Above Viewer FREE with Any \$10.00 Order
HOLLYWOODLAND STUDIOS
"The West's Greatest Film Mail Order House"
Southgate, California

PROCESSING

Any Make or Type—Reversed—Neg.
100' 16mm, 75c 100' Dbl. 8, 90c

COPIES or PRINTS

Single, Dbl. 8 or 16mm, 2/2c per Foot
Minimum Order \$1.00

REDUCTION of underexposed film . . . 2/2c per foot. Min. \$1.00.

INTENSIFICATION of overexposed film. 3c per foot. Min. \$1.00

FILMS in Bulk or Processed

Send for Free Useful Pamphlet

BRITE TONE MOVIE SUPPLY

188 W. Randolph St., Dept. H Chicago, Ill.

25¢ Kodak Finishing 25¢

Any 6 or 8 exp. roll dev. and printed for only 25c. Quality guaranteed. None finer. Bring in or mail.

Extra Prints—122 or smaller, 3c each. 35mm enlarged to 4x5, 5c each. Write for complete price list.

THRIFTY PHOTO SERVICE

10364 State Street Lynwood, Calif.

MR. 16mm PRODUCER

We offer you complete facilities for

SOUND

BLACK & WHITE • KODACHROME SPECIAL EFFECTS

GEO. W. COLBURN LABORATORY

1197-A Merchandise Mart CHICAGO

Information . . .

• Continued from Page 406

to be slow and so even that no streaks or spots occur. Actual contact with the film is prevented by placing the mercury in an open glass or metal container or by wrapping the amalgam loosely in porous blotting paper.

"Among the surprising facts revealed by the experiments is the unusual behavior of the latent image when treated with mercury vapor, a discovery that may lead to a better understanding of what happens when the latent image is formed. It was found that film showed a markedly greater increase in sensitivity when hypersensitized after exposure instead of before exposure. Other interesting features of the method are that it shows no apparent effect on the gradation of the grain size of the photographic material. Further characteristics which make the method superior to usual wet-hypersensitizing treatments include the following features reported by Drs. Dersch and Duerr in their article:

"(1) The film does not have to be put through a bathing process and then dried. (2) The mercury vapors are active also upon tightly wound spools of film, the sensitizing effect being uniformly spread over the whole length (e. g., of a 100-foot roll of 35mm picture film). If sufficient time is available for hypersensitizing, the films need not even be removed from their original wrappers, as the mercury vapors diffuse sufficiently through the wrapping material. (3) The in-

crease of sensitivity is general throughout the range of wave length of light to which the film was originally sensitive. (4) The stability of the film is not permanently affected, although the increase in speed is gradually lost over a period of four weeks of aging. By a second treatment with mercury vapor, the hypersensitizing can be renewed in a film that has recovered from previous hypersensitizing."

Workshop . . .

• Continued from Page 429

those of split stage effects. Because this device interferes with use of regular camera viewfinder, I built an auxiliary viewfinder from sheet metal. Cross-wires at front and back aid in keeping objects focused in center.

— Bill Leedke.

Title Troubles...

• Continued from Page 408

Q. Should the background be the same for all the titles or should it be different?—M. S. S., Blue Earth, Minn.

A. There is no rule to answer this question, but if it were my film, I should use the same, simple design for all the subtitle backgrounds. The same background gives the film a unity that is lacking if the backgrounds vary from title to title. You might have different backgrounds for the lead and end titles, but your film will seem to "hold together" better if the subtitle backgrounds are the same.

• All Amateurs, whether subscribers of HOME MOVIES or not, are invited to submit their films to the editors for review and helpful criticism. Unless otherwise requested, reviews of some of the films which we believe would benefit other amateurs will be published each month.

Reviewed films will be rated one, two, three, and four stars, and films qualifying for two or more stars will receive, free, an animated leader indicative of such award. Detailed reviews, with suggestions for improvement—if any—will be mailed to amateurs submitting their films.

Exceptional films qualifying for

the distinction of the "Movie of the Month" will be treated in detail in a feature length article in a following issue of HOME MOVIES. In addition, a certificate evidencing the award of "Movie of the Month" and a special animated "Movie of the Month" leader will be returned with such films after review.

When submitting films for review and analysis, please advise make of camera, speed of lens, whether or not tripod was used, or if you used filters, exposure meter, or other accessories. While this information is not essential to obtain analysis of your film, we would like to pass it on for the benefit of other amateurs.

NEW 8-16mm "CINE-SCOPE" POCKET-VIEWER \$1.00

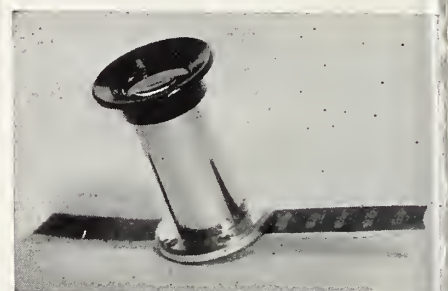

MAGNIFIES 36 TIMES AREA
Optically-ground lenses insure a large, clear-cut image. Adjustable. Film is slipped in, at the side. Groove holds film in position (see photo). A \$3.50 value—GOING FAST at \$1.00.

A REAL NECESSITY—ORDER NOW!
State 8 or 16 mm. Enclose dollar-bill and dime post. (DON'T SEND STAMPS.)
Designed by: E. M. LIEBSCHER, Opt. Engr.
157-pc. "moderne" TITLING-SET, \$1.95
3/4 in. high—3/8 in. thick or cast-white DENTAL plaster. "Third dimension." NO PINS. Regular price, \$4.00 per set. Has letters, figures, etc. 157 pcs. Shipped ins. exp. (chs. approx. 35c). DIME BRINGS SAMPLES—NO STAMPS. FREE!! "Table of sizes" CHART with ALL orders (while they last). Reg. \$1. Gives "field-sizes" at various distances. "CAMERA SPECIALTIES."
P. O. Box 3182 Hollywood, Calif.

Climax

Your Next Screening with Pictures That Thrill!



"HER HOLLYWOOD TEST" and other Sensational Films obtainable only from us. Get best prints, lowest prices, direct from producers. SPECIAL PRICE LIST FREE.

Special Price List Free
Inclose Dime for Sample Film
Sensational Films
Box 1504 Hollywood, Calif.

Guaranteed 24-Hour PROCESSING



EXCLUSIVE with ESO-S Pictures is the modern soft-flash system reversal process which insures an even, correctly tone-balanced, fine-grain reel of films consistently!

Double 8mm, up to 34 feet.....45c
Single 8mm, up to 34 feet.....25c
Univex Std. and U. P., and ALL ESO-S single 8mm films.....15c

These prices apply to all bulk films, including the new Geraert Ortho, Microgan and Super Panchor, DuPont, Eastman positive, and our own complete line of reversal films.

REELS AND CANS RETURNED WITH THE FINISHED FILMS UPON REQUEST

ESO-S PICTURES

"Quality 8mm Service"

3945 Central Street Kansas City, Missouri

TITLES LIKE THIS . . . Can Be Yours

122 pieces for \$1.00! Letters and numbers 1 inch high, made of stiff polished coated cardboard—all die cut. In 6 colors—red, green, yellow, blue, black and white. Least expensive yet best type of letters for photographic titles and quotations, etc. Send check, money order or

Rich Mfg. Co. \$1.00 today . . . complete units shipped immediately, postpaid.
364 Atlantic Ave. Boston, Mass.

16mm Professional TITLES Silent by FILMACK Sound

Put pep, punch and theatrical effect into your pictures and announcements with Filmack titles. Sound or silent. Black and white, tinted or KODACHROME. Complete, 16mm Laboratory service. No order too small. Send for Catalog—FREE.

SEND TRIAL ORDER

FILMACK LABORATORIES

832 South Wabash Avenue

Directory Of Amateur Cine Clubs.

ARIZONA

TEMPE: Tempe Cine Club (8mm and 16mm)—Howard Lindly, Sec'y, 103 E. 5th St. Meet 2nd Wednesday.

CALIFORNIA

ALHAMBRA: La Casa Movie Club (8mm and 16mm)—H. P. Carnahan, Pres., 21 S. Garfield. Meet 3rd Monday each month.

AZUSA: Sunkist Movie Makers of the San Gabriel Valley (8mm and 16mm)—Elbert B. Griffith, Sec'y, 708 E. Bonita Ave. Meet 1st Monday each month.

BERKELEY: Berkeley Amateur Motion Picture Club—Micky Ambrose, Sec'y, 1719 E. 15th St., Oakland.

EL SEGUNDO: South Bay Camera Club—Heath L. Martz, Vice-Pres., 314½ Virginia St.

FRESNO: Fresno Movie Makers—R. C. Denny, Sec'y, 750 Vassar Ave.

GLENDALE: Glendale Lens & Shutter Club (8mm and 16mm)—Howard Manning, Sec'y, 547 N. Brand Blvd. Meet 2nd Tuesday each month.

HANFORD: Kings Camera Club—G. Meldrum, Pres., 206 W. Grangeville Blvd.

HAYWARD: Hayward Cinema Club (8mm and 16mm)—Harvey Reed, Jr., Sec'y, 230 Pearce St. Meet 2nd and 4th Thursday.

HERMOSA BEACH: Amateur Movie Club of Hermosa Beach—Robert Balfour, Producer.

HIGHLAND PARK: Highland Park 8mm Club (8mm)—Howard Timmons, Sec'y, 4530 W. Avenue 41. Meet 2nd week of month.

LONG BEACH: Long Beach Cinema Club—Pat Rafferty, Sec'y, 2215 E. 8th St. Meets 8 p. m. 1st and 3rd Wednesdays at Y. W. C. A.

LOS ANGELES: Los Angeles 8mm Club—Leo Caloia, Sec'y, 143 West Avenue 28. Meet 2nd Tuesday each month.

Los Angeles Cinema Club (8mm and 16mm)—Wm. Hight, Sec'y, 361 N. Formosa Ave. Meet 1st Tuesday each month.

Southwest 8mm Club (8mm)—Mrs. W. B. Blanchard, Sec'y, 2127 Glendon Ave. Meet every 3rd Tuesday.

LYNWOOD: Southern Cinema Club (8mm and 16mm)—Don Hunt, Sec'y, 3522 Firestone Blvd., South Gate, Calif. Meet 4th Tuesday each month.

MONTEREY: Peninsula Cine Club (8mm and 16mm)—H. H. Daugherty, Box 97, Pacific Grove. Meet 3rd Wednesday each month.

NORTH HOLLYWOOD: North Hollywood Cine Club (8mm and 16mm)—Ted Knight, Sec'y, 4873 Lankershim Blvd. Meet 1st Tuesday each month.

NORWALK: The Tri City Movie Club (8mm and 16mm)—Bert P. Teets, Sec'y, 804 Pine. Meet 1st and 3rd Wednesday of the month.

OAKLAND: Bay Empire 8mm Movie Club (8mm)—R. J. Shattock, Sec'y, 4132 Opal St. Meet 2nd and 4th Wednesday of month.

The Greater Oakland Motion Picture Club (8mm and 16mm)—B. F. Pratt, Sec'y, 2039 Shattuck Ave., Berkeley. Meet 2nd and 4th Monday each month.

PASADENA: Pasadena Movie Club—Gordon Plank, Sec'y, 2075 E. Orange Grove. Meet 3rd Wednesday of each month.

POMONA: Pomona Valley Club—T. J. Hebert, 155 S. Garey St.

RED BLUFF: Tehame County Movie Club (8mm and 16mm)—Hank Schafer, Sec'y, 415 Madison St. Meet every 3rd Thursday of the month.

SACRAMENTO: Sacramento Movie Club (8mm and 16mm)—Wilfred Meacham, Sec'y, c/o Associated Oil Company. Meet 1st Thursday of month.

Sierra Camera Club (8mm and 16mm)—John Pardee, Sec'y, 1207 K St. Meet 2nd Tuesday and last Thursday.

SAN DIEGO: San Diego Cinema Club (8mm and 16mm)—G. E. Taylor, Sec'y, 4522 Utah. Meet 2nd and 4th Wednesday each month.

SAN FRANCISCO: Cinema Club of San Francisco (8mm and 16mm)—Edwin L. Sargeant, 1980 Washington St. Meet 3rd Tuesday each month.

Cinematicians Club of San Francisco, 130 Taraval St.

Sherman Clay Movie Club (8mm and 16mm)—Mrs. C. E. Griffin, Sec'y, 1335 Washington. Meet 3rd Wednesday of each month.

Silver Screen Players of San Francisco (16mm)—Bette Byers, Sec'y, c/o Eric Mawson, 237 Woolsey St.

Westwood Movie Club (8mm and 16mm)—Don S. Campbell, Sec'y, 1164 Portola Dr.

SAN JOSE: San Jose Cine Club (16mm)—Frank T. Bondi, Sec'y, 1286 Vine St. Meet 1st Monday each month.

• Amateur movie makers interested in joining a cine club may make inquiry of the secretary of the club nearest their vicinity whose headquarters are given on this page.

If you are interested in forming a new cine club, HOME MOVIES will be glad to assist you. You are invited to write to the editors for free data that will be of assistance to you in organizing a club.

Listing of additional clubs will be made to this directory from time to

time as the data is received from club secretaries. Every amateur cine club in the United States, Canada, and Mexico is invited to participate. Clubs not as yet listed are requested to furnish the necessary information for listing.

Stars indicate clubs from whom club-produced films are available to other clubs on exchange basis on payment of transportation charges.

This directory is another of HOME MOVIES' exclusive services for the amateur movie maker.

SANTA ANA: Orange County 8mm Club (8mm)—Jack Kahler, Sec'y, 1512 Dresser St.

8-16 Movie Makers—Thelma Heath, 1028 Hickory St. Meet 1st and 3rd Thursdays.

STOCKTON: Port Stockton Cine Club (8mm and 16mm)—K. R. Oliver, Sec'y, 345 N. San Joaquin. Meets 2nd and last Thursday of each month.

Stockton Cine Club—Harold Liddicoat, Sec'y, 11 S. Hunter St.

COLORADO

DENVER: Bell Movie and Camera Club of Denver—H. M. Price, Box 960.

Denver Cine 8mm Club—Preston Hopkins, Sec'y, 631 E. Colfax St. Meet 2nd Monday each month.

CONNECTICUT

BRIDGEPORT: Monogram Movie Club.

BRISTOL: Bristol Cinema Club—Earle H. Sparks, Pres., 20 Good St. Meet 2nd Thursday each month.

HARTFORD: Hartford Amateur 8mm Camera Club (8mm)—George McCauley, Sec'y, 1214 Main St.

Nutmeg Film & Reel Club—J. Philip Earley, Sec'y, 138 Main St.

MANCHESTER: The Manchester Cinema Club—Mrs. Thos. Hooley, Sec'y.

NEW BEDFORD: Greater New Bedford Movie Club—Percy Lord, Sec'y.

NEW HAVEN: The 8mm Movie Club of New Haven (8mm)—Syd Sidebottom, Sec'y, 29 May St., West Haven. Meet 3rd Tuesday each month.

STAMFORD: Stamford Cinema Club—R. Taylor, Sec'y, 65 South St. Meet 3rd Wednesday.

TARRINGTON: Tarrington Cinema Club.

DISTRICT OF COLUMBIA

WASHINGTON: National Capital Cinema Club (16mm)—Geo. D. Lane, 738 Numsey Bldg. Meet 2nd Thursday.

WASHINGTON: Washington Society of Cinematographers (8mm and 16mm)—Wilbur F. Comings, Sec'y, War College Dept. Meet 1st and 3rd Mondays.

Washington 8mm Club—Dr. I. Rodis, Sec'y, 1726 Eye St. Meet 2nd Wednesday each month.

FLORIDA

JACKSONVILLE: Jacksonville Movie Makers (8mm and 16mm)—350 St. James Bldg. Frank M. Linville, 424 W. 17th St.

GAINESVILLE: Orange State Camera Club—Earl H. Jernigan, Pres., Box 587. Meet every other Tuesday.

MIAMI: Miami Camera Club—Alfred Kahn, Sec'y.

Miami Movie Makers (8mm and 16mm)—Mrs. Paul Hockett, Sec'y, 1460 N. W. 38th St. Meet 1st and 3rd Monday each month.

TERRITORY OF HAWAII

HILO: The Family Movies Club—P. O. Box 106.

HONOLULU: Honolulu Amateur Cinema Club (8mm and 16mm)—Richard G. Bailey, Sec'y, c/o Nuuanu Y.M.C.A., Fort St. Meet 1st and 3rd Tuesday each month.

Honolulu 8mm Club (8mm)—Francis C. Williams, 4740 Farmer Rd.

GEORGIA

ATLANTA: Atlanta Movie Club (8mm and 16mm)—Douglas Cone, Sec'y, P. O. Box 74, Station C. Meet 1st and 3rd Friday each month.

THOMASTON: Thomaston Movie Club—(16mm and 8mm)—J. Lee Abernathy, Sec'y, 308 W. Main St. Meet every other Sunday.

IDAHO

BOISE: Boise Camera Club (8mm and 16mm)—Mabel M. Sturgis, Sec'y, 1505 N. 15th St. Meet 1st and 3rd Tuesday each month.

NAMPA: Nampa Movie Club (8mm and 16mm)—Art French, Sec'y, c/o Northwest Photo Shop. Meet 1st Monday.

ILLINOIS

BERWYN: Suburban Amateur Movie Club (8mm and 16mm)—John Triska, Sec'y, 2415 S. Highland Ave. Meet 1st and 3rd Monday each month.

CANTON: Canton Movie Camera Club (8mm and 16mm)—Lafe Drury, Sec'y, 314 S. Main and Walnut. Meet 2nd and 4th Mondays.

CHICAGO: Chicago Cinema Club (8mm and 16mm)—Lilly Thye, Sec'y, 314 S. Federal St. Meet every Thursday.

Chicago Cinematographers—S. F. Warner, 1538 Marengo Ave., Forest Park. Meet 1st Tuesday each month.

Commonwealth Edison Camera Club—Arnold R. Hatch, 72 W. Adams St., Room 737.

Circle Camera Club (8mm and 16mm)—Eugene J. Etges, Sec'y, 1139 N. Lamont Ave. Meet every 4th Wednesday.

Lane Tech Movie Club—A. P. Heflin, Sec'y, 2501 Addison St.

Metro Movie Club of River Park (8mm and 16mm)—J. W. Claywell, Sec'y, 5100 N. Francisco Ave. Meet every Wednesday night.

Shutter Snapper Club—Faith Church, Pine and Augusta.

South Side Cinema Club (8mm and 16mm)—Caroline Hetzner, Sec'y, 7321 Lawrence Ave. Meet 2nd and 4th Wednesday each month.

The Camera Adventurers' Club (8mm)—Mrs. Frank H. Crowe, Sec'y, 5916 N. Paulina.

Triangle Cinema League of Chicago (8mm and 16mm)—Leo Brooks, Sec'y, 1528 S. Harding Ave. Meet Sunday afternoons, once or twice a month.

Westlawn Cinema Club—Walter Sengstock, Sec'y, 1517 S. Kostner Ave.

EVANSTON: Northwestern Amateur Club.

HOMEWOOD: 3H Camera Club, Movie Division—George Durand, Sec'y, 1750 Linden Rd.

OTTAWA: Ottawa Cine Club—C. F. Grover, Sec'y.

PEKIN: Pekin Cinema Club (8mm and 16mm)—Howard E. Miller, Sec'y, Box 262. Meet every other Monday night.

PEORIA: Peoria Cinema Club, Inc. (8mm and 16mm)—Miss Lena R. Hoerr, Sec'y, 1102 Frye Ave. Meet every 3rd Tuesday.

ROCKFORD: Rockford Amateur Movie Club.

ROCK ISLAND: Tri-City Cinema Club (8mm and 16mm)—Albert N. Mueller, M.D., 550 26th St. Meet 4th Friday each month.

INDIANA

ELKHART: Conn Camera Club—Florindo Viti, Sec'y, Conn Entertainment and Athletic Ass'n.

FORT WAYNE: Fort Wayne Amateur Cinema Club (8mm and 16mm)—B. J. Olander, Sec'y, 2560 E. Brook Dr. Meet 2nd Monday each month.

HAMMOND: Calumet Movie Makers (8mm and 16mm)—Gladys Patrick, Sec'y, 5411 Price Pl. Meet every 3rd Monday.

INDIANAPOLIS: Indianapolis Amateur Movie Club (8mm and 16mm)—Alfred F. Kaufman, Sec'y, 4623 N. Arsenal Ave. Meet 1st and 3rd Wednesday each month.

Super-Art Productions of Indianapolis—W. Stuart Bussey, 17 E. St. Joseph St. Public Service Company Camera Club—James Genders, Sec'y, 4935 W. 11th St.

VINCENNES: Vincennes Camera Club (8mm and 16mm)—Robert M. Johnson. Meet 1st Thursday.

IOWA

DES MOINES: Y. M. C. A. Movie and Camera Club of Des Moines (8mm and 16mm)—Mary H. Platt, Sec'y, 3223 2nd St.

SIoux CITY: Amateur Cinema Club of Sioux City (8mm and 16mm)—Don Goodwin, Sec'y, 3733 7th Ave. Meet 3rd Tuesday each month at Hunt School.

KANSAS

PRATT: Camera Club—16mm and 8mm)—Benjamin F. Henry, First Presbyterian Church.

WICHITA: Wichita Amateur Movie Club—Mrs. Martin Lentz, Sec'y, Martin W. Lentz Co., 111 W. William St.

MASSACHUSETTS

ATTLEBORO: Attleboro Movie Club—Francis J. O'Neil, 37 Pleasant St.

BOSTON: Boston Cinamateur Club (8mm and 16mm)—Fannie Tinkham, Sec'y, Cambridge Photographic Society, 631 Massachusetts Ave. Meet 2nd and 4th Mondays.

LOWELL: Lowell Amateur Cinema Club—Leslie R. Lawson, Sec'y, 311 Westford St.

LYNN: Greater Lynn Camera Club, Movie Division—Max Hurwitz, Sec'y, 46 Central Square.

PITTSFIELD: Berkshire Museum Camera Club (8mm and 16mm)—A. C. Hindle, Sec'y, 19 North St. Meet 2nd Wednesday each month.

SOUTHBRIDGE: ★Southbridge Amateur Movie Makers Club (8mm and 16mm)—Joseph R. Seremet, Sec'y, 124 Highland St. Meet 2nd Friday each month.

MICHIGAN

BATTLE CREEK: Photographic Society of Battle Creek (8mm and 16mm)—Neil E. Elliott, Sec'y, 215 Fairfield Ave.

DETROIT: Detroit Society of Cinematographers (8mm and 16mm)—James A. Harris, Sec'y, c/o McGregor Library. Meet 4th Monday.

FLINT: Flint Amateur Movie Club—Lynn J. DePree, 2006 Mountain Ave. Meet 1st Wednesday each month.

JACKSON: Jackson Amateur 8mm Camera Club (8mm)—Lila O. Redinger, Sec'y, 1040 S. Jackson St. Meet 3rd Friday each month.

KALAMAZOO: Kalamazoo 8mm. Cinematographers—(8mm)—Grant Kinch, Pres., 806 S. Park. Meet 1st and 3rd Thursdays.

LANSING: Capitol Camera Club (8mm and 16mm)—R. B. Gould, Sec'y, 1414 Corbett St. Meet 2nd Monday each month.

LAPEER: Lapeer Cinema Club (8mm and 16mm)—Peter Skeberdis, Sec'y, 1665 Inlay City Rd. Meet 3rd Tuesday of each month.

PONTIAC: ★Pontiac Amateur Cinematographers (8mm and 16mm)—Welton J. Jones, 583 E. Tennyson. Meet 1st Monday each month.

SAGINAW: The Saginaw Movie Club (8mm and 16mm)—Clarence R. Krueger, Sec'y, P. O. Box 671. Meet every other Thursday.

MINNESOTA

AUSTIN: Austin Camera Club (8mm and 16mm)—Lon Enochson, Sec'y, 205 N. 2nd St. Meet 2nd Tuesday each month.

MINNEAPOLIS: Minneapolis Octo-Cine Guild (8mm)—C. G. Crosby, Sec'y, 5617 12th Avenue S. Meet last Thursday each month.

Minneapolis Cine Club (8mm and 16mm)—Dr. Reinhold Ericson, Sec'y, c/o R. A. Riebeth, P. O. Box 22, Commerce Station, Minneapolis.

Suburban Cine Club (8mm and 16mm)—J. M. Devoy, Sec'y, 309 Blake Rd., Hopkins. Meet last Thursday.

ST. PAUL: Gopher Movie Club (8mm and 16mm)—Mrs. L. T. Thiets, Sec'y, 580 Wentworth. Meet last Friday each month.

St. Paul Amateur Movie Makers (8mm and 16mm)—Walter Gayman, Sec'y, 314 W. Kellogg Blvd. Meet 1st and 3rd Tuesday each month.

Metropolitan Cine Club (8mm and 16mm)—T. C. Hotchkiss, Sec'y, 303 S. Cleveland Ave. Meet 1st and 3rd Wednesdays.

MISSOURI

KANSAS CITY: The Heart of America Movie Club (8mm and 16mm)—Cooper Jenkins, Sec'y, 616 W. 26th St. Meet 1st Monday of each month.

Kansas City Cinema Club (8mm and 16mm)—E. P. Witte, Sec'y, 3125 Broadway. Meet 2nd and 4th Wednesday each month.

ST. JOSEPH: St. Joseph Amateur Movie Camera Club (8mm and 16mm)—Ruthanna Beard, Sec'y, 610 E. Missouri Ave. Meet 2nd and 4th Wednesdays.

ST. LOUIS: Amateur Motion Picture Club of St. Louis (8mm and 16mm)—Miss Eloise Koch, Sec'y, 2738 Accomac St. Meet 2nd Wednesday each month.

MONTANA

BILLINGS: Billings Movie Club—Louis M. Moos, Sec'y, 311 Wyoming.

NEW JERSEY

BAYONNE: Bayonne Cine Club (8mm and 16mm)—Thos. A. Dolan, Sec'y, 232 Danforth Ave., Jersey City. Meet 2nd and 4th Fridays.

CLIFTON: Clifton Cinema Club (8mm and 16mm)—J. G. Elgersma, Sec'y, 43 Sears Pl.

EAST ORANGE: Cinema Club of the Oranges (8mm and 16mm)—Herbert A. Smith, Sec'y, 541 Main St. Meet 3rd Friday.

MILLBURN: Gibraltar 8mm Club (8mm)—M. H. Sanders, 85 Greenwood Dr.

• Continued on Next Page

Directory Of Cine Clubs

• Continued from Preceding Page

MAPLE SHADE: The Wedgewood-Draper Club (8mm)—William Hoover, Sec'y. Meet 2nd and 4th Wednesdays.

MAPLEWOOD: The Maplewood Amateur Movie Club (8mm and 16mm)—Mrs. Fred W. Miller, Sec'y, 13 Rynda Rd.

NUTLEY: ★ Cineman Club of North Essex (8mm and 16mm)—J. E. Nestell, Sec'y, 18 Shepard Pl. Meet 3rd Thursday each month.

PASSAIC: Passaic Y. M. C. A. Cinema Club.

TRENTON: Trenton Movie Makers (8mm and 16mm)—Jules Y. Shein, Sec'y, 521 S. Warren St. Meet either 1st or 2nd Friday each month.

NEW YORK

BINGHAMTON: Cinema Club of the Triple Cities—Edwin Moody, Sec'y.

BRONX: Bronx Amateur Cinema Club (8mm and 16mm)—Nicholas H. Zella, Sec'y, 384 E. 193rd St.

BROOKLYN: Brooklyn Amateur Cine Club—Irving Pollock, Pres., 91-01 64th Rd., Rego Park, L. I. Meet every two weeks.

BUFFALO: Amateur Cinema Club of Buffalo—Edward C. Denny, Sec'y, 385 La Salle Ave.

Niagara Cinema League (8mm and 16mm)—K. N. Hadley, Sec'y, 103 Villa Ave. Meet 3rd Wednesday each month.

ELMIRA: Y. M. C. A. Movie Club (8mm and 16mm)—H. M. Shinn, Jr., Sec'y, Y. M. C. A. Meet 1st Monday each month.

JOHNSON CITY: I. B. M. Cinematographer's Club—W. M. Muir, Pres., R. D. No. 2.

LONG ISLAND: Queens Cine Club (8mm and 16mm)—Jack Jacoby, 103-17 125th St., Richmond Hills, L. I.

MOUNT KISCO: Mount Kisco Cinemas (16mm)—Robert F. Gowen, Sec'y, Chilmark Park, Assinung, N. Y. Meets 1st Monday of each month.

MOUNT VERNON: Mount Vernon Movie Makers (8mm and 16mm)—N. W. Knight, Sec'y, 258 Westchester Ave. Meet 3rd Tuesday.

NEWBURGH: Newburgh Amateur Cinema Club (8mm and 16mm)—Robert S. Kelly, Sec'y, 217 North St. Meet 2nd Thursday each month.

NEW YORK CITY: Metropolitan Motion Picture Club, Inc. (8mm and 16mm)—Robert M. Coles, Sec'y, 35 E. 20th St. Meet 2nd Thursday each month.

Graphic Photo Guild—1924 Washington Ave. Nat Rosenthal, Recording Sec'y.

New York City 8mm Motion Picture Club—Walter C. Mills, 35 Park View Rd., Bronxville. Meet 3rd Monday.

Telephone Camera Club of Manhattan—Thos. G. Herenden, Room 1958, 195 Broadway.

PEEKSKILL: Peekskill Sport Center, Inc.—830 South St.

PEEKSKILL: Peekskill Cinema Club (8mm and 16mm)—J. J. Billings, Sec'y, 830 South St. Meet 3rd Monday.

ROCHESTER: Rochester Amateur Movie Club (8mm and 16mm)—D. W. MacFarlane, Sec'y, 52 Edgemond Rd. Meet 1st and 3rd Thursdays each month.

ROCKVILLE CENTER, LONG ISLAND: Rockville Amateur Cinema Club.

SCHENECTADY: Schenectady Photographic Society, Cine Group (8mm and 16mm)—H. M. Webber, Sec'y, 1279 Dean St. Meet 1st Wednesday of each month.

STATEN ISLAND: Staten Island Cinema Club (8mm and 16mm)—Frank E. Gunnell, Sec'y, 34 Colonial Court, West New Brighton. Meet 2nd Tuesday each month.

Staten Island Movie Makers (8mm and 16mm)—Harry S. Wilson, Sec'y, 34 Rokeby Pl.

SYRACUSE: Syracuse Amateur Movie Makers (8mm and 16mm)—Benjamin Franklin, Sec'y, 221 Marguerite Ave. Meet every other Monday.

VALLEY STREAM, LONG ISLAND: Valley Stream Camera Club (8mm and 16mm)—John H. Trunk, Sec'y, 152 Locust Blvd. Meet 1st and 3rd Wednesday each month.

NORTH CAROLINA

MORGANTON: Morganton Camera Club, Movie Division—Edw. H. Hairfield, Jr., Sec'y, Box 793.

OHIO

AKRON: Buckeye Camera Guild (8mm and 16mm)—W. G. Marksity, Sec'y, 1080 Brown St. Meet every other Monday.

CLEVELAND: Aremac Club (8mm and 16mm)—L. C. Neuffer, Pres., Box 1719. Meet every 3rd Tuesday.

Cleveland Amateur Cinematographers (8mm and 16mm)—Miss Dorothy Boetticher, Sec'y, 1394 W. 3rd St.,

c/o Strong, Carliss & Hammond Co. Meet 1st and 3rd Wednesdays each month in Hotel Carter.

COLUMBUS: Columbus Movie Makers—Arthur Robinson, Sec'y, 34 N. 3rd St.

DAYTON: Cinema Research Club—F. H. Bickford, Jr., Chairman, 1529 S. Broadway.

Dayton Cinema League—P. C. Beach, Sec'y, 2240 E. 5th St.

FINDLAY: Findlay Camera Club—Ralph L. Stears, Sec'y, 208 Lark St.

GALION: Galion Camera Club (8mm and 16mm)—Mary Postance, Sec'y, 377 N. Market St. Meet 1st and 3rd Tuesdays each month.

HAMILTON: The Movie Makers Club—Clinton W. Bergen, Pres., 1269 Harmon Ave.

MANSFIELD: Mansfield Movie Club—Dr. L. B. McCullough, 78 Park Ave. W.

MOUNDSVILLE: Trojan Production Co.—Jacquelyn Rusen, Sec'y.

MOUNT VERNON: Mount Vernon Camera Club (8mm and 16mm)—Frank J. Van Vorhis, Sec'y, 306 N. Main St. Meet 1st and 3rd Tuesdays each month.

NORTH CANTON: North Canton Cinema Club (8mm and 16mm)—R. L. Wearstler, Sec'y, R. D. 6, E. Maple St. Ext. Meet 1st Friday each month.

SPRINGFIELD: Springfield Cinema Club—C. O. Harrison, Sec'y.

TOLEDO: The Toledo Cine Club (8mm and 16mm)—517 Madison Ave. H. Kline, Sec'y, 4613 Whitford Rd. Meet 3rd and 4th Mondays.

NEWARK: YMCA Movie Makers (8mm and 16mm)—C. I. Grimm, Pres., Arcade Annex. Meet 1st and 3rd Wednesdays.

WOOSTER: Wooster Amateur Movie Makers (8mm and 16mm)—Howard W. Keister, Sec'y, 218 W. University St. Meet 3rd Monday each month.

YOUNGSTOWN: Youngstown Amateur Movie Club (8mm and 16mm)—Fred Deiter, Sec'y, 52 Wesley Ave. Meet 1st and 3rd Mondays.

OKLAHOMA

NAWATA: Nawata Cine Club—Audrey Albin, Sec'y, 514 N. Pine.

OKLAHOMA CITY: Cinematographer Club (8mm and 16mm)—H. P. Douglass, Sec'y, 1909 N. W. 27th. Meet 3rd Friday each month.

Oklahoma City Movie Club—Alex McDonald, Pres., 721 N. W. 29th St.

TULSA: Tulsa Am-Mo Club—J. B. Close, Pres., Box 854. Meet 1st and 3rd Wednesdays.

OREGON

MEDFORD: Medford Movie Club (16mm)—Mrs. George F. Tucker, Sec'y, 37 Kenwood Ave. Meet 3rd Saturday.

NORTH BEND: Coos Bay Camera Club (8mm and 16mm)—Ernest Kollins, General Delivery.

Southern Oregon Cinema Club—W. Bernard Roberts, Pres., 922 Reddy Ave.

PORTLAND: Portland Cine Club, Inc.—Arthur E. Gibbs, Sec'y, 324 S. W. Stark St. Meet every two weeks.

PENNSYLVANIA

ALLENTOWN: Allentown Y. M. C. A. Cinema Club—Aral M. Hollenbach, Sec'y, 1229 N. 19th St.

LEBANON: Lebanon Valley Camera Club (8mm and 16mm)—George Kline, Sec'y, 470 N. 4th St.

NORRISTOWN: Mrs. Mary Leonard, Sec'y (8mm and 16mm), 618 De Kalb St. Meet every 3rd Monday.

PHILADELPHIA: ★ The 8-16 Movie Club—Louis Sobel, Sec'y, 4916 Ormes St.

Philadelphia Cinema Club (8mm and 16mm)—George A. Pittman, Sec'y, 1808 E. Tulpehocken St. Meet 2nd Tuesday each month.

8-8 Club (8mm)—Mrs. Robert H. Connor, Sec'y, 6707 Linmore Ave. Meet 1st and 3rd Thursday each month.

PITTSBURGH: Pittsburgh Amateur Cinema Club (8mm and 16mm)—Miss Rose Goldman, Sec'y, 319 Amber St. Meet 1st and 3rd Wednesday each month.

Amateur Cinematographers of East McKeesport—J. J. Carbaugh, P. O. Box 1466.

North End Cinema Club (8mm and 16mm)—R. C. Straka, Sec'y, 1711 Harpster St., N. W. Pittsburgh. Meet 1st and 3rd Tuesdays of each month, North Borough's Y.M.C.A., 629 Lincoln Ave., Bellevue.

POTTSTOWN: Pottstown 8mm Movie Club (8mm)—Wm. J. Weiss, Sec'y, 874 N. Charlotte St. Meet 1st Tuesday each month.

READING: Berks Camera Club (8mm and 16mm)—Stephen Lawrence, 310 N. 12th St. Meet every Monday night.

SUNBURY: Sunbury Amateur Cinema Club (8mm and 16mm)—David Lenker, Sec'y, 346 Chestnut St. Meet 1st and 3rd Mondays.

SOUTH DAKOTA

SIoux FALLS: Sioux Falls Amateur Cine Club—(16mm and 8mm)—H. Hanson Harold's, 308 S. Phillips Ave. Meet 1st Monday each month.

YANKTON: Yankton Camera Club. Arthur J. Smith, Pres., 414 Capitol St.

TENNESSEE

JACKSONVILLE: Jacksonville Movie Makers, P. O. Box 56.

MEMPHIS: W. G. Snowden, Sec'y, Box 2073, DeSoto Sta.

TEXAS

DALLAS: Dallas Cine Club—Stan Evertman, Pres., 1504 Young St.

FORT WORTH: Movie Makers Club (8mm and 16mm)—J. C. Duvall, Pres., 60 Burk-Burnett Bldg.

UTAH

LOGAN: Logan Amateur Cinema Club (8mm and 16mm)—Mrs. E. L. Hansen, Sec'y, Logan, Utah.

SALT LAKE CITY: Utah Amateur Movie Club (8mm and 16mm)—C. F. Solomon, Jr., Sec'y, 1471 Browning Ave. Meet 2nd Monday of each month.

VIRGINIA

LYNCHBURG: Hill City 8 Movie Club (8mm)—Nowlin Puckett, Corresponding Sec'y, 822 Floyd St. Meet once month.

NORFOLK: Norfolk Amateur Movie Club (8mm and 16mm)—Claude D. McMillan, Jr., Sec'y, 720 Carolina Ave. Meets 3rd Tuesday.

WASHINGTON

SEATTLE: Northwest Amateur Cinema League—Carlos E. Grant, 915 Green Bldg., Seattle Wash.

Roosevelt Movie Club (16mm)—Jayn Stokes, Sec'y, Roosevelt High School, 2032 Franklin Ave. Meet every other Wednesday.

★ Seattle 8mm Club (8mm)—W. B. Bowden, Sec'y, 546 Dexter Horton Bldg. Meet 2nd Tuesday each month.

TACOMA: Tacoma Cinema Club (16mm)—Don Flag, Sec'y, 829 S. Ferry St. Meet 4th Monday each month.

WALLA WALLA: Walla Walla Cinema Club (8mm and 16mm)—Cromie L. Wilson, Sec'y, 715 Catherine St. Meet 4th Monday.

WENATCHEE: Wenatchee Cine Club—Rlwood Johnson, Sec'y.

YAKIMA: Yakima Amateur Movie Club (8mm and 16mm)—William Hassell, Pres., 1208 W. Yakima Ave. Meet 4th Wednesday.

Amateur Movie Club: Paul Thompson, Pres., 709 S. 4th St.

WEST VIRGINIA

HUNTINGTON: Huntington YMCA Amateur Movie Club (8mm and 16mm)—James Wartell, Sec'y, 629 6th St. Meet each 3rd Friday.

TRIADPHIA: St. Vincent's Cinematography Club—E. Dietrich, Rt. 1, Box 93.

WHEELING: ★ Cinematography Group of the Ohio Valley Camera Club (8mm and 16mm)—R. E. Dempster, 1615 15th St. Meet every other Friday.

WISCONSIN

FOND DU LAC: Fond du Lac Camera Club (8mm and 16mm)—Miss Mildred E. Weber, Sec'y, 333 S. Marr St. Meet 4th Monday each month.

MADISON: Cine 8 Club—Ruth Hoffman, Sec'y, 535 W. Dayton St. Meet 1st Tuesday each month.

Maple Bluff Camera Club—John B. Casaday, Sec'y, 1005 Power & Light Bldg.

MILWAUKEE: The Amateur Movie Society of Milwaukee (8mm and 16mm)—Miss Parmelia M. Mills, Sec'y, 530 N. 20th St. Meet 2nd and 4th Wednesday.

Cream City Cinema Club—E. R. Glaesner, Sec'y, 3730 W. Lisbon Ave.

Milwaukee Movie Makers—Harold Francke, Sec'y, 1926 E. Fernwood Ave.

NEENAH: The Winnebago Camera Club Movie Division—Duane Raiche, Sec'y, 247 4th St.

WYOMING

CASPER: Casper Amateur Motion Picture Club (8mm and 16mm)—A. F. Everitts, Sec'y, 1544 S. Cedar St. Meet 1st Tuesday each month.

CANADA

CALGARY, ALBERTA: Calgary Amateur Motion Picture Club (8mm and 16mm)—Mrs. A. F. McKenna, 2316 2nd St. W. Meet 3rd Thursday each month.

EDMONTON, ALBERTA: The Edmonton Cine Club (8mm and 16mm)—H. B. Holloway, Sec'y, Ste. 2, 10617 98th Ave. Meet 1st and 3rd Monday each month.

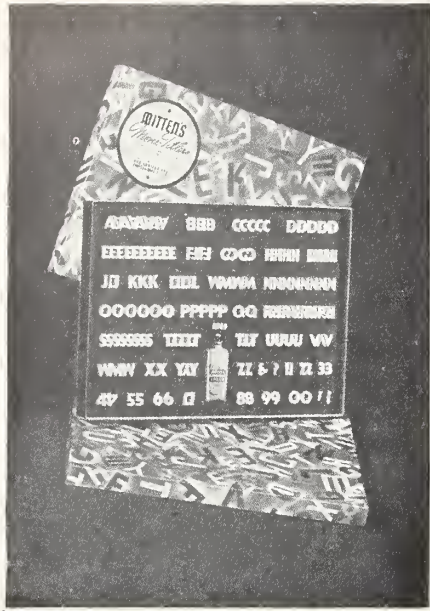

TITLES
make movies
talk for
themselves!

Why not take full advantage of the pleasures of your hobby? When you foil to title your films . . . you foil to enjoy the thrill of making a real finished home movie.

Ask your dealer about the PIN AND SANDED BACK TITLE LETTER SETS. They are ideally suited for making theatre quality titles with any 8mm or 16mm camera.

PIN LETTER SETS

\$5.50 Up

SANDED BACK LETTER SETS

\$4.75 Up

Write for Descriptive Literature and Information on Our Complete Line of Letters

MITTENS LETTER COMPANY

REDLANDS, CALIFORNIA



ORDER FOR SUBSCRIPTION

Home Movies Magazine

12 MONTHS FOR \$2.00 IN U. S.

In Canada, \$2.00; Foreign—\$3.00

SPECIAL OFFER: 3 Years for \$5.00 in the U. S.

HOME MOVIES

Sunset Blvd.
Beverlywood, Calif.



Send to.....

Address

City..... State.....

New Renewal Gift

Send to.....

Address

City..... State.....

New Renewal Gift



Enclosed find \$..... Date.....19.....

Sent in by.....

Address

City..... State.....

NO SUBSCRIPTIONS ACCEPTED FOR LESS THAN ONE YEAR

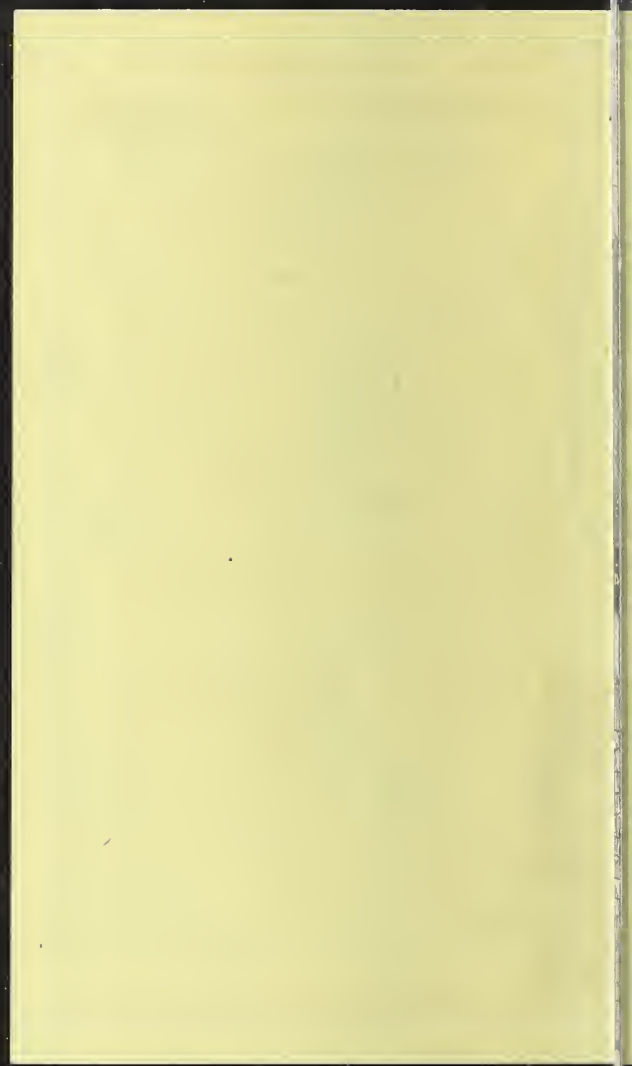

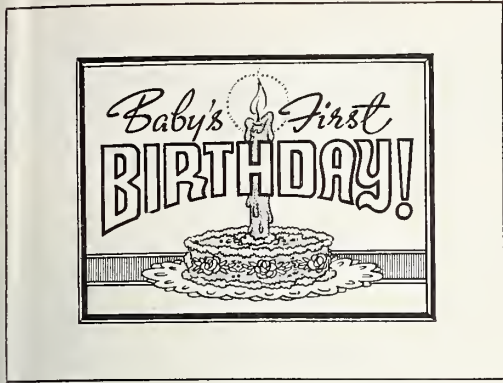

TITLE Backgrounds



By EDMUND TURNER

WITH vacation and general summer filming nearing a close, the season approaches for the amateur to get his "home work" done—editing, titling, etc.—especially titling. HOME MOVIES has made the task of titling a great deal easier for the amateur by publishing a series of artistic title backgrounds each month, and by providing a simple method for lining up these titles with his camera by means of the title centering guides now being published each month in this magazine. For further data regarding this feature, turn to the page of Title Centering Guides in this issue.

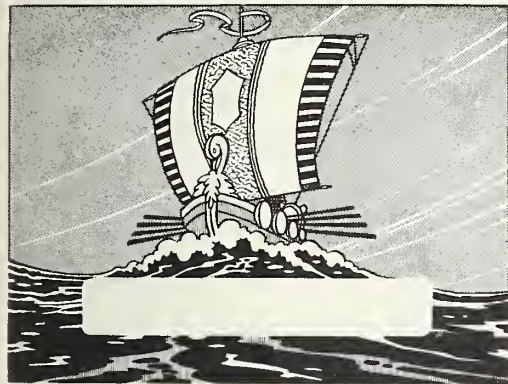

...

Quite consistently now we have published this page of title backgrounds, backed up by an advertising page that would permit cutting out the backgrounds without mutilating important editorial matter. Many amateurs now cut these backgrounds from the magazine each month and file them away in a small 3"x5" card file appropriately indexed according to the various classifications in which the titles might fall, such as Vacations, Baby Pictures, End Titles, etc.

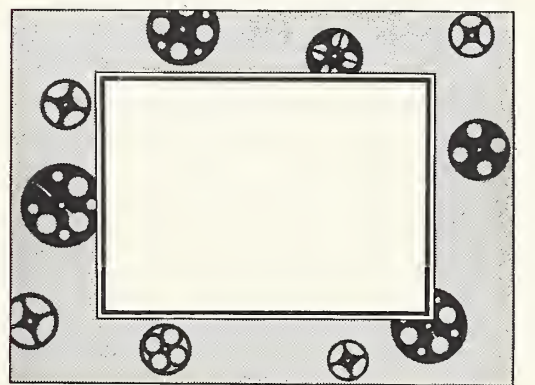
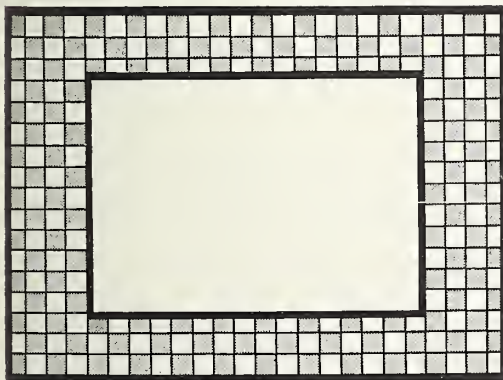

...

HOME MOVIES has available other title backgrounds printed on a good grade of paper and packaged in sets of 25 which sell for 50c per set. They are available for either black and white films or Kodachrome. In ordering, specify Set No. 1 for black and white, and Set No. 2 for Kodachrome. The titles in each set are the same, except that those for Kodachrome are printed in colored inks on colored stock.



...

CLASSIFIED

ADVERTISING

EQUIPMENT FOR SALE

● BASS SAYS: September—Autumn—Colors. Get ready!

USED CAMERAS

DeVry 57, F:3.5 lens, \$19.50.
100-foot Cine B, F:3.5 lens, \$24.50.
Filmo Magazine 121, Cooke, F:2.7 lens, \$47.50.
Super Speed Filmo 70, F:1.5 lens, \$75.00.
8mm Movikon, F:2 lens and case, \$137.50.
16mm Movikon, Sonnar F:1.5 and case, \$295.00.
Latest Cine Special, F:1.9 lens, \$307.50.

FADE-OUTS AND EFFECTS

Fadette, fits most lenses, complete, \$5.95.
Transito, the great new device for wipes, \$9.95.
Boo-Fader, a big seller, complete 64 effects, \$17.50.
Fade-O-Scope, a new Polaroid Fader, \$18.75.

NEW EQUIPMENT

The new RCA 16mm S. O. F. Model PG 170, 750-watt Projector, complete, \$300.00.
The new Revere Double 8 Camera with F:3.5 lens, \$29.50.
New Revere Double 8 Turret Camera with F:2.5, \$65.00.
New Revere Double 8 Model B Projector, 500-watt, \$59.50.

Ready in September, the great new 84-page BASS CINE BARGAINGRAM, most complete book ever published. Write for your copy.

BASS CAMERA COMPANY

Dept. HC, 179 W. Madison St., Chicago, Ill.

● FULL LIST PRICE ALLOWED FOR: Eastman Model 20 toward a new Bell-Howell Sportster. Kodascope EE toward Bell-Howell Filmo-Master. Eastman 8mm Model 25 or Bell-Howell Sportster toward a Bell-Howell Turret or an 8mm Bolex. 500-watt Keystone toward a new Bell & Howell 8mm projector. NEW MAGAZINE CINE EIGHT FOR IMMEDIATE DELIVERY. Full list price for your Model 20 or 25 Eastman, for Keystone F:3.5 or F:2.7, or for Bell-Howell Companion toward this camera. AS NEW: Bell-Howell Sportster with Wind-Bak, \$75. Bell-Howell Companion with Wind-Bak, \$49.50. Bell-Howell Turret with Wind-Bak, \$129.50. Eastman 16mm Magazine, F:1.9, \$75. 1" F:1.3 Laack Lens, \$39.50. 15mm F:1.5 Dallmeyer lens, \$49.50. 3" F:4 Wollensak, \$29.50. 30x40 beaded screen with tripod, \$7.95; 36x48, \$10.50; 39x52, \$12.50. Hundreds of other bargains. Write NATIONAL CAMERA EXCHANGE, established 1914, 11 South 5th St., Minneapolis, Minn.

● NEW HEAVY DUTY Metal Freehead Tripods, list \$27.50, now \$18.50; 70DA, F3.5, F.M.; Filters; Case, \$98.50; Craig Editor, \$25.00; Keystone Strobo Editor, complete, \$27.50; 1" Biotar F1.4, F.M., \$55.00; 2" \$75.00; 2" F3.5, F.M., \$24.50; 3" \$26.50; RCA 16mm Sound Camera, complete, 400-ft. Magazines, Motor, Amplifier, Cases, Tripod, \$675.00. Other bargains; free Bargain Bulletin No. 103. CAMERA MART, Dept. G, 70 West 45th Street, New York.

● DE LUXE VICTOR Model 5 with turret, backwind, critical focuser, 1" f/3.5 Taylor-Hobson lens, 15mm Wollensak f/2.7 lens with viewfinder piece. Has variable shutter (operates either manually or automatically), producing perfectly smooth fades and dissolves; frame counter; and extra footage counter. In excellent condition, guaranteed, cost \$280.00. Will sell for cash, \$160.00. DR. RICHARD WIERENGA, 737 Leonard St., N.W., Grand Rapids, Mich.

● 16MM ENLARGER. Made by Eastman, with projector for lamphouse. Gives enlargement approximately 4x5 of your 16mm frame. Can also be used as viewer for editing. Originally sold for \$90.00. The first \$20.00 takes it. Perfect condition. Box RR, Home Movies Magazine, 6060 Sunset Blvd., Hollywood, Calif.

● FULL price for your Eastman 20, Keystone 3.5, or Revere 3.5 on Eastman Magazine 8. Bolex H-16, Hektor lens, slightly used, including DeLuxe case, \$229.00. Better deal at FINNS, 118 South Robert St., St. Paul, Minn.

● PROJECTOR, combination 16mm and 8mm Ditmar. You can show either 16mm or 8mm pictures on this 500-watt projector. Switchover very simple. Original price more than \$200.00. For quick sale, \$125.00, A-1 condition. Box RT, Home Movies Magazine, 6060 Sunset Blvd., Hollywood, Calif.

● PAILLARD BOLEX Headquarters for the West is Morgan Camera Shop. Try the multi-featured Bolex 16mm or 8mm camera before buying. See them at 6262 Sunset Blvd., Hollywood, California.

● AMPRO PROJECTOR—Practically new, 16mm, 750-watt, pilot light, new bulb, fully reconditioned. Cost \$175, will sacrifice for \$95.00. Box 5, HOME MOVIES, 6060 Sunset Blvd., Hollywood, Calif.

● BARGAIN—Victor 16mm camera, f/1.5, \$58.00. Case, \$5.00. Keystone 300-500-watt projector, \$30.00, excellent condition. KAMM, 710 Keeler, Berkeley, Calif.

● FOR SALE—Bell & Howell 16mm sound projector, both speeds. Complete with accessories and extras. Almost new. Sacrifice price. WRITE BOX 821, Wilmington, Del.

● WRITE for list of more than 100 articles at bargain prices, both movie and still equipment. FLOYD A. SEARS, Oquaga Lake, Deposit, N.Y.

● Ten cents per word; minimum charge, \$2.00 cash with order. Closing date, tenth of preceding month. ● HOME MOVIES does not guarantee goods advertised. ● Send ads to 6060 Sunset Boulevard, Hollywood, California.

EQUIPMENT FOR SALE

● MOVIE Cameras, Films, Projectors, etc., bought, sold, and exchanged. Big lists Free. Art samples, 25c. PEERLESS, Box 1310-H, Hollywood, Calif.

● UNIVEX Projector, with screen, used, \$9.95; Camera, \$4.00; Excel Projector, \$36.95; RCA Sound Projector, \$300. High allowance for trade-ins. Send for Free fall bargain list of movie and still equipment and film catalog. W. N. GRAVLEE & SON, Kennedy, Alabama.

EQUIPMENT FOR SALE

● 4 STAR ★★★★★ movie products are designed to fill your cine needs. 4 STAR Movie Screens in standard sizes, prices from \$3.95 up. Special sizes to fit your home theatre needs can be made up at reasonable prices on order. Hollywood Cine Products Co., 3221 South Figueroa, Los Angeles, Calif.

● 16mm KODASCOPE "G," 750-watt, \$85.00. 16mm DeVry Challenger, 1200-watt professional projector, \$135.00. 16mm Cine Kodak BB, f/3.5, \$22.50. STRAND THEATRE, Warsaw, Indiana.

Ready . . .
NOVEMBER 1st!

**HOME MOVIE
GADGETS**

A new book containing over 100 illustrations and descriptions of handy gadgets any amateur can build for special effects, titling, lighting, photography, etc.

PRICE **\$1.00** COPY

Reserve Your Copy Today!

VER HALEN PUBLICATIONS

6060 Sunset Boulevard

Hollywood, Calif.

ACCESSORIES

● MODERNIZE your Eastman 20, 25, or 60 for \$15.00 with a windback. Make professional transitions. Send stamps for information. MOVIE CAMERA SUPPLY CO., 1833 Beechwood, Highland Park, St. Paul, Minnesota.

● WESTON Exposure Meter, new "Master" in box, \$17.50—good buy. Write to E. C. WALLIS, 617 12th St., N.W., Washington, D. C.

FILM RELEASES (8 and 16mm)

● WRITE FOR our new 8mm rental catalog. Films shipped everywhere. No extra charge for shipping. We pay both ways, express or parcel post. ABBE FILMS, 1265 Broadway, New York City.

● REAL "ART" Film. Send 10c today for generous prepaid sample; big illustrated catalogs included. CINEART, 2443-B Gunnison, Chicago.

● ART MOVIES—take them yourself. 10c brings sample and information. REELIFE, 4234 Lincoln Ave., Chicago.

● 40 ADDITIONAL Features in new Free catalog. 16mm silent rentals, 7 reels, \$2.25. ARTS, ASHA FILMS, 785 St. Johns, Brooklyn, N. Y.

● UNUSUAL ART Film Catalogue. All latest releases. Send 10c for sample. ERWINES CINE LABORATORIES, 143 North Ninth St., Allentown, Pa.

● 8mm EXCHANGE Library. Purchase first print, \$5.50. Monthly exchange privilege, \$1.00. Latest new releases. RIEDEL FILMS, 2221 West 67th St., Cleveland, Ohio.

● "ARTFILM" As You Like It! One thin dime brings big prepaid sample, catalogs, amazing GIFT offers! PARISIAN, 4228-D Lincoln, Chicago.

● LATEST 8-16mm War, Comedy, Travel, Unusual Subjects. Send 10c for sample and lists. A personal service. RIO, 413-H Elmira, N. Y.

FILM

● SPECIAL! 100' 16mm Weston-16 film, \$3.40 processed. Also 8mm, 16mm film bulk. Cameras, Projectors, Accessories, Castle Films library. Write your wants. R. C. CAMERA & PHOTO SUPPLY CO., 3357 E. 66 St., Cleveland, Ohio.

● MOTION PICTURE FILM, daylight loading. Weston 8, processing included. 100 ft. 16mm—\$2.00. 50 ft. 16mm—\$1.25. 25 ft. 8/8mm—75c. Write for price list. RITTER FILM SERVICE, 629 Lyman Ave., Oak Park, Ill.

TITLING SERVICE

● DON'T leave those vacation films and valuable family record films go untitled. Write for our illustrated (FREE) literature showing the beautiful . . . professional titles you can make easily with Pin Letters. Letters are available in sets or can be purchased individually. PIN LETTERS are made in all sizes from 3/4" to 9". Write now to Mittens Letter Co., Dept. HM, Redlands, California.

● END AND CREDIT Titles Free with 8 B. & W. or 6 tinted titles for \$2.00. We help make your films interesting. WHITEMAN'S 16mm SERVICE, 312 E. 7th St., Clovis, N. M.

● SUNBEAM Kodachrome titles, 8 and 16mm. Professional, glowing colors. Sample Free! W. C. KANE 102 Gibbs St., Rochester, N. Y.

WANTED

● WILL TRADE for wide angle or Telephoto lens for 16mm Victor camera, private collection of accessories, including 35mm Candid Camera with automatic film transport for shooting pictures in rapid sequence; Willo exposure meter; Maxim exposure meter; Craig Junior 8mm-16mm film splicer; and Monocolor Viewing Glass. BOX 7003, HOME MOVIES, 6060 Sunset Blvd., Hollywood, Calif.

● WANTED—Bolex 16mm Camera. Give full description and cash price in first letter. P. O. BOX 2323, Reno, Nevada.

● WANT Berndt-Maurer Recorder. Will purchase or trade. Large list equipment. Air-mail serial number, information, and consideration. R. R. HUTCHISON, Pullman, Wash.

CAMERAS AND PHOTO SUPPLIES

● MAKE money in photography. Learn quickly at home. Easy plan. Previous experience unnecessary. Common school education sufficient. Interesting booklet and requirements free. AMERICAN SCHOOL OF PHOTOGRAPHY, 3601 Michigan Avenue, Dept. 263C, Chicago.

PROCESSING SERVICE

● REVERSAL OR NEGATIVE processing, 100 ft. 16mm, 75c; 50 ft. 16mm, 50c; 25 ft. double 8mm, 35c; 25 ft. 8mm, 25c. RITTER FILM SERVICE, 629 Lyman Ave., Oak Park, Ill.

MISCELLANEOUS

● BACK ISSUES "Home Movies" magazine—January, February, March, April, and May, 1940—25c per copy while supply lasts. HOME MOVIES, 6060 Sunset Blvd., Hollywood, Calif.

A New Sensational Movie Titler!

4 STAR ★★★★★ TITLEER

Designed by Hollywood Motion Picture
Studio Technicians for 8mm and
16mm Camera Users

*Superior construction
with brand
new features never
before offered in
the low price field!*

★ LARGE TITLE AREA

Title cards may be photographed at 4", 6", 8" and 12" distances. At 12" a larger size card with a "field area" of 3¼x4¼ inches may be used. This increase in size allows more room for hand lettering, printing and drawing for special effects. A clear celluloid target defines "field areas" at 4", 6", 8" and 12" distances. Title backgrounds appearing in HOME MOVIES each month are readily accommodated.

★ ZOOM TITLES

This popular titling effect is created by sliding the title card stand in the fitted Titleer base to get the desired effect.

★ SUPERIMPOSED TITLES

The celluloid target holder will accommodate a panel of clear celluloid or glass on which lettering can be placed for special background titles and animation.

★ ACCURATE ALIGNMENT

Eliminate all fuss and bother in lining up titles by using a camera base custom made for your particular camera. These precision bases are interchangeable on the Titleer and assure simple and accurate alignment for all popular cameras.

★ ULTRA CLOSE-UPS

The camera stand and auxiliary lens holder may be moved to the end of the Titleer base for photographing ultra close-ups of insects, flowers, copy work, etc. The Titleer may be used in a vertical position or mounted on any tripod. The lighting assembly is easily removed or placed at any position on the Titleer base.

4 STAR
TITLEER
(Less Lights)

6⁹⁵

LIGHTS and ATTACHMENT, \$3.00 EXTRA

Complete with 2 Auxiliary Lenses, Celluloid Target, Instructions and Titling Data

**PROFESSIONAL TRICK ATTACHMENTS
and ACCESSORIES AVAILABLE SOON!**

At Your Dealer or Write

**HOLLYWOOD CINE PRODUCTS CO. 3221 SO. FIGUEROA ST.
LOS ANGELES, CALIF.**

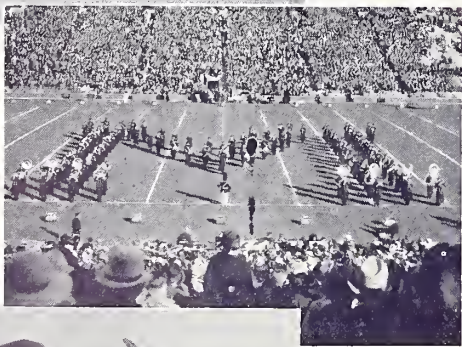

In home movies

COLOR

means

KODACHROME

THERE'S color ahead—color in the countryside and color in all the high-spirited goings-on of the autumn season.

It's a time for Kodachrome Film. For, in home movies, color means Kodachrome. Kodachrome is unique in its mastery of subtle as well as brilliant coloring, just as it is unique in its clarity and ease of use.

Plan now to be ready for the fall's color. Load up with Kodachrome, and keep a roll or two in reserve.

For daylight shots, use regular Kodachrome; for work by artificial light (Photoflood), use Type A. (Either type, of course, can be used in the other's special field with the aid of a corrective filter.) Both types are the same price—and the price includes processing and return of the film, ready for showing.

8 MM. KODACHROME

25-ft. rolls, \$3.40; 25-ft. magazines, \$3.75.

16 MM. KODACHROME

200-ft. rolls (from Rochester only), \$16; 100-ft. rolls, \$8; 50-ft. magazines, \$4.65; 50-ft. rolls, \$4.30.

EASTMAN KODAK COMPANY
ROCHESTER, N. Y.

Price 25c

HOME MOVIES



Ralph F. Morgan

October . 1940

LARGEST CIRCULATION OF ANY AMATEUR MOVIE MAGAZINE!

READY NOW...! A New, later series of Mickey Mouse and Donald Duck films...!

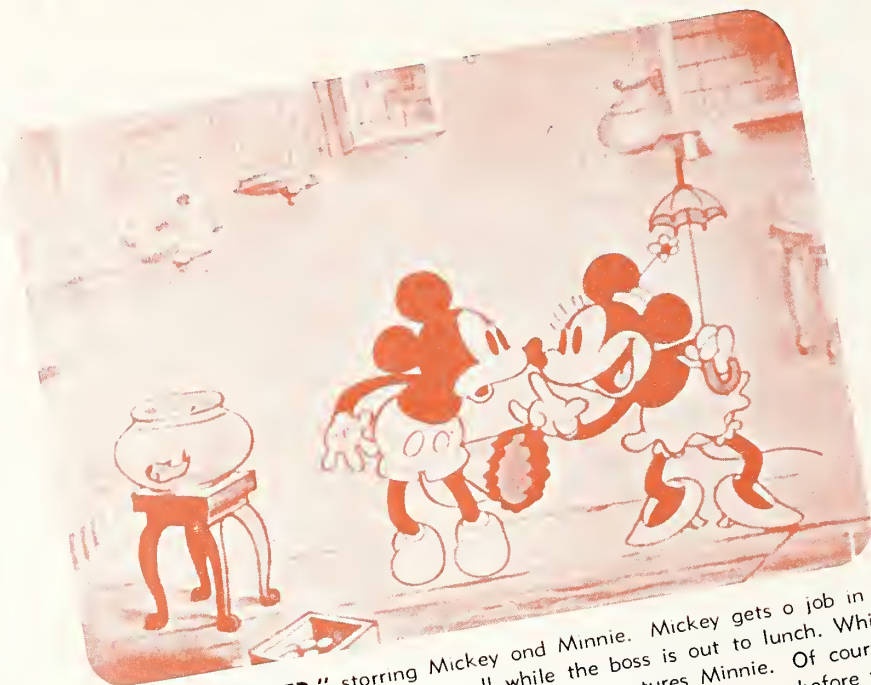

"HIRED AND FIRED," starring Mickey and Minnie. Mickey gets a job in a pet store, where Minnie comes to coll while the boss is out to lunch. While showing Minnie the pets, a gorilla escapes and captures Minnie. Of course, Mickey saves Minnie, but wrecks the store in doing so and resigns before the boss returns. Order by subject number—1402-B.

200 feet 16mm
100 feet 8mm

\$7.50
3.00



"FOOTBALL MANGLERS"—Mickey's "Lightweights" tackle the "Manglers" in a highly exciting game of football. With but one-quarter second to go, Mickey and a fellow player pull some fancy tricks that win the game for them and leave you in gales of laughter. Subject No. 1512-A.

100 feet 16mm \$3.00
50 feet 8mm 1.50

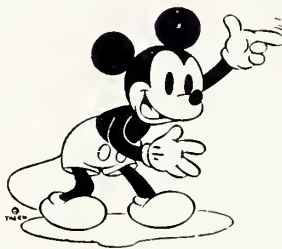

"FAST AND FURIOUS"—Donald Duck and Mickey, as highway policemen, corner Peg Leg Pete the "dognapper" in an old sawmill. A runaway buzz saw complicates the chase, which is fast and furious, involving many hilarious situations. How Donald and Mickey capture Peg Leg furnishes a clever "mirthquake" finish. Subject No. 1452-B.

200 feet 16mm \$7.50
100 feet 8mm 3.00



"DONALD DUCK'S OUTING"—A scream from start to finish. Donald, on a picnic, suddenly finds cakes and sandwiches disappearing from the picnic spread. Mickey's nephews, hiding some distance, are the cause of the trouble, shooting darts into the food to which strings are tied. Donald becomes exasperated, as only Donald can, and succeeds in saving some of the lunch. Subject No. 1551-A.

100 feet 16mm \$3.00
50 feet 8mm 1.50



New Mickey Mouse and Donald Duck cartoons are available in 25, 50, and 100 foot 8mm lengths, and 50, 100, and 200 foot 16mm lengths. Send for FREE CATALOG!

HOLLYWOOD FILM ENTERPRISES, INC.
6060 SUNSET BLVD. • HOLLYWOOD, CALIF

OCT -3 1940



* Shot of the Month ...

home MOVIES

Copyright 1940 by Ver Halen Publications. No part of magazine may be reprinted without specific permission.

CONTENTS FOR OCTOBER, 1940

INFORMATION PLEASE.....	462
BACKYARD MOVIES.....	464
THE READER SPEAKS.....	466
TITLE TROUBLES.....	468
THE WINNER TELLS ALL!.....	<i>By Herman Bartel</i> 471
WE SHOT NEW YORK OUR WAY.....	<i>By Roy Creveling</i> 472
MOVIE OF THE MONTH.....	<i>By J. H. Schoen</i> 473
DEMOUNTABLE TURRET ANY AMATEUR CAN BUILD	<i>By Curtis Randall</i> 474
ACCURATE ALIGNMENT ESSENTIAL IN ANIMATING CARTOONS	<i>By Walter W. Light</i> 477
IT'S EASY TO TINT AND TONE YOUR FILMS... ..	<i>By Geo. W. Cushman</i> 478
WHAT AN AUXILIARY LENS WILL DO... ..	<i>By Dr. A. K. Baumgardner</i> 479
ARE YOU PREPARED FOR INDOOR FILMING?.....	<i>By R. E. Worstel</i> 480
DETAIL? IT DEPENDS UPON THE EMULSION.....	<i>By S. J. Williams</i> 481
FRAME COUNTERS AND GEARS FOR GLORIFIED 16. .	<i>By Arthur H. Hart</i> 482
TEACH YOUR DOG TO ACT IN YOUR HOME MOVIES. .	<i>By John H. Klok</i> 483
TITLE CENTERING GUIDES.....	484
TELL ME, HOW CAN I IMPROVE MY FILM?... ..	<i>Reviews by the Editors</i> 485
EXPERIMENTAL CINE WORKSHOP.....	486
IT'S NEW TO ME.....	<i>By Cinebug Shopper</i> 492
EXPOSURE METER GUIDE.....	506
DIRECTORY OF AMATEUR CINE CLUBS.....	509
TITLE BACKGROUNDS.....	511

EDUCATIONAL FILMS SECTION

SCHOOLS CAN SUCCESSFULLY PRODUCE TEACHING FILMS	<i>By Bill A. Jones</i> 488
COOPERATIVE VISUAL SYSTEM SUCCEEDS.....	<i>By Wm. J. Inskeep</i> 489
EDUCATIONAL FILM TREATMENTS.....	490

★ Shot of the Month—By Charles Herbert, A.S.C. Note shallow foreground and the fringe of pine branches delicately framing picture at the top.

CHAS. J. Ver HALEN
PUBLISHER

C. J. Ver HALEN, JR.
ASSOCIATE PUBLISHER

ARTHUR E. GAVIN
EDITOR

OFFICE OF PUBLICATION
6060 Sunset Boulevard, Los Angeles, Calif.
Phone GRanite 5149

NEW YORK OFFICE
Everett Gellert, 62 West 45th Street
Vanderbilt 6-5254

CHICAGO OFFICE
C. N. Burris, 712 Wrigley Building
Whitehall 7784

RAY FERNSTROM
Technical Editor

GEORGE W. CUSHMAN

J. H. SCHOEN
Associate Editors

COUNT H. von SCHOENFELDT
Photographic Editor

C. E. BELL
Associate Photo Editor

L. C. BUSCHER
Art Director

ADVISORY EDITORS

GEORGE BURNWOOD
The 8-16 Movie Club, Phila., Pa.

JAMES BIALSON
Amateur Motion Picture Club of St. Louis

WIL SNYDER
Norfolk Amateur Movie Club

RIEBETH
Minneapolis Cine Club

ELISSE A. PELLETIER
Toronto Amateur Movie Club

WESTELL
Cinemem Club

W. A. CADARETTE
Los Angeles 8mm Club

ED F. KAUFMAN
Indianapolis Am. Movie Club

L. DVORAK
Suburban Amateur Movie Club

ROUNTREE
Bay Empire 8mm Movie Club

RT B. GRIFFITH
Sunkist Movie Club

HUR E. GIBBS
Portland Cine Club

A. HOOK
Seattle 8mm Club

EMERSON CLYMA
Detroit Society of Cinematographers

SISSEL
Austin Movie Club

HEO. ROTH
Sherman Clay Movie Club

D. E. SNYDER
Des Moines Y. M. C. A. Movie Club

C. ENION SMITH
Metro Movie Club of Chicago

MOSS BROWN
Dallas Cinema Club

ER BEZEK
Chicago Cinema Club

SSELL A. DIXON
Pittsburgh Amateur Cinema Club

Second-Class Matter, May 6, 1938, at postoffice at Los Angeles, California, under the Act of March 3, 1879.

Subscription rates: U. S. \$2.00 per year. Canada Foreign Countries, \$3.00 per year. Single copies 25c. Canadian and Foreign single copies Copyright, 1940, by Ver Halen Publications. Advertising rates on application.

SEE THIS NEW
MODEL • A-82 • 16 MM

IT HAS
EVERYTHING

plus BRILLIANT and QUIET
PERFORMANCE

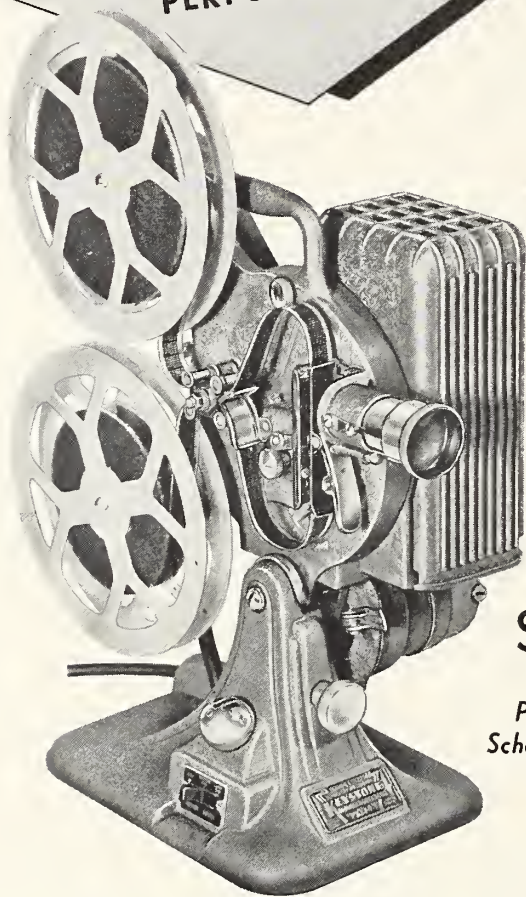

\$74.50

Perfect for Homes,
Schools and Churches

- ★ REVERSE PICTURES
- ★ COVERED REEL ARMS
- ★ 750 WATT LAMP
- ★ STILL PICTURES
- ★ AUTOMATIC LEVER RE-WIND

- ★ SILENT FINGER MOTION
- ★ COOL LAMP HOUSE WHEN RUNNING REVERSE
- ★ f.1.6 WOLLENSAK LENS
- ★ CENTRALIZED CONTROLS
- ★ SLOW SPEED FLICKERLESS PICTURES
- ★ PILOT LIGHT

and many other features listed in our literature

AMERICA'S LARGEST PROJECTOR LINE

KEYSTONE

KEYSTONE MFG. COMPANY • BOSTON, MASS.

Information PLEASE

Meter Readings (G. Joseph, New Jersey)

I should like some information before buying an exposure meter. One I am interested in gives readings for the following lens openings: f/1.4, 2, 2.8, 4, 5.6, 8, 16, 22, and 32. My camera has an f/3.5 lens. Why doesn't the meter give a reading for this opening? Also, one meter I saw is calibrated in Scheiner ratings and lists such speed values as 14, 17, 20, 23, 26, and 29. Why doesn't this meter have a number 18 speed marking as well as other numbers I find many film distributors using in their film advertising?

The lens openings as listed on the first meter you mention are true full stops. That is, each is again as big or again as small as the opening preceding or following it. For example, f/4 is exactly one full stop larger than f/5.6. The f/3.5 opening on your camera lens would be one-half stop larger than f/4, and f/4.5 would be a quarter stop smaller than f/4. The difference is so small that when you get a reading of f/4 you may safely use a stop of f/3.5 on one hand, or a stop of f/4.5 if the reading leans slightly in excess of f/4.

The Scheiner ratings referred to are also full stops. Every three numbers in the Scheiner system represents a full stop on the lens. Therefore, the difference between 17 and 18 Scheiner represents but 1/3rd of a stop. If the film you use is rated at 18 Scheiner, you may safely use the 17 Scheiner reading on your meter.

Fog (O. L. Rader, Maryland)

I find that after reversing my film the whites lack transparency. What causes this?

Lack of transparency, or fog, may be caused by several things. Too much caustic soda may be used in the processing formula; your safelight may not be 100% safe; or you may be using the wrong type bleach. It is

• READERS: This department is for your benefit. Send in your problems and our technical board of professional cameramen will answer your question in these columns. If an answer by mail is desired, enclose addressed stamped envelope.

best to use the bleach formula which calls for bichromate, as this works on the non-halation backing of most films except Eastman.

Yellowish Cast (L. L. Rader, Maryland)

Sometimes my home processed film has a slight yellowish cast. What is the cause of this?

The yellow cast referred to may arise from two conditions: Either your developers are too weak from over-use or too weak compounding, or you fail to wash your film sufficiently long enough after each processing operation.

Universal Focus (J. R. Dawns, New York City)

I just purchased a Hugo Meyer f/1.5 lens for my 8mm camera. At what point may I set it for universal focus?

When using the f/1.5 opening and setting the focus at 13 feet, this lens will be in universal focus from 6'6" to infinity. At f/1.8 it will be in focus from 5'6" to infinity when set at a focus of 11 feet. An opening of f/2.5 set at 8 feet will be in focus from 4' to infinity. At f/3.5 set at 6 feet, the lens will be in focus from 2'6" to infinity; and f/4.5 focused at 4 feet will be in focus from 2' to infinity.

Binocular-Telephotos (T. R. Schratt, Evanston, Ill.)

When using a binocular in front of my regular camera lens, the scenes are very dark. What causes this?

The use of binoculars in front of your lens tends to cut down the volume of light reaching the film, depending upon the number of extra lens surfaces through

• Continued on Page 508

NEW CASTLE FILMS BRING LAUGHTER AND FUN TO YOUR HOME-MOVIE SCREEN!



BOY MEETS DOG!

The most rollicking, laugh-filled cartoon of season... done in a brand-new technique! Never has the home-movie screen had such a chance for merriment! Father's severity with his boy lands the grouch in Pixie-land where he's condemned to grow young again, after which he turns human. Animation by Lantz, "Oswald's" creator and based on Gene Byrnes' strip, "Reg'lar Fellers."

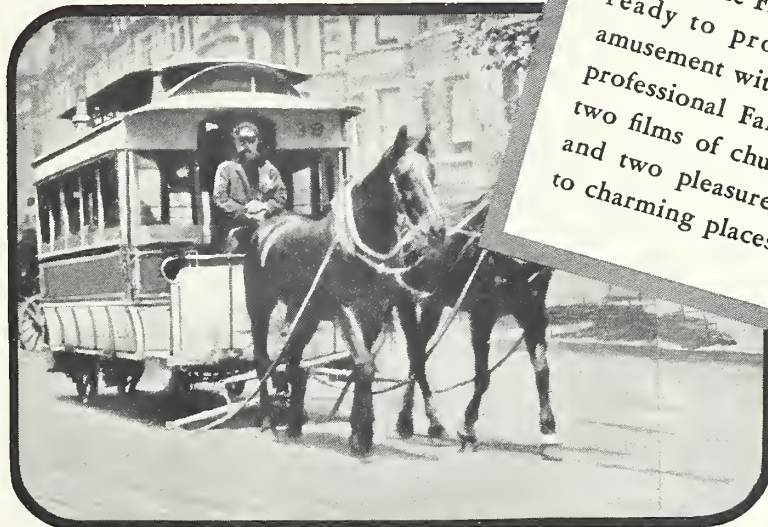

GAY NINETIES LIVE AGAIN!

It may make you homesick for the good old days, but it also will make your sides ache with hearty, wholesome laughter! Movies actually taken near the turn of the century are resurrected, and, with them, bustles and fire-horses, sport styles and horse-cars in New York, Chicago and San Francisco. Easter parades and subway openings and steam locomotives on the elevated! One of the earliest bathing beauty contests! Teddy Roosevelt returns with his Rough Riders! Governor-elect Wilson, the "divine" Sarah Bernhardt, John Bunny and other celebrities!

The world today can do with a little more fun and laughter. And Castle Films' dealers are ready to provide genuine amusement with more of our professional Fall releases... two films of chuckles galore and two pleasure-filled trips to charming places.

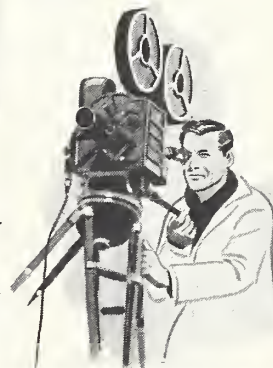

TWO BEAUTIFUL FILM VISITS TO ENCHANTING PLACES



PALESTINE

A new perspective on Palestine, beautifully photographed! The hallowed streets of centuries-old cities, revered by the followers of three faiths, contrasted with modern construction and development particularly in the all-Jewish city of Tel Aviv.



FUN IN FLORIDA!

Places and events familiar to many but known by all! A quarter of an hour among Royal palms and flamingoes... at Miami and Palm Beach... fishing for gamesters... watching champ divers... living the life of winter tourists!

All Castle films are available in five lengths at these lowest prices:

- 8 MM: 50' - \$1.75 180' - \$5.50
- 16 MM: 100' - \$2.75 360' - \$8.75
- Sound-on-Film: 350' - \$17.50

Just off the Press!

CASTLE FILMS, INC.
30 Rockefeller Plaza, New York City

Please send without cost your new 1940-41 Castle Films' catalogue.

Name _____

Address _____

City and State _____

B-10

CASTLE FILMS
 30 ROCKEFELLER PLAZA NEW YORK FIELD BUILDING CHICAGO RUSS BUILDING SAN FRANCISCO

PROTECT YOUR 16 mm FILMS

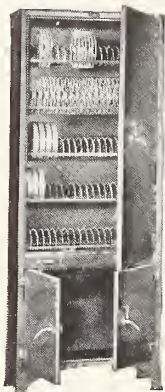

TYPICAL NEUMADE CABINET
MODEL MM-102—Holds 100 400-foot reels, humidified, indexed, key locks, large utility compartment in base.

Permanent Protection! Instant Selection!

Preserve and protect your films. Keep them fresh and clean, ready for immediate use—today, tomorrow, next year. File and store them in a NEUMADE cabinet.

Designed for Films

HUMIDIFIED ALL-STEEL
FIREPROOF INDEXED
DUSTPROOF KEY LOCKS

Complete line . . . the result of over 24 years' experience supplying the motion picture industry. More than fifty models to choose from—needed by every film owner.

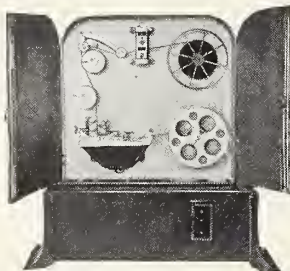

Film Renovator

Sparkling projection is possible only with clean film. In one motor-driven operation, film is automatically . . .

CLEANED - CONDITIONED
RENOVATED - POLISHED
"NEUVATOR" MODELS

CL-4 . 400-ft. reels
CL-16 . 1600-ft. reels

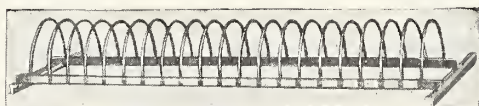

Steel Film Filing Racks

Put them in your present cabinet, desk drawer, closet, on your table—can be used anywhere. Each reel (with or without can) held erect in its proper place, individual changeable index cards. Cut any length to fit your requirements. Price per foot, complete with drilled end mounting brackets:

RK-1 (100 ft.) \$2.25 RK-4 (400 ft.) \$3.00
RK-16 (800-1600 ft.) \$4.50

Also available—Floor Model Separator Rack units complete with end uprights for the large library. Send requirements for immediate quotation.

Write for Catalogue No. 16

Neumade Products Corp.
MANUFACTURERS

431 West 42nd Street New York, N. Y.

CABINETS
CLEANERS
PROJ. TABLES
MEAS. MACH.
FLANGES

REWINDS
SPLICERS
EDIT. TABLES
REELS, CANS
CASES

BACKYARD MOVIES

Ideas for Short Films

Tic Tac Review

Your house, an old 89c alarm clock and a hundred feet of panchromatic film will fill the bill of materials for a simple short subject that should prove interesting to friends and family alike. Here is the substance of the sequence, which can be adapted conveniently to the individual amateur's needs:

Mother has just bought a new and (supposedly) expensive bedroom clock, and she is seen reminding the other members of the family to respect her "territorial integrity," as the picture begins. It is not long, however, before Junior, screwdriver in hand, spots the clock with a mischievous eye, and views it as a shining piece on which to try his skill. He takes the clock to his private sanctum and proceeds to take it apart, just to see "what makes it tick."

With all the parts scattered on the floor, and practically nothing left of Mother's fine alarm clock, Junior is discovered. Mother is heartbroken. The thing is a complete wreck. "Dad, can't you do something about it? Not even the best jewelers could put that clock together again!"

Dad then approaches with the self-confident air of a master mechanic, sits down on the floor next to Junior, and with a solemn "Watch me," proceeds to reassemble the clock in 10 seconds flat! Everyone is surprised beyond measure as Dad holds the ticking clock to Mother's ear for approval.

As an amusing finish, show Dad discovering a few parts left over, which he quickly and deftly relegates to the waste basket.

The above effects are easily achieved with a bit of splicing and trick photography. All that is required is that scenes of reassembling of the clock be photographed with the camera held upside down as the clock is being taken apart. In other words, after Junior's initial removal of a few screws from the clock, the next scene photographed should be with the

camera held upside down, showing Dad holding the clock to Mother's approving ear, followed by Dad taking apart the clock (shot at 8 frames per second to speed the action); then his "Watch me" scene; and finally his exit from the room which, when later spliced in the processed film, will be his entrance! In this manner the whole sequence will automatically be reversed, and Dad will accomplish the impossible task of putting a clock together in a few moments.

A few parts taken from the dissembled clock can be used for the last "basket" scene, of course.

—Raymond A. Ghelardi.

Vacation Idea

An idea for a vacation movie that is a little different uses a surprise ending. Of course, the main purpose is to show your vacation trip. Start the movie with a scene at your desk writing a letter. Stop writing, put your pencil down and begin to yawn, then let your head slowly droop down on your arm, resting on the desk, as though very sleepy. Next, take a closeup of the letter, which you were supposed to have been writing, that has a date about a week before your vacation starts. Have the letter begin in this way: "Dear Friend—Just starting to get ready for my trip to the mountains (or the place you'll visit). I'm so excited I can hardly wait to get away."

Now you make the pictures of your trip. Begin

• Continued on Page 508

KIN-O-LUX No. 3 GOLD SEAL



A new **FINER** movie film for indoor use and other occasions except bright sunlight.

RATINGS

WESTON TUNGSTEN 100
SCHEINER TUNGSTEN 29°

100 foot
\$6.00

50 foot
\$3.50

In selecting a movie film you must consider three important questions. What performance will you get? Will it be uniformly reliable at all times? How much will it cost you? Kin-O-Lux No. 3 Gold Seal answers all three with one simple straightforward statement. Created expressly for indoor use and guaranteed for reliability, it is priced lower than any other film of comparable quality. Offering a superior Super Pan emulsion, its speed grants a wide latitude and exceptionally fine grain. But, then, who could be a better judge than you, yourself? Go to your dealer today—ask for Kin-O-Lux No. 3 Gold Seal. Try it—see why more and more camera users daily are turning to this and other Kin-O-Lux Films for finer movies.

Other Kin-O-Lux Movie Films are:

KIN-O-LUX No. 1	KIN-O-LUX No. 2	KIN-O-LUX No. 3
Weston 8, Scheiner 18°	Weston 12, Scheiner 20°	Weston 50 40 (Tun.) Scheiner 26° 24° (Tun.)
100 ft. . . . \$3.00	100 ft. . . . \$3.50	100 ft. . . . \$6.00

ECONOMY • RELIABILITY • FINER RESULTS

Write for Booklet H10

KIN-O-LUX, INC. 105 West 40th Street, New York City

• We want suggestions and ideas for random "backyard" filming; also for simple home movie scenarios. Those which are published will bring the contributors either a 100-ft. 16mm or a 50-ft. 8mm film subject selected from the advertisements in HOME MOVIES magazine.

For ideas that can be adapted to a feature length article we will reward the contributor with two rolls of panchromatic film. Address your suggestions to BACKYARD MOVIES, care of HOME MOVIES, 6060 Sunset Boulevard, Hollywood, Calif.

FOR COLOR PICTURES

You Especially Need

DA-LITE'S BRIGHTER GLASS-BEADED SURFACE

The greater density of the emulsion on Kodachrome and Dufaycolor film requires the brighter light reflective quality of a glass-beaded screen in order to bring out all of the colors as brilliantly as they appear in the original scene. The specially constructed shatter-proof Da-Lite Glass-Beaded surface reflects the maximum of light without sparkling or glare. It reproduces all of the shades of colors faithfully. Ask your dealer for a comparison. You, too, will choose the Da-Lite Glass-Beaded Surface for your pictures.



For CONVENIENCE You Will Prefer

QUICKLY SET UP

To set up the Da-Lite Challenger here is all that you have to do:

1. Open the legs of the tripod.
2. Swing the case to horizontal.
3. Lift the Glass-Beaded Fabric from the case and hook it over the extension rod.
4. Raise the extension rod to operating position and start your show.

SQUARE SIZES

If you want to show Kodachrome double frame still pictures, ask for a Challenger in the *square* size. It can be adjusted to rectangular shape for showing movies. Twelve sizes (including square sizes) from 30" x 40" to 70" x 94" inclusive from \$12.50 up. Prices slightly higher on Pacific Coast.

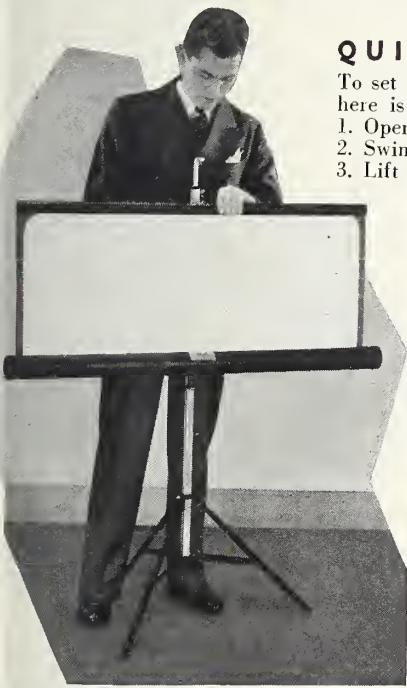

THE **DA-LITE** CHALLENGER

(REG. U. S. PAT. OFF.)

To simplify the showing of movies and still pictures, thousands of experienced photographers use the Da-Lite Challenger model. This complete unit, consisting of the Da-Lite Glass-Beaded Surface, spring-roller-mounted in a metal case, to which a tripod is permanently and pivotally attached, can be set up anywhere in 15 seconds.

The Challenger is the *only* screen which can be adjusted in height merely by releasing a spring latch and raising the extension rod. No separate adjustments of the case. The screen can be quickly adjusted in height to meet the projection requirements of any sized audience. The Challenger is the only screen with *Square tubing* in both the center rod of the tripod, and the extension support to keep the case aligned and the entire picture in perfect focus. The Challenger is durably built. The handle is mounted on a special bracket encompassing the case (as shown at lower left). It is not attached to the thin metal of the case. Ask your dealer to show you this modern tripod screen. It is one of many styles in the Da-Lite line—a line famous for quality for 31 years. Write for free literature now!

DA-LITE SCREEN CO., Inc.

Dept. 10-HM, 2723 North Crawford Avenue • Chicago, Illinois

Look for the Name **DA-LITE** When You Buy!

REG. U.S. PAT. OFF.

Better MOVIES

BEGIN WITH

Proper LIGHTING

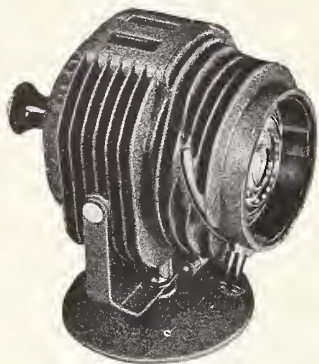

F-R HI-SPOT the better HOLLYWOOD TYPE SPOTLIGHT

Experienced photographers know that lighting is the first requisite for finer picture making. Having studied Hollywood lighting technique they know that the F-R Hi-Spot, miniature of the giant and bulky Hollywood spotlights, with its soft but punchy beam "picks up" details ordinary lighting never discovers. It embodies all the fine points necessary for superior home movie making.

OUTSTANDING FEATURES:

- Fresnel Lens.
- 200 Watt Special Hi-Spot Projection Lamp.
- Finger-tip focusing from a large to a small spot.
- Complete directional control—tripod mounted or adapted to standard light stands.
- Made of Die-Cast Aluminum.
- Compact, sturdy—yet light-in-weight.
- Anyone can manipulate it.
- Complete with 10 ft. cord.

\$9⁹⁵

At leading dealers everywhere.

Buy it today.

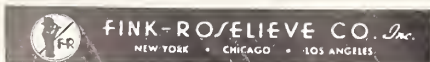

The Reader



SPEAKS

Our Error

As presumed by this reader, others have called our attention to the error in the title centering guide for the Keystone "8" which appeared in the September issue.

Gentlemen. I suppose others have already informed you that your title centering guide for the Keystone "8" on page 424 of the September issue is upside down.

—Henry Dechau.

Happened To You?

The following plaint from a reader is being published for the benefit of beginners who might make a similar mistake. Moistened blotters are usually O.K., provided they are not saturated with water or a humidifying solution. A few drops to one-half teaspoon of liquid is sufficient. Too much will over-humidify film, causing irreparable damage, as in this case.

Dear Sirs: I would like to pass along information regarding the experience I had with my films. In trying to save a few cents by not purchasing humidor cans, I put a moistened blotter in my reel cans. When I opened the cans a few weeks later, I found the film completely spoiled. Moisture had penetrated throughout the film, causing the emulsion to run.

—Samuel Del Pizzo,
Ardmore, Pa.

Likes "Swapping" Idea

In the August issue, we published a reader's suggestion that we encourage exchange between amateurs, of films of various subjects of commercial origin in addition to those made by the amateur himself. This reader is one of several who has written, applauding the idea. We should be unable, though, to handle the postcards suggested.

Dear Sirs: I am heartily in favor of Mr. Starkweather's idea of swapping films. I have quite a few reels of

8mm which I should be glad to swap. Why not let each amateur that is interested furnish you with penny postcards bearing his name and address, together with a list of films he desires to trade? You, then, could forward the cards to other amateurs who write in, saving the space required in this department for a published reply.

—Walter C. Brooke,
Boyetown, Pa.

Home Stage Plans

This reader will find plans for remote control of home theatre curtains in the Experimental Cine Workshop department of this issue.

Gentlemen: In the July issue I noticed an article on plans for home movie screening within the home. I wish you would give us more articles of this type. I would like to see an article that would explain how to rig up movable curtains in a home theatre stage.

—Victor A. Schultz,
Litchfield, Minn.

Swappers!

Gentlemen: Thanks for your interest in our club. We want you to know that your Club Directory page is a swell idea. We have swapped films with Cinemen, of Nutley, N. J., and Silver Screen Players, of Burlingame, Calif. We of the 8-16 Movie Club of Philadelphia will swap films with other amateur clubs—either 8mm or 16mm. Films to be shown at our club meetings. In exchange, we offer loan of "Reversal Process," 200 feet 16mm, and "Picnic Daze," available in either 16mm (400 feet) or 8mm (200 feet).

—George Burnwood,
992 East Godfrey,
Philadelphia, Pa.

Dear Sirs: In your "Swappers" column, would you kindly try to make contact for me with any cine fans in Sioux City, Iowa, who might have taken some movie shots of the president

• Continued on Page 508

Sale!

MINI

Universal Electric EXPOSURE METER



For Still and Motion Picture Photography

The Mimi is direct reading and pre-set to film shutter speed. It is very small and light and slips easily into your vest pocket. Measures $1\frac{7}{8} \times 2\frac{1}{2} \times \frac{3}{4}$ inches and weighs but $3\frac{1}{2}$ ounces. Inclined cell and protecting cover eliminate top and bottom light influence. No carrying case necessary.

REGULARLY \$12.50

\$8⁹⁵

complete with neck cord, exposure meter manual and list of practical film speeds.

Mail Orders Filled

If it's photographic
you'll find it at

Willoughbys

32nd St. Near 6th Ave.
New York

World's Largest Camera Store
Built on Square Dealing

CRAIG JUNIOR EDITOR .. The No. 1 Movie Accessory

A COMPLETE EDITING OUTFIT
... in ONE Compact Unit

The new CRAIG 16mm JUNIOR EDITOR now brings professional-like editing within the reach of all! Its famous ROTARY PROJECTION principle, unique design and popular price combine to give you TOP VALUE at SMALL INVESTMENT.

Proper editing cannot be effected by magnified viewing alone—it requires careful study of ACTUAL MOVEMENT... cutting, splicing and the insertion of titles must be accomplished with due regard to an INTEREST SUSTAINING CONTINUITY THROUGH EACH ENTIRE SCENE.

The JUNIOR EDITOR affords the simplest yet most efficient means of attaining these ends—its "Action-Editing" principle permits careful inspection, slow motion if desired, of EVERY MOVEMENT on its brilliant miniature screen. The conveniently placed CRAIG SENIOR SPLICER assures quick, professional-like splices. Complete unit lists at only \$27.50.

JUNIOR EDITOR alone (with mounting plate for splicer) lists at \$19.50.



To operate, merely place reels on rewind spindle, thread film, plug in cord and wind. Motion is projected from within on a brilliant miniature screen which is set at a comfortable viewing angle.



When a section to be edited is found, film may be wound at slow motion until exact frame to be cut is determined—then slipped from the polished guide to the conveniently placed splicer for quick cutting and splicing.

NOW BEING DEMONSTRATED BY LEADING DEALERS
Craig Editing Equipment is now being featured by leading photographic stores everywhere. Stop in at your favorite dealer TODAY for full details. Ask for a free copy of the new Craig Folder.

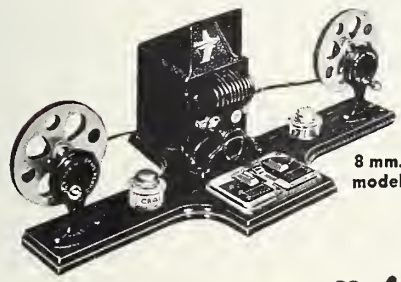

8 mm. model

THE CRAIG PROJECTO-EDITOR

Through a new, revolutionary principle in design, the CRAIG PROJECTO-EDITOR permits true ACTION Editing—a SMOOTHLY ANIMATED viewing method allowing careful inspection, at regular speed or SLOW MOTION, of actual movement on a brilliant miniature screen. The PROJECTO-EDITOR has no shutter—therefore has no flicker.

The 8 mm. model, illustrated at left, complete with 8 mm. Junior Splicer and Rewind combination . . . mounted on a hardwood base with a bottle of Craig Safety Film Cement, \$27.50.

8 mm. Projecto-Editor alone	\$22.50
16 mm. Model complete	49.50
16 mm. Model alone	35.00

"Makes Editing a Pleasure"

Craig Safety Film Cement
—25c

Craig 16mm Senior Splicer,
Sound or Silent—\$10.00.

Craig Senior Combination, Complete—\$19.50.

Craig Junior Splicer, 8 or
16mm—\$2.50.

Craig Senior Rewinds—
\$4.50 each, \$9.00 the pair.

CRAIG MOVIE SUPPLY COMPANY

1053 SOUTH OLIVE STREET, LOS ANGELES, CALIFORNIA • 149 NEW MONTGOMERY STREET, SAN FRANCISCO, CALIFORNIA

Here's a real TITLE MAKER

Now you can dress up your films. Make flip-flops... zooms... receding titles... turn-arounds... silhouettes... shadows... fade-ins... fade-outs... handwriting... moving letters... animations... book covers... rear projections... etc.

THE BROWN MICRO-MATIC TITLER IS PRECISE, ALL METAL, AND PROVIDES FOR QUICK AND CERTAIN ALIGNMENT



No other title maker provides the optical bench precision (so essential in making worth while titles) that is found in the BROWN. Other features include: Vertical or horizontal mounting... self-locking camera mount... positive lens and easel alignment... full adjustable reflectors... self-centering supplementary lens holder... accurate field-of-view chart... demountable title frame which will hold any desired background... any 8 or 16mm camera fits on the BROWN.

The BROWN TITLER complete, includes: Opal glass, clear glass, and cork backgrounds, 9" x 12"... two reflectors with adjustable brackets... 12 ft. extension cord... vertical pivot bearing... target sight and auxiliary lens holder... field chart for lenses... and full instructions \$27.50



"HOW TO TITLING YOUR MOVIES"
Send today for this interesting, illustrated leaflet—a post card to American Bolex Co. will bring it.

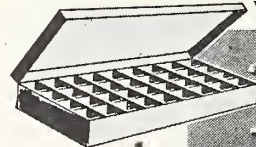

"MASTER" TITLE KIT
—the best letters for your home movie titles.

ABCDEFGHIJKLMN OPQRS
TUVWXYZ & 1234567890
abcdefghijklmnopqrs
tuvwxyz-?!,.
\$12.50

222 Characters... 3/8-inch Capitals. Plain back, or Pin back on Special Order. Packed in box with exclusive Template composing gauge and full instructions.

Cinea FILM CEMENT

The only film cement for all kinds of film—acetate or nitrate—35 mm, 16 mm, or 8 mm CINEA CEMENT is odorless, does not bleach color, is slow to evaporate from uncorked bottle yet joins film quickly and strongly. The perfect cement for use with the CINEA 30 SPlicer.

Bottle... 25¢



SEE YOUR DEALER OR WRITE TO:

AMERICAN BOLEX CO., 155 EAST 44th STREET, NEW YORK, N. Y.

CINELAC

LIFETIME
FILM PROTECTION
NO
SCRATCHES
BRITTLINESS
OR CURL

CINELAC permeates and toughens emulsion—seals in moisture—prevents excessive aging—protects negatives and motion picture film. No apparatus needed—easy to apply . . . \$1.00



TITLE Troubles

By GEO. W. CUSHMAN

If you have any questions concerning titles or title-making, Mr. Cushman will be glad to help you. You can write him in care of this magazine or direct to his home address, 3425 Witmer Parkway, Des Moines, Iowa. Be sure to enclose a self-addressed stamped envelope for your reply. It is also well to include a sample or drawing when possible, as well as the developer used kind of illumination, film lens opening, etc.

Q. Having shot several rolls of film, I am now anxious to make some titles for them and would appreciate your telling me the simplest way for a beginner such as myself.—C. S. N., Covington, Ky.

A. Probably the simplest method for the beginner is to first purchase a titler to fit the camera. The dealer where the camera was purchased probably has one, or can get one. On a piece of black paper no larger than the title area in the titler letter the wording in white ink. A typewriter and ordinary white paper is also satisfactory.

Place the title in the title easel and photograph the title for a second or two longer than it takes to read it through once slowly. If the title is in the outdoor sun, an exposure of f.11 is suggested. Indoors, a 100 watt light may be placed just above the camera lens about 8 inches from the title, and with this illumination an exposure of about f.5.6 is recommended. When processed, the titles are spliced into the film where they belong—that's all there is to it.

Q. I am planning a new titler and would like to know which is the better, a vertical or horizontal easel?—S. D. K., Dayton, Ohio.

A. This is largely a matter of opinion, and secondly it depends upon the type of work to be done. If much

"NOW, AREN'T YOU GLAD WE GOT OUR NEW PROJECTOR?"

"YES, AND I'M GLAD WE CHOSE THE REVERE"



YOU, TOO, CAN IMPROVE YOUR MOVIES WITH THE

Revere & Projector

**REVERE MODEL 80 SERIES B
8mm PROJECTOR**

Thousands of movie makers have replaced their old equipment with this modern powerful projector. Complete with 500-watt lamp and 1" F1.6 lens. **\$59.50**

YOU WILL LIKE THE VERSATILITY OF REVERE CAMERAS

Among the eights, Revere alone offers you all of these features—five speeds, built-in, parallax-corrected view finder, die cast aluminum, one-piece case, and exclusive sprocket film control.*

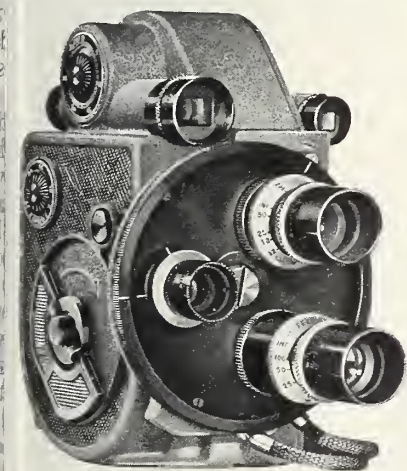
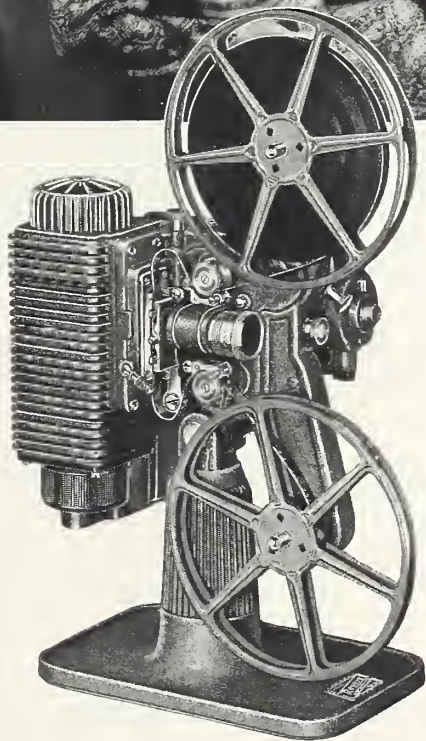

REVERE MODEL 99 TURRET CAMERA

Has extra optical view finder for telephoto lenses. Complete with one Wollensak 12.5mm F2.5 lens. **\$65.00**

REVERE MODEL 88 CAMERA

Complete with Wollensak 12.5mm F3.5 lens in removable universal focus mounting. **\$29.50**
With F2.5 lens. **\$39.50**

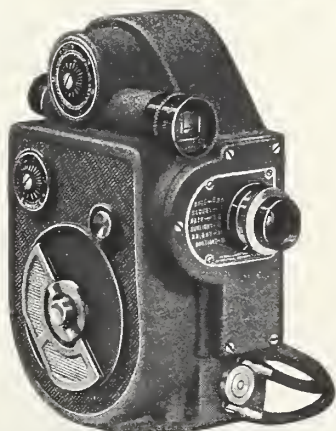

The greater screen illumination of the Revere 8 Projector, with its 500-watt lamp and F 1.6 lens, will make every reel of film you own more enjoyable.

The dependable performance of the Revere 8 Projector and the ease with which it can be threaded will eliminate embarrassing delays. 300-foot reels and a fast automatic motor driven rewind minimize time spent changing reels. There are no belts to bother with in the fully enclosed Revere rewind. A precision-built duplex shuttle film movement, with 10½ to 1 ratio, assures life-like pictures of theater quality steadiness. Other features include clutch control for showing still pictures, with automatic fire shutter to protect film; double blower cooling system for lamp and film; 15-tooth sprockets with roller guides for full protection of film; and heavy duty AC-DC motor. Ask your dealer for a demonstration. Compare the Revere with the finest and you will agree that for \$59.50 the Revere 8 is top value. Mail coupon for literature!



All Revere Double 8 Cameras are licensed under Eastman Spool and Spindle Patents.

***REVERE Sprocket Film Control**

forms a loop in the film automatically—prevents film jamming . . . An exclusive Revere feature.

REVERE CAMERA COMPANY • CHICAGO
PHILADELPHIA • KANSAS CITY • MINNEAPOLIS • LOS ANGELES • DALLAS

REVERE CAMERA COMPANY
Dept. 10HM, 328 East 21st Street, Chicago, Ill.

Send complete facts on Revere 8 Projectors and other Revere motion picture equipment.

NAME _____

ADDRESS _____

CITY _____ STATE _____

*For Canadian prices, write to Ryerson Film Service,
299 Queens Street, West, Toronto*

**"COLOR PICTURES
MUST BE
PERFECTLY
EXPOSED"**

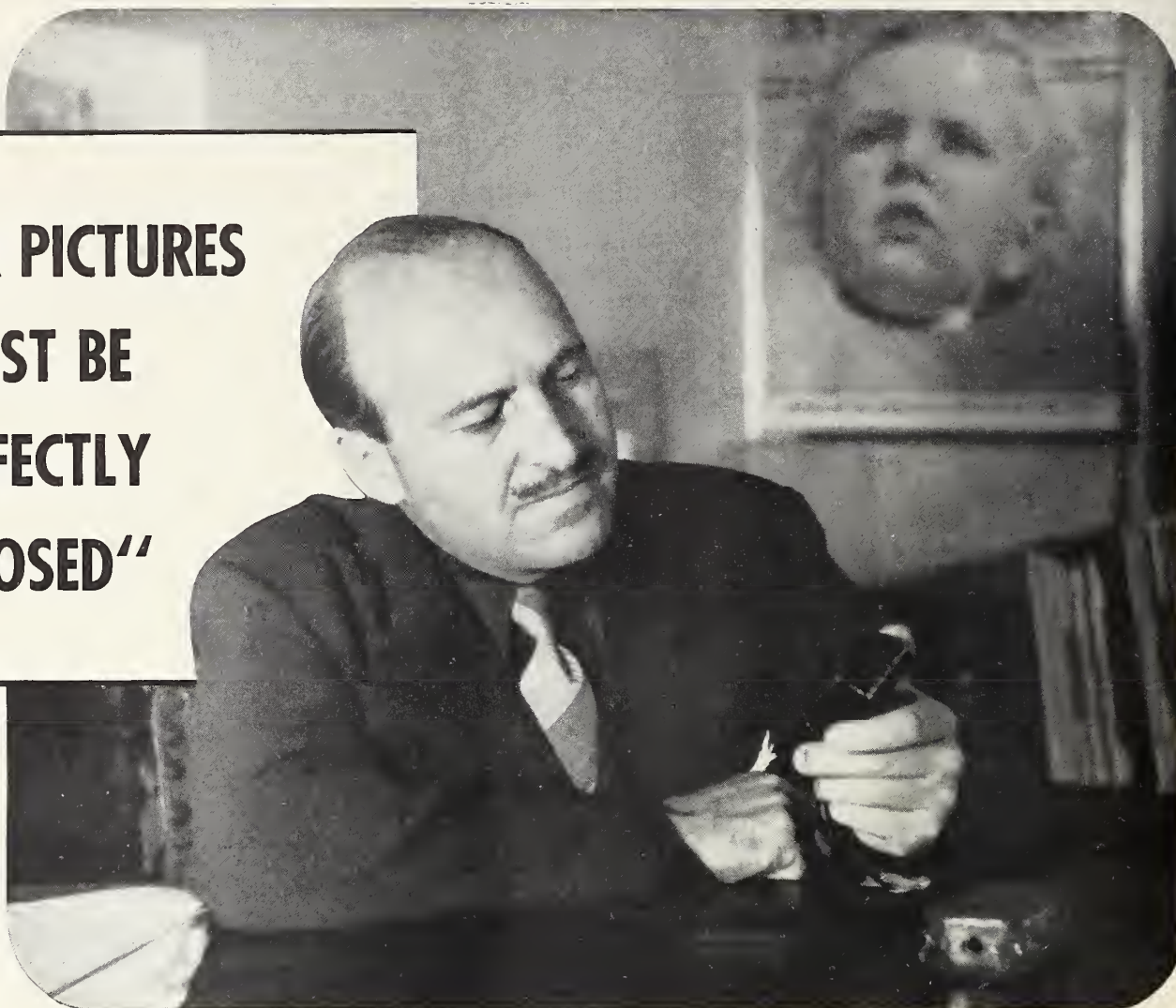

**—says IVAN DMITRI
noted Saturday Evening Post cover photographer**

MY assignments call for color pictures all over the world. Aerial shots, landscapes, and portraits from the north temperate zone to the tropics.

"When you're working within the very narrow latitude of color film, exposures must be right. Seemingly identical days during different seasons call for vastly different exposures. Although the human eye adjusts itself to changing light conditions, it cannot accurately calculate differences in exposure.

"Many of the pictures I take are on occasions that cannot be duplicated. Others are made on special sets that cannot be held for retakes. These shots must be just right for perfect four-color reproduction. I find my G-E meter an indispensable aid in accurately compensating for all variables."

The General Electric exposure meter covers a brightness range from 0.05 to 1700 candles per square foot. Film speeds up to 800. Stops from f:1 to f:44, shutter speeds from 1/2500 to 100 seconds. Simplified calculator with locking device. Designed for one-hand operation.

ation. Specially arranged for printing and enlarging. Ask for the meter that's used first to TAKE, then to MAKE perfect pictures.

NEW G-E METER FOR MOVIE MAKERS

It's the new Type DW-49—incorporating all quality and accuracy features of the Type DW-48, but designed especially for movie makers. It has a new pre-set calculator, which you set and lock before taking a reading. No further adjustment necessary. It's quick, convenient, accurate. Equally adaptable for stills. Price \$21.

If you own a Type DW-48, you can have a DW-49, too—and enjoy the advantages of both meters—by purchasing (for \$4.85) the new interchangeable hood with pre-set calculator at your dealer's. Or write to General Electric, Schenectady, N. Y.

GENERAL  ELECTRIC



Home Movies

MAGAZINE



**Subscription
Order Form**



HOME MOVIES

Published in Hollywood
OCTOBER 1940

NOW that it can be told, I suppose I ought to start at the beginning and state that "Angels Are Made of Wood" is one of those things—a brainstorm, some call it—that sort of comes to you all of a sudden. The idea, I mean. After some months trying out my new camera in order to get the "feel" of it, I began to yearn—as many amateurs do—to make an amateur movie that would be a real standout. So, from the very beginning, I felt this picture would have to be the best, at least the best that I, with my modest equipment and knowledge of movie making, could produce.

An observation, made quite early during my amateur movie making efforts, was that a successful picture could not be made simply by trying



The **WINNER** tells all . . . !

1940 Home Movies' Amateur Contest Winner Tells Inside Story of Producing "Angels Are Made of Wood"

By HERMAN BARTEL

to follow all of Hollywood's current picture making technique. For one thing, you can't adapt talking picture technique to silent picture making. If you do, the picture invariably falls flat. I reasoned that a successful home movie must follow some of the best techniques of the old silent pictures, chief of which was the art of conveying a thought by means of pantomime instead of words—either written or spoken.

So when the script for "Angels Are Made of Wood" was finally whipped into shape, there was a decided accent upon scenes where pantomime could be used to tell the story. Not one sub-title was planned in the script, and none was added after the picture was completed.

I won't go into detail about the story, for it was treated in considerable detail on page 416 of the September issue of HOME MOVIES. Suffice it is to say it concerned an artist confronted with a rush order for an advertising layout, which is completed by "Dodo," a wooden mannikin, while the artist slept.

The greater part of the picture involved single

frame photography in filming the animation sequences of "Dodo." But before proceeding with this phase of the picture making, perhaps I should say a few words about "my other actor"—Harry Etchells, who assumed and played to perfection the role of the "artist." Etchells is an amateur actor of some note, and the tribute paid him by the reviewers in the September issue of HOME MOVIES was highly deserving. Perhaps we have discovered a new team in Etchells and "Dodo" that may prove a serious threat to Charlie McCarthy and Edgar Bergen!

CONFIDENT that Etchells could adequately handle his bit in the picture, my next task was to determine the timing in animating "Dodo." One factor was definitely known—that the picture would be projected at 16 frames per second. One second of action, therefore, would consume 16 frames of film, meaning that the mannikin would have to be moved 16 times for one second of screening time if I were to shoot single-frame action,

• Top: Bartel (left) discusses animation technique with Harry Etchells, who played part of the artist in "Angels Are Made of Wood." Below: Typical set-up of lighting equipment for animation shots. Opening in paper shield in front of phataflood and reflector is covered with blue cellophane to give moonlight effect to the scene.



• Continued on Page 494

Authored by
ROY CREVELING

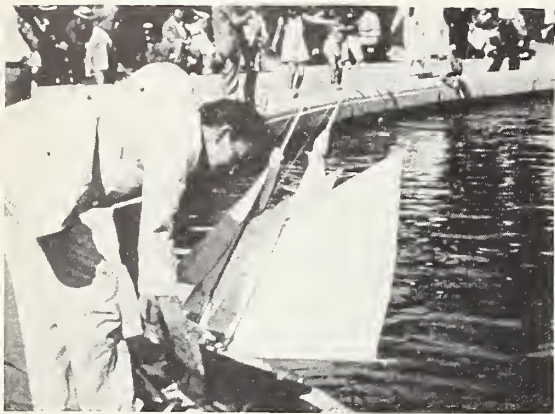
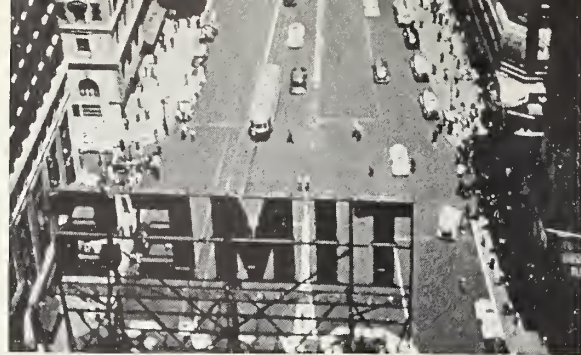
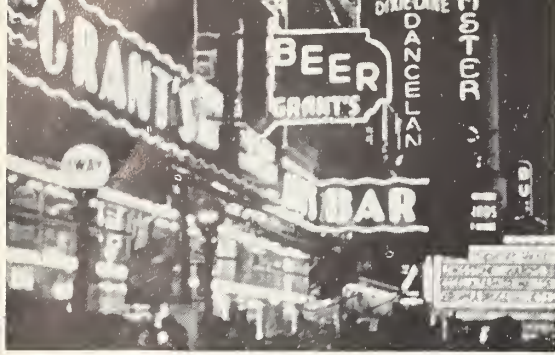

sooner had we deposited our fares in the coin box than our true cameramen's spirit returned and revolted at the thought of our retreating. We had come to the big city to explore it, hadn't we? Then nothing must stand in our way! So back to the street we went, invading and shooting big, bad, "colorful" Harlem!

Upon returning to the "Y" we spent the wee hours of the morning in our room working out a shooting schedule for our picture making. Maps, circulars, and programs — secured from the reading rooms — were

WE SHOT NEW YORK *our way . . . !*

IN order to fully appreciate "Manhattan Movie-Go-Round," which we premiered for a large host of friends in Easton last January, it seemed to us who made it that our audience should know something of the experiences we encountered in making this picture. And so we prepared a somewhat elaborate printed program in which we told our story and these were distributed to all who attended the premier showing.

With the exception of a few scenes, "Manhattan Movie Go-Round" was filmed by Fred E. Lewis and myself on one brief vacation jaunt to New York City. We'd seen a lot of amateur movies of New York and we thought we could make one better. We had some ideas and angles of our own, and we were prepared to try them as soon as we unbuckled our equipment after checking in at the Y.M.C.A. where we stayed in order to keep down the "overhead" of our production.

One of the spots skipped by most amateurs filming New York is Harlem. So we put Harlem down as one of the first and most important "locations" on our schedule. With the brashness of a couple of high school freshmen we barged into one of the toughest sections of New York's black belt just as a brace of mounted policemen were quelling a street brawl. We asked the officers for directions to a certain location. Observing that we were decidedly off our reservation, they declined the information and advised us to get out of Harlem and go on back home.

This admonishment, together with what we had just seen, sort of unnerved us. So we took their advice and retreated to the nearest subway station. No

spread upon the bed and floor of our room. Before retiring, we had charted just what we expected to photograph each day of our stay in New York and this was worked out right to the hour. It was amazing how closely we were able to keep to schedule. I have always found that plotting and planning a picture is half the fun of making it.

But finding our way around town was not as difficult as we anticipated it. As hardboiled as New Yorkers are reputed to be, we always found someone willing to direct us. Once when we inquired of the way to the Fulton Fish Markets, a chap good-naturedly pointed the way and added, "You can't miss it once you pick up the scent!"

One day we made the acquaintance of two smart looking girls on the top of a Fifth Avenue bus. Learning they were native New Yorkers, we asked to take them home. It seemed like a good idea in order to get some first-hand information about the city.

"We want to make some movies of the slums," I told them. "Where is the best place to get some good shots?"

"You mean the tenement district?" the dark-eyed girl asked. "Well, when you take us home, you'll be right in the midst of it. That's where we live!"

DOWN in Chinatown we received our second big scare; the result of the camera jamming right in the midst of filming that colorful section. The camera had to be fixed and that required a dark room . . . a dark room in Chinatown! I started down a long, stone stair which led into a cellar, but Fred made me come back . . . not that I had to be coaxed very much.

Finally we peeped into a feed store, the distant

• Continued on Page 502

• Pictured above are scenes from Ray Creveling's and Fred E. Lewis' picture, "Manhattan Movie-Go-Round." Below, photo made by interested onlooker of Creveling and Lewis as they sprawled on the sidewalks of New York for a special angle shot they sought.



Reported by
J. H. SCHOEN



A. O. JENSEN

A. O. JENSEN must have had a lot of fun making "Driftwood"—especially in the preparation of it. It must have been fun poking around the various places in and near Seattle in search of the highly interesting locations of which there were a great many in this 400-foot 8mm picture. It must have been

fun shooting all those scenes in the rain—and real Seattle rain, too! And it must have been fun screen-testing the many prospective actors and then finding a trio of amateurs who really could act and who, it must be said, contributed much to the success of this picture.

In choosing "Driftwood" as the Movie of the Month, the Editors feel that added recognition should be given for the real job done by Jensen in the story, actor, and technical preparation which is more than half the fun of making any home movie. As a rule, a home movie will excel in photography, or editing, or titling, etc.; but rarely do we find a picture which rates high averages in all departments as does this one.

"Driftwood" is the story of a homeless girl, a youth, and a drunken old drifter. The picture opens with scenes of revelry in a cafe on New Year's Eve, made highly interesting by some mighty fine montage and dissolve effects by Jensen. As the hour of 3 A. M. approaches, the celebrants have left the cafe—all but the ragged old drifter, whom we find dead drunk at the bar. The waiter tosses him out on the pavement, wet with rain, leaving him to stumble home to his old waterfront shack as best he can.

Back in the kitchen, the little heroine, played so admirably by Miss Arlene Osthoff, is struggling with stacks of dishes and taking a great deal of abuse from the cook. The boss, hearing the argument, abruptly enters the kitchen, causing the girl to drop and break a stack of plates. Enraged, the boss manhandles the girl. She eludes him after cracking a plate over his head. Of course, this stuns the boss and, fearing she has killed him, the girl flees from the cafe, seeking refuge in a shack near the waterfront.

The shack belongs to the ragged old derelict whom the bartender tossed into the street earlier in the morning, and after several hours trudging around in the rain, the old fellow finds his way home. Still very drunk, he scarcely sees the girl, who becomes quite frightened upon his entrance, and then he collapses on the floor of the shack. The girl struggles to get him to bed, and some time later as she is preparing his breakfast, the old man awakens somewhat sober and reaches for a flask of whiskey. The girl snatches it from him and throws it out the window.

A youthful fisherman, passing in a rowboat, is struck by the bottle. Playfully, he throws a fish back through the window. The girl, puzzled, goes to the window, sees the youth, both smile, and—well, this is where the boy meets the girl.



MOVIE of the MONTH

The fisherman returns later in the day with a be-ribboned package, ostensibly from the florist's, which he leaves on the girl's doorstep. Upon opening it she finds it contains two slimy fish. Enraged, she takes up the old man's shotgun and goes out in search of the fisherman whom she believes to be playing tricks on her. But outside, tacked on the wall of an adjacent shack is a plac-

• Continued on Page 503

• "Driftwood" drew for its producer one of the coveted Achievement Awards for editing in this magazine's recently concluded amateur movie contest. It is further acclaimed for its fine continuity, good photography and acting abilities of the cast.

Authored by
CURTIS RANDALL

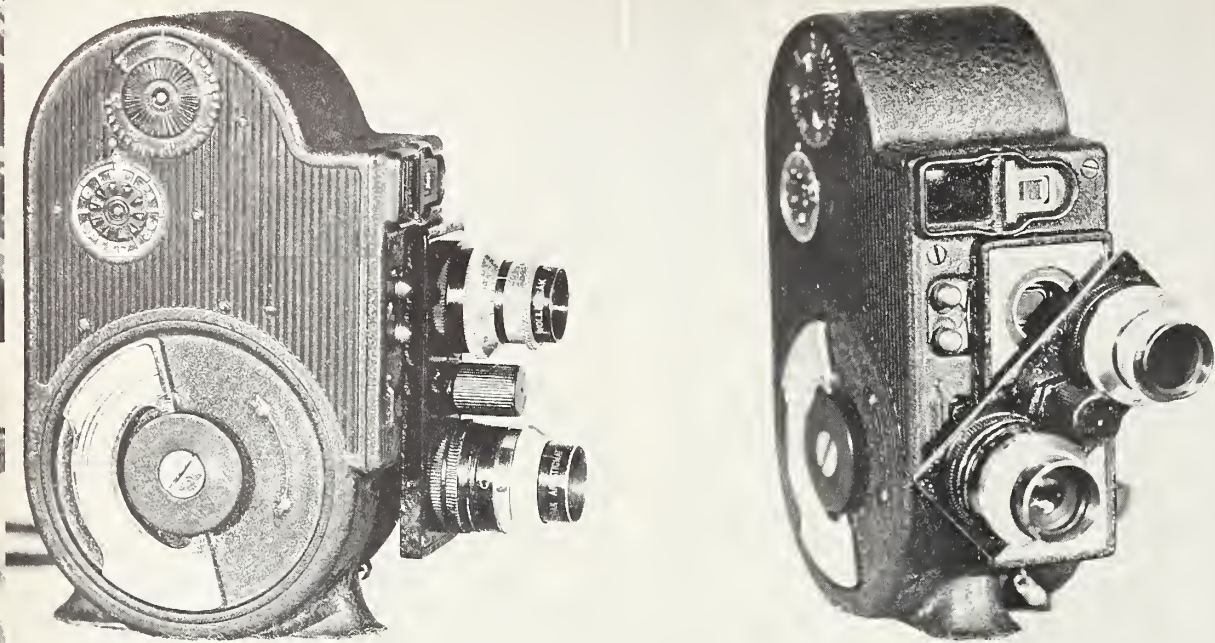

A DEMOUNTABLE TURRET *any* *amateur can build . . .*

OF ALL the cine cameras, the Filmo "8" offers the simplest means for adding a home-made turret front. E. Leroy Saffer, of Albany, N. Y., has designed and built a nifty little gadget that may be attached to any Filmo "8" in a jiffy to provide a two-lens turret and without altering the camera in any way whatever.

Cinebug Saffer made this turret from materials easy to secure from the average heavy hardware store, and any ambitious Filmo "8" owner can do the same thing for his camera, providing a turret into which he may fit his regular Filmo half-inch lens, and another lens—a telephoto of the size to suit his needs.

To attach this turret to the camera, the regular camera lens is separated from the adapter and the shim, as shown in Fig. 4. The adapter is screwed into the turret, which permits snapping it into place over the lens opening in the same manner as the regular lens. The lens, minus the adapter and shim, is then screwed into one of the openings in the turret rotor plate. A telephoto lens is mounted in the opposite opening.

To change lenses, all that is necessary is to lift the rotor plate by pulling outward on the knob, revolve it until the other lens is in position, and then allow it to recede into place. In fact, this operation is almost automatic, as there are two guide pins on the rotor plate which find two holes during this operation and cause the rotor to fall snugly into accurate position. Thus, sharp focusing of lens is always assured.

The entire unit is held firmly in place, first, by the lens adapter already described, then by means of the lens mounting pin in the camera case, and

again by a slot in the rear of the turret which fits over one of the exposure button guards on the camera case, preventing the unit swinging when the rotor is revolved.

The turret consists of two major parts—the stator plate that is attached to the camera, as already described, and the rotor plate to which is fitted the lenses (see Fig. 1). The rotor is attached to the stator plate by means of a tubular shaft which fits over the rotor bearing. The spring "C" serves to keep the rotor in close contact with the stator plate when in filming position. It also permits revolving the rotor without any unnecessary or extra adjustments. To shift from one lens to another, the rotor plate is lifted by pulling outward on the bearing cap "F" until plate will rotate. The plate moves upon two guide pins "E" until they find corresponding holes in the rotor plate which allow the rotor to fall into position. The change is accomplished in a fraction of a second.

THE stator plate "A" is made from a piece of $1\frac{1}{4}$ " channel brass obtainable at any heavy hardware supply house. This material has sides $\frac{1}{8}$ " thick which should be filed or milled down to $\frac{1}{16}$ " in thickness, leaving the plate $1\frac{1}{8}$ " wide. Inside measurements, between the channel sides, is just 1" which provides for using 1" material for the rotor plate. Brass, in strips 1" wide, is obtainable in thickness of $\frac{1}{16}$ ", so this permits cutting down height of channel sides to conform with this thickness when rotor is in place, giving an overall outside depth of the stator plate of $\frac{3}{16}$ ".

Next, cut a piece of the 1" brass material $2\frac{1}{2}$ " long for the rotor and lay it in the channel of the

• Here's a nifty turret for the Filmo "8" that can be attached to the camera in a jiffy and detached at will. No alterations whatever are necessary on the camera. The same patented safety ring that holds the regular Filmo lens is used to hold the turret in place.

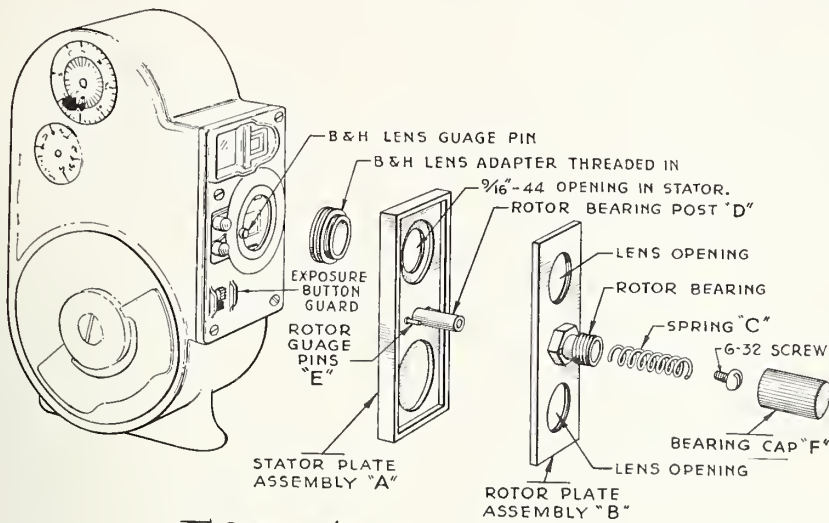

Fig. 1

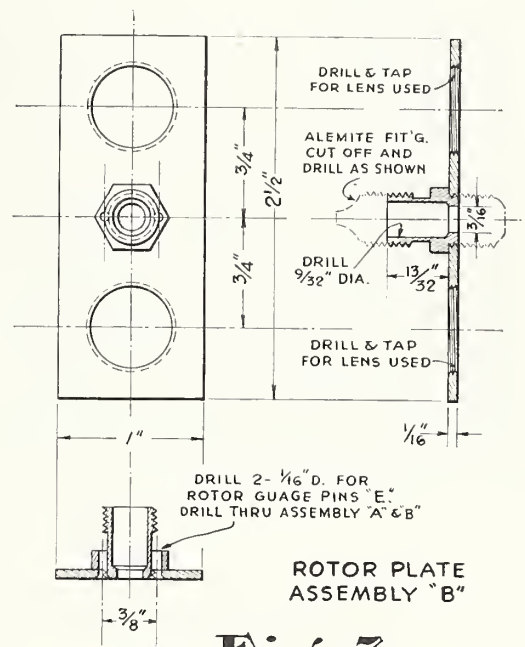

Fig. 3

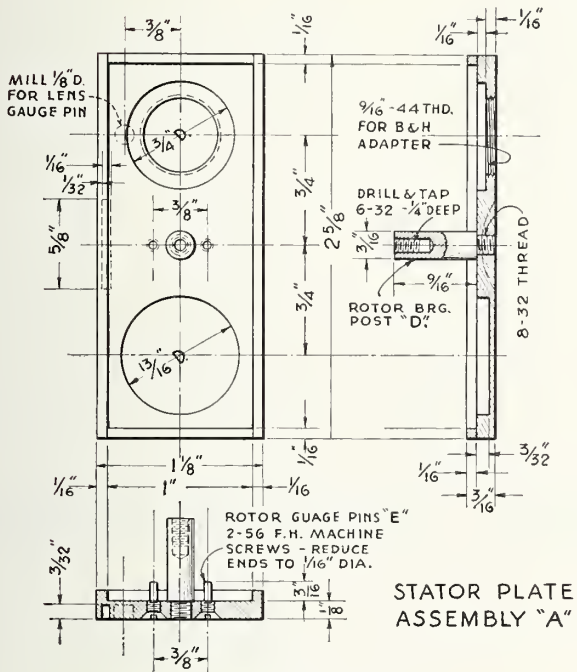

Fig. 2

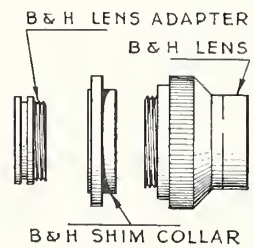

Fig. 4

DETAILED PLANS FOR BUILDING
LENS TURRET
FOR
BELL & HOWELL 8mm CAMERA

stator. Then solder small pieces of brass at either end of the channel to close the ends and form a complete wall around the stator plate.

Placing the rotor plate again inside the stator channel, measure the exact center and drill a hole through both plates with a No. 29 drill. Tap the stator 8x32 and mount the rotor bearing post "D." This post may be made of 3/16" round brass and threaded 8x32 to seat into the tapped hole in the stator. The post is then drilled and tapped for the 6x32 spring retaining screw, shown in Fig. 1. The post, when mounted, should extend 5/8" from base of stator plate, and it may be filed off later in order to allow the bearing cap "F" to fit over the spring retaining screw.

Construction of the spring housing and rotor bearing is illustrated in detail in Fig. 3. This is made from an Alemite automobile pump oil nipple which may be had complete with cap for only

a few cents from any automotive supply house.

The holes in the rotor plate which take the lenses are 1 1/2" from center to center and centered 3/4" from center of the rotor bearing post. These holes are threaded according to the lenses that are to be used. Where Wollensak 8mm lenses—such as those designed for the Keystone 8mm camera—are to be used, the holes should be drilled and tapped 5/8"x32. Where the original Bell & Howell lens is to be used in one of the openings, the hole should be drilled 5/8" but tapped for a No. 56 thread.

IT is advisable to start these holes first with a small drill on one side, reverse the plate, and drill through on the other side, and then increase size of drill as required. This will insure accurate registry regardless of which way the rotor plate is turned.

One hole should be continued on through the

• The above plans will enable any amateur to build, or to have built for him, a lens turret for the Filma "Eight."

• Continued on Page 507

Our cameraman visits the home of

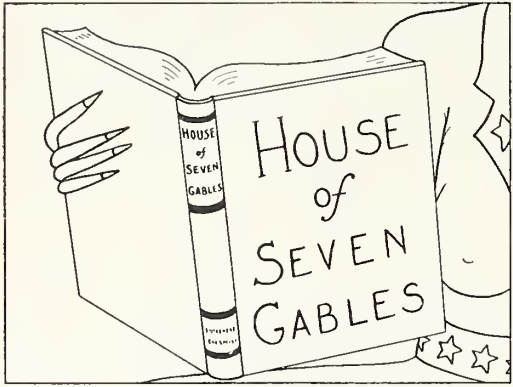
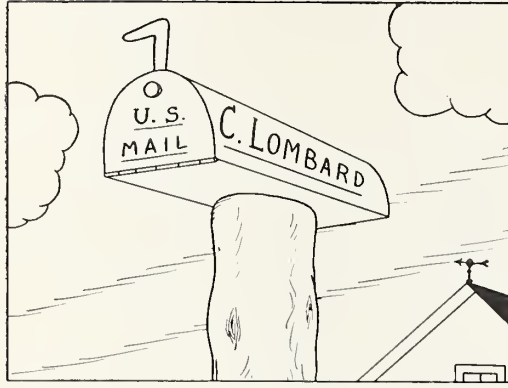

Back on Hollywood Boulevard, we find

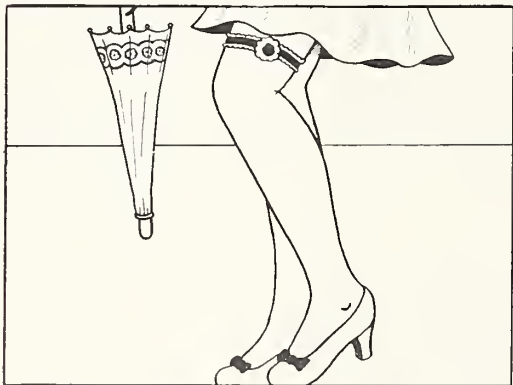

Authored by
WALTER W. LIGHT



ACCURATE ALIGNMENT *essential*

in animating cartoons . . .

LAST month we explained how to photograph pen and ink drawings so as to make them move for a home-made animated cartoon film. This month we present the second set of cartoons on the opposite page and also additional instructions.

One essential thing to keep in mind is that each drawing must be accurately lined up in the title holder, or on title board, to insure registry on the screen with the drawing that preceded it. If this is not done, the pictures will appear to jump about on the screen and will not be like the professional jobs we see on theatre screens.

If you are using a typewriter titler for this work — and you probably are — inasmuch as the drawings on the opposite page as well as those published last month were scaled down to fit such titlers — the easiest way to insure accurate alignment is to fit the card holder of the titler with a mask and then place alignment marks in the exact center of the top, bottom, and side edges as shown in the above photo. With the mask so marked, place corresponding marks on the edges of each drawing with a pencil so that when each drawing is placed in the titler behind the mask it may readily be centered by lining up the pencil marks with the marks on the mask.

It may be found easier to manipulate the drawings by placing them in the titler in strips, as shown in the photo. Slide them back and forth in titler as needed.

With this month's series of illustrations, first, photograph the sub-title, "*Our Cameraman Visits the Home of . . .*" Next, expose the first drawing of the mail box for about 4 seconds (64 frames). Then expose the second drawing, the closeup of Miss Lombard, for at least 80 to 100 frames. Make

the next cartoon a closeup of the book about the same length. Expose the next cartoon of Miss Lombard gazing into space for 40 to 50 frames; expose the fifth cartoon (the seven "Gables") for at least 100 frames; then go back and expose 50 frames of the second drawing cartoon. Next, expose a short scene of the mail box again (about 50 frames). This completes the sequence.

Expose the next sub-title, "*Back on Hollywood Boulevard We Find . . .*" The first scene of Mr. Chaplin is composed of two cartoons. Expose about 30 to 40 frames of the first drawing of this series, then 3 frames alternately of each drawing for a total of 125 frames or more. Next, expose about 80 frames of the girl's leg. Now go back and make a short scene of Charlie tipping his hat very fast (expose 1, 2, or 3 frames alternately of the first and second drawings of Chaplin for this effect). Next, make a short scene of the leg again, then expose the closeup of Charlie's face. This can be any length desired and the speed of the eye-rolling, etc., should be varied. Finally, expose the last scene of Charlie getting the umbrella over his head, 2 frames of each cartoon—alternately—then 1 frame of each alternately. Total length of this scene should be at least 125 frames. This completes the second sequence of this month's installment.

IF A few extra scenes are desired, copy the cartoons with a still camera (a mini-camera will do) and make 5 x 7 or 8 x 10 inch enlargements of the desired frames (or portions of the cartoons desired) on paper. Be sure they are sharp and contrasty. These can be cut up and used for "panning"

• A mask, fitted in the title card holder and marked to indicate the exact center of each edge of the opening, will aid in lining up accurately each of the drawings in the animation series.

• Continued on Page 507

Authored by
GEORGE W. CUSHMAN



Von Schoenfeldt

Toning of Kodachrome has also been done with pleasing results. For instance, a sunset is sometimes improved by toning it red. Ocean scenes shot on grey days seldom photograph like the typical blue of the ocean. A bit of blue dye does wonders for a shot of this kind.

And here is a stunt known by relatively few amateurs. Moonlight shots, as most workers know, are usually made by giving two or three stops less exposure. This works fine on black and white, but those who have tried it on Kodachrome know that by underexposing this much, the colors are any-

It's easy to TINT and TONE your films . . . !

MANY a foot of cine film has been shot in black and white and left just that way, the movie maker not having realized that the shot might have been improved a hundred fold by tinting or toning it. Some scenes do look better in black and white, that's true; yet sunsets, night fires, ocean waves, etc., appear much more natural by having an appropriate color added to them.

A few pointers along this line appeared in the April issue this year and several readers asked for more information on this subject. Thus we present here some additional formulae and procedures.

It might be wise first to repeat again the difference between tinting and toning for the benefit of those who may have missed the April issue. Tinting colors the base of the film — that is, the celluloid, while toning colors the emulsion. This being true, a black and white film that is tinted blue becomes blue and black (the whites changing to blue) while one that is toned blue becomes blue and white. (In this instance the blacks have been changed to blue, the highlights remaining clear.) Bearing this in mind it is possible to tint a film one

color and tone it another.

There are other uses for tinting and toning than merely coloring the film. Many times an over-exposed film can be improved by toning it with a toner that serves also as an intensifier. Likewise, there are toners which act as a reducing agent, and these are used on scenes which are too dark.

thing but natural. The blue sky turns almost purple, skin textures become deep red, etc. The secret of making a faked moonlight shot on Kodachrome is to give the correct exposure or nearly so, thus obtaining the correct color, and then to dye the film in black dye until the proper "moonlight" density is obtained. The dye darkens the color, but does not change it, and the moonlight effect is obtained with true color still present.

Neither tinting nor toning is difficult. A dark-room is not needed — the work can be done anywhere. Many workers prefer to mix their own solutions, while others like the ready-mixed solutions. Some procedures require two or three different baths while others require only one. The Mansfield Laboratories of Chicago have a good single solution toner now on the market which gives excellent results, the film being dipped in the solution until the desired tone is acquired. They are obtainable in several colors. Practically all commercially made toners and dye preparations for this purpose are satisfactory when instructions are followed.

WITH any solution of this kind there are some precautions which must be followed for best results. First of all the film must be washed thoroughly in running water to erase all traces of hypo. If any hypo is left on the film it will probably cause streaking and prevent the dye from working evenly. Film to be toned that is dry should be pre-soaked in clear water several minutes to soften the emulsion and permit the dye or toner to work evenly. With paper prints or lantern slides such unevenness would not be nearly as important, but unevenness on motion picture film shows badly when projected upon the screen.

Secondly, the dye solutions should be used quite

• Continued on Page 501

• Toning of Kodachrome has also been done with pleasing results. Sunset scenes like the above may be improved by toning with red. Below: An ordinary photo tray and simple wooden rack is all that is needed for tinting or toning individual scenes.

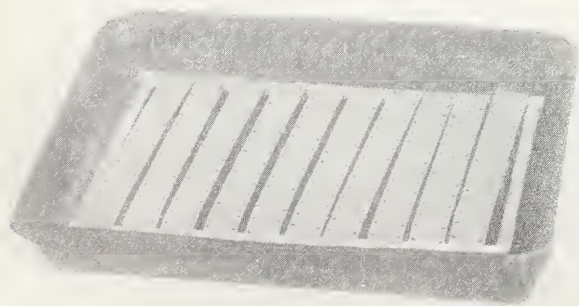

Authored by
DR. A. K. BAUMGARDNER



FIG. 1

HAVING established the procedure for the performance of auxiliary lenses with the camera lens set for infinity, we are ready to deal with the advanced phases of these lenses when employed for other purposes. In brief review, we are to consider that the use of an auxiliary lens is to render the rays of light parallel as they enter the camera lens. Applying the wave theory, we determine the focal length of the auxiliary lens and use that distance to photograph the subject. This rule applies only when the camera lens is set for infinity.

However, an auxiliary lens has unlimited possibilities when properly used at other distances, but mathematical formulae must be considered to make this possible. Otherwise, blur will result to the extent that the picture will be ruined. The range of an auxiliary lens is limited by that which we know as depth of focus and this presents an important factor for our study of advanced lens adaptation.

For those who have focusing mounts on their cameras, a single auxiliary can be made to produce a sharp focus at any distance within the adjustment of the camera lens. With the basic rule that one dioptré lens focuses parallel rays of light at one metre (39.37 inches) we can compute the dioptric value of the combination of the auxiliary with the camera lens at any short range and confine our work to that combination by making changes in the focusing adjustment. Let us assume that we have a 2 dioptré auxiliary lens which focuses at one-half metre, or roughly 20 inches with the camera lens set at infinity. By changing

What an **AUXILIARY LENS** will do . . .

the adjustment of the focusing mount we produce sharp focus at the various distances as indicated by the following table.

<i>Lens Setting</i>	<i>Distance of Focus</i>
2 feet.....	10.80 inches
3 feet.....	12.74 inches
4 feet.....	13.76 inches
5 feet.....	14.80 inches
6 feet.....	15.44 inches

THIS table is computed by converting the lens setting to inches and determining the dioptric value of the lens setting alone, then adding the dioptric value of the auxiliary and converting the total back into inches. For example a lens setting of two feet represents 24 inches or a dioptric value of 1.64. By adding the 2 dioptré auxiliary we have a total of 3.64 which will focus at 10.80 inches. The analysis of the table will show some startling results. For instance, with a 2 dioptré lens which has a focal length of 20 inches, we are able to

• Auxiliary lenses are far more flexible than is commonly known. When you want to shoot an ultra closeup or make a title, it's an auxiliary lens placed in front of the camera lens in most cases that makes the shot possible.

• Continued on Page 496

FIG. 3

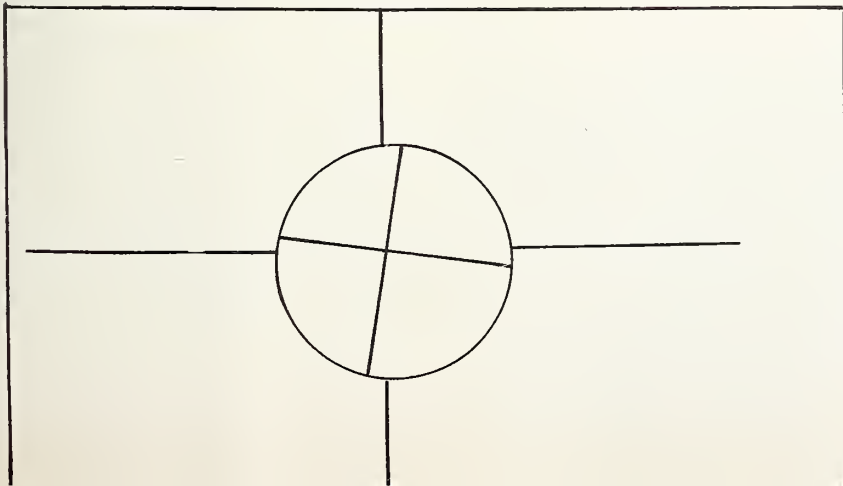
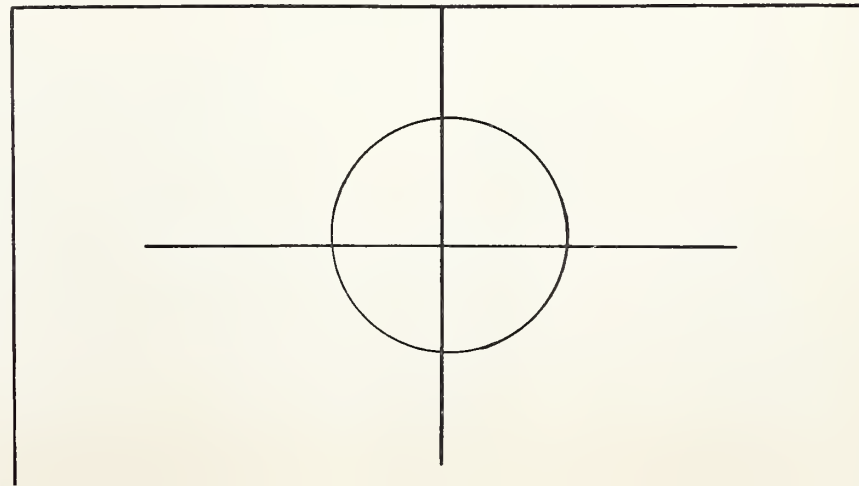

FIG. 2



Authored by
R. E. WORSTEL



Are you prepared for INDOOR FILMING...?

WEBSTER defines inventory as "an itemized list of goods with their estimated worth." The home movie enthusiast should express it as, "Do I have any lighting equipment, and if so, is it adequate for my needs for indoor filming this winter?" Certainly, the old adage, "an ounce of prevention is worth a pound of cure," applies to the cine enthusiast at the beginning of the indoor season.

Don't think of the Fall as the close of the filming season. Think of it as the opening of the *indoor* season.

What does summer sunlight have that artificial light does not have? Only one thing — quantity. A photographer has no control over the color of daylight, its distribution or intensity on the subject. If there is a clear sky and a brilliant sun the lighting may be harsh with deep impenetrable shadows. If the sky is overcast, the lighting will be "flat." There will be no shadows and therefore very little contrast.

The color of daylight changes continuously. It is affected by the position of the sun, the area of clouds visible, and the amount of haze — a real headache for the color cinematographer.

There was a time when it was necessary to put the movie camera on the shelf during the winter.

Film was relatively insensitive and light sources generally inadequate. Today there are a number of highly sensitive films available, and to produce light there is the small, powerful photoflood lamp, suitable for black-and-white or color.

The effectiveness of any light source is increased with the use of a good reflector. At least three times as much light is received on the subject when a lamp is fitted with an efficient reflector compared with that obtained from a bare lamp. This alone makes ownership of a reflector a good investment.

In addition to increasing the light on the subject, reflectors improve the quality of the light. Sharpness and density of shadows depend to a large extent upon the size of the light source. When a reflector is used, it becomes the source of light and the size of the source is increased from that of the lamp bulb to the diameter of the reflector. The use of a reflector for a general lighting unit therefore creates softer and more pleasing shadows.

A large percentage of indoor shots may be taken with two reflector units employing either No. 1 or No. 2 photofloods. The No. 1 is a 250-watt, 2-hour life lamp having the same physical size as a 60-watt house lighting bulb while the No. 2 consumes 500 watts and has the same dimensions as a 150-watt bulb.

A standard and very reliable lighting arrangement consists in locating one reflecting unit near the camera and directed full upon the subject. This provides general illumination of uniform intensity over the subject. Another unit located slightly higher and out about 45 degrees from the subject provides more illumination on one side of the subject than on the other. Thus the lighting is unbalanced with the modeling light and the subject has roundness and form. The accompanying illustration (Sketch No. 1) was made with two light sources as described.

The illumination on the subject from the modeling light should be at least twice that from the front or general lighting unit. For example, this can be done by using a No. 1 photoflood in front and a No. 2 in the modeling unit, both located at the same distance from the subject. Another scheme is to use the same size lamp in both units but move the modeling lamp at least thirty per cent closer to the subject than the front lighting reflector.

IT IS possible to use one light source and obtain satisfactory results but unless done by an expert, faces will be white and chalky with deep shadows on the side of the subject opposite to that on which the source is located. If only one reflector unit is available, it should be located at about 45 degrees as in the case of the modeling light as de-

• Lighting charts below show two alternatives for lighting the setting pictured above: 1—by means of two light sources, and 2—with one light source and a white cardboard or cloth reflector.

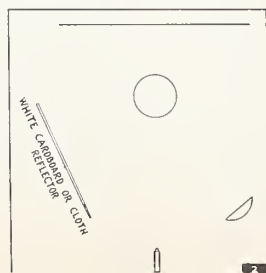
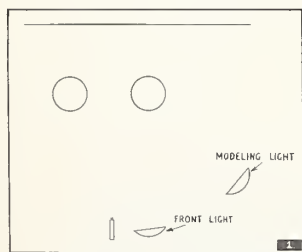

Authored by
S. J. WILLIAMS

Detail? It depends upon the EMULSION

LAST month, in the article, "What Type Film Should I Use?" we sought to make clear to the amateur the basic characteristics of all cine films — panchromatic, orthochromatic, and "semi-orthochromatic" — and to explain the results to be expected from the use of each.

This month, we shall continue with the subject, giving emphasis to the characteristics of the slower, less sensitive emulsions.

Frequently in advertisements one sees a film referred to as a "semi-orthochromatic" or "semi-ortho" type. According to statements from the laboratories of one of the nation's leading film manufacturers, such films are usually of the basically "color-blind" type, though sometimes with a slight degree of sensitivity in the green; they differ basically from the true "ortho" films, which are sensitive not only to blue and green, but to the yellow, and in some cases (such as Agfa's Plenachrome) to a limited extent to the orange as well.

It may also be pointed out that virtually all of the non-panchromatic films are lacking in shadow speed — that is, granting a correct overall exposure for the picture as a whole, shadows with these films fill up quickly — become so badly under-exposed that they are just empty black spaces — whereas with most of the panchromatic types, granted a correct overall exposure, there will be a reasonable amount of detail visible in most shadows.

The illustrations on this page show enlargements made from 16mm frames of each of the respective films. Fig. 1 is a frame from a 16mm "semi-ortho" film and is a good example of the absence of detail in shadows characteristic of this type film. Note that the beach sand records in a normal tone while the flesh of the subjects containing a predominance of red, registers decidedly dark and in some areas, black.

Fig. 2 is a frame made on standard orthochromatic film by the same camera, at the same location, under the same light conditions, and of one of the subjects in the first photo. There is a truer rendition of tones throughout the scene, and shadow detail is quite normal in the face of the child.

Fig. 3 is a frame from a 16mm panchromatic film, shot at the same beach location, of the same subject, and under the same light conditions. Note the perfect rendition of detail in the shadow cast by a beach umbrella just beyond the child's head. Such detail could not be obtained with "semi-ortho" or other color blind films. Also, there is an increased quality of tone in the subject's features and clothing, not found in either of the two preceding pictures.

In the foregoing it may also be noticed that in general the "color-blind" films are the slowest and the panchromatic types fastest. However, speed alone is no evidence that a film is or is not panchromatic. Some of the ortho types — like Agfa Plenachrome and Gevaert Ortho — are quite fast, with speeds of Weston 16 or over, while some of the finer-grained panchromatic types — like Eastman safety film, DuPont "regular" pan negative, Gevaert fine grain panchro and especially Eastman regular 8mm — are relatively slow, with speeds of Weston 12 or even 8. The best test of whether or not a film is panchromatic is to try it and see how it reproduces red and blue. Especially, try it with various filters. If a yellow filter, even with the fullest exposure, doesn't give an image, the film is color-blind. If an orange or red filter gives just a black, virtually unexposed film, while a yellow filter works, it is an ortho type. If you can use a red filter, the film is sure to be panchromatic.

• Continued on Page 506

• Illustrated are enlargements made from (1) a "semi-ortho" film; (2) orthochromatic film; and (3) panchromatic film. These pictures were especially filmed with the same 16mm camera at the same location and of the same subject to illustrate the recording qualities of the various film emulsions. Interesting is the absence of speed in the shadows and inability to render true tones to red colors by color-blind "semi-ortho" film, as demonstrated in the first picture.



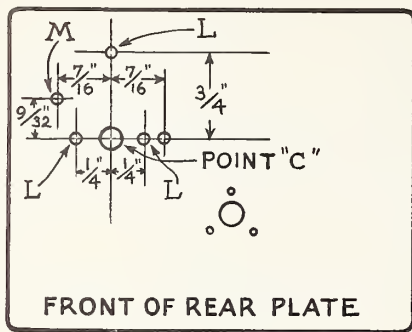

Fig. 17

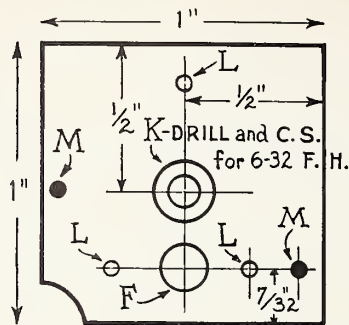

Fig. 18

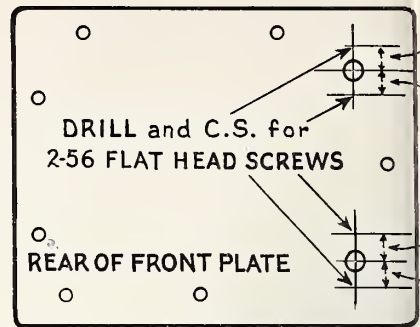
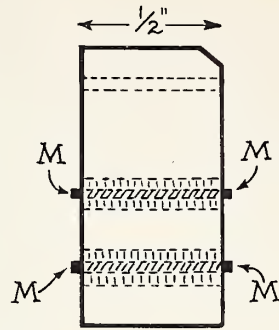

Fig. 20

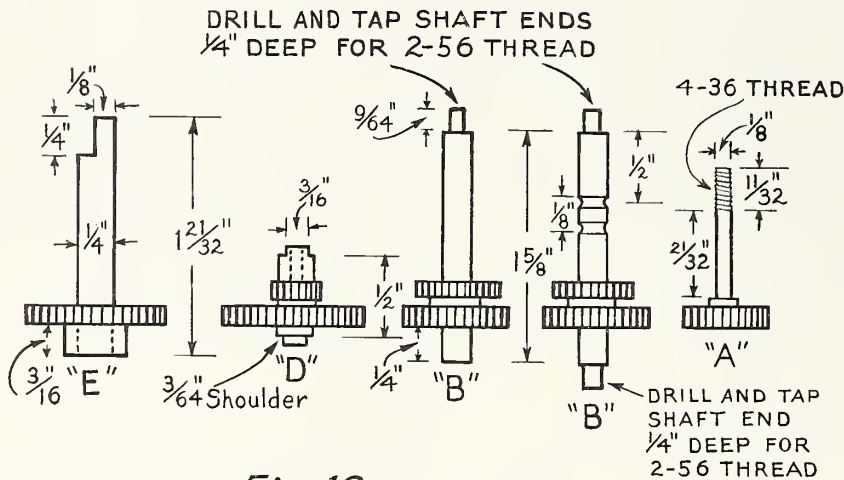

Fig. 19

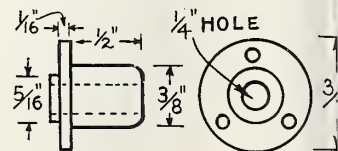
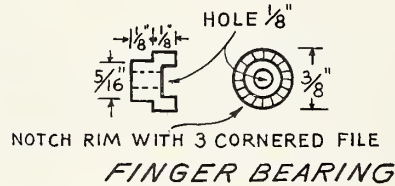
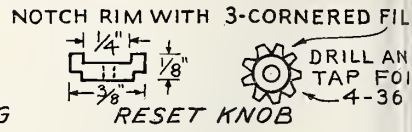
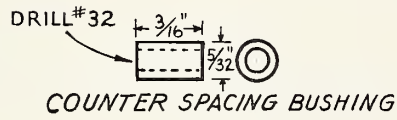

Fig. 21

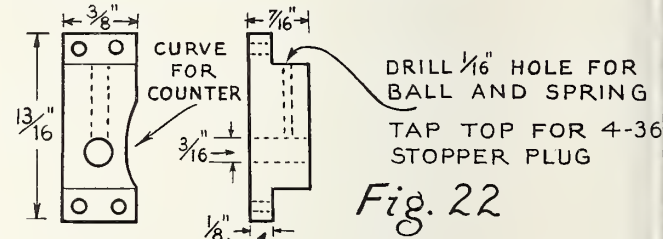

Fig. 22

Frame counters and gears for "GLORIFIED 16"

Authored by
ARTHUR H. HART

AT THE conclusion of this article, those cinebugs who have already undertaken the construction of the several gadgets necessary to build the "Glorified 16" will be able to complete the most important part of the mechanism that controls the effects devices, *i. e.*, the wipe-off fans and the fading and dissolving apparatus.

Perhaps you are eager to get going, so we'll get right down to details and instructions. After laying out the points "A," "B," "C," "D" and "E" on the face plate, they are ready for drilling with a No. 43 drill.

Points "A" and "E" are only drilled through the front plate, while points "B," "C" and "D" are

drilled through both plates. Point "C" on front plate is then tapped for a 4-36 thread into which a slightly oversized screw is placed, then filed flat so as to blank the front hole. Points "A," "B" and "D" are redrilled with an 11/64" drill and finished and reamed with a 3/16" reamer. Point "D" is then drilled and reamed for 5/16". Direct contact between the crank gear housing and the effects gear box is now ready to start.

Between these two are placed a brass spacer one inch square and one-half inch thick. This is fastened to the crank gear housing with a single 6-32x3/4" flat head screw. The rear effects box plate being fastened to this spacer by three 2-56x1/2" flat head screws. Pilot pins are placed in the spacer so that one side enters into the crank gear housing, while the other side serves to hold the rear effects plate in place.

FIG. 18 shows the dimension of this spacer. A 3/16" hole is drilled through at point "F." A 10-32 screw is passed through this hole and on into hole "J," placing a nut on the inside of the crank gear housing.

• Continued on Page 498

FIG. 14

FIG. 15

FIG. 16

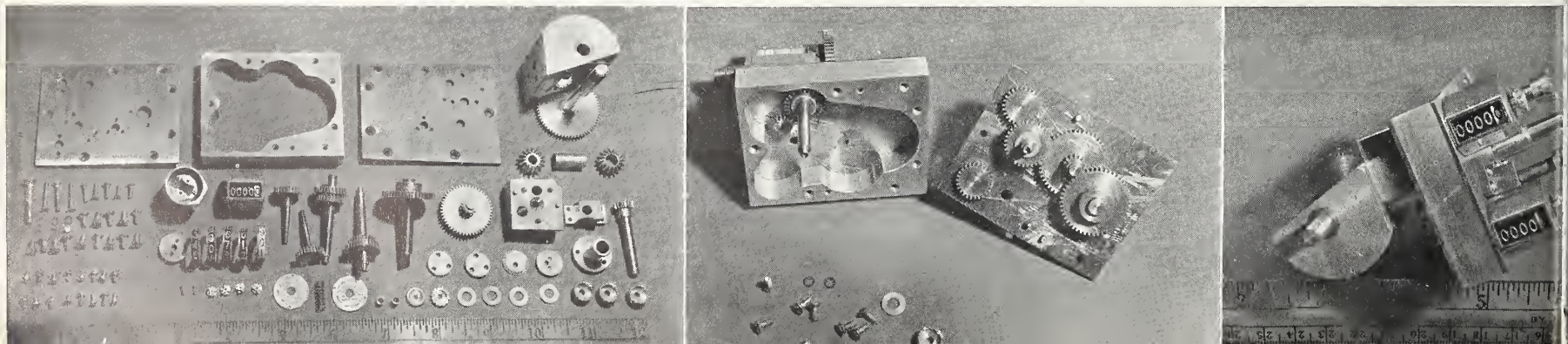

Authored by
JOHN H. KLOK*

MOST home movie enthusiasts at some time or other have taken a few feet of film of their pet dogs, but few amateurs have built any great or interesting movies around these intelligent pets. Yet, unquestionably, one's dog when trained is one of the most willing of actors and very interesting plays can be worked around him without great cost.

Only a few weeks ago I saw the movie, "The Biscuit Eater." I have not seen a movie in years that pulls on the heart-strings as this one does.



Teach YOUR DOG TO ACT in *your home movies . . .*

Such a picture as "The Biscuit Eater" could have been produced by any amateur movie club or by most individual amateurs because the props were all of the home-grown variety. This particular movie, as many of you probably know, was built around a hunting dog. It could have been built around any dog. For instance, had it been planned for, let us say, any of the working breeds, the Shepherd, Doberman Pinscher, Collie or Boxer, the plot could have been worked out by having your boy or girl get what appeared to be the runt of the litter. (Now, you may not have the kennels for atmosphere, but it would not be difficult to arrange with a near-by kennel for shooting the necessary scenes.) Then have the children apparently train the dog, and of course have him do a lot of things he should not do. (You will be surprised how a trained dog can act out these misdemeanors.) And finally, as a climax, have him enter an obedience test and actually come through with a C. D. certificate. You know, any pedigreed dog can be entered in these contests at most dog shows for only \$3.00, so you can put real color in your dog-movie.

Of course, to enter a dog in an actual show, one must have a pedigreed dog. So for those who do not have one of these so-called aristocrats of the canine world, the whole plot can be changed to involve a poor pup which Junior found in the alley.

The dog becomes the hero by becoming the breadwinner of the family when the father loses his business or position, and after the last dollar has been spent, Junior gets the bright idea of putting on shows with his trained wonder dog. These prove very successful and Fido is discovered by a Hollywood scout and goes on to fame and fortune and the family move back to their home on Main Street, or whatever ending you may wish to give the story.

TO MAKE a dog a successful movie actor, the first requirement is that he be trained in absolute obedience, which means that when you give him a command he must execute it at once. The wisest plan, of course, is to send him to a training school for a month or two for his education. Yet anyone can train his dog if he has the patience and can devote a little time to the dog every day for a few months. He must first be taught to sit, lie down, always come when called, jump over hurdles, carry objects in his mouth and pick up things, and go to given places. For instance, if you are in a park

● Perhaps your dog is another Rin Tin Tin just waiting for the training and the opportunity that will make him famous, too!

*Director of Special Training, LaSalle Kennels, Minneapolis.

TITLE CENTERING GUIDES

... for 16mm Bolex, 16mm Victor, and 8mm Keystone cameras.

THESE guides are especially drawn to fit the average typewriter titler and may be used in conjunction with the Title Backgrounds, published each month in HOME MOVIES, as a means of accurately centering same.

To use with typewriter titlers, insert guide in card holder, line up title area within opening of card holder. Then, sighting through viewfinder, line up camera with viewfinder area and lock in position.

To shoot titles without a titler, place centering guide on wall and, with camera mounted on tripod, line up camera with viewfinder area and lock in place. Title card is placed over "title area."

We're sorry about the mistake in the centering guide for the Keystone "8" which appeared in the last issue and the correct guide is being published this month.

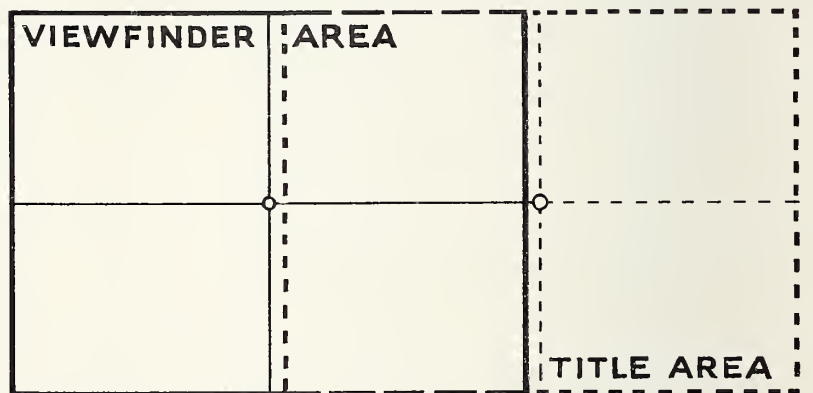

BOLEX 16 mm

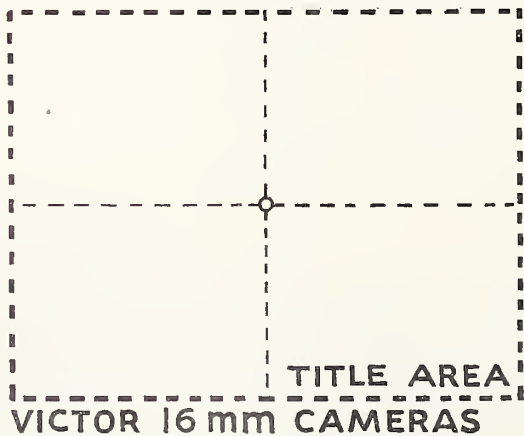
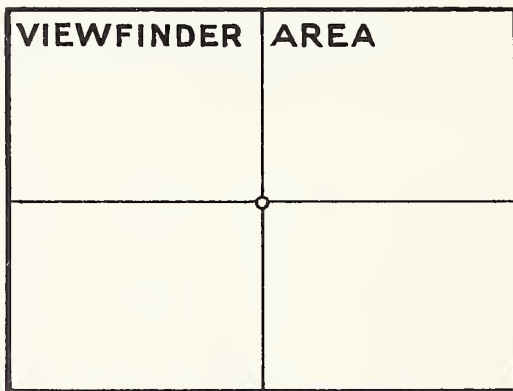

VICTOR 16 mm CAMERAS

NOTE: The guide below is printed as a correction of the centering guide for Keystone 8mm cameras which appeared in the September issue. Previously, the title and viewfinder areas were reversed.

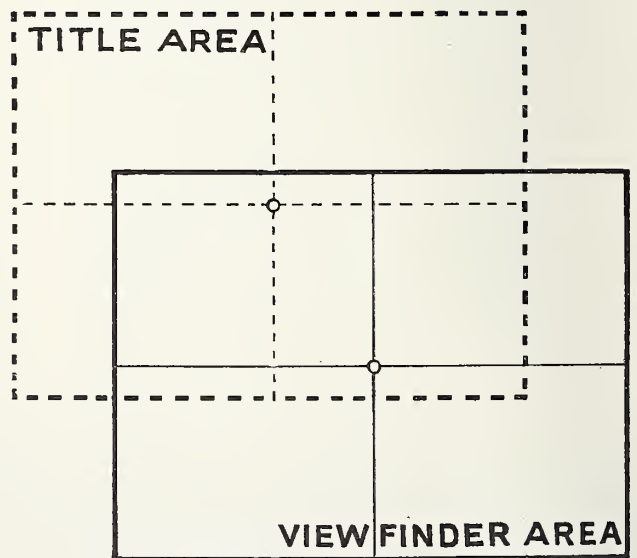

8 mm KEYSTONE-MODEL 8

Reviews by
THE EDITORS



TELL ME— how can I improve my film?

HAVE you submitted your latest film to HOME MOVIES for a detailed review and criticism? Why not take advantage of this helpful service to improve your movie making — your photography, editing, and titling? There is no charge whatever for this service. It is available to every amateur whether he is a subscriber to HOME MOVIES or not. All films are returned promptly with a written detailed criticism and with an animated one, two, three, or four star leader attached.

Amateur film reviews selected for publication this month are as follows:

"OPPORTUNITY, LTD."

700 ft. 16mm — By E. D. C.

★★★

Continuity: This picture was conceived as a means of propaganda to sell a community the idea of increasing its vocational school facilities for children.

The story involves two freshmen who travel throughout the various classrooms of the school intent upon enrollment only to find all classes overcrowded and closed to them. This serves as an opportunity to picture the various classes offered by the school, and the story is clearly and graphically told.

Highly interesting is the latter part of the picture which is devoted to the classes available to girls such as cooking, sewing, typing, and beauty culture. Each sequence is lavish with detail-revealing closeups that makes a movie interesting.

Editing: This phase of the picture is well handled. Scenes are cut to a satisfactory length — none of them too long, as is often the case with school-made movies where outside pressure is often brought to bear upon the producer by those desiring extra footage of themselves or their departments to be retained in the finished picture.

There was one spot that seemed to need a linking scene — the sequence where talks are being given by various students after a brief introduction by the class chairman. The second time the chairman introduces a student, he comes upon the platform too suddenly. A fadeout of the preceding scene would have helped here.

Photography: Exposure was consistently good throughout this picture in spite of the fact that outdoor Kodachrome was used on many of the in-

terior shots. These interiors incline toward the red. Scenes were framed well, change of camera angle was frequent, and there were plenty of close-ups.

Titling: The main title of this picture is highly commendable. Particularly effective was the use of big block letters, backlighted from the rear with a red light. The subtitles were printed, well centered and well exposed; but possibly more interesting is the fact that they were not shot on color film but toned for the desired color effect. The toning particularly enhanced the grained wood backgrounds.

"SNOW WHITE"

175 ft. 8mm — By A. W.

★★★

Continuity: This story is an adaptation to the now famous fairy tale of "Snow White and the Seven Dwarfs." This filmer worked out a fine continuity which proved a splendid amateur vehicle for children as actors. The picture opens with a family — a man, his wife, and two daughters in the garden of their home. The children, tiring of play, ask their mother to read a story to them. The story is that of "Snow White."

AS she reads there is a dissolve into the action of the story with all the parts played by children. It is a color picture and therefore much color was utilized in the costumes of the characters. As the story unfolds, there are flashbacks to the chapter titles in the story book which serve as titles for the picture.

Of course, there is no need to dwell upon the story, it is so well known. This filmer used excellent judgment in shooting most of his picture in closeups which subordinated the backgrounds. Where it

• Cont. on Page 505

• Top — Scene from "Below the Border," 16mm documentary film, and from "Snow White," an 8mm film. Below — scene from "Opportunity, Ltd.," 16mm documentary film. All pictures are enlargements from frames of original films.



THE EXPERIMENTAL

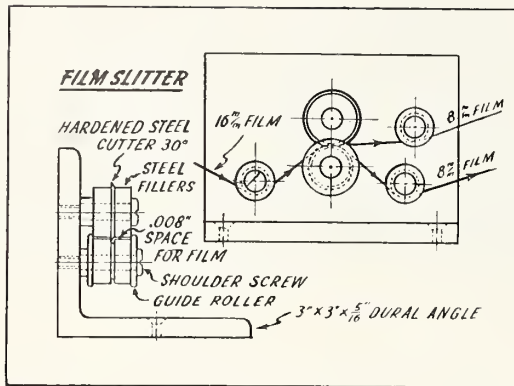

Film Slitter

I recently constructed a device for slitting double 8mm film into single 8mm widths, as per accompanying illustrations. On a 3x3x5/16-inch dural angle 4 inches long are mounted a 16mm guide roller "A"; a cutting roller with its guide roller "B"; and two 8mm guide rollers "C."

The hardened steel cutter is 3/4 inch in diameter with a bevel of 30 degrees and clamped between two steel filler rollers 5/8 inch in diameter. A 1/4-inch diameter screw holds the assembly in place. The cutter guide roller is also made of steel but does not have to be hardened. One edge of the groove is exactly in the center, while the other edge is 1/16 inch to the right. A space of .008 inch between the rollers "B" allows for the film.

—Arthur Zaugg.

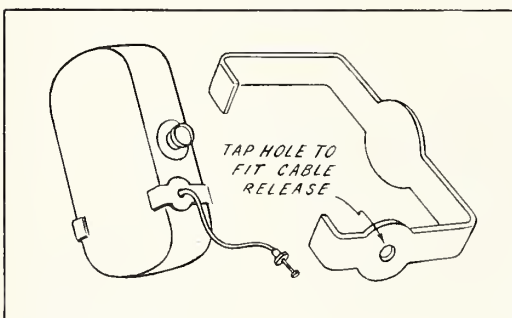

Camera Aids

Pictured here are two gadgets I have made for my Keystone 8mm camera. The first is a clip for holding cable release in accurate position for making

CINEBUGS!

• If you have an idea for a gadget, trick, or shortcut in filming, titling, editing or processing home movies, pass it on to your fellow Cinebugs through these columns. If your idea is published you will receive two reels for your efforts. Extraordinary ideas will net you a roll of film.

Ideas not published will be held for future publication unless they duplicate ideas previously received. Endeavor also to send along photos or rough sketcher illustrating your suggestions. There is no limit to number of suggestions you may submit.

Important: When submitting ideas, be sure to mention whether equipment you use is 8mm or 16mm, enabling us to promptly forward awards adaptable to your use.

single frame exposures. Clip slips into place and is held secure without necessity of screws or bolts. It may be turned from a strip of brass or steel. The irregular lines in the design only lend style to its appearance. If desired, a plain band of metal may be used.

The second gadget, or assembly of gadgets, is an aid in making fades through manipulation of the lens iris. An iris control handle is fashioned from aluminum or other metal and made to slip snugly over the iris control ring of

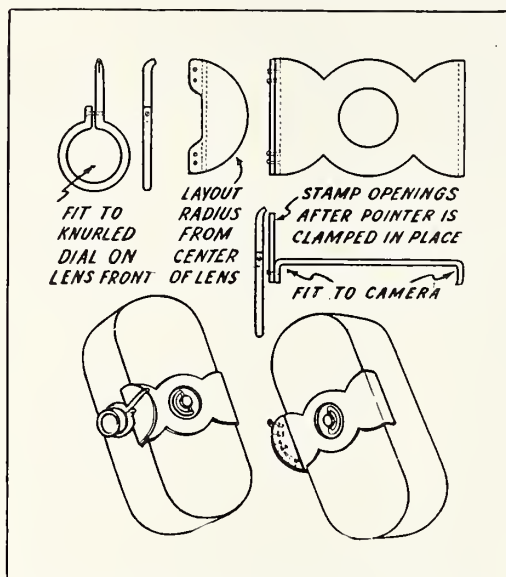

the lens. The tip of the handle is curved slightly to serve as an indicator which snaps into position on side of the camera as shown.

Thus it is possible to accurately open or close lens iris while standing behind the camera. Sketches show full details of construction.

—Herbert Valentine.

Lens Case

I made a gadget, as pictured here, for safely carrying my assortment of cine lenses. It consists of a piece of sugar pine, 2x4x4 inches. With an extension bit, three holes were bored, as shown, of a size and depth to accommodate my various lenses. Space was allowed for

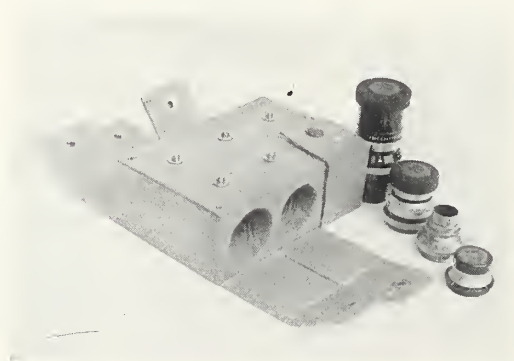

placing a sponge rubber cushion at the bottom of each lens chamber and for lining same with felt or velvet.

The block was then neatly covered with bookbinders' cloth. After drying, the portion covering the holes was slit "pie-cut" fashion with a razor blade and the triangles of cloth folded inside the holes. Pieces of heavy cardboard were then cut to fit all sides of the block. From a leather belt such as made for ladies' dresses and obtainable from the dime store, three strips were cut to form the flaps as shown. These were glued to the bottom and side cardboard pieces, then covered with bookbinders' cloth. Before cementing to the block, the top piece and the flaps were taken to a local glove repair shop, where the snaps and clasps were added at small cost. Afterward, the pieces were glued to the block.

—C. P. Norton.

8mm Reverse Action

In using my 8mm Kodak for upside-down filming to produce reverse action, I found it very annoying to have action and background reversed from side to side, as it did not tie in properly with straight filming of the same scene.

To again reverse the film image to its proper relation with the rest of my scenes, I made a simple gadget to fit on my camera, as follows:

First, I secured a small box from a jeweler, about 1 3/4 x 1 3/4 inches square and 4 inches long, with a sliding cover. (A suitable box may be made of heavy cardboard or plywood.) The 5-and-10 supplied a small plate glass mirror

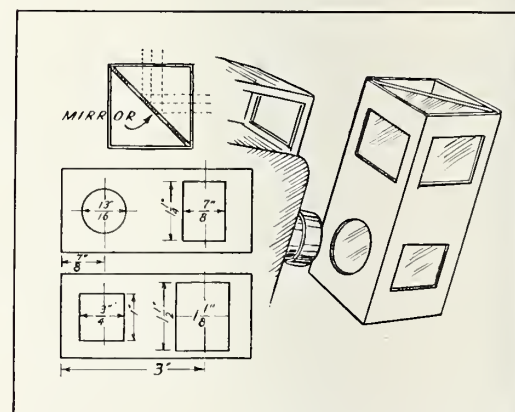

2 1/2 x 3 3/4 inches, such as are sold for hand bags. The mirror was mounted in the box lengthwise, at an angle of 45 degrees to the bottom, and held in place with china cement. In the cover of the box a hole was cut with a sharp knife, the center 7/8 inch from one end, 13/16 inch in diameter. Exactly 3 inches from the same end a hole 7/8 inch high by 1 1/4 inches wide was cut as shown by diagram. In the side opposite the mirror a hole 3/4 inch high by 1 inch wide, the center 7/8 inch from the end, and a hole 1 1/8 x 1 1/2 inches, the center 3 inches from the same end, are cut as shown. The entire inside of the box and lid was painted dull black and the cover glued

C I N E W O R K S H O P

on. The outside was also painted black to give it a finished appearance.

In use, the round hole in the lid is pushed over the lens barrel, with the square hole opposite the viewfinder. It will be necessary to stand with the camera pointed at an angle of 90 degrees to the scene filmed.

These dimensions are to fit the model 60 8mm Kodak. To make one of these gadgets for any other cine camera, it is only necessary to alter the size of the round hole to fit the lens in use. With cameras in which the viewfinder is not directly above the lens, it will be necessary to alter the dimensions of the box and mirror and change position of the holes.

—Edwin D. Taylor.

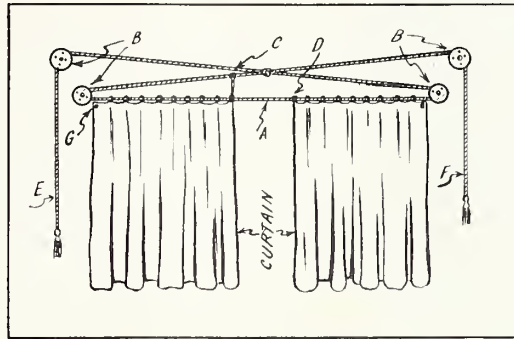

for automatically opening and closing curtains on home theater stages by remote control from the projection booth.

A combination guide and curtain line "A" is suspended taut between two pulleys "B" situated at either side of the stage. The curtain is suspended from this line by means of curtain rings threaded on to the line as shown. The upper right hand corner of the left curtain is fastened to a point on the top line as shown at "C" and the upper left hand corner of the right curtain is fastened to the lower line as shown at "D." This should be done while the curtains are fully drawn and overlapping slightly.

Thus when the guide line is moved by drawing on the left control line "E" the curtains are opened; and are closed by drawing on control line "F" at the right. Both control lines run along the walls through small eye screws to the projection booth. A wooden stop-block placed at "G" prevents the curtain rings from fouling the guide line pulleys.

—O. A. Nelson.

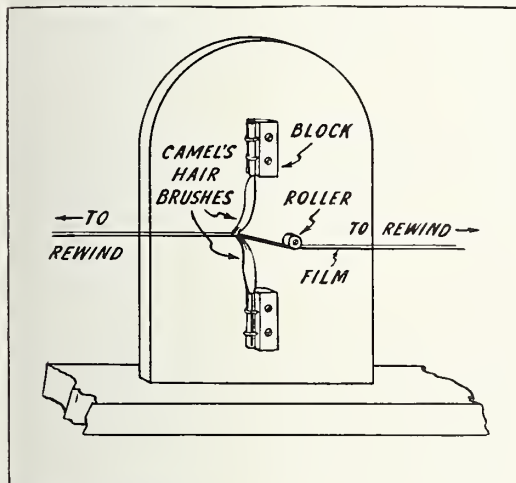

Film Cleaner

The accompanying sketch shows a film cleaner I recently made which does not involve use of cleaning fluids. Instead, two soft camel's hair brushes are employed to clean both sides of the film as it is being re-wound.

The two brushes are mounted on small blocks which are in turn mounted on a small wooden upright on the editing board, and this is done in such a manner that the brushes extend into one another about 1/8 inch.

A roller is mounted on the upright over or under which the film passes and which serves to guide the film between the brushes. This roller may be of wood or any smooth surfaced material that won't scratch the film—a wooden thread spool will do.

Suitable brushes may be obtained from any paint store or artist's material supply house. Incidentally, this idea may be applied directly to one's projector so that the film is brushed clean of lint and dust particles before entering the film gate, thus insuring "fuzz-free" frame lines during projection.

—Wm. Ziemer.

Stage Curtain Control

Illustrated is a simple arrangement

gadgets, tricks and short cuts contributed by Cinebugs

illustration. Proceed in similar manner to mark meter for other f/ stops of camera lens. Thus, when meter is pointed at object or scene to be photographed, the meter hand will point directly to the f/ stop, making compensation or further adjustment unnecessary.

The piece of cardboard may be cemented to the glass with rubber cement, thus making it easily removable when meter is to be used with a still camera.

—A. W. Bartel II.

Pola Screen Guide

To insure that the same effect as seen through a Pola Screen or polarizing filter will be recorded on the film when taking the picture, the Pola Screen must be attached to the lens in exactly the same position as when held in the hand during observation and adjustment. Any deviation, axially, while attaching same to the lens may cause the expected effect to be altered or even lost in the picture. A simple device for gauging the position of the Pola Screen may easily be made and often without spending a penny. It is adaptable to both movie and still cameras.

Take a white or light-colored cardboard and cut out a 3-inch square. Draw a circle in the center, slightly bigger than the diameter of the Pola Screen; then draw another circle around it, leaving about 1/4 inch space between the two circles. Divide same in eight even parts and mark the numbers 1 to 8, as shown in Fig. 1. Repeat this on reverse side of the cardboard, but number counterclockwise so that No. 1 and No. 5 will appear on both sides at the same position (see Fig. 2). Now cut out the center piece (small circle) and the gauge is ready for use. If the Pola Screen has no indicator handle, you will have to mark a line on the outside of its mount. Place the screen

• Continued on Page 508

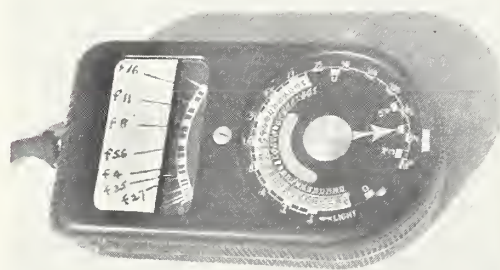

Meter Dial

Here is a suggestion for augmenting those electric exposure meters designed for still photography so that they will give, directly, the f/ values for cine photography. From a piece of white cardboard cut a piece that will fit snugly over about one-half the area of the glass covering meter dial. Set the calculator to the Weston speed of the film most frequently used and, starting with the highest f/ value on the lens of your camera, set same to correspond with the shutter speed. Read off the candlepower as indicated by the meter hand and place a mark on the cardboard as shown in

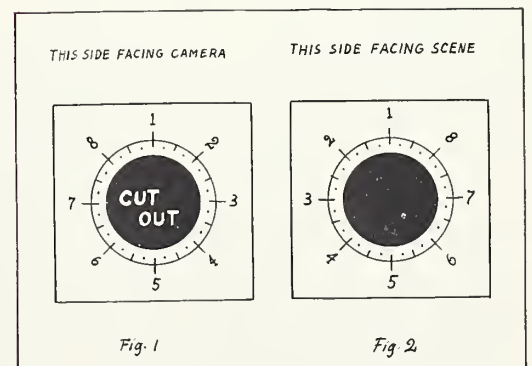

Fig. 1

Fig. 2

By
BILL A. JONES



SCHOOLS can successfully produce teaching films . . .

Dover High School's initial effort highly acclaimed . . .

THE resources of two school organizations were combined when the Board of Highway Education, a division of the Ohio State Highway department, collaborated with the Bureau of Educational Research of Ohio State University in an experiment to determine if schools can successfully produce their own educational films.

Dover High School was chosen as one of nine schools—eight in Ohio and one in West Virginia—to produce a motion picture on some safety subject. Funds were provided by the Highway Education Board.

"Jack Finds a Way" was the title chosen for the Dover High School film, which had bicycle safety for its theme because of the great number of bicycle riders in Dover. The picture was directed by Clyde Miller, with Frank Harmon directing the crew of student photographers.

HIGH school literature classes were put to work developing a script for the film. Meanwhile a special day was set aside for each class in the school to make a list of common mistakes made by bicycle riders.

These were turned over to the script writers to be included in the story—and it was these mistakes which provided much of the material, makes the film interesting, and provided a little fun for the photographers.

While the script was sent to Columbus for approval by state officials, actors

were "signed," property crews were organized, arrangements for locations and properties were made, and when the script had been okayed and returned, shooting was ready to begin.

Story of the film is roughly as follows: Jack, a high school student, is a careless bicycle rider. During the first part of the film his actions show plainly the way *not* to ride a bicycle. Then, while riding his brother on the handle bars he strikes an automobile, and the two are sent to the hospital. While in the hospital Jack gives a great deal of thought to his misfortune, and decides to exercise more care in the future. Soon after his recovery, he contacts the mayor and asks permission to establish a bicycle safety clinic where police officers may give instructions to boys and girls on the correct way to handle bicycles, and to inspect and repair damaged bikes. The final scene is a fade-out of Jack being congratulated by the mayor and the chief of police after he has shown them what can be done by an organized safety movement.

As you see, the story provided plenty of meaty material for the cameraman.

ONE of the most thrilling shots in the film is the automobile-bicycle wreck, which was treated with the time-honored Hollywood technique of illusive and deceptive cutting.

A long shot shows the boys on the bicycle approaching an intersection opposite the camera, weaving in the street and waving at some girls on the sidewalk. Then a small truck approaches from the right and turns into the street in which the boys are riding. As the car turns into the street, the bicycle moves toward it while the boys look in the opposite direction at the girls.

Then a cut to a shot made through the windshield of the truck and over the

• Continued on Page 504



• Top photo—One of Dover's student photographers operates the camera in filming "Jack Finds a Way." Below—Shooting an interior; marking the "slate" to identify each scene; and production staff and crew at extras an location for a "chase" scene.

By WM. J. INSKEEP

• Mrs. Almo Rogers, visual education expert, who aided in development of St. Louis County cooperative system, and has since become head of it.



IN AN analysis of administrative methods and units in visual education systems, all three of the normal political subdivisions, the state, county, and city, are important and logical units. In states having a state board of education controlled and supported system, the county recedes in importance, since city systems can depend upon and look directly to the state system. However, only a handful of the forty-eight states have or are immediately likely to have fully developed, state-financed systems with comprehen-

the rural schools as well, with 100 per cent participation being not far off.

In 1932, visual education began to loom large in the minds of several progressive district superintendents in St. Louis County, who had the opportunity of seeing the accomplishments in the wealthy St. Louis city system next door. The superintendent of one district had even gone so far as to buy a number of films, only to find himself stymied even in use of them in the schools in his own district, due to lack of a distribution

COOPERATIVE *visual system succeeds . . .*

sive state distribution, and consequently a well-organized county system is a most important unit, bridging the gap for thousands of towns which are not individually large or wealthy enough to generate a first-class system independently. Even in states whose state universities support and operate a system of distribution of visual aids for participation by all schools within the state, a county system is almost essential for the local distribution and control.

The visual education department of the St. Louis County schools, in St. Louis County, Missouri, is exemplary of the well-developed, self-sustaining type of county system which brings facilities to a group of small school districts almost on a par with those of a major metropolis, without the substantial investment or endowment usually involved in metropolitan systems. The St. Louis County school system functions entirely separately from the city of St. Louis, the city being legally a county itself, and not in or of St. Louis County. In St. Louis County are some twenty-one school districts, made up of townships ranging in size from such populous districts as Normandy, University City, and Webster Groves down to tiny districts equivalent in student population to a cross-roads hamlet; in addition there is the usual quota of rural schools. So well developed is the St. Louis County system that eighteen of the county's districts participate in its full service, and several of

system. Several other superintendents similarly minded were called into conference, and Mrs. Alma Rogers, visual education expert from Indianapolis, entered the picture as a nucleus and organizer. It was determined that by installing an efficient county system, all the school districts, from largest to smallest, could participate in facilities far beyond the individual district's reach, and the Visual Education Department of the St. Louis County schools was created as a cooperative organization, administered and supported by the various district superintendents as a group, with one of

them acting as treasurer and bursar, Miss Rogers as director, and the balance as advisers and nominal board of governors.

RATHER than throw the new department into the political ring to become subject to political patronage and abuse, the group did not at once seek official funds to support it, but arrived at a base cost for participation by each individual district, this cost to be paid by each su-

• Continued on Page 503

• The system boasts one of the most efficient departments for inspection and distribution of school films in the country. Teaching films number approximately 1000 and others are made quickly available from outside sources.

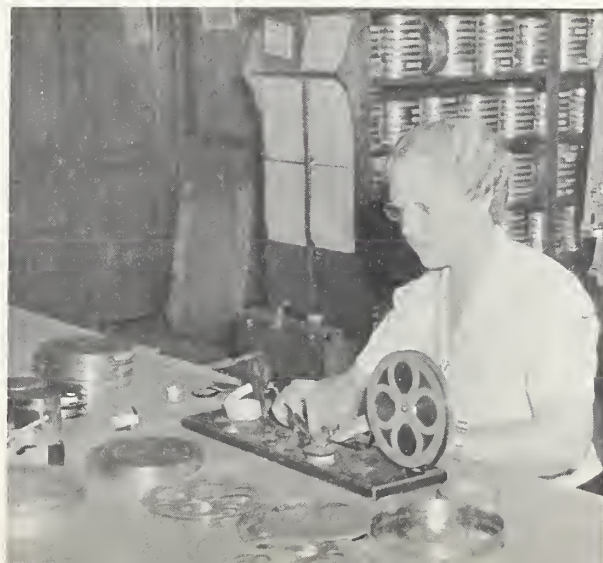

EDUCATIONAL FILM TREATMENTS



Bermuda

By ELDRED J. WILSON

Highland Park School System, Chicago, Ill.

Previewing pictures by the teacher is, of course, nearly always a necessity, and it is even more important in geographical and travel pictures, since the subject is so broad, the students should be directed, to some extent, in their observation and concentration. During this preview, the teacher should select pertinent points which are particularly well illustrated by the film, and make notes of them. Then, before the picture is shown, a few leading questions should be asked and discussed, simply to put their minds on the alert for these points in the film. In the film, "Bermuda," such points brought up were: What kind of climate has Bermuda? What kind of houses do they live in? Of what materials are their roads built? What means of transportation do they use? Under whose government is Bermuda?

After the children see the picture, the teacher begins the discussion by re-asking these questions. It depends on the grade, of course, as to how deeply the discussion probes the film. Then, the class should be asked to make up a set of questions which it thinks would be interesting. From these lists, a group of representative questions can be compiled for the final discussion. In an 8th grade class this was the final list of questions: 1. Where is Bermuda? 2. To what coun-

try does it belong? 3. How far it is from the United States? 4. What means of transportation is prohibited there? What means is used the most? 5. Can you think of any reasons for this? 6. Why are there so many tourists in Bermuda? 7. What are the chief products? 8. What do you know about sea horses? How is Bermuda governed?

This is plainly a very thorough follow-up to have been conceived by the children themselves, and it probably would not have been so complete if it had not been for the "lead-up," which I believe is as important as the follow-up.

Pygmies of Africa Watussi of Africa

By H. G. HILTON

Oklahoma City Public Schools

These two pictures may well be shown at the same session or close together, for they present a valuable contrast in the two extremes of native Africans. They are also a good preface to the unit on Africa in the social studies, and should be timed accordingly. The present war

makes Africa more than of passing interest. "The Pygmies of Africa" presents the detailed study of the relatively primitive types, their way of life, how they hunt, eat, and worship. "The Watussi" presents a study of a ruling family of the Rwanda region, their state of culture, works of art, and music.

The pictures, of course, were previewed. As usual, the social studies department took the major emphasis. The art department stressed the handicrafts of the people, their basket-making, dyeing, making of bark fabric. The home-making department cited the Watussi film to study the food habits, clothing, home furnishings of civilized people who have a primitive background.

The pupils were prepared for the pictures by a study of the map of Africa, where the different types of people are located, something of the history and political background of the people and the country, discussion of the white peoples' part in the development of the country. Material for geography texts for supplementary work is profuse.

Among the study subjects developed from the films were: "Why do primitive peoples differ so much in their cultures?" "What effect has Western civilization had on the dark continent?" "How do their religions affect their life and culture?"

In the applied sciences, several students made fairly faithful replicas of the baskets illustrated, and the speaking classes worked on the ceremonials of the two peoples.

Electrodynamics

By G. B. RANDOLPH

West End High School, Birmingham, Ala.

Timing is important in scheduling science films, since any film embodying principles or ideas not previously clarified in other study will tend to create confusion in the students' minds. Accordingly, this film should be ordered for showing when the study of static electricity has been finished, but before the study of current electricity has been started.

The film is shown to the class after verbal instructions as to which points the instructor considers the most important, so that they will remember to concentrate especially on these points. The particular points emphasized in this film were the contributions of Galvani, Volta, Oersted, and Faraday. Emphasis is placed on the fact that the discoveries of these men were made in the order named and that each discovery was a dependent one. This is important in building up the subject of electricity as one in which all

facts and principles are logical in development and depend on one another.

After the film has been shown, a ten-minute quiet period was allowed for the students to make notes from their memory of the film, no questions being asked during this period. Following this a period is allowed for questions to be asked and discussed. Then a committee of three or four students was appointed to write up a brief resume of the film and its important points, and this report was duplicated and a copy given to each member of the class.

Another phase of the timing of the film is that it should be shown immediately prior to a laboratory period wherein the discoveries of Volta (a simple cell made from two strips of metal and a weak acid solution), Oersted (the deflection of the compass by an electric current), and Faraday (the induction of electricity in a wire moving in a magnetic field) are demonstrated in the laboratory.

Following the laboratory period, and a simple quiz is in order, a certain portion of the quiz should be based on the film and points brought out in it. Findings have been that points and principles supported by the film were retained better and explained in the quizzes better than other points not covered in the film.

Safety

By MISS MAISY DAVIDSON GLENN

Hemphill Elementary School, Birmingham, Ala.

THIS is a very important lesson film which should be adapted to the primary grades to begin the lesson of safety early, yet it requires considerable effort to drive home all the points to the very young minds. Bringing out the points in the simplest ways and illustrating them as graphically as possible is the best way to impress the juvenile mind.

In this instance, the services of Gordon Parsons, the city safety expert, were secured. Mr. Parsons appeared dressed in a policeman's uniform, and explained that the film was very important, as it would help keep some children from being killed. The children were consequently all set and ready to absorb the message. After the film was shown, a lively discussion was held in which accidents similar to the ones shown in the film were recalled, certain "policemen friends" were remembered and named. Following the discussion period, the children were required to make their own stories for a reading chart about the

things the officer had told them and what they saw in the picture. The stories were told orally, based on a story outline as follows:

We went to the auditorium.

We saw the policeman.

He wore a blue uniform.

He is our friend.

We saw a picture show.

It was a picture about safety.

The policeman told us the A B C of safety.

It is, "Always Be Careful."

Consistent with the system of continuing the visual carrying out of the ideas, the children were then required to draw illustrations from the picture. Some drew the policeman, some drew the Mother Goose characters in the film, and some drew children crossing the street. The popularity of the Mother Goose characters was used still further to cement the ideas, by allowing the children to get books from the library containing the characters, and devoting some time to games involving the characters, wherein all the characters were extremely careful.

That the message "stuck" is evidenced by a typical story outline produced by one of the children several days later:

We saw some boys in the picture show.

We saw some girls, too.

The boys and girls were riding bicycles.

They were very careful.

They did not go too fast.

They watched the traffic light.

The red light means "stop"; the yellow light means "wait"; the green light means "go."

Mexico, Our Neighbor

By GENE GREENLAP

Riverview School System, St. Louis, Mo.

IT is our conviction that visual education can have any of several legitimate functions, such as stimulation, review, additional information, helping to visualize and retail material already studied. Before employing a film, we believe it important to determine which of these functions the film should perform, and to shape our preparation to that end. In this shaping, every possible aid and adjunct to the subject should be brought into play, to extend the students' thinking beyond just the phases covered in the film.

With the film, "Mexico," we felt that its purposes should be to help the student visualize and assimilate facts already studied, since every child knows something of Mexico already from current history, geography, and similar sources. Accordingly, here is our breakdown procedure: contributions and preparations consisted of an emphasis on Mexico in geography classes, studying locations, cities, climate, resources, products, characteristics, habits, and people—how they live and how they utilize the tourist trade. Procedure included the use of regular text books and books secured from the library, pictures, maps, and travel posters, illustrating the oil fields, a typical Mexican family, and Mexico's

resources, as well as the native forms of dress. All the books on Mexico in the library were placed on a special shelf, and a Mexican scene was arranged on a table from objects borrowed from the Children's Museum, including pottery, dolls illustrating the native dress, and a diorama of a typical Mexican dwelling. The children were allowed to study these before the film was shown, and again after it was shown.

The film was previewed, and notes made of important subjects, including nature of country, type of family and home, habits and daily life, schools, churches, architecture, pastoral life, parks, public buildings and roads. These were briefly discussed before the film was shown.

Following the film, a quiz was given, covering the following questions:

1. What did you see that agrees with what you have previously learned?

2. What growing plants did you recognize?

3. Can you guess the climate from the picture?

4. Could you describe the people and their nature from the picture?

5. What can you tell about Mexico's dependence? Its arts and crafts? Its agriculture? Livestock? Dances? Music?

New Releases

AMONG the new film releases which have been reviewed by educators as possible visual aid material are the following patriotic subjects released by Ideal Pictures Corporation, Los Angeles and Chicago: "The Star-Spangled Banner," "Wake Up, America!," "The American Way," "Lincoln," "The U. S. Marches On," and "Our Constitution."

Among the vocational guidance films available from the same source are: "Finding Your Life's Work," "Radio and Television," "Journalism," "Woodworker," and "Automotive Service."

Castle Films' latest release, "Gay Nineties Live Again," is reported to be a very informative picture worthy of inclusion in the libraries of all teaching institutions. The picture includes early day scenes of Teddy Roosevelt and his Rough Riders; the horse car transportation system of New York City, etc.

"IT'S NEW TO ME"

By CINEBUG SHOPPER



Castle Films

"The Gay Nineties Live Again" is the title of one of the most interesting films just released by Castle Films. It is a valuable record of some highly historical as well as amusing events of early days.

Other Castle releases for October include a brand new type of animated cartoon, "Boy Meets Dog," from the studios of Walter Lantz; "Fun in Florida," replete with activities filmed in the haunts of wintering tourists in this attractive state; and "Palestine," a film which pays tribute to historical spots hallowed by three faiths, and records the great progress made in recent developments in this famed land.

All four releases are said to be available now from leading photographic dealers.

Film Cleaner

On the basis that a clean film lasts twice as long and does not scratch as readily, the Fisher Mfg. Co., Rochester, N. Y., are making rapid progress in the increased sale of the Fisher Film Cleaner. Developed by a man with thirty years of projection experience to his credit, the Fisher Film Cleaner has been found ideal for amateur use. It may be mounted on table or editing board to permit cleaning of films during rewinding and inspection.

Several schools are said to have adopted Fisher Film Cleaners exclusively for their visual education departments.

Titleer

A new attachment is announced this month for use with the Cinemaster Titleer. Said to be the first of its kind made available for small type-writer titlers, it enables users to make scroll, flop-over, and wipe-off titles and other professional-like effects in home movie titles. Also announced is Title Accessory Kit No. 1, which includes an 8" auxiliary lens, 25 title background cards, a translucent screen for rear projection, and two panels of clear celluloid for filming superimposed titles. Complete data on these new offerings may be had by writing Hollywood Cine Products Co., Los Angeles.

Recording Unit

Presto Recording Co., New York City, announces the new Synchronsound, a system of mechanical links which enables any amateur to record synchronized sound on a disc record while filming. Likewise, it is possible to produce a fully synchronized recording of commentary and background music for films already made.

The Synchronsound System provides synchronization be-

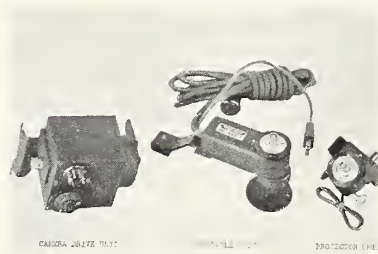

tween disc and film by means of two six-segment commutators with revolving brushes. Master commutator mounts on the turntable shaft, making the brush revolve at standard phonograph speed. When filming a picture, this turntable commutator is connected by means of an electrical cable to an electric camera drive unit consisting of a similar commutator, a small electric motor, and a shaft which engages with the film moving mechanism of the camera. Power is fed to the camera motor through the two commutators.

For projection of film and playing of synchronized recording, the turntable and projector are joined by a similar hookup of commutators. Instant and accurate starting of both film and disc is assured, and the screened results are said to equal those of sound on film productions.

A free booklet giving further data and instructions is available by writing the manufacturer at 242 West 55th Street, New York City.

Sprocket Guard

Of interest to 16mm movie makers is Bell & Howell's recent development, "Safe-Lock" sprocket guards which are now

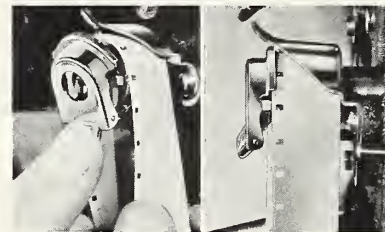

being built into all Filmo projectors, silent as well as sound.

Bell & Howell claims it is now impossible to thread a Filmo "Master" projector in any way but the correct way. This new improvement insures that the film is either correctly seated on the sprocket with perforations over the sprocket teeth, or it is held fully clear of the sprocket teeth, preventing damage to the film. An added feature is that the extending guard prevents damaged film or film with faulty splices from jumping the sprocket.

Cine Gadgets

Hollywood Cine Gadgets of Hollywood announce a new line of adapter lenses which may be used to augment the regular cine camera lens and convert same into a telephoto. They are applicable to either 8mm or 16mm lenses. Said to be reasonably priced and accurately machined, the adapters do not require any mechanical changes in either camera or lens and are instantly interchangeable, according to the manufacturer.

Amfiles

Amberg File & Index Co., Kankakee, Ill., has introduced on the market an interesting multi-compartment file for storing 8mm films. The file, having the appearance of three bound books, is intended to be kept on library desk or bookshelf and provides for holding eight 200-foot reels of 8mm film in humid cans.

Each Amfile is neatly bound in colorful leatherette and finished with gold labels captioned "Motion Pictures." Inside the cover is a ruled index providing for listing titles and description of films.

Visual Releases

Walter Gutlohn, Inc., a New York firm specializing in visual education film subjects, is said to have acquired exclusive distribution of the single-reel musical subjects now being produced in Hollywood by Artists Films. These films will feature such renowned personages as Richard Bonelli, Helen Jepson, Jose Iturbi, and negotiations are said to be under way for many others.

Rangefinder

Goodspeed, Inc., 220 Fifth Avenue, New York City, manufacturer of the famous Goodspeed flash synchronizer, announces a new type of coupled range finder called the "Cinemaster" for most 16mm amateur motion picture cameras.

The "Cinemaster" coupled

• Continued on Page 495

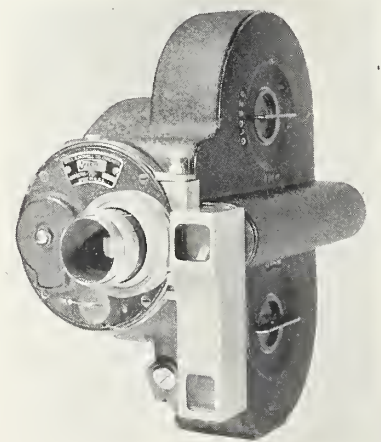

A Revelation in 8mm. Projection



Full 16mm. Quality now available in this new AMPRO 8mm. Projector

Yes, every feature that good 8mm films deserve—brilliance of illumination, reverse pictures, ease of operation, gentle treatment of precious film, in short, a smooth satisfying performance is now available through the new Ampro 8mm projector.

For years 8mm fans have said, "Give us a projector that does not penalize us for the economy of 8mm film." In this new model—Ampro now makes it possible to show 8mm film under ideal conditions.

Many Special Features Provide Smooth Satisfying 8mm Projection . . .

Still Picture Lever . . . Automatic Safety Shutter . . . Reverse Picture Operation . . . Fast Automatic Rewind . . . Full 400 foot reel capacity if desired . . . 500 Watt Illumination . . . Flickerless Pictures at Slow Speed . . . Efficient Cooling for Forward or Reverse Projection . . . Cool Air Intake Across Aperture Insures Longest Film Life . . . Automatic Reel-Locking Device . . . Micrometric Tilting Knob . . . Automatic Pilot Light . . . Centralized Controls . . . Complete Range of Film Speeds . . . Easy Threading . . . Quiet Operation . . . Has 1" F1.6 Objective Lens . . . Optical System Corrected for Color Films . . . Operates on both AC or DC 100-125 Volts.

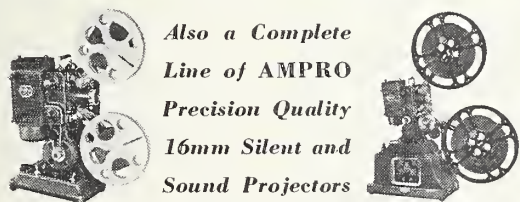

Also a Complete Line of AMPRO Precision Quality 16mm Silent and Sound Projectors

Ampro projectors both silent and sound are standard equipment in many thousands of schools, universities, government departments, U. S. Army and Navy, churches, clubs and homes. These precision projectors incorporate numerous features that insure brilliant, high quality silent and sound projection.

Ampro

PRECISION CINE EQUIPMENT

Ampro Corp., 2839 N. Western Ave., Chicago, Ill.

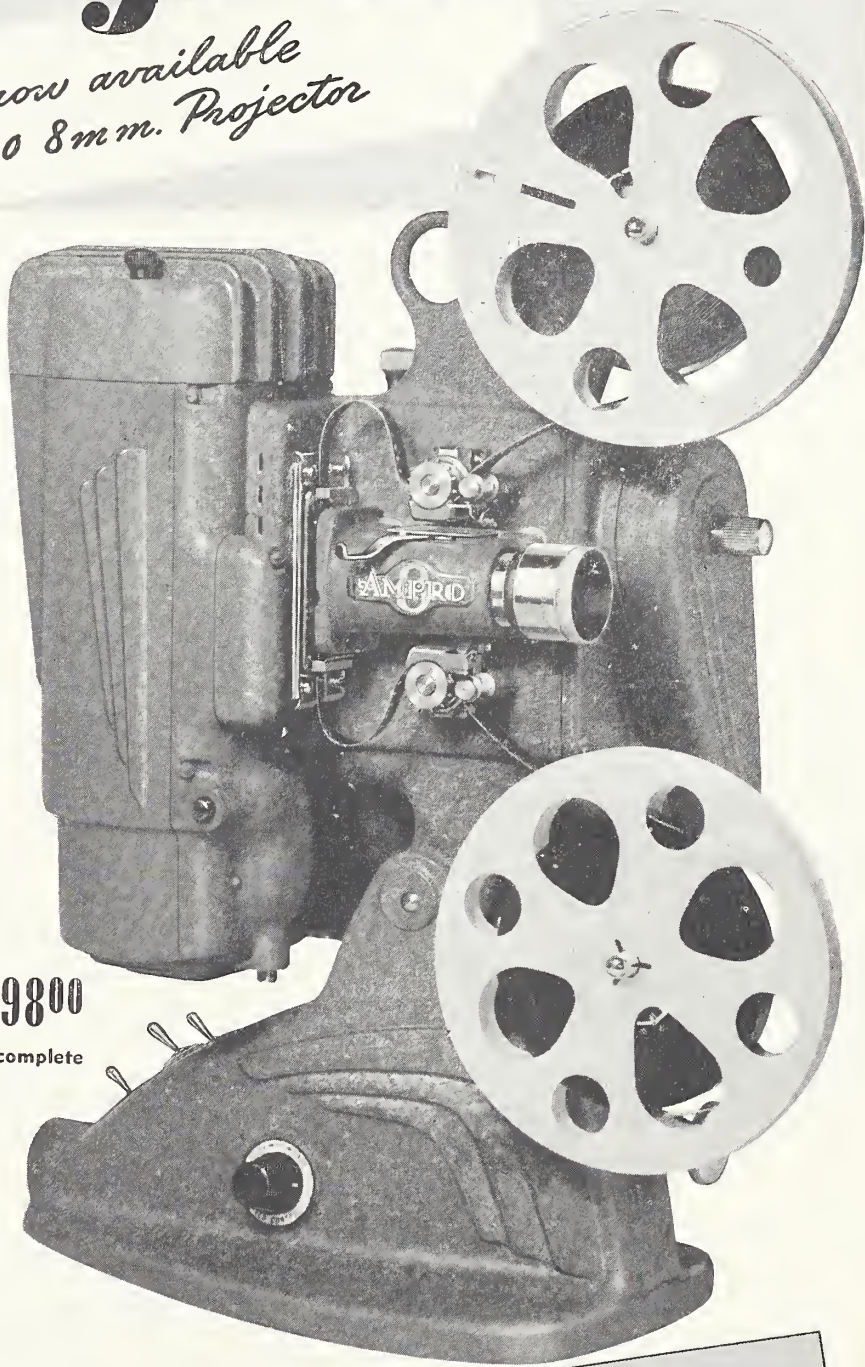

\$9800
complete

SEND FOR CATALOG
The latest Ampro Catalog will give you full details on this remarkable new 8 mm. projector and the full story on the complete line of Ampro "precision" 16 mm. silent and sound projectors.

Ampro Corporation, 2839 N. Western Ave., Chicago, Ill.
Please send me full details on the new 8mm Ampro Projector.
Also the complete Ampro 1940 Catalog of 8 and 16mm Projectors.

Name _____
Address _____ State _____
City _____

DEALERS:
Write for information on the Ampro franchise!

GOERZ KINO-HYPAR LENSES

f:2.7 and f:3

For regular and color movies of surprising quality—high chromatic correction . . .

Focal lengths 15mm to 100mm — can be fitted in suitable focusing mounts to Amateur and Professional Movie Cameras.



GOERZ Reflex FOCUSER

— Patented —

For 16mm Movie Cameras — voids PARALLAX between finder and lens — provides full-size ground-glass image magnified 10 times. Adaptable to lenses 3" and up. Also useful as extension tube for shorter focus lenses for close-ups. Extensively used in shooting surgical operations, small animal life, etc.



GOERZ Parallax-Free FOCUSER and FIELD FINDER CONTROL

No more off-center pictures, for Filmo 121 and Simplex-Pockette magnifies 4 and 8x.

For Detailed Information Address Dept. HM-10

C. P. Goerz American Optical Co.
317 East 34th St., New York

American Lens Makers Since 1899

NEW ULTRA HIGH SPEED SOLAR FILM

"ULTRA HI-SPEED"

America's fastest movie film! Weston 150, Daylight Mazda 110. Wide latitude, fine grain. Non-halation coating. Even most modest equipment produces unbelievable results using film of this tremendous speed. You get night pictures, theatricals, indoor movies heretofore beyond reach of the amateur! Costs little more than ordinary speed film.



Dbl. 8 25 ft. \$2.25 16mm 100 ft. \$6.00 16mm 50 ft. \$3.50

Processing and Return Postage Included

A SOLAR FILM for EVERY PURSE and PICTURE No matter what kind of pictures you want to get . . . no matter what your film budget dictates . . . you get FULL VALUE for your film money in SOLAR FILM. Look at these Low Prices.

	Weston Dbl. 8 Rating 25 ft.	16mm 100 ft.	16mm 50 ft.
ECONOMY OUTDOOR (Semi-ortho) 8		\$2.50	\$1.75
SUPER OUTDOOR Ortho, non-halation . . . 12	\$1.39	\$2.95	\$1.95
SOLAR HI-SPEED Fine Grain Pan 24	\$2.00	\$5.50	\$3.25

• COAST TO COAST PROCESSING SERVICE . . . included in all above prices. Solar processing stations now located in Kansas City, Chicago, Miami, and Arlington, Calif., less than 24 hours from 90% of all movie camera fans. You SAVE MONEY on SOLAR FILM and get FAST SERVICE, too! Sold by over 100 dealers in 201 towns and cities. If your dealer hasn't SOLAR film, ask him to get it for you, or order direct from this ad.

SOLAR CINE' PRODUCTS, INC.
3827 Archer Ave. Dept. 1A Chicago, Ill.

The Winner tells all..!

• Continued from Page 471

or 8 times for two-frame exposure per movement, etc.

I decided to make tests before proceeding with actual shooting of the animation sequences. Selecting one of the first scenes in the animated sequence, the mannikin was set up and his arms and legs placed in "starting" position. Just before starting the camera, it was decided this would also be an ideal opportunity to test various lighting set-ups, especially as the picture was to be filmed in Kodachrome; so several lighting units were arranged, and then the camera work begun. A simple sketch was made, for future reference, of the position of "Dodo," of the lights and of the position of each in relation to the camera. Then a note was made of the exposure.

The mannikin was to raise his arm from his side and stretch it out before him. I had Etchells go through this action with his arms, and it was found to take approximately half a second. Thus, on the basis of three frames per movement, the complete action would consume nine frames of film.

With the test shot of this gesture safely recorded, we proceeded with making tests of the succeeding action on the same principle—always rehearsing the movement ourselves in order to calculate the elapsed time required for a human to execute the same movement.

Because more than one member of the mannikin would often be required to move—that is, both legs, or an arm and a leg, etc.—things began to get a little complicated. Care had to be taken to keep the mannikin properly placed and to make certain that only those parts of the body needed to denote action were moved each time. Ultimately this possibility of error was overcome by making a simple diagram of the figure with notations of the movement. It was found that translating the movements into time was simple enough. Of greater importance was to keep clearly in mind at all times

the essential action which the mannikin was to execute.

With the first test shots completed, the lens was opened one stop and the entire action was again recorded at the new exposure, and this time at two frames per movement. This, of course, entailed more movements.

Then we made a third series of tests—this time with the lens closed down one stop from the original exposure, and exposing one frame per movement. The tests were then sent off to the laboratory.

When the processed film was returned we found that one frame exposure per movement was just right for smooth, normal action; that two frames per movement was pretty smooth, too, and just the exposure to use when it was wished to express a more leisurely tempo of action. Three frames per movement was unsatisfactory for smooth action. So, for fast action, it was concluded to shoot one frame per movement and halve the movements. In other words, if a normal gesture would require eight movements, it becomes a quick gesture when filmed in four. The test film also indicated the correct exposures for the animated sequences.

Armed with this essential data, production of the picture moved along smoothly until we were confronted with the problem of filming the mannikin actually executing the illustrations. Obviously to film actual productions of the drawings would involve a great deal of detail and seriously slow down the picture, besides presenting almost insurmountable technical difficulties. But after all the script called for the mannikin to make the drawings!

This problem was taken care of through well planned camera angles. By shooting a sequence of closeup shots of the mannikin wielding the paint brush made it unnecessary to show what was being placed upon the draw-

ing board. Varying the camera angles frequently sustained interest, and this was further heightened by an occasional ultra closeup of the tip of the paint brush dipping into the colors, mixing on the palette, or being washed in the glass of water nearby. All of this revealed what the mannikin was doing without showing the actual result. This, indeed, was a happy solution, since it introduced just the needed element of suspense for the picture. Just what is being painted is not revealed until close to the end of the picture when the illustration is shown just as it is viewed by the eyes of "Dodo's" master.

At another point, "Dodo" is called upon to execute a triple flip in the air. This bit of action was obtained by setting the camera so as to shoot straight down vertically to the floor, then laying "Dodo" on his side upon a black cloth and with a lining board (painted the same color as the bridge table upon which all the previous action took place) under his feet and parallel with the lower edge of our field.

When projected, this action had the effect of a shot filmed straight on of the mannikin standing on the table with just the edge of the table showing. "Dodo" was simply turned while lying on his side, to effect the motion of a triple flop.

With "Dodo's" good Samaritan act about finished in the early hours of the morning, it was decided to emphasize the time-of-day feature in these shots by accenting the lighting. During the previous shots, the mannikin had been lighted with a photoflood covered with blue cellophane to give the illusion of moonlight. Now, with dawn breaking, we would want the light to gradually change as the sun rose. So to the edge of the sheet of blue cellophane, a sheet of violet cellophane was pasted, and then a strip of deep crimson; orange; and finally bright yellow.

Starting the shot with the blue color, the multi-colored strip of cellophane was moved across the central lighting unit, giving just the right effect.

In choosing the lighting scheme for the earlier shots it was decided to effect an

illusion of "Dodo" working in the moonlight. A sheet of blue cellophane over a No. 2 photoflood in a reflector gave just the desired effect of a moonbeam striking the mannikin. Additional high-lighting was supplied by a spotlight, moved occasionally to accentuate action or expression. Effect achieved was that of the mannikin working on a table near a window and illuminated by moonlight and highlighted by a lamp within the room.

What was the most important thing learned in filming this picture? Timing—especially in timing the pauses between movement. In filming animated movement one should not forget to allow for pauses between action, or where a character comes completely to rest. This is important because it duplicates the natural action of humans. It will be found that, at times, it is advisable to shoot as much as 16 frames (1 second) of non-movement to indicate a pause in movement that is parallel to that of human action.

And I learned another thing, too—that it takes imagination, yes, and no little patience, to make animated movies. But I like it. And now that "Angels Are Made of Wood" has proven such a success, I'm going ahead with plans for another animated home movie.

It's New to Me!

• Continued from Page 492

range finder is based on a new principle that provides not only a clear and brilliant focusing field but one that can be used under dim lighting conditions. At present designed only for f1.5 lenses of normal focal length, it is attached and detached at will by the owner. No holes have to be drilled in the camera casing, nor is any filing required. It is not necessary to send the equipment to the factory. As cameras vary in style and shape, several different models of the "Cinemaster" are available to exactly suit the requirements of the most popular models, including Bolex, Cine Kodak, Victor, Bell & Howell, Keystone, etc.

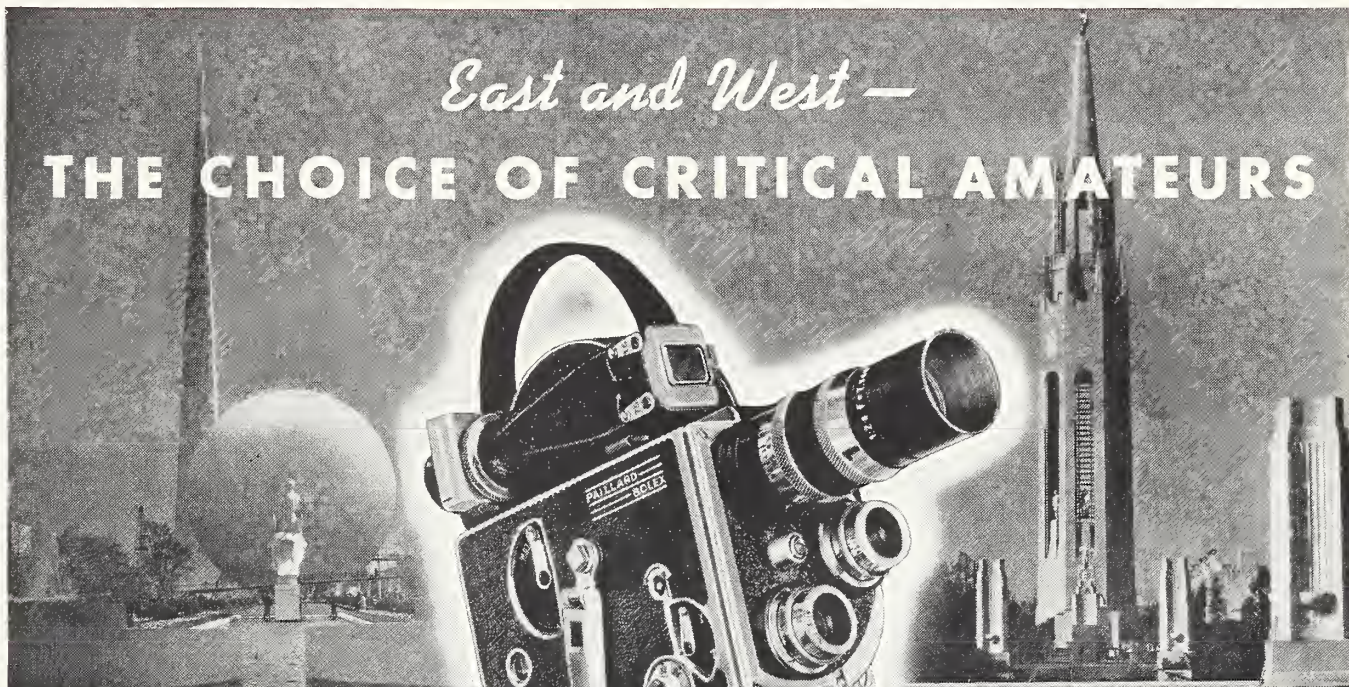

East and West —
THE CHOICE OF CRITICAL AMATEURS

New York World's Fair

Golden Gate International Exposition

THOUSANDS OF MOVIE MAKERS FROM COAST TO COAST ARE ENJOYING THE SATISFACTION OF OWNING A BOLEX CAMERA

LOOK AT A BOLEX FIRST THEN YOU WILL KNOW WHY IT IS MORE ECONOMICAL TO BUY YOUR BOLEX NOW

IN MAKING personal movies it's the results that really count, plus, of course, the ease and pleasure experienced in producing them. The consistently fine films made by outstanding amateurs in America are the most eloquent testimony possible. The makers of these films are the ones who can vouch for the adaptability, versatility, and sterling merit of BOLEX.

Why not get the best, first? It's much cheaper in the end. BOLEX ciné cameras, both 16mm and double-8, are custom built by E. PAILLARD & Co., internationally famous for over a century as manufacturers of precision instruments, and that is your assurance of finest design, materials, and workmanship. There is no other camera like BOLEX—it alone offers these important features: Automatic threading—Spring motor clutch for forward or reverse filming by hand crank—3-Lens turret with clear field for use of wide-angle lens—Tri-focal, parallax-correcting optical viewfinder—Lateral spring tension in gate—Single frame mechanism—And, focal plane type shutter.

Yes, everything with which to produce the finest motion pictures is built right into BOLEX. Go to your dealer today and see how it feels just to handle the world's finest. And then remember—it is cheaper to buy a BOLEX at the start. Send for the booklet.

AMERICAN BOLEX COMPANY, Inc.
155 EAST 44th STREET • NEW YORK, N. Y.

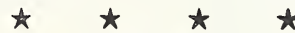

1940 GRAND PRIZE WINNER

LLOYD BACON TROPHY

HERMAN BARTEL, NEW ROCHELLE, N. Y. WINS the coveted Lloyd Bacon Trophy in the Home Movies 1940 Contest. Amateur Bartel's outstanding 8mm Kodachrome production, "Angels are made of wood", was photographed with a Bolex Double-8 camera.

Bolex
paillard

THE WORLD'S FINEST



HARD TO GET?

NOT WITH A CINE TELEPHOTO LENS

The toughest shots become easy with a Wollensak Cine Telephoto Lens. No wonder—the timid deer never knew a picture was taken—the camera was 200 yards away. Take "close-ups" from a distance for humor, variety, thrills... use a Wollensak Cine Telephoto Lens.



WRITE FOR
FREE BOOK!

Wollensak Optical Co., 519 Hudson Ave., Rochester, N. Y.

WOLLENSAK

What auxiliary lens does . . .

• Continued from Page 479

shorten that focus to 10.80 inches to create practically double the dioptric power by using the camera lens set at 2 feet. In other words, it would require a 4-dioptre lens to accomplish this same result with the lens set at infinity.

There are some very important considerations at this point in connection with the use of auxiliaries in this method. Extreme accuracy is necessary due to the fact that we have two forms of dioptric power, one by adjustment, the other by addition of the auxiliary. These two are not the same, and are therefore subject to alteration in combination with each other. Our best protection against error lies in the care with which we apply the formula. There is the possibility of introducing aberration in this combination, and for that reason it is advisable to use plenty of light in the exposure to permit the use of a small diaphragm opening. This automatically reduces aberration and at the same time increases the depth of focus which will take up small errors in distance calculation. Some writers on this subject point out the possibility of using two or more auxiliary lenses in combination to produce the effect of one strong lens with a shorter focus. Theoretically, this is possible and the combination is mathematically correct, but this idea is to be avoided because of the discrepancies resulting from poor contact of the auxiliaries. Air spaces between two lenses produce added aberration and allow the light passing through them to get out of control. Some excellent results are possible by this method, but again it is important to exercise great care in view of the risk of uncertain focus.

Many cine amateurs inquire regarding methods of determining the dioptric value of lenses which they pick up—and desire to use as auxiliaries. Old spectacle lenses are often suitable, as well as simple magnifying lenses such as are found in the 10-cent stores. Many en-

thusiastic amateurs have bought the cheap spectacles and dismantled them for the lenses and applied them to their purpose successfully. Others have found that their own discarded lenses from their eyeglasses can be used, or even those which they wear. An auxiliary lens must be free from astigmatism and there is a simple method of locating astigmatism in a lens, whether or not it is known to exist. To do this, draw a perfect set of cross lines on a card about ten inches square and use this as a target. Place the card in an upright position and look at it through the lens while rotating it. If there is no astigmatism present the lines will not be broken as they pass beyond the edges of the lens. (See Fig. 2.) If they are broken as the lens is rotated (see Fig. 3), there is enough astigmatism present to make the lens unfit for use. If the lines are unbroken, the lens may be used at the distance at which parallel rays of light can be focused as described in the first section of this lens study.

Lenses of uncertain origin, when used as auxiliaries, should also be tested for proper centering. Each lens has what is known as an optical center, or that small point in the center where both surfaces are parallel. This is not always the geometric center though it should be in most cases. The principal axis passes through the lens at the optical center, and unless this is true we create a displacement as serious as parallax.

To find the optical center, use the same target as for locating astigmatism—this time holding the lens by its edges and noting that position where all four lines pass out of the lens edge, still retaining the perfect cross in the center. When it is seen that all four lines are continuous, place a dot of ink on the lens at that point where the lines cross. This is the optical center, and if it is coincident with the geometric center, so much the better. However, cheap lenses are not usually

well centered. Having determined the optical center, place the lens over the camera lens so that this dot is in the center of lens mount. The dot, of course, is to be removed before photographic work continues.

To properly conduct these experiments, it will be necessary to hold the lens at some distance away from the target, somewhere within its focal length, just so the lines are sharp enough to observe the changes. The eye of the observer should not be too close to the lens. Usually a distance of 10 to 20 inches is sufficient for most lens powers, but alterations in the distance may make it easier to see the target. With a little experimenting one may locate the proper distances to make these observations.

For those amateurs who are interested in making use of auxiliaries, it is suggested that they remove the camera lens and mount it in a cardboard box with a ground glass focusing field to correspond with the camera. It is then possible to add auxiliaries and change the focusing mount in every way and observe the effects. Many interesting experiments may be made in this manner without the loss of film. An extensive study may be made of the equipment at hand and its limitations noted. As in the entire hobby of cinematography, best results come from a thorough understanding of the equipment and its adjustments.

An auxiliary lens should be considered in terms of potential power with a complete knowledge of what it will do. There is no mystery about the rules of lens adaptation. It is a definite science and is the heart of our hobby. All equipment is built around the lens system of the camera and every accessory or appliance which we use is for the purpose of producing efficient results with that lens system. Our light control, shutter speed, emulsion speed and all other factors are rated in terms of lens adaptation. With a given standard for a lens system, these other factors must be in proper relationship. When we alter any one of these, we must alter the others to correspond.

SMASHING VALUES

**FROM THE BIG NEW
FREE
LAFAYETTE
CAMERA
CATALOG**

A whole book of values! Packed with all the latest nationally advertised cameras and equipment. It's money-saving! Send coupon for FREE copy at once!

**RUSH ORDER
WITH COUPON**

Enclose ad or note attached to coupon along with check or money order. Mark each item and mail today!

**FREE
CATALOG**



**REELS
& CANS**

Real values! Made of heavy aluminum. Patented shaft opening accommodates every type reel arm. Humidors of heavy gauge aluminum.

8 mm. Reel	16 mm. Reel
8 mm. Can	16 mm. Can
29¢ ea.	39¢ ea.
6 for 1.69	6 for 2.27

FILM CEMENT

1 oz. bottle	1/2 oz. bottle
18¢ ea.	9¢ ea.
4 for 69¢	4 for 29¢

**RUSH
COUPON
NOW**

LAFAYETTE CAMERA

DEPT. 80-K 100 Sixth Ave., New York, N. Y.

I ENCLOSE \$
RUSH MY ORDER. RUSH FREE
CATALOG No. 81

NAME _____

ADDRESS _____

CITY _____ STATE _____

Join now . . . !

The REEL FELLOWS

Sponsored exclusively by Home Movies Magazine, the REEL FELLOWS is a friendly, chummy, coast-to-coast organization of movie amateurs whose purpose is to further the pleasure of amateur movie making and to encourage a wider and more beneficial contact among amateurs.

If you shoot 8mm or 16mm movies, or if you are interested in any of the aspects of amateur movie making, you are invited to become a member of the REEL FELLOWS. \$1.00 membership fee is so low no amateur can afford not to join.

Wear your REEL FELLOWS pin to identify you wherever you go! Upon receipt of your membership application, you will receive membership card, gold pin, and insignia for your camera. Be the first in your community to join! Fill out the REEL FELLOWS membership application below and send it in immediately!

DETACH HERE

MEMBERSHIP APPLICATION

THE REEL FELLOWS

REEL FELLOWS
c/o Home Movies
6060 Sunset Boulevard
Hollywood, Calif.

I am enclosing \$1.00 membership fee, for which please enroll me as a member of the REEL FELLOWS and send me membership card, gold pin, and camera insignia.

I have been shooting movies (length of time).....

My equipment is: 8mm.....16mm.....

Name.....

Address.....

City..... State.....

Quality Bulk Movie Film

8mm • 9½mm • 16mm • 35mm

Complete New Reversal and Title Instructions Free with Film Orders. Separately, 25c each. Cash, check or money order for quick service. Deposit \$1.00 required with C. O. D. orders. Special delivery, 15c; air mail, 50c extra. Overpayments refunded or credited.

Daylight Loading with Processing Included for Bulk Films, add amounts given below, per roll:
Double 8mm, 65c Single 8, 35c 16mm, \$1.50

SUPER CINEPAN PLUS REVERSAL			
Speed 50-40 - Non-Halation Base			
	400 ft.	100 ft.	33 ft.
Double 8	\$13.50	\$3.85	\$1.45
Single 8	7.00	2.15	.80
16mm	12.50	3.50

SUPER CINEPAN REVERSAL			
Speed 24-16 - Non-Halation Base			
	400 ft.	100 ft.	33 ft.
Double 8	\$12.00	\$3.35	\$1.25
Single 8	6.50	1.90	.70
16mm	11.75	3.25

CINEPAN REVERSAL			
Speed 12-8 - Non-Halation Base			
	400 ft.	100 ft.	33 ft.
Double 8	\$11.50	\$3.25	\$1.25
Single 8	6.20	1.80	.65
16mm	11.25	3.15

CINECHROME REVERSAL			
Speed 8-2 - Non-Halation Base			
	400 ft.	100 ft.	33 ft.
Double 8	\$ 5.75	\$1.75	\$.75
Single 8	3.50	1.15	.50
16mm	5.25	1.50

SPEED 8 SEMI-ORTHO REVERSAL			
	400 ft.	100 ft.	33 ft.
Double 8	\$ 4.00	\$1.50	\$.60
Single 8	2.75	1.00	.40
16mm	4.00	1.15

Clear, Lavender, Amber, Blue, Yellow in 16mm.
Only Clear and Lavender 8mm Scored.

CINE-KODAK POSITIVE TITLE FILM			
Darkroom Loading, Laboratory Packed			
	400 ft.	100 ft.	33 ft.
Double 8	\$ 4.10	\$1.35	\$.60
Single 8	2.15	.90	.40
16mm	4.00	1.00

Clear, Purplehaze, Yellow, Red, Amber, Special Blue.
Also DuPont Lavender, Pink, Light Amber.

CAMERA SPOOLS WITH CANS—Each			
Double 8	\$.35	Keystone St. 8	\$.35
Invex 8	.20	16mm, 50 ft.	.50
Filmo St.	.50	16mm, 100 ft.	.60

EXTRA CANS, Double 8 and Straight 8 size..... .05
100 ft. and 50 ft. 16mm size..... .30
Non-Humidor, 400 ft. 20c; 6 for..... 1.00

PRECISION PERFORATING
16mm Films for Use in Double 8 Cameras
50 ft., \$1.00 100 ft., \$1.50 400 ft., \$4.50
Satisfactory in all cameras except Keystone K-8

MISCELLANEOUS	
RATA Precision All Metal 8mm Slitter.....	\$2.50
FOTOFADÉ DYE for making Chemical Pades.....	1.00
FOTOFADÉ WIPE-OFF TAPE, per roll.....	.60
CINETINTS, 6 Colors and Instructions.....	3.60
DUPONT VISCOSE SPONGES, each.....	.35
HOW TO TITLE HOME MOVIES, hook, each.....	1.00
HOME MOVIES, Back Issues, 1936-37-38-39.....	.15
Back Issues, 1946, each.....	.30
TITLE DEVELOPER, tubes, each make 16 oz.....	.15

FILM PROCESSING—PER ROLL			
	Reversal	Title Developing	
	100 ft.	33 ft.	100 ft.
Double 8	\$2.00	\$.65	\$1.75
Single 8	1.00	.35	.75
16mm	1.50	1.25

WE STOCK EVERY MAKE FILM
Write for Complete NEW Price Lists
A PERSONAL MOVIE SERVICE
Telephone Lincoln 1207

W. STUART BUSSEY FILM LAB.
17 E. St. Joseph St. Indianapolis, Ind.

"Glorified Sixteen . . ."

• Continued from Page 482

This will hold the spacer to the crank gear housing while drilling and tapping for its mounting screw, which is indicated at point "K."

After drilling, tapping, and placing of screw at point "K," remove the 10-32 screw and reassemble with the 10-32 screw entered through hole "C" in the rear plate of the effects box.

Fig. 17 shows the placement of the 2-56 screws which hold this plate on as indicated at "L," pilot pins being placed at "M." After this assembly has been made run a 3/16" reamer through hole "J."

Fig. 14 shows the complete complement of parts required for the unit. A little study of this will serve to familiarize one with them.

In the center are located the necessary gears mounted on their respective shafts. Those at the extreme left run through the counters, or at point "A." The next one, upper, point "B"; lower, point "B," point "E," and point "D"; while at the extreme right hand side, mounted on a short shaft, is the 16-tooth gear which is located at point "C."

This shaft should be installed next. It runs through hole "J" to effect the mechanical drive between the bevel gears in the crank housing sump to that of point "C."

A piece of 3/16" rod is cut approximately 1½" long. The 16-tooth gear is reamed out to 3/16" and pressed on to the end of the shaft.

The term "pressed on" means that the shaft should be a trifle larger than the hole in the gear. However, using 3/16" rod and the hole in the gears the same size, some method has to be taken into consideration for holding the gear in place.

For convenience the quickest way is to roll a spline on the rod at the point where the gear rests. In lieu of this, a center punch may be used punching approximately a dozen staggered raises around the shaft, then pressing the gear on.

After pressing the 16-tooth gear on, a brass bearing spacer is turned, ¼" in diameter, 3/16" long with a 3/16" hole through it and slid on the shaft next to the gear.

Slip this assembly through hole "J" at point "C," and slip the bevel gear on in the sump. Drill through the bevel gear shoulder with a No. 49 drill and tap out for 2-56 thread. Countersink the shoulder and screw in a 2-56 flathead screw, and this item is finished.

Assemble the other bevel gears and sleeve on the crank gear shaft and do the same. This completes to drive up to point "C."

Fig. 19 shows dimensions for the shafts the rest of the gears are pressed onto.

The next item for consideration are the two counters used in keeping track of the film footage.

These counters are the type used on bicycles, and are called cyclometers, made by the Veeder Co. of Hartford, Conn. They sell for about \$1.50 each.

Sometimes it is possible to obtain several of these in a used condition from a bicycle shop. By rebuilding them it is possible to make two good ones.

Upon obtaining two of these counters, unscrew the end. This can be accomplished by using a pair of sharp-pointed tweezers and inserting the points in the holes.

Removal of the end plate will reveal a small cam fastened to the main shaft which rotates inside another round ring. Unscrew the cam from the main shaft and remove together with the ring which is around it. The cam should be soldered to ring. These parts may be seen in Fig. 14 just above the two washers at the 10-inch mark on the ruler.

After soldering the cam in the center of the ring, run a 4-36 tap through the hole. Just below the point where this cam and ring rested within the counter case will be found a plate held in with two small screws. Around

the outside of the plate will be found a set of raised teeth. File these off smooth.

Reach in with a pair of tweezers and remove the first star tumbler (these are shown just above the 4-inch mark on the ruler in Fig. 14), then the first numeral ring, then the next star tumbler, etc., etc.

Saw off the mounting base and fill smooth to the contour of the counter.

Screws for holding the counters to the front plate are 2-56 x ¼" flat head, mounting dimensions shown in Fig. 20. After drilling the mounting holes, the counters can be held in position and marked for drilling, after which they are tapped to a 2-56 thread.

The little covers which screw into the ends of the counters must be drilled in their centers for the reset shaft to come through. The diameter of this hole is 11/64".

After mounting the two counters on the plates, assemble their insides. The point "A" shafts are then slipped in and the cam that was soldered inside the ring is screwed on so that the counters are now in operating condition. Screw the end plates in, slip the little spacing bushing on, and screw on the reset knob.

Three small swivel knobs are made for the ends of the point "B" shafts. Two of which are used on the lower "B" shaft and one on the upper "B" shaft. These are used as bearings during the time the lower shaft is being slid in and out without having the shaft rotate on the finger ends.

Fig. 22 shows the housing which lower "B" shaft comes through. This housing is drilled so that a 1/16" ballbearing with a spring behind it, snaps into the grooves in the shaft, locking same so that there is no chance for the gears to become accidentally engaged or disengaged, thereby spoiling some effects being filmed. Fasten housing to the front plate with four 2-56x1/8" round head screws.

Two bearing cover caps are required at point "D" (these are shown in Fig. 14, second row up, above the eight and nine-inch marks). These are ½" in diameter and 1/16" thick, with three holes drilled 120 degrees

MR. 16mm PRODUCER

We offer you complete facilities for adding

SOUND

BLACK & WHITE • KODACHROME
SPECIAL EFFECTS • ART TITLES

GEO. W. COLBURN
LABORATORY

1187-A Merchandise Mart CHICAGO

For Good Pictures

Ask for

Consumers Film Products CORPORATION

COMPLETE LINE OF 16mm AND 8mm
CAMERA AND PROJECTION FILMS
At Your Dealer, or Write Direct
RIDGEFIELD PARK, N. J.

A New Sensational Movie Titler!

Cine Master TITLEER

★ ★ ★ ★ A Four Star Product ★ ★ ★ ★

Here is a titler with new features never before offered in the low price field. Designed by Hollywood Motion Picture Studio Technicians for 8mm and 16mm camera users.

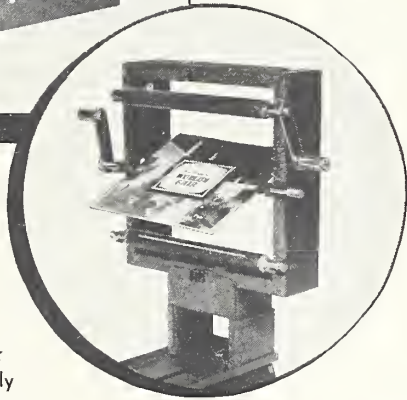
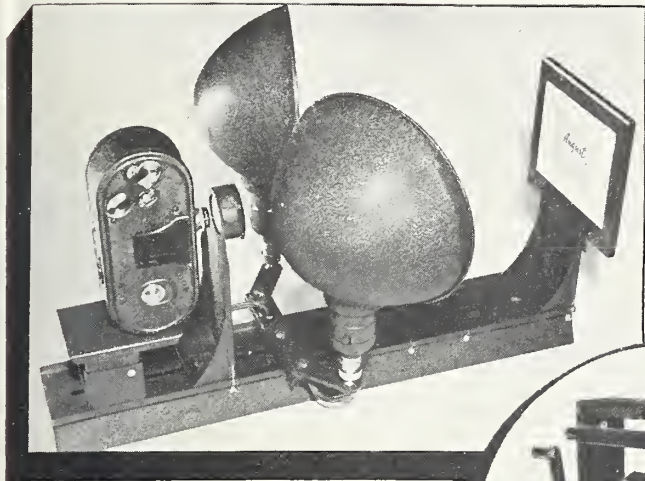

Title cards may be photographed at 4", 6", 8" and 12" distances, creating a larger size "field area" allowing more title card room for hand lettering, printing and drawing for special effects. ★ ★ ★ ★ Title backgrounds and animation sets appearing in Home Movies each month are readily accommodated. ★ ★ ★ ★ Zoom titles and superimposed titles are easily created on the Cine Master Titleer. ★ ★ ★ ★ Accurate alignment is assured with a custom made camera base for your particular camera, eliminating all fuss and bother in lining up titles. Bases for all popular cameras are interchangeable on the Titleer. ★ ★ ★ ★ All parts are adjustable on the Titleer base, making it ideal for table top, copy work and ultra close-up photography. ★ ★ ★ ★ Titleer may be used in a vertical position or mounted on any tripod. ★ ★ ★ ★ The lighting assembly is easily removed or placed at any position on the Titleer base.

6⁹⁵ LESS LIGHTS

9⁹⁵ WITH LIGHTS

Complete with two auxiliary lenses, celluloid target, instructions and tiling data.

TITLEER ACCESSORY KIT No. 1	
Includes an 8" auxiliary lens, set of 25 Titles and Backgrounds, a translucent screen for rear projection shots and two sheets of clear celluloid for superimposed titles.	
Complete Kit.....	\$195

Announcing the TITLEER PROFESSIONAL ATTACHMENT

An outstanding accessory for making all styles and types of professional titles on the CINE MASTER TITLEER.



★ **SCROLL TITLES**

These popular rolling titles may be rolled either up or down as desired. By changing the Attachment frame to a side position on the base, the scroll titles will travel from left to right horizontally.

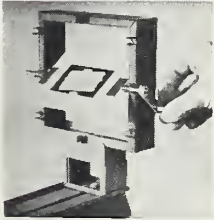

★ **TURNOVER TITLES**

The rotating arms hold the title card edges at the center. By placing the arms in the middle frame clips, the title card can be turned over for the desired effect.



★ **TURNAROUND TITLES**

By changing the rotating arms to the vertical clips, turnaround and turnabout titles are easily made.

★ **FLOP UP and FLOP DOWN TITLES**

These professional titles are made from either the bottom or top clips of the Attachment frame.

★ **PUSH OUT or WIPE OFF TITLES**

A channel on the Attachment frame permits one title card to push another out of the field area and create a wipe-off effect.

★ **TABLE TOP and SUPERIMPOSED TITLES**

The Attachment provides a base support for table top or ultra closeup work. By shooting through lettered celluloid in the card holder, unusual superimposed titles are created.

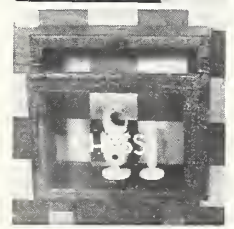
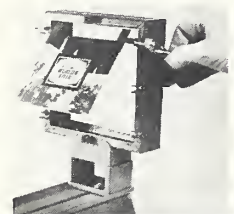

TITLEER PROFESSIONAL ATTACHMENT \$395

Ask to see the Cine Master Titleer at your dealer today!

or write

HOLLYWOOD CINE PRODUCTS CO. 3221 SO. FIGUEROA ST. LOS ANGELES, CALIF.

PROVE IT TO YOURSELF!

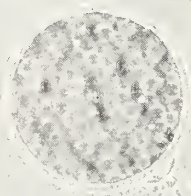

Write for your free 5" x 7" sample of the **BRITELITE-TRUVISION WIDE ANGLE SCREEN FABRIC** and Reflection Test Chart.

Whether you like a Box or Tripod Model, we challenge you to find any other **SCREEN** which will give equal projection quality at all angles... sharper definition, no glare, halation or distortion. Best for black-and-white or color. **NO GREATER COST!**

See the *Britelite Line of Screens, Reflectors, Spotlights, Utility Cases, etc., at your dealer, or write for Catalog and Test Package.*

DE LUXE A MODEL
30 x 40—\$15.00
Other sizes \$13.00 to \$57.50

NU-MATIC SCREEN
30 x 40—\$17.50
Other sizes \$19.75 to \$78.50

TRIFOD SCREEN
30 x 40—\$18.00
Other sizes \$18.50 to \$35.00

MOTION PICTURE SCREEN and ACCESSORIES CO., INC.
351 West 52nd St., New York City



apart for 3, 2-56 x 1/8" round head screws.

Constructive details on the bearing used at point "E" are shown in Fig. 21. Three holes are drilled around the rim spaced 120 degrees apart for mounting with 3, 2-56x1/8" roundhead screws. The unit is now ready to assemble except for one more hole which has to be drilled in the spacer between the crank housing and the effects box.

At upper point "B" a hole slightly larger than 3/16" in diameter has to be drilled into the spacer block so that a spring can be placed there, which will serve to return

the shaft "B" to its original position after resetting the upper or main footage counter.

Drill and bottom this hole to a depth of 7/16". A small spring 3/16" in diameter with about 10 turns in it and stretched to a length of about 1/2", is placed in the hole. Then round the bottom of the crank gear housing.

The assembled unit is shown in Fig. 16, while Fig. 15 shows the unit split.

Next month the data on the wipe-off fan and mounting bracket together with fade and lap devices will be given.

Co-op. Visual System . . .

• Continued from Page 489

perintendent out of his own budget, taking the funds from whatever account or accounts could best contribute each month. The original scale, which still prevails, was 25c per student per year, which was approved as dividing the cost accurately according to student population. Participation for each school year is based on the enrollment of each school as of the previous June, each superintendent paying into the visual education fund his population assessment, for disbursement by the treasurer according to the recommendations of Mrs. Rogers and approval by the group. Payments are made monthly by the districts, enabling the superintendents to have better control of the distribution of the sums in their own budgets, according to the least-taxed accounts each month. "Extra equipment" may bear the visual education assessment one month, "Maintenance" another, or "Furniture and Fixtures" another. With a total enrollment in the participating districts of the county of from 35,000 to 40,000 students, this gave the department a budget of \$9,000 to \$10,00 for administrative expenses, supplies, and the commencement of a film and slide library.

The visual education department functions strictly as a source of supply for the individual schools, making no effort to control or corre-

late the individual teacher's choice or treatment of films. "We believe this to be best," says Mrs. Rogers, "since each teacher has a better knowledge of his conditions and problems than we could have. We simply try to make available as complete a range of materials as possible, so as to have material which will be applicable to every condition and course." The assessment paid by the schools covers unlimited participation in the system, allowing every teacher in every school to requisition as many films as he or she needs throughout the year. Delivery costs, always an important factor to individual schools, are absorbed by the St. Louis County system, a truck service being contracted for to deliver and pick up films requisitioned by the participating schools. The county system issues a catalogue at the beginning of each year, listing all films and slides it has on hand, with brief comments on each; the teachers are furnished requisition forms, on which they specify the films or slides they want, and when. Wants are filled as nearly to requested schedule as possible and teachers are advised when a change of schedule will be necessitated.

Individual schools provide their own projectors and lanterns, the superintendents having decided it would be impractical for the sys-

FREE BOOKLET for CAMERA OWNERS



Here's a little booklet, especially prepared for beginners or occasional photographers, that illustrates and describes the easy way to get perfectly exposed pictures every time you use your still or movie camera. It's written in plain, understandable language, without confusing technicalities; and it's full of interesting, helpful illustrations. Be sure to send for your free copy . . . learn how easy it is to get every black and white or color picture you take sharply exposed with brilliant detail . . . how simple it is to avoid film losses and picture disappointments due to incorrect exposure. Write today, to Weston Electrical Instrument Corporation, 585 Frelinghuysen Avenue, Newark, New Jersey.

WESTON Exposure Meters



INSURE PERFECT PICTURES WITH YOUR CAMERA

BETTER HOME MOVIES

With **BLACK and WHITE FILM**

REVERSIBLE FILM
25 ft. Double 8mm Including Processing
Rating: Weston 12, Scheiner 18. At your dealer or direct. Fast service processing same day included at no additional cost.

Black-White VISCHROME-12
100 FOOT SAFETY FILM FOR PATENT LEADING SPOOL FOR 16 MM CAMERAS
\$1.98

16mm—100 ft. Reversible Film Incl. Processing \$1.98
Rating: Weston 12, Scheiner 18. At your dealer or direct. Fast service processing same day included at no additional cost.

VISUAL INSTRUCTION SUPPLY CO.
1757 Broadway Box H9 Brooklyn, N. Y.

THE NEW "CRITIC" MODEL 40

\$15.50
Perfect exposures because of light acceptance angle of the "Louvre" construction.

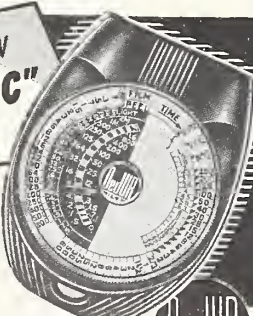

DeJur-Amsco CORPORATION
SHELTON, CONNECTICUT

YOUR DOG--

can be trained for professional or home movies. Spectacular stunts, amazing tricks learned by any size or breed between 8 months and 3 years old.

Write for Details
LA SALLE KENNELS
Dept. M, Wayzata Blvd.
Minneapolis, Minn.

Fully trained Grown Dogs. Also some Fine Puppies, now available

BY POPULAR DEMAND

THIS AD WORTH ONE DOLLAR IN FREE MERCHANDISE

We again make our sensational bona fide gift offer in order to acquaint you with our unique laboratory services, cine equipment bargains and complete stock of motion picture films. You may "spend" this ad for anything listed in our catalogue.

JUST CLIP AND MAIL WITH YOUR NAME AND ADDRESS. WE'LL SEND OUR BULLETIN AND DOLLAR CREDIT CARD IMMEDIATELY!
(This offer is open to everyone, and is valid until November 15th, 1940)

ESO-S PICTURES
3945 CENTRAL STREET KANSAS CITY, MO.

Buy GENERA in BULK

DOUBLE 8 SCORED
SEPARATES WITHOUT SLITTING
Single 8, Double 8 & 16mm

LOAD YOUR OWN SPOOLS and Save Money
A REVERSIBLE semi-or-the OUTDOOR Film. Can be used in Cine Kodaks, Keystone, Victor, Revue and Univex. Also suitable for titles. Processing simplified by use of Prepared Powders. FREE instructions.

200 ft. 8 in dbl. \$1.50 post-paid
Keystone 35c Eastman 40c
100 ft. straight 8 for Univex and Keystone \$1.00 ptpd.
100 ft. 16mm on paper spool for 16 cameras, \$1.25 ptpd.
400 ft. 16mm in 400-ft. reel container, \$4.00 ptpd.

Simplified Processing Outfits incl. Prepared Powders. For 30 ft. single 8, \$3.35, ptpd.; Dbl. 8 & 16, \$4.95
Processing Powders: 1/2 gal. Set, \$1.20; 1 gal. Set, \$1.85
Write for Big Bargain Catalog, our processing prices.
FROMADER GENERA CO., Davenport, Iowa

NOW READY!

FREE New 1941 CATALOG

30 New Features plus many Shorts—16mm Silent Programs, 7 Reels, \$2.25.
Exchange—Exclusive.

ASHA FILM LIBRARY
785 St. Johns Pl. Brooklyn, N. Y.

tem to mix into the equipment end to any great extent. "Each school would have to bear the cost of its own equipment anyway," commented Mrs. Rogers, "so it is logical to let them get their equipment as best suits them. Under the present arrangement, every school participating has a projector except a few of the smaller ones, and they have them available, some two or three smaller schools buying one cooperatively and circulating it among them." The department maintains two sound projectors of its own, which it makes available on need to schools not having sound equipment for the use of sound film.

At present, the St. Louis County system has nearly a thousand films of its own in its own library, some 7,000 slides, and countless photographic exhibits, dioramas, and other visual exhibits.

More important, however, is the fact that the department does not limit its service to the participating schools to its own stock films alone, but functions as a source of supply of films from a myriad national sources as well. In Miss Rogers' desk are catalogues from dozens of sources: state universities, commercial and industrial firms, the government, film rental agencies, other school systems. In the county department's catalogue is a note: "If what you need is not listed here, we will endeavor to get it for you if it is available." So any teacher in any school may requisition any film available through any of these many sources, and the St. Louis County department will order it, pay the rental and the shipping costs, and deliver it under the same arrangements as though it came off the county library shelves.

Easy to tint and tone . . .

• Continued from Page 478

weak for two reasons. A fast dye usually works unevenly, and also gives the operator practically no time in which to judge the density. Thus by using a weak solution, the dye tends to work more evenly and the amateur can better judge the density of the dyed image.

Third, some kinds of metal will react with certain solutions, resulting in muddy or very poor results, and for this reason all metal parts of the equipment used, whether it be trays, racks, tanks or what, should first be covered with a coating of paraffine. Glassware or porcelain is better for this work. Many a worker has had poor results and blamed the formula or the film, not knowing that his own equipment was at fault.

As a rule, positive films will take most dyes and toners better than reversal films. Experience has shown that some reversal emulsions will not take certain dye solutions. Other solutions must then be tried, or, a negative of the film can be run off and a print of this negative toned or tinted. Colored base films can also

be tinted or toned in addition to the color already in the film. Some amateurs use only black and white film, tinting or toning it after they have seen it projected, rather than use the colored base stock.

One way of visualizing how the film may appear after having been colored is to project it holding a colored piece of cellophane in front of the projector lens. Those desiring a more accurate appearance of the finished product take a piece of 35mm positive film and place it in the hypo, thus clearing it yet retaining the emulsion base. When washed this is then dyed or toned in the solution which is to be used on the film itself. The resultant strip is then held in front of the projector lens and the projected image resembles much more closely the actual effect of that particular dye.

In using dyes for tinting, most dyes are satisfactory. They are best obtained in powder form and diluted with distilled water. The film is dipped until the desired color is obtained, then



Made by Ralph Forney, A.R.P.S., with RB Series D Graflex, on Eastman Tri-X Panchromatic Film

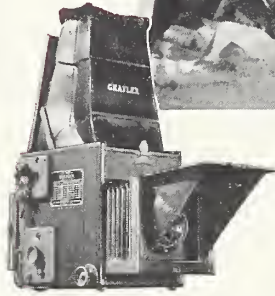

Get the peak of the picture with a GRAFLEX

THIS striking football scene was a picture for just a fraction of a second. An instant before, a routine running play—an instant later, an ordinary pile-up. As with most subjects, the difference between an outstanding picture and an ordinary shot is simply timing.

Graflex is made to order for opportune picture making. You look into the hood . . . focus on the ground glass . . . watch your

subject—right side up and full picture size . . . and when the composition, situation, and expression are just what you want, you click the 1000th-second shutter. The picture's yours—at its best.

See the Graflexes at your Kodak dealer's. The 4 x 5 Revolving Back Series D Graflex, illustrated, with which this fine football picture was made, with 7½-inch Kodak Anastigmat f/4.5 lens, is \$157.

Graflex and Graphic Cameras are made by the Folmer Graflex Corporation

EASTMAN KODAK COMPANY, ROCHESTER, N. Y.

When you buy a **SOLAR** you get more than just an Enlarger!

1ST— IT MAKES PERFECT "PRIZE WINNING" ENLARGEMENTS —AND YOU CAN ALSO USE IT FOR . . .

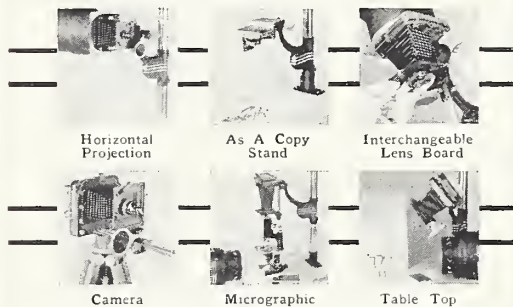

Solar Enlargers give you more of everything. Eight models, with and without condensers, cover negative sizes from 35mm. to 8x7 inches . . . and Solar's perfected optical system brings out the full pictorial quality of every negative. Valuable Enlarging Treatise HM1040 FREE

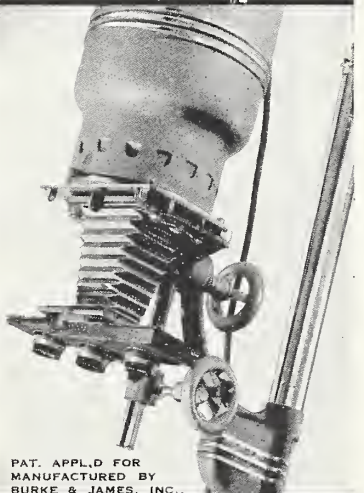

PAT. APPL'D FOR MANUFACTURED BY BURKE & JAMES, INC.

BURKE & JAMES, Inc., (EST. 1897) 223 W. Madison St. Chicago

DO FILTER FACTORS FLOOR YOU?

... then ask about the new **HARRISON Duraline FILTER SET**—4 Filters, a Holder and Shade to meet 99% of all your requirements. With compact leather case—Easy instructions. New low prices. See them at your dealer today! . . . Or write for folder.

HARRISON & HARRISON
Optical Engineers
8351 SANTA MONICA BLVD. HOLLYWOOD, CALIF

Your Own Metal Title Letters

Ask for Samples of the Most Beautiful Capital and Lower Case Letters Made

Title your films with
METAL Letters
Professional
EASY

Complete Sets in Wood Case, 222 Pcs. . . . \$7.16
126 Caps Only . . . \$4.28
AN INTERESTING ADDITION TO YOUR MOVIE HOBBY
Specify White or Black Letters
KNIGHT & SON, INC. P. O. Box B, Seneca Falls, N. Y.

HER GIFT IS SMALL But... THOUSANDS SHARE IT!



By remembering one . . . she's helping thousands! Because her gift is decorated with a Christmas Seal! Your purchases of Christmas Seals will enable your Local Tuberculosis Association to continue its year-round campaign. Since 1907, this campaign has helped to reduce the death rate from Tuberculosis by 75%! But the fight is not yet won. Tuberculosis still takes an annual toll of 64,000 lives! So from now 'til Christmas, mail no letter—send no package—unless it is decorated with the Christmas symbol that saves lives.

BUY CHRISTMAS SEALS
The National, State and Local Tuberculosis Associations in the United States



THRIFTY BULK FILM

Write for Catalog and NOTE THESE PRICES

100 ft. double 8mm semi-ortho.....	\$1.19
100 ft. straight 8mm semi-ortho.....	.75
100 ft. 16mm semi-ortho.....	1.19
Dbl. 8mm empty camera spools.....	.30
Univex straight 8 empty camera spools	.15
100 ft. 16mm empty camera spools....	.40

Slitters for slitting unscored double 8mm film, formerly \$1.50, now only .79

All above film is laboratory packed and prices do not include processing.

California customers please include 3% sales tax. No C.O.D. orders unless accompanied by \$1.00 cash with order.

THRIFTY FILMS
Drawer 98, Watts Station Los Angeles, Calif.

Bass says:

The long and short of it is that you can't beat it for bargains . . . so send at once for my free

NEW CINE BARGAINGRAM No. 245

Stay awake nights reading the thousands of items in 8, 16 and 35mm cameras and stuff for both SOUND and Still movies. FREE . . . print name plainly.

Bass CAMERA CO. Dept. H. M.
179 W. MADISON ST. CHICAGO, ILL.



The NEW IMPROVED HOLLYWOOD CINESCOPE

8-16mm Film POCKET VIEWER. Reg. Price \$1.50. OUR NEW LOW PRICE \$1.00 Postpaid. SPECIAL FEATURES

- Will not scratch film . . . pre-focused for normal vision . . . adjustable for abnormal vision . . . large precision eye-lens . . . will last for years . . . film is held in position by groove . . . can be mounted on editing boards . . . special "light diffusion" screen . . . professional appearance.

Starts on in 1 min When Ordering Above Viewer FREE with Any \$10.00 Order

HOLLYWOODLAND STUDIOS
"The West's Greatest Film Mail Order House"
Southgate, California



washed in running water and hung up to dry.

With the single solution toners, the same procedure is followed, although toning will probably take longer than tinting. Instructions accompanying each toner should be followed carefully.

Of the many methods of toning film the dye toners are probably the best. In this method the film is mordanted in one solution and then toned in another. The mordanting bath is as follows:

MORDANTING BATH

Stock Solution

Uranium Nitrate.....8 grams
Oxalic acid.....4 grams
Potassium ferricyanide.4 grams
Distilled water to make.1 liter

To use, take one part of the mordanting stock solution and four parts of water. Bleach the film until a slight brown tone appears but no further. Wash the film ten to fifteen minutes in running water. The film is now placed in the dye bath, made as follows:

DYE BATH

Dye0.2 gram

Acetic acid (10% solution)5.0 cc.
Distilled water to make1.0 liter

When the desired color is obtained the film is removed from the dye bath and washed for several minutes before being hung up to dry. Some dyes work better in this formula than others, and the following, all of which may be obtained from the Eastman Kodak Co. especially for this purpose, are recommended:

Red.....Safranin A
OrangeChrysoidine 3R
YellowAuramine
GreenVictoria Green
BlueMethylene Blue BB
VioletMethyl Violet

(Use only 25% of the amount of methyl violet stated in the dye bath formula.)

If a double tone is desired in which the shadows are bluish, the following solution may be used:

DOUBLE TONER

Ammonium persulfate.....0.5 gram
Ferric alum.....1.4 grams
Oxalic acid.....3.2 grams
Potassium ferricyanide1.0 gram

Hydrochloric acid (10% solution)1.0 cc.
Distilled water to make1.0 liter

Tone until the shadows are deep blue and after washing immerse in the dye bath as given above.

Even with all the instructions given here, the wise amateur will experiment and test freely before risking an important shot in any of these solutions. Once dyed, the film is done, and the color cannot be removed. Some dyes may "bleed" slightly, that is, wash off to some degree.

It remains now to get out those latest reels, select the scenes best suited for coloring and go to it. Remember, a shot doesn't have to be colored heavily to change its appearance. Sometimes the slightest tinge of blue is enough to bring out a hidden beauty which in black and white is lost.

(Some of the formulas and data contained in this article are included through the courtesy of Photo Technique Magazine.—Author.)

We Shot New York Our Way . . . !

• Continued from Page 472

rear of which seemed to fade into darkness. We told the Chinese proprietor of our need for darkness. Without reply, he ushered us into that distant rear of his establishment, around and behind big stacks of cartons until it was pitch dark. When we came out we were white . . . not with fear but with flour. The proprietor rushed for a whisk broom and brushed us off and offering at the same time all kinds of apologies.

Another amusing series of incidents occurred the day we were photographing Old Trinity. While making pictures of the graveyard from a high stone abutement, a topless Cadillac car drove to the curb and stopped. From the attire of its occupants, I guessed that they were movie people even before they unloaded their equipment which bore the name Universal Newsreel. They waited quietly. It was not until we left that they set up their camera . . . exactly where we had been!

From there we went to a point on Wall Street where

an impressive view of the church can be had. Before our filming there was completed, along came the same movie outfit and set up its camera close by.

We planned to take some skyward close-ups of the church next but, before proceeding, stood and watched the professionals make pictures. Suddenly they got in their car and moved on up to the building where they set up their camera to make skyward closeups! It seemed almost amazing that the two of us . . . one professional and the other amateur . . . should be using the same technique in photographing the same subject. Although our cameras were side by side for the third time, the Universal camera staff ignored us, and we went about our business as if Universal never existed. By now a crowd had gathered and we were mistaken for part of the professional outfit. Curious people were asking questions. One old fellow asked, "What's going on? Is the church going to fall in?" Others wanted to know the name of the picture. We told

them "Manhattan Movie-Go-Round"!

Innumerable authors and composers have written and made songs about the Sidewalks of New York . . . but it is doubtful if any of them have been closer to their subject than we were in producing our conception; Fred and I had laid flat upon the sidewalks in Times Square to photograph the eternal procession of feet.

A newspaper reporter friend of ours had suggested writing an article on our New York movie-making adventures, so it occurred to us that a picture of ourselves on the Sidewalks of New York would be a most appropriate illustration. But, we ran into difficulty having it (a still) taken with the stream of pedestrians so dense.

"Why not take it in a less congested area?" we reasoned; they would still be the sidewalks of New York. So a broad expanse of pavement across from the Pennsylvania Station was selected. There we hailed a pedes-

ORDER FOR SUBSCRIPTION

Home Movies Magazine

12 MONTHS FOR \$2.00 IN U. S.

In Canada, \$2.00; Foreign—\$3.00

SPECIAL OFFER: 3 Years for \$5.00 in the U. S.

HOME MOVIES

1234 Sunset Blvd.
Beverly Hills, Calif.



Name to.....

Address.....

City..... State.....

New Renewal Gift

Name to.....

Address.....

City..... State.....

New Renewal Gift



Enclosed find \$..... Date..... 19.....

Sent in by.....

Address.....

City..... State.....

NO SUBSCRIPTIONS ACCEPTED FOR LESS THAN ONE YEAR



Cine-X Reversal Laboratories

SAVE • SAVE • SAVE

SPECIAL OFFER

on "PLUS+VIOLET" FILM

(Film Speed of 12)

30 ft. Sgl. 8mm for Univex Cameras

60c per roll; 2 for \$1.00

25 ft. Double 8mm

\$1.00 per roll; 4 for \$3.50

100 ft. 16mm

\$2.35 per roll; 4 for \$8.00

THESE SPECIAL PRICES INCLUDE: DAYLIGHT LOADING SPOOLS, PROCESSING and RETURN POSTAGE!

(Calif. Buyers add 3% Sales Tax)

Send Your Order Today to:

CINE-X REVERSAL LABORATORIES

7404 Santa Monica Boulevard
HOLLYWOOD, CALIF.

Hollywood, Calif..

FILM LIBRARY

SEND NOW FOR ZENITH'S
NEW 1941 CATALOG—

containing scores of new comedies, travelogues, and current event pictures—in 8, 16mm silent and 16mm sound. For rental and outright sale. Write now for your copy.

OUR STUDIO is completely equipped for editing, titling, cleaning and Vaporating your films.

COMMERCIAL MOTION PICTURES

With over 16 years' experience in filming 16mm professional pictures, our staff is able to solve your picture problem at either factory, wedding, or social function.

Get on Zenith's Mailing List by Writing Today for Your Copy of the New 1941 Catalog—Now Ready for Mailing.

ZENITH CINEMA SERVICE

5011 N. Sawyer Ave., Chicago, Ill.
"Fine Movies Since 1924"

FINE MACHINE WORK

We install backwinds on Eastman, Bell & Howell, Keystone, Univex, Victor, Revere, and other cameras, and install frame counters on other backwinds. Backwinds from \$10.50 up.

Turret installations of Filmo Double 8, \$28.75. Victor Model 3, \$30.50, and on others at proportionate prices.

Special Apparatus and Lens Alterations

MacVAN MFG. CO.
3829 EL CAJON SAN DIEGO

8 ENLARGED TO 16 REDUCED TO 8

GEO. W. COLBURN LABORATORY

Special Motion Picture Printing
1197-A MERCHANDISE MART
CHICAGO

FASHION TITLES

Eight words or less on photographic background, per title, 25c; extra words, 3c each. 8 and 16mm Sample "The End" title and illustrated catalog free upon request.

CENTRAL CINEMA SERVICE

6420 Cottage Grove Ave. Chicago, Ill.

trian to snap the picture.

While certain adjustments were being made, we found ourselves surrounded by another crowd of curious people... a crowd so large that a cop broke through to see what was going on. We explained meekly. He told us to make it snappy... so the picture was snapped without further ado. New York is the most susceptible city in the world to ballyhoo; you can get a crowd around you just by parting your hair on the wrong side.

Making "Manhattan Movie-Go-Round" was a never-to-be-forgotten adventure. Roaming the countries of the earth couldn't offer greater thrills. Ascending to the towers of its skyscrapers was like exploring the world's highest mountain peaks; threading our way between these monuments of stone was not unlike passing through deep, mysterious canyons. The city's nationality districts (and what nationality can't

you find in New York?) seemed like little countries; and the great New York harbor furnished all the maritime rapture that could be found elsewhere in either hemisphere.

All of this has to do with the New York of today... but time marches on with so many changes. In future years, will this city pack as many thrills? Without roaring elevated trains; without surface cars in Times Square clanging their merry bells; without the pushcarts on the East Side, and the tenements of that district? We know that removing these from "Manhattan Movie-Go-Round" would leave a pretty flat picture. And we know that the eye of a sight-seer is not unlike that of the one behind the shutter of a camera.

"Manhattan Movie-Go-Round" is dedicated to the New York of today... the city at its pinnacle of human appeal.

Movie of the Month...

• Continued from Page 473

ard announcing the opening that day of the town's annual Fish Festival. The two fish in the box proved a friendly token of the event.

Peering after the girl, the old man senses the feeling of friendship of the girl for the fisherman. He's grateful, too, for the help she's given him. So, thus touched, the old fellow returns to the shack, empties an old sugar bowl of his meager savings, and tramps into town to buy the girl a new dress and a pair of shoes.

When he returns, the girl eagerly dons the new dress and shoes and then goes out in search of the fisherman along the waterfront to tell him she'll be his partner at the festival. Soon located close by his fishing boat, the two sit and chat awhile.

Presently the boss, whom the girl feared she might have killed in the cafe scuffle the night before, appears at the boat dock on business. At first the girl is frightened, and then realizing she has nothing to fear, snuggles into the protecting

arms of the fisherman.

There's a flashback to the old man seated in his shack reading a newspaper, and then an insert of a columnist's account of the young couple's marriage and honeymoon aboard the fishing boat. Not new but very effective was the closing scene ending in a fadeout of two hands clasped about a spoke of the tiller-wheel.

Filmer Jensen has done a fine piece of camera work in this picture. His flair for composition stands out decidedly in every scene and, on the technical side, his fades, dissolves, and montages are excellent. Lighting of all interior scenes was very professionally done and there was a notable absence of straight flat lighting so often found in the interior shots of amateur made movies. Jensen knows his lighting equipment well, and knows how to use it to advantage.

The most outstanding feature of this picture perhaps is the editing and here again Jensen's camera genius is quite evident. For with all

Amaze Your Movie Loving Friends

TAKE **COLORTONE** MOVIES

★ COST NO MORE THAN
BLACK AND WHITE FILM

Color sequences give LIFE and PEP to your films! Just imagine what a few feet of Amber scenes, or a Pink title here and there could do to otherwise drab and colorless movies! SUPERIOR COLORTONE FILM is a brand NEW tinted base film offered by us exclusively. Every foot evenly tinted for brilliant projection quality. Colors will not scratch off, fade, or wear away. The film is fine grain Weston 8 orthochromatic, American made. Choice of colors, lavender, pink, yellow, and amber. Order a roll of each and explore the astonishing possibilities of COLORTONE movies. Be sure to specify color.

100 ft. Double 8mm Colortone.....\$1.65
100 ft. Single 8mm Colortone..... 1.00
100 ft. 16 millimeter Colortone..... 1.25

PROCESSING MADE EASY

Complete instructions for making your own processing drum, tank, drying rack, etc. Plans and processing directions included. 25c.

ORDER TODAY—Colortone film is easy to use, and is processed like ordinary film. Shipped promptly, postpaid, to you. Satisfaction guaranteed. Send postcard for free circular on bulk film, processing rates, etc.

SUPERIOR BULK FILM CO.
"Home Processing Headquarters"
188 W. Randolph Street
Dept. HM-10 Chicago, Ill.

Presenting

A MOVIE A MONTH

For 8 and 16mm Fans

A new plan entitling members to an extremely low cost viewing service.

Complete Edition Castle Films

8mm and 16mm for Just a

Few Cents a Day

AND THAT'S NOT ALL

You receive one headline edition free. You select it and own it.

IT'S A GREAT SERVICE

Write Now for Further Details

Movie a Month Association
Box 524 Reynoldsville, Pa.

The Service That Saves

Cable Release and Adaptor

FOR

BELL & HOWELL

Sportster and Companion Model Filmo

Don't grope for the trigger or jar the camera. Enter the picture yourself. Operate the camera and pan head with one hand. Adaptor no larger than a half dollar, instantly attached and detached, will not interfere with loading, winding or tripod mounting. Can be left on camera permanently. Adjustable for single frame, for straight filming, and can be locked for continuous running.

Adaptor and 10-inch lock cable, \$2.00 postpaid in the U. S. Eastman and Keystone releases ready for delivery after November 15.

GARMUR PRODUCTS

P. O. Box 6073, Metropolitan Station
Los Angeles, California



16mm
Outdoor
AMBERTINT \$2.00
Per 100' roll
Fine grain safety film,
Weston 8. Machine-
processed. California
buyers include sales tax.
HOLLYWOODLAND
STUDIOS
Southgate, Calif.

NOTICE TO MOVIE FANS

If you take movies (8mm or 16mm) you simply cannot afford to be without a Free copy of the latest Photo Bargain Book now being distributed throughout the U. S. Lists all the best moving picture equipment from all the leading manufacturers, describes them. The prices save you money in many cases. You'll find the latest in lenses, screens, meters, projectors, cameras, film, titlers, editing outfits, tripods, books on editing, titling, etc. This Bargain Book is invaluable to you as an equipment REFERENCE book. Don't wait a day longer to send for your Free copy. Write us now. CENTRAL CAMERA COMPANY
230 S. Wabash Dept. J-9 Chicago, Illinois

THOUSANDS now using the new, improved "HOLLYWOOD CINE-SCOPE" 8-16mm Pocket Viewer



MAGNIFIES 36 TIMES NORMAL SIZE
A \$3 Value, NOW, ONLY \$1 Postpaid

Large, precision-ground eye-lens shows bright, clear, image... focus set for normal vision but adjustable... film is slipped in at side, held by groove... easily mounted on editing boards... has "light diffuser" State if for 8 or 16mm... IMMEDIATE DELIVERY... (NO STAMPS)... FREE! "Table of sizes" chart, showing field-sizes at various distances.

"NOPARLAX" alignscope, a precision instrument, to line up and focus titles, insects, etc., at close range... fits all 8-16mm cameras having screw-in lenses... image is seen EXACTLY as it will be on the film. (State camera used.) \$12 postpaid.

NEW "GADGET"... telephoto adapters, to adapt 8-16mm cameras to various std. lenses, for use as "telephotos." Save \$10 or more, using these adapters. Price \$3 up.

WOLL (new) 1-inch f/3.5 (color correct) to fit 8mm, \$12. T. H. C. (used), same as above, adapted to fit 8mm, ONLY \$10. "FLY-LITE" (stereo) title-letter set (155 pes.), ONLY \$2. (Add 35c exp. ins.). Dime brings samples and catalog.

"HOLLYWOOD CINE GADGETS"
P. O. Box 403 Hollywood, Calif.

OCTOBER SPECIAL

ONYX 8 OUTDOOR FILM **\$750**

4—100 foot 16mm with processing,
1—400 foot projectar reel, 1—400 foot storage can, all for the above price. A \$10.00 value.

We can save you money on all of your film needs. A post card will bring our money saving price list.

KENWOOD FILMS
1231 E. 46th St. Chicago, Ill.

8mm SLITTER

Slits perfectly 16mm width film to exact 8mm width. Die cast body with hardened steel cutting wheels. New price, each, \$2.50.

DEVELOPING RACKS

Stainless steel, take 30 feet 16mm or 8mm width film. Can be used in 11x14 or 8x10 flat trays respectively. Complete with loading stand, each, \$6.75. Specify type wanted.

At Your Dealer's or Direct

J. C. Haile & Sons
Motion Picture Dept.
215 Walnut Street Cincinnati, Ohio

CINE SHOP TITLES

WRITE FOR NEW CATALOG

Cine Shop

1012 PIEDMONT CHARLESTON, WEST VA.



\$200 16mm Outdoor AMBERTINT Per 100' roll

Fine grain safety film, Weston 8. Machine-processed. California buyers include sales tax.

HOLLYWOODLAND STUDIOS
Southgate, Calif.



due respect to his fine skill at the editing board, Jensen made his task much easier by giving proper thought to editing in the filming of each scene. It was for editing this picture, you may remember, that Jensen received an

Achievement Trophy in HOME MOVIES' 1940 Annual Amateur Contest, as announced last month.

And now "Driftwood" has captured another award for Jensen in acquiring recog-

niton as the Movie of the Month. We hope this will spur him onward toward further cinematic goals. "He certainly knows his stuff!" as one amateur remarked during the review-screening of his film.

Teach your dog to act . . .

• Continued from Page 483

and you tell the dog to go and get up on a distant rock or picnic table, he must do it and stay there until you call him back to you. After he has learned these things the sky is practically the limit when it comes to further training. If he is the larger type dog, he can learn to pull a cart, open doors, and even such feats as opening the old fashioned farm cellar door and letting it close on him after he gets through. Then there are the usual tricks such as catching things thrown to him, creeping on his belly, jumping through hoops and the snake walk, which is to walk between his master's legs, weaving in and out as they go along.

This trick in itself can be used as the basis for a plot for a movie. Here is an actual story which happened some years ago as related by Beno Stein, the famous trainer. A friend of his who was a lion tamer lost an arm, and this finished his career as a lion trainer. One day this one-armed friend was watching Mr. Stein teach a dog this snake walk.

He went home and taught it to his own Shepherd dog. Things went from bad to worse for the ex-lion trainer through sickness, misfortune, etc., and he finally resorted to selling newspapers on the street, with his faithful dog helping him.

All the while, he was trying to save enough money to buy and make stage properties to take his dog on the road. Half of the time he could hardly make enough to feed himself and his dog, yet he kept the dog in trim, hoping that some day things would break for him. Then one day a miracle happened. While busily engaged selling his papers, a near-by jewelry store was held up. The robber gathered up the jewels and put them in a bag, rushed out of the store with long strides and ran past the news stand where the dog was alone at this moment tending the papers stand for his master, who was farther up the street. The dog, seeing the robber coming along the street taking those long strides, could think of only one thing—zig-zagging between those flying legs, as had been

taught him by his master. Of course, this tripped the robber, who sprawled on the sidewalk, dropping his bag and spilling the loot on the pavement. The police captured the thief and the former lion trainer received a financial reward which enabled him to fulfill his dream and purchase the necessary equipment to take his dog on the stage.

Although it is now several years since Mr. Stein related this story, for all know our friend the ex-lion trainer and newspaper peddler is still traveling the circuit making a good living with his trained dog.

I think there is somewhat of a moral in this story. Even though we may never expect to make a living with our dog, one could invest time and money in no better way than in training his dog just in case. Rin Tin Tin is best remembered as the most famous dog actor. But there are many smart dogs among all breeds. Perhaps there's another Rin Tin Tin among them just waiting for the training and opportunity that will make him famous, too.

Schools produce teaching films . . .

• Continued from Page 488

radiator while truck was moving as the boys approach. Then the small brother suddenly sights the truck. Fortunately, there were some good actors in the film, and the small brother's look of horror is real indeed as they are about to strike the truck. As they loom up in front of it, a cut to the two boys struggling under the wheels of the stopped truck tells the rest of the story.

In another wreck sequence filmed at a street intersec-

tion, the students made the necessary trick shots and then moved the camera back to a street corner for the ambulance scene. Arrangements had been made for the city's police ambulance to roar into the scene with siren wide open. Passers-by actually thought there had been an accident and they came rushing into the scene and gathered around the stretcher bearers, etc., all of which made the action extremely realistic.

Property crews arranged

with local motor car dealer and funeral homes for the necessary trucks and ambulances. City officials provided a fire truck for a se-

CORRECTION

• In the article on Home Processing in the September issue, 5th paragraph from the last, page 447, there appears a typographical error in the quantity of ingredients to be used in one formula. The quantities for potassium bromide and mercuric chloride were given as 7.5 ounces. The correct amount is .75, or $\frac{3}{4}$ ounces for each ingredient.

100 ft.--16mm THRIFTY FILM \$160

Thrifty Films save you 50% on your film cost. Three splendid films to choose from—each a leader in its class. And now the surprise—look at these prices!

THRIFTY ORTHOTYPE
For OUTDOOR... non-halation base, fine grain, fast—the film you've been wanting to find at an unheard-of low price. Machine processed. Per 100 ft. rolls..... **\$160**

THRIFTY PANCHROMATIC
Use for all types of shooting. High-speed Weston 16 daylight—10 photofoods, machine processed. Per 100 ft. rolls..... **\$3.75**

THRIFTY SUPER-PANCHROMATIC
Super-fast; high sensitivity, requiring minimum of light. Weston 50 daylight—32 photofoods, machine processed. Per 100 ft. rolls..... **\$4.25**

When you use good film, from a reliable house, you have a complete developing laboratory, you'll save yourself many disappointments. THRIFTY FILM is a proven value and our complete laboratory is one of the best in the West.

California Buyers Please Include Sales Tax
Sold and Processed Only by
THRIFTY FILMS
Drawer 98, Watts Station Los Angeles, Calif.

YOUR CHOICE OF
WESTON
Master or Master Cine (40 Model)
EXPOSURE METER \$14
(REGULAR \$14 LIST)
... and your old model Weston exposure meter (if in good order).
Send check for \$14 and old meter

CAPITAL CAMERA EXCHANGE
FREE—latest film speed rating chart and bargain list of used cameras

1003 PENNA. AVE. N.W.—WASH., D. C.

A DIME A DAY BRINGS FUN TO STAY
Enjoy home movies on Don's simple Dime-A-Day payment plan. Pay \$2.50 down on Keystone, Revere, etc., 8mm and 16mm cameras, balance in 10 easy payments; no interest, no carrying charge. Send for free catalog. Write Dept. HM1.

don elder's home movies
739 BOYLSTON ST., BOSTON, MASS.

GLASS-BEADED MOVIE SCREENS
Easily Made!

Make your own sparkling beaded screens—at a fraction of their usual cost! Crystal beads can be applied to cloth, cardboard or almost any smooth surface. Complete directions with each pound (No fractions of pounds sold).

Glass Beads (to cover) sq. ft. (1 lb.) Finest Size \$1.95

D. GARD, C-8, 54 WEST 74TH ST., NEW YORK CITY

CLEAN FILMS PROJECT THE BEST PICTURES

Use Our Dry Film Cleaner—Price \$3.95 Postpaid
FISHER MFG. CO.
17 Main St. E. Dept. 61-V Rochester, N. Y.

8mm SUBJECTS FOR SALE or RENT
Charlie Chase's, Charlie Chaplin's, Snub Pollard's, Paul Parrott's. 200 feet 8mm Brand New Comedies. Send for list and catalogs. Large rental library.

THE ABBE FILMS
1265 Broadway New York

8mm Bulk Film 16mm
Lowest Prices
Write for Catalogue
HOLLYWOODLAND STUDIOS
Southgate California

quence where a group of bicycle riders dash to a fire. Local and state police provided policemen-actors, as well as patrolmen to shut off traffic from congested areas where we were shooting.

Editing of the film was done on a "wholesale" basis—a method which, it would seem, would not make for quality, but which worked out well in this case because of the fact that a well-planned script was followed to the letter.

Before shooting a scene, its identifying number would be written on a slate and photographed on a few frames of film preceding the scene as a means of identification for the editors.

There were 24 sequences in the film, so the editors provided 24 wire clothes-hangers on which to hang the scenes for each sequence. Then as the film was broken down in the cutting room, the individual scenes were clipped to the required sequence-hangers which greatly expedited the as-

sembly of the scenes under this "wholesale editing" arrangement.

On scenes where there were several takes of one shot, the best was chosen in the "first draft." The film was then assembled in correct order with Scotch tape, and spliced, run several times to note scenes which needed shortening, and then cut again where necessary.

As yet, Dover's school system has not acquired any equipment for filming or editing movies, so it became necessary to rent cameras, and editing equipment. The equipment used in producing "Jack Finds a Way" included a 16mm Bell & Howell Camera equipped with one, two, and three inch lenses; a Bolex camera; a tripod; exposure meter; and a Craig projecto-editor. The production has since proved so successful, however, that school officials are reported seriously considering the purchase of its own equipment for the production of instructional films by the Dover High School staff.

Can I improve my film?

Continued from Page 485

became necessary to make a shot with too modern a background in the distance, camera angle was changed—heightened or lowered—in order to obtain just the right effect and eliminate anything within the scene that might appear "modern."

Editing: Highly commendable is the cutting of this picture. Scenes are of

just the proper length to make the story understandable and yet not make the story lag at any point. There was one scene that might be eliminated. This shows one of the daughters holding the garden hose and sprinkling the lawn while listening to her mother tell the story. The closing shots of the picture show the hose being inadvertently turned upon the

All Amateurs, whether subscribers of HOME MOVIES or not, are invited to submit their films to the editors for review and helpful criticism. Unless otherwise requested, reviews of some of the films which we believe would benefit other amateurs will be published each month.

Reviewed films will be roted one, two, three, and four stars, and films qualifying for two or more stars will receive, free, on omitted leader indicative of such award. Detailed reviews, with suggestions for improvement—if any—will be mailed to amateurs submitting their films.

Exceptional films qualifying for

the distinction of the "Movie of the Month" will be treated in detail in a feature length article in a following issue of HOME MOVIES. In addition, a certificate evidencing the award of "Movie of the Month" and a special animated "Movie of the Month" leader will be returned with such films after review.

When submitting films for review and analysis, please advise make of camera, speed of lens, whether or not tripod was used, or if you used filters, exposure meter, or other accessories. While this information is not essential to obtain analysis of your film, we would like to pass it on for the benefit of other amateurs.

A SENSATION with HOME MOVIE MAKERS

Double Your Film Fun Scripts

With Filmed Main Titles and Endings; Complete Sets of Title Cards; Clever Film "Props"; and Novel Ideas Galore!

Now Featuring
Plots and Blots

An Adventure for Amateur Cinematographers in Trick Photography and Interesting Miniature Filming, With Intriguing Accessories and Professional Hollywood "Shooting" Script, complete, at only..... **\$1.75**

Ask for Our Catalogue of Other New-Idea Scripts!

SPECIAL OFFER—Your Name on a Personal Screen-Credit Title Card as Producer or Cinematographer for 10c. You can use it with any of your reels.

HOME-MOVIES SCRIPT SERVICE
Pathe Building, 331 Turk Street
SAN FRANCISCO, CALIFORNIA

Golden Gate International Exposition 16mm Films

Four 100-ft. reels. No titles except heading and end.
REEL No. 1—Gen. views, Oakland Bay Bridge, Tower of Sun, Fountains, Buildings, etc.
REEL No. 2—Continuation of reel No. 1.
REEL No. 3—Continuation of reel No. 2.
REEL No. 4—Night photography, The Fair in all its glory! General views of the Gay Way.
Each reel complete, but you can add one to the other without duplication. **BLACK AND WHITE** specially priced at.....each **\$1.95**

NATURAL COLOR PRINTS
Full color Kodachrome showing the Fair in all its beauty.
100 ft. 16mm..... **\$9.00**

8mm BLACK AND WHITE
50 ft.....\$1.75 180 ft.....\$5.50
California Buyers Include Sales Tax

HOLLYWOODLAND STUDIOS
"The West's Greatest Film Mail Order House"
SOUTHGATE Box 14 CALIFORNIA

FREE
16mm SILENT AND SOUND-ON-FILM RENTAL LIBRARY CATALOGUE
Films Shipped Anywhere—Large Selection
Write Today for Your Copy
NATIONAL CINEMA SERVICE
71 Telegram Sq. New York City

FOTOFADE

FADES, WIPES Can be added to your Reels after Processing
WITH FOTOFADE on black and white or color films. Price, \$1.00. Waterproof Wipeoff Tape, 60c per roll. Complete Fotofade Kit.....\$1.60
CINETINTS for coloring your 16mm or 8mm film. Set of six colors, \$3. At your Dealer or direct.
DYE RESEARCH LABORATORIES
318 Jackson Street Los Angeles, Calif.

"It Always Gets the Picture"
G FILM
DESTROY THE FIFTH COLUMN OF HOME MOVIE FAILURES
100' 16mm (inc. Proc., postpaid).....\$1.50
100' Dble. 8mm (inc. Proc., postpaid)..... 1.75
100' Sgle. 8mm (inc. Proc., postpaid)..... 1.00
Unspooled to Save You Money Scheiner 18

M-G-M PHOTO SERVICE
1485 Oak Street San Francisco

MILRO FILMGRAPH
VOICE AND MUSIC RECORDINGS

Making your own "Talkies" now possible with newly patented FILMGRAPH. Instantaneous and permanent play-back. Cost of recording only 25c per hour. Over 13 hours of indexed VOICE, RADIO, CODE, TELEPHONE recording on a single reel of film costing \$3.00 up. Bulletin free.

MILES REPRODUCER CO., INC.
Dept. HMA, 812 Broadway New York City

4 FEATURES of FILM PROTECTION

- INTERNAL SOFTNESS
To resist heat and dry air.
- EXTERNAL TOUGHNESS
To resist scratches and stains.
- SURFACE LUBRICATION
To resist wear and sprocket-strain.
- PERMANENT IMPREGNATION
To resist loss of protection in cleaning.

Impregnations, with SEPARATE chemical vapors, each doing its SEPARATE job, give you effective 4 FEATURE FILM PROTECTION against CLIMATE, WEAR, SCRATCHES, OIL, DIRT, WATER and FINGER MARKS.

Better Photo Finishers Offer VapOrate protection for still negatives.



VAPORATE CO., INC. 130 W. 46th St. New York City
BELL & HOWELL CO. 1801 Larchmont Chicago 716 No. La Brea Hollywood

FRAME-COUNTING WINDBACKS

Guaranteed accurate. Expertly engineered and installed. Money-back guarantee.

Keystone.....\$15.00 • Filmo.....\$19.95
Precision Built Accessories for Every Need

Write Us Your Requirements

Custom Built Camera Accessories Co.
4124 Rawlins Dallas, Texas

25¢ Kodak Finishing 25¢

Any 6 or 8 exp. roll dev. and printed for only 25¢. Quality guaranteed. None finer. Bring in or mail.

Extra Prints—122 or smaller, 3¢ each. 35mm enlarged to 4x5, 5¢ each. Write for complete price list.

THRIFTY PHOTO SERVICE
10364 State Street Lynwood, Calif.

THALMETAL TRIPOD

FOR VERSATILITY AND VALUE

Pan-tilt head, sturdy metal and wood legs, beautiful appearance and other standard Thalhammer features make this one of the world's finest tripods. Economically priced at \$14.50.

See it at your dealer's today.

THALHAMMER COMPANY
1015 West 2nd St. Los Angeles, Calif.

ABSOLUTELY FREE 5,000 "A TO Z" MOVIE TITLING TRY-IT-YOURSELF KITS

Also Sample "Figurette" for Backgrounds

Send Today - Keep the Kit - It's Yours

JACOB STEIN, Mfr.
175 Fifth Ave. Dept. H-18 New York

Patents and Trade Marks

Patent and profit by your inventions. Protect your most valuable assets.... Expert personal service.

LESTER L. SARGENT
Registered Patent Attorney
1115 K St., N. W. Washington, D. C.

\$200 16mm Outdoor AMBERTINT Per 100' roll

Fine grain safety film, Weston 8. Machine-processed. California buyers include sales tax.

HOLLYWOODLAND STUDIOS
Southgate, Calif.



IN PHILADELPHIA

CAMERAS

and Everything Photographic

KLEIN & GOODMAN
18 S. 10th STREET

father, thoroughly soaking him, and then of father fuming and stomping about, shaking the water from his clothes.

Titling: This phase of the picture was well executed. All titles were neatly lettered, nicely centered, and well exposed.

Photography: Generally, exposure was very good. Under-exposure was deliberately used in several instances to accentuate theme of story and to obscure the background. All scenes were well centered.

"BELOW THE BORDER" ★★★
700 ft. 16mm — By V. M., Indiana

Continuity: As the title of this film indicates, it is a documentary of a trip to Mexico—a record of a vacation trip made to the interesting land of our southern neighbors. It is, indeed,

a thorough job. The opening scenes are given over to a great deal of statuary for which Mexico City is famous, but in short order, the picture moves rapidly onward, showing interesting scenes of the natives, and important and picturesque points of interest in Mexico such as typical native homes, the pyramids, many cathedrals, and the interiors of some of them, and of a silver mine. There are some particularly fine scenes of a Mexican bull fight, too, and the picture closes with a few peaceful tropical panoramas.

Editing: Is generally good throughout. There are a number of very dramatic closeups and most scenes are cut to a reasonable length. Cutting of the bull

fight sequence was well done.

Photography: The camera work throughout this picture was fairly good. There was a tendency to move the camera too much, for in the greater part of the picture the camera is either panning or tilting. Also there were several over-exposed shots. Commendable are the telephoto shots of the bull fight.

Titling: Main title was superimposed over street scene of Mexico with people in scene walking past camera. Other titles were made with Mexican blankets as backgrounds which added an interesting color note. In all the descriptive titles were very informative and contributed much toward making the picture interesting.

Detail depends upon emulsion . . .

• Continued on Page 481

But the advances in speed noticed broadly between the various classes of film have a practical value. The faster the film, the smaller the lens stop that may be used under given conditions, and the greater will be the depth of field. Conversely, with the faster films, it is possible to make satisfactory pictures under increasingly poor

light conditions. With an f:3.5 lens, for example, under conditions where with the average color-blind film the lens would have to be used wide open, with the average ortho film the lens can be stopped down to f:5.6; with the average pan type, to f:9; while with the fastest pan types one could stop down to f:8. Thus, with the

faster films, one can keep on making good pictures under conditions where picture-making would be utterly impossible with slower films.

Finally, consider the matter of shooting interiors. "Impossible" is a mighty big word, so it can hardly be held that it is impossible to shoot under artificial lighting with the "color-blind" and ortho films. Besides, one or two people have done it quite successfully. To do so requires a tremendous amount of light, for the greater part of the light radiated by Photoflood globes is composed of the red and yellow rays, to which such film is least sensitive. For interiors, the pan types are supreme, and the faster the film, the more useful it is when one goes indoors.

So, if color rendition is of only minor importance, and getting plenty of pictures is the paramount question, use the economical "color-blind" film. If distinctly more normal results are wanted, and the subjects to be filmed are average, all-around outdoor subjects (other than those where red clothing, etc., are really important factors), use one of the "ortho" or chrome types. Finally, if the very best is wanted and one is willing to pay for it, "pan" is the film to use.

Exposure Meter Guide

CORRECTED OCTOBER 1, 1940

	SCHEINER		WESTON			SCHEINER		WESTON	
	Day	Mazda	Day	Mazda		Day	Mazda	Day	Mazda
AGFA					GENERA				
16mm SSS Pan.....	29	27	100	64	Meteorpan.....	23	21	24	16
16mm Hypan.....	24	23	32	24	Normal Panchromatic.....	20	18	12	8
16mm Panchromatic.....	21	20	16	12	Super Ortho.....	21	17	16	6
16mm Supreme Pan. Neg.	27	25	64	40	Movetone Ortho.....	19	13	10	3
16mm Finopan Neg.....	23	21	24	16	Semi-Ortho.....	18	12	8	2
16mm Positive.....	12	8	3	..					
16mm Pleaschrome.....	20	..	12	..	KIN O LUX				
8mm Twin-8 Hypan.....	23	21	24	20	No. 1.....	16	..	6	..
8mm Filmopan.....	18	16	8	5	No. 2.....	18	16	12	..
					No. 3.....	26	24	50	40
DUPONT					CONSUMERS				
Reversal Pan.....	21	19	16	10	Ortho.....	18	..	8	..
Regular Pan Neg.....	20	18	12	8	Panchro.....	23	21	24	16
Superior Pan Neg.....	24	21	32	20	Colorchrome.....	18	..	8	..
Positive.....	12	..	2	1-6					
EASTMAN					HOLLYWOOD				
16mm Super XX Pan.....	100	64	S. S. Pan.....	26	25	50	40
16mm Super X Pan.....	24	23	32	24	Pan.....	21	20	16	12
16mm Safety.....	20	18	12	8	Semi-Ortho.....	18	12	8	2
16mm Sound Pan.....	23	21	24	16					
16mm Pan. Negative.....	23	21	24	16	UNIVEX				
16mm Positive.....	16	10	5	3	Standard.....	17	14	6	..
8mm Super X Pan.....	23	21	24	16	Ultrapan.....	20	18	12	6
8mm Regular Pan.....	18	16	8	5					
Kodachrome (8 & 16mm)	18	14*	8	3*	GRAPHICHROME				
Koda. "A" (8 & 16mm)	18*	21	8*	12	Regular.....	18	10	8	3
GEVAERT					Plus.....	20	17	12	6
Super Reversal.....	23	21	24	16	Superpanex No. 100.....	29	27	100	64
Panchro.....	20	18	12	8	Superpanex No. 24.....	23	21	24	16
Ortho.....	21	17	16	6	Colortone.....	18	10	8	3

*With filter.

O'Sullivanized FILM



- Prevents FADING and BLEEDING

Boiling Water Test

Made Under Witnessed Supervision and Sworn Affidavit.

A strip of Processed Color Film Placed in Boiling Water for 4 Minutes.

Result: Dyes were neither run nor upset and a clear picture remained.

Our claims for permanency in color are based on ordinary film usage, but it is strong enough to stand abuse.

- 1 Reel 50 to 200 feet 8mm . . . \$.50
- 1 Reel 200 to 1600 feet 16mm . . . 1.50

See Your Dealer or Write

O'Sullivan Film Process

5184 Santa Monica Blvd. Hollywood, Calif.

THRILL your audiences!
WITH Sensational Films

GET NEW PRINTS Lowest PRICES Order from Producers

Exciting new films now ready! WRITE TO Sensational Films BOX 1504 - HOLLYWOOD, CAL.

SPECIAL PRICE LIST SAMPLE FILM 10¢

16mm Outdoor AMBERTINT \$2.00 Per 100' roll

Fine grain safety film, Weston 8. Machine-processed. California buyers include sales tax. HOLLYWOODLAND STUDIOS Southgate, Calif.

PROCESS YOUR MOVIES

With Roycraft equipment, home processing is easy. Enjoy the fascinating hobby of processing your own movies and save on film. Complete equipment, capacity 30 ft. single 8, double 8, or 16mm, \$2.95. Processing chemicals at minimum prices. Write for circular.

ROYCRAFT COMPANY

Dept. 23, Box 1810 Milwaukee, Wisconsin

Our new catalogue is now ready. It lists the largest library in the world of 16mm sound, 16mm silent, and 8mm silent films.

IDEAL PICTURES CORPORATION

28-34 East 8th St. Chicago, Ill. 2402 West 7th St. Los Angeles, Calif.

★ TITLES ★ REDUCING ★ ENLARGING ★ BULK FILM ★ REVERSE PROCESSING

16mm Write for ILLUSTRATED CATALOGUE

8mm GENERAL CINE SERVICE

204H 18th St. New York

GIBBS FLOOD-GUNS

THE ONLY flood-light that follows the camera—models for either still or movie cameras.

ARTHUR E. GIBBS

1925 N. E. Knott St., Dept. H Portland, Oregon

Demountable Filmo Turret . . .

• Continued from Page 475

stator plate—at the top position, as shown at "A", Fig. 1, and then tapped for a No. 44 thread to receive the small patented lens adapter that is used for holding the regular Bell & Howell lens in place on the camera.

As some makes of 8mm lenses may be found to protrude through the rotor plate too far, striking the stator plate and preventing correct seating of the lens, a well of sufficient depth may be machined in the stator, as shown in Fig. 1, to allow for such extension. Again, some lenses may fail to seat properly if the lens adapter (Fig. 4) extends too far through the stator plate. In such cases, the adapter may be shortened by working down the threaded end on an oil stone. Usually three threads are sufficient to hold the turret unit securely on the camera.

A small hole about 1/8" deep and 1/8" in diameter is milled into the back of the stator plate, as shown in Fig. 2, allowing the stator to fit over the guide pin on the lens mount opening of the camera. Also a slot is cut into the back of the stator, just below the hole, described above, which allows the plate to fit over the left hand exposure button guard on the front of the camera. This also serves to keep the turret in accurate position at all times and preventing its turning when

the rotor is revolved in changing lenses.

Important are the two rotor gauge pins "E," Fig. 1, which guide the rotor in place and aid in accurately seating the lens. They also serve to keep the lens mounting clear of obstructions until in position to drop into place before the lens opening. Detail of these gauge pins are illustrated in the lower unit of Fig. 2.

There is just one precaution—and that is, the lens, when mounted in the turret, must be at the right distance from the film plane. The regular Bell & Howell lens adapter referred to above is .1875 in thickness, plus a tolerance of .0003. Thus the thickness of this turret completely assembled must not exceed the total of these dimensions.

The wise cinebug will shoot a few feet of tests, after assembling this turret to his camera, before proceeding with any great amount of filming, in order to insure he is getting a sharp focus. Any errors, of course, may be adjusted with a file and emery paper, or shims.

The final touch is to finish this gadget to match the finish of your Filmo. This may be done by most enameling and plating houses, the majority of whom include crackle finishing as a part of their service. Where crackle finish is not obtainable, a bronze or nickel finish will be found acceptable.

Accurate Alignment . . .

• Continued from Page 477

scenes or short length close-ups and will increase the length of the cartoon. The eyes can be made movable in these closeup scenes by cutting them out and drawing them on a slip of heavy paper which may be moved back of the openings.

If you like to draw, it will be easy to make other subjects by using these same principles which give a reasonable amount of anima-

tion with a minimum of time and labor.

One scene or title may run from 48 to 160 frames or more each (3 to 10 seconds projection time). Make them too long rather than too short.

Nearly every 16mm movie camera can be made to function well as a printer for making duplicates and some projectors will do a good

BRITELITE SUNSPOT

FOR MODELING QUALITY 4 1/2" DIAMETER FRESNEL LENS

FOR ECONOMICAL OPERATION No. 1 PHOTO-FLOOD

10.95 COMPLETE WITH BULB AND TABLE BASE

Advanced optical system, designed to take advantage of the high actinic value and lumen output of the NO. 1 PHOTO-FLOOD. Versatile push-pull focusing from table-top, portrait to full length and group photography. For color or black-and-white. Lamp housing of aeronautical aluminum alloy, amply ventilated. May also be mounted on BRITELITE Junior Tripod (6 1/2 feet) . . . PRICE \$4.00

See the SUNSPOT at your dealers or write for complete specifications and for the BRITELITE catalog, Dept. HM-10.

MOTION PICTURE SCREEN and ACCESSORIES CO., INC. 351 West 52nd St., New York City



SAVE ON MOVIE FILM

LOOK AT THESE LOW PRICES	16mm	16mm	8mm
REGULAR Weston 8 semi-ortho . . .	\$1.79	50 ft. \$1.19	25 ft. \$.98
SUPER . . . full ortho, wide latitude, non-halation, Weston 12 . . .	2.19	1.39	1.19
PAN . . . extra fast, Weston 24, panchromatic, fine grain . . .	3.69	2.19	1.39

PROCESSING AND RETURN POSTAGE INCLUDED. Each roll complete on DAYLIGHT LOADING spool in metal container and strong mailing carton. Fast service, 24 hours or less in our modern laboratory. Send only \$1. We ship C. O. D. for balance. Or remit in full and save postal charges. NOT SOLD IN STORES. Order TODAY direct from this ad.

ESSCO FILM PRODUCTS Dept. HM, 6117 S. Campbell Ave. CHICAGO, ILL.

Why use anything else when **TITLES BY PARK CINE** cost no more than ordinary titles.

Catalog Free on Request **PARK CINE LABORATORY** 120 West 41st Street New York City

EXPERT PHOTOGRAPHY MADE EASY

Successful photography as a career, for sparetime earnings or as a hobby—made easy through New York Institute Training! Practical, thorough, personal coaching by leading photographers. Fascinating field. Splendid opportunities. Commercial, News, Portrait, Motion Picture, Advertising and Color Photography. Personal attendance and Home Study Courses. Booklet FREE! N. Y. Institute of Photography, Dept. 114, 10 West 33rd Street, New York, N. Y. (30th Year)



RAVEN SCREENS

Used exclusively in the Kodak Cavalcade of Color at World's Fair. At all leading dealers. Literature on request.

RAVEN SCREEN CORP., 314 East 35th St., New York



When You Buy **BAIA** You Buy the Best

Precision Made; Guaranteed Perfect

\$2.50

From Your Dealer or Direct **BAIA MOTION PICTURE ENG.** 259 Gerald, Highland Park (Detroit), Michigan

MAKE YOUR OWN TITLER!

For all types of titles, close-up and copy work. Complete kit of finished parts—optically ground lens—easy instructions. Assemble in 15 minutes! Money Back Guarantee. State camera model. Distinctive Title Card—"Photography by (your name)"—35c

ONLY \$1.95 IN KIT FORM

For All 8 or 16 MM CAMERAS

HOLLYWOOD MOVIE SUPPLY COMPANY NORTH HOLLYWOOD • CALIFORNIA

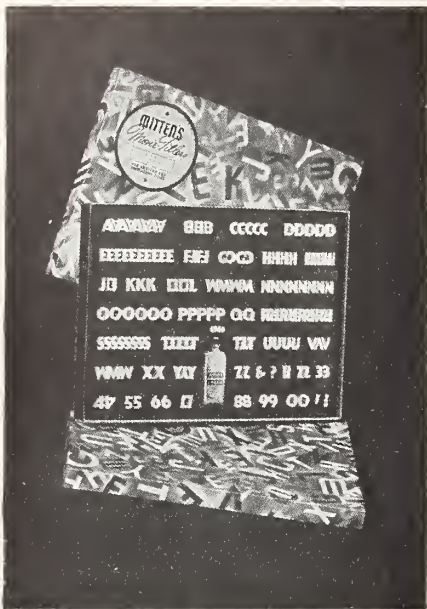

TITLES make movies talk for themselves!

Why not take full advantage of the pleasures of your hobby? When you foil to title your films . . . you foil to enjoy the thrill of making a real finished home movie.

Ask your dealer about the PIN AND SANDED BACK TITLE LETTER SETS. They are ideally suited for making theatre quality titles with any 8mm or 16mm camera.

PIN LETTER SETS
\$5.50 Up

SANDED BACK LETTER SETS
\$4.75 Up

Write for Descriptive Literature and Information on Our Complete Line of Letters

MITTENS LETTER COMPANY

REDLANDS, CALIFORNIA



job, too. The writer has also tried some 8mm printing and found it reasonably good for cartoon films but too grainy for general printing unless very fine-grained films and developers are used. A bright but fairly distant light source improves printing sharpness. Animated cartoons are *practically grainless*, subjects being mostly black or white.

In photographing and printing animated cartoons, give *minimum exposure* and *maximum development* for best results. Eastman D-72 stock developer mixed 3 to 1 is excellent for both the negative and the positive. If exposure is correct, development may run 4 to 6 minutes at 70° to 65° F., respectively, when using positive films. However, good results can be obtained over a wide range, depending on experience and the effects desired.

The third and last part of this series will be presented next month.

Indoor filming . . .

• Continued from Page 480

scribed above. By means of a large piece of white paper or cloth located on the opposite or shadow side of the subject, (see Sketch No. 2) the shadows are illuminated indirectly.

Greater lighting interest and a professional touch may be provided by employing a third light source above and in back of the subject so that only the hair and shoulders are illuminated. This is known as "back-lighting." A spotlight type of reflector is desirable but not necessary for this purpose. Direct light from this unit should be shielded from the lens.

Reflectors provided with floor stands are desirable but not necessary. "Clamp-on" sockets to which may be fastened well-designed reflectors are very satisfactory for the beginner. These may be clamped to doors, chair backs and other pieces of furniture. Spare photo-flood lamps and extension cords are other items in the inventory not to be neglected.

With the approach of indoor living and holidays, take a tip from the Boy Scouts' motto, and "Be Prepared."

Cine workshop . . .

• Continued from Page 487

into the hole of the cardboard and hold same up for inspecting the scene, so that No. 1 appears on top. Rotate the screen while holding the cardboard in one and the same position; when the desired effect is observed, read off the number to which the handle or your line-mark is pointing. Slip the cardboard over the camera lens so that the reverse side may be read with No. 1 on top and attach the Pola Screen according to previous reading.

—Arthur Wolf.

Reader Speaks

• Continued from Page 466

of Trinity College? Reason for wanting such shots is, this person is a relative who passed away recently.

—John H. Trunk,
34 Cherry St.,
Valley Stream, N. Y.

Gentlemen: Can you tell me where I can get a few scenes of Baltimore; Washington, D. C.; Wilmington, N. C.; Charleston, N. C.; Savannah, Macon, and Atlanta, Ga.; or any scenes along the route from the Smoky Mountains to New York City, the Fair, and thence to Boston?

I recently completed a trip which took me through these cities and states, but I had only 500 feet of film and lack many important shots that I should like to add to my travelog.

—Joseph George Velardo,
23 Ashley St.
East Boston, Mass.

Information please

• Continued from Page 462

which the light must pass. Those who have successfully used binoculars and telescopes with their camera lenses for telephoto shots, recommend opening up the camera lens diaphragm from 1½ to 3 stops.

Binoculars have an "f" value, but this is never marked on the instrument as they are not designed to be used photographically. For those who want to determine the "f" value of

a binocular, divide the focal length by the diameter. The figure will undoubtedly be quite low. This is an approximate method as there are prisms in many binoculars which will cause an added reduction in light.

The best method is to make a short test strip with the binoculars in place before the camera lens, filming a few feet of a scene for each stop on the lens. Be sure to make a note of the normal exposure for the scene, as given by your exposure meter or camera exposure chart, and from this may be determined the number of stops increase that must be made when compared with the exposure of the normal scene on the test strip.

Backyard Movies

• Continued from Page 464

with a scene showing your departure by auto, bus or train. Then show the place you visit and make a picture of your arrival. After that make a record of your vacation, showing your activities, the interesting places you saw, and any amusing or unusual thing that happened to you.

At the end, show your return home. For this part you need a companion. As you and the friend arrive at your house and start to go inside, pause and motion that you want to be pinched. Here you should fix a title reading, "It was such a grand vacation it must have been a dream. Pinch me so I'll know I'm awake." Then show the friend giving you a hard pinch. Next, instead of the fade-out and a shot showing it was a dream continue the scene showing surprise on your face, and then a very delighted smile. Close the picture with the title, "So I found it wasn't a dream at all."

—Sarah Rogers.

Title troubles

• Continued from Page 468

zooming is to be done, the easel should probably be vertical to allow a horizontal track for the camera movement. If much animation is anticipated, a horizontal easel will be found necessary, with the camera suspended vertically above

Directory Of Amateur Cine Clubs.

ARIZONA

TEMPE: Tempe Cine Club (8mm and 16mm)—Howard Lindly, Sec'y, 103 E. 5th St. Meet 2nd Wednesday.

CALIFORNIA

ALHAMBRA: La Casa Movie Club (8mm and 16mm)—H. P. Carnahan, Pres., 21 S. Garfield. Meet 3rd Monday each month.

AZUSA: Sunkist Movie Makers of the San Gabriel Valley (8mm and 16mm)—Elbert B. Griffith, Sec'y, 708 E. Bonita Ave. Meet 1st Monday each month.

BERKELEY: Berkeley Amateur Motion Picture Club—Micky Ambrose, Sec'y, 1719 E. 15th St., Oakland.

BURLINGAME: Peninsula Home Movie Club, Recreation Center (8mm and 16mm)—Thomas J. Branson, Jr., Sec'y, 125 Lorton Ave. Meet 1st and 3rd Tuesdays.

EL SEGUNDO: South Bay Camera Club—Heath L. Martz, Vice-Pres., 314½ Virginia St.

FRESNO: Fresno Movie Makers—R. C. Denny, Sec'y, 750 Vassar Ave.

GLENDALE: Glendale Lens & Shutter Club (8mm and 16mm)—Howard Manning, Sec'y, 547 N. Brand Blvd. Meet 2nd Tuesday each month.

HANFORD: Kings Camera Club—G. Meldrum, Pres., 206 W. Grangeville Blvd.

HAYWARD: Hayward Cinema Club (8mm and 16mm)—Harvey Reed, Jr., Sec'y, 230 Pearce St. Meet 2nd and 4th Thursdays.

HERMOSA BEACH: Amateur Movie Club of Hermosa Beach—Robert Balfour, Producer.

HIGHLAND PARK: Highland Park 8mm Club (8mm)—Howard Timmons, Sec'y, 4530 W. Avenue 41. Meet 2nd week of month.

LONG BEACH: Long Beach Cinema Club—Pat Rafferty, Sec'y, 2215 E. 8th St. Meets 8 p.m. 1st and 3rd Wednesdays at Y. W. C. A.

LOS ANGELES: Los Angeles 8mm Club—Leo Caloia, Sec'y, 143 West Avenue 28. Meet 2nd Tuesday each month.

Los Angeles Cinema Club (8mm and 16mm)—Wm. Hight, Sec'y, 361 N. Formosa Ave. Meet 1st Tuesday each month.

Southwest 8mm Club (8mm)—Mrs. W. B. Blanchard, Sec'y, 2127 Glendon Ave. Meet every 3rd Tuesday.

LYNWOOD: Southern Cinema Club (8mm and 16mm)—Don Hunt, Sec'y, 3522 Firestone Blvd., South Gate, Calif. Meet 4th Tuesday each month.

MONTEREY: Peninsula Cine Club (8mm and 16mm)—H. H. Daugherty, Box 97, Pacific Grove. Meet 3rd Wednesday each month.

NORTH HOLLYWOOD: North Hollywood Cine Club (8mm and 16mm)—Ted Knight, Sec'y, 4873 Lankershim Blvd. Meet 1st Tuesday each month.

NORWALK: The Tri City Movie Club (8mm and 16mm)—Bert P. Teets, Sec'y, 804 Pine. Meet 1st and 3rd Wednesday of the month.

OAKLAND: Bay Empire 8mm Movie Club (8mm)—R. J. Shattock, Sec'y, 4132 Opal St. Meet 2nd and 4th Wednesday of month.

The Greater Oakland Motion Picture Club (8mm and 16mm)—B. F. Pratt, Sec'y, 2039 Shattuck Ave., Berkeley. Meet 2nd and 4th Monday each month.

PASADENA: Pasadena Movie Club—Gordon Plank, Sec'y, 413 N. Oak St., Temple City. Meet 3rd Wednesday of each month.

POMONA: Pomona Valley Club—T. J. Hebert, 155 S. Garey St.

RED BLUFF: Tehame County Movie Club (8mm and 16mm)—Hank Schafer, Sec'y, 415 Madison St. Meet every 3rd Thursday of the month.

SACRAMENTO: Sacramento Movie Club (8mm and 16mm)—Wilfred Meacham, Sec'y, c/o Associated Oil Company. Meet 1st Thursday of month.

Sierra Camera Club (8mm and 16mm)—John Pardee, Sec'y, 1207 K St. Meet 2nd Tuesday and last Thursday.

SAN DIEGO: San Diego Cinema Club (8mm and 16mm)—G. E. Taylor, Sec'y, 4522 Utah. Meet 2nd and 4th Wednesday each month.

SAN FRANCISCO: Cinema Club of San Francisco (8mm and 16mm)—Edwin L. Sargeant, 1980 Washington St. Meet 3rd Tuesday each month.

8-16mm Movie Makers (8mm and 16mm)—Margaret Bauer, 1080 W. 17th St. Meet 1st and 3rd Thursday each month.

Cinematronics Club of San Francisco, 130 Taraval St.

Golden Gate Cine Club (8mm and 16mm)—Helen Hawkins, 666 Edinburgh St. Meet 1st and 3rd Wednesdays.

Sherman Clay Movie Club (8mm and 16mm)—Mrs. C. E. Griffon, Sec'y, 1335 Washington. Meet 3rd Wednesday of each month.

• Amateur movie makers interested in joining a cine club may make inquiry of the secretary of the club nearest their vicinity whose headquarters are given on this page.

If you are interested in forming a new cine club, HOME MOVIES will be glad to assist you. You are invited to write to the editors for free data that will be of assistance to you in organizing a club.

Listing of additional clubs will be made to this directory from time to

time as the data is received from club secretaries. Every amateur cine club in the United States, Canada, and Mexico is invited to participate. Clubs not as yet listed are requested to furnish the necessary information for listing.

Stars indicate clubs from whom club-produced films are available to other clubs on exchange basis on payment of transportation charges.

This directory is another of HOME MOVIES' exclusive services for the amateur movie maker.

Silver Screen Players of San Francisco (16mm)—Bette Byers, Sec'y, c/o Eric Mawson, 237 Woolsey St.

Westwood Movie Club of San Francisco (8mm, 9½mm and 16mm)—Eric Unmack, Sec'y, 1944 Ocean Ave. Meet last Friday each month at Community Building, Ocean Ave. at Granada Ave.

Western Union Movie Club (8mm)—L. W. Henry, Sec'y, 3260 Gough St. Meet 1st Tuesday each month.

SAN JOSE: San Jose Cine Club (16mm)—Frank T. Bondi, Sec'y, 1286 Vine St. Meet 1st Monday each month.

SANTA ANA: Orange County 8mm Club (8mm)—Jack Kahler, Sec'y, 1512 Dresser St.

8-16 Movie Makers—Thelma Heath, 1028 Hickory St. Meet 1st and 3rd Thursdays.

STOCKTON: Port Stockton Cine Club (8mm and 16mm)—K. R. Oliver, Sec'y, 345 N. San Joaquin. Meets 2nd and last Thursday of each month.

Stockton Cine Club—Harold Liddicoat, Sec'y, 11 S. Hunter St.

WHITTIER: El Rancho Camera Club (8mm and 16mm)—Mabel Beck, Sec'y, 2241 Valle Drive, La Habra. Meet at Murray Ranch, Whittier.

COLORADO

DENVER: Bell Movie and Camera Club of Denver—H. M. Price, Box 960.

Denver Cine 8mm Club—Preston Hopkins, Sec'y, 631 E. Colfax St. Meet 2nd Monday each month.

CONNECTICUT

BRIDGEPORT: Monogram Movie Club.

BRISTOL: Bristol Cinema Club—Earle H. Sparks, Pres., 20 Good St. Meet 2nd Thursday each month.

HARTFORD: Hartford Amateur 8mm Camera Club (8mm)—George McGauley, Sec'y, 1214 Main St.

Nutmeg Film & Reel Club—J. Philip Farley, Sec'y, 138 Main St.

MANCHESTER: The Manchester Cinema Club—Mrs. Thos. Hooley, Sec'y.

NEW BEDFORD: Greater New Bedford Movie Club—Percy Lord, Sec'y.

NEW HAVEN: The 8mm Movie Club of New Haven (8mm)—Syd Sidebottom, Sec'y, 29 May St., West Haven. Meet 3rd Tuesday each month.

STAMFORD: Stamford Cinema Club—R. Taylor, Sec'y, 65 South St. Meet 3rd Wednesday.

TARRINGTON: Tarrington Cinema Club.

DISTRICT OF COLUMBIA

WASHINGTON: National Capital Cinema Club (16mm)—Geo. D. Lane, 738 Numsey Bldg. Meet 2nd Thursday.

WASHINGTON: Washington Society of Cinematographers (8mm and 16mm)—Wilbur F. Comings, Sec'y, War College Dept. Meet 1st and 3rd Mondays.

Washington 8mm Club—Dr. I. Rodis, Sec'y, 1726 Eye St. Meet 2nd Wednesday each month.

FLORIDA

JACKSONVILLE: Jacksonville Moviemakers (8mm and 16mm)—350 St. James Bldg. Frank M. Linville, 424 W. 17th St.

GAINESVILLE: Orange State Camera Club—Earl H. Jernigan, Pres., Box 587. Meet every other Tuesday.

MIAMI: Miami Camera Club—Alfred Kahn, Sec'y.

Miami Movie Makers (8mm and 16mm)—Mrs. Paul Hockett, Sec'y, 1460 N. W. 38th St. Meet 1st and 3rd Monday each month.

TERRITORY OF HAWAII

HILO: The Family Movies Club—P. O. Box 106.

HONOLULU: Honolulu Amateur Cinema Club (8mm and 16mm)—Richard G. Bailey, Sec'y, c/o Nuuanu Y.M.C.A., Fort St. Meet 1st and 3rd Tuesday each month.

GEORGIA

ATLANTA: Atlanta Movie Club (8mm and 16mm)—Douglas Cone, Sec'y, P. O. Box 74, Station C. Meet 1st and 3rd Friday each month.

THOMASTON: Thomaston Movie Club—(16mm and 8mm)—J. Lee Abernathy, Sec'y, 308 W. Main St. Meet every other Sunday.

IDAHO

BOISE: Boise Camera Club (8mm and 16mm)—Mabel M. Sturgis, Sec'y, 1505 N. 15th St. Meet 1st and 3rd Tuesday each month.

NAMPA: Nampa Movie Club (8mm and 16mm)—Art French, Sec'y, c/o Northwest Photo Shop. Meet 1st Monday.

ILLINOIS

BERWYN: Suburban Amateur Movie Club (8mm and 16mm)—John Triska, Sec'y, 2415 S. Highland Ave. Meet 1st and 3rd Monday each month.

CANTON: Canton Movie Camera Club (8mm and 16mm)—Lafe Drury, Sec'y, Main and Walnut. Meet 2nd and 4th Mondays.

Chicago Cinema Club (8mm and 16mm)—Miss Lillie Thy, Sec'y, 20 N. Wacker Drive. Meet every Thursday.

The Camera Adventurers' Club (8mm)—Mrs. Frank H. Crowe, Sec'y, 6508 N. Richmond St.

Chicago Cinematographers—S. F. Warner, 1538 Marengo Ave., Forest Park. Meet 1st Tuesday each month.

Commonwealth Edison Camera Club—Arnold R. Hatch, 72 W. Adams St., Room 737.

Circle Camera Club (8mm and 16mm)—Eugene J. Etges, Sec'y, 1139 N. Lamona Ave. Meet every 4th Wednesday.

Lane Tech Movie Club—A. P. Heflin, Sec'y, 2501 Addison St.

Metro Movie Club of River Park (8mm and 16mm)—J. W. Claywell, Sec'y, 5100 N. Francisco Ave. Meet every Wednesday night.

Shutter Snapper Club—Faith Church, Pine and Augusta.

Southeast Cine Club (8mm and 16mm)—B. Fox, Sec'y, 6900 Jeffery Ave. Meet 2nd and 4th Monday each month.

South Side Cinema Club (8mm and 16mm)—Caroline Heltzer, Sec'y, 7321 Lawrence Ave. Meet 2nd and 4th Wednesday each month.

The Camera Adventurers' Club (8mm)—Mrs. Frank H. Crowe, Sec'y, 5916 N. Paulina.

Triangle Cinema League of Chicago (8mm and 16mm)—Leo Brooks, Sec'y, 1528 S. Harding Ave. Meet Sunday afternoons, once or twice a month.

Westlawn Cinema Club—Walter Sengstock, Sec'y, 1517 S. Kostner Ave.

EVANSTON: Northwestern Amateur Club.

HOMEWOOD: 3H Camera Club, Movie Division—George Durand, Sec'y, 1750 Linden Rd.

OTTAWA: Ottawa Cine Club—C. F. Grover, Sec'y.

PEKIN: Pekin Cinema Club (8mm and 16mm)—Howard E. Miller, Sec'y, Box 262. Meet every other Monday night.

PEORIA: Peoria Cinema Club, Inc. (8mm and 16mm)—Miss Lena R. Hoerr, Sec'y, 1102 Frye Ave. Meet every 3rd Tuesday.

ROCKFORD: Rockford Movie Makers (8mm and 16mm)—Betty Knudson, Sec'y, 1411 4th Ave. Meet 1st Monday each month.

ROCK ISLAND: Tri-City Cinema Club (8mm and 16mm)—Albert N. Mueller, M.D., 550 26th St. Meet 4th Friday each month.

INDIANA

ELKHART: Conn Camera Club—Florindo Viti, Sec'y, Conn Entertainment and Athletic Ass'n.

FORT WAYNE: Fort Wayne Amateur Cinema Club (8mm and 16mm)—B. J. Olander, Sec'y, 2560 E. Brook Dr. Meet 2nd Monday each month.

HAMMOND: Calumet Movie Makers (8mm and 16mm)—Gladys Patrick, Sec'y, 5411 Price Pl. Meet every 3rd Monday.

INDIANAPOLIS: Indianapolis Amateur Movie Club (8mm and 16mm)—Alfred F. Kaufman, Sec'y, 4623 N. Arsenal Ave. Meet 1st and 3rd Wednesday each month.

Super-Art Productions of Indianapolis—W. Stuart Bussey, 17 E. St. Joseph St.

Public Service Company Camera Club—James Genders, Sec'y, 4935 W. 11th St.

VINCENNES: Vincennes Camera Club (8mm and 16mm)—Robert M. Johnson. Meet 1st Thursday.

IOWA

DES MOINES: Y. M. C. A. Movie and Camera Club of Des Moines (8mm and 16mm)—Mary H. Platt, Sec'y, 3223 2nd St.

Movie of the Month

• Each month the Editors of HOME MOVIES select the best picture sent in for analysis and designate it "The Movie of the Month." This movie is given a detailed review and a special leader is awarded the maker.

This award does not affect the eligibility of such films for entry in the annual HOME MOVIES CONTEST. They are automatically entered for rejudging with those films submitted especially for the annual contest. Films awarded the honor of MOVIE OF THE MONTH during past 12 months are:

1939

NOVEMBER: "Esquire's Escapade," produced by Clarence M. Aldrich, Long Beach, Calif. A 16mm picture 800 ft. in length.

DECEMBER: "Souvenir," produced by Harold E. Remier, Hollywood, Calif. A 100-ft. 8mm Kodachrome film.

1940

JANUARY: "The Cauldron," produced by Dr. R. E. Gerstenkorn, Beverly Hills, Calif. A 16mm picture 400 ft. in length.

FEBRUARY: "Whistling Wings," produced by W. H. Nordin, Austin, Minn. A 16mm Kodachrome picture, 400 ft. in length.

MARCH: "Checking Off the Budget," produced by B. W. Johnson. An 8mm Kodachrome film, 1000 feet in length.

APRIL: "El Lobo," produced by Demetris Emanuel. A 16mm picture, 400 feet in length.

MAY: "From A to Z," produced by Vernon Altred, Stockton, Calif. A 16mm Kodachrome film, 400 feet in length.

JUNE: "Peetie," produced by Edmund Turner, Detroit, Mich. A 16mm Animated Cartoon, 400 feet in length.

JULY: "Song of the Soil," produced by E. C. Denny, Buffalo, N. Y. A 16mm Kodachrome film, 800 feet in length.

AUGUST: "St. Margarets," produced by Gordon MacCormack, Montreal, Canada. A 16mm Kodachrome film, 400 feet in length.

SEPTEMBER: "Angels Are Made of Wood," produced by Herman Bartel, New Rochelle, N. Y. An 8mm Kodachrome film, 200 feet in length. (Winner Lloyd Bacon Trophy, 1940 Amateur Contest.)

OCTOBER: "Driftwood," produced by A. O. Jensen, Seattle, Wash. An 8mm Kodachrome film, 400 feet in length.

Directory Of Amateur Cine Clubs.

- SIOUX CITY:** Amateur Cinema Club of Sioux City (8mm and 16mm)—Don Goodwin, Sec'y, 3733 7th Ave. Meet 3rd Tuesday each month at Hunt School.
- KANSAS**
- PRATT:** Camera Club—16mm and 8mm—Benjamin F. Henry, First Presbyterian Church.
- WICHITA:** Wichita Amateur Movie Club—Mrs. Martin Lentz, Sec'y, Martin W. Lentz Co., 111 W. William St.
- MASSACHUSETTS**
- ATTLEBORO:** Attleboro Movie Club—Francis J. O'Neil, 37 Pleasant St.
- BOSTON:** Boston Cinamateur Club (8mm and 16mm)—Fannie Tinkham, Sec'y, Cambridge Photographic Society, 631 Massachusetts Ave. Meet 2nd and 4th Mondays.
- HOLYOKE:** Prospect Movie Camera Club (8mm and 16mm)—Henry M. Bader, Sec'y, 19 Charles St. Meet 1st Monday each month.
- LOWELL:** Lowell Amateur Cinema Club—Leslie R. Lawson, Sec'y, 311 Westford St.
- LYNN:** Greater Lynn Camera Club, Movie Division—Max Hurwitz, Sec'y, 46 Central Square.
- PITTSFIELD:** Berkshire Museum Camera Club (8mm and 16mm)—A. C. Hindle, Sec'y, 19 North St. Meet 2nd Wednesday each month.
- SOUTHBRIDGE:** ★Southbridge Amateur Movie Makers Club (8mm and 16mm)—Joseph R. Seremet, Sec'y, 124 Highland St. Meet 2nd Friday each month.
- MICHIGAN**
- BATTLE CREEK:** Photographic Society of Battle Creek (8mm and 16mm)—Neil E. Elliott, Sec'y, 215 Fairfield Ave.
- DETROIT:** Detroit Society of Cinematographers (8mm and 16mm)—James A. Harris, Sec'y, c/o McGregor Library. Meet 4th Monday.
- FLINT:** Flint Amateur Movie Club—Lynn J. DePre, 2006 Mountain Ave. Meet 1st Wednesday each month.
- JACKSON:** Jackson Amateur 8mm Camera Club (8mm)—Lila O. Redinger, Sec'y, 1040 S. Jackson St. Meet 3rd Friday each month.
- KALAMAZOO:** Kalamazoo 8mm. Cinematographers—(8mm)—Grant Kinch, Pres., 806 S. Park. Meet 1st and 3rd Thursdays
- LANSING:** Capitol Camera Club (8mm and 16mm)—R. B. Gould, Sec'y, 1414 Corbett St. Meet 2nd Monday each month.
- LAPEER:** Lapeer Cinema Club (8mm and 16mm)—Peter Skeberdis, Sec'y, 1665 Imlay City Rd. Meet 3rd Tuesday of each month.
- PONTIAC:** ★Pontiac Amateur Cinematographers (8mm and 16mm)—Wilton J. Jones, 583 E. Tennyson. Meet 1st Monday each month.
- SAGINAW:** The Saginaw Movie Club (8mm and 16 mm)—Clarence R. Krueger, Sec'y, P. O. Box 671. Meet every other Thursday.
- MINNESOTA**
- AUSTIN:** Austin Camera Club (8mm and 16mm)—Lon Enochson, Sec'y, 205 N. 2nd St. Meet 2nd Tuesday each month.
- MINNEAPOLIS:** Minneapolis Octo-Cine Guild (8mm)—C. G. Crosby, Sec'y, 5617 12th Avenue S. Meet last Thursday each month.
- Minneapolis Cine Club (8mm and 16mm)—**Dr. Reinhold Ericson, Sec'y, c/o R. A. Riebeth, P. O. Box 22, Commerce Station, Minneapolis.
- Suburban Cine Club (8mm and 16mm)—**J. M. Devoy, Sec'y, 309 Blake Rd., Hopkins. Meet last Thursday.
- ST. PAUL:** Gopher Movie Club (8mm and 16mm)—Mrs. L. T. Thiets, Sec'y, 580 Wentworth. Meet last Friday each month.
- St. Paul Amateur Movie Makers (8mm and 16mm)—**Walter Gayman, Sec'y, 314 W. Kellogg Blvd. Meet 1st and 3rd Tuesday each month.
- Metropolitan Cine Club (8mm and 16mm)—**T. C. Hotchkiss, Sec'y, 303 S. Cleveland Ave. Meet 1st and 3rd Wednesdays.
- MISSOURI**
- KANSAS CITY:** The Heart of America Movie Club (8mm and 16mm)—Cooper Jenkins, Sec'y, 616 W. 26th St. Meet 1st Monday of each month.
- Kansas City Cinema Club (8mm and 16mm)—**E. P. Witte, Sec'y, 3125 Broadway. Meet 2nd and 4th Wednesdays each month.
- ST. JOSEPH:** St. Joseph Amateur Movie Camera Club (8mm and 16mm)—Ruthanna Beard, Sec'y, 610 E. Missouri Ave. Meet 2nd and 4th Wednesdays.
- ST. LOUIS:** Amateur Motion Picture Club of St. Louis (8mm and 16mm)—Miss Eloise Koch, Sec'y, 2738 Accomac St. Meet 2nd Wednesday each month.
- MONTANA**
- BILLINGS:** Billings Movie Club—Louis M. Moos, Sec'y, 311 Wyoming.
- NEW JERSEY**
- BAYONNE:** Bayonne Cine Club (8mm and 16mm)—Thos. A. Dolan, Sec'y, 232 Danforth Ave., Jersey City. Meet 2nd and 4th Fridays.
- CLIFTON:** Clifton Cinema Club (8mm and 16mm)—J. G. Elgersma, Sec'y, 43 Sears Pl.
- EAST ORANGE:** Cinema Club of the Oranges (8mm and 16mm)—Herbert A. Smith, Sec'y, 541 Main St. Meet 3rd Friday.
- MILLBURN:** Gibraltar 8mm Club (8mm)—M. H. Sanders, 85 Greenwood Dr.
- MAPLE SHADE:** The Wedgewood-Draper Club (8mm)—William Hoover, Sec'y. Meet 2nd and 4th Wednesdays.
- MAPLEWOOD:** The Maplewood Amateur Movie Club (8mm and 16mm)—Mrs. Fred W. Miller, Sec'y, 13 Rynda Rd.
- NUTLEY:** ★Cinema Club of North Essex (8mm and 16mm)—J. E. Nestell, Sec'y, 18 Shepard Pl. Meet 3rd Thursday each month.
- PASSAIC:** Passaic Y. M. C. A. Cinema Club.
- TRENTON:** Trenton Movie Makers (8mm and 16mm)—Jules Y. Shein, Sec'y, 521 S. Warren St. Meet either 1st or 2nd Friday each month.
- NEW YORK**
- BINGHAMTON:** Cinema Club of the Triple Cities—Edwin Moody, Sec'y.
- BRONX:** Bronx Amateur Cinema Club (8mm and 16mm)—Nicholas H. Zella, Sec'y, 384 E. 193rd St.
- BROOKLYN:** Brooklyn Amateur Cine Club—Irving Follock, Pres., 91-01 64th Rd., Rego Park, L. I. Meet every two weeks.
- BUFFALO:** Amateur Cinema Club of Buffalo—Edward C. Denny, Sec'y, 385 La Salle Ave.
- Niagara Cinema League (8mm and 16mm)—**K. N. Hadley, Sec'y, 103 Villa Ave. Meet 3rd Wednesday each month.
- ELMIRA:** Southern Tier Cinema Club (8mm and 16mm)—Wm. J. McCarthy, Sec'y, 504 Dewitt Ave. Meet last Friday each month.
- JOHNSON CITY:** I. B. M. Cinematographer's Club—W. M. Muir, Pres., R. D. No. 2.
- LONG ISLAND:** Queens Cine Club (8mm and 16mm)—Jack Jacoby, 103-17 125th St., Richmond Hills, L. I.
- MOUNT KISCO:** Mount Kisco Cinemats (16mm)—Robert F. Gowen, Sec'y, Chilmark Park, Assinng, N. Y. Meets 1st Monday of each month.
- MOUNT VERNON:** Mount Vernon Movie Makers (8mm and 16mm)—N. W. Knight, Sec'y, 258 Westchester Ave. Meet 3rd Tuesday.
- NEWBURGH:** Newburgh Amateur Cinema Club (8mm and 16mm)—Robert S. Kelly, Sec'y, 217 North St. Meet 2nd Thursday each month.
- NEW YORK CITY:** Metropolitan Motion Picture Club, Inc. (8mm and 16mm)—Robert M. Coles, Sec'y, 35 E. 20th St. Meet 2nd Thursday each month.
- Graphic Photo Guild—**1924 Washington Ave. Nat Rosenthal, Recording Sec'y.
- New York City 8mm Motion Picture Club—**Walter C. Mills, 35 Park View Rd., Bronxville. Meet 3rd Monday.
- Telephone Camera Club of Manhattan—**Thos. G. Herendeen, Room 1958, 195 Broadway.
- PEEKSKILL:** Peekskill Sport Center, Inc.—830 South St.
- ROCHESTER:** Rochester Amateur Movie Club (8mm and 16mm)—D. W. MacFarlane, Sec'y, 52 Edgemond Rd. Meet 1st and 3rd Thursdays each month.
- ROCKVILLE CENTER, LONG ISLAND:** Rockville Amateur Cinema Club.
- SCHENECTADY:** Schenectady Photographic Society, Cine Group (8mm and 16mm)—H. M. Webber, Sec'y, 1279 Dean St. Meet 1st Wednesday of each month.
- STATEN ISLAND:** Staten Island Cinema Club (8mm and 16mm)—Frank E. Gunnell, Sec'y, 34 Colonial Court, West New Brighton. Meet 2nd Tuesday each month.
- Staten Island Movie Makers (8mm and 16mm)—**Harry S. Wilson, Sec'y, 34 Rokeby Pl.
- VALLEY STREAM, LONG ISLAND:** Valley Stream Camera Club (8mm and 16mm)—John H. Trunk, Sec'y, 34 Cherry St. Meet 1st and 3rd Wednesdays each month.
- SYRACUSE:** Syracuse Amateur Movie Makers (8mm and 16mm)—Benjamin Franklin, Sec'y, 221 Marguerite Ave. Meet every other Monday.
- NORTH CAROLINA**
- MORGANTON:** Morganton Camera Club, Movie Division—Edw. H. Hairfield, Jr., Sec'y, Box 793.
- OHIO**
- AKRON:** Buckeye Camera Guild (8mm and 16mm)—W. G. Marksyty, Sec'y, 1080 Brown St. Meet every other Monday.
- CLEVELAND:** Aremac Club (8mm and 16mm)—L. C. Neuffer, Pres., Box 1719. Meet every 3rd Tuesday.
- Cine Hobbyist (8mm and 16mm)—**Harold Munny, 2709 Mayfield Road, Cleveland Heights. Meet every Friday night.
- Cleveland Amateur Cinematographers (8mm and 16mm)—**Miss Dorothy Boetticher, Sec'y, 1394 W. 3rd St., c/o Strong, Carliss & Hammond Co. Meet 1st and 3rd Wednesdays each month in Hotel Carter.
- COLUMBUS:** Columbus Movie Makers—Arthur Robinson, Sec'y, 34 N. 3rd St.
- DAYTON:** Cinema Research Club—F. H. Bickford, Jr., Chairman, 1529 S. Broadway.
- Dayton Cinema League—**P. C. Beach, Sec'y, 2240 E. 5th St.
- FINDLAY:** Findlay Camera Club—Ralph L. Stears, Sec'y, 208 Lark St.
- GALION:** Galion Camera Club (8mm and 16mm)—Mary Postance, Sec'y, 377 N. Market St. Meet 1st and 3rd Tuesdays each month.
- HAMILTON:** The Movie Makers Club—Clinton W. Bergen, Pres., 1269 Harmon Ave.
- MANSFIELD:** Mansfield Movie Club—Dr. L. B. McCullough, 78 Park Ave. W.
- MOUNDSVILLE:** Trojan Production Co.—Jacquelyn Rusen, Sec'y.
- MOUNT VERNON:** Mount Vernon Camera Club (8mm and 16mm)—Frank J. Van Vorhis, Sec'y, 306 N. Main St. Meet 1st and 3rd Tuesdays each month.
- NORTH CANTON:** North Canton Cinema Club (8mm and 16mm)—R. L. Wearstler, Sec'y, R. D. 6, E. Maple St. Ext. Meet 1st Friday each month.
- SPRINGFIELD:** Springfield Cinema Club—C. O. Harrison, Sec'y.
- TOLEDO:** The Toledo Cine Club (8mm and 16mm)—517 Madison Ave. H. Kline, Sec'y, 4613 Whiteford Rd. Meet 3rd and 4th Mondays.
- NEWARK:** YMCA Movie Makers (8mm and 16mm)—C. I. Grimm, Pres., Arcade Annex. Meet 1st and 3rd Wednesdays.
- WOOSTER:** Wooster Amateur Movie Makers (8mm and 16mm)—Howard W. Keister, Sec'y, 218 W. University St. Meet 3rd Monday each month.
- YOUNGSTOWN:** Youngstown Amateur Movie Club (8mm and 16mm)—Fred Deiter, Sec'y, 52 Wesley Ave. Meet 1st and 3rd Mondays.
- OKLAHOMA**
- NAWATA:** Nawata Cine Club—Audrey Albin, Sec'y, 514 N. Pine.
- OKLAHOMA CITY:** Cinemateur Club (8mm and 16mm)—H. P. Douglass, Sec'y, 1909 N. W. 27th. Meet 3rd Friday each month.
- Oklahoma City Movie Club—**Alex McDonald, Pres., 721 N. W. 29th St.
- TULSA:** Tulsa Am-Mo Club—J. B. Close, Pres., Box 854. Meet 1st and 3rd Wednesdays.
- OREGON**
- MEDFORD:** Medford Movie Club (16mm)—Mrs. George F. Tucker, Sec'y, 37 Kenwood Ave. Meet 3rd Saturday.
- NORTH BEND:** Coos Bay Camera Club (8mm and 16mm)—Ernest Rollins, General Delivery.
- Southern Oregon Cinema Club—**W. Bernard Roberts, Pres., 922 Reddy Ave.
- PORTLAND:** Portland Cine Club, Inc.—Arthur E. Gibbs, Sec'y, 324 S. W. Stark St. Meet every two weeks.
- PENNSYLVANIA**
- ALLENTOWN:** Allentown Y. M. C. A. Cinema Club—Aral M. Hollenbach, Sec'y, 1229 N. 19th St.
- Amateur Cinematographers of East McKeesport (8mm and 16mm)—**J. J. Carbaugh, 914 4th St., East McKeesport.
- LEBANON:** Lebanon Valley Camera Club (8mm and 16mm)—George Kline, Sec'y, 470 N. 4th St.
- NORRISTOWN:** Mrs. Mary Leonord, Sec'y (8mm and 16mm), 618 De Kalb St. Meet every 3rd Monday.
- PHILADELPHIA:** ★The 8-16 Movie Club—Louis Sobel, Sec'y, 4916 Ormes St.
- Philadelphia Cinema Club (8mm and 16mm)—**George A. Pittman, Sec'y, 1808 E. Tulpehocken St. Meet 2nd Tuesday each month.
- 8-8 Club (8mm)—**Mrs. Robert H. Connor, Sec'y, 6707 Linmore Ave. Meet 1st and 3rd Thursdays each month.
- PITTSBURGH:** Pittsburgh Amateur Cinema Club (8mm and 16mm)—Miss Rose Goldman, Sec'y, 319 Amher St. Meet 1st and 3rd Wednesday each month.
- North End Cinema Club (8mm and 16mm)—**R. C. Straka, Sec'y, 1711 Harpster St., N. W. Pittsburgh. Meet 1st and 3rd Tuesdays of each month.
- North Borough's Y.M.C.A.,** 629 Lincoln Ave., Bellevue.
- POTTSTOWN:** Pottstown 8mm Movie Club (8mm)—Wm. J. Weiss, Sec'y, 874 N. Charlotte St. Meet 1st Tuesday each month.
- READING:** Berks Camera Club (8mm and 16mm)—Stephen Lawrence, 310 N. 12th St. Meet every Monday night.
- SUNBURY:** Sunbury Amateur Cinema Club (8mm and 16mm)—David Lenker, Sec'y, 346 Chestnut St. Meet 1st and 3rd Mondays.
- SOUTH DAKOTA**
- SIOUX FALLS:** Sioux Falls Amateur Cine Club—(16mm and 8mm)—H. E. Hanson Harold's, 308 S. Phillips Ave. Meet 1st Monday each month.
- YANKTON:** Yankton Camera Club. Arthur J. Smith, Pres., 414 Capitol St.
- TENNESSEE**
- JACKSONVILLE:** Jacksonville Movie Makers, P. O. Box 56.
- MEMPHIS:** W. G. Snowden, Sec'y, Box 2073, DeSoto Sta.
- TEXAS**
- DALLAS:** Dallas Cine Club—Stan Everman, Pres., 1504 Young St.
- FORT WORTH:** Movie Makers Club (8mm and 16mm)—J. C. Duvall, Pres., 604 Burk-Burnett Bldg.
- UTAH**
- LOGAN:** Logan Amateur Cinema Club (8mm and 16mm)—Mrs. E. L. Hansen, Sec'y, Logan, Utah.
- SALT LAKE CITY:** Utah Amateur Movie Club (8mm and 16mm)—C. F. Solomon, Jr., Sec'y, 1471 Browning Ave. Meet 2nd Monday of each month.
- VIRGINIA**
- LYNCHBURG:** Hill City 8 Movie Club (8mm)—Nowlin Puckett, Corresponding Sec'y, 822 Floyd St. Meet once a month.
- NORFOLK:** Norfolk Amateur Movie Club (8mm and 16mm)—Claude D. McMillan, Jr., Sec'y, 720 Carolina Ave. Meets 3rd Tuesdays.
- WASHINGTON**
- SEATTLE:** Northwest Amateur Cinema League—Carlos E. Grant, 915 Green Bldg., Seattle Wash.
- Roosevelt Movie Club (16mm)—**Jayne Stokes, Sec'y, Roosevelt High School, 2032 Franklin Ave. Meet every other Wednesday.
- ★Seattle 8mm Club (8mm)—**W. B. Bowden, Sec'y, 546 Dexter Horton Bldg. Meet 2nd Tuesday each month.
- TACOMA:** Tacoma Cinema Club (16mm)—Don Flag, Sec'y, 829 S. Ferry St. Meet 4th Monday each month.
- WALLA WALLA:** Walla Walla Cinema Club (8mm and 16mm)—Cromie L. Wilson, Sec'y, 715 Catherine St. Meet 4th Monday.
- WENATCHEE:** Wenatchee Cine Club (8mm and 16mm)—Evelyn Shotwell, Sec'y, Box 920.
- YAKIMA:** Yakima Amateur Movie Club (8mm and 16mm)—William Hassell, Pres., 1208 W. Yakima Ave. Meet 4th Wednesday.
- Amateur Movie Club: Paul Thompson, Pres.,** 709 S. 4th St.
- WEST VIRGINIA**
- HUNTINGTON:** Huntington YMCA Amateur Movie Club (8mm and 16mm)—James Warfield, Sec'y, 629 6th St. Meet each 3rd Friday.
- TRIADELPHIA:** St. Vincent's Cinematic Club—E. Dietrich, Rt. 1, Box 93.
- WHEELING:** ★Cinematography Group of the Ohio Valley Camera Club (8mm and 16mm)—R. E. Dempster, 162 15th St. Meet every other Friday.
- WISCONSIN**
- FOND DU LAC:** Fond du Lac Camera Club (8mm and 16mm)—Miss Mildred E. Weber, Sec'y, 333 S. Marr St. Meet 4th Monday each month.
- MADISON:** Cine 8 Club—Ruth Hoffman, Sec'y, 535 W. Dayton St. Meet 1st Tuesday each month.
- Maple Bluff Camera Club—**John B. Casoday, Sec'y, 1005 Power & Light Bldg.
- MILWAUKEE:** The Amateur Movie Society of Milwaukee (8mm and 16mm)—Miss Pamelia M. Mills, Sec'y, 530 N. 20th St. Meet 2nd and 4th Wednesdays.
- City Club of Milwaukee (8mm and 16mm)—**E. H. Hallows, Chairman, 756 N. Milwaukee St. Meet 3rd Friday each month.
- Globe Movie Makers (8mm and 16mm)—**Paul Barkhauser, 413 E. Dean Road.
- Cream City Cinema Club—**E. R. Glaesner, Sec'y, 3730 W. Lisbon Ave.
- Milwaukee Movie Makers—**Harold Francke, Sec'y, 1926 E. Fernwood Ave.
- NEENAH:** The Winnebago Camera Club, Movie Division—Duane Raiche, Sec'y, 247 4th St.
- WINNEBAGO:** Oshkosh Cine Club (8mm and 16mm)—Edw. L. Fredrick, Sec'y, c/o Winnebago State Hospital. Meet 3rd Friday each month.



TITLE Backgrounds



By EDMUND TURNER



WOULD you like to receive a set of 25 HOME MOVIES Title Backgrounds absolutely free? For the best suggestion received from a reader during the month of October for a series of title backgrounds to be reproduced on this page, the editors will give a set of 25 backgrounds for either Kodachrome or black and white films.



With vacation and general summer filming nearing a close, the season approaches for the amateur to get his "home work" done—editing, titling, etc.—especially titling. HOME MOVIES has made the task of titling a great deal easier for the amateur by publishing a series of artistic title backgrounds each month, and by providing a simple method for lining up these titles with his camera by means of the title centering guides now being published each month in this magazine. For further data regarding this feature, turn to the page of Title Centering Guides in this issue.

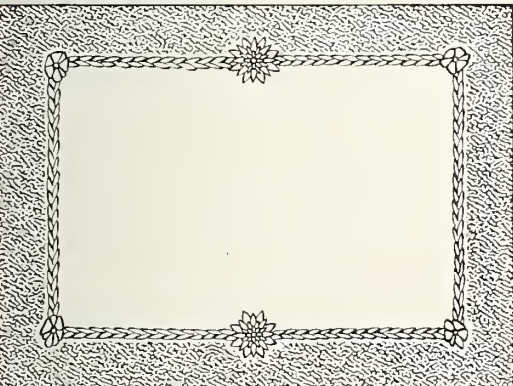

Quite consistently now we have published this page of title backgrounds, backed up by an advertising page that would permit cutting out the backgrounds without mutilating important editorial matter. Many amateurs now cut these backgrounds from the magazine each month and file them away in a small 3"x5" card file appropriately indexed according to the various classifications in which the titles might fall, such as Vacations, Baby Pictures, End Titles, etc.

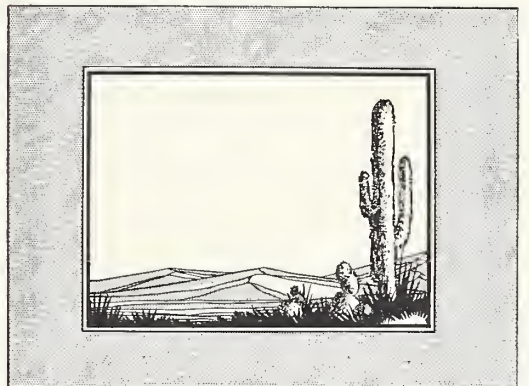

HOME MOVIES has available other title backgrounds printed on a good grade of paper and packaged in sets of 25 which sell for 50c per set. They are available for either black and white films or Kodachrome. In ordering, specify Set No. 1 for black and white, and Set No. 2 for Kodachrome. The titles in each set are the same, except that those for Kodachrome are printed in colored inks on colored stock.



CLASSIFIED

ADVERTISING

EQUIPMENT FOR SALE

• BASS SAYS. Our annual fall house-cleaning now in progress.

USED CAMERAS

DeVry 57, F:3.5 lens, \$19.50.
Cine Anso, 100 ft., 1" F:3.5 lens, \$22.50.
Cine B, 100 ft., F:3.5 lens, \$24.50.
Cine B, 100 ft., 1" F:1.9, \$47.50.
Filmo Magazine 121, Cooke F:2.7 lens, \$47.50.
Victor 3, Cooke 1" F:3.5, five speeds, latest model, \$47.50.
Super Speed Filmo 70, f:1.5 lens, \$75.00.
Victor Model 5, latest model, five speeds, reflex focuser, turret, 1" F:2.9 lens, \$105.00.
8mm Movikon, F:2 lens and case, \$137.50.
Filmo 70DA, like new, 1" F:3.5, 1" F:1.5, 3" F:3.3 Telephoto, \$225.00.
Filmo 70DA with 12-volt motor drive, two 200-ft., one 400-ft. magazines, three lenses, masks and mask slot, carrying case, \$1043.00 value; price, \$600.00.

PROFESSIONALS ATTENTION: Unusual values in Eyemo equipment. Write for full details.

NEW EQUIPMENT

The new RCA 16mm S. O. F. Model PG170, 750-watt projector, complete, \$300.00.
New Revere Double 8 Camera with 3.5 lens, \$29.50.
New Revere Double 8 Turret Camera with F:2.5, \$65.00.
New Revere Double 8 Model B Projector, 500-watt, \$59.50.

Send for new Revere literature.
Send for the new 84-page BASS CINE BARGAINGRAM—most complete book ever published.

BASS CAMERA COMPANY

Dept. HC 179 W. Madison St. Chicago, Ill.

• 1½" f:3.5 telephoto for Bell & Howell, \$33.50; for Keystone, \$27.50. Dallmeyer .099 lens, standard mount, \$39.50. 1½" f:2.8 Hugo Meyer telephoto for Bolex, \$45. 4" f:4.5 Cooke telephoto lens, \$45. 3" f:4 telephoto, Cooke, \$39.50. 2" f:1.9 Dallmeyer lens, \$49.50. These lenses as new. Eastman Model 60 f:1.9 lens, list \$67.50, as new, \$39.50. Bell-Howell Turret 8 with Wind-Bak, new condition, \$99.50. 16mm Bolex, f:1.4 lens, with special \$35 slot for filters and masks, carrying case, total list \$365, brand new condition, \$235. Full list price allowed for Eastman Model 20 toward a new Bell-Howell Sportster; for a Keystone f:3.5 or Eastman Model 20 on a Revere Turret; on a Model 50 toward an Ampro 8mm or Bell-Howell 8mm Projector. NEW MAGAZINE CINE EIGHT FOR IMMEDIATE DELIVERY. Full list price for your Model 20 or 25 Eastman, for Keystone f:3.5 or f:2.7, or for Bell-Howell Companion toward this camera. AS NEW: Bell-Howell Sportster with Wind-Bak, \$75. Bell-Howell Companion with Wind-Bak, \$49.50. Bell-Howell Turret with Wind-Bak, \$129.50. Eastman 16mm Magazine, f:1.9, \$75. 1" f:1.3 Laack Lens, \$39.50. 15mm f:1.5 Dallmeyer lens, \$49.50. 3" f:4 Wollensak, \$29.50. 30x40 beaded screen with tripod, \$7.95; 36x48, \$10.50; 39x52, \$12.50. Hundreds of other bargains. Write NATIONAL CAMERA EXCHANGE, established 1914, 11 So. 5th St., Minneapolis, Minn.

• BARGAINS — 70DA, Black, 1-2-3" F3.5 LENSES, FOCUSING MOUNTS, MAYFAIR CASE, \$145.00; 70A, F3.5 lens, \$29.50; CINE KODAK, 16mm, 50 ft. 1" F1.9, 3" F:4.5, CASE, \$62.50; STANDARD DE LUXE PROJECTOR, F1.6 LENS, 500 w., I. N., \$37.50; CRAIG EDITOR ONLY, 16mm, \$25.00; GRISWOLD 16mm Professional Splicer, \$12.50; DALLMEYER 1" F0.99 C. Mt., \$50.00. MANY OTHER BARGAINS. WRITE FOR BARGAIN BULLETIN No. 103. CAMERA MART, Dept. G, 70 West 45th St., New York.

• SLIGHTLY used, like new, 300-watt Keystone 8mm Projector, \$20.85. K-8 camera, like new, \$17.50. Telephoto lens for K-8 camera, f/1.5 1-inch, bargain, \$12.50. MALENA CO., 616 Market St., Philadelphia, Pa.

• FULL LIST price for your Cine f/3.5 cameras toward Eastman Magazine or Filmo Sportster, Model 60 Eastman, \$42.50. Filmo 70 with f/3.5 and case, \$32.50. Filmosound, like new, \$650.00, now—\$250.00. Better deal at FINNS, 118 S. Robert St., St. Paul, Minn.

• LOOK! Sacrifice for cash. Bell & Howell Sportster, f/3.5 with \$45.00 MacVan backwind and frame counter, compartment case, 9 Wratten filters, and filter holder—all for \$80.00. 1½" Bell & Howell f/3.5 telephoto for 8mm, perfect condition, \$25.00. R. E. BURRIS, State College Station, Fargo, N. D.

• VICTOR Sound Projector, Model 25, for A/C and D/C, 120-v., \$165.00. 24-B, 750-watt, \$210. NAVILIO, 1757 Bdwy., Brooklyn, N. Y.

• 16MM ENLARGER. Made by Eastman, with projector for lamphouse. Gives enlargement approximately 4x5 of your 16mm frame. Can also be used as viewer for editing. Originally sold for \$90.00. The first \$20.00 takes it. Perfect condition. Box RR, Home Movies Magazine, 6060 Sunset Blvd., Hollywood, Calif.

• PROJECTOR, combination 16mm and 8mm Ditmar. You can show either 16mm or 8mm pictures on this 500-watt projector. Switchover very simple. Original price more than \$200.00. For quick sale, \$125.00, A-1 condition. Box RT, Home Movies Magazine, 6060 Sunset Blvd., Hollywood, Calif.

• Ten cents per word; minimum charge, \$2.00 cash with order. Closing date, tenth of preceding month. • HOME MOVIES does not guarantee goods advertised.
• Send ads to 6060 Sunset Boulevard, Hollywood, California.

EQUIPMENT FOR SALE

• PAILLARD BOLEX Headquarters for the West is Morgan Camera Shop. Try the multi-featured Bolex 16mm or 8mm camera before buying. See them at 6262 Sunset Blvd., Hollywood, California.

• AMPRO PROJECTOR — Practically new, 16mm, 750-watt, pilot light, new bulb, fully reconditioned. Cost \$175, will sacrifice for \$95.00. Box 5, HOME MOVIES, 6060 Sunset Blvd., Hollywood, Calif.

EQUIPMENT FOR SALE

• MOVIE Cameras, Films, Projectors, etc., bought, sold, and exchanged. Big lists Free. Art samples, 25c. PEERLESS, Box 1310-H, Hollywood, Calif.

PROCESSING SERVICE

• MOTION PICTURE Processing—100' 16mm, 75c; 50' 16mm, 50c; 25' 8/8mm, 35c; 25' 8mm, 25c. Write for film price list. RITTER FILM SERVICE, 629 Lyman Ave., Oak Park, Ill.

ACCESSORIES

• NEW "Hot Spot" lamp by Hollywood Studio Cameraman (\$15.00 value), only \$6.95. Strong, completely controlled lighting. STURN, 828 N. Gardner, Hollywood, Calif.

• DEVELOP your own positive titles — Tint and Tone scenes in color — Reverse your own films with the new Hollywood Processing Outfit. Holds 34 feet double 8mm or 16mm film. Requires only 32 ozs. solution in any 8"x10" tray. Complete reel and stand, drying rack and stand, instructions, processing methods, formulas, and other valuable information—\$5.95. HOLLYWOOD CINE PRODUCTS CO., 3221 So. Figueroa St., Los Angeles, Calif.

• 146 ADULT film subjects. Lists, lens cleaner, 10c. Univex representatives wanted, towns under 5,000. Details, stamp. JENKINS, 392, Elmira, N. Y.

• 8mm and 16mm film, rent, sale, exchange, 25c. Equipment, all makes at substantial discounts. Trades accepted. Sound projectors, new and used. Terms. HOLMES — "Movies for Homes"—3030 Germantown Ave., Phila., Pa.

FILM RELEASES (8 and 16mm)

• 8mm EXCHANGE Library. Purchase first print, \$5.50. Monthly exchange privilege, \$1.00. Latest new releases. RIEDEL FILMS, 2221 West 67th St., Cleveland, Ohio.

• "ARTFILM" As You Like It! One thin dime brings big prepaid sample, catalogs, amazing GIFT offers! PARISIEN, 4228-D Lincoln, Chicago.

• LATEST 8-16mm War, Comedy, Travel, Unusual Subjects. Send 10c for sample and lists. A personal service. RIO, 413-H Elmira, N. Y.

• SOUND and Silent Films exchanged, bought, sold, rented. Bargains always. New Free lists. FRANK LANE, 5 Little Bldg., Boston, Mass.

• REAL "ART" Film. Send 10c today for generous prepaid sample; big illustrated catalogs included. CINEART, 4224-B Lincoln, Chicago.

• BEST NICKELODIONS — Chaplin, Lloyd, Arbuckle, Turpin, Bill Hart, "His-the-Villain" dramas. 16mm, \$6.50, new. IRVING K. MEGINNIS, "Megifilms," 340-M 29th St., New York.

• FILMS—Latest Subjects Silent, Sound. Sold, exchanged. Films rented everywhere. Bargains in equipment. Trades accepted. Free illustrated catalog (with sample Art, 10c). GARDEN FILM, 317 West 50th, New York.

• RENT—8mm-16mm programs, 7 rolls, \$2.00 Free catalog (with sample Art film, 10c). PARKWAY EXCHANGE, 1040 Parkway, Brooklyn.

• WRITE FOR our new 8mm rental catalog. Films shipped everywhere. No extra charge for shipping. We pay both ways, express or parcel post. ABBE FILMS, 1265 Broadway, New York City.

• "THE PLEDGE of Allegiance to Our Flag" —Shows wording on moving, patriotic backgrounds. Dollar bill brings this timely, educational (8mm-16mm) film postpaid. Sample strip, 10c. Titles . . . Duplication . . . Processing . . . Films. ORBIT FILMS, 1157 No. McCadden, Hollywood, Calif.

FILM

• SPECIAL! 100' 16mm Weston-16 film, \$3.40 processed. Also 8mm, 16mm film bulk. Cameras, Projectors, Accessories, Castle Films library. Write your wants. R. C. CAMERA & PHOTO SUPPLY CO., 3357 E. 66 St., Cleveland, Ohio.

TITLING SERVICE

• SUNBEAM Kodachrome titles, 8 and 16mm. Professional, glowing colors. Sample Free! W. C. KANE, 102 Gibbs St., Rochester, N. Y.

WANTED

• 16mm FILMO D-A camera and Filmomaster projector. Will trade Keystone equipment. RICHARD DIRKSE, R. No. 5, Holland, Mich.

• WANTED—Cine Special or 70DA with crank, etc., or RCA Newsreel SOF Camera; also 8mm projector and late model 16mm sound projector. Must be perfect working condition and extremely cheap for cash. P. O. Box 2109, Tucson, Ariz.

• WANTED—Used 8mm film subjects in good condition. Send lists, lengths, and 3c stamp. No dealers. Box 392, Elmira, N. Y.

EXCHANGE OR TRADE

• TRADE—Conn Eb Alto Saxophone and case, used very little, good condition, for good candid camera or telephoto lens for 8mm Filmo Sportster. RONALD McDONALD, Star Route, Omak, Wash.

CAMERAS AND PHOTO SUPPLIES

• MAKE money in photography. Learn quickly at home. Easy plan. Previous experience unnecessary. Common school education sufficient. Interesting booklet and requirements free. AMERICAN SCHOOL OF PHOTOGRAPHY, 3601 Michigan Avenue, Dept. 263C, Chicago.

HOME MOVIE GADGETS

Ready . . . NOVEMBER 1st!

A new book containing over 100 illustrations and descriptions of handy gadgets any amateur can build for special effects, titling, lighting, photography, etc.

PRICE \$1.00 COPY



Reserve Your Copy Today!

VER HALEN PUBLICATIONS

6060 Sunset Boulevard

Hollywood, Calif.

WHEN YOU BUY THEM SEPARATELY

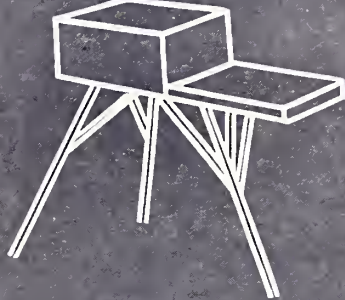
 +
 
 +
 
 +
 
 = \$145.95

KODASCOPE G **2" f/1.6 LENS** **750 WATT LAMP** **PROJECTO CASE**
\$100 **\$18** **\$5.45** **\$22.50**

But... when you buy them as a complete outfit, the total cost is exactly **\$137.50**

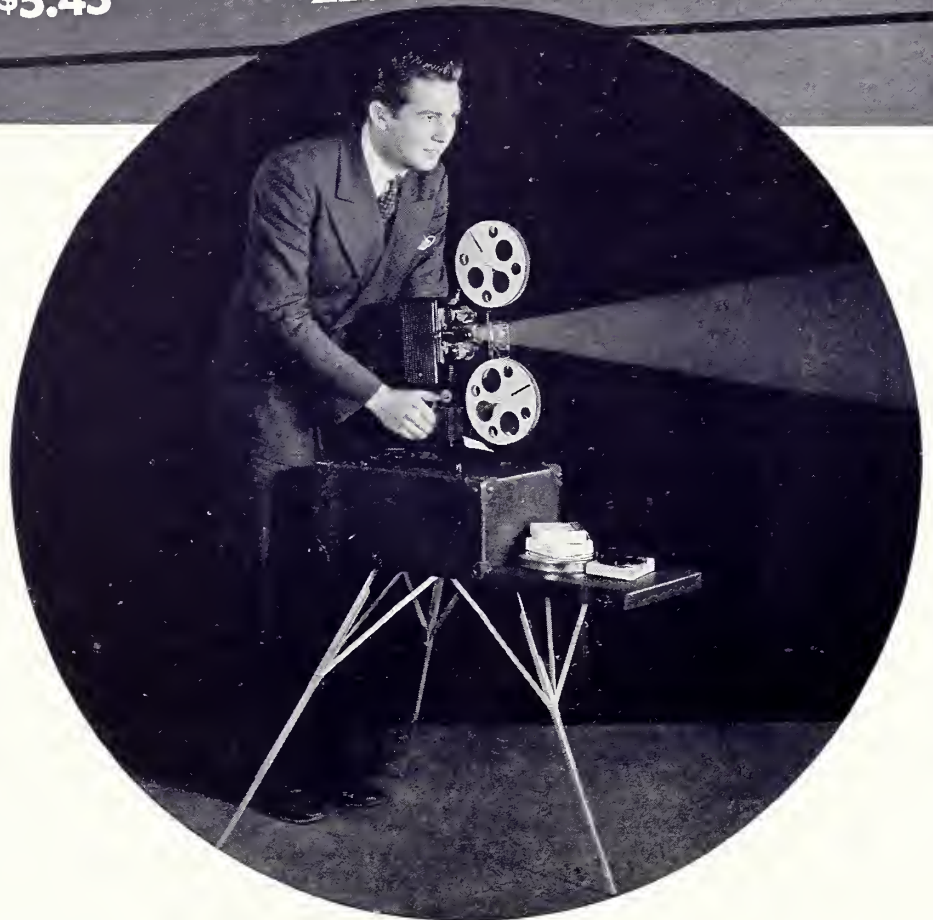

IT'S PROBABLE that you'd acquire this outfit, piece by piece, before very long. Probable...and natural, for every movie maker knows how really good every bit of it is.

Now there's an added reason for getting the whole business at once—a money-saving price of \$137.50 for all four.

Kodascope Model G is the new ruling favorite among 16 mm. projectors. It's so easy to use, so "professional" in its quiet efficiency. At its regular price of \$100, without lens or lamp, it is an excellent value. Under this combination offer, the value is even higher.

Of the six lenses available for Model G, the 2-inch f/1.6 is undoubtedly the favorite average-use lens. It gives you a screen image 26" by 34" at 15 feet, 42" by 56" at 25 feet.

And the 750-watt lamp is, of course, rich in bril-

liance. You need never fear that your screened movies will have that anemic, washed-out look; they'll be full-bodied, vivid.

And the Projecto Case is a hit. It becomes a three-legged projection stand, sturdy and thoroughly convenient. All closed up it is simply a handsome, compact carrying case.

Get all four...and save money. Your dealer is authorized to extend this saving to his customers.

**EASTMAN KODAK
COMPANY
ROCHESTER, N. Y.**

*Will You Choose This 8-
or Wish You Had?*



FILMO TURRET 8

Quick, easy loading...no sprockets to thread...no loops to form



The only 8 mm. motion picture camera that has all of the features you are sure to want as your skill increases

BEFORE you choose an 8 mm. motion picture camera, remember that *only* the Filmo Turret 8 provides *all* of the features you are sure to want now or later. Good judgment suggests, therefore, choosing the camera your *advancing skill will not outgrow.*

Step into your camera dealer's store and give the Filmo Turret 8 the most critical inspection you ever gave any important purchase. Compare its workmanship and features with any other 8 mm. camera.

You'll see why Filmo Turret 8 is the "aristocrat of the 8's." It combines the economy of 8 mm. film with the instant readiness and amazing versatility of a newsreel man's camera. *Three lenses and their matching viewfinders* are mounted on the turret.

The correct lens and its viewfinder are *both* placed in position by simply revolving the turret. *Seven* fine color-corrected Taylor-Hobson and Bell & Howell lenses are available for this camera. Its positive-type viewfinder eliminates errors in composition. Its magnifying critical focuser shows the entire frame through the lens. Four speeds, including slow motion... single frame exposure... automatic reset film footage dial... built-in exposure calculator... and other features.

With one lens—Taylor-Hobson 12½ mm. F 2.5\$140
With provision for film wind-back for making lap dissolves and double exposures.....\$172



Yes! You Can Trade Your
Camera In on a New
Filmo Auto Master
WITH TURRET HEAD

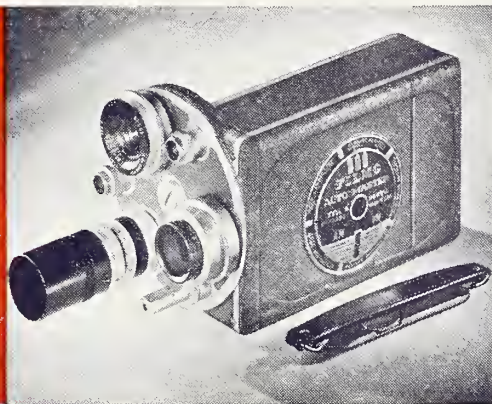

—the only 16 mm. magazine-loading motion picture camera with a Turret Head

IF YOU want the "ace" of 16 mm. motion picture cameras—now is the time to get it. Trade your old camera in on the new *Filmo Auto Master*. Then you'll own a camera that you'll never outgrow. Then you'll be master of every movie opportunity.

Loading can be done in three seconds—even while wearing gloves. The pre-threaded film magazine slides into place. A turret head mounts three lenses *and* their matching viewfinders. When the desired lens is placed into position by rotating the turret, its viewfinder is also positioned.

A positive-type viewfinder, enclosed and protected, provides exceedingly brilliant image—and *what you see, you get.* A built-in exposure chart gives readings at a single setting for both color

and black-and-white film. Four speeds, including slow motion... single frame exposure... full range of special-purpose lenses... steady-strap handle that swings camera into instant action—and every other advanced feature you find only in a camera precision-built by the makers of Hollywood's professional equipment. See it at your dealer's—or mail coupon for information. Bell & Howell Company, Chicago; New York; Hollywood; London. *Established 1907.*

Filmo Auto Master, with film speeds of 16, 32, 48, and 64, steady-strap handle, and Taylor-Hobson 1" F 2.7 universal focus lens\$195

Available on special order with speed range of 8, 16, 24, 32 at slight additional cost.

New FILMOTION Viewer for 8 mm. and 16 mm. Film (a Model for Each)

When you edit your films with this new Bell & Howell Filmotion Viewer, you see them as *motion pictures* rather than as a series of stills. Obviously, then, you can do a much more professional job of editing. And don't forget that *this* viewer provides *complete protection* to those priceless films that you could not replace in case of damage. By attaching B&H 136 Splicer and proper rewinders for your size film, you have a complete editing outfit. Viewer and splicer may be purchased complete as shown here—or you may detach your B&H 136 Splicer from its present base and mount it on the new base.

HEAVY-DUTY 2-SPEED REWINDERS (for 16 mm. Film)

Gear shift lever provides three positions—low speed, 1-to-1 ratio, for editing; neutral, to free the spindle; high speed, 4-to-1 ratio, for fast rewinding. Manual brake, conveniently placed, permits tight rewinding and safe control of even the heaviest reels. This new equipment fits into combinations with the present B&H line of film editing equipment. Mail coupon for circular.

B&H FILM CLEANER. For use with both Filmotion Viewers (8 mm. and 16 mm. sizes). This film cleaner is equipped with a special bracket which fits on the Filmotion Viewer for cleaning films while rewinding.

PRECISION-MADE BY

Bell & Howell

BELL & HOWELL COMPANY HM 10-40
1825 Larchmont Ave., Chicago, Ill.
Send me detailed information about ()
Filmo Turret 8; () Filmo Auto Master;
() New Filmotion Viewer and Splicer;
() B&H Film Cleaner; () Heavy-duty Re-
winders.

Name.....
Address.....
City.....State.....

Price 25c

HOME MOVIES



C. E. Bell Photo

November . 1940

LARGEST CIRCULATION OF ANY AMATEUR MOVIE MAGAZINE!



**"DON'T TAKE MY WORD FOR IT!
ASK ANY OF THE THOUSANDS OF
FANS SHOWING
HOME MOVIES**

**WHY THEIR 'PROGRAMS' ARE NOW
BEING ACCLAIMED AS THE FINEST
IN HOME MOVIE ENTERTAINMENT!"**

"Bella" Laughs! Thrilling Action! Drama! Anything and everything you desire to "round out" your programs, will be found in HOME MOVIES! Hundreds of entertaining and educational subjects in 8mm and 16mm widths . . . all designed to give your programs that added punch and audience-appeal. Screen them and then listen to your friends "rave"!

HERE'S ONE REASON!

WALTER LANTZ PRODUCTIONS PRESENT

OSWALD RABBIT



Your 'Program' Needs Him!

Oswald, the funny little rabbit, who is ever popular with young and old alike. His adventures are screened in 57 16mm subjects and 43 8mm films—every foot packed with laughs.

25-foot	8mm and 16mm	\$.75
50-foot	8mm and 16mm	1.50
100-foot	16mm only	3.00

Entirely NEW SERIES!

**MICKEY MOUSE and
DONALD DUCK**

The new series has swept the country by storm! For the first time in the history of MICKEY MOUSE and DONALD DUCK HOME MOVIES, you can now screen these lovable Disney characters in 200-foot 16mm and 100-foot 8mm complete subjects. Every film tells a complete story!

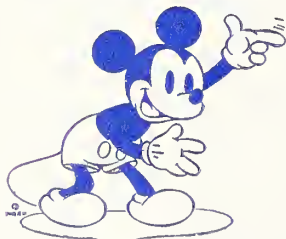

8mm-16mm	
25-foot	.. \$.75
50-foot	.. 1.50
100-foot	.. 3.00
200-foot	(16mm only) 7.50

**CHRISTIE COMEDIES!
WESTERN DRAMAS!
TRAVELS - SCENICS!
CHARLIE CHAPLIN!**

Christies and Chaplins for humor . . . Westerns for fast-action drama . . . Travels and Scenics for interesting insights into countries abroad which are playing important roles in the European theatre of war. These and many other subjects are available in 8mm and 16mm widths, from 25-foot lengths up to feature-length sound-on-film productions.

HERE'S ANOTHER!

WALTER LANTZ PRODUCTIONS PRESENT

THE THREE MONKEYS

MEANY, MINY & MOE



The "human" antics of Meany, Miny and Moe are bound to delight your audience. With 49 subjects available in 16mm and 39 in 8mm, their capers will add that "extra something" to your programs.

25-foot	8mm and 16mm	\$.75
50-foot	8mm and 16mm	1.50
100-foot	16mm only	3.00

DON'T DELAY! WRITE FOR FREE CATALOG TODAY!

SEEMANNS, INC., 6628 Santa Monica Blvd., Hollywood
EXCLUSIVE WORLD-WIDE DISTRIBUTORS
FOR

HOLLYWOOD FILM ENTERPRISES, INC.
SUNSET BLVD. • • HOLLYWOOD, CALIF

THE NEW G-E METER

It's the Perfect
 Gift for the Man who
TAKES and then MAKES
 his own
 Pictures



IF he's a camera fan, give him something he will use from the initial exposure to the finished print—something that will definitely contribute to the further success of his hobby. Give him a new G-E exposure meter.

He Will Use it for Taking Pictures

The new G-E meter is geared for three ranges of light—low, medium, and high. This is particularly helpful in tricky winter lighting. The G-E meter gives readings in brightness as low as .05 candle per square foot. Lots lower than you need for those winter night shots. It gives exposure data way up to 1700 candles per square foot—ample range to get glistening snow scenes without going off scale. And on dull, dark days those medium light readings will spread out over the entire scale. No guess-work. No fractional numbers to calculate.

And it's Extremely Accurate for Making Pictures

PRINTING: By measuring light transmitted through the negatives, the G-E meter helps select the proper grade of paper and determine the correct printing time. It's easy to duplicate prints exactly!

ENLARGING: Light values with the G-E meter put enlarging on a precision basis. Test strips and guessing are out.

COLOR WORK: Realistic color prints require properly balanced separation negatives. He can incorporate the sensitive G-E exposure meter in a densitometer or use it with a fixed light source and obtain accurate control of this process.

Ask your dealer to demonstrate the new G-E meter to you. You will be convinced it's the ideal gift for the man who *takes* and *makes* his own pictures. General Electric, Schenectady, N. Y.

GENERAL  ELECTRIC

Wollensak means Good Lenses



AN excellent example of a creative photographer's work is this shot, "Going Home," by Walter S. Meyers, associate of the Royal Photographic Society and a member of the Photographic Society of America. Exposed in a Guatemala

street, the whole 35mm negative shows background which detracts from the picture. Artistic cropping produced this atmospheric masterpiece. The lens—an $f4.5$ 2" Wollensak Enlarging Velostigmat. Mr. Meyers has used Wollensak lenses for still and cine work for over a quarter of a century. Improve *your* photography with a Wollensak.

For Movies, Candid, Enlarging, Action, Stills

WOLLENSAK OPTICAL CO., ROCHESTER, N.Y.

OCT 30 1940



★ Shot of the Month...

ADVISORY EDITORS

A. K. BAUMGARDNER

Peoria Cinema Club

BEZEK

Chicago Cinema Club

MES BIALSON

Amateur Motion Picture Club of St. Louis

ROSS BROWN

Dallas Cinema Club

GEORGE BURNWOOD

The 8-16 Movie Club, Philadelphia, Pa.

DE W. A. CADARETTE

Los Angeles 8mm Club

PERSON CLYMA

Detroit Society of Cinematographers

WILL A. DIXON

Pittsburgh Amateur Cinema Club

DYORAK

Suburban Amateur Movie Club

ALBERT E. GIBBS

Portland Cine Club

M. HOOK

Seattle 8mm Club

EDWARD F. KAUFMAN

Indianapolis Amateur Movie Club

W. H. MESTELL

Cinemen Club

JEANETTE A. PELLETIER

Toronto Amateur Movie Club

ALBERT B. PETERSON

Metropolitan Cine Club

ELIZABETH RIEBETH

Minneapolis Cine Club

EDWARD O. ROTH

Sherman Clay Movie Club

FRANK M. MOUNTREE

Bay Empire 8mm Movie Club

ALBERT L. SNYDER

Norfolk Amateur Movie Club

EDWARD E. SNYDER

Des Moines Y.M.C.A. Movie Club

W. H. BISSEL

Austin Movie Club

EDWARD HENION SMITH

Metro Movie Club of Chicago

home MOVIES

Copyright 1940 by Ver Halen Publications. No part of magazine may be reprinted without specific permission.

CONTENTS FOR NOVEMBER, 1940

THE READER SPEAKS..... 520

INFORMATION PLEASE 522

BACKYARD MOVIES 524

WITH THE PRO-16'S..... *By Ray Fernstrom, A.S.C.* 526

AVALANCHE OF MEMBERSHIPS SWELLS RANKS OF REEL FELLOWS.. 529

HERE'S TITLE TRICK THAT WON 1940 AWARD. *By Jack Irwin* 530

THE LOWDOWN ON CONTINUITY..... *By Geo. W. Cushman* 531

THIRD SEQUENCE CONCLUDES ANIMATED CARTOON SERIES
By Walter W. Light 532

COMPLETING ASSEMBLY OF THE "GLORIFIED SIXTEEN"
By Arthur H. Hart 534

IS YOURS A WHERE, WHAT, OR A WHO PICTURE?.. *By S. J. Williams* 536

AT LAST — SUCCESSFUL SOUND FOR 8MM AND 16MM MOVIES!
By Curtis Randall 537

FILMS, LIKE RARE VOLUMES, SOUGHT BY COLLECTORS
By Fred Grosse 538

FIVE FACTORS OF SUCCESSFUL CINEPHOTOGRAPHY
By Dr. A. K. Baumgardner 539

SEVENTEEN CINE CLUBS STAGE BIG "GET ACQUAINTED" FUNFEST
By Warren Garin 540

MOVIE OF THE MONTH..... *By J. H. Schoen* 541

TITLE CENTERING GUIDES 542

TELL ME, HOW CAN I IMPROVE MY FILM?..... 543

EXPERIMENTAL CINE WORKSHOP 544

IT'S NEW TO ME..... *By Cinebug Shopper* 546

EXPOSURE METER GUIDE..... 550

ANIMATED TITLE BACKGROUNDS..... 563

★ Shot of the Month — By Jack Treacy. A fine study of unique camera angle and of effect to be obtained with use of red filter.

CHAS. J. Ver HALEN
PUBLISHER

C. J. Ver HALEN, JR.
ASSOCIATE PUBLISHER

ARTHUR E. GAVIN
EDITOR

OFFICE OF PUBLICATION
6060 Sunset Boulevard, Los Angeles, Calif.
Phone GRanite 5149

NEW YORK OFFICE
Everett Gellert, 62 West 45th Street
Vanderbilt 6-5254

CHICAGO OFFICE
C. N. Burris, 712 Wrigley Building
Whitehall 7784

RAY FERNSTROM
Technical Editor

GEORGE W. CUSHMAN

J. H. SCHOEN
Associate Editors

COUNT H. von SCHOENFELDT
Photographic Editor

C. E. BELL
Associate Photo Editor

L. C. BUSCHER
Art Director

Second-Class Matter, May 6, 1938, at
Post Office at Los Angeles, Calif., under the Act
of March 3, 1879.
Subscription rates: U. S. \$2.00 per year. Canada
and Foreign Countries, \$3.00 per year. Single copies
5c. Canadian and Foreign single copies 35c. Copy-
right, by Ver Halen Publications. Advertising
rates on application.

CRAIG EDITING EQUIPMENT

A GIFT FOR THE *Entire Family*
ENJOYED THE *Entire* YEAR



8mm PROJECTO-EDITOR—FOR ACTION EDITING

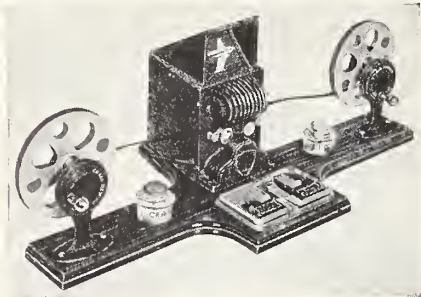

the Hollywood Studio Way

For *Action-Editing* the Hollywood Studio way—a smoothly animated viewing device allowing careful inspection, slow motion if desired, of actual movement on its brilliant miniature screen.

The 8mm model, as illustrated at left, complete with 8mm Junior Splicer and Rewind combination . . . mounted on a hardwood base with a bottle of Craig Safety Film Cement, \$27.50. 8mm Projecto-Editor alone, \$22.50.

CRAIG 16mm SENIOR SPLICER

A professional type dry splicer—for sound or silent film. Its unique design, combined with precision machining and sturdy construction, has made this the outstanding splicer for the amateur. Only 4 easy operations to make perfect, straight splices . . . quickly . . . accurately . . . and without wetting the film. For Sound or Silent Film . . . \$10.00.

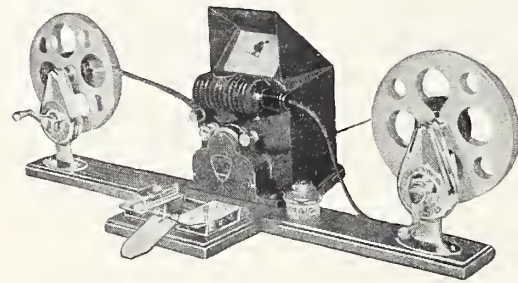
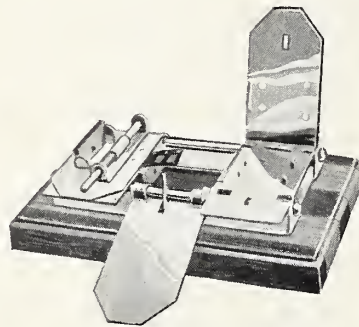

Craig 16mm PROJECTO-EDITOR

Incorporates the same famous "Action-Editing" principle as the 8mm model. Complete with Senior Splicer and Rewind Combination, Safety Film Cement and Hardwood Base . . . \$49.50. Projecto-Editor unit alone . . . \$35.00.

★ It takes proper *Editing* to make modern fast-moving, interest-sustaining movies. Through the careful selection of desired scenes, their rearrangement into proper sequence and the insertion of titles—many random shots can be transformed into smooth-running sequences that everyone will enjoy seeing.

Your entire family will derive increased enjoyment from your home movies when they are edited with *Craig Editing Equipment*. For utmost satisfaction, insist on CRAIG—there is no finer gift.

Ask Your Dealer or Write for New, Free Folder

Craig Senior Rewinds
\$4.50 each or \$9.00 the pair

Craig Junior Splicer
8 or 16 mm., \$2.50

Craig Junior Combination
Complete, \$7.25

Craig 16mm. Senior Splicer
For sound or silent, \$10.00

Craig Senior Combination
Complete, \$19.50

CRAIG "Makes Editing a Pleasure"

CRAIG MOVIE SUPPLY CO.
1053 S. OLIVE ST. • LOS ANGELES, CALIF.

The Reader



SPEAKS

Gone Domestic!

Isn't this just like a woman?

Gentlemen: Here's one for the books! Arriving home from work yesterday, I found my camera tripod set up in the middle of the kitchen floor. Suspended by a cord from the tripod screw was a cloth bag stained a bright red and oozing a claret-like liquid into a cooking utensil below. You guessed it—my wife was making jelly and using my nice new tripod to suspend the jelly bag! Said she read about the idea in one of those home and garden magazines. There ought to be a law!

—Charles Dana,
Denver, Colo.

Title Card Areas

How do the rest of you readers feel about this? If the size of the title backgrounds, published each month, do not fit your typewriter titlers, we want to correct the fault at once. We'll appreciate other comments on this question.

Dear Sirs: When you increased the size of HOME MOVIES to its present dimensions, you began publishing the monthly layout of title backgrounds about 1/4 inch smaller all around.

Recently, you have been putting an inner frame on these titles, making them un-usable to me and, I am sure, to other readers as well. When next month's titles are made, make them as they have been made, but leave the inner frame completely out. Then I can use them in my small titler.

—Sterling Boggess, Jr.,
Lawrenceburg, Ky.

8mm Fan

We're ever on the alert for news of practical amateur made gadgets and conversions of 8mm and 16mm cine cameras, and just as soon as we learn of a simple amateur application of a

windback for a Keystone 8, we'll publish it.

Gentlemen: Congratulations on your article in the July issue about the Keystone 8 Turret! This looks like a real job and I intend to build one after altering the design to take three lenses instead of two. Now give us the dope on a windback for the Keystone 8 and we'll be all set!

—R. S. Holmberg,
Hermosa, S. D.

Opportunity To Aid

Perhaps there are a number of champions for the "Showing for Shut-ins" movement who may be able to cooperate with this reader in supplying films he desires for his "shut-in" exhibitions.

Gentlemen: I have noted with interest your movement for "Showings for Shut-ins." Would it be possible for me to obtain, without charge, the loan of some sport reels or travel films? Do you know of anyone who would be kind enough to lend me such films if I pay transportation both ways? You see, we are also shut-ins—staying at a sanitarium—and have no chance to see current sport or travel movies. I own an 8mm Keystone projector, model M-8. I guarantee to take good care of the films and return same promptly.

I used to rent films from several firms in New York City, but my budget won't allow me to continue this. I have been staying here at the sanitarium two years.

—Fiete Van Der Veen,
Murray Hill,
Mt. Morris, N. Y.

Wants and Swaps

Here's opportunity to furnish a brother cinebug with needed footage or to exchange film:

Gentlemen: I would like to communicate with any amateur who could supply me with approximately 50 feet of 16mm Kodachrome consisting of scenes of big

• Continued on Page 560

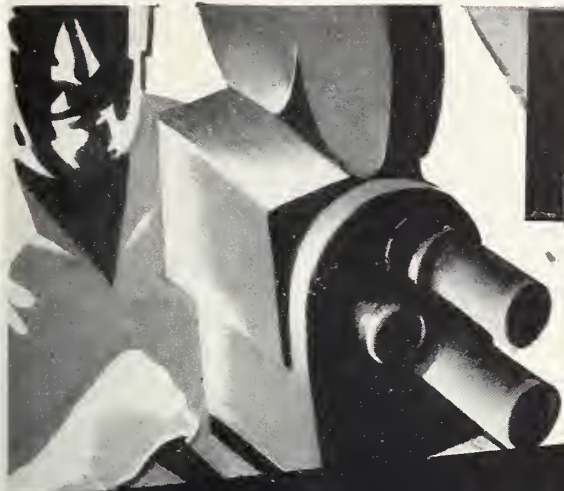

READY NOW!

YOU CAN OWN 1940's BIGGEST HEADLINES FOR YOUR HOME-MOVIE PROJECTOR

CASTLE FILMS

NEWS PARADE OF THE YEAR

16 · MM · 8

A world aflame . . . a world torn asunder is recorded for all to see in this only authentic and complete home-movie review of twelve months of shattering change. Castle Films' "News Parade of the Year" preserves for all time the mounting pace of events, month by month, through the world's most tragic year!

- ★ PANORAMA EUROPE'S TOTAL WAR! BRITAIN'S STAND!
- ★ U. S. ELECTS PRESIDENT!
- ★ AMERICAN DEFENSE STARTS!
- ★ BRITAIN GETS U. S. DESTROYERS!
- ★ AMERICA'S YOUTH PREPARES FOR WAR!
- ★ MEN OF THE YEAR!

Other Historic Events That Made 1940 History!

Castle Films' 16 mm. prints are VapOrated for protection. 8 mm. prints are also processed.

At less than the cost of unexposed movie film, you can own this living, moving record of momentous world history, filmed as it happened . . . a priceless chronicle for the years to come!

Get your copy now. Send this handy order form to your Photo Dealer today!

Please send Castle Films' NEWS PARADE OF THE YEAR in the size and edition checked below.

16 mm SIZE	
Headline 100 Feet	\$2.75
Complete 360 Feet	\$8.75
Sound 350 Feet	\$17.50
8 mm SIZE	
Headline 50 Feet	\$1.75
Complete 180 Feet	\$5.50

Name _____

Address _____

City _____

State _____

(B-11)

CASTLE FILMS

30 ROCKEFELLER PLAZA
NEW YORK

FIELD BUILDING
CHICAGO

RUSS BUILDING
SAN FRANCISCO



Use these
VICTOR
Photoflood Lighting Units
FOR BRILLIANT-COLOR FILMING

The Victor "620" For No. 2 Floods \$6.95

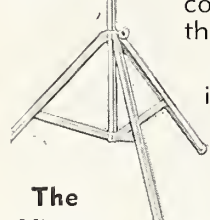

The Victor "250"



\$2.65

YOU'LL get more effective light for indoor filming when you use VICTOR clamp-on or stand lighting units. Correct reflector shapes, with the most effective reflecting surfaces, spun from substantial gauge aluminum, and mounts that provide unlimited directional control, make VICTOR Photographic Lights the choice of experts everywhere.

We publish a 24-panel folder which illustrates and describes more than 35 VICTOR Units, priced from \$1.00 up. It also gives you suggestions for lighting arrangements and provides an exposure guide. The coupon below pasted on a penny post-card will bring it to you without cost. Mail it TODAY.

The Victor Units shown here are recommended for lighting subjects for color filming. At the prices quoted, we are sure you can find nothing better in Photographic Lights.

See These at Your Dealer's

or MAIL THE COUPON

The Victor "41" For No. 4 Floods \$9.75

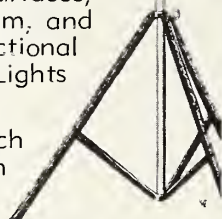

JAMES H. SMITH & SONS CORP.
1100 Lake Street, Griffith, Indiana

Send me your 66th Year Folder describing the VICTOR Photographic Lights suitable for indoor movie making.

NAME.....
ADDRESS.....
CITY..... STATE.....

For Professional Fades, Wipes, and Vignettes!

SCREW-IN ADAPTER TO FIT ALL LENSES

Universal BAIA CINE-TRANSITO, Jr.

In movies, a transition is the change from one scene to another. With the CINE-TRANSITO, Jr., you can make smooth transitions which were formerly confined to the professional screen. Small, compact, light. Easy to operate, efficient, and ever-ready!

Complete with cable release, fade disc, wipe disc, vignetter, and lens adapter. **\$14.85**

Timed and operated by clockwork mechanism.

See Your Dealer or order direct from:

AMERICAN BOLEX COMPANY
155 EAST 44th ST., NEW YORK CITY

HAILED!

FROM
COAST TO COAST

H Eye appeal... sales appeal... are the keynote features of the new Hollywood Tripod. For real camera enjoyment the Hollywood All-Metal Tubular Tripod and Head offers unequalled features in design and operation. Extremely light, rigid and compact the complete unit weighs only 3 3/4 lbs., yet can easily support 180 lb. man. All metal tubular construction gives this tripod a very high tensile strength. Legs are of beautiful satin finished tubular aircraft material. Entire tripod corrosion and tarnish resistance treated. Head and controls are chromium-plated. Customers everywhere are singing the praises of this fine new tripod, order your supply today.

PREMIERE MODEL

- Premiere Model \$15.75 Complete with Head
- Tripod only \$11.25
- Head only 6.25
- Carrying Case 4.25

For literature and further details see your regular distributor or write:

R. J. PAGLIUSO MFG. CO.
1000 E. Mountain Street
Glendale California

HOLLYWOOD TRIPOD
R. J. PAGLIUSO MFG. COMPANY

Information PLEASE

Chemical Exposure (J. R. Watson, Kansas City, Mo.)
In home processing, I rack my films in three layers on flat racks and therefore cannot use light for my second exposure. What chemical can I use instead?

While the use of chemicals in place of light for the second exposure is not usually advisable, some conditions may require it. Chemicals, as a rule, will not give as satisfactory result as light. The chemical to use is stannous chloride — about 8 ounces to 20 gallons of water. Immerse film in this solution 4 to 5 minutes, then wash. Strength of chemical is quickly dissipated and therefore the solution is not good for any great length of time.

Film Storage (H. A. Lamoureux, Los Angeles)
What is the best method for storing cine films? How would an old wooden ice box do? Should I plug the drain or leave it open?

For black and white film, use the regular humidor cans and moisten the humidifying pads with water or one of the humidifying solutions now on the market. Care must be taken not to moisten pad too much. Usually a half-teaspoonful of water or solution is adequate. Films should always be stored in a cool place where temperatures range between 65 and 72 degrees. This is applicable particularly to color films. Where it is possible to control room humidity, same should be maintained at approximately 50 per cent for color films.

The ice box mentioned will be satisfactory for storage if the above conditions can be maintained. To leave drain open would tend to circulate air more.

Incidentally, makers of Kodachrome do not advise moistening pads of humidor cans, as just the slightest excess moisture within the humidor will damage the emulsion.

Close Focus (N. Kapicia, Detroit)
What is the closest I may

• READERS: This department is for your benefit. Send in your problems and our technical board of professional cameramen will answer your question in these columns. If an answer by mail is desired, enclose addressed stamped envelope.

focus with my Keyston 8mm f/3.5 lens?

This will depend a great deal upon the opening you use. As you probably know depth of focus increases as you stop down your lens. For example, at f/16, lens will be in sharp focus 1 foot 2 inches; at f/11, at 1 foot 4 inches; at f/8, 1 foot 6 inches; and at f/3.5, at foot 9 inches.

Polaroid (R. L. Grand, Detroit, Mich.)

How much additional should the lens be opened when using a polaroid filter?

The manufacturers of the Fade-O-Scope, which employs the use of polaroid filters, recommends opening up a stop and a half, so we presume that the same would apply to any polaroid filter used before the lens. Incidentally, many amateur who have purchased Fade-O-Scopes are using them as a neutral density filter to cut down light volume when extra fast cine films are used. For example, if your camera is loaded with super X pan film, you will most likely get a meter reading outdoors in bright sunlight of f/32. With most lenses f/16 is the maximum stop and a N.D. filter or polaroid is the only thing that may be used to reduce the amount of light entering the lens without affecting contrast as would be the case if a heavy color filter was used.

Reverse Action (Alden Carter, Longview, Texas)

Will you please explain for me how reverse action can be filmed with an 8mm camera?

• Continued on Page 53

**HIGH QUALITY
AND LOW COST
MAKE THE**

Revere

8mm PROJECTOR

The Greatest Value

**IN THE HOME
MOVIE FIELD**

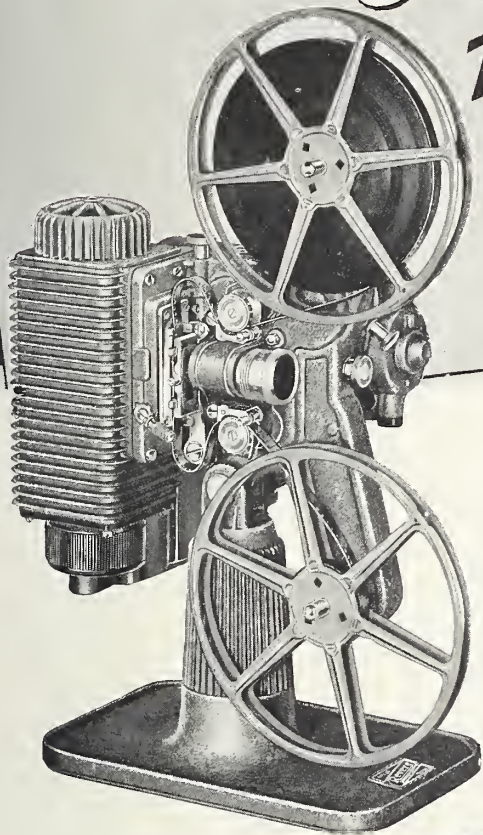

**REVERE MODEL 80
SERIES B 8mm
PROJECTOR**

This powerful projector with every professional feature for better and smoother projection, sets the pace for quality and value.

WITH 500-WATT LAMP
AND 1-INCH F 1.6 LENS,
COMPLETE—ONLY

\$5950

**YOU WILL LIKE THE
QUICK LOADING OF
REVERE CAMERAS**

Changing from colored film to black and white after each 25 feet is a simple matter for the Revere Owner. The exclusive Revere Sprocket Film Control forms a loop in the film automatically and prevents film jamming.

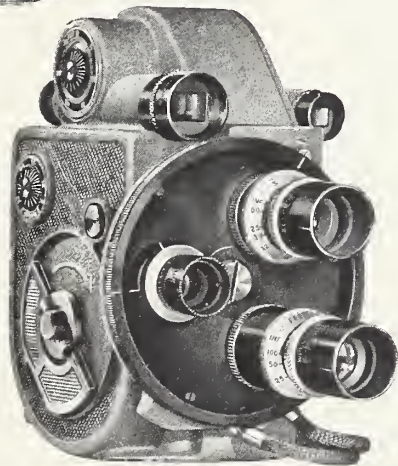
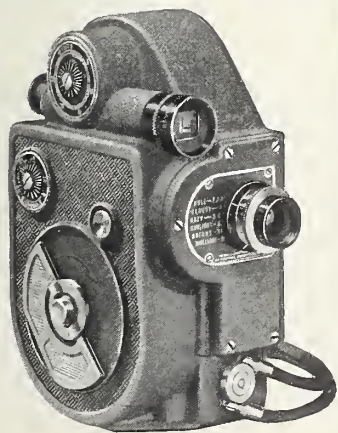

REVERE MODEL 99 TURRET CAMERA

Offers all the conveniences of the professional type Cameras at a remarkably low price. With two optical view finders and one Wollensak 12.5mm F2.5 lens COMPLETE..... \$65.00

REVERE MODEL 88 CAMERA

With Wollensak 12.5mm F3.5 lens in removable universal focus mounting. COMPLETE..... \$29.50
With F2.5 lens..... \$39.50



Revere offers you a complete Projector at this low price; made possible only because of its modern manufacturing facilities and its scientific production methods . . . has every mechanical and optical feature to insure brilliant, steady projection of your 8mm movies.

• **BRIGHTER BLACK AND WHITE AND COLOR MOVIES**
500 Watt lamp. Powerful F 1.6 lens.

• **SHARPER, STEADIER PICTURES**

Duplex shuttle film mechanism, 10½ to 1 ratio. Self-adjusting film guide in gate assembly eliminates unsteadiness, usually caused by variations in film width and splices.

• **GREATER FILM PROTECTION**

Double blower cooling system for lamp and film. Large 15 tooth sprockets with "Safety-roller" film guides. Recessed aperture shoe and film track (prevents film damage).

Automatic "Quick-Action" safety shutter.

• **EASIER OPERATION AND MAINTENANCE**

Simple "Three-point" threading system. Manual clutch control for still projection. Fully enclosed Rewind mechanism (Sprocket Drive). 300-foot reels (for longer shows). Removable Aperture shoe for quick cleaning. Variable motor speed control.

• **LONGER LIFE**

Heavy-Duty Ball Bearing AC-DC motor. Revere has *no belts* — positive gear-drive. Superior Cooling system — prolongs lamp life. Precision-built-quality construction, fully guaranteed.

These are only a few of the features. *Ask your dealer for a demonstration.* Like thousands of other users, you, too, will agree the Revere 8mm Projector is the greatest value in the home movie field. Write for literature now!

REVERE CAMERA COMPANY • CHICAGO
PHILADELPHIA • KANSAS CITY • MINNEAPOLIS • LOS ANGELES • DALLAS

REVERE CAMERA COMPANY

Dept. 11HM, 328 East 21st Street, Chicago, Ill.

Send complete facts on Revere 8mm Projectors and other Revere motion picture equipment.

NAME

ADDRESS

CITY STATE

*For Canadian prices, write to Ryerson Film Service,
299 Queen Street, West, Toronto*



THE UTMOST IN A SOUND MOTION PICTURE PROJECTOR

- ★ **Assured Film Protection**—Patented Safety-Trip immediately stops machine. To be found only on this equipment. With Offset Film Loop that eliminates damaging film pressure and side sway.
- ★ **Stationary Sound Drum** — Unequalled sound quality—no moving parts—No adjustment necessary for color or black and white.
- ★ **"Spira-Draft" Forced Cooling** — insures greatest lamp economy and safety.
- ★ **Flickerless Shutter** — unsurpassed clarity of pictures. Safety shutter for stills.
- ★ **Film Reverse** — Pressing one lever reverses film for reviewing. No rethreading necessary.
- ★ **Easy Accessibility** — to spotlessly clean all working parts. No special tools required.
- ★ **Multiple Use**—For classroom, auditorium, dances, outdoor events — with interchangeable units that mean Greater Economy and Widest Utility.



In no other equipment regardless of price can all of these advance features be found. Write today for complete description of these and other features.

VICTOR ANIMATOGRAPH CORPORATION
Dept. B-1 Davenport, Iowa

BACKYARD MOVIES

Ideas for Short Films

It's a Boy!

Here is a suggested scenario which anyone can make on one roll of 8mm or 16mm film and really have something interesting to add to his home film library. If the events suggested, that of the birth of a baby, actually happens, so much the better. This story is for the man who can take a joke as well as give one. I mean by that, the new papa should of course play the leading part. Talk the story over with your family physician. If you present your idea enthusiastically enough, he might even consent to play "himself" in the picture. You can well imagine the sensation your film will cause when you flash the opening scenes on your home screen and your friends recognize your own family doctor. I can just picture them exclaiming, "Why, there's Dr. Jones! How ever did you get him to act in your movies?"

If your wife is movie-minded and wants to appear in your film, you can have the last part of the story take place right in the bedroom instead of outside the door. The new baby's mamma can appear very perturbed when you faint and then laugh at you when you are revived by the nurse. She can even look down at you on the floor and say, "You big sissy!" Of course a couple of shots of the new baby can be fitted in right at this point (you will be filming him, anyhow).

Opening scene: Excited husband dials phone and starts talking.

Scene 2 (closeup): Doctor answers the phone very calmly and after a pause speaks —

Title: "I'll be over in about an hour."

Same as opening: Husband very excited and still talking.

Same as Scene 2: Doctor smiles and speaks —

Title: "I said, in about an hour; that will be plenty of time."

Same as opening: Husband still excitedly talking.

Same as Scene 2: Doctor hangs up with a smile.

Title: One hour later.
Long shot: Car drives up to curb; doctor gets out very slowly and walks up to the house, where he is met by the husband, who is waiting on the front porch.

Medium closeup: They shake hands and the doctor follows him into the house.

Medium closeup: The doctor enters the bedroom and pushes the husband playfully out the door. Doctor speaks —

Title: "I won't be needing you around for a while."

Closeup: Husband's feet nervously pacing the floor.

Closeup: Ashtray with one cigarette butt still smoking.

Closeup: Husband's feet again nervously pacing the floor.

Closeup: Ashtray now has several cigarette butts.

Long shot: Doctor is coming down the stairs, pauses and speaks —

Title: "You may go up, now."

Same as before: Husband rushes past the doctor, nearly bowling him over, and mounts the stairs, two steps at a time.

Medium closeup: Nurse is coming out of the bedroom door with a baby wrapped in a blanket. She stops and speaks —

Title: "Mr. Jones, may I present your son?"

Medium long shot: Husband takes a step forward and falls on the floor in a faint.

Same position: Nurse returns baby to the bedroom and comes back with a bot-

• Continued on Page 561

Camera!

MITTEN'S MOVIE TITLERS

ARE READY FOR ACTION

THE IDEAL HOME MOVIE GIFT

SEE YOUR DEALER OR WRITE FOR CATALOG

MITTEN'S DISPLAY LETTERS
REDLANDS CALIFORNIA

BRANSBY & HEWITT
1600 BROADWAY • NEW YORK CITY

• We want suggestions and ideas for random "backyard" filming; also for simple home movie scenarios. Those which are published will bring the contributors either a 100-ft. 16mm or a 50-ft. 8mm film subject selected from the advertisements in HOME MOVIES magazine.

Far ideas that can be adapted to a feature length article we will reward the contributor with two rolls of panchromatic film. Address your suggestions to BACKYARD MOVIES, care of HOME MOVIES, 6060 Sunset Boulevard, Hollywood, Calif.



Home Movies

MAGAZINE



**Subscription
Order Form**



A Revelation in 8mm. Projection

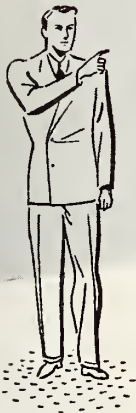

Full 16mm. Quality now available in this new AMPRO 8mm. Projector

Yes, every feature that good 8mm films deserve—brilliance of illumination, reverse pictures, ease of operation, gentle treatment of precious film, in short, a smooth satisfying performance is now available through the new Ampro 8mm projector.

For years 8mm fans have said, "Give us a projector that does not penalize us for the economy of 8mm film." In this new model—Ampro now makes it possible to show 8mm film under ideal conditions.

Many Special Features Provide Smooth Satisfying 8mm Projection...

Still Picture Lever . . . Automatic Safety Shutter . . . Reverse Picture Operation . . . Fast Automatic Rewind . . . Full 400 foot reel capacity if desired . . . 500 Watt Illumination . . . Flickerless Pictures at Slow Speed . . . Efficient Cooling for Forward or Reverse Projection . . . Cool Air Intake Across Aperture Insures Longest Film Life . . . Automatic Reel-Locking Device . . . Micrometric Tilting Knob . . . Automatic Pilot Light . . . Centralized Controls . . . Complete Range of Film Speeds . . . Easy Threading . . . Quiet Operation . . . Has 1" F1.6 Objective Lens . . . Optical System Corrected for Color Films . . . Operates on both AC or DC 100-125 Volts.

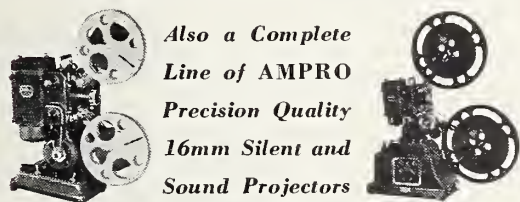

Also a Complete Line of AMPRO Precision Quality 16mm Silent and Sound Projectors

Ampro projectors both silent and sound are standard equipment in many thousands of schools, universities, government departments, U. S. Army and Navy, churches, clubs and homes. These precision projectors incorporate numerous features that insure brilliant, high quality silent and sound projection.

Ampro

PRECISION CINE EQUIPMENT

Ampro Corp., 2839 N. Western Ave., Chicago, Ill.

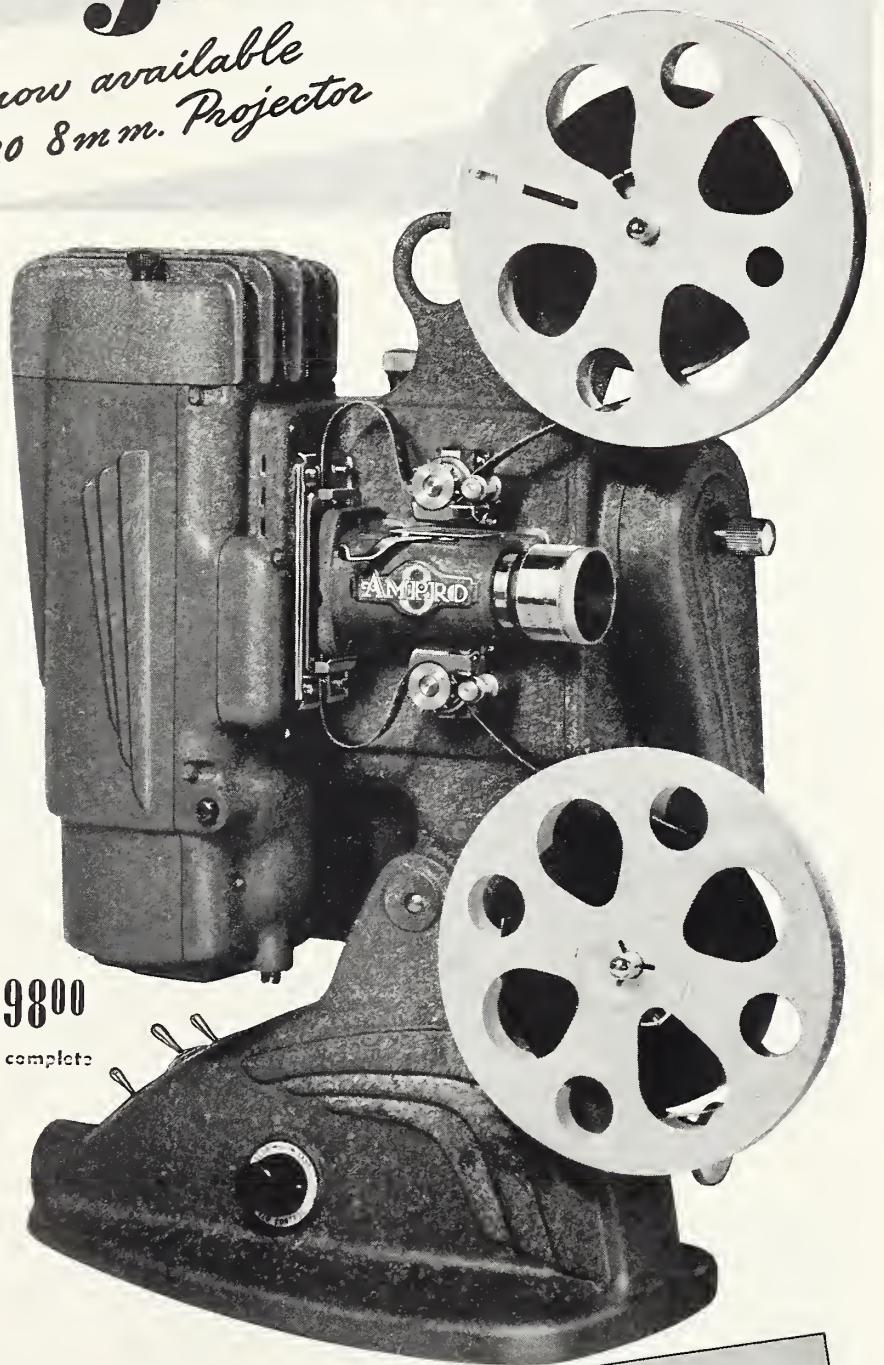

\$9800

complete

SEND FOR CATALOG

The latest Ampro Catalog will give you full details on this remarkable new 8 mm. projector and the full story on the complete line of Ampro "precision" 16 mm. silent and sound projectors.

Ampro Corporation, 2839 N. Western Ave., Chicago, Ill.
Please send me full details on the new 8mm Ampro Projector.
Also the complete Ampro 1940 Catalog of 8 and 16mm Projectors.
Name _____
Address _____ State _____
City _____

DEALERS:
Write for information
on the Ampro franchise!

Playtime is Movie Time



Get G-E PHOTOFLOODS and film priceless shots . . .

Some of the most priceless pictures you'll ever shoot are sequences of your children at play. Make sure of crisper, clearer pictures . . . INDOORS. Use G-E MAZDA Photoflood lamps to light the scene. These are the same high-efficiency type lamps that the big movie studios use . . . made to fit *your* needs. They are grand for color or black-and-white. Get some today and get better shots.

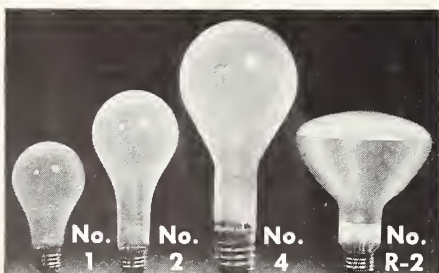

NEW LOW PRICES

G-E No. 1 . . . 15¢ G-E No. 4 . . . 1.20
G-E No. 2 . . . 30¢ G-E No. R-2 . . . 85¢
(a handy extra light)

GENERAL ELECTRIC
MAZDA PHOTO LAMPS

With the PRO-16's

By RAY FERNSTROM, A.S.C.

RECENTLY we spent many hours in the projection rooms and over the optical benches and printers of Hollywood's studios and film laboratories gathering information on their most recent developments—that of obtaining satisfactory 35mm prints from 16mm film. The success of this accomplishment marks another milestone in motion picture history,—home, theatrical, and industrial. There is little doubt that from now on there will be a lessening need of 35mm cameras as the current trend gains improved results.

So far, two very satisfactory 16mm professional cameras have been in use by "pro" cameramen, and more are coming out, some of them quite startling. The other day Cinecolor gave a demonstration on a full theater screen of a two color print from Kodachrome sixteen. For the first time the contrast was normal, practically equal to prints from direct contact 35mm negatives. No appreciable sediment spots or other marks were apparent and a noticeable improvement in definition was gained. Black and white prints can be made by this same method. Slow motion in 35mm color has been hampered by difficulties that are removed entirely with this new system of enlarging 16mm Kodachrome.

Cinecolor also showed a few feet of their new three color prints from both the 35mm 3 color negative and 16mm Kodachrome, and from where I sat the 16mm appeared the answer to many questions of how to shoot professional three color for all professional needs regardless of whether films are for theater or industrial use.

This is just a "preview" into a new development which I feel sure will gain momentum as the days go by.

Already this writer has had a call to buy some outstanding Kodachrome on various sports. The first re-

• News of readers' activities in business, school, and publicity film production.

quest is on Ice Sailing; so any of you who live near centers of this sport please drop me a line and I'll give you the information on how you can sell some Kodachrome footage. For successful enlargement, your color film should not be handled at all before enlarging. If it must be viewed, do so only on a viewer such as the Craig, wherein nothing touches the picture area.

There are several other laboratories here in Hollywood who are also enlarging 16mm to 35mm for professional use at the present time and several major studios are making experiments and tests along this line.

For many years Cosmcolor films have been enlarged from pictures photographed not on 16mm but from two slightly larger than 16mm images on one piece of 35mm negative. These have been successfully used on theater screens all over the country.

So enlarging of movie films is no new idea, but rather an old one coming into its own. It shouldn't take long now before all motion pictures, whether theatrical or industrial, are photographed in 16 whether in color or black and white. With professional use of 16mm Kodachrome, in professional 16mm cameras, (equipped as major studio 35mm cameras are at present), affording greater quality, variety of angles, speed and efficiency there will come better pictures, better color and better business for all concerned.

One of the major studios is now testing the first professional 16mm camera to be built incorporating the features found heretofore only in the 35mm cameras used by the industry as standard. This model will

• Continued on Page 561

"ADD+ COLOR"

Yes, it does exactly that—it adds color, on the screen, to any and all black-and-white pictures.

Eight-segment selector-disc (8 colors), mounted on its own stand, is placed in front of projector lens and revolved by a flick of the hand while picture is screening. Projects two pre-selected colors simultaneously (on upper and lower portions of screen respectively) or tones entire scene one color.

Usable with all projectors, 16mm and 8mm.

Set up in a moment, "ADD+COLOR" takes minimum space. Does not disturb screen, film or projector.

Enjoy the thrill of seeing your "good old black-and-whites" acquire new life and sparkle, with "ADD+COLOR."

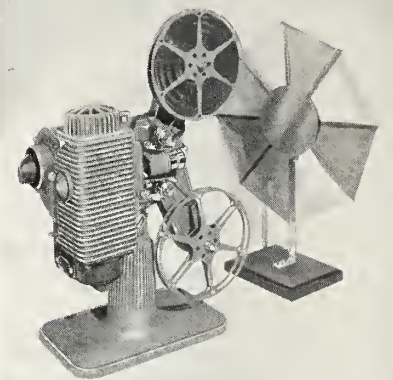

Useful, too, with projector, for color-lighting title sets in Kodachrome filming; also for color-lighting interiors (e. g., injecting red glow around fireplace) in Kodachrome work.

"ADD+COLOR"

POSTPAID \$7.50 C.O.D.

ORDER FROM YOUR DEALER
OR DIRECT FROM

FREIDEL'S

2564 ZOE AVENUE
HUNTINGTON PARK, CALIF.

Get Yours TODAY

California Customers add 3% Sales Tax

Name This New TRIPLE-DUTY SCREEN



**AND YOU MAY
WIN
\$200.00**

**\$1,050.00
IN 139 PRIZES**

Contest Closes December 31st, 1940

FIRST PRIZE, Cash . . . \$200.00

**3 Second Prizes, Cash . . . \$40.00
each**

**10 Third Prizes \$18.00*
of DA-LITE Projector Stands each**



These stands are adjustable in height and have tilting rotating platform. They are ideal for showing movies, for use as a camera tripod or a support for clamp—on type light reflectors.

**25 Fourth Prizes \$6.00*
of DA-LITE No. 2 Unipods each**



This popular camera support has a neck strap and is adjustable in height from 11" to 17". For movie or still camera. Weighs only 12 oz.

**100 Fifth Prizes \$4.00*
of DA-LITE 22"x30"
Junior Screens**



This has Da-Lite's Glass-Beaded screen surface and special two-ply spring wire support for setting up on a desk or table.

139 Prizes, total value \$1050.00



Used as a Hanging Screen

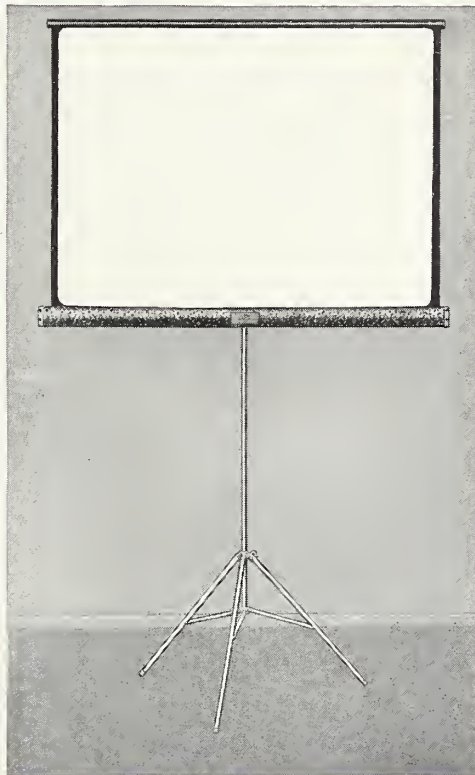

Used as a Tripod Screen

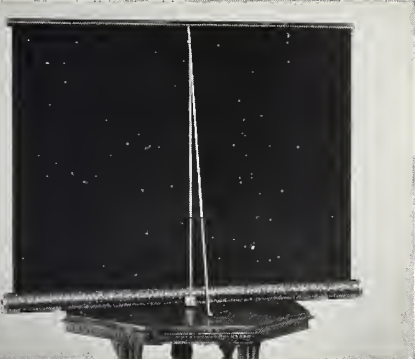

Used as a Table Model

3 SCREENS IN ONE, 30" X 40" only \$7.50*

\$200.00 FOR A NAME! That's what you will receive if the name you suggest for Da-Lite's sensational new screen is considered best by the judges. There are 139 prizes, totaling \$1,050.00. You can send in as many entries as you wish! All you have to do is suggest a name for this screen and give in 25 words or less your reason why you think the name is best.

FACTS ABOUT THE SCREEN: It is a triple-duty screen that can be used as (1) a tripod screen, (2) a map-type hanging screen, or (3) a table screen, quickly set up on a desk or table. The surface is Da-Lite's famous Glass-Beaded surface—ideal for color or black and white pictures. It provides maximum illumination to wider angles

*Prices slightly higher on Pacific Coast.

than ordinary beaded screens and stays white longer than any other white surface. The screen (a 30"x40" size), case, folding tripod and special Da-Lite two-ply spring support for setting up on a table are all offered at the amazingly low price of \$7.50.*

See this new Da-Lite Screen at your dealer's! Compare its features—you'll agree it is top value in the low-price class—just as the Challenger, Model B, Electrol and other Da-Lite Screens are leaders in their respective fields.

NOW FOR A NAME! Send your first entry to-day—on the entry blank below. You can get other blanks from your dealer. But mail your first suggestion now! It may WIN \$200.00.

FOLLOW THESE EASY RULES

1. Suggest a name for DA-LITE'S NEW GLASS-BEADED Combination Tripod-Hanging-Table Screen and give in 25 words or less your reason why you think this name is best.
2. Send in as many entries as you wish. Mail to DA-LITE Screen Contest Editor, 215 North Michigan Avenue, Chicago, Illinois.
3. The contest closes December 31, 1940. Your entries must be postmarked not later than midnight, December 31st, and must be received by us within ten days.
4. An independent, experienced contest organization will have complete charge of the contest. They will judge all entries from the standpoint of originality, uniqueness and applicability of the name suggested in conjunction with the sender's reason for recom-

mending it. Decision of judges will be final. In case of ties, duplicate prizes will be awarded. All entries become the property of DA-LITE Screen Company, Inc., Chicago, Ill. No entry will be returned.

5. Anyone living in continental United States may compete, except employees of DA-LITE Screen Company, Inc., and its advertising agency or their families. The contest is subject to Federal, State and local regulations.
6. Prizes with a total value of \$1,050 will be awarded. First prize is \$200 cash. See complete list of prizes at upper right.
7. All winners will be notified by mail. A complete list of the winners will be sent on request of any contestant enclosing stamped, addressed envelope.

ENTRY BLANK Mail Now!

CONTEST CLOSING DECEMBER 31, 1940

DA-LITE SCREEN CONTEST EDITOR
Dept. 11 H. M.
215 North Michigan Avenue, Chicago, Ill.

Date.....

For the new Da-Lite Glass-Beaded Triple Duty Screen I suggest the name:

My reasons are:.....

Limit statement to 25 words or less.

NAME.....

ADDRESS.....

CITY..... STATE.....

NAME OF DEALER.....



End of the hunt

WHETHER you're an 8 or 16 mm. enthusiast, you need look no longer for the film that has everything you want. It's Agfa Hypan Reversible!

You'll find 16 mm. Hypan Reversible the ideal medium for outdoor work. It is a high-speed film, fine-grained and fully panchromatic. When projected, you'll like its brilliant gradation that adds a snap and sparkle to all your scenes.

And for use with all Double-8 cameras, there is the extremely fast and fine-grained

"Twin Eight" Hypan Reversible. For either indoor or outdoor use, it has a well-balanced panchromatic emulsion with excellent resolving power and effective anti-halation coating.

For better movies, try either of these better films. Soon. Agfa 16 mm. Hypan Reversible in 100 ft. rolls is \$6.00; in 50 ft. rolls: \$3.25. Agfa "Twin Eight" Hypan Reversible in 25 ft. (double width) rolls is \$2.25. Prices include processing and return postage. **Agfa Ansco, Binghamton, N. Y.**

Agfa

8 mm. and 16 mm.

HYPAN FILM

MADE IN U.S.A.



HOME MOVIES

Published in Hollywood
NOVEMBER 1940



"HAPPY SHOOTING!" . . . This, cinebugs, is the salutation and the password of the Reel Fellows — the new organization of movie amateurs sponsored by HOME MOVIES that you've been hearing about. You may expect to hear this password frequently from now on wherever cinebugs gather or may roam seeking cinematic adventure.

And of course if you don't hear the password, you may still identify a Reel Fellow by the emblem on his coat lapel or the Reel Fellow insignia on his camera. That soon there will be thousands of Reel Fellows from the Pacific to the Atlantic is a certainty. Memberships are pouring in daily by the hundreds.

ceived from readers were carefully considered by the editors. During the discussions which followed one of the staff said, "What we need is a real short, snappy name for a bunch of real fellows."

"Real fellows?" rejoined another. "Why not R-e-e-l Fellows — yuh know, sort of joining reel with real?" And there it was! Its acceptance was unanimous.

How do you become a Reel Fellow? What are the requirements? The cost? Any movie amateur may become a member. There are no specific requirements except, perhaps, that every cinebug — once he becomes a Reel Fellow — be a real fellow toward any and all members he may encounter

Avalanche of memberships swells

ranks of **REEL FELLOWS...!**

It is timely that we tell of the origin of the Reel Fellows and of its development into a real matter-of-fact organization. For more than two years the editors have listened to suggestions of readers and of cinebugs gathered at amateur club meetings — suggestions for forming a nation-wide amateur movie club; some suggested a nation-wide association of cine clubs. What most amateurs desired, it seemed, was an organization that would enable them to meet other cinebugs; to be able to identify their brother hobbyists; share their experiences.

Then there came a letter from Irwin Sipherd, at that time president of the Pittsburgh Amateur Cine Club, suggesting a standardized emblem that could be adopted by all cine clubs and, to use Mr. Sipherd's words, "which would identify the wearer as an amateur movie friend." This letter, published in the May 1940 issue of HOME MOVIES, brought numerous letters from readers acclaiming the suggestion.

Thus assured of the amateurs' desire, HOME MOVIES immediately set about to make the organization a reality and to select a suitable name for it. The various suggestions which had been re-

thereafter, give freely of his knowledge of cine-filming to those who may benefit by it, and to maintain undying enthusiasm in the finest of hobbies — amateur movies. The cost is nominal — the initial membership fee of one dollar. This brings to each member a handsome gold emblem, three-color insignia for attaching to his camera, and his membership card.

OF course there are many other benefits yet to be had from membership in the Reel Fellows, but we're a little too young to make any lavish promises. The Reel Fellows have elected to go along slowly but more surely perhaps, sort of feeling their way, to insure against a mushroom growth and the flash-in-the-pan existence that has fallen the lot of so many organizations. You may be sure the many requests which already are coming to the secretary for new and additional services, are being given careful consideration and that just as soon as they are sufficient in number to indicate a healthy demand, they will be made a

• Above: Grace Ver-Halen, secretary, is literally swamped with applications for membership in the Reel Fellows, the newest nation-wide organization of movie amateurs. A gold emblem, three-color camera insignia and membership card are mailed each member upon receipt of application.

Authored by
JACK IRWIN

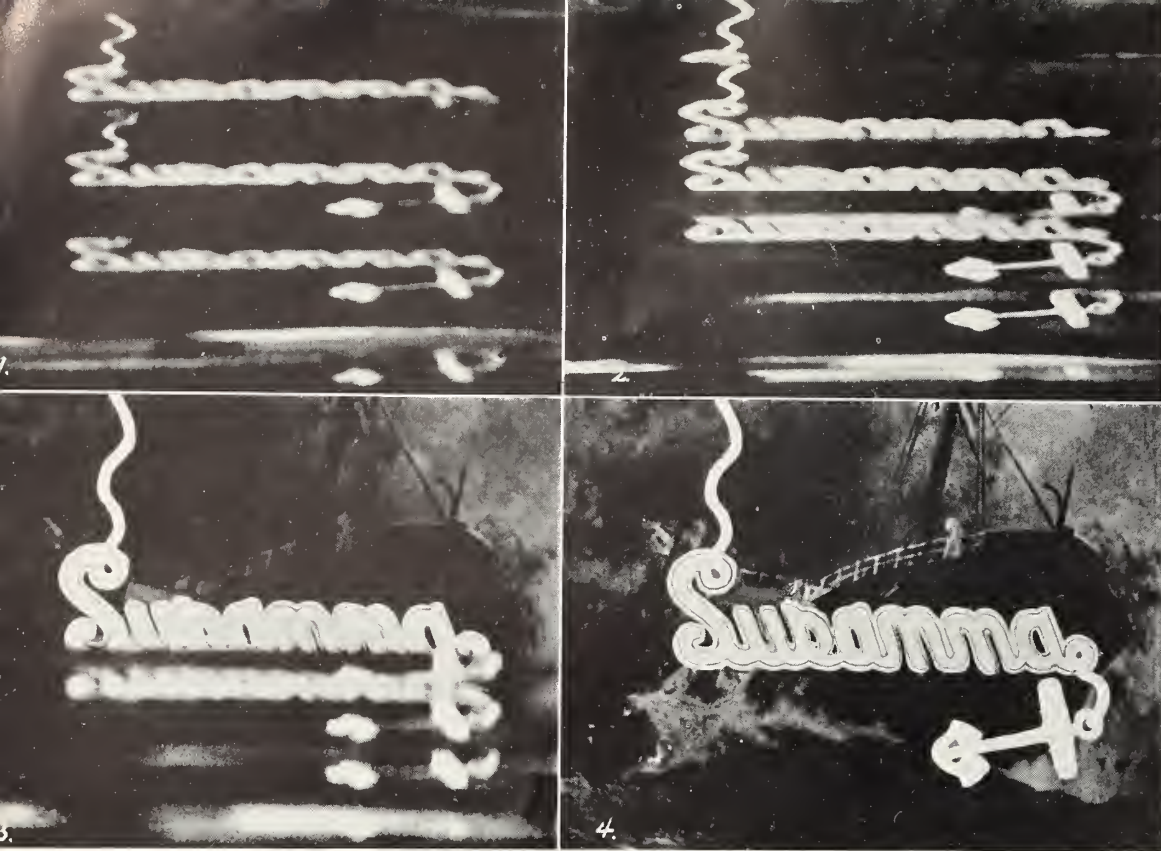

Here's TITLE TRICK that won 1940 award!

• Above—enlargements from frames of main title of "Susanna" showing navel fade-in effect produced by glass described here; and below—sketches showing method of manipulating glass; cross section of glass; and (Fig. 4) another effect that may be achieved.

To many readers of HOME MOVIES the name of Clarence N. Aldrich is not unfamiliar. His name has appeared more than once in these pages for his accomplishments as an amateur movie maker. When Clarence Aldrich isn't shooting, editing, or titling his home movies, he may be found huddled between a pair of expansive desks within his office in Long Beach, California, where he can look out upon the broad billowing Pacific which laps the shores of that famous city.

We say "huddled" because architects spend a great deal of their time in such a position over drawing boards, sketch pads, or estimate sheets.

Aldrich is an architect. On this particular day, he relaxed in his chair a moment, perhaps to ponder a detail or two on the blueprint before him. And, as many of us are wont to do in moments of contemplation, he picked an object from his desk and toyed with it thoughtlessly.

As he turned it, while holding it before him, the strange pattern it created attracted him. The object—a small panel of architectural glass received as a sample that morning from a builders supply house—imparted an interesting distorted effect to objects as he gazed through it. The glass fully transparent and about 1/8-inch in thickness, was fluted on one side, that is, it was made up of a series of semi-circular depressions which broke up the pattern of light passing through it much the same as in a prism or a series of prisms.

Aldrich's mind instantly traveled from building plans to movie making, or to be more specific—title making. Here, he discovered, was a swell gadget for making unusual effects in home movie titles!

WHEN he left the office that evening, Aldrich carried home with him the little panel of glass; and while dinner was being prepared, he busied himself experimenting—manipulating the glass before a title card in his home-made titler. The big smile he wore the rest of the evening betrayed his discovery. The rest is history. When the judges reviewed Aldrich's entry, "Susanna," in HOME MOVIES' 1940 Amateur Contest, they immediately acclaimed it the most outstanding film

• Continued on Page 550

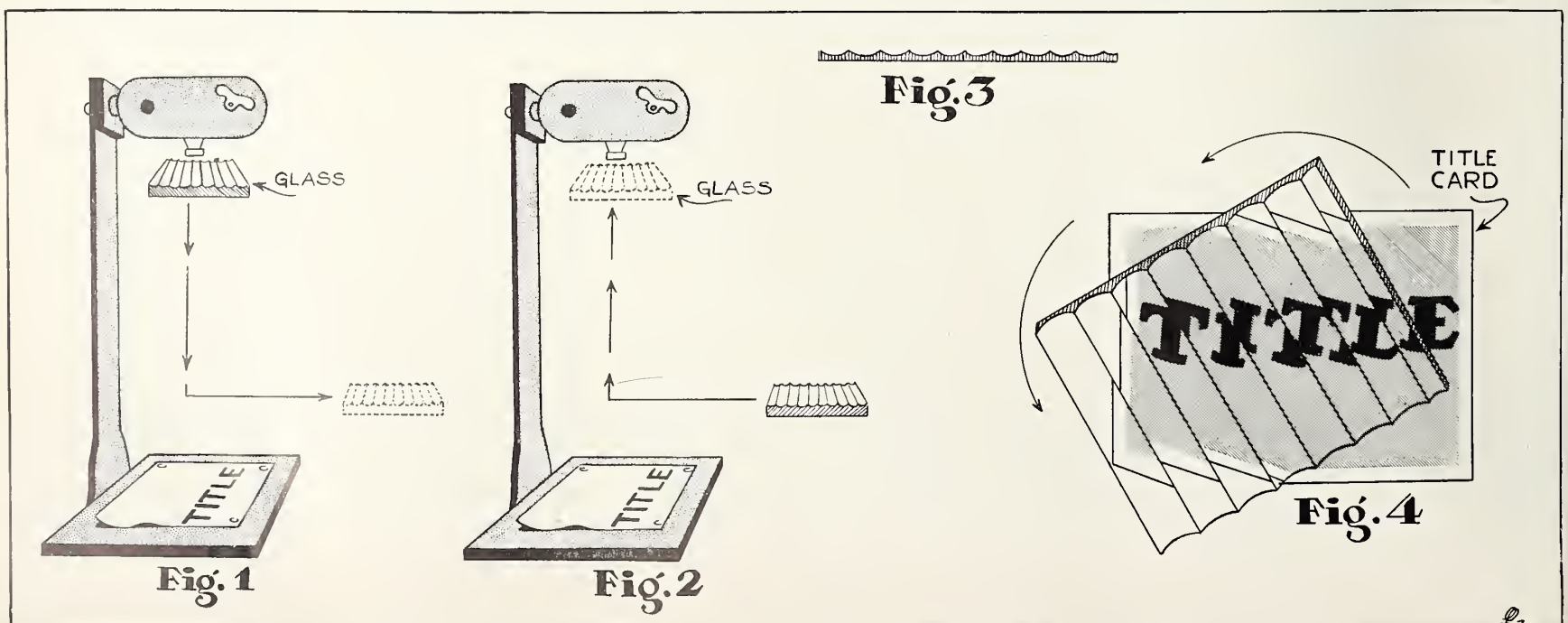

Authored by
GEO. W. CUSHMAN

The lowdown on CONTINUITY.....

WHAT is continuity?

To many the word itself is sort of mysterious, elusive. They shy away from even the thought of it. Why? Well, probably because they never quite understood the real meaning of the word, at least as far as it is associated with the making of movies.

In its simplest form, continuity is the state of being continuous, that is, unbroken, uninterrupted, going along in a solid manner. When applied to the making of movies it refers to the action and means that the action is continuous, smooth-flowing, unbroken.

Sometimes a cinefilmer is confused by the use of the term "continuity" in referring to a plot or scenario as used in the studios. Such use of the word is purely colloquial and undoubtedly originated because of the purpose of a scenario to insure continuity. Agreed that a scenarized picture has continuity; but a picture can also have continuity without a plot of any kind. In fact a picture can have continuity without having any action. A photograph album or a set of slides can have strong continuity.

What, then, is meant by continuity? Probably the simplest explanation would be to say that continuity exists when we recognize the relation succeeding scenes bear to each other by virtue of action or titles. It is the continuation of a central theme or bit of action through a series of related scenes. The scenes vary from long shots to closeups, and in so doing disclose the subject being photographed more interestingly.

This may look all right in print but the filmer wants to know how he can obtain a smooth flow of action in practice. The answer is, "Think before shooting!"

It would be easy to suggest merely writing out the scenes before shooting. Following a carefully prepared script will always produce excellent continuity in the various sequences. But how many cinfilmers today can or in fact want to write out every

movie they make beforehand? Who can write out the scenes he will take on his vacation? Who wants to describe each scene baby is to do at her next birthday party? Such candid shots are much more interesting as well as authentic than those rehearsed and practiced.

THINK before shooting, is the answer for those who want to improve their films. Think how the whole series of shots about to be exposed are going to appear on the screen. Will each shot be independent of the one before it? Or will it carry on where the one before it left off?

Let's take an example. Let's pretend it's baby's first birthday. Grandpa and grandma are in on the show, as are big sister and perhaps an aunt or uncle. What shall baby do? Wait a moment! The action will soon present itself. Let's start with a closeup of the youngster; shots of the oldsters will work in later. If the cake is on the table, have mother take it back to the kitchen. Start shooting

• Continued on Page 552

• Below is an excellent type of "lead" or opening shot for a rodeo sequence. Following this would be a long shot revealing the action taking place on the other side of the fence; then a medium shot of the same scene followed by a full closeup of the action. How much more interesting such continuity makes a movie compared to one consisting of a series of shots filmed from the same location and with no thought of continuity?



Authored by
WALTER W. LIGHT

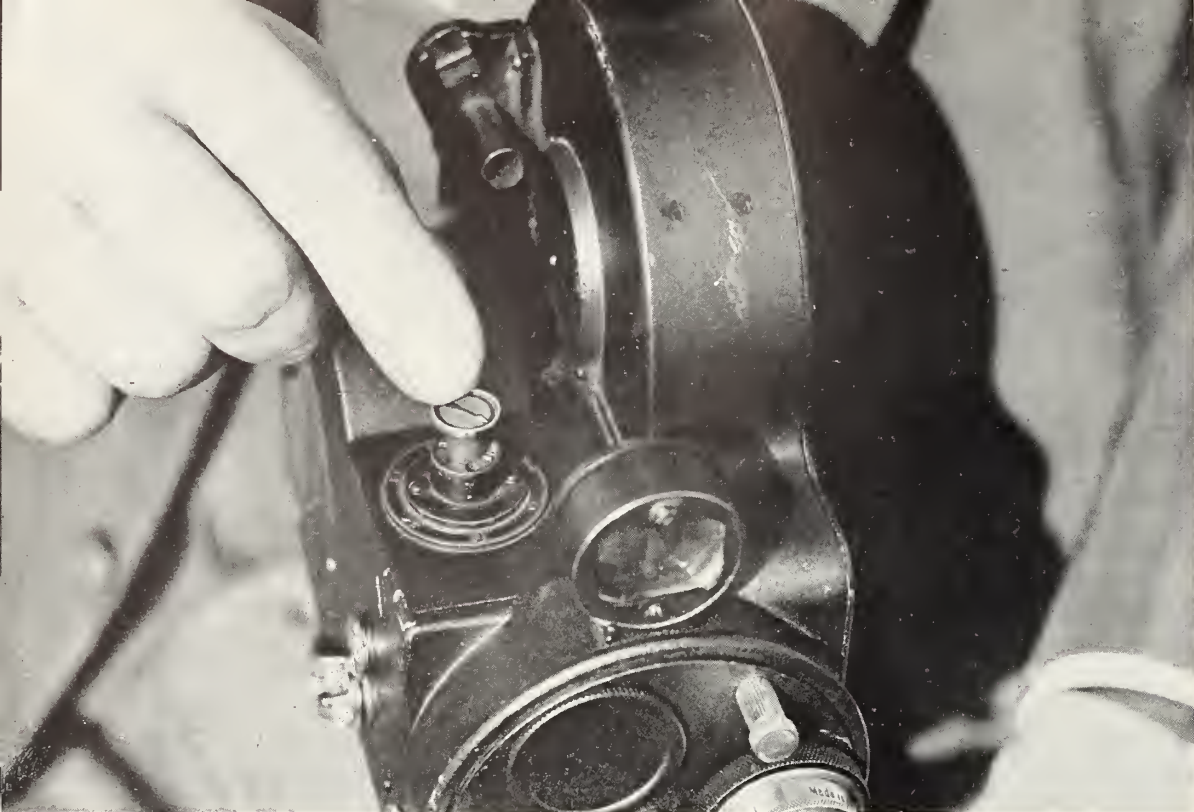

Third sequence concludes **ANIMATED** **CARTOON** *series . . .*

MAKING animated cartoons is a good rainy weather or winter evening hobby. And it will prove even more fascinating because so much of the otherwise tedious preliminary work has already been completed for you in the series of animated sketches which have appeared in the last two issues of HOME MOVIES, and which wind up with the final set of drawings which appear on the opposite page.

These, of course, should be photographed in the same manner as described last month, and if you failed to get the September and October issues and are now enthused with the idea of filming this cartoon, a limited number of both issues are still available.

The sketches will be referred to later by number and although their respective numbers do not appear in the drawings, they are numbered — this month — from 31 to 45 beginning with the first title and reading across the page from left to right.

As suggested before, it will be easier to handle these sketches in the titler if they are not cut apart, but instead — pasted together in one long strip, or used in strips of 3 sketches each as they appear on the page. In this way, they will be easier to line up in the title card holder or on your animation board. Incidentally, last month we illustrated a simple method of lining up each drawing by means of centering marks placed on the border of each sketch and on the border of the titler mask.

Each drawing is to be exposed one frame at a time. After shooting the first title for the required

footage, expose 15 or 20 frames of Stan and Ollie — drawing number 1. Then expose 4, 3, 2 or 1 frame of the next two cartoons plus the first one in this order — 1-2-3-2-1-2-3, etc., for a total of approximately 150 frames. If you want a pause in the action at any point, expose several frames of the drawing as desired.

Continue exposing the remainder of drawings and titles in the same way, making an extra close-up or “pan” shot by the methods described last month. When the last drawing is being filmed, end it with a slow fade. Fade-in and out on the final title preceding the End title. These fades give a smooth effect to the picture.

ALLOWING for repeat scenes, etc., there are over 30 scenes and titles in this cartoon film. Allowing an average of 10 seconds for each, will result in a total projection time of fully 5 minutes — approximately 100 feet of 16mm film or its equivalent in single 8mm.

In exposing drawings by the single frame method, don't worry too much if a frame or two is not exposed correctly now and then. Such frames will pass through the projector quickly and scarcely be noticed. However, possibility of uneven exposure can be kept to a minimum by those whose cameras do not provide for accurate single-frame exposure. A little time spent in practicing with the release button will soon enable you to click the button just enough to allow a single frame to pass the gate. It is advisable, too, to do

• Where camera does not provide for single frame exposure, a little time spent practicing with the release button will soon enable you to click the button just enough to allow a single frame to pass the gate; but the camera must be steady, not moved during this operation.

At the Hollywood studios we see a super-production in the making

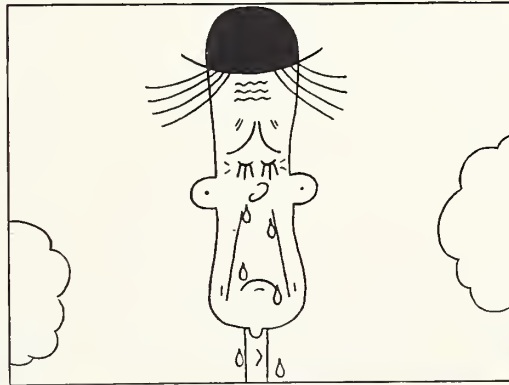
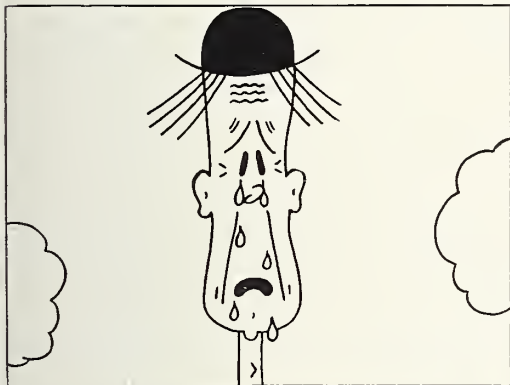
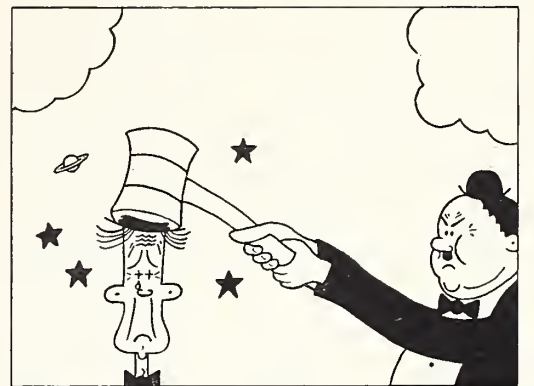
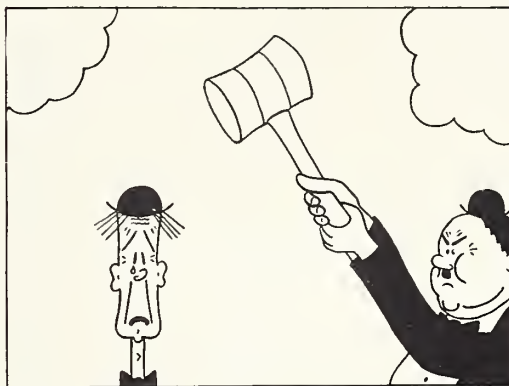
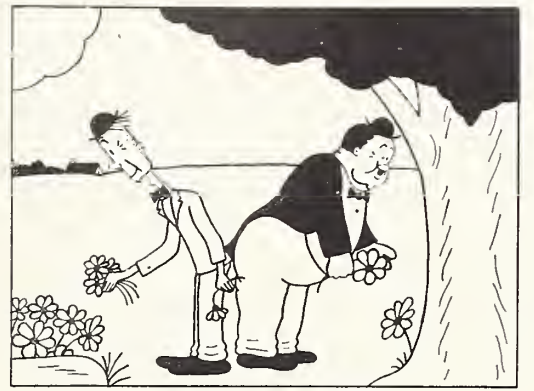
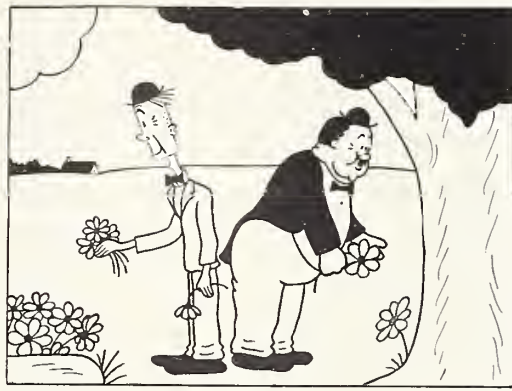

As the moon rises over the desert we bid farewell to Hollywood



Watch for the new "Hollywood Snapshots" at this theatre soon . . . !

THE . . .
. . . END

Authored by
ARTHUR H. HART

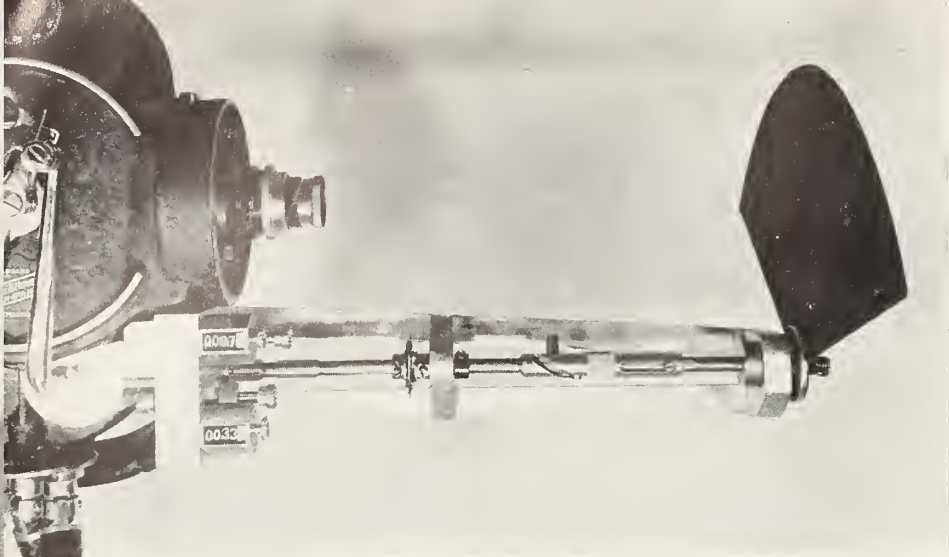

FIG. 25

Completing assembly of the "GLORIFIED SIXTEEN..."

WITH the effects box for the "Glorified Sixteen" completed up to this point, the next item for consideration is the wipe-off fan and its associated parts.

The two mounting studs which hold the fan bracket to the effects box are machined from $\frac{7}{16}$ " hexagon brass rod. Fig. 23 shows the dimensions of these studs. For assurance that the two wing nuts will not be lost, the ends of these studs are tapped for 2-56 x $\frac{1}{4}$ " screws. A No. 2 lock washer is first placed on the screw, then a No. 2 plain washer, then another No. 2 lock washer, the screw then being run into the mounting stud and tightened.

• Above photo shows appearance of the effects gear box, wipe-off control shaft, and wipe-off fan completely assembled on the Filmo "70" camera. Lower photo shows gadgets attached to gear box which move lens iris to produce o fade.

FIG. 27

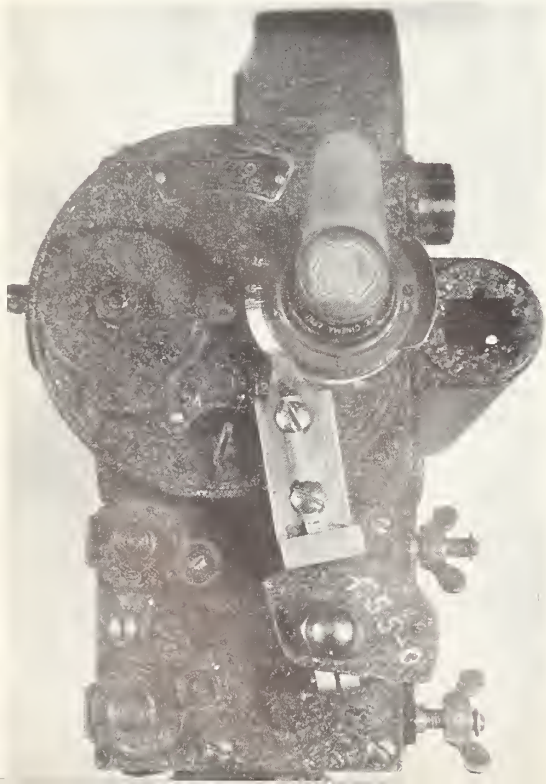

A little study of Fig. 25 will serve to show how the fan bracket is assembled. The backbone being constructed from two pieces of $\frac{1}{8}$ " by $\frac{1}{2}$ " flat brass approximately 10" long. At the front end a piece of $1\frac{1}{2}$ " x $1\frac{1}{2}$ " x $\frac{1}{2}$ " aluminum is used as the front bearing. Fastening this to the backbone is accomplished by two 6-24 x $\frac{1}{2}$ " ovalhead NP screws. The center bearing being constructed of the same material, is mounted in the same manner.

It will be noted that the lower piece of brass, which serves as the backbone for the bracket, is at right angles to the effects box, while the upper one tapers down toward the front.

Fig. 24 shows the necessary details in the making up of this bracket. After the bracket has been constructed to this point, the bearing mounts are squared up to the

backbone portion, while the front faces are rounded off for a finish.

Attach the bracket to the effects box and carefully lay out through the center and front bearing mounts, a straight line from the shaft that comes out from the effects box. Drill and ream for $\frac{1}{4}$ ".

It is through these holes that the fan shaft passes and it is essential that they be in alignment so as to eliminate any tendency to bind.

Between the center and front bearing on the shaft will be noted a sleeve which has two slots in it. One slot is straight, while the other is spiral. This performs the action of advancing the wipe-off fan to cover the area of the film exposed during the first operation and thereby eliminates the necessity of having to use more than one fan. The one fan serves to make the wipe-on as well as the wipe-off.

This sleeve is constructed from a piece of $\frac{7}{16}$ " brass rod and is approximately $2\frac{3}{4}$ " long. Bored and reamed for $\frac{1}{4}$ ". A portion in the center $\frac{7}{16}$ " wide is knurled for finger grip during the sliding operation.

Width of the slots should be kept somewhere around $\frac{1}{8}$ " wide. Travel of the sleeve during the slide is $\frac{3}{4}$ ", and the rotation angle approximately 132 degrees. Laying out of the rotating slot should present little or no difficulty, after which it is milled.

NOTE should be taken of the small projection on the sleeve just above the rotating slot. This is a piece of $\frac{1}{4}$ " brass rod which is screwed into the sleeve. Then center of the rod is drilled $\frac{1}{16}$ " almost the full depth into which is inserted a small spring and a $\frac{1}{16}$ " ball bearing. The rear shaft being drilled with a small hole at each end of travel

of the sleeve so that the sleeve will snap into a final locating position at either end of its shift.

The front piece of the shaft is threaded for 1/4-20 for a distance of approximately 3/4". Onto this is screwed a washer 3/16" thick and 1 1/4" in diameter, to effect a backing up plate for the fan and at the same time a bearing stop.

TO the rear of the front bearing on the shaft is a collar to remove any end play. Between this collar and front bearing is a flat bronze spring which introduces enough friction so when the fan comes over past center it will not fall forward, taking up what slack that might be in the shaft and gears.

To the front of the center bearing is another collar fitted with a set screw to prevent center rod from slipping backwards. To the rear of the center bearing is located a small universal joint. This joint is of the type used in the construction of radio sets and is available from any radio parts supply house.

The short shaft fitted between the universal joint and the effects shaft, is formed on one end the same as was the effects shaft. Over this shaft is placed a small length of 1/4" tubing and soldered on. The shaft is then cut to length and fastened into the universal joint.

Dimensions for the fan are shown in Fig. 26. As previously stated, the effective travel of the fan axially, is some 132 degrees. In order to properly adapt it to the travel of the spiral cut in the sleeve, it will be well to lay the fan out for 180 degrees. One-eighth inch lap over is allowed on the

rear and forward edges of the fan blade.

First lay out the fan with one side finished. That is, with 1/8" lap over the center. Attach to the fan bracket a straight edge upright so that when the fan is in the first position there will be 1/8" of the fan lapping over past the edge.

Rotate the fan forward the full extent of its travel; scribe a line down the side of the straight edge; then 1/8" farther over and parallel to the line just scribed, scribe another line. Cut the remainder of the fan off at this line. This completes the fan so that when the fan is either advanced or retarded, there will be 1/8" covered by the fan of its previous position.

In other words, the travel of the fan is just 1/3" less than its outside circumference.

Fig. 27 shows the arrangement of gadgets for producing either fades or lap dissolves. A small clamp fits on the effects shaft housing, which has a slide on it controlled from cams of different design. As the cam opens out, the end of the slide bears on a pin which is fastened to the diaphragm control. Thus as the cam rotates it can be arranged so that the iris diaphragm can be either opened or closed, depending on which side of the lens the slide rests on.

THE lens used is the type that formerly came with the model 70 Filmos, a Taylor Hobson Cooke f/3.5 universal lens, fully color corrected and gives excellent rendition of pictures. While this lens only covers from f/3.5 to f/16, I have found that for all general photographic purposes, it is more

• Continued on Page 562

• Plans below show construction details of vital parts of the wipe-off bracket, wipe-off fan, and the cam slide for making fades.

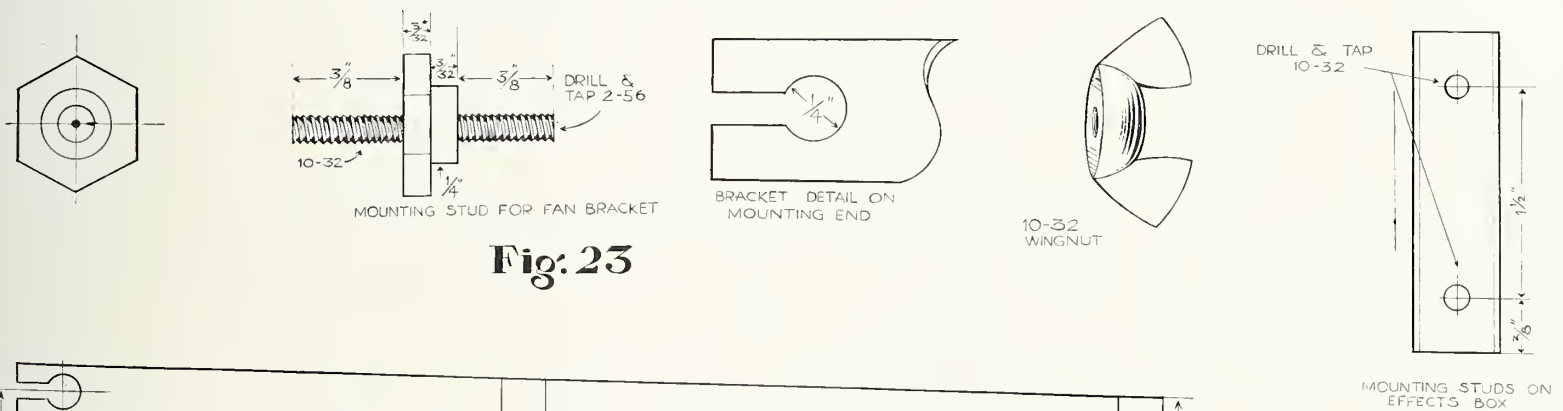

Fig. 23

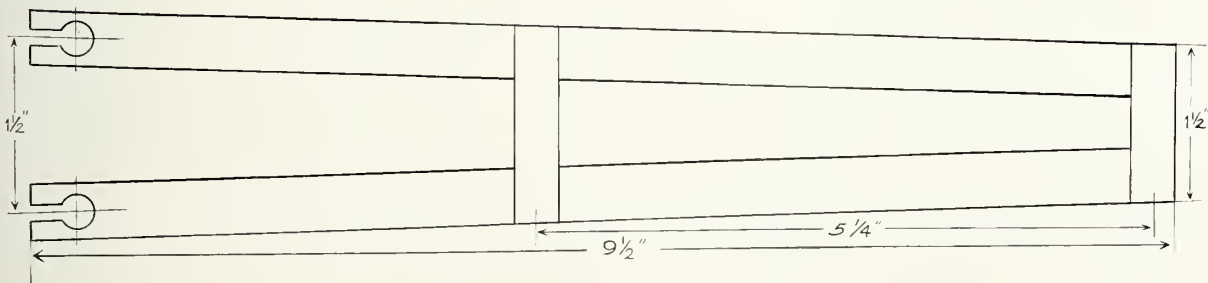

Fig. 24

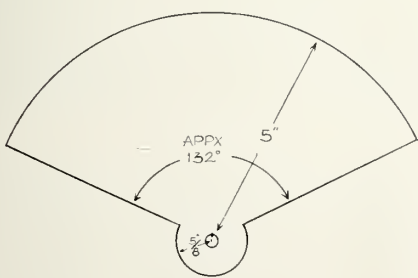

Fig. 26

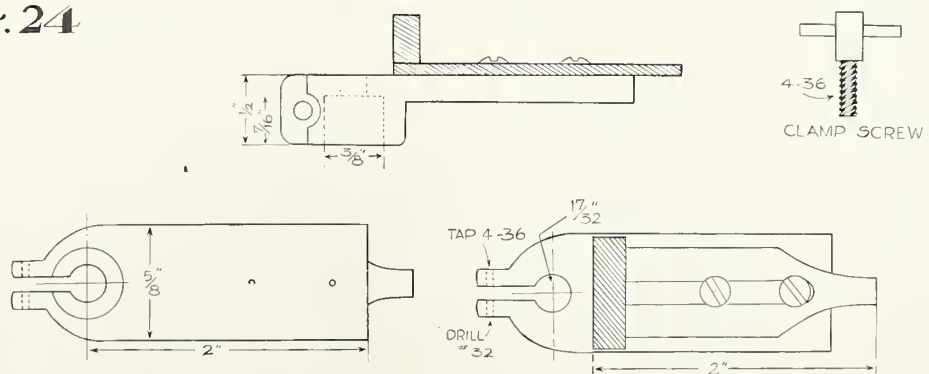
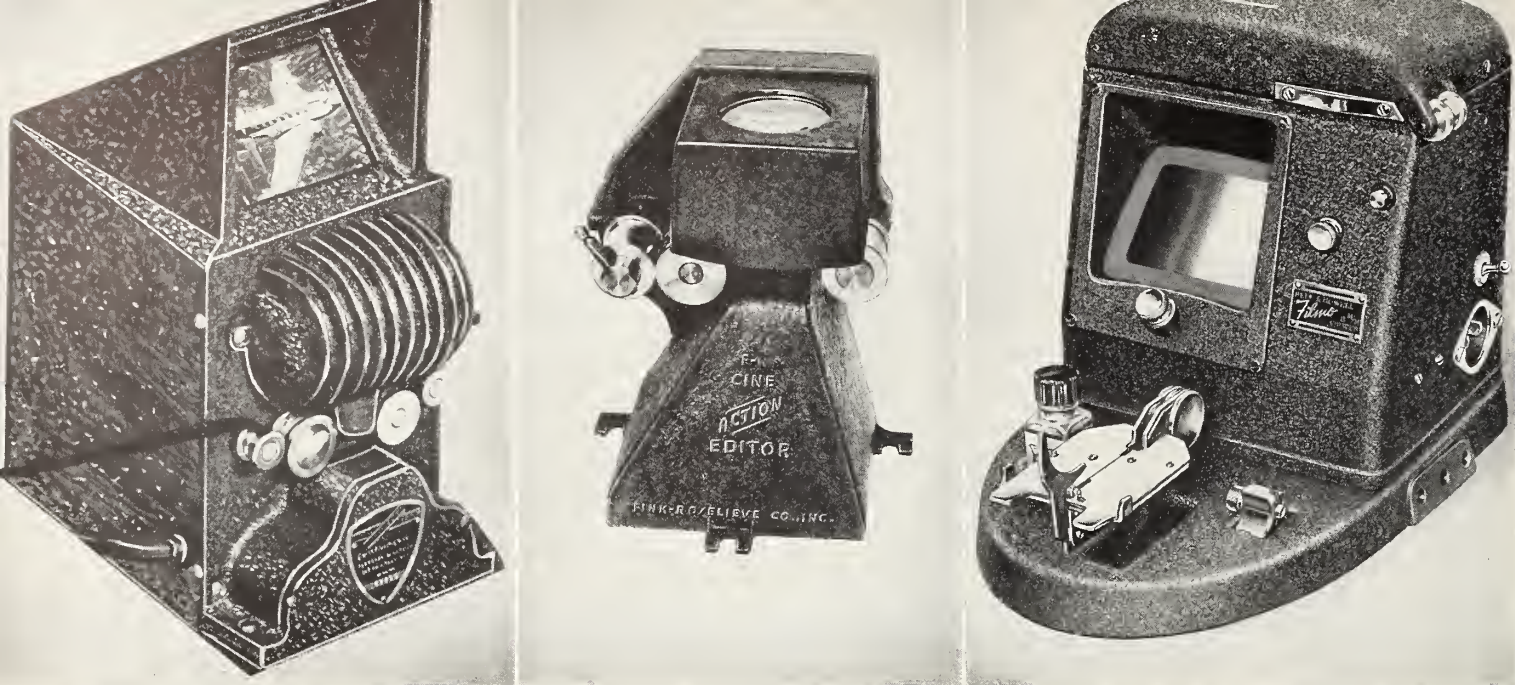

Fig. 28



Is yours a **WHERE, WHAT,** or a **WHO** picture?

Some professional pointers on editing home movies

By S. J. WILLIAMS

EVERY film — including vacation films — should answer one of three basic questions: "Where?" "What?" or "Who?" Trying to answer more than one of them at a time is likely to get the best of films into trouble. Determining which of these a film should be, is one of the keys to successful editing.

If a film is a "Where?" picture, every possible detail of where the shots were made should be stressed; the scenes that deal with what one did once he got there, or who it was that made the trip, are unimportant. They can be eliminated to good advantage, or at least held to a discreet minimum.

In the same way, if it is seen that the primary interest of a film is in the "What?" aspect, the footage devoted to scenes that tell where and who can be minimized.

If it is fundamentally a "Who?" picture, the scenes of the people concerned in answering that question should be emphasized, and the where and what aspects should be held to a minimum.

For example, a film dealing with a vacation spent touring our National Parks is definitely a

"Where?" picture. The fact that en route one fished in Yellowstone Lake, or stopped to visit Aunt Carrie at Julesburg, won't matter. The message that film has for the people who will see it is what Yellowstone, the Grand Canyon, Glacier Park, and the other scenic spots looked like. Yellowstone's trout and Aunt Carrie's homestead are unimportant, and only detract from the main interest.

On the other hand, suppose a vacation was devoted to a fishing trip, say in Northern Michigan. In this case the "What?" would be all-important. The fact the trip was to Michigan is of only incidental importance. In the same way, it may not matter much who caught the fish. The main thing — and the main footage — should be the fish and their capture, to say nothing of the pleasures of eating them in camp.

In the same way, if the vacation consisted of a visit to Uncle Seth and his family, or if it consisted of a trip with a particular group of people, they are the important things. Devote all possible footage to them, and save the "Where?" and "What?" shots for use in another film.

This gives a hint for making any vacation film more pleasing, many of which tend to divert an audience's attention from "Where?" or "What?" shots — in which it is interested — to "Who?" shots of people unfamiliar to it. Why not, then, divide the film into two separate subjects: one, a picture of the vacation itself, of the places visited, and of the things done, which will interest any audience; second, take the cut-outs from this reel and build up a more personal picture that deals almost exclusively with the people visited, with only enough of the travel shots to put over the idea of going somewhere to see these folks, and then returning home. That will preserve the family's record for family showings, without boring the average audience with the doings of unknowns.

IN editing vacation films, the problem of continuity is not nearly so difficult as in other types of pictures. The average vacation movie is usually shot in pretty much the right continuity to

• One of the several motion editing-viewers now on the market will aid materially in editing your films. Such viewers permit inspecting the film in action making possible more accurate cutting. Those illustrated above are Croig Projecto-Editor, Fink-Roselieve Action Editor, and Bell & Howell's Filmo-Viewer.

Authored by
CURTIS RANDALL

At last—successful SOUND for

8mm and 16mm movies . . . !

IT'S NOT entirely new, but now it's definitely ready for the amateur. It made its appearance about eleven months ago — experimentally — and was widely acclaimed. We refer to Synchronsound — a new and completely successful system for making 8mm or 16mm sound movies.

The new Synchronsound System had its world premier showing at the Associated Cine Clubs of Southern California's picnic and outing held September 22nd in Long Beach at which time it was fully demonstrated to some 400 amateur movie makers and their friends. During the demonstration an 8mm sound movie was made. And judging from the keen interest displayed, there is little doubt that Synchronsound is the most important recent development in the realm of amateur motion pictures.

The Synchronsound System employs the principle of sound-on-disc recordings — ordinary phonograph recordings. In addition to their low cost, disc recordings have several advantages over film recordings for home, educational, and experimental uses. Sound reproduction from disc recordings is equal to the best sound on film. Each recording can be played back immediately after it is recorded for checking purposes. The records can be made to match the final edited film.

While the Synchronsound System consists of apparatus that makes possible shooting of pictures with sound as well as adding sound after the film has been exposed, processed, and edited, we shall deal first with the latter which no doubt will interest the greater number of amateurs. With a few exceptions, Synchronsound is adaptable to most of the popular makes of 8mm and 16mm projectors. One unit of the Synchronsound System links together, electrically, the projector and turntable or record player. It consists of an electrical cable with fittings for projector and turntable shaft.

The function of this cable or "link" is to aid in maintaining constant and synchronized speed of both projector and turntable motors. The technical details will be described later. Thus, a Synchronsound recording will play back as often as required and be fully synchronized with the film when played on a recorder turntable, phonograph, or record player linked with the projector by the Synchronsound unit.

LET US assume we have a reel of film to which we wish to add sound by means of this system. With our projector set up in a darkened room before a screen and linked with a disc re-

recorder as described above, the film is threaded and made ready. A blank disc is placed on the recorder and the needle set. The starting point of the record is marked as is the starting point of the film in the projector gate. Projector and recorder are started simultaneously by means of the central control switch on the turntable connection, and the dialogue, music, or sound effects are recorded through the microphone.

To play back recording with film, the film is rewound, then threaded on the projector so that the same starting point is before the film gate; the playback arm is placed on the starting mark on the first groove on the record and the starting switch snapped on.

Now if such a recording is made on a recorder not your own, that is by some commercial recording service, it may still be played on any other record player or phonograph. You have the record

• Continued on Page 556

• Below—Figs. 1, 3, and 4 show application of Synchronsound camera units to the Bolex, Keystone "8", and Filma "8", respectively, for recording lip-synchronized speech at time of exposing the film. Fig. 2 shows the other half of the unit attached to the pivot shaft of the recorder. The unit which couples the projector with playback recorder or phonograph turntable is shown in the circle in Fig. 5.

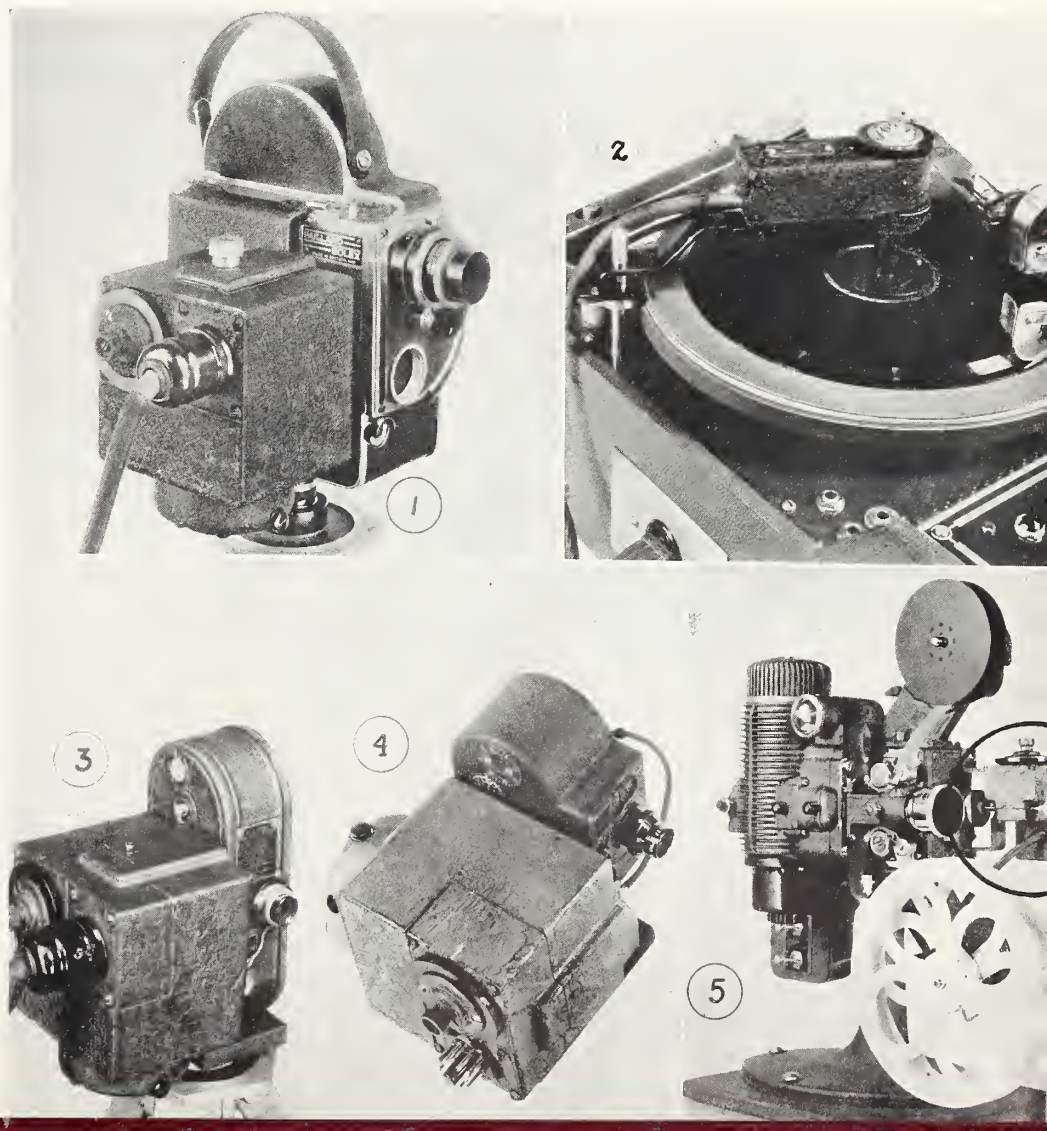

Films, like rare volumes, sought by COLLECTORS

Authored by
FRED GROSSE

THERE is an increasingly strong and hitherto unpublicized movement growing among amateurs. Records of the vital history unfolding today are being accumulated in home film libraries. Amateurs are becoming collectors . . . collectors of important movie documents.

Thanks to those who long ago foresaw the cine fan's need for 8mm and 16mm records of current world happenings, history is being made available in the more assimilable form of home movie films. Unlike those who lived before, people today are informed of a happening within a few hours after its occurrence no matter in what part of the world it takes place. In due time, those owning home movie projectors are afforded opportunity to review these events, exactly as they happened, in the comfort of their homes.

Periodically, such organizations as Castle Films make available a home movie release on both 8mm and 16mm film of important events especially prepared from the motion pictures gathered by newsreel staffs assigned throughout this country and to the world centers seething in the turbulent cycle of change gripping the world today.

Those who have not yet been privileged to screen such films may fail to realize their value or the important place they are beginning to occupy in the cultural dominion of the home. Just as good books on the library shelf lead to a more intelligent family life, so now documentary home movies of important world happenings are regarded an asset in the realm of knowledge.

Somewhat skeptical, the public received the first efforts of producers of news and historical home movie films as just another series of entertain-

ment movies. But as favorable audience reaction increased at each showing of such films, those fortunate to have acquired them realized they possessed something more than a roll of film to flash on the screen for the entertainment of drop-in visitors and friends.

Today, intelligent and far-seeing cine fans are building libraries of such films; have become collectors of news, historical, and current event home movie films, as others collect rare books, antiques, coins, and stamps. And it is not unlikely this new field of the collector holds far greater returns. Films thus acquired, used and stored carefully, can last a lifetime. They can be a source of much entertainment, knowledge, and — far more important — a source of historical facts for our children. Should another war follow this one, they may see instead of read about the last one. Perhaps the vividness of an 8mm or 16mm movie depicting the horrors of the 1940 war may still the hand or voice of the one about to plunge a future generation into another frightful holocaust.

FILMS depicting important events of 1940 that will have a top spot among the film collectors will include such accounts as the fall of France, Britain's stalwart stand against odds before which country after country previously had succumbed. The "Altmark" epic in a Norwegian fjord. Balbo killed. The *Queen Mary* making neutral port, and later risking flight from that port through submarine-infested waters. Closing the Burma Road to China. Royal refugees seeking sanctuary in England. American destroyers swapped with Britain for strategic bases in the Atlantic. General DeGaulle and his "free" Frenchmen. King Leopold surrenders. World's eyes turn to China-Jap struggle as it assumes threatening aspects to United States. And then, closer home, a winter of blizzards; a spring of floods. The Windsors "taking over" at Nassau. Munitions plant explosion. Millions start working for America's defense. And then — America elects a President. Such headline news events will be available to the thousands who collect and maintain home movie libraries.

• Continued on Page 562

• Below: Castle Films' "News Parade of the Year" shows the year's most important events as they actually happened—camera scoops by the world's most fearless newsreel staffs.

Wide World Photos



Authored by
DR. A. K. BAUMGARDNER

THE first few rolls of film which are returned from the laboratory provide the amateur cameraman with a sense of satisfaction due to the revelation of the mystery of the ability to capture motion upon film. These first trials are often considered as marvelous accomplishments and only after they are shown several times do they present faults to the eye of the cameraman which is becoming more critical with each screening. The older the film becomes, the less interest it holds, mainly because new ideas present themselves as to how improvement could have been made.

When these first attempts are analyzed from a technical viewpoint, after the human interest has waned, the film loses its glamour and often takes its place upon the bottom of the future stack of humidors, perhaps never to be shown again. To satisfy the thirst for knowledge regarding the proper technique among beginners, it is my in-



5 FACTORS of successful cinephotography . . .

attention to establish some simple rules of procedure which will insure good results.

It is expensive to "play around" with a camera, learning the hard way what should be considered to obtain satisfactory results. Fundamental rules can be followed for all conditions if a few minutes of study can be spared.

Our first consideration is to enumerate all factors which come under the general manipulation of the camera. No one factor is more important than another, but for simplicity we may list them as follows: 1. Emulsion Speed 2. Light Value 3. Shutter Speed 4. Diaphragm Opening 5. Distance of Focus. The first four of these apply to all cine cameras, the latter to be considered only on focusing lens mounts.

Among the first four factors, there is a definite relationship of balance for the perfect picture. Any one of these factors standing alone has no value. It has value only in consideration of the other three. If we ignore any one of them we are sure to ruin the picture. The first three, as enumerated, determine the value of the fourth and these three are the popular factors which are used on most meters to calculate exposure. An interesting fact to consider early is that the alteration of any one of these three factors will affect No. 4. The advanced amateur soon learns that if he desires to alter one of them for a specific purpose, without altering No. 4, he must alter one of the other two to create a balance.

To properly visualize the complete picture of camera control, consult the enclosed chart and hold the diagram in mind at all times while standing behind the camera. This will eliminate errors, as a complete consideration of all factors will complete the triangle. Until the triangle is complete, you are not prepared to take the picture. To apply this principle, the lens cap must be *in the hand*.

The triangle can not be formed if it remains over the lens. For an example, we start the formation of the triangle, supposing the lens cap to be a piece of chalk by which we prepare to draw the imaginary shape out into space. Let us assume that factor No. 1 is 12 Weston, factor No. 2 is 16 Light Value, factor No. 3 is $\frac{1}{30}$ sec. With these values determined, we automatically arrive back to No. 4 which is $f/5.6$. If the camera lens is of fixed focus, we have thus completed the triangle and the exposure may be made. For those who have focusing mounts, it is necessary to consider the dotted triangle terminating at No. 5 in addition to the basic triangle.

LET us suppose that we substitute a new factor for No. 1 and use an emulsion speed of 24, using the same factor for No. 2 as before. In this case, we must alter either of the two remaining factors to obtain the same exposure. Either we must increase the shutter speed to $\frac{1}{60}$ sec. or change the diaphragm opening to $f/8$.

• Variable shutter speeds have proven themselves to be of great value. For example, an $f/3.5$ lens becomes an $f/2$ at half shutter speed. An $f/1.5$ lens would become so fast at half shutter speed, there is hardly an instance where it could be thus employed.

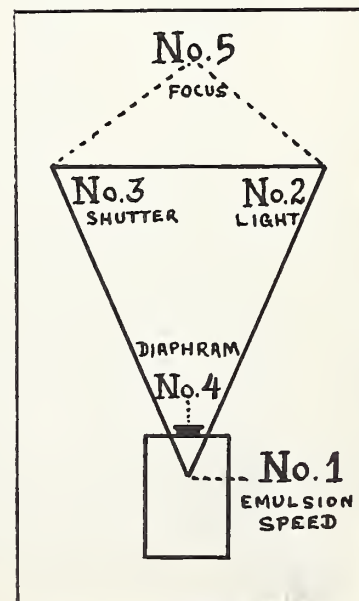

• Continued on Page 548

Reported by
WARREN GARIN



Seventeen CINE CLUBS stage big “get-acquainted” funfest . . . !

LONG after sunset, at the close of that eventful Sunday, September 22nd, little groups remained clustered about the broad lawns of Long Beach's Recreation Park comparing gadgets, discussing mutual cinefilming problems with new found brother cinebugs, or examining the many prizes awarded during the day's program of events.

All agreed they not only had one whale of a good time, but HOME MOVIES' idea in sponsoring a joint picnic for the 17 amateur cine clubs of Southern California was the finest thing that had been done for cinebugs in a long, long time.

Early that day, some 400 cine fans — members of the 17 cine clubs and their families and friends — began to assemble at the picnic grounds. They brought in addition to lunch baskets and thermos jugs, movie cameras, tripods, exposure meters, reflectors, and cine gadgets too numerous to mention.

As they entered the park, each club member was registered and given a handsome badge to wear for the day which bore his full name and indicated his club affiliation. This was a mighty fine idea. If one cinebug saw another toting a camera fitted with a strange looking gadget he wanted to know about, he simply walked up to the fellow,

cocked one eye at the badge to learn his name, and fell right into friendly conversation as though both were old time buddies.

After everyone had been given opportunity to mingle with the crowd and renew acquaintances or make new ones, the day's festivities were officially begun with an address of welcome by Charles J. VerHalen, publisher of HOME MOVIES; also addresses by Mrs. Mildred Caldwell, president of the Long Beach Cine Club and “Bill” Wade of the Los Angeles 8mm Cine Club.

FOLLOWING this, a very interesting demonstration was given of the new Synchronsound System for making 8mm and 16mm sound movies by means of fully synchronized phonograph discs. A complete lip-synchronized sound movie was made with many of the picnickers taking part, and this movie has since been screened for several clubs and other exhibitions are scheduled so that all who attended the picnic and witnessed the demonstration may see the result.

The production staff of the Long Beach Cine Club also shot several scenes for their current club production, “Happy Landing,” that called for

• Continued on Page 557

• Above, left to right — Bert Soul, Poso-deno; Charles VerHalen, publisher Home Movies; Bert Teets, Tri-City Cine Club; Mildred Caldwell, Long Beach Cine Club; Vernon Lorson, Southern Cinemo Club; Willford Lutz, Orange County 8mm Club; Thomas Jeffers, Southwest 8mm Club; and B. B. Vogel, Los Angeles 8mm Club. All officiated in various capacities in 1st Annual Club picnic. On tripod in front of Bert Teets is camera equipped with Synchronsound unit used in making 8mm talkie. Below — Comermen lined up, filming festivities; registration of members; and group examining new camera gadgets demonstrated by Charles VerHalen.





Ray Fosholdt

THERE ought to be another photo on this page — that of LaNelle Fosholdt. It was LaNelle who wrote the original yarn, then the script, from which her illustrious husband, Ray, made the Movie of the Month for November — “Father’s Time.” We are certain, therefore, Ray Fosholdt won’t mind our cutting in his

wife on some of the credit early in this story.

Actually, Ray and LaNelle work hand-in-hand making all of their pictures. LaNelle writes the scripts and acts as dramatic coach, which leaves Ray with only the minor details to attend to — directing, photographing, editing, titling, and processing the film. Ray Fosholdt processes every foot of film he shoots. He has what is probably the most complete home laboratory in these United States. But that is another story.

We like to think what a nice thing it is for a young couple like the Fosholdts to have mutual interest in a hobby such as home movies; a husband and wife deeply if not religiously interested in the same hobby and working happily together to make each effort a big success. Not much of their success has been “narrated” around in the public prints; but around Long Beach, California, where the Fosholdts make their pictures — occasionally with members of the Long Beach Cine Club to which they belong — their achievements are well known.

NOW, their latest 16mm triumph, “Father’s Time,” having acquired the additional honor of Movie of the Month, will make them better known throughout the vast realm of amateur movie-making.

“Father’s Time” is a home movie that any amateur might make, full of human interest and humorous situations. The story concerns a man who, at the end of a working day, purchases his favorite magazine on his way homeward, and then, after reaching home, endures many trials and tribulations seeking opportunity to read it without family interruptions.

The opening scene is that of a pendulum of a huge clock swinging back and forth, ticking off the minutes. There is a dissolve to the face of the clock showing the minute hand just as it reaches 12 and indicating exactly 5 o’clock. This is followed by a scene in a machine shop. A man — “Father” — is working on a piece of machinery. He hears the 5 o’clock whistle, lays down his tools and goes to the locker room to dress. Leaving the factory gate, he stops to buy a copy of *Time* magazine.

The next sequence opens with a fade-in to the kitchen of his home where his wife is busy over the stove preparing dinner. Father enters the room, greets his wife with a kiss, and exits, peeling off his coat.

We next see him entering the parlor, magazine and slippers in hand, and heading for his easy chair in the corner. Having relaxed comfortably,

• Continued on Page 559

MOVIE of the MONTH

Reported by
J. H. SCHOEN

FATHERS TIME //



• These scenes are reproductions from Ray Fosholdt’s 16mm movie, “Father’s Time,” a picture full of human interest and humorous situations, marked by good acting by its entire cast.



TITLE CENTERING GUIDES

*. . . . for 8mm Bolex,
Cine Kodak "90", and
Revere 8mm cameras*

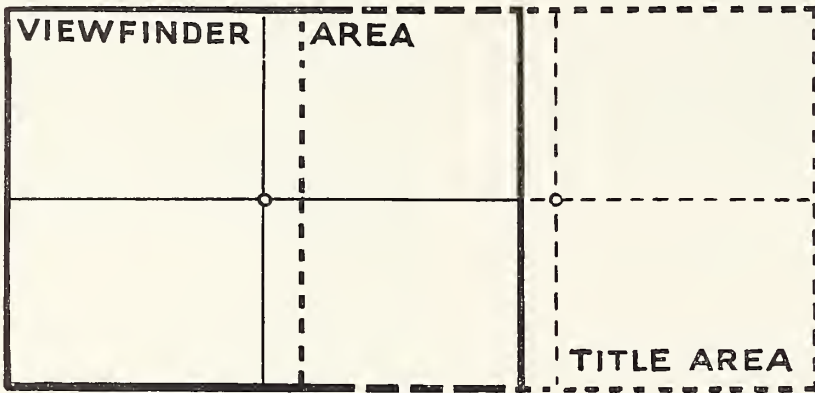

BOLEX 8mm

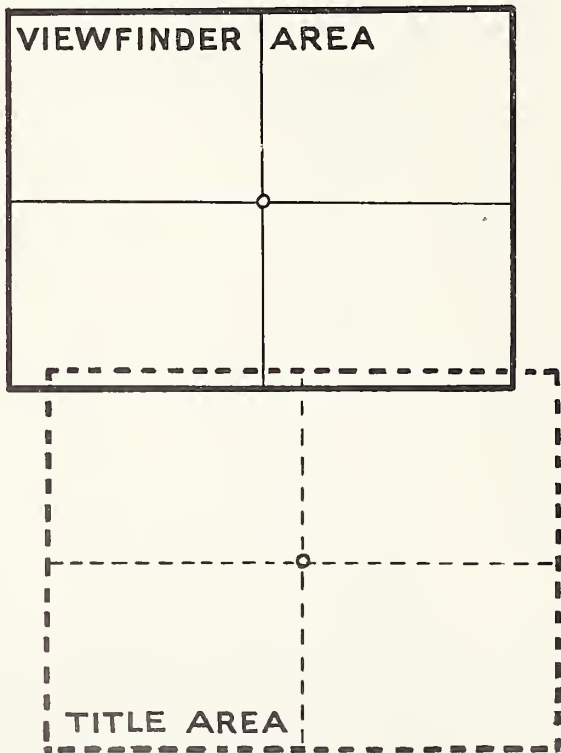

**CINE KODAK "90"
MAGAZINE EIGHT**

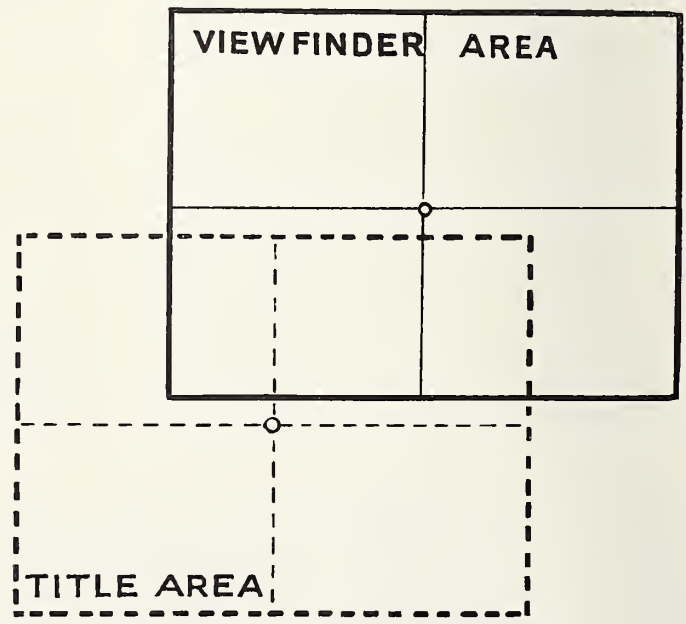

8mm REVERE - ALL MODELS

IF you are preparing to shoot the series of animated cartoons which have been appearing in HOME MOVIES and conclude with this issue, you'll find these centering guides helpful in lining up your camera. These guides just about complete the series for all the important 8mm and 16mm cine cameras. If you missed the issue containing the centering guide for your camera, extra copies are available. Other title centering guides appeared as follows:

Cine Kodak models 20, 25, and 60, and Magazine Cine Kodak — June issue.

Cine Kodak models "E" and "K" — July issue.

Filmo "70" series, Filmo Turret "8", and Filmo single lens "8"—August issue.

Filmo Model 141 and Model 121 Filmo — September issue.

Keystone 8mm, Victor 16mm, and Bolex 16mm — October issue.

Centering guides are not essential for titling with Bolex 8mm or 16mm cameras. The parallax corrected viewfinder of these cameras insures accurate focusing down to a working distance of 18". The guides are published for those who may wish to work with these cameras at closer distances.

Reviews by
THE EDITORS



Tell me—how can I IMPROVE my film?

ADDED facilities now enable the Editors to expedite review and return of films sent in by readers for criticism. Those residing in the East, for example, need no longer hesitate to forward their films for this helpful service, fearing they may be retained too long. Reviewing service is now functioning on a 48 hour return basis — no films will be held longer than 48 hours.

Without charge or obligation, HOME MOVIES' constructive criticism and review service is available to every amateur whether a subscriber to the magazine or not. Films are returned with a written detailed criticism and suggestions for improvement, and with a one, two, three, or four star leader attached. The most outstanding film is selected as "The Movie of the Month."

Some of the interesting films reviewed during October are as follows:

"OPEN TO THE PUBLIC" ★★★

150 ft. 8mm — By D. F.

Continuity: A fine and original idea, picturing the various recreational facilities offered by a large public park. Indeed, the idea alone rates three stars. The picture begins by showing the attractive golf links with many fine shots of players in action on greens and fairways. Following this sequence, are others depicting other amusements afforded by the park — canoeing, the art gallery, baseball diamond, bicycling paths, tennis courts, bowling greens, playing of horseshoes, and then followed winter sports — skating, tobogganing, etc. There was an interesting sequence of the park zoo — interesting because it was not over emphasized by too lengthy scenes as is so frequently done.

So many films made in parks concentrate on the zoo. But this filmer found interest in all of the recreational facilities afforded to the public and

made a wise choice in selecting this theme as the basis for his picture.

Photography: Generally speaking, the photography in this picture should be rated good. There were just a few shots on the golf links that showed too much foreground with players too near the top of the frame line. A better balance in composition could have been had by tilting camera slightly. Otherwise the picture as a whole was well exposed and camera was steady.

Editing: As a whole, scenes were kept to an interesting length. The golfing episode was a little too long, and shortening of scenes in this sequence would pep up the picture at this point. Cutting in of closeups was very beneficial, aiding in maintaining interest. The use of the Fadette between sequences was very effective.

Titling: Well centered and well exposed were all titles which featured backgrounds of geometric design. Special effects on the opening title and the wipe-offs used between main title and first subtitles were well executed.

Equipment: Cine kodak model 20 with an f/3.5 lens, and a tripod.

"RAINBOW BOUND" ★★★

400 ft. 8mm — By C. C. H.

Continuity: This picture is a record of a tour made of remote sections of Arizona where it is necessary to employ pack mules in order to reach otherwise inaccessible but highly scenic regions of this state. The picture opens with scenes of preparations being made for the trip but these wisely were kept to brief footage. The picture promptly gets right into the meat of the subject showing attractive points visited along the route. An interesting revelation was that the party was able to travel but six miles per hour in their automobile

• Above are enlargements from frames of home movie films reviewed this month. Scenes 1 and 2 are from "Open to the Public"; scene 3 is a closeup from "Newlyweds"; and scene 4, one of the many interesting studies of native life in the 8mm film, "Rainbow Bound."

• Continued on Page 558

THE EXPERIMENTAL

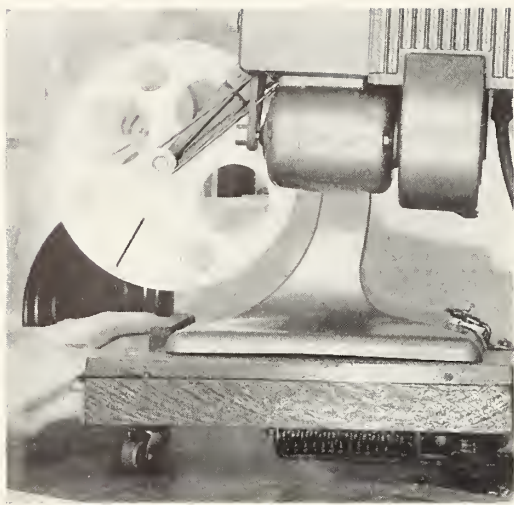

Projector Turntable

In building a separate projection room within my home, it was necessary to place the projector with the sprocket side up close to the wall, as shown in the photo, in order to be able to throw a picture on a screen placed in the center of the wall at the far end of the room.

To solve the problem of threading the projector, I built a turntable as shown which permits swinging the projector around in a circle. A "stop" in the table insures returning projector to the right position each time so realignment with screen is unnecessary.

—A. R. Bowen.

Ink For Glass

An effective ink for printing titles on glass—an ink that won't run, etc.—may easily be made by any amateur from the following formula:

- Glycerine 40 parts
- Barium sulfate 15 parts
- Ammonium bifluoride 15 parts
- Ammonium sulfate 10 parts
- Oxalic acid 8 parts
- Water 12 parts

Mix all parts by weight. The viscosity may be adjusted by adding water. Use the mixture in a hood or well-ventilated room.

—Wm. McGee.

CINEBUGS!

• If you have an idea for a gadget, trick, or shortcut in filming, titling, editing or processing home movies, pass it on to your fellow Cinebugs through these columns. If your idea is published you will receive two reels for your efforts. Extraordinary ideas will net you a roll of film.

Ideas not published will be held for future publication unless they duplicate ideas previously received. Endeavor also to send along photos or rough sketches illustrating your suggestions. There is no limit to number of suggestions you may submit.

Important: When submitting ideas, be sure to mention whether equipment you use is 8mm or 16mm, enabling us to promptly forward awards adoptable to your use.

For Larger Reels

8mm Bell & Howell projectors will accommodate the new 300-foot reels readily if the small guard clip fastened just beneath the lower sprocket is removed. Removal of this clip will in no way interfere with operation of projector, yet its absence provides the necessary additional leeway for the 300-foot takeup reel to fit the lower spindle. 300-foot reels will fit the upper supply spindle without any alteration to the projector.

—Ernest Kremer.

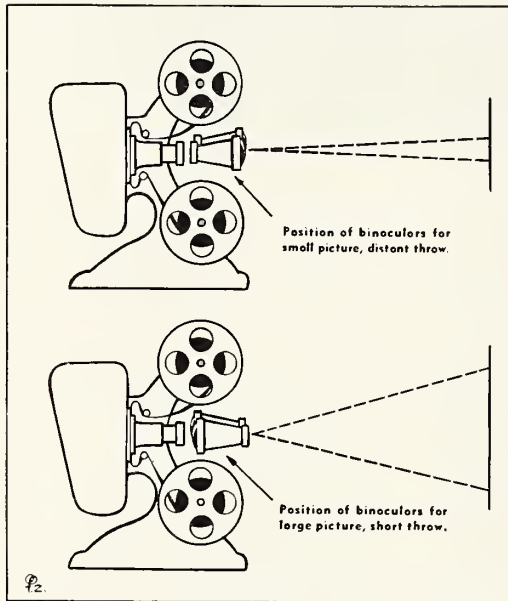
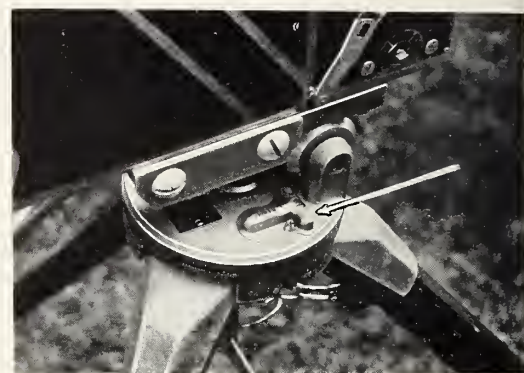

Projection Aid

Altering the size of the projected picture may be accomplished without investment in an assortment of projection lenses of varying focal lengths. When a large picture is desired with a short projection throw, place an ordinary binocular before the projector lens so that the larger lens of the binocular is facing the projector.

Where a small clear picture is desired at a longer than average throw, reverse position of binoculars before the projector, placing the small end before the lens. Sharp focus in both instances may be obtained by adjusting both projector and binocular lenses.

—Kurt Wollner.

Drum Motor

After experimenting with a number of small electric motors of various sizes as a means of turning my developing drums, I finally found one that serves the purpose—the Tinker Toy motors. These tiny motors have just the right speed for home reversal work when used with a 6-inch pulley.

—Oscar Nelson.

Tripod Level

Photo shows a small, two-way spirit level which I mounted on my tripod to aid in squaring up my framing of scenes. The two-way level insures setting up tripod so pictures will be framed perfectly horizontal. The level is one such as used on the computing scales found in grocery and butcher shops and was obtained from a scale repair man. Later I found them to be available from my local hardware store.

—S. P. Painting.

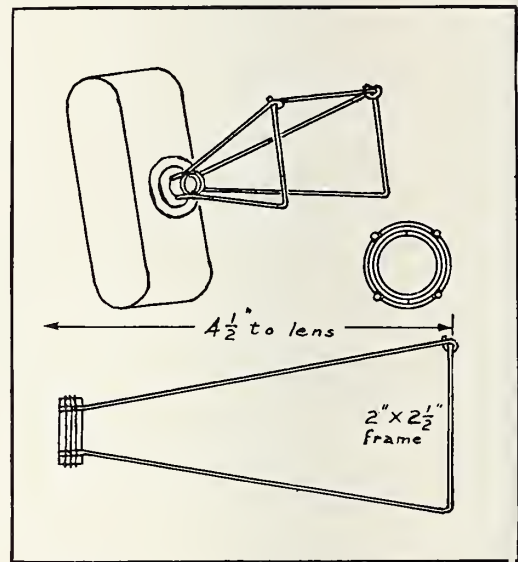

For Ultra-Closeups

For shooting closeups of insects and flowers, here is a simple gadget that insures accurate framing and focusing of the subject. With the lens focused for a distance of 5 inches with the aid of shims, the lens takes in an area of 1 1/2 x 2 inches. I built the wire frame accordingly, allowing an extra 1/2 inch all around, and making it shorter by 1/2 inch in order to make it easier to get closer to some objects without the wire frame getting in the way.

A collar to fit over the lens was made of several thicknesses of cardboard glued together. Then the four ends of the wire frame were fastened to it as shown and glued securely.

—Howard E. Foote.

CINE WORKSHOP

gadgets, tricks and short cuts contributed by Cinebugs

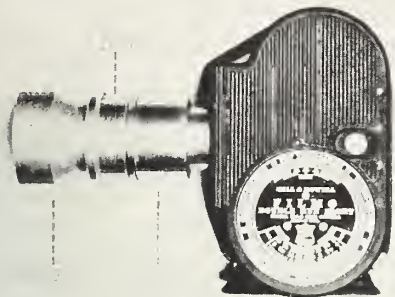

Telephoto Lens

Miniature camera lenses which are removable may be combined with regular 8mm or 16mm cine lenses to form a telephoto lens. All that is needed is a suitable adapter that will hold the miniature camera lens at the required distance ahead of the cine lens.

As very accurate focusing is of great importance, a ground glass should be used to find the required length of the adapter. After the adapter has been machined and fitted, short lengths of positive film should be run through the camera to determine accurate focusing points for various distances. This may also be accomplished by opening the camera, placing a strip of frosted film in the open film gate, and focusing upon it. The determined focusing points may be marked on the mini camera lens by filing notches on the focus-adjustment ring.

The accompanying sketch and photo show the adapter which I built for my

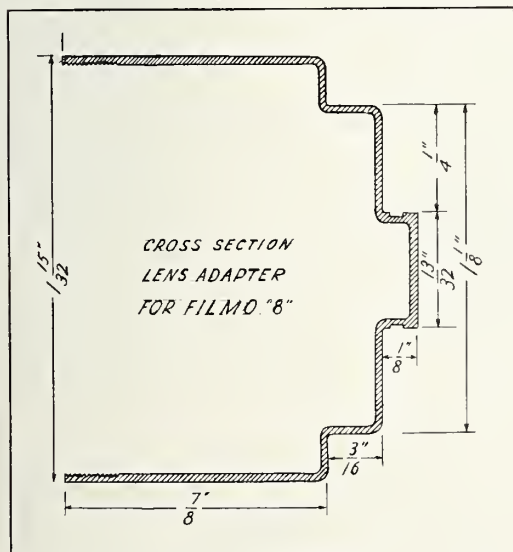

Filmo 8mm camera. The total cost was \$3.00.

Inside of the adapter should be painted flat black. Ordinary india ink will serve very well, and it is advisable to clean the surface thoroughly with acetic acid to remove any oil or dirt left over from the machining process.

—Wilbur W. Sauer.

Titler Camera Mount

As a suggestion to those who may have made use of the plans for the Home Movies Titler, may I tell you that I made easier the fastening of the camera on the sliding platform by hinging the top of the platform. Thus, instead of having to reach inside the small opening beneath the platform each time to turn the camera screw, I merely lift the lid, turn the screw until camera is secure. This also facilitates tightening the bolt which locks the platform to the sliding track of the titler.

—Archie D. Mitchell.

Filter Safety

To prevent losing filters and mounts from my camera lens, I secured a small length of chain from the jewelry counter of the five and ten and some small brass screw-eyes from a hardware store and attached same to my camera as shown in sketch. At one end of the chain is a clip. This is attached to a small screw-eye soldered or cemented to the lens mount. The arrangement is protection against loss of either filter or mount in case same become detached from camera lens.

—W. E. Ogden.

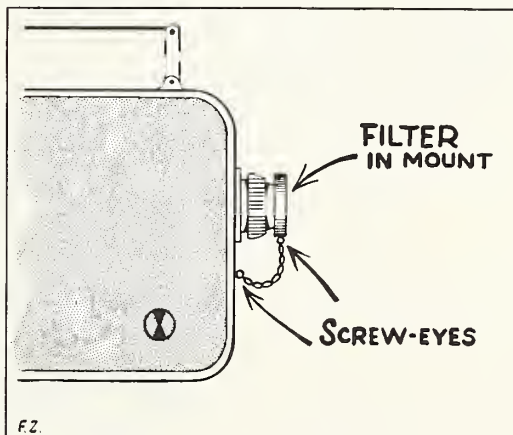

Speed Checker

Here is a convenient method for checking the speed of either 8mm or 16mm projectors:

A strip of opaque film, 81 frames in length and of the correct width—8mm or 16mm—for the projector to be tested, is obtained. The average amateur will have some of his film available in the form of scraps. Also a piece of positive film may be used after fogging and developing it to make it fully opaque.

This strip of film is spliced into a closed loop of exactly 80 frames. Then scrape the emulsion from one frame so as to leave it transparent; repeat this procedure every sixteenth frame so that the closed loop will have five clear spaces

or frames, each separated by the equivalent of fifteen frames of film.

After threading this loop into the projector, projector speed should be adjusted so that one flash of light occurs every second. This is best done by counting the number of flashes over a period of one-half minute.

—Harold C. Martin.

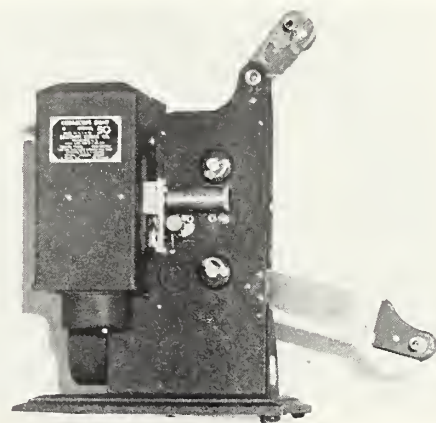

For 400 Ft. 8mm Reels

Photo and sketch show method of converting Model 50 Eastman projectors to take 400-foot reels. The necessary alterations do not impair the trade-in value of the projector as the additional parts may be quickly detached.

The sketches are self explanatory. Probably the most difficult part of this conversion is the drilling and tapping of the upper pulley. To disassemble this pulley and shaft, it is necessary to un-rivet the pulley and then the shaft must be drilled and tapped for a 4-36 brass screw in order to reassemble it.

—W. Raymond Henry.

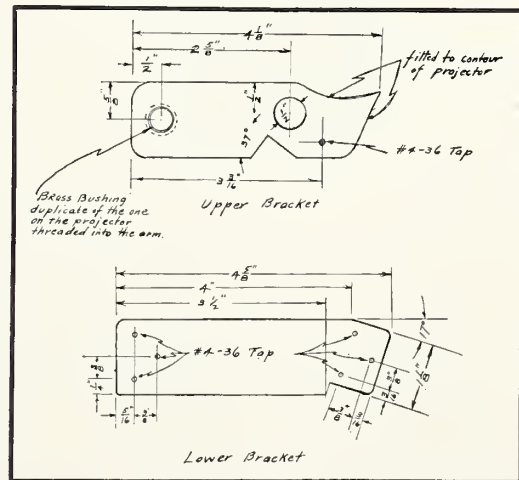

"IT'S NEW TO ME"

By CINEBUG SHOPPER

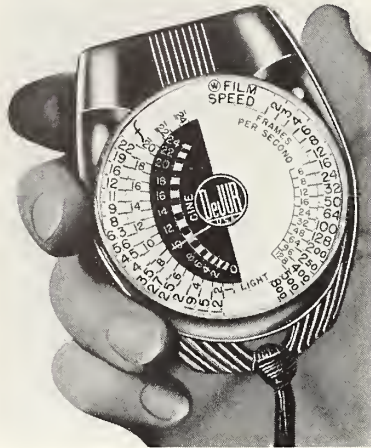

DeJur Cine Meter

Following recent advent of the DeJur "Critic" Model 40 exposure meter, comes the new and different DeJur "Critic" Cine Exposure Meter designed especially for moving picture making.

Among the many features are: Sensitivity from .1 to 4000 candle light; narrow viewing angle, particularly adapted to movie camera lenses; film speeds from .3 to 800 Official Weston; shutter speeds from 6 frames to 128 frames per second; one hand operation, for use in either the right or left hand; a special Alnico magnet, which is rated to be the strongest magnet known; fine jeweled galvanometer movement; a stable, ultra-sensitive, American made photo-electric cell; and a locking device which facilitates quick readings.

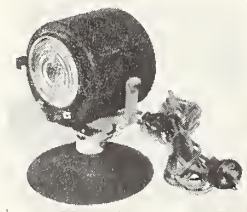

Baby Spot

Cost problem of spotlight equipment for the amateur has been solved by Frank A. Emmet Co., with advent of new Academy Baby Spotlight retailing under \$7.00 per unit. Weighing less than three pounds, it takes 100, 150, or 200 watt T-8 bulbs, and is

equipped with 3 inch Fresnel lens with attached slots for holding diffusion disks, etc. Interesting feature is ability to change from spot to floodlight by simple rod adjustment. It comes equipped with 12 foot cord and switch. Further data is available from manufacturer at 2707 West Pico, Los Angeles.

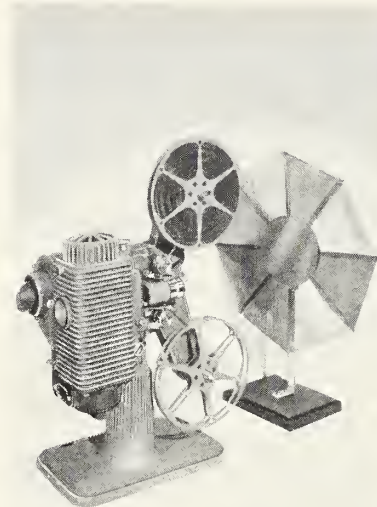

Add-Color

Friedel's, Huntington Park, Calif., are introducing "Add-Color"—a rotary color wheel for use in conjunction with projection of home movies for adding color tones to screened pictures. The wheel is made up of eight separate colored celluloid segments. The wheel, attached to an upright standard that sets before the projector, is adjustable to fit all makes of projectors. It is said to meet the demand of those amateurs screening mixed rolls of color and black and white films, by enabling them to add pleasing overall color to the black and white films during projection.

Baia Moves

Shortly after October 1st, Baia Motion Picture Engineering Co., manufacturers of the Baia Film Slitter and other cine accessories, moved to their new and larger quarters at 259 Gerald Street, Highland Park, Michigan. Added demand for the Baia Cine

Transito is credited with forcing the firm to seek larger quarters.

B&H Disc Recorder

The new Filmosound Recorder and Record Player, just announced by Bell & Howell, promises to be of real importance to those interested in school or home recording. The new combination unit is complete in its case without amplifier, plugging directly into the Filmosound and making use of the amplifier in the sound projector.

The depth of the cut made by the crystal cutting head is said to be readily adjustable to different types of record blanks and recording needles, and a convenient volume level indicator permits even an inexperienced operator to modulate the recording volume to the proper level.

For further information, write to Bell & Howell Company, 1801 Larchmont Avenue, Chicago, Illinois.



Copying Stand

An ideal setup for copy work of the most critical and exacting types is provided for by the new type Solar copying stand just announced by Burke & James, Inc., 223 W. Madison St., Chicago Illinois. It is for use with any type of camera with suitable bellows extension or supplementary copying lens.

An adjustable camera supporting arm permits camera to be brought down within 8 to 10 inches from the base

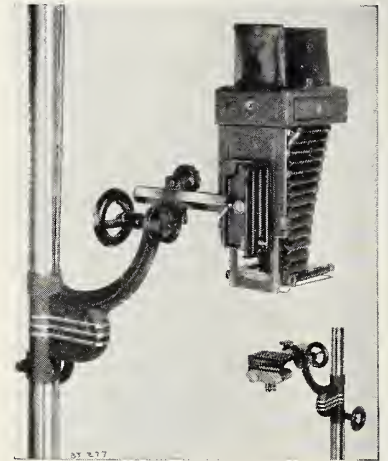

board, depending upon the size of the camera used.

A sliding rod, hexagonal in shape, permits in and out adjustment over an 8-inch range and makes it possible to set the camera at any one of six different angles.

Reels in Color

Moviette, Inc., 320 West 42nd St., New York, have introduced a vogue in projector reels. Their 750-foot reels are now available in red, white, or blue finish. They are said to be especially appealing as a gift for movie amateurs.

Redi-cut Titler

Hollywood Movie Supply offer a new innovation this month—a complete knocked down kit of parts for a movie titler, which may be assembled easily in about 15 minutes. Designed for typewritten titles, all parts are made of wood. Title card holder is designed as a stage permit-

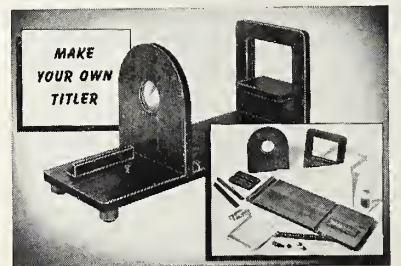

ting, also, the filming of ultra closeups on stage floor. Additional accessories include a 5

dioptré auxiliary lens, celluloid framing mask, 1 The End title card and an assortment of title background cards. Complete instructions for assembling are also included. For data, write the manufacturer at North Hollywood, Calif.

Ready Made Titles

Frank A. Emmet Co., Los Angeles, are making available a wide range of ready-to-use home movie main titles in both 8mm and 16mm. Most of these stock titles are made on artistic background and are packaged complete—one title to a box—and available from many photographic dealers in principal cities. Additional data and title lists are available directly from Frank A. Emmet Co., 2707 West Pico.

New Meter Feature

A new interchangeable hood with pre-set calculators for present owners of the G-E DW-48 exposure meter has been announced by the General Electric Company. Especially designed to fit present DW-48 exposure meters, the calculator hood is particularly adapted to movie making, but can be used for stills as well. The calculator's pre-set feature makes further adjustment unnecessary once it has been set and locked.

The interchangeable hood is standard equipment on the new G-E Type DW-49 exposure meter for movie making, available at photographic dealers on October 1. Featuring the same instrument element and general appearance as the DW-48, this new exposure meter is so designed that the DW-48 calculator hood can also be used with it.

Prepared Scenarios

Western Movie Supply, 254 Sutter St., San Francisco, is distributing agent for the new Wesco Home Movie Scenarios. Actually, each scenario comes boxed with many props necessary for successful filming of the story. Six scenarios and kits are now available, and are to be had from most camera stores and photographic dealers.

Invariably THE CHOICE OF CRITICAL AMATEURS



"DOUBLE-EIGHT"

"SIXTEEN"

Because, among other things, only BOLEX has these exclusive and important features:

Automatic threading with pre-farmed loops

Facial-plane type, 190° rotating disc shutter

Clutch far forward or reverse filming by hand crank

Special 3-lens turret

Tri-facial, parallax-correcting viewfinder

Single-frame mechanism

Lateral spring tension in the gate

BOLEX is the easy-to-operate movie camera

BOLEX produces better pictures in the "professional" manner

And, of course, BOLEX has practically every other feature found in the best cameras

CUSTOM BUILT

BOLEX is, in practically every way, a custom-built instrument. Every important part is carefully fitted and numbered with its reciprocal part—assembly is not a haphazard proposition but rather a meticulous process. E. PAILLARD & Co. are internationally famous as manufacturers of precision-made instruments—a reputation earned through 126 years of uninterrupted production. That's why every BOLEX is guaranteed against defects in workmanship and materials for two years.

Yes, it has everything—versatility and adaptability are built right into BOLEX. You can do with it nearly everything that you see done on the professional movie screen. At your finger tips are the means to produce slow motion, animations, single-frame "stills," super-impositions, fades, close-ups, lap-dissolves and all the other "professional" effects that add so much to the interest of personal movies. And of greatest importance is the fact that BOLEX films are always rock-steady and when properly exposed are of the most beautiful photographic quality. Ask your dealer to show you how BOLEX meets and masters every movie-making situation—see for yourself how it feels just to handle the world's finest sub-standard cine camera. Then you will know why critical amateurs by the thousands choose BOLEX. Send today for new 52-page catalogue.

AMERICAN BOLEX COMPANY, Inc.
155 EAST 44th STREET • NEW YORK, N. Y.

Bolex

paillard

THE WORLD'S FINEST

It's cheaper to buy a BOLEX at the start — so see a BOLEX before you buy!

PLEASE THE
MOVIE-DIRECTOR
OF THE FAMILY!
GIVE THIS
WESCO GIFT
COMBINATION!



Amateurs can Get "Big Studio"
Results in their HOME MOVIES
by Shooting a Wesco

Home Movie Scenario

with this professional

FADE-IN & FADE-OUT and these
6 POPULAR
MASKING
EFFECTS



Attached to
Keystone
Camera

Wesco's

FADETTE

combined with

FADE-O-MASK

regular price \$8.45

specially priced
complete with holder and
three double masks \$7.75

WESCO FADETTE—the only vignetter producing a rectangular fade at ANY desired speed. Gradual Fading—In or Out—Fast or Slow at the will of the operator. NO SUDDEN SHUT OFF. Light weight . . . rugged construction. Fits most all cameras. \$5.95 Comes with cable release and filter holder.

Special adapter for Eastman lenses 75c. When ordering specify make and model of camera.

WESCO FADE-O-MASK—holder of durable tenite, takes the place of filter holder. Attached quickly and easily to the Fadgette. The Wesco Fade-O-Masks of thin flexible pyralin are quickly and easily interchangeable, and give the movie maker an \$2.50 unlimited range of novel effects.

Home Movie Scenario

Professional Hollywood Shooting Scripts for amateur movie makers with filmed Titles, clever praps, Title cards — your name on a screen credit card — all to double your film fun.

What a Picnic \$1.00 Shapes of Bath \$2.00
Pickle Party Pranks . . \$1.75 Home-e-o and You-li-et . . \$3.00
Plots & Blots \$1.75 We do the Darndest Things \$2.50

Ask Your Dealer for a Demonstration.

WESTERN MOVIE SUPPLY CO.
254 SUTTER STREET SAN FRANCISCO

5 Factors of Cinephotography . . .

• Continued from Page 539

Or in case we wish to substitute a value for any of the other factors, we must make an alteration to maintain the balance. Many amateurs have found the advantage of increasing the light value, particularly for a limited diaphragm opening. Also, by increasing the emulsion speed, we may use smaller diaphragm openings to sharpen detail.

At this point, we may consider the advantages of faster emulsions. At first thought, one might suppose that the faster emulsions are supplied for the purpose of filming under adverse light conditions. This is only partly true, as they serve a more important purpose in allowing us to use the same light factor but with a smaller opening. This increases the depth of focus and is the best method known for sharpening detail.

Variable shutter speeds have proven themselves to be of great value, not alone for changing the speed of motion, but for the possibility of altering exposure. Still objects, such as flower gardens, scenic views, statuary, buildings or most any inanimate material can be filmed at any speed if the other factors are balanced to correspond. This is of special importance when one does not have control over light conditions otherwise. Half speed has been of great value to indoor inanimate photography when light conditions are poor. By comparison, this is the same flexibility of the still camera shutter. It is amazing to consider the potential reserve power of an emulsion when filming at half speed.

For example an $f/3.5$ lens becomes an $f/2$ at half shutter speed. Or if we wish to compute the theoretical emulsion speed, it will double its value, using half speed shutter action. An $f/1.5$ lens under this rule becomes so fast that we hardly know of an instance in which it can be employed. Many amateurs are startled at their

own possibilities when they pause to analyze these factors along this line of reasoning. It is regrettable that many owners of amateur equipment fail to utilize these many advantages which the manufacturers have given them.

All of the above is based upon many other important assumptions not the least of which is the consistent use of a good tripod. Perfect camera control depends upon tripod application and while many manufacturers stress the ease with which amateurs can take pictures by holding the camera in the hand, it is a mistake to over-estimate the efficiency of any camera without a tripod. A camera should not be considered a complete piece of equipment in itself. It is certainly only one unit of the complete equipment which should include a tripod and a meter.

For those amateurs who desire to advance rapidly, the suggestion is offered that an evening be spent with the unloaded camera

set up at home for theoretical observations. Having placed the camera on tripod, photoflood lamps in position, meter in hand, an object may be selected as the subject and the imaginary triangle may be formed. Using a hypothetical emulsion speed to correspond with the popular brands of film, calculations may be made by altering the light value, shutter speed and diaphragm opening. By altering one at a time, it is rather easy to see what compensations must be made to maintain the balance of triangle factors.

A good plan is to arbitrarily create some imaginary factor value and supply the others to correspond. In this way, one soon becomes familiar with his equipment and the proper applications of the principles. Study of this nature is just as fascinating as actual film work and the vast improvement in picture quality will become apparent at the first

Movie of the Month

• Each month the editors of HOME MOVIES select the best picture sent in for analysis and designate it "The Movie of the Month." This movie is given a detailed review and a special leader is awarded the maker.

This award does not affect the eligibility of such films for entry in the annual HOME MOVIES CONTEST. They are automatically entered for rejudging with those films submitted especially for the annual contest. Films awarded the honor of MOVIE OF THE MONTH during past 12 months are:

1939

DECEMBER: "Souvenir," produced by Harold E. Remier, Hollywood, Calif. A 100-ft. 8mm Kodachrome film.

1940

JANUARY: "The Cauldron," produced by Dr. R. E. Gerstenkorn, Beverly Hills, Calif. A 16mm picture 400 ft. in length.

FEBRUARY: "Whistling Wings," produced by W. H. Nordin, Austin, Minn. A 16mm Kodachrome picture 400 ft. in length.

MARCH: "Checking Off the Budget," produced by B. W. Johnson. An 8mm Kodachrome film 1000 ft. in length.

APRIL: "El Lobo," produced by Demetris Emanuel. A 16mm picture 400 ft. in length.

MAY: "From A to Z," produced by Vernon Altree, Stockton, Calif. A 16mm Kodachrome film 400 ft. in length.

JUNE: "Peetie," produced by Edmund Turner, Detroit, Mich. A 16mm Animated Cartoon, 400 ft. in length.

JULY: "Song of the Soil," produced by E. C. Denny, Buffalo, N. Y. A 16mm Kodachrome film 800 ft. in length.

AUGUST: "St. Margarets," produced by Gordon MacCormack, Montreal, Canada. A 16mm Kodachrome film 400 ft. in length.

SEPTEMBER: "Angels Are Made of Wood," produced by Herman Bartel, New Rochelle, N. Y. An 8mm Kodachrome film 200 feet in length. (Winner Lloyd Bacon Trophy, 1940 Amateur Contest.)

OCTOBER: "Driftwood," produced by A. O. Jensen, Seattle, Wash. An 8mm Kodachrome film 400 feet in length.

NOVEMBER: "Father's Time," produced by Raymond Fosholdt, Long Beach, Calif. A 16mm picture, 400 feet in length.

opportunity to use the loaded camera.

If the beginner will imagine himself standing with the camera at the first point of the triangle at all times, he cannot fail to get first class results. When he advances to that point where he wishes to employ filters, he will naturally consider the application of a filter as an alteration of the light factor. Thus, he will increase his diaphragm opening to allow for this alteration according to the filter value. This system not only exposes much of the mystery pertaining to cinematography but makes it a more interesting hobby because of its flexibility brought about by a thorough understanding of basic values.

One of the deplorable situations which we often see when we view amateur pictures is the failure of the operator to take full advantage of his basic factors. Camera control is very positive by the use of the triangle method. Ordinary picture material takes on dramatic atmosphere when the balance of the factors is complete.

Even with the restrictions of the least expensive equipment, many amateurs have devised methods of getting the most out of those factors which are adjustable. Assuming that we have a lens of $f/3.5$ and no more, constant shutter speed with no variable adjustment, we still can raise the efficiency of these factors through the application of increasing the light value or the emulsion speed or both.

However, the ideal working equipment is that in which all factors may be varied and if they are properly understood so that they do not get out of control, the amateur film work closely rivals that of the professional. Enterprising photographers are never satisfied to stay in the snap-shot class.

This method is not a theoretical experiment but a definite plan by which any amateur may master his equipment in the shortest possible time. After a little practice the triangle may be visualized and completed in less than one minute before shooting the scene. For

PATTERNED AFTER *Hollywood* STANDARDS



FOR
16mm
FILM

\$ **7⁹⁵**

F-R CINE *Action* EDITOR

Hollywood sets movie standards — and F-R has gone straight to screenland's capital to bring to eager cine photographers an *action* editor patterned after those used in the motion picture industry. Features which heretofore had proved troublesome to the amateur were eliminated and many new advantageous special features were added. Those you would expect to find only in much larger and more costly equipment — yet the F-R Editor is simple to operate, gives a professional job and costs

so little. Learn what real fun *more efficient* editing can be — "the F-R Way". "Foreword" to "Finis" be proud of your pictures. Leading dealers everywhere will be glad to demonstrate the F-R Cine Action Editor to you — for it represents one of photography's truest values. Look for the F-R symbol, "the little man", before you buy — it's your guarantee of photographic excellence always.

Outstanding Features of the F-R Cine Action Editor are:

- Permits films to be edited showing the actual motion picture — or stopped for prolonged inspection of "stills"
- Smooth continuous viewing of films magnified four times the original size
- Easy to operate — the Editor is simply placed between two rewinds
- Highly efficient though using low wattage lamp which give all the essential illumination without excessive heat.



FINK-ROSELIEVE CO., INC. NEW YORK • CHICAGO • LOS ANGELES

BRITELITE-TRUVISION HITS!

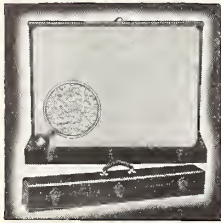

De Luxe A Screen
America's No. 1 screen with the Britelite Wide Angle Crystal Beaded Fabric, reflecting more light to all viewing points. Pull up to use, pull ring to close. Fine leatherette covered all wood case with attractive nickel trimmings. Complete range of movie and slide sizes. Prices from \$13.00 to \$57.50. Sizes from 22x30 to 54x72.

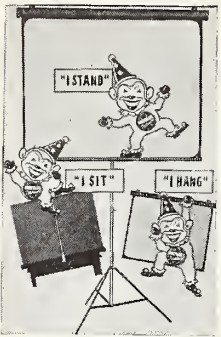

Tripod Model Screen
For those who prefer a tripod model, here it is, with the Britelite Wide Angle Crystal Beaded Surface, that reflects more light to all viewing angles. Black masking border. Black crackle tube and Cadmium finished tripod. Easy to set and easy to carry. 8 sizes for movie and slide projection from 30x40 to 54x72 . . . \$15.00 and up.

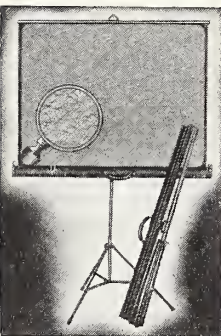

Triple Duty Screen
America's most versatile screen. Sensational for its low price and utility. Britelite Crystal Beaded Screen in black crackle tube that hangs on wall—stands on table or on its own tripod. Sizes from 30x40 to 36x48. Prices, \$10.00 to \$13.50—10% higher west of Rockies.



Britelite Sunspot
4 1/2 in. diameter heat resistant Fresnel Lens—uses No. 1 Photoflood. Focusing from table top and portrait to full length, color or black-and-white. Amply ventilated aeronautical aluminum housing. Complete with bulb and table base. Price \$10.95.



No. 519 Spotlight
The pioneering 500-watt FRESNEL Lens modeling Spotlight that outperforms the conventional 2000-watt Spotlight. Price, \$19.75.



No. 20 Superflector
The only all purpose reflector designed for all types of photography. Properly centering for maximum performance, either No. 1, No. 2 Photoflood A 25 or 500-watt T20 bulb. Price, \$3.50.

SEE THESE AT YOUR DEALERS OR WRITE FOR COMPLETE SPECIFICATIONS AND THE BRITELITE CATALOG. DEPT. H. M. 11.

MOTION PICTURE SCREEN and ACCESSORIES CO., INC. 351 West 52nd St., New York City



those new owners of cine equipment who are bewildered by the mysterious markings on the camera, allow me to suggest that each graduation has a definite meaning and value and the earlier one becomes acquainted with them the greater will be his interest in the unlimited possibilities which will lead him into the advanced stages of professional work.

This method also provides more possibility of trick photography through the alteration of those factors necessary to produce unusual effects. There is scarcely an instance in which one could not produce, artificially, light conditions to represent different times of day or even night. Experimentation is most fascinating with this control, as it is not doubtful in its effect as long as the knowledge is properly applied.

Animated Cartoon . . .

Continued from Page 532

such practicing with a length of exposed film threaded in the camera; as with some, there is a difference in the tension on the starting mechanism when the camera is threaded with film as compared to when it is empty.

It should be possible to expose about 15 to 20 feet of film per hour, once preliminary tests have been completed. For the best work, tests are advisable—tests of the starting button, as suggested above; tempo—that is, determining the number of exposures of each drawing desired; and centering of drawings in titler or animating board.

This series of animated drawings, in three installments, are intended as lesson number one for those many amateurs who have repeatedly implored the Editors to provide the material for simple amateur cartoon animating. The drawings were purposely kept as simple as possible as was the action. To have made it complicated would only have served to discourage many before they might have started.

So go to it. You'll like this phase of home movie making!

Prize Title Trick . . .

Continued from Page 530

of the year for amateur titling achievement and awarded Aldrich a handsome trophy indicative of the honor. That interesting little piece of glass had potential possibilities in an altogether different field. Aldrich recognized them, experimented, and made a discovery that might be termed a contribution to home movie making.

The accompanying photos are enlargements from frames of the main title of Aldrich's "Susanna" and illustrate one of the effects produced in making titles with this glass. The sketches show the manner in which Aldrich manipulated the glass before his title card in order to produce the effect.

As may be observed from the photos, the result is a combination of semi-dissolve and ripple effects. Spectacular dissolves may be produced by this method without having to wind back a single frame of film. But perhaps we're getting ahead of our story. Illustrated in the sketch, at Fig. 3, is a cross-section of the archi-

tectural glass we've been making all the fuss about. According to Aldrich, the glass is called "Broad Reeded" and is manufactured in England, but is obtainable from almost any large glass house in this country. The Libbey-Owens-Ford Glass Company manufacture a similar glass called "Flutex" that can be used to produce the same effects.

Aldrich secured a piece of this glass sufficiently large to cover the size of the title cards used in his titler. This was important. Then, prepared to film a title, a fade-in was accomplished as shown in Fig. 1. The glass held close to the camera lens on starting the camera, and with the "flutes" running parallel to the title lettering, was gradually lowered until within a few inches of the title card, then drawn straight out and away from the titler as shown. The title, when projected, appeared as shown in the photographs. The title lettering appears distorted at first and divided into several lines. Then, as the fade is completed, the title is clear and sharp.

Exposure Meter Guide

CORRECTED OCTOBER 1, 1940

	SCHEINER		WESTON			SCHEINER		WESTON	
	Day	Mazda	Day	Mazda		Day	Mazda	Day	Mazda
AGFA					GENERA				
16mm SSS Pan.	29	27	100	64	Meteorpan	23	21	24	16
16mm Hypan.	24	23	32	24	Normal Panchromatic	20	18	12	8
16mm Panchromatic	21	20	16	12	Super Ortho	21	17	16	8
16mm Supreme Pan. Neg.	27	25	64	40	Movetone Ortho	19	13	10	3
16mm Finopan Neg.	23	21	24	16	Semi-Ortho.	18	12	8	2
16mm Positive	12	8	3	2					
16mm Plenachrome	20	12	12	3	KIN O LUX				
8mm Twin-8 Hypan.	23	21	24	20	No. 1	16	6	6	..
8mm Filmopan	18	16	8	5	No. 2	18	16	12	12
					No. 3	26	24	50	40
DUPONT					CONSUMERS				
Reversal Pan	21	19	16	10	Ortho	18	8	8	..
Regular Pan Neg.	20	18	12	8	Panchro.	23	21	24	16
Superior Pan Neg.	24	21	32	20	Colorchrome.	18	8	8	..
Positive	12	..	2	1-6					
					HOLLYWOOD				
EASTMAN					S. S. Pan.	26	25	50	40
16mm Super XX Pan.	24	..	100	64	Pan.	21	20	16	12
16mm Super X Pan.	24	23	32	24	Semi-Ortho.	18	12	8	2
16mm Safety	20	18	12	8					
16mm Sound Pan	23	21	24	16	UNIVEX				
16mm Pan. Negative	23	21	24	16	Standard	17	14	6	..
16mm Positive	16	10	5	3	Ultrapan.	20	18	12	6
8mm Super X Pan.	23	21	24	16					
8mm Regular Pan.	18	16	8	5	GRAPHICHOME				
Kodachrome (8 & 16mm)	18	14*	8	3*	Regular	18	10	8	3
Koda. "A" (8 & 16mm)	18*	21	8*	12	Plus	20	17	12	6
GEVAERT					Superpanex No. 100.	29	27	100	64
Super Reversal.	23	21	24	16	Superpanex No. 24.	23	21	24	16
Panchro.	20	18	12	8	Colortone.	18	10	8	3
Ortho.	21	17	16	6					

*With filter.

To fade-out, the glass was manipulated in the reverse manner as indicated in Fig. 2. The glass, with the "flutes" running parallel to the lettering as before, was held outside the field of the camera, as shown in the sketch, and then, as the point was reached for the fade-out to begin, the glass was moved in over the title card and then upward toward the camera lens.

To produce a dissolve in making titles, according to Aldrich, all that is necessary is to stop the camera at the end of a fade-out with the glass near the camera lens; change title cards; reverse the camera again and reverse the movement of the glass to produce a fade-in.

Other variations of fade-ins and fade-outs may be produced with this glass. While being raised or lowered between title card and camera lens, it may be twisted or rotated slightly, as shown in Fig. 4, or it may be tilted. For such effects, however, the panel of glass must be sufficiently large to cover the title card at all times during movement between lens and title.

Although Aldrich used a vertical titler for these titles, the use of this fascinating glass is by no means limited to this type. Obviously, it may be used with any titler, from the small typewriter style to the large outfits taking cards up to 9 by 12 inches. With the typewriter titlers, the glass will have to be drawn away from the title card at the top instead of at the bottom, but the effect will be the same. One variation is to draw the glass away at the side, but this requires that the "flutes" run vertical instead of parallel with the title lettering in order to produce the desired effect.

Aldrich also informed us that architectural glass is obtainable in a wide variety of patterns, many of which can be used for odd and interesting effects in title making when manipulated before the title card as just described. Aldrich's discovery is indeed an important contribution to strictly amateur technique in movie making—a contribution for which amateurs the country over will be deeply grateful.



Everything you want in a TITLE MAKER

Now you can dress up your films. Make flip-flops... zooms... receding titles... turn-arounds... silhouettes... shadows... fade-ins... fade-outs... handwriting... moving letters... animations... book covers... rear projections... etc.

THE BROWN MICRO-MATIC TITLER IS PRECISE, ALL METAL, AND PROVIDES FOR QUICK AND CERTAIN ALIGNMENT

No other title maker provides the optical bench precision (so essential in making worthwhile titles) that is found in the BROWN. Other advanced features include: Vertical or horizontal mounting... self-locking camera mount... positive lens and easel alignment... full adjustable reflectors... self-centering supplementary lens holder... accurate field-of-view chart... demountable title frame

which will hold any desired background... any 8mm or 16mm camera fits on the BROWN. The BROWN TITLER complete includes: Opal glass, clear glass, and cork backgrounds, 9" x 12"... reflectors with adjustable brackets... 12-ft. extension cord... vertical pivot bearing... target sight and auxiliary lens holder... field chart for lenses... and full instructions... **\$27.50**



Make FADES & DISSOLVES as you go

Nothing else like it!
64 DIFFERENT EFFECTS
automatic
TIMED AND OPERATED BY CLOCKWORK MECHANISM
COMPLETE **\$17.50**

THE Bool CINE-FADER
FITS MOST EVERY MOVIE CAMERA

Make Fades and Lap-Dissolves "As You Go" With the Honky BOOL CINE-FADER. Unlimited Number of Varied and Pleasing Effects. Also Works as Fader Over the Lens of Any Projector.

Cinea FILM CEMENT

The only film cement for all kinds of film... acetate or nitrate... 35mm, 16mm or 8mm. Odorless, doesn't bleach color. Joins film quickly and strongly. Perfect for use with Cinea 30 Splicer. Bottle... **25¢**

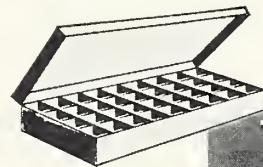

THE Master TITLE KIT

—the best letters for your home movie titles.

ABCDEFGHIJKLMNOPQRSTUVWXYZ
1234567890
abcdefghijklmnopqrstuvwxyz
-?!,.

No movie maker should be without this handy title letter kit. 222 characters... 5/8-inch capitals. Plain back... or, if desired, pin back on special order. Packed in box with exclusive template composing gauge and full instructions... **\$12.50**

Cinea 30 SPLICER

For 8mm and 16mm sound and silent film. Makes better splices with less effort and considerably more speed. Fewer movements are necessary and, most important, the splices are perfect every time. Precisely made, all steel, will fit on most all editing boards... **\$10.00**

CINELAC FILM PROTECTOR

LIFE-TIME FILM PROTECTION NO SCRATCHES, BRITTLINESS or CURL

CINELAC permeates and toughens emulsions... seals in moisture... prevents excessive aging... protects negatives and motion picture film. CINELAC-treated films can be enjoyed time and again, year after year, projected and re-wound, without damage. No apparatus needed... easy to apply. Bottle... **\$1.00**

AMERICAN BOLEX CO., 155 EAST 44th STREET, NEW YORK, N. Y.

GET THOSE DISTANCE SHOTS!



Price
\$73.00

With This 4-in., F3.5 DALLMEYER CINE TELEPHOTO

For 16mm Models

For **FILMO, BOLEX, VICTOR, KEYSTONE**

Other Models

World famous for greatest accuracy and optical precision, these popular Dallmeyer Telephotos are supplied for practically all makes of Still and Cine cameras (both 8 and 16mm). You will increase the use and enjoyment of your camera to an amazing degree by means of a Dallmeyer Telephoto.

Booklet Describing All Models on Request



15 W. 47th St. New York, N. Y.



Black-White
100 FOOT SAFETY FILM
100' DAYLIGHT LOADING
SPOOL FOR 16 MM CAMERAS
REVERSIBLE
198
16mm—100 ft.
Reversible Film
Incl. Processing
\$1.98
Rating: Weston 12, Scheiner 18.
At your dealer or direct. Fast service processing same day included at no additional cost.

BETTER HOME MOVIES

With **BLACK and WHITE FILM**

REVERSIBLE FILM
25 ft. Double 8mm
Including Processing
98¢
Rating: Weston 12, Scheiner 18.
At your dealer or direct. Fast service processing same day included at no additional cost.



VISUAL INSTRUCTION SUPPLY CO.
1757 Broadway Box H6 Brooklyn, N. Y.

FILMGRAPH
VOICE AND MUSIC RECORDINGS

Making your own "Talkies" now possible with newly patented FILMGRAPH. Instantaneous and permanent play-back. Cost of recording only 25¢ per hour. Over 13 hours of indexed VOICE, RADIO, CODE, TELEPHONE recording on a single reel of film costing \$3.00 up. Bulletin free.

MILES REPRODUCER CO., INC.
Dept. HMA, 812 Broadway New York City

\$2.00 16mm Outdoor AMBERTINT Per 100' roll

Fine grain safety film, Weston 8. Machine-processed. California buyers include sales tax.

HOLLYWOODLAND STUDIOS
Southgate, Calif.

Lowdown on Continuity...

• Continued from Page 531

the baby with a bare table before him. Let mother or someone outside the scene call his attention to one side. As he looks up, stop the camera. As far as that one scene goes, it is incomplete, for everyone wants to know what made baby look up. Thus almost any scene that followed this one would complete the action since almost anything could attract baby's attention. In this case, then, a second scene is actually called for to complete the first one.

The second scene is mother bringing in the birthday cake decorated with a lone candle. Let mother come into the picture from the near center and exist on one side. At once the audience wants to know where she has gone with the cake. The third shot is a longer shot of the baby with the mother and cake entering from one side of the picture and placing the cake in front of the one-year-old.

There, in three scenes which anyone can shoot, is a strong bit of continuity without a plot of any kind. Each scene begins where the one before it left off, and in this instance each is somewhat dependent upon the other two.

However, to stop the picture now would never do. What's baby going to do with that cake? Keep the lights on and the camera ready, for baby will do something now. Whatever it is, film it. Perhaps he'll finger the frosting, then smear it on his face (most of them do), or he may be persuaded to use the knife and try to cut it.

Now we want grandma and the others in this birthday record. How about flanking them on each side of baby for a group shot? Then what shall they do? What shall baby do? After all, this is a movie. Perhaps they can be eating the cake. That is the procedure the beginner might undertake, but the filmer who would strengthen his continuity still more would choose a different method.

The group shot is unsatisfactory, for there are too

many in the scene making it necessary to move the camera back which would require more lighting. Also the subjects will appear smaller on the screen. The procedure is to film closeups of each of the guests, either singly or not more than two at a time, looking on amused at the baby.

What are they doing? Nothing. That's the funny part of it. Nothing, except smiling and showing intense interest. These shots can be made long after the baby has gone to bed, if necessary. When the film is edited these closeups — reaction shots they are called — are spliced in at intervals while the baby is "working" on the cake. Let's assume one of these closeups caught one of the oldsters laughing quite heartily. By all means this laughing shot should follow the scene where the baby first covers his face with frosting.

What have these closeups done? They have served two purposes. They have intensified the interest in the action of the film, and have served as a record of the guests at the party. Each of these reaction shots is almost completely dependent on the scene both before and after it, and when the shots of a sequence are so dependent one upon another only real continuity can result.

Have you ever had someone in the audience remark, "My, Helen certainly can change dresses in a hurry," in response to two scenes in which the same person appears but in different clothing? That is because those scenes are connected, either intended or by accident, and the sudden change of clothing is apparent. This happens many times in vacation films when the amateur may film a certain locality on different days with the same persons who have, of course, changed clothes. The worker intent upon perfect continuity must watch such details. The professional studios employ persons for just this thing, to see that the actors are dressed exactly

Thanks for recommending

KIN-O-LUX No. 3 Gold Seal

writes an enthusiastic camera user after having tried this new, FINER movie film for indoor use (and other occasions except bright sunlight).



No Outdoor Ratings

RATINGS

WESTON TUNGSTEN 100
SCHEINER TUNGSTEN 29°

And from movie fans everywhere come cries of approval for this new film whose Super Pan Emulsion and speed offer wide latitude, exceptionally fine grain and all around finer film performance. Yet this uniformly reliable film is priced lower than any other of comparable quality. But who could be a better judge than you, yourself? Buy KIN-O-LUX No. 3 Gold Seal today. Try it — you'll see why more and more experienced camera users insist on KIN-O-LUX. Accept no other. If your dealer cannot supply you, write direct to Dept. B10, 100 ft., \$6.00; 50 ft., \$3.50. (Prices include processing, scratch-proofing and return postage.)

Other Kin-O-Lux Movie Films are:

KIN-O-LUX No. 1 (Weston 8, Scheiner 18°), 100 ft. \$3.00; KIN-O-LUX No. 2 (Weston 12, Scheiner 20°), 100 ft. \$3.50; KIN-O-LUX No. 3 (Weston 50 Tung. 40, Scheiner 26° Tung. 24°), 100 ft. \$6.00.

ECONOMY • RELIABILITY • FINER RESULTS

KIN-O-LUX, INC.

105 West 40th Street

New York City

the same for each set of related scenes. Many times a scene will be made which follows one taken a week or two earlier. Even the growth of a man's hair will make a difference in close-ups of this kind.

For another example let's make a sequence of a parade. A parade is a typical newsreel subject, for the action must be photographed exactly as it is presented. Some people think a newsreel has no continuity. Indeed it does! Each sequence, when properly filmed, can be as full of continuity as any other type of cinematography.

The dullest way of taking a parade movie is to set the camera on a tripod at the curb and shoot every scene from that point. Twenty seconds of this and the audience is asleep (yes, even if they're in the parade). Since the action of a parade is always the same, it's up to the filmer to change it. How? Let's see.

First of all, jump the gun and get a shot or two of the parade before it starts. Get the band men adjusting their instruments, the last-

minute retouching of the floats, the policemen pushing back the crowd. This will create suspense. The audience awaits the start of the parade. And now they come, bands, floats, and all. Shoot a bit from eye level, get this next float from the rear as it goes on up the street, and now the drum major, twirling his baton. Shoot him from the ground. Run up to a second floor window for a long shot of the parade and the crowded streets. Back on the street again sneak a candid shot of some of the spectators. Perhaps there's a bit of confetti coming down. Continuity? The film will be full of it. Careful editing will make it even stronger.

Compare such a film with one taken from one viewpoint, where each scene is complete in itself. The former packs with life, with action, with a flow of continuity as each scene adds a bit more to the sequence. The latter is dull and lifeless; it is disconnected. A movie in its ideal form is a series of related bits of action. Otherwise, it is like the unconnected link of a chain, useless.

**For Clearer, Sharper
"STILLS"
THE NEW KODAK 35 (f/3.5)
WITH
COUPLED RANGE FINDER... \$47⁵⁰**

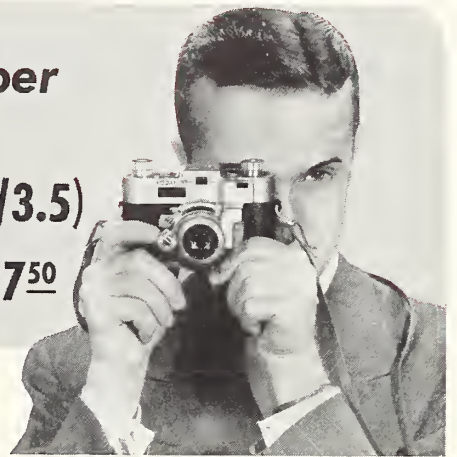

WITH this new miniature Kodak you can focus simply, swiftly, surely for your home movie "stills." As you look through the range finder window, a turn of the focusing knob gives you exact focus for a beautifully sharp picture.

The lens is a Kodak Anastigmat Special f/3.5; the shutter, a 1/200-second Kodamatic. Important features include dou-

● Look through the little window, turn the knob — and you know your picture's in focus.

ble-exposure prevention... automatic shutter setting... film centering... exposure counter... and, of course, Eastman precision construction.

Kodak 35 f/3.5, with range finder, costs \$47.50 with neck strap. At your Kodak dealer's.

Only Eastman Makes the Kodak

EASTMAN KODAK COMPANY, ROCHESTER, N. Y.

BESBEE TITLER

*The Universal Titler for ALL
8 and 16mm Movie Cameras*

Now for only \$8.75 everyone can have all the equipment he needs to make titles that add sparkle and interest to home movies. It's the new Besbee Titler, the only one selling for less than \$25 that is so simplified that any amateur can make professional titles without special artistic ability or training.

Here's all you do to produce fascinating titles with the Besbee: Choose any colored or black-and-white illustration—photograph, map, poster, etc. Spell out your titles with the handy stick-on letters. Place this titled background in the title frame (which is 9x12 inches, large enough for almost any background and for the handling of as many as 12 words).

Now simply set your camera on the Tripod Table, check the distance setting for your camera with the chart supplied with the set, and shoot your titles—easily quickly, accurately. All the lighting you need is the illumination afforded by a 100-watt bulb placed in position over and behind the camera.

Ask your dealer to show you the Besbee—America's low-priced simplified precision titler.



NEW BESBEE UNIVERSAL TITLER INCLUDES:

- TITLE LETTER SET—150 capital letters and numerals. Stick to any surface.
- CENTRALIZER—To assure accurate titles.
- BACKGROUND, 9"x12" . . . GUIDE CARD.
- BOOKLET—"Tell It With Titles" with easy, simplified instructions.

ALBERT



SPECIALTY CO.
NEW YORK • CHICAGO • LOS ANGELES
Main Office and Factory: 231 S. Green Street, Chicago

Quality Bulk Movie Film

8mm • 9½mm • 16mm • 35mm
 Complete New Reversal and Title Instructions Free with Film Orders. Separately, 25c each. Cash, check or money order for quick service. Deposit \$1.00 required with C. O. D. orders. Special delivery, 15c; air mail, 50c extra. Overpayments refunded or credited. Daylight Loading with Processing Included for Bulk Films, add amounts given below, per roll:

SUPER CINEPAN PLUS REVERSAL			
Speed 50-10 - Non-Halation Base			
	400 ft.	100 ft.	33 ft.
Double 8	\$13.50	\$3.85	\$1.45
Single 8	7.00	2.15	.80
16mm	12.50	3.50
SUPER CINEPAN REVERSAL			
Speed 24-16 - Non-Halation Base			
	400 ft.	100 ft.	33 ft.
Double 8	\$12.00	\$3.35	\$1.25
Single 8	6.50	1.90	.70
16mm	11.75	3.25
CINEPAN REVERSAL			
Speed 12-8 - Non-Halation Base			
	400 ft.	100 ft.	33 ft.
Double 8	\$11.50	\$3.25	\$1.25
Single 8	6.20	1.80	.65
16mm	11.25	3.15
CINECHROME REVERSAL			
Speed 8-2 - Non-Halation Base			
	400 ft.	100 ft.	33 ft.
Double 8	\$ 5.75	\$1.75	\$.75
Single 8	3.50	1.15	.50
16mm	5.25	1.50
SPEED 8 SEMI-ORTHO REVERSAL			
	400 ft.	100 ft.	33 ft.
Double 8	\$ 4.00	\$1.50	\$.60
Single 8	2.75	1.00	.40
16mm	4.00	1.15
Clear, Lavender, Amber, Blue, Yellow in 16mm. Only Clear and Lavender 8mm Scored.			
CINE-KODAK POSITIVE TITLE FILM			
Darkroom Loading, Laboratory Packed			
	400 ft.	100 ft.	33 ft.
Double 8	\$ 4.10	\$1.35	\$.60
Single 8	2.15	.90	.40
16mm	4.00	1.00
Clear, Purplehaze, Yellow, Red, Amber, Special Blue. Also DuPont Lavender, Pink, Light Amber.			
CAMERA SPOOLS WITH CANS—Each			
Double 8	\$.35	Keystone St. 8	\$.35
Univex 8	.29	16mm, 50 ft.	.50
Filmo St. 8	.50	16mm, 100 ft.	.60
EXTRA CANS, Double 8 and Straight 8 size..... .05 100 ft. and 50 ft. 16mm size..... .10 Non-Humidor, 400 ft. 20c; 6 for..... 1.00			
PRECISION PERFORMING			
16mm Films for Use in Double 8 Cameras			
50 ft., \$1.00	100 ft., \$1.50	400 ft., \$4.50	
Satisfactory in all cameras except Keystone K-8			
MISCELLANEOUS			
BATA Precision All Metal 8mm Slitter.....	\$2.50		
FOTOFADÉ DYE, for making Chemical Fades.....	1.00		
FOTOFADÉ WIPE-OFF TAPE, per roll.....	.60		
CINETINTS, 6 Colors and Instructions.....	3.89		
DuPONT VISCOSÉ SPONGES, each.....	.35		
HOW TO TITLE HOME MOVIES, book, each.....	1.00		
HOME MOVIES, Back Issues, 1936-37-38-39.....	.15		
Back Issues, 1946, each.....	.50		
TITLE DEVELOPER, tubes, each make 16 oz.....	.15		
FILM PROCESSING—PER ROLL			
	Reversal	Title Developing	
	100 ft.	33 ft.	100 ft.
Double 8	\$2.00	\$.65	\$1.75
Single 8	1.00	.35	.75
16mm	1.50	1.25

WE STOCK EVERY MAKE FILM
 Write for Complete NEW Price Lists
 A PERSONAL MOVIE SERVICE
 Telephone Lincoln 1207

W. STUART BUSSEY FILM LAB.
 17 E. St. Joseph St. Indianapolis, Ind.

IMPROVE YOUR COLOR SHOTS!



The PB Movie Filter Kit for Color Film
 \$3.95 COMPLETE

- 1 PB Lens Shade and Filter Holder
- 1 PB Haze Filter (for Kodachrome)
- 1 PB Conversion Filter (for converting type A to Daylight)
- 1 PB Filter Pouch

Available for all 8mm Movie Cameras
 Order from your nearest dealer or direct from:
PONDER & BEST 1015 S. GRAND AVE., LOS ANGELES, CALIF.

FOTOFADÉ

FADES, WIPES Can be added to your Reels after Processing WITH FOTOFADÉ on black and white or color films. Price, \$1.00. Waterproof Wipeoff Tape, 60c per roll. Complete Fotofade Kit..... \$1.60
 CINETINTS for coloring your 16mm or 8mm film. Set of six colors, \$3. At your Dealer or direct.
DYE RESEARCH LABORATORIES
 318 Jackson Street Los Angeles, Calif.

A Titler for Your "8"?
 See Inside Back Cover!

Information Please...

Continued from Page 522

To obtain reverse action on any film—8 or 16mm—the picture is shot with the camera held upside down. When the film is returned from the laboratory, it is turned end for end. However, in the case of 8mm film, it must also be turned over so that the glossy side is outside—so that the sprocket holes will match with film shot in the regular manner. This means that action filmed moving from left to right will project moving from right to left as well as moving in the reverse direction. Also, that the image may appear slightly out of focus on the screen because of the thick-

ness of the film and the fact that the emulsion on the "reverse action" film will not be on the same plane of focus as the rest of the film. This is not true of course of 16mm film where it is only necessary to turn it end for end. Sometimes there is a slight difference in the framing of some cameras so that the reverse action shots may have to be re-framed when projected with footage filmed in the regular manner. These variations, however, are quite unimportant when compared to the thrill to be had when reverse action movies are screened for your audience.

Where, What, or Who Picture?

Continued from Page 536

start with. It has to be! Most vacation filmers start shooting as they leave home; they keep on shooting until they get there, and usually finish up with more shots made on the way home. About all that is needed to edit such a film is to clip out the leaders and fogged frames, put in titles, and rearrange a scene or two here and there.

The simplest way to go about editing a film of this kind is to begin by getting the rolls of processed film in their proper sequence, according to the order in which they were shot. If you numbered the carton of each roll as it is shot, marked "1", "2", "3", and so on, on a corner of each carton, your editing task will be so much easier.

When all of the film is back from the processing laboratory, project it, in proper order, to get a clear idea of what there is to work with. The film can be assembled on a larger projection reel, eliminating leader, fogged frames, and the like as it is spliced.

When this has been done, study the film over a motion viewer, and start rearranging the scenes for greater strength. In most home films, and especially vacation films, while the scenes are all shot in an approxi-

mately natural continuity, the order of long-shots, medium-shots and close-ups within the individual sequences may often need rearranging.

In general, the most satisfactory order in which to present several different views of any given scene or action is that followed by the professionals—begin with a long-shot, follow it with medium-shots, and work progressively in to the closest angles you have. This is good logic. In real life, when one walks into a room or views a scene for the first time, the first impression is a visual long-shot. One sees the whole thing. Then one walks closer to the object of interest, and gets a closer view of it—a medium-shot. Finally one approaches as close as possible, and gets a still closer view—a close-up.

Once in a long while the reverse may be effective on the screen. For instance, in "Chicago, Vacation Center of the Nation," a "Movie of the Month" of a few years ago, Theodore D. Shaw, of Chicago's Metro Movie Club, achieved a very effective presentation of a spectacular fountain by reversing the usual order. He

OMAG

Sunshade and Filter CINE-KIT



MAKE your good movies great—sharp, clear, detailed—with a precision-calibrated Omag Cine Kit! Fits the popular cine cameras: Eastman-Kodak (including 8 mm. "90"), Revere, Keystone, Bell & Howell, Univex. Each kit contains a duraluminum combination sunshade and filter holder, 4 genuine Omag filters (yellow, green, red and haze for Kodachrome), utility carrying pouch. Only \$5.95 for most models. At dealers, or write for information: Dept. H-11.

CHESS-UNITED CO., Inc.
 Emmet Bldg., 29th St. & Madison Av., N.Y.C.

GOERZ

KINO-HYPAR LENSES

f:2.7 and f:3
 For regular and color movies of surprising quality—high chromatic correction...
 Focal lengths 15mm to 100mm—can be fitted in suitable focusing mounts to Amateur and Professional Movie Cameras.



GOERZ Reflex FOCUSER
 — Patented —
 For 16mm Movie Cameras—voids PARALLAX between finder and lens—provides full-size ground-glass image magnified 10 times. Adaptable to lenses 3" and up. Also useful as extension tube for shorter focus lenses for close-ups. Extensively used in shooting surgical operations, small animal life, etc.



GOERZ Parallax-Free FOCUSER and FIELD FINDER CONTROL
 No more off-center pictures, for Filmo 121 and Simplex-Pockette magnifies 4 and 8x.
 For Detailed Information Address Dept. HM-11

C. P. Goerz American Optical Co.
 317 East 34th St., New York
 American Lens Makers Since 1895

began with a very close view of the fountain itself. Then he cut progressively to distant and yet more distant shots until he ended the sequence with an extreme long-shot that very effectively showed how the fountain fitted into its landscaped park background.

Matching action between long-shots and closer angles is a simple enough matter if one can study the action of the two scenes carefully in a motion viewer. The ideal situation, of course, is that which applies in scenario films, and the like, where one can have complete control over the action, and stage things so that the same action is duplicated in both shots. That way, one can easily determine the places to cut so that on the screen there will seem to be no interruption in the flow of movement as the angle changes from long-shot to close-up. But such "direction" is seldom thought of—or possible—when making an ordinary travel or vacation picture. One just shoots what he can—and hopes for the best.

However, by carefully studying the action on the screen of a viewer, it is nearly always possible to find a frame in each where the action is reasonably similar. In doing this, it is a good idea to break the film between the two shots in question, and then pull each scene through the viewer by hand while the action is studied in detail. Thus, one may compare the two scenes with each other. One film can be slipped out of the viewer and the other, in its place. When the right pair of frames are found, the two scenes can be cut, and the splice made.

When this type of cutting has been done from one end

of the picture to the other, it is a good idea to project the film for further study of the picture as a whole. This study can be made on the viewer, of course; but projecting the film will often give a fresh viewpoint, together with a more accurate conception of the screen-time of each scene and sequence.

This study should reveal which sequences drag, which are too short, and which have too many scenes. Naturally, there is very little that can be done with a sequence that is too short. But when one is too long, or seems to drag, editing can do wonders.

Beware of pictorially lovely scenes that have no particularly significant action in them. On the screen, a scene that has no action seems twice as long as it really is. As a rule, about four seconds on the screen is quite enough for most actionless scenes: that is about 2 feet of 16mm film, or 9 inches of 8mm. This may seem short—but it's quite long enough on the screen!

The final step in a good editing job is titling; without titles, neither the editing nor the film itself is complete. So much has been written about how to make titles that this needn't be mentioned here. The problem is where to use them, and what to say.

Here again the projector comes in handy. Project the film for someone who has never seen it before, and who is not familiar with the places, events or people shown. Notice at what points he asks questions will tell where the titles should go; the replies to them, properly boiled down to minimum title length, should come pretty close to providing the right wording for the title-cards.

Reel Fellows . . .

• Continued from Page 529

part of the Reel Fellows' advantages.

There is, however, one additional advantage which every Reel Fellow is now entitled to—the distinguishing mark of a star added to his Reel Fellow emblem. This distinguish-

ing mark will be given those Reel Fellows having a film selected by HOME MOVIES as The Movie of the Month, awarded four stars for an outstanding film, or for achieving an award in HOME MOVIES Annual Amateur Contest. This, indeed,

SOLAR GIVES YOU SIX PLUS FEATURES

A CAMERA	TABLE TOP	MICROGRAPHIC	COPYING	LENS CHANGE	HORIZONTAL
----------	-----------	--------------	---------	-------------	------------

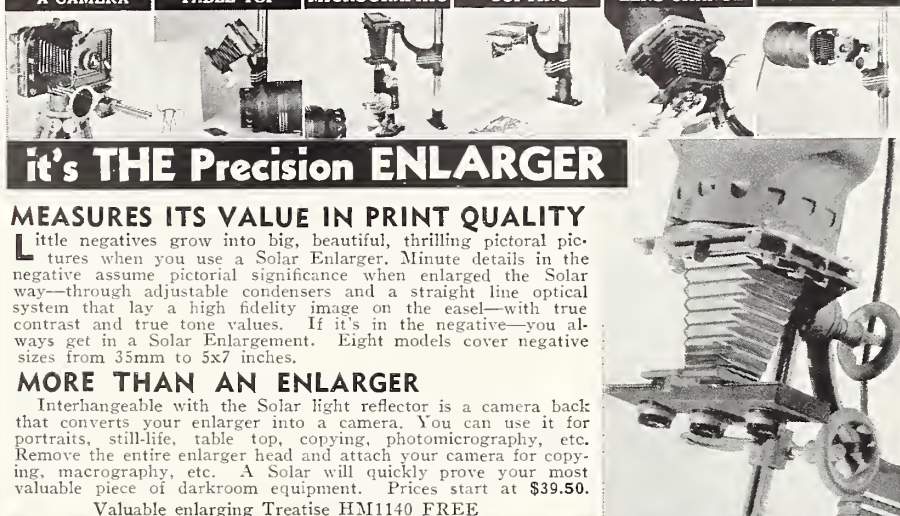

it's THE Precision ENLARGER

MEASURES ITS VALUE IN PRINT QUALITY

Little negatives grow into big, beautiful, thrilling pictorial pictures when you use a Solar Enlarger. Minute details in the negative assume pictorial significance when enlarged the Solar way—through adjustable condensers and a straight line optical system that lay a high fidelity image on the easel—with true contrast and true tone values. If it's in the negative—you always get in a Solar Enlargement. Eight models cover negative sizes from 35mm to 5x7 inches.

MORE THAN AN ENLARGER

Interchangeable with the Solar light reflector is a camera back that converts your enlarger into a camera. You can use it for portraits, still-life, table top, copying, photomicrography, etc. Remove the entire enlarger head and attach your camera for copying, macrography, etc. A Solar will quickly prove your most valuable piece of darkroom equipment. Prices start at \$39.50. Valuable enlarging Treatise HM1140 FREE.

BURKE & JAMES, Inc., (EST. 1897) 223 W. Madison St. Chicago

Buy GENERA in BULK

DOUBLE 8 SCORED

SEPARATES WITHOUT SLITTING

Single 8, Double 8 & 16mm

LOAD YOUR OWN SPOOLS and Save Money
A REVERSIBLE semi-outdoor Film. Can be used in Cine Kodaks, Keystone, Victor, Revere and Univex. Also suitable for titles. Processing simplified by use of Prepared Powders. FREE instructions.

200 ft. 8 in dbl. 8 width	\$1.50 post-paid	Spoils: Univex 15c
100 ft. straight 8 for Univex and Keystone	\$1.00 ptpd.	Keystone 35c
100 ft. 16mm on paper spool for 16 cameras	\$1.25 ptpd.	Eastman 40c
400 ft. 16mm in 400-ft. reel container	\$4.00 ptpd.	

Simplified Processing Outfits incl. Prepared Powders:
For 30 ft. single 8, \$3.95, ptpd.; Dbl. 8 & 16, \$4.95
Processing Powders: 1/2 gal. Set, \$1.20; 1 gal. Set, \$1.85
Write for Big Bargain Catalog, our processing prices.
FROMADER GENERA CO., Davenport, Iowa

The NEW IMPROVED
HOLLYWOOD CINESCOPE



8-16mm Film POCKET VIEWER. Reg. Price \$1.50. OUR NEW LOW PRICE \$1.00 Postpaid. SPECIAL FEATURES
Will not scratch film . . .
pre-focused for normal vision . . . adjustable for abnormal vision . . . large precision eye-lens . . . will last for years . . . film is held in position by groove . . . can be mounted on editing boards . . . special "light diffusion" screen . . . professional appearance.

Small Order of 10mm When Ordering
Above Viewer FREE with Any \$10.00 Order
HOLLYWOODLAND STUDIOS
"The West's Greatest Film Mail Order House"
Southgate, California

Adaptor and 10" Cable Release

For KEYSTONE K-8, and for BELL & HOWELL Filmo (Sportster and Companion) **\$2.00**

Avoid groping for the trigger and jarring the camera. Enter the picture yourself. Operate the camera and pan head with one hand. Adaptors no larger than a half dollar, instantly attached and detached, will not interfere with loading, winding or tripod mounting. Can be left on camera permanently. Simplifies single frame exposure, straight filming, and can be locked for continuous running. Eastman and other Keystone 8mm releases available soon.

See Your Dealer or Write
GARMUR PRODUCTS
P. O. 6073 Metropolitan Station
Los Angeles, California

Also available:
MATUS CAMERA SUPPLY CO.
5208 Wilshire Blvd. Los Angeles, California

Buy Nationally Famous MOVIE EQUIPMENT From Washington, D. C.

AT SENSATIONALLY LOW PRICES

We carry a full line of all nationally advertised movie cameras, projectors, lenses and film. Write us for our sensationally low prices. We're Washington's most complete photographic store. Far prices write to Dept. H.

BYRON'S INC.

625 15th St. Washington, D. C.

For GOOD PICTURES

Ask for

Consumers Film Products CORPORATION

COMPLETE LINE OF 16mm AND 8mm CAMERA AND PROJECTION FILMS
Also large assortment of HOLIDAY SUBJECT FILMS. Write for Holiday Catalog H.
At Your Dealer, or Write Direct
RIDGEFIELD PARK, N. J.

Save ON PHOTOGRAPHIC EQUIPMENT

Write for our
**FREE
CATALOG**
no obligation!

Everything you need for the enjoyment of your camera hobby, "Still" or "Movie." WRITE TODAY!

SUNNY SCHICK

National Brokers
401 W. WASHINGTON BLVD.
FORT WAYNE, INDIANA

MODERNIZE—Trade in Your Equipment!

HURRY! HURRY! LAST CHANCE!
Accept This "Get-Acquainted" Offer
FREE 'A to Z' Movie Tinting "KIT"
"Try-It-Yourself"
Make Your Movie Titles Sensationally Different
Act Quickly—Offer Limited—No Obligation
JACOB STEIN (Mfr.)
175 5th Ave. Dept. H19 New York City

Filmo Movie Equipment Does Not Limit Your Skill!

FILMO movie equipment imposes no restrictions upon your skill. The more advanced you become, the better the basically complete Filmo serves you. There are no limits to quality or variety of movies it lets you make. That's why Filmo owners are satisfied owners.

Make your next movie purchase a Filmo. Write today for free literature describing cameras, 8 mm., 16 mm., or 35 mm.; projectors, sound or silent; or any particular accessory in which you are interested. Most literature is in interesting, illustrated booklet form. Write for information today. Bell & Howell Company, 1825 Larchmont Ave., Chicago; New York; Hollywood; London. *Since 1907 the largest manufacturer of precision equipment for motion picture studios of Hollywood and the world.*

PRECISION-MADE BY
BELL & HOWELL

MAGNETIC MOVIE TITLER OF 1001 USES

THE QUIXET
MAGNETIC
MOVIE
TITLER

The Ideal XMAS GIFT

THESE UNUSUAL TITLERS WILL PROVIDE AS MUCH PLEASURE AS MOVIE MAKING.

Make unique, professional titles for your movies with the Quixet Magnetic Movie Titler. Quixet Magnetic Letters are made of attractive plastic, with built-in magnets powerful enough to adhere to any iron or steel background through magazine illustrations, cloth, photographic prints, etc. Beautiful results can be achieved by simply placing the letters on the background in the desired positions—circles, curves, angles, straight lines, etc., and the magnets do the rest.

**QUIXET
Magnetic Titler**
Set consists of 10" by 14" metal background with easel attached and 91 Quixet Magnetic Letters packaged in an attractive box. Numerals are extra.

\$9.50

ACCESSORIES

Additional characters . . . 10c each
Rosette magnets . . . 25c each
Panels . . . \$1.00 each
Each titler is fully guaranteed and will give many years of service.

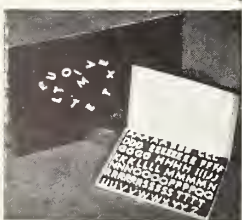

QUIXET DE LUXE MAGNETIC TITLER

Consisting of 122 letters and 28 numerals . . . **\$15**

If Your Dealer Cannot Supply These, Write to

QUIXET, INC. Dayton, Ohio

is a mark to shoot for and one which every member has an equal chance to attain.

Subsequently, Reel Fellows expect to make available special animated "Reel Fellow" leaders for its members' films, credit title cards bearing the Reel Fellow's insignia, and an emblem or sticker for their automobiles. These ideas, of course, are still in stages of development.

In recognition of Irwin Sipherd's suggestion which did much to motivate Reel Fellows into being, he has been tendered the first gold emblem, making him the "No. 1" Reel Fellow and the first Honorary Member.

The spirit of fellowship which motivated Mr. Sipherd's suggestion will always remain the guiding spirit of the Reel Fellows. HOME MOVIES considers it a privilege if not a duty to sponsor this organization of movie amateurs, and needless to say every effort will be bent toward increasing its usefulness to its members.

If you are a cinebug that loves the great glow of satisfaction that comes from experimenting and trying, exploring and proving new cine theories; in short—if you are enthusiastic about making home movies—we invite you to become a member of the Reel Fellows. "Happy Shooting!"

Sound for Home Movies!

Continued from Page 537

made for you, then take it home to be played on your own phonograph, the turntable of which would be linked with your projector for the purpose.

Music stores throughout the country now offer recording service to the public. In a very short time, they may be offering recording services to home movie makers through the Synchronsound System.

The big opportunity ahead for some enterprising amateurs is the establishing of recording studios—right in their own homes or garage workshops, if necessary—offering Synchronsound recording service to those movie amateurs who have no desire to invest in costly apparatus, but will readily invest in those units of the Synchronsound System enabling them to make synchronized recordings for their films if moderate price recording service is available.

Many amateurs have been experimenting with recording of discs for their movies for some time and possess satisfactory recorders. All they need to do is demonstrate that they can cut a good, clear record. The amateur who has purchased the Synchronsound unit already described need only bring his projector and the unit to the recording studio, which should have projection facilities available, *i. e.*,

projection room, screen, etc.

Additional services that could also be made available to amateurs by such recording service studios is a library of sound effect records, supplies of blank discs of various sizes, and narrator's service. It's a swell opportunity just waiting for the right men to take hold of it. And what better men are there to cater to the home movie amateur than those who are capable of understanding the amateur's problems—ambitious and conscientious cinebugs who are themselves amateurs? It is predicted the time is not far off when there will be established a chain of service studios, such as we have just described, stretching across the continent and serving the thousands of amateur movie makers from coast to coast now clamoring for sound home movies—their own sound movies!

A 16-inch record cut on a recorder traveling at 33-1/3 revolutions per minute will play for fifteen minutes—sufficient to synchronize a complete 400-foot reel of 16mm or 200 feet of 8mm film. The 16-inch blank records usually sell for \$2.00. Many recording studios will supply the blank and make the recording in their studios for about \$5.00. In other words, those who do not

GREAT VALUES OUT OF NEW

Free LAFAYETTE CATALOG

FILM CEMENT

1 oz. bottle 18¢ 4 for 69¢
1/2 oz. bottle 9¢ 4 for 29¢

CRYSTAL BEADED SCREEN

This practical, easily handled 30 x 40 crystal beaded screen features a complete lack of halation from front or sides. Has 4 times the reflectibility of an ordinary screen. Raller type Metal past support.

ONLY \$4.49

REELS AND CANS

Reel values! Made of heavy aluminum. Patented sprocket device accommodates every type reel arm. Humidars of heavy gauge aluminum.

8 mm. Reel	29¢
8 mm. Can	Each 6 for 1.69
16 mm. Reel	39¢
16 mm. Can	Each 6 for 2.27

REEL CLIPS

8 mm.—6c ea.
12 far 67c
16 mm.—8c ea.
12 far 89c

CLIP YOUR ORDER TO COUPON

Save time and money! Just enclose this ad, or any part, or note attached to coupon, along with your check or money order. Mark each item you desire and mail today.

ALL MERCHANDISE GUARANTEED

FILM STORAGE CHESTS

8 MM.	6-Reel Capacity	\$1.85
	12-Reel Capacity	\$2.55
16 MM.	6-Reel Capacity	\$2.25
	12-Reel Capacity	\$2.95

ORDER NOW!

SEND FOR BIG FREE CATALOG

IT'S BRAND NEW!

A whole book of great values in photography. Complete, up-to-the-minute, packed with all the latest nationally advertised cameras and equipment. It's money-saving! Send coupon for your FREE copy at once!

Lafayette Camera

DEPT. 80L— LAFAYETTE CAMERA
100 SIXTH AVE., NEW YORK, N. Y.

I ENCLOSE \$ RUSH MY ORDER

PLEASE RUSH FREE CATALOG No. 81.

NAME

ADDRESS

CITY STATE

ORDER FOR SUBSCRIPTION

Home Movies Magazine

12 MONTHS FOR \$2.00 IN U. S.

In Canada, \$2.00; Foreign—\$3.00

SPECIAL OFFER: 3 Years for \$5.00 in the U. S.

HOME MOVIES

10000 Sunset Blvd.
Van Nuys, Calif.



Name.....
Send to.....

Address.....

City..... State.....

New Renewal Gift

Name.....
Send to.....

Address.....

City..... State.....

New Renewal Gift



Enclosed find \$..... Date..... 19.....

Sent in by.....

Address.....

City..... State.....

SUBSCRIPTIONS ACCEPTED FOR LESS THAN ONE YEAR





4 FEATURES of FILM PROTECTION

1. **INTERNAL SOFTNESS.**
To resist heat and dry air.
2. **EXTERNAL TOUGHNESS.**
To resist scratches and stains.
3. **SURFACE LUBRICATION.**
To resist wear and sprocket-strain.
4. **PERMANENT IMPREGNATION**
To resist loss of protection in cleaning.

Impregnations, with SEPARATE chemical vapors, each doing its SEPARATE job, give you effective 4 FEATURE FILM PROTECTION against CLIMATE, WEAR, SCRATCHES, OIL, DIRT, WATER and FINGER MARKS.

Better Photo Finishers Offer VapOrate protection for still negatives.

PEERLESS
VAPORATE
FILM TREATMENT

VAPORATE CO., INC.
130 W. 48th St.
New York City

BELL & HOWELL CO.
1801 Larchmont
Chicago
716 No. La Brea
Hollywood

CORONA

Same Price,
16mm or 8-8

BETTER BULK FILMS

	100 ft.	400 ft.
Semi-Ortho 8-2 (8-8 is scored)	\$1.20	\$4.00
Super Pan 24-16 Anti-halo	3.15	11.60
12-4 Semi-Ortho	1.20	4.00
12-4 Semi-Ortho Anti-halo	1.30	4.25

Above prices do not include processing.

REVERSAL PROCESSING Double 8 and 16mm
100 ft. .85c 50 ft. .65c 25 ft. .50c
All orders postpaid except C. O. D.

SPECIAL ANNOUNCEMENT!

Corona is now dealing in 8mm and 16mm cameras, silent and sound projectors, feature and short subjects and movie accessories. Write for literature on your camera wants. Lowest prices on the best equipment. Victor, Keystone, Univex, etc.

TIME PAYMENTS ARRANGED

CORONA FILM LABORATORIES
200 East 34th St. Brooklyn, N. Y.

FREE bargain BOOK

First Step to Successful Pictures

Free illustrated catalog, crammed with hundreds of new and used bargains. Lists everything photographic—still and movie cameras, films, lenses, equipment—at tremendous savings. Liberal trade-in allowances. Satisfaction guaranteed or your money back. 10-day trial. Write for your FREE copy—just out. Hurry!



CENTRAL CAMERA CO. Dept. K-9
230 So. Wabash Ave., Chicago, Ill. Since 1899

ONYX 50 HI-SPEED MOVIE FILM

For Better Pictures

100 ft. 16mm	\$5.25
25 ft. double 8	1.60
30 ft. Univex	1.10

KENWOOD FILMS

1231 E. 46th St.
Chicago, Ill.

Scoop...

Titler for
REVERE CAMERA
See Inside Back Cover

Our new catalogue is now ready. It lists the largest library in the world of 16mm sound, 16mm silent, and 8mm silent films.

IDEAL PICTURES CORPORATION

28-34 East 8th St. Chicago, Ill. 2402 West 7th St. Los Angeles, Calif.



16mm Outdoor
AMBERTINT \$200
Per 100' roll
Fine grain safety film.
Weston 8. Machine-processed. California buyers include sales tax.
HOLLYWOODLAND STUDIOS
Southgate, Calif.

now have their own recorders can obtain a recording for "sounding" a full reel of film for \$5.00.

An amateur doesn't have to be particularly well versed in mechanics or electricity, nor is there any need for advanced schooling in the fundamentals of sound recording, in order to make successful sound movies with Synchronsound. The Synchronsound System is simple to attach to home movie equipment and equally simple to use. Synchronization between disc and film is accomplished by means of two 6-segment commutators with revolving brushes—similar to the commutators or distributors of automobile ignition systems. These two commutators are joined together by the length of cable mentioned earlier. The master commutator mounts on the turntable shaft and the other on the free shaft protruding from the projector (the one fitted with a knob and used for turning projector mechanism during threading). A two-wire cable from the projector commutator is connected to projector motor, replacing the regular cord supplying current.

Thereafter the current passes through the Synchronsound unit, power being fed to the projector motor through the two commutators in a series of timed impulses which keep the speed of record and film in exact relationship or, to use a

more common term, in "synchronization."

The Sychrosound System also provides for linking camera with recorder in a similar manner for making lip-synchronized sound and talking movies. Cameras having a hand crank shaft require no alteration to add the Synchronsound drive. Other cameras must be altered slightly to couple the drive shaft to the spring gear—a service which undoubtedly will be made available by those agencies distributing Synchronsound in each respective city.

The turntable Synchronsound unit can be attached to any home phonograph or record playing attachment for projecting the sound pictures. While it is not possible to obtain lip synchronization of dialogue unless the recordings are made while the picture is being filmed, synchronized sound added later to a silent picture adds greatly to its entertainment value.

Synchronsound units are now available for Ampro projectors, Bell & Howell 8mm and 16mm cameras and projectors, Bolex cameras, Keystone 8mm camera and projector, and the Victor 16mm camera and projector. Units can be supplied for other makes on special order, according to information supplied by the manufacturer.

Cine Clubs' big funfest

• Continued from Page 540

the park locale and the use of the hundreds of picnickers in "mob" scenes. Members of other clubs who so often had seen the screened results of this club's many now famous productions were afforded an opportunity to see how a well organized club producing unit really works.

All the while this was going on, scores of amateurs were busy on the side lines, perched in trees, or sprawled on the lawn with cameras in action, and they continued clicking throughout the day—or at least until film ran out. One enterprising dealer appeared at the picnic with a supply of 8mm and 16mm film, ready to aid

in re-charging cameras unexpectedly exhausted of film.

And when the picnic lunches were spread beneath the shade trees of the park, cameras were more active than ever. There were scores of strange "eyes" peering at the hundreds of merrymakers as they devoured sandwiches and guzzled pop or coffee. Just as one would bite into a tempting sandwich, some cinebug would pop up in front for a "human interest" closeup!

The fun was just beginning, though. While the Long Beach Cine Club had been charged with the task of providing the site for the

Introducing

A new line of
**Telephoto Lenses for 8mm
and 16mm
Cameras known as**

Teletar Lenses

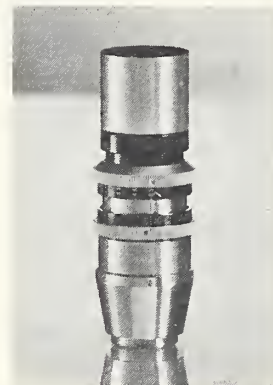

With one of these lenses you can explore new fields that are educational in scope, fascinating and at times even mysterious.

Rare and exciting "shots" of sports events, candid pictures of children, travel scenes, and close-ups of wild life, flowers, insects, etc.

Teletar Lenses are constructed so as to give a flat field of exceptional definition and sharpness. The general corrections for anastigmatism, color and special aberration have been fully carried out. The image is brilliant and clean-cut and when projected on the screen gives exceptional results.

Prices Are Amazingly Low! Teletar Lenses in Focusing Mounts

For 8mm Cameras

1 inch F 3.5	\$18.00
1 1/2 inch F 3.5	24.00

In Mounts to Fit

Keystone, Revere, Revere Turret, Bolex

For 16mm Cameras

3 inch F 3.5	35.00
--------------	-------

In Mounts to Fit

Keystone, Victor, Bolex, Filmo

Please Specify the Type of Mount when Ordering. Delivery November 12th, 1940.

Mail Orders Filled

Write Dept. H.M.T.

If it's photographic
you'll find it at

Willoughbys

32nd St. near 6th Ave.,
New York

World's Largest Camera Store
—Built on Square Dealing—

AT LAST! THE CINE EXPOSURE METER!

DeJUR "Critic" CINE



Exposure Meter 40-C

- Only \$15.50 Custom Designed Case, \$1.50
 - SENSITIVITY: .1 to 4000 candles
 - ONE SCALE: For all light intensities
 - VIEWING ANGLE: Adapted for movies
 - FILM SPEEDS: .3 to 800 Weston
 - SHUTTER SPEEDS: 6 to 128 frames per second
 - ONE HAND OPERATION
 - SPECIAL ALNICO MAGNET
 - JEWELLED Galvanometer Movement
 - SPECIAL LOCKING DEVICE: Easy reading
- Plus the Modern "LOUVRE"*
Sees "eye to eye" with camera... assures perfect pictures—ALWAYS!
Made in U. S. A. At your dealer's, or write for FREE folder!

DeJUR-AMSCO CORPORATION
SHELTON, CONNECTICUT

FOR LONGER LIFE . . . BETTER PICTURES

PERMALAC YOUR FILM

★ PROCESS USED BY BIG STUDIOS NOW AVAILABLE TO AMATEURS

Prolong the life of your movie films with the same amazing preservative used by Hollywood Studios to preserve priceless master reels. PERMALAC preserves projection qualities, banishes finger marks, oil stains, "rain" effects, scratches, torn sprocket holes, and other tell-tale marks of film age. PERMALAC restores new-film flexibility to old film, too. Toughens film against overheating, curling, scratching, and breakage. Even films boiled in water are immune to damage when treated with Permalac.

"PERMALAC" FILM PROCESSING

Send your exposed films to us exclusively for Permalac Processing. Not available anywhere else. Prices below include high grade processing, including Permalac Treatment, and return postage to you. Satisfaction guaranteed or money back.

100 ft. 16mm (black and white)	95c
25 ft. dbl. 8mm or 50 ft. single 8 (B & W)	55c

PERMALAC YOUR OLD FILM

Restores life and resilience of your OLD film; protects from further damage. Send films securely wrapped and add 10c to following prices for return postage and handling.

100 ft. 16mm black and white, or color30
100 ft. 16mm black and white, or color	1.00
200 ft. single 8 black and white, or color30

Send film direct to us. Permalac Processing is obtainable nowhere else and there is nothing else like it anywhere. At our low prices you not only save money on your film processing but you also save your film. Be sure to enclose correct remittance. We guarantee satisfaction or money back.

PERMALAC SOLUTION for home processing, enough to Permalac 1500 ft. 16mm or dbl. 8mm. Simple directions included. Per bottle, \$1.00.

SUPERIOR BULK FILM CO.
188 West Randolph, Dept. HM-11 Chicago, Ill.

Written Especially for the Beginner . . .

"HOW TO USE A MOVIE CAMERA"

50c Copy

Would you like to know how to use your camera to the best advantage? Then this is the book for you! Takes up where your camera instruction book leaves off.

HOME MOVIES
6060 SUNSET BLVD. HOLLYWOOD, CALIF.

picnic, the ice cream, etc., they accomplished all this and more too, proving themselves excellent hosts. The entertainment program had previously been voted into the custody of the Los Angeles 8mm Club, and "Bill" Wade and his associates supplied a program replete with surprises and many laugh-provoking situations. When the program of races—sock race, three-legged race, blind-fold race, egg throwing race, and others—got under way, cine cameras really started grinding. Already many had exhausted their supply of film and were hustling around borrowing a roll here and there or making quick trips to supply points in the city, when they couldn't locate the dealer who had come to the park with a supply of film. Husbands, entering the events, turned cameras over to wives, sons, or daughters to carry on with the cine clicking in order not to miss recording a single event.

B. B. Vogel of the Los Angeles 8mm Club was in charge of the entertainment program of events and did an excellent job. Everything went off smoothly and without confusion. Everyone had a lot of laughs. Then, at the close of the program of contests, all present were summoned to assemble before the park pavilion where prizes were distributed to winners of the various events.

Certain we are that few

Can I improve my film?

over some roads. Soon they are obliged to abandon their car and travel afoot.

Other travelers are shown making the same trip with pack mules. They trudge onward. When the party is left alone in this remote region, the picture actually imparts the rugged feeling of the wilderness. Added drama was injected by good titling.

Editing: Was consistently good. An interesting observation was that the long shots were not held too long—but sufficiently to aid in amplifying the message of the titles which usually preceded them. Frequent cut-backs to scenes of the filmer's activities along the way

cinebugs left the park without having made a host of new friends with a kindred hobby—making home movies. Indeed, the success of the whole affair may be summed up in that very accomplishment—the meeting and making of new friends. That this event promoted a more neighborly feeling among the cine clubs of Southern California is born out by plans which have since developed for these same clubs to hold a mid-winter meeting in December. At this time the best films produced by each club or its members will be screened and this will be followed by exhibition of cine gadgets designed and built by amateurs.

Also, the picnic has been officially declared an annual event to be held each year in a different Southern California city with the clubs from that city playing host—a sort of one-day, outdoor convention of amateur movie makers. The directorate of other cine clubs will undoubtedly see in the successful outcome of this event, an idea they might readily adopt for increasing interest and activity within their respective vicinities. Indeed we see this group club get-together idea leading to more inter-club activities, particularly inter-club competition in the production and exhibition of home movie films similar to the competition of salon showings among still camera clubs.

added much to the interest of the picture.

Photography: Left very little to be desired. Exposure was very good throughout and camera was steady at all times.

Titling: The main title was nicely executed over a pictorial background of a rainbow. Descriptive subtitles, which were frequent, were nicely worded and well placed, and did much to establish and maintain interest in the picture already made interesting by good photography.

"NEWLYWEDS" ★★
200 ft. 8mm—By M. C.

Continuity: Here is a simple story any amateur might



Turrets and Backwinds FOR FILMO AND OTHER CAMERAS

Backwinds with 240 frame counter and crank, \$32.50 on Filmo 8. Same backwind with small 24 frame counter, \$24.00. Filmo 8 turret, with automatic indexing, \$28.75. Includes compensation for wear in indexing mechanism. Brilliant image focuser shows full frame area, with all lenses.

Turrets for Keystone 8mm and 16mm cameras, \$28.00 complete.

1200-ft. reel arms for Keystone 16mm projectors, \$12.50. Lens adapters, focusing mounts and other apparatus. Two-year guarantee.

MacVAN MFG. CO.
3829 El Cajon Boulevard San Diego, Calif.

Golden Gate International Exposition 16mm Films

Four 100-ft. reels. No titles except heading and end.

REEL No. 1—Gen. views, Oakland Bay Bridge, Tower of Sun, Fountains, Buildings, etc.

REEL No. 2—Continuation of reel No. 1.

REEL No. 3—Continuation of reel No. 2.

REEL No. 4—Night photography. The Fair in all its glory! General views of the Gay Way.

Each reel complete, but you can add one to the other without duplication. BLACK AND WHITE specially priced at each **\$1.95**

NATURAL COLOR PRINTS

Full color Kodachrome showing the Fair in all its beauty.

100 ft. 16mm	\$9.00
------------------------	--------

8mm BLACK AND WHITE

50 ft.	\$1.75	180 ft.	\$5.50
----------------	--------	-----------------	--------

California Buyers Include Sales Tax

HOLLYWOODLAND STUDIOS
"The West's Greatest Film Mail Order House"
SOUTHGATE Box 14 CALIFORNIA

DO FILTER FACTORS FLOOR YOU?



...then ask about the new HARRISON Duraline FILTER SET—4 Filters, a Holder and Shade to meet 99% of all your requirements. With compact leather case—Easy instructions. New low prices. See them at your dealer today! Or write for folder.

HARRISON & HARRISON
Optical Engineers
8351 SANTA MONICA BLVD. HOLLYWOOD, CALIF

Adhesive Title Letters

REMOVABLE OR REUSABLE

13/16" Gothic (240 letters)	\$2.50
1" Exotic (40 letters)	\$3.50

NO-HALO FILM—Weston 12

100 ft. Dble. 8mm (200 ft. 8mm) Bulk	\$1.25
100-ft. 16mm, bulk	\$1.15
100-ft. 16mm Da-Light Leader, bulk	\$1.25

ACCURATE CINEMA SERVICE & LABORATORY
2909 Maroa Ave. Chicago, Ill.

CINE SHOP TITLES

WRITE FOR NEW CATALOG

Cine Shop
1012 PIEDMONT CHARLESTON, WEST VA.

25c KODAK FINISHING 25c

Any 6 or 8 exp. roll dev. and printed for only 25c. Quality guaranteed. None finer. Bring in or mail.

Extra Prints—122 or smaller, 3c each. 35mm enlarged to 435, 5c each. Write for complete price list.

Thrifty Photo Service
10364 State Street 29 Lynwood, Calif.

IN PHILADELPHIA

CAMERAS

and Everything Photographic

KLEIN & GOODMAN
18 S. 10th STREET

Presenting

A MOVIE A MONTH
For 8 and 16mm Fans

A new plan entitling members to an extremely low cost viewing service.

Complete Edition Castle Films
8mm and 16mm for Just a Few Cents a Day

AND THAT'S NOT ALL
You receive one headline edition free. You select it and own it.

IT'S A GREAT SERVICE
Write Now for Further Details

Movie a Month Association
Box 524 Reynoldsville, Pa.

The Service That Saves

Your Own Metal Title Letters

Ask for Samples of the Most Beautiful Capital and Lower Case Letters Made



Complete Sets in Wood Case, 222 Pcs. . . . \$7.16
126 Caps Only . . . \$4.28
AN INTERESTING ADDITION TO YOUR MOVIE HOBBY
Specify White or Black Letters
KNIGHT & SON, INC. P. O. Box B, Seneca Falls, N. Y.

MR. 16mm PRODUCER
We offer you complete facilities for adding

SOUND

BLACK & WHITE • KODACHROME
SPECIAL EFFECTS • ART TITLES

GEO. W. COLBURN
LABORATORY
1197-A Merchandise Mart CHICAGO

FRAME-COUNTING WINDBACKS
Guaranteed accurate. Expertly engineered and installed. Money-back guarantee.
Keystone.....\$15.00 • Filmo.....\$19.95
Precision Built Accessories for Every Need
Write Us Your Requirements
Custom Built Camera Accessories Co.
4124 Rawlins • Dallas, Texas

\$200 16mm Outdoor **AMBERTINT**
Per 100' roll
Fine grain safety film, Weston 8. Machine-processed. California buyers include sales tax.
HOLLYWOODLAND STUDIOS
Southgate, Calif.



Now Ready . . .
Titler for
Eastman Magazine 8mm
See Inside Back Cover

"It Always Gets the Picture"
G FILM
100' 16mm (inc. Proc., postpaid).....\$1.50
100' Dble. 8mm (inc. Proc., postpaid).... 1.75
100' Sgle. 8mm (inc. Proc., postpaid).... 1.00
Unspooled to Save You Money Scheiner 18
Send for New Free Illustrated Folder
M.-G.-M PHOTO SERVICE
1485 Oak Street San Francisco

use—a story for two people, a young married couple. The picture opens showing the young wife preparing to go shopping. While dressing, she discovers a mouse scampering about the floor and calls to her husband. When he enters the scene, we find him with an apron about his waist and evidence that he has been busy in the kitchen.

A comedy touch was imparted in a closeup as the husband searches beneath the bed for the mouse. As he bends over, his suspender buttons give way, allowing his trousers to droop. Then again as he stands, eyes searching the room for the elusive mouse, there is a cut to a closeup of the mouse crawling over his shoe and up his trouser leg. Thus the mouse is captured.

Wife departs for shopping tour and husband proceeds with his kitchen duties. Meanwhile, another mouse appears in the kitchen. Husband pursues it with broomstick, disarranging the kitchen and upsetting himself very much.

The wife returns from her

shopping trip to find the kitchen a shambles and her husband with a black eye and torn clothes, squatting beneath a table and holding the elusive mouse which he finally trapped. The closing shots show hubby being put to bed and a piece of beefsteak being applied to his eye by his sympathetic wife.

Editing: Was good. Picture was well cut for timing. No scenes are held too long and there is fine intercutting of angle shots of downtown shoppers made at low camera angle.

Photography: Quality of exposure and focusing was consistently good. The low camera angle shots of the shoppers were well staged so that the shot ended, each time, with the wife emerging from the crowd. Then, again, shooting up stairway as woman listens at door proved very effective.

Titling: Commendable were the revolving titles made with the aid of an electric fan. Title card was affixed to fan, which was started, to rotate title and then stopped abruptly to allow time for reading.

Movie of the month . . .

• Continued from Page 541

he is about to take up the magazine when there is a call from the kitchen. His wife summons him to open a can of preserves.

Returning to his chair and magazine, he begins to thumb the pages when his youthful daughter enters the room and climbs upon his lap. An advertisement in her hand tells about a sale of "college-cut" coats and after a good deal of wheedling, she succeeds in getting the desired money, although it is obvious father would not have parted with it so easily if he were not trying to be rid of the girl and get back to his reading.

With a sigh of relief, father lights up his pipe, then snuggles down in his chair to read. But there is another call from mother—this time to dinner. Dejected and disgusted, father comes to the table, bringing the magazine with him. Spreading it alongside of his plate he continues to read until mother, with a

cold, indignant stare, puts an end to that.

The dinner over, father again retires to his chair in the corner and gets fairly deep in his magazine when there is another interruption—a call at the door. Mother answers and admits a neighbor who has come to take her to a lecture. Mother removes her apron and hands it to Father with instructions to wash the dishes while she is away. Considerably agitated, Father reluctantly dons the apron and begins the task awaiting him at the sink.

A practical man, he props the magazine on the window sill before him and continues to read as he dunks the dishes in the suds. But even here there is no peace for a man with a deep passion for literature. There is another call for Father—this time from an upstairs bedroom where daughter, dressing for a date, is stymied in the task of lacing her corset. Father

Better MOVIES
BEGIN WITH
Proper
LIGHTING

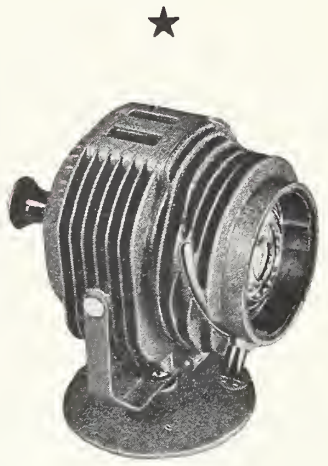

F-R HI-SPOT
the better
HOLLYWOOD TYPE SPOTLIGHT

Experienced photographers know that lighting is the first requisite for finer picture making. Having studied Hollywood lighting technique they know that the F-R Hi-Spot, miniature of the giant and baby Hollywood spotlights, with its soft but punchy beam "picks up" details ordinary lighting never discovers. It embodies all the fine points necessary for superior home movie making.

- OUTSTANDING FEATURES:**
- Fresnel Lens.
 - 200 Watt Special Hi-Spot Projection Lamp.
 - Finger-tip focusing from a large to a small spot.
 - Complete directional control—tripod mounted or adapted to standard light stands.
 - Made of Die-Cast Aluminum.
 - Compact, sturdy—yet light-in-weight.
 - Anyone can manipulate it.
 - Complete with 10 ft. cord.

\$9⁹⁵

At leading dealers everywhere.
Buy it today.



YOU BE THE DIRECTOR! YOUR HOME FOLKS CAN BE THE PLAYERS!

Here's a Professional Hollywood Manuscript for Home Movie Makers

Featuring, for Fall Festivities, "Pickle Party Pranks"

This Wesco Home Movie Scenario is designed for a riotous fun-fest of making a different kind of home movie. With this professional Hollywood shooting script, written exclusively for amateur cinematographers, you receive filmed Main Title and Ending, ready to splice in. Complete set of Title Cards, ready for home filming. Clever **\$1.75** Film Props... all for...
SPECIAL OFFER: Your name, either as producer or cinematographer, on a special Screen-Credit Card for only 10c. This can be used in any or all of your reels.

See Your Photographic Dealer, or
Mail This Coupon, Today

HOME MOVIES SCRIPT SERVICE,
331 Turk Street, San Francisco, Calif.

- Enclosed find \$1.75. Please send Wesco Home-Movie Scenario, "Pickle Party Pranks."
- Enclosed find 10c for Special Screen-Credit Card as per copy.
- Please send Catalog listing other Wesco Home-Movie Scenarios.

Name.....
Address..... City.....

NEW ULTRA HIGH SPEED SOLAR Movie FILM

Weston 150, Daylight Mazda 110. Wide latitude, fine grain. Non-halation coating. Even most modest equipment produces unbelievable results using film of this tremendous speed. You get night pictures, theatricals, indoor movies heretofore beyond reach of the amateur! Costs little more than ordinary speed film.



Dbl. 8 16mm 100 ft. **\$2.25** 16mm 50 ft. **\$6.00** 16mm 25 ft. **\$3.50**

Processing and Return Postage Included

400 dealers in 201 towns and cities. If your dealer hasn't SOLAR film, ask him to get it for you, or order direct from this ad.

SOLAR CINE' PRODUCTS, INC.
3827 Archer Ave., Dept. 1A Chicago, Ill.

It's HERE! The TRI-METAL

This new, all-metal beauty is a tripod that will delight every camera fan. It combines sturdiness, convenience and versatility with a strikingly handsome appearance. Standard Thalhammer features throughout. SEE IT AT YOUR DEALERS



THALHAMMER COMPANY
1015 West 2nd St. Los Angeles, Calif.

FREE

16mm SILENT AND SOUND-ON-FILM RENTAL LIBRARY CATALOGUE
Films Shipped Anywhere—Large Selection
Write Today for Your Copy
NATIONAL CINEMA SERVICE
71 Telegram Sq. New York City

Guaranteed 24-Hour

PROCESSING

EXCLUSIVE with Eso-S Pictures is the modern soft-flash system reversal process which insures an even, correctly tone-balanced, fine-grain reel of films consistently!

Double 8mm, up to 34 feet.....45c
Single 8mm, up to 34 feet.....25c
Univex Std. and U. P., and ALL Eso-S single 8mm films.....15c

These prices apply to all bulk films, including the new Gavaert Ortho, Microgan and Super Panthro, DuPont, Eastman positive, and our own complete line of reversal films.

REELS AND CANS RETURNED WITH THE FINISHED FILMS UPON REQUEST

ESO-S PICTURES

"Quality 8mm Service"

3945 Central Street Kansas City, Missouri

is summoned to aid in this chore, and after considerable difficulty with the laces, which affords opportunity for many nifty angle shots of some nifty angles, daughter is made ready for the struggle of donning her clinging evening gown. And Father, already retracing his steps to the kitchen, is called back to assist with this, too.

When he returns to the kitchen, Father does a slow burn as he discovers his magazine has toppled from the window sill and into the pan of dishwasher. Undismayed, he removes the magazine to the oven of the kitchen stove, lights the burner and continues washing dishes while waiting for it to dry out.

There comes another ring at the door. Father answers it, draped in the water splashed apron, and admits daughter's boy friend. Time passes quickly as they chat while waiting for daughter to appear. Then there's the usual exchange of good-byes, as the young couple depart, and Father trudges back to his chore — and his magazine.

But on arriving in the kitchen, Father sniffs a strange odor. Of course it's the magazine — burning in the oven. This is too much for Father. His "Time" has been sacrificed on the altar of domesticity—charred to an unreadable crisp. He sinks dejectedly to the floor as the picture ends in a fade-out.

Besides making a really entertaining movie, Ray Fosholdt had two other objectives in mind: to make a picture that required no

subtitles, and one in which he could exercise the use of other than flat lighting for his interior sets. Both were accomplished successfully. The picture has been highly complimented at every screening for its smooth flow of story without the aid of titles, and the lighting is refreshing as it is different.

Fosholdt used spotlights in all of his interior shots; and to say his lighting technique approaches the professional is to compliment him mildly. Actually his picture is an excellent study for other amateurs interested in improving their interior shots with the aid of spotlighting. It represents a successful result of applying standard principles of modeling and backlighting, about which, Fosholdt states, he has read in earlier issues of HOME MOVIES.

Considering that about 98% of this picture was filmed indoors, photography rates away above average. No shot was held over ten seconds without varying camera angle. Closeups are frequent, as they should be in a story of this kind. By playing the story in close-ups, explanatory titles were easily eliminated. Needless to say, the editing skill displayed in putting this picture together, is equally good.

The Fosholdt duet are, at this writing, actively engaged in producing another picture. Considering the skill already displayed and what they learned while making "Father's Time", they can easily be expected to ring the bell again with another Movie Of The Month.

The reader speaks

• Continued from Page 520

game fishing—tuna, swordfish, tarpon, etc.—especially medium closeup shots of such fish being brought to gaff. Would also like to hear from those who have such scenes and would make them available for duplication. Full description of scenes and the amount of footage should be included in first letter.

—Charles L. Schultz,
1924 West 42nd St.,
Los Angeles, Calif.

Dear Sirs: Since returning from a trip through the West, I have tried to obtain from several sources some 16mm film in either Kodachrome or black and white of the California redwoods along the famed Redwood Highway. Would appreciate hearing from any amateur having such film for sale.

—Miss Mary E. Powers,
631 Poplar St.,
Winston Salem, N. C.

A COMPLETE RECORD of the WAR!

Through this notable series it is now possible to own for all time a chronologically correct pictorial record of history, photographed as it was enacted. A priceless record—becoming more and more valuable with the years.

- NEWS PARADE—1937
- GERMANY INVADES AUSTRIA
- NEWS PARADE—1938
- WAR IN EUROPE (Polish Invasion)
- FINLAND FIGHTS
- BATTLESHIP GRAF SPEE SCUTTLED
- BATTLE FOR FRANCE
- BOMBS OVER EUROPE (DENMARK, NORWAY, HOLLAND AND BELGIUM)
- NEWS PARADE—1939

A complete line of all new Castle Releases for sale here at lowest prices. OUR STUDIO is completely equipped for Editing, Titling, Cleaning and Vaporating your films.

Get on Zenith's Mailing List by writing today for your copy of the new 1941 Film Rental Catalog—8 and 16mm silent and 16mm sound—now ready for mailing.

ZENITH CINEMA SERVICE

5011 NORTH SAWYER AVE., CHICAGO, ILL.
"Fine Movies Since 1924"

THRIFTY BULK FILM

Write for Catalog and NOTE THESE PRICES

- 100 ft. double 8mm semi-ortho.....\$1.19
- 100 ft. straight 8mm semi-ortho..... .75
- 100 ft. 16mm semi-ortho..... 1.19
- Dbl. 8mm empty camera spools..... .30
- Univex straight 8 empty camera spools .15
- 100 ft. 16mm empty camera spools.... .40
- Slitters for slitting unscored double 8mm film, formerly \$1.50, now only .79

All above film is laboratory packed and prices do not include processing.

California customers please include 3% sales tax. No C.O.D. orders unless accompanied by \$1.00 cash with order.

THRIFTY FILMS

Drawer 98, Watts Station Los Angeles, Calif.

8mm SLITTER

Slits perfectly 16mm width film to exact 8mm width. Die cast body with hardened steel cutting wheels. New price, each, \$2.50.

DEVELOPING RACKS

Stainless steel, take 30 feet 16mm or 8mm width film. Can be used in 11x14 or 8x10 flat trays respectively. Complete with loading stand, each, \$6.75. Specify type wanted.

At Your Dealer's or Direct

J. C. Haile & Sons

Motion Picture Dept.

215 Walnut Street Cincinnati, Ohio

8mm—BULK FILM—16mm

Single 8—Double 8—16mm With Processing Also

35mm Film for Candid Cameras

Write for Low Prices

PACIFIC COAST FILM CO.

1510 No. Sierra Bonita Hollywood, Calif.

GLASS-BEADED MOVIE SCREENS Easily Made!

Make your own sparkling beaded screens—at a fraction of their usual cost! Crystal beads can be applied to cloth, cardboard or almost any smooth surface. Complete directions with each pound. (No fractions of pounds sold.)
Glass Beads to cover 20 sq. ft. (1 lb.)
Finest Size \$1.25
D. GARD, C-9, 54 WEST 74TH ST., NEW YORK CITY



When You Buy BAIA You Buy the Best

Precision Made: Guaranteed Perfect

\$2.50

From Your Dealer or Direct

BAIA MOTION PICTURE ENG
259 Gerald, Highland Park (Detroit), Michigan

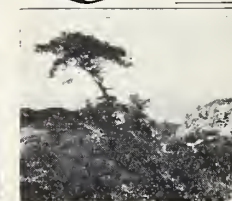

16mm Outdoor AMBERTINT Per 100' roll **\$200**

Fine grain safety film, Weston 8. Machine-processed. California buyers include sales tax. HDLLYWOODLAND STUDIOS Southgate, Calif.

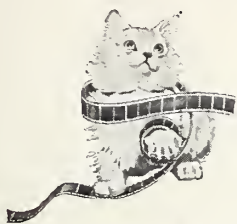

48 HOURS UNDER WATER

Test under witnessed supervision and sworn affidavit:

Strips of color film were placed under water, after being treated, for 48 hours and no ill effects were visible under the microscope.

So We Say the

O'SULLIVAN FILM TREATMENT

- Makes Film Waterproof
- Prevents Fading and Bleeding

See Your Dealer or Write

O'Sullivan Film Process

5184 Santa Monica Blvd. Hollywood, Calif.

SAVE ON MOVIE FILM

LOOK AT THESE LOW PRICES	16mm 100 ft.	16mm 50 ft.	8mm 25 ft.
REGULAR Weston 8 semi-ortho.	\$1.79	\$1.19	\$.98
SUPER . . . full ortho, wide latitude, non-halation, Weston 12.	2.19	1.39	1.19
PAN . . . extra fast, Weston 24, panchromatic, fine grain.	3.69	2.19	1.39

PROCESSING AND RETURN POSTAGE INCLUDED. Each roll complete on DAYLIGHT LOADING spool in metal container and strong mailing carton. Fast service, 24 hours or less in our modern laboratory. Send only \$1. We ship C. O. D. for balance. Or remit in full and save postal charges. NOT SOLD IN STORES. Order TODAY direct from this ad.

ESSCO FILM PRODUCTS
Dept. HM, 6117 S. Campbell Ave.
CHICAGO, ILL.

LEARN PHOTOGRAPHY from Experts

Thorough, practical training For pleasure or career. All phases of photography. Commercial, News, Portrait, Advertising, Motion Pictures, Color. Teaching staff of noted authorities. 30th year. Send for Free Booklet.

New York Institute of Photography
10 West 33 Street (Dept. 114) New York City

Why use anything else when

TITLES BY PARK CINE

cost no more than ordinary titles.

Catalog Free on Request

PARK CINE LABORATORY

120 West 41st Street New York City

8 ENLARGED TO 16 REDUCED TO 8

GEO. W. COLBURN LABORATORY

Special Motion Picture Printing
1197-A MERCHANDISE MART
CHICAGO

8mm Bulk Film 16mm

Lowest Prices

Write for Catalogue

HOLLYWOODLAND STUDIOS

Southgate California

MAKE YOUR OWN TITLER!

For all types of titles, close-up and copy work. Complete kit of finished parts—optically ground lens—easy instructions. Assemble in 15 minutes! Money Back Guarantee. State camera model. Distinctive Title Card—"Photography by (your name)"—35c

ONLY \$1.95 IN KIT FORM

For All 8 or 16 MM CAMERAS

HOLLYWOOD MOVIE SUPPLY COMPANY
NORTH HOLLYWOOD • CALIFORNIA

With the "Pro-16's" . . .

• Continued from Page 526

sell in the neighborhood of \$2,000, we have been told. More about this later after we have had a chance to test it.

Every enthusiastic amateur has a dream camera in his mind. We professionals have the same. Naturally we think of the results that can be obtained with such a dream. After twenty years of constantly shooting 35mm and eleven years specializing in color movies, I have a camera, a dream camera, in mind for all professionals who want to shoot the "ne plus ultra" for the screen. It would first have all the features of the studio cameras used here in Hollywood, plus automatic dissolve and built in filters, diffusers and other effects. It would of course be a 16mm outfit. The tripod would be a small Akeley type gyro design for smooth, steady telephoto pans and tilts. The entire outfit so quiet that a mike a few feet away would pick up nothing in the way of noise from it.

It would have a built-in Harrison color meter and color compensating correction filters, and Commander exposure meter. The Sunshade and matte box would contain compartments for swinging edge gauzes and pola screen into place and racks for additional effects. In addition it would have one of the new swinging slates that the local studios are beginning to use, so that the film formerly wasted in getting up to full camera speed can be utilized for slate and synch marks. The tripod would have attachable wheels so it could be quickly converted into a dolly for trucking shots. The entire outfit would be so light it could be carried under the arm.

As many past dreams seem to be coming true, thanks to the science of Hollywood, maybe this one will soon be here so that we of the professional cameras will be joining the home movie producers in using 16mm equipment.

It's about time we gave the amateurs a little competition.

Backyard Movies . . .

• Continued from Page 524

tle of smelling salts and proceeds to revive husband on the floor.

Closeup: Husband opens his eyes in a dazed manner and speaks—

Title: "Never again!"

Same as before: He again faints dead away and as the nurse tries to revive him, fade-out.

Title: Next morning at the office.

Medium long shot: Husband is strutting around the office with a big grin on his face, passing out cigars and receiving congratulations from all his fellow workers.

THE END

—George Burnwood.

Filming a Wedding

Here are some suggestions for a wedding film: Opening scenes may be made of the groom nervously adjusting tie, glancing at watch,

pace floor, etc. Then the bride, as she nervously re-powders nose, adjusts corsage, touches up hair, etc. Shoot the wedding march and ceremony, if permissible, taking care not to disturb or interfere with the ceremony.

At the reception, movies of the entire bridal party, friends and relatives can be made. The wedding cake should not be overlooked and especially the opportunity to get closeups of the bride or groom cutting same.

Effective shots will be those of the bride and groom escaping through a back or side door for a hasty departure on their honeymoon. Then of the decorated cars, starting after them in pursuit.

—Perry M. Long.

No Need to Compromise Quality For Price . . . Now!

BUY A SUPERIOR RAVEN Haftone SCREEN

at new reduced prices, save money—and get even more movie pleasure.

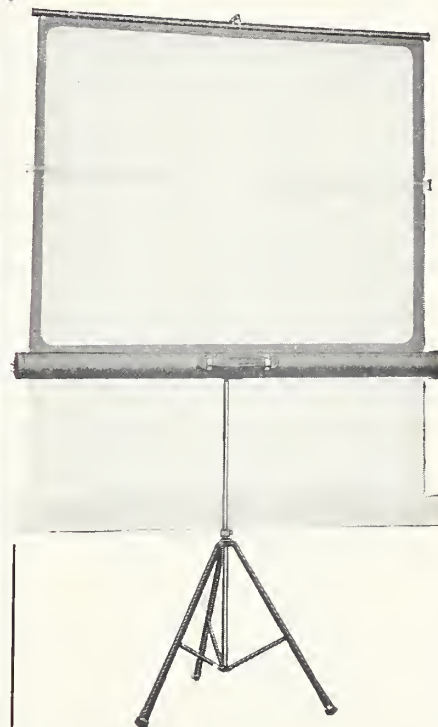

STANDARD TRIPOD MODEL

Strong construction of lightweight metal tubing. Easily and quickly set up. Can be folded in compact units when not in use. Quickly adjustable to high or low points. Made in five fabrics, attractively finished in dark "crackle" and equipped with non-scratch rubber feet. Sizes 30"x40" to 52"x72".

Raven Quality, chosen from among all others by Eastman Kodak in screens to show the gorgeous Cavalcade of Color at the New York World's Fair—now at new lowered prices is found in every Raven Screen, no matter what style, size or type of mounting. See them at leading dealers everywhere. For finest screen value—insist on Raven.

RAVEN SCREEN CORP.

314 EAST 35th ST. NEW YORK CITY

16mm THRIFTY FILM



THRIFTY ORTHOTYPE **\$1.60**
For OUTDOOR... non-halation base, fine grain, fast... the film you've been wanting to find at an unheard-of low price. Machine processed. Per 100-ft. rolls.....

THRIFTY PANCHROMATIC **\$3.75**
Use for all types of shooting. Machine processed. Per 100-ft. rolls.....

THRIFTY SUPER-PANCHROMATIC **\$4.25**
Super-fast; high sensitivity, requiring minimum of light. Machine processed. Per 100-ft. rolls.....

Thrifty Films save you 50% on your film cost. Three splendid films to choose from—each a leader in its class. THRIFTY FILM is a proven value and our complete laboratory is one of the best in the West. California Buyers Please Include Sales Tax

THRIFTY FILMS
Sold and Processed Only by
Drawer 98, Watts Station Los Angeles, Calif.

FOR SERIOUS WORKERS BASS RECOMMENDS THE CINE KODAK SPECIAL



Even the great Bass cannot find words to describe this scientific marvel. Doctors, biologists, engineers, advanced amateurs are invited to send for special exhaustive booklet. Free. Also ready now... the new BASS CINE BARGAINGRAM No. 245.

Bass CAMERA CO. Dept. H. M.
179 W. MADISON ST. CHICAGO, ILL.

THRILL your audiences!



WITH Sensational Films

GET new PRINTS Lowest PRICES Order from Producers

Exciting new films now ready

SPECIAL PRICE LIST SAMPLE FILM 10¢

WRITE TO Sensational Films BOX 1504 - HOLLYWOOD, CAL.

Save on MOVIE FILM

100 feet 16mm or 8mm film, including processing, \$1.75. Write for free bargain price list and close-out specials.

Write to Dept. HM 1
43 PROVINCE ST., BOSTON, MASS.



ONLY WE SAVE YOU SERVICE \$5

MORRISON'S

DECORATED ILLUSTRATED

16mm TITLES 3 WORDS OVER 51 WORDS 25¢ EA.

MINIMUM ORDER \$1 PLUS POSTAGE

KODACHROME TITLES, MAPS, CHARTS, PRICES, REQUEST

TITLE SERVICE FREE ANIMATED TITLES WITH ORDER

1600 BROADWAY NEW YORK, N.Y.

Print Your Own Film Titles



Photo titles, stationery, greeting cards, bookplates, advertising. Easy rules furnished. Junior Outfits \$5.25 up. Senior \$17 up. Print for Others, Big Profits. Sold direct from factory only. Write for free catalog and all details. Kelsey Presses, W-94, Meriden, Conn.

EXCELSIOR

"Glorified Sixteen . . ."

• Continued from Page 535

than fast enough to cover general needs.

Practically all average outdoor shots are taken at from f/8 to f/16, and inasmuch as the lens only closes to f/16 it will be seen that there is little or no chance to produce a fade by closing the iris down, so it becomes necessary to make a slight change in order that the diaphragm will close completely.

By removing a small set screw in the diaphragm stop ring, the ring may be removed. With a small hand grinder, the slot that the screw goes through can be lengthened out so the diaphragm will close down to an opening of .012", or approximately f/82.5, five full stops below f/16, which will produce a full fade on any film with a rating of 24 Weston or less.

Control of amount of footage used in producing a fade is relatively simple for the cam design. Two feet of film at 16 frames per second is considered about right to produce a fade or lap dissolve. As the effects shaft makes one revolution every 6.3 feet of film, this will mean approximately 114 degrees rotation of the cam for two feet of film.

Films like rare volumes . . .

• Continued from Page 538

These 8mm and 16mm commercial releases do much to make the average home movie show interesting to guests outside the family circle. A reel of news events projected between a screening of personal family films supplies relief from monotony that might grip those disinterested in personal filmings.

More and more, such films are finding their way into the permanent libraries of visual aid departments of educational systems. They are seen more frequently than ever as a part of the film programs of industrial and business organizations. If these films are worthy

Two cams are made for each of the stops anticipated to be used, one for opening and one for closing, except for the f/3.5 stop, for which one cam will open and close the lens.

Fig. 28 shows the details of the slide actuated by the cams.

After completing the slide, the various cams may then be laid out. One set of cams cover from 0 to f/stop used and the other set from f/stop to 0—zero being considered as the stop with the smallest opening.

Laying out a circle with the radius equal to the distance from end of the slide to the center of the effects shaft, lay out another circle with the radius equal to that of the lens opening wanted. The distance, then, between the spacing of the circles will be equal for either the opening of the diaphragm from 0 to f/- or f/- to 0.

Scribing two lines from the center of the cam 114 degrees apart, then proceeding from the inner ring and scribing a line upward to the outside ring, will give the contour for the cam. Trim to this line and mount the cam on a bushing with a 1/4" hole through it, which will provide for mounting on the effects shaft as shown in Fig. 27.

of such recognition, as indeed they are, surely they belong in more of the nation's personal home movie libraries.

• Exceptional films reviewed and qualifying for the distinction of "Movie of the Month" will be treated in detail in a feature length article in HOME MOVIES. In addition, a certificate evidencing the award of "Movie of the Month" and a special animated "Movie of the Month" leader will be returned with such films after review.

When submitting films for review and analysis, please advise make of camera, speed of lens, whether or not tripod was used, or if you used filters, exposure meter, or other accessories.

Have you joined the REEL FELLOWS?

GET on the bandwagon! Join the finest bunch of movie amateurs that ever clicked a cine camera! For a greater measure of good fellowship among brother hobbyists, register NOW! Identify yourself as a REEL FELLOW with a handsome gold REEL FELLOW emblem and a REEL FELLOW insignia on your camera.

Membership in the REEL FELLOWS will enable you to make some mighty fine acquaintances, for it's an organization that attracts those who are enthusiastic about your hobby—making movies . . . those who like to share their experiences with others . . . those who get a kick out of experimenting and achieving goals in the greatest of hobbies—Home Movies.

SEND IN THIS APPLICATION TODAY

REEL FELLOWS,
% HOME MOVIES MAGAZINE,
6060 Sunset Blvd.
Hollywood, Calif.

I am enclosing \$1.00 membership fee, for which please enroll me as a member of the REEL FELLOWS and send me gold emblem, membership card, and camera insignia.

I have been shooting movies..... Yrs. Mos.

My equipment is: 8mm.....16mm.....

NAME.....

ADDRESS.....

CITY.....STATE.....

ANIMATED

Title Backgrounds

THIS month we inaugurate a new feature for home movie titlers — an animated title background. If you will look closely at the five drawings on this page you will note that position of the dog's tail and tongue differs in each drawing. A movie made of these drawings properly animated will show the dog panting and wagging his tale — ostensibly after having just playfully dropped the ball before him.

To get the lettering of your title superimposed over the drawings, it will be necessary to letter the title text on a small panel of clear celluloid and lay it over the drawings as they are photographed. The celluloid may be purchased in sheets from the larger stationery stores and a piece cut to the required size.

In order to letter the celluloid with india ink, or in the case of Kodachrome, with poster colors, the celluloid should first be prepared by washing thoroughly and then applying ordinary talcum powder to the surface to be lettered, then brushing it off until the celluloid is fully clear again. This prepares the surface to take the ink or poster colors, allowing them to flow evenly with the stroke of the brush or pen, yet not "creep" nor "shrink" after application.

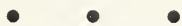

It is advisable, too, to wear a pair of thin cotton gloves while handling the celluloid to keep it free of finger marks. A celluloid panel thus lettered, may be washed of ink or poster color with soap and water and used again.

The lettering on many of the title backgrounds which have appeared in past issues of HOME MOVIES may be copied on the celluloid panel by laying it over the title, tracing the lettering, then filling in with ink or poster color.

It is extremely important that each drawing be accurately centered in the titler, otherwise it will appear "jumpy" on the screen. This also applies to laying the celluloid over each drawing. A simple method that will insure accurate centering when using these drawings and the celluloid in typewriter titlers was illustrated on page 477 of the October issue of HOME MOVIES.



Here is the routine to be followed in animating the drawings: As you will note, each is numbered on the margin — outside the field of focus—indicating the order in which they are to be filmed. By shooting drawings 1, 2, 3, etc., right down to number 5, one-half of the animated action will have been completed. Then reverse the order — shoot drawings 4, 3, 2, and 1, making sure to give each the same number of exposures, i.e., the same number of frames each. This completes the action which may be repeated as often as may be desired to allow for reading the title next superimposed over it.

Each drawing should be exposed for at least two frames although an interesting effect may be given by allowing drawings 1 and 5 added time on the screen, shooting each in single-frame exposure for about 15 or 20 frames.

Watch for more animated title backgrounds next month. They will supplant the regular series of title backgrounds for awhile.



CLASSIFIED • ADVERTISING

EQUIPMENT FOR SALE

● **BASS SAYS:** Heavy trading means many trade-ins. Get yours at these low prices.
USED CAMERAS
 8mm Cine Kodak Model 20, F:3.5 lens, \$19.75.
 8mm Cine Kodak Model 20, F:2.7 lens, \$27.75.
 8mm Cine Kodak Model 60, F:1.9 lens, \$49.50.
 8mm Bell & Howell Sportster, Cooke F:2.5 lens, \$52.50.
 8mm Movikon, F:2 lens, case, \$137.50.
 16mm Stewart-Warner, F:3.5 lens, \$12.75.
 16mm Cine Kodak B, F:3.5 lens, \$22.50.
 16mm Cine Kodak K, F:1.9 lens, \$54.50.
 16mm Cine Kodak Magazine, F:1.9 lens, \$82.50.
 16mm Bell & Howell Model 141 Magazine, Cooke F:2.7, \$84.50.
 16mm Bell & Howell Model 141 Magazine, Wollensak F:1.5 in focusing mount, \$97.50.
 16mm Victor Model 5, 1" F:3.5, 2" F:3.5, 3" F:4 lenses, \$107.50.
 16mm Bolex 16 with Hektor F:1.4 and case, \$225.00.
 16mm Zeiss Movikon, Sonner F:1.4 lens and case, \$297.50.
 16mm Filmo 70DA, with 12 volt motor drive, two 200 ft., one 400 ft. magazines, three lenses, masks and mask slot, carrying case, \$1043.00 value; price, \$600.00.
 35mm Bell & Howell Eyemo, reconditioned, 12, 24, 32 speed, sound aperture, Cooke F:2.5 lens, case, \$175.00.
USED PROJECTOR BARGAINS
 16mm Ampro Model J, 500 watt, with case, \$67.50.
 16mm Ampro Model NC, 750 watt, with case, \$97.50.
 16mm Bell & Howell Diplomat, gear driven, with case, \$127.50.
 Victor Sound on Film Model 12, with amplifier, \$124.50.
IN STOCK
 New Filmo Auto Master.
 New Revere Double 8 Camera with F:3.5 lens, \$29.50.
 New Revere Double 8 Turret camera with F:2.5 lens, \$65.00.
 New Double 8 Turret camera with F:2.5 lens, \$65.00.
 New Revere Double 8 Model B Projector, 500 watt, \$59.50.
 Send for new Revere literature.
 Free on request—84-page Bass Cine Bargain-gram. Most complete ever published.
BASS CAMERA COMPANY
 Dept. HC 175 W. Madison St. Chicago, Ill.

● **USED BARGAINS: CINE KODAK K.** 16mm F2.7; 1" F1.9; 33/4" F4.5, Case \$110.00; **MAGAZINE CINE KODAK** 16mm, \$85.00; **VICTOR 5**, 20mm F2.5, 1" F1.5; 4" TeleF4, Case \$140.00; **GRISWOLD 16mm SPLICER** \$12.50; **LENSES FOR FILMO, BOLEX, KEYSTONE, VICTOR, CAMERAS—DALLMEYER** 15mm F1.5; 1" F1.9 \$50.00 EACH, 3" F1.9 \$70.00; **FOR FILMO 8**, 20mm F1.5; 1" F1.5, 2" F1.9, \$55.00 EACH, 2" F2.9 \$40.00; 1" o.99 \$55.00; **WE RENT CAMERAS, LIGHTS, LENSES, PROJECTORS, EDITING OUTFITS TO CLUBS AND INDIVIDUALS IN NEW YORK AND VICINITY. ALL EQUIPMENT SOUND AND SILENT. WE BUY, TRADE AND SELL NEW AND USED MOTION PICTURE EQUIPMENT, 8-16-35mm. CAMERA MART, INC., 70 WEST 45th STREET, NEW YORK.**

● **FULL LIST PRICE ALLOWED** for your Eastman Model 20 or Keystone f:3.5 toward the purchase of a Bell & Howell Sportster, an Eastman 8mm Magazine, or a Revere Turret. Full list price allowed for Eastman Model 25, Keystone f:2.7, Revere 3.5, or Bell Howell Companion, toward the new 8mm Eastman Magazine. Full list price allowed for a Model 50 projector toward new Ampro 8mm or Bell Howell 8mm projector. **AS NEW:** Bell Howell Sportster with Wind-Bak, \$75. Bell Howell Companion with Wind-Bak, \$49.50. Bell Howell Turret with Wind-Bak, \$129.50. Model 60 Eastman f:1.9, list \$67.50, priced at \$39.50. 1 1/2" f:3.5 telephoto for Bell & Howell, \$33.50; for Keystone, \$27.50. 2" f:1.9 Dallmeyer lens, \$49.50. 1" f:1.3 Laack lens, \$30.50. 15mm f:1.5 Dallmeyer lens, \$49.50. 30x40 beaded screen with tripod, \$79.95; 36x48, \$10.50; 39x52, \$12.50. Hundreds of other bargains. Most liberal traders in the country. Write **NATIONAL CAMERA EXCHANGE**, established 1914, 11 So. 5th St., Minneapolis, Minn.

● **TELEPHOTO LENS SPECIAL—1 inch F:1.5** for 8mm Keystone, Revere, Bolex Emel cameras. Use with black and white, colored films. Bargain, \$12.50 C.O.D. \$1.00 deposit. **MALENA CO.**, 616 Market St., Philadelphia, Pa. Money Back Guaranteed.

● **EASTMAN 16mm magazine camera equipment:** 4 1/2" telephoto lens, \$40.00. Wide angle lens, \$35.00. Focusing finder, \$15.00. Pola Screen filter, \$5.00. Lens adapter, \$5.00. **JACK MOORE**, 4529 Fairway, Dallas, Texas.

● **BOLEX combination 16mm, 9 1/2mm, 8mm projector,** 500 W lamp, two lenses. Bargain at \$150.00. **VOS**, 2117 Rockledge Rd., Hollywood, Calif.

● Ten cents per word; minimum charge, \$2.00 cash with order. Closing date, tenth of preceding month. ● **HOME MOVIES** does not guarantee goods advertised. ● Send ads to 6060 Sunset Boulevard, Hollywood, California.

EQUIPMENT FOR SALE

● **BELL & HOWELL** projector, 57 series, 400 W. Rebuilt and refinished. Double claw, pilot light, etc., with model B Dalite 30"x40" screen. \$45.00. **ARTHUR H. HART**, 2125 32nd Ave., San Francisco, Calif.
 ● **LOOK!** Sacrifice for cash. Bell & Howell Sportster, f2/5 with \$45.00 MacVan backwind and frame counter, compartment case, 9 Wratten filters, and filter holder—all for \$80.00. 1 1/2" Bell & Howell f/3.5 telephoto for 8mm, perfect condition, \$25.00. **R. E. BURRIS**, State College Station, Fargo, N. D.
 ● **PAILLARD BOLEX** Headquarters for the West is **Morgan Camera Shop**. Try the multi-featured Bolex 16mm or 8mm camera before buying. See them at 6262 Sunset Blvd., Hollywood, California.

● **MOVIE** Cameras, Films, Projectors, etc., bought, sold, and exchanged. Big lists Free. Art samples, 25c. **PEERLESS**, Box 1310-H, Hollywood, Calif.

ACCESSORIES

● **BARGAINS** in 16mm projectors, films, and camera lenses. List furnished. 15mm wide angle lens wanted. **PHOTOGRAPHER**, 1826 Kenilworth, Berwyn, Ill.
 ● **BELL & HOWELL** projectors, 16mm, 500-W., \$45.00 each. Film subjects, 50 ft. 8, 65c; 100 ft. 16, \$1.25, all new. Exchange rate, 25c per 50 ft. 8, 100 ft. 16. Sound and silent 400 ft. subjects, \$3.00 up. Exchange rate, 75c. **VICTOR 24-B Sound Projectors**, \$145.00 each. **HOLMES "Movies for Homes,"** 3030 Germantown Ave., Philadelphia, Pa.
 ● **146 ADULT** film subjects. Lists, lens cleaner, 10c. Univex representatives wanted, towns under 5,000. Details, stamp. **JENKINS**, 392, Elmira, N. Y.

FILM RELEASES (8 and 16mm)

● **8MM FILM** Exchange Library, Sales—Exchanges. Latest releases. Complete selection. Quality prints. Free Catalogue. **RIEDEL FILMS**, 2221 W. 67th St., Cleveland, Ohio.

FILM RELEASES

● **SPECIAL!** 25ft 8/8mm film, Weston 8, daylight loading, including processing, 75c. **RITTER FILM SERVICE**, 629 Lyman Ave., Oak Park, Ill.
 ● **"ARTIFILM"** As You Like It! One thin dime brings big prepaid sample, catalogs, amazing GIFT offers! **PARISIAN**, 4228-D Lincoln, Chicago.
 ● **LATEST 8-16mm War, Comedy, Travel, Unusual Subjects.** Send 10c for sample and lists. A personal service. **RIO**, 413-H Elmira, N. Y.
 ● **SOUND and Silent Films** exchanged, bought, sold, rented. Bargains always. New Free lists. **FRANK LANE**, 5 Little Bldg., Boston, Mass.
 ● **REAL "ART"** Film. Send 10c today for generous prepaid sample; big illustrated catalogs included. **CINEART**, 4224-B Lincoln, Chicago.
 ● **"PLEDGE Of Allegiance To Our Flag"**—moving patriotic background, a stirring film (16mm-8mm) \$1.00. Free movie titles. **MERCURY PICTURES**, 1157 N. McCadden, Hollywood, Calif.
 ● **8MM SUBJECTS** for sale or rent. Charlie Chaplin's, Snub Pollard's, Paul Parrott's. 200 ft. 8mm brand new comedies. Send for list and catalogs. Large rental library. **THE ABBE FILMS**, 1265 Broadway, New York.
 ● **16MM EXCHANGES**, rentals, sales, 16mm and 8mm films and equipment. Exchanges and rentals of Art subjects. **BALD MOUNTAIN EXCHANGE**, Somers, Conn.
 ● **UNUSUAL ART** Film Catalogue. All latest releases. Send 10c for sample. **ERWINES CINE LABORATORIES**, 43 North Ninth St., Allentown, Pa.
 ● **8-16mm FILMS**—All subjects sold, rented, exchanged. Bargains in equipment—silent, sound. Free illustrated catalogue (with sample Art film, 10c). **PARKWAY EXCHANGE**, 961 Eastern Parkway, Brooklyn, N. Y.

TITLING SERVICE

● **NOW IS THE** time to title those vacation shots. Four titles (b&w) for \$1.00. End and titles free with eight. **WHITEMAN'S 16MM SERVICE**, 312 E. 7th, Clovis, N. M.
 ● **TITLES** printed, eight words or less; 8mm, 15c; 16mm, 20c. Minimum order \$1.50. Samples and complete hand lettered "The End", 10c. State size. **MIDWEST TITLE SERVICE**, 1024 Quincy, Topeka, Kansas.
 ● **SUNBEAM** Kodachrome titles, 8 and 16mm. Professional, glowing colors. Sample free! **W. C. KANE**, 102 Gibbs St., Rochester, N. Y.

PROCESSING SERVICE

● **MOTION PICTURE** Processing—100' 16mm 75c; 50' 16mm, 50c; 25' 8/8mm, 35c; 25' 8mm, 25c. Write for film price list. **RITTER FILM SERVICE**, 629 Lyman Ave., Oak Park, Ill.
 ● **STRAIGHT** 8mm duplicates, 3c per foot. Minimum order, \$1.00. **CINE-X REVERSAL LABORATORIES**, 7404 Santa Monica Blvd., Hollywood, Calif.
 ● **100 FT. 16MM, \$1.00; 25' 8mm, 50c; 30 ft straight 8mm, 15c.** Discount to dealers. **CINE-X REVERSAL LABORATORIES**, 7404 Santa Monica Blvd., Hollywood, Calif.

EXCHANGE OR TRADE

● **SHOTGUNS.** Target Pistols and Binoculars accepted in trade on everything photographic, including Liecas, Contaxes, Eastman and Bell & Howell motion picture equipment and Da-Lite Screens. Write for Catalog. Convenient time payments may be arranged on anything new or used. **NATIONAL CAMERA EXCHANGE.** Established in 1914. 11 So. Fifth St., Minneapolis, Minn.

HOBBY BOOKS

● Are you a "beginner" in the ranks of amateur movie makers? Would you like to know how to use your camera to the very best advantage, yet avoid the mistakes and wasted film that so often results from lack of knowledge of fundamentals of cine camera operation? Then order a copy of "How to Use a Movie Camera." Just 50c, and well worth it.
 Would you like to learn how to process your own movie film so that you can buy inexpensive film in bulk? Let us send you "How to Process Home Movie Film," a book chock full of instructions and advice by experts plus complete, easy-to-understand plans for building your own simple processing equipment. Sent postpaid for 50c.
 Would you like to know how to make your own titles? What equipment to use—what exposure to use—all about auxiliary lenses—title areas, etc? Would you like complete plans for building a very simple and versatile home movie titler? Then send for "How to Title Home Movies"—the latest and one of the most authentic books ever written on the subject. Price \$1.00 per copy. We pay the postage.
VER HALEN PUBLICATIONS
 6060 Sunset Blvd. ● Hollywood, Calif.

Reserve Your Copy Now . . . !

\$1

COPY

HOW TO MAKE HOME MOVIE GADGETS

A new book containing over 100 illustrations and descriptions of handy gadgets any amateur can build for special effects, titling, lighting, photography, etc.

\$1

COPY

HOME MOVIES, 6060 Sunset Boulevard, Hollywood, Calif.

STATEMENT OF THE OWNERSHIP, MANAGEMENT, CIRCULATION, ETC.,
 REQUIRED BY THE ACTS OF CONGRESS OF AUGUST 24, 1912,
 AND MARCH 3, 1933

Of Home Movies, published monthly at Los Angeles, California, for October 1, 1940.

STATE OF CALIFORNIA } ss.
 COUNTY OF LOS ANGELES }

Before me, a Notary Public in and for the State and county aforesaid, personally appeared C. J. Ver Halen, Jr., who, having been duly sworn according to law, deposes and says that he is the Publisher of the Home Movies and that the following is, to the best of his knowledge and belief, a true statement of the ownership, management (and if a daily paper, the circulation), etc., of the aforesaid publication for the date shown in the above caption, required by the Act of August 24, 1912, as amended by the Act of March 3, 1933, embodied in section 537, Postal Laws and Regulations, printed on the reverse of this form, to wit:

- That the names and addresses of the publisher, editor, managing editor, and business managers are:
 Publisher, CHAS. J. VER HALEN and C. J. VER HALEN, JR., LOS ANGELES.
 Editor, ARTHUR E. GAVIN, LOS ANGELES.
 Managing Editor
 Business Managers
- That the owner is: (If owned by a corporation, its name and address must be stated and also immediately thereunder the names and addresses of stockholders owning or holding one per cent or more of total amount of stock. If not owned by a corporation, the names and addresses of the individual owners must be given. If owned by a firm, company, or other unincorporated concern, its name and address, as well as those of each individual member, must be given.)
PARTNERSHIP
 CHAS. J. VER HALEN, 9014 LARKE ELLEN CIRCLE, LOS ANGELES.
 C. J. VER HALEN, JR., 9024 LARKE ELLEN CIRCLE, LOS ANGELES.
- That the known bondholders, mortgages, and other security holders owning or holding 1 per cent or more of total amount of bonds, mortgages, or other securities are: (If there are none, so state.) NONE.
- That the two paragraphs next above, giving the names of the owners, stockholders, and security holders, if any, contain not only the list of stockholders and security holders as they appear upon the books of the company, but also, in cases where the stockholder or security holder appears upon the books of the company as trustee or in any other fiduciary relation, the name of the person or corporation for whom such trustee is acting, is given; also that the said two paragraphs contain statements embracing affiant's full knowledge and belief as to the circumstances and conditions under which stockholders and security holders who do not appear upon the books of the company as trustees, hold stock and securities in a capacity other than that of a bona fide owner; and this affiant has no reason to believe that any other person, association, or corporation has any interest direct or indirect in the said stock, bonds, or other securities than as so stated by him.
- That the average number of copies of each issue of this publication sold or distributed, through the mails or otherwise, to paid subscribers during the twelve months preceding the date shown above is _____ (This information is required from daily publications only.)

C. J. VER HALEN, JR.
 (Signature of editor, publisher, business manager, or owner.)
 Sworn to and subscribed before me this 8 day of Oct., 1940.
 [SEAL] L. E. GRILL
 (My Commission expires Oct. 13, 1941.)

America's Outstanding Titleer!

ON EVERY MOVIE MAKER'S "WANT LIST"

Cine Master TITLEER

A Four Star Product ★ ★ ★ ★

It has everything - - -
Note these features!

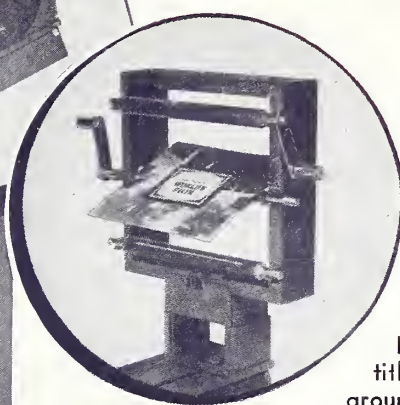

A larger "field area" is created by photographing titles at a 12" distance. This larger area allows more room for hand lettering, printing, drawing and special effects. Title cards may also be photographed at 4", 6" and 8" in addition to the 12" distance. ★★★★★ Zoom titles and superimposed titles are easily made on the Titleer. ★★★★★ Title backgrounds and animation sets appearing each month in Home Movies are readily accommodated. ★★★★★ Accurate alignment is assured with a custom made camera base for your particular camera, eliminating all fuss and bother in lining up titles. Bases for all popular cameras are interchangeable on the Titleer. ★★★★★ All parts are adjustable on the Titleer base, making it ideal for table top copy work and ultra close-up photography. ★★★★★ Titleer may be used on any tripod or suspended in a vertical position. ★★★★★ The lighting assembly is easily removed or placed at any position on the Titleer base.

Custom camera bases to fit Revere 8, Eastman Magazine 8, Bell & Howell, Keystone, and all other popular cameras.

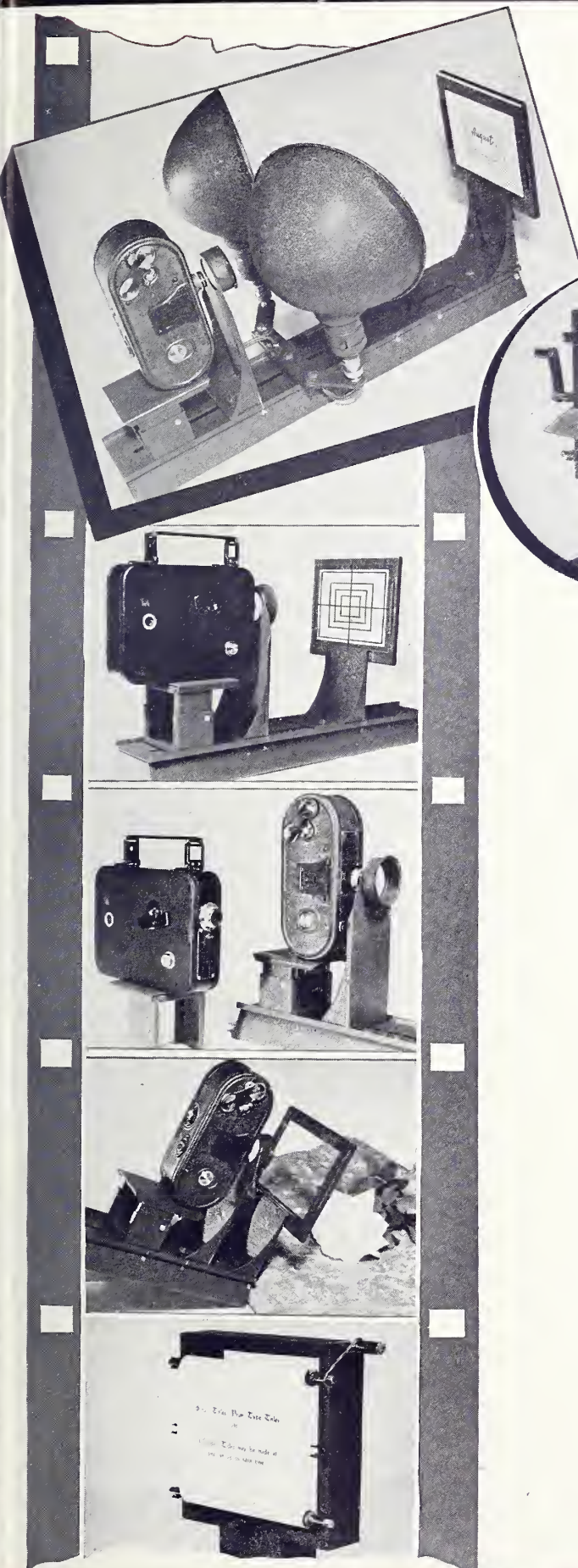

\$695

LESS LIGHTS

\$995

WITH LIGHTS

Complete with two auxiliary lenses, celluloid target, instructions and valuable titling data.

And Now A New Accessory! TITLEER PROFESSIONAL ATTACHMENT

With this new attachment it is possible to make Turnover, Turnabout, Turn-around, Flop Up and Flop Down, Revolving, Horizontal and Vertical Scroll and Rolling Titles. Superimposed, Pushout or Wipe Off Effect Titles, Zoom combinations and many other professional titles. The Professional Attachment is instantly attached to the Cine Master Titleer.

PROFESSIONAL
ATTACHMENT

\$395

TITLEER ACCESSORY KIT No. 1

Includes an 8" auxiliary lens, set of 25 Titles and Backgrounds, a translucent screen for rear projection shots and two sheets of clear celluloid for superimposed titles.
Complete Kit.....

\$195

At Your Dealer or Write to

HOLLYWOOD CINE PRODUCTS CO. 3221 SO. FIGUEROA ST. LOS ANGELES, CALIF.

(Ciné-Kodak Film)

GOOD FILM = GOOD MOVIES

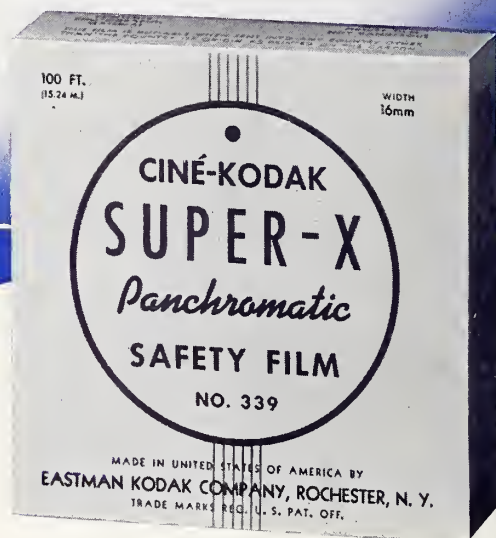

MOST movie makers have discovered that the surest assurance of good movies is to use really good film—Ciné-Kodak Film. With Ciné-Kodak Film in their cameras they go about their movie making confidently, free to concentrate on the character of their shots.

Ciné-Kodak Film is the accepted standard of reliability, uniformity, brilliance, and clean-cut quality. When it is processed and made ready for projection (at no added cost) it receives exactly the same precise, scientific handling as that which governed its manufacture.

Ciné-Kodak Film is made in several types, black-and-white and full-color Kodachrome. Among the black-and-white films, Super-X Panchromatic (16 mm.) is the new popular favorite. It's fast enough for most movie making, and beautifully brilliant and clean cut. Fine grain, too. In 100-foot rolls at \$6; 50-foot rolls, \$3.25; 50-foot magazines, \$3.50.

If it's worth shooting, it's worth Ciné-Kodak Film.

EASTMAN KODAK COMPANY, ROCHESTER, N. Y.

Price 25c

HOME MOVIES



Courtesy Metro-Goldwyn-Mayer

December . 1940

LARGEST CIRCULATION OF ANY AMATEUR MOVIE MAGAZINE!

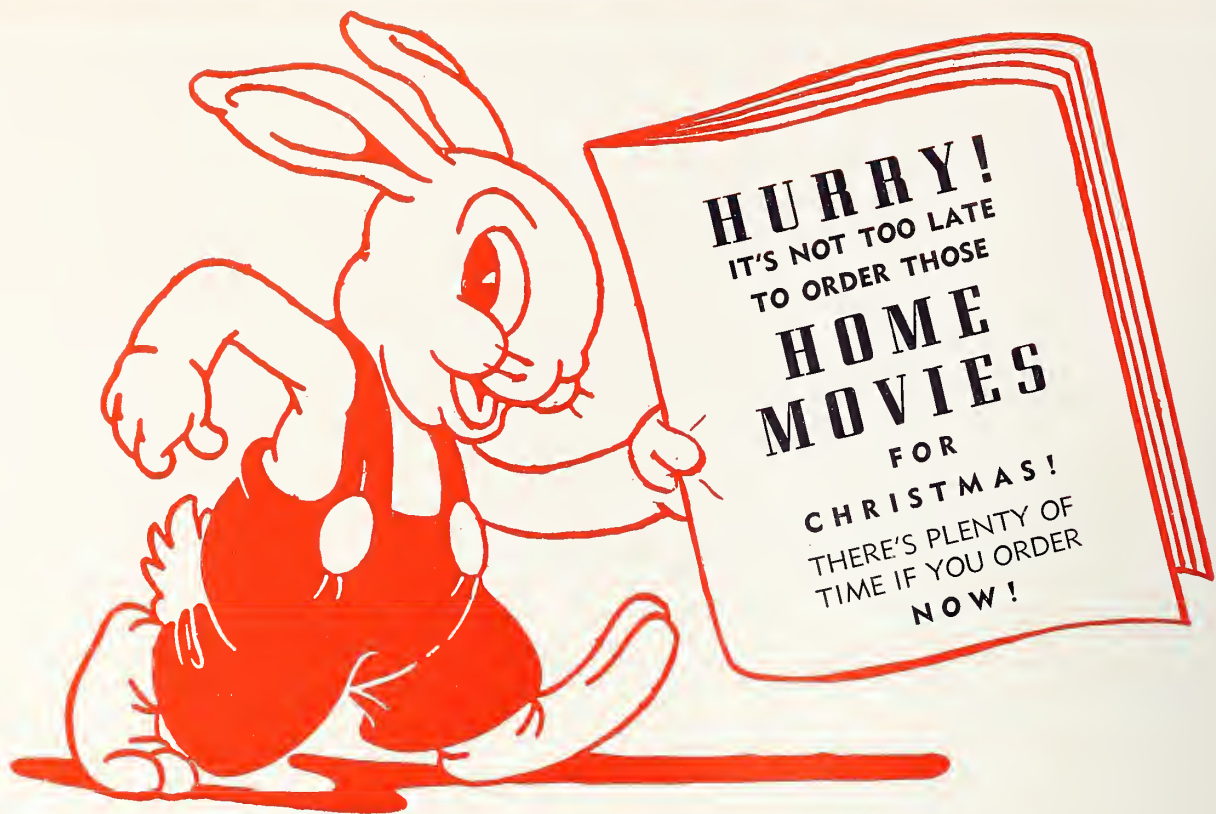

IT WILL BE A MERRIER CHRISTMAS IF "HOME MOVIES" ARE ON THE PROGRAM



HOME MOVIES can easily solve the "want to give the amateur movie fan" problem! The wide variety of subjects and reasonable price make HOME MOVIES ideal gifts in which the entire family may share!



MICKEY MOUSE and DONALD DUCK

The Walt Disney gang, favorites throughout the world, are starred in more than 100 HOME MOVIES subjects. The 100 ft. 8mm and 200 ft. 16mm films are complete-length productions.

In 8mm or 16mm: 25 ft.75c 50 ft.\$1.50 100 ft.\$3.00
200 ft. (16mm only)\$7.50

OSWALD RABBIT and THE 3 MONKEYS

Walter Lantz presents his laugh-provoking cartoon characters, Oswald Rabbit and The Three Monkeys—Meany, Miny, and Moe—in a wide variety of subjects.

In 8mm or 16mm: 25 ft. 75c; 50 ft. \$1.50; 100 ft. (16mm) \$3.00

COMEDIES

Christie Comedies starring such favorites as Bobby Vernon and Billy Dooley, and Charlie Chaplin Comedies are available from 25 ft. lengths up to 2-reel feature-length productions.

MISCELLANEOUS

Scenics, travels, western dramas, historical and aviation subjects . . . as well as many other classifications will be found in HOME MOVIES . . . anything and everything the amateur movie fan desires for his programs.

AND HUNDREDS OF OTHER "AUDIENCE-TESTED" SUBJECTS—EVERYONE A "HIT!"

SHIPMENT MADE WITHIN
48 HOURS
AFTER RECEIPT OF ORDER!

**SPECIAL
Christmas Releases!**

★ NO. 1401B—"MICKEY PLAYS SANTA CLAUS"

Mickey and Pluto as Christmas carolers provide a very merry Christmas for the poor widow and her many children.

100' 8mm \$3.00 200' 16mm \$7.50

★ NO. 126A—"THE STORY OF SANTA CLAUS"

50' 8mm \$1.00 100' 16mm \$2.00

★ NO. 462A—"HOLY NIGHT"

50' 8mm \$1.00 100' 16mm \$2.00

★ NO. 125C—" 'T WAS THE NIGHT BEFORE CHRISTMAS"

200' 8mm 3.75 400' 16mm \$10.00

★ NO. 456B—"THE NIGHT BEFORE CHRISTMAS"

(Condensed Version of No. 125C)
100' 8mm \$2.00 200' 16mm \$5.00

WRITE NOW FOR FREE CATALOG TO—

SEEMANNS, INC., 6628 Santa Monica Blvd., Hollywood

EXCLUSIVE WORLD-WIDE DISTRIBUTORS
FOR

HOLLYWOOD FILM ENTERPRISES, INC.
6060 SUNSET BLVD. • HOLLYWOOD, CALIF



ADVISORY EDITORS

- A. K. BAUMGARDNER**
Peoria Cinema Club
- R. BEZEK**
Chicago Cinema Club
- JAMES BIALSON**
Amateur Motion Picture Club of St. Louis
- ROSS BROWN**
Dallas Cinema Club
- BURGE BURNWOOD**
The 8-16 Movie Club, Philadelphia, Pa.
- GEORGE W. A. CADARETTE**
Los Angeles 8mm Club
- EMERSON CLYMA**
Detroit Society of Cinematographers
- WELL A. DIXON**
Pittsburgh Amateur Cinema Club
- AL DVORAK**
Suburban Amateur Movie Club
- THOMAS E. GIBBS**
Portland Cine Club
- W. A. HOOK**
Seattle 8mm Club
- ED F. KAUFMAN**
Indianapolis Amateur Movie Club
- W. H. NESTELL**
Cinememen Club
- GEORGE A. PELLETIER**
Toronto Amateur Movie Club
- ROBERT B. PETERSON**
Metropolitan Cine Club
- W. E. RIEBETH**
Minneapolis Cine Club
- W. H. ROOTH**
Sherman Clay Movie Club
- W. H. ROUNTREE**
Bay Empire 8mm Movie Club
- W. H. SNYDER**
Norfolk Amateur Movie Club
- W. H. SNYDER**
Des Moines Y.M.C.A. Movie Club
- W. H. SISEL**
Austin Movie Club
- W. H. ENION SMITH**
Metro Movie Club of Chicago

home MOVIES

Copyright 1940 by Ver Halen Publications. No part of magazine may be reprinted without specific permission.

CONTENTS FOR DECEMBER, 1940

READER SPEAKS	572
INFORMATION PLEASE	574
WITH ADVANCED CINEFILMERS	576
TITLE TROUBLES	578
SOME NEW IDEAS FOR CHRISTMAS FILMING..... <i>By R. E. Worstel</i>	581
MOTHER, DAD AND THE CHILDREN STAR IN THIS CHRISTMAS SCENARIO	<i>By J. H. Schoen</i> 582
HOW I FILMED MY PRIZE WINNING PICTURE	<i>By J. Allyn Thatcher, D.D.S.</i> 584
BUILD YOUR OWN EQUIPMENT AS THIS CINEBUG DID!	<i>By Curtis Randall</i> 586
A TURRET WITH BUILT-IN TELE-LENSES FOR KEYSTONE "8"	<i>By Jack Irwin</i> 588
THREE IDEAS THAT MAKE TITLING EASIER. <i>By George W. Cushman</i>	590
TIPS ON MAKE-UP FOR HOME MOVIES. <i>By Jacob Deschin, A.R.P.S.</i>	591
ZONE LIGHTING FOR CINE PHOTOGRAPHY	<i>By Dr. A. K. Baumgardner</i> 592
LLOYD BACON FIRST HONORARY MEMBER OF THE REEL FELLOWS	<i>By Warren Garin</i> 593
TITLE CENTERING GUIDES	594
FINAL CONVERSION STEPS FOR "GLORIFIED 16". <i>By Arthur H. Hart</i>	595
MOVIE OF THE MONTH..... <i>By J. H. Schoen</i>	596
SOME FILMING IDEAS THAT "CLICKED"..... <i>Reviews by the Editors</i>	597
WHAT ARE YOU GIVING YOURSELF FOR CHRISTMAS?.....	598
EXPERIMENTAL CINE WORKSHOP	602
"IT'S NEW TO ME"..... <i>By Cinebug Shopper</i>	604
INDOOR LIGHTING CHART.....	612
DIRECTORY OF AMATEUR CINE CLUBS.....	626
TITLE BACKGROUNDS	628
ANNUAL INDEX	630

EDUCATIONAL FILMS SECTION

LIGHTING INTERIORS IN TEACHING FILM PRODUCTIONS	<i>By Jesse S. Cohen</i> 600
U. OF I. SUPPLY CENTER FOR TEACHING FILMS. <i>By Wm. J. Inskeep</i>	601

★ Shot of the Month: Interesting for its angular composition and of course its seasonal motif.

CHAS. J. Ver HALEN PUBLISHER	C. J. Ver HALEN, JR. ASSOCIATE PUBLISHER	ARTHUR E. GAVIN EDITOR
---------------------------------	---	---------------------------

OFFICE OF PUBLICATION
6060 Sunset Boulevard, Los Angeles, Calif.
Phone GRanite 5149

NEW YORK OFFICE
Everett Gellert, 62 West 45th Street
Vanderbilt 6-5254

CHICAGO OFFICE
C. N. Burris, 712 Wrigley Building
Whitehall 7784



★ Shot of the Month ...

DECEMBER
1940
NUMBER 12
VOLUME VII



RAY FERNSTROM
Technical Editor

GEORGE W. CUSHMAN
J. H. SCHOEN
Associate Editors

COUNT H. von SCHOENFELDT
Photographic Editor

C. E. BELL
Associate Photo Editor

L. C. BUSCHER
Art Director

Second-Class Matter, May 6, 1938, at office at Los Angeles, Calif., under the Act of March 3, 1879.
Subscription rates: U. S. \$2.00 per year. Canada and Foreign Countries, \$3.00 per year. Single copies 35c. Canadian and Foreign single copies 35c. Copyright 1940, by Ver Halen Publications. Advertising rates on application.

Christmas

MAKE YOUR GIFT SELECTION FROM THESE



Films to delight everybody! Scores of subjects to choose from! All superbly produced! Wonderful films to own . . . wonderful films to give—in confidence that your gift will be used and cherished through the years. Every Castle film bears our name . . . your guarantee of home movie excellence!

SANTA CLAUS STORY

Santa speaks to the youngsters and the young in heart in the loveliest Christmas fantasy ever filmed! Get this Castle exclusive for that child who has "everything"! He'll remember your gift always. It's message is unforgettable!

A world aflame . . . a world torn asunder is recorded for all to see in this only authentic and complete movie review of twelve months of shattering change. Castle Films' "News Parade of the Year" preserves for all time the mounting pace of events, month by month, through the world's most tragic year!



CASTLE FILMS

30 ROCKEFELLER PLAZA
NEW YORK

FIELD BUILDING
CHICAGO

RUSS BUILDING
SAN FRANCISCO



16·MM·8 CASTLE HOME MOVIE TRIUMPHS!



BOY MEETS DOG

An up-to-the-minute fun cartoon that everybody will roar over! Taken from the famed comic strip "Reg'lar Fellers", it's one long, loud laugh from start to finish! Of course the kids will love it! Here's one Christmas gift which will bring fun throughout the year!

OR MAKE YOUR CHOICE FROM ANY OF THE GALAXY OF OTHER CASTLE HOME MOVIE HITS Including:

ICE CARNIVAL

Flashing blades in graceful solos and dazzling, spectacular ensembles!



WINGS OVER WORLD WONDERS

Famed spots of many continents—viewed from the air! The most novel world tour ever put on film!



GAY NINETIES LIVE AGAIN

The most colorful period in our history brought to breathing life! Authentic pictures of America's golden age!



—and many more.

Write today for the complete and fascinating 32-page illustrated Castle Catalogue.

Send this convenient order form to your photo dealer NOW!

Please send the Castle Films' motion pictures in the size and edition checked		16mm SIZE			8mm SIZE	
		Headline 100 Feet	Complete 360 Feet	Sound 350 Feet	Headline 50 Feet	Complete 180 Feet
		\$2.75	\$8.75	\$17.50	\$1.75	\$5.50
Santa Claus Story _____						
News Parade of the Year _____						
Boy Meets Dog _____						

NAME _____ ADDRESS _____

CITY _____ STATE _____ 12⁶

CRAIG EDITING EQUIPMENT

A GIFT FOR THE *Entire Family*
ENJOYED THE *Entire YEAR*



PROJECTO-EDITORS — FOR ACTION EDITING

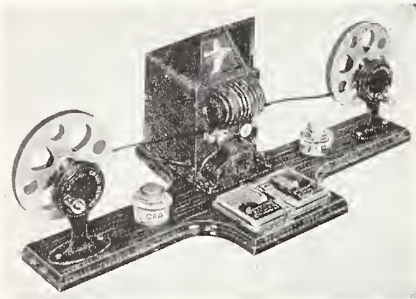

the Hollywood Studio Way

A smoothly animated viewing device allowing careful inspection, slow motion if desired, of actual movement on its brilliant miniature screen.

The 8mm model, as illustrated at left, complete with 8mm Junior Splicer and Rewind combination... mounted on a hardwood base with a bottle of Craig Safety Film Cement, \$27.50. 8mm Projecto-Editor alone, \$22.50.

16mm model with Senior Splicer and Rewinds... \$49.50.

CRAIG 16mm SENIOR SPLICER

A professional type dry splicer—for sound or silent film. Its unique design, combined with precision machining and sturdy construction, has made this the outstanding splicer for the amateur. Only 4 easy operations to make perfect, straight splices... quickly... accurately... and without wetting the film. For Sound or Silent Film... \$10.00.

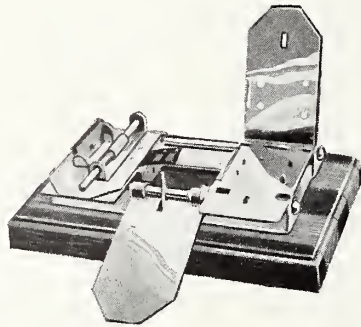

CRAIG FOTOFADE
FOR MAKING PROFESSIONAL-LIKE FADES AND WIPES

Here's the finishing touch for all well-edited movies. FOTOFADE permits the joining of odd scenes with smooth fades or wipes—dissolving one into the other without abrupt loss of continuity so essential to modern attention-compelling movies. Easy and quick to use—no special equipment necessary. Bottle sufficient for hundreds of applications, only \$1.00. Complete instructions included.

★ It takes proper *Editing* to make modern fast-moving, interest-sustaining movies. Through the careful selection of desired scenes, their rearrangement into proper sequence and the insertion of titles and fades for maintaining continuity—many random shots can be transformed into smooth-running sequences that everyone will enjoy seeing.

Your entire family will derive increased enjoyment from your home movies when they are edited with *Craig Editing Equipment*. For utmost satisfaction, insist on CRAIG—there is no finer gift.

Ask Your Dealer or Write for New, Free Folder

- Craig Senior Rewinds \$4.50 each or \$9.00 the pair
- Craig Junior Splicer 8 or 16 mm., \$2.50
- Craig Junior Combination Complete, \$7.25
- Craig 16mm. Senior Splicer For sound or silent, \$10.00
- Craig Senior Combination Complete, \$19.50

The Reader



SPEAKS

Circle of Confusion

The following is one of several letters which have been received requesting an explanation of the "circle of confusion"—a term relating to lenses and mentioned in one of Dr. Baumgardner's recent articles. In this instance, we prevailed upon Advisory Editor Baumgardner to answer this specific request and his letter follows that of reader M. R. Ehrer:

Dear Sirs: I believe that your proposed series of articles on light and lenses, the first of which appeared in the September issue, will be of value to every amateur. However, I think that all terms used in these articles should be clearly defined in the article or in a glossary at its conclusion. For example, I should like a further explanation of the term, "circle of confusion."

—M. R. Ehrer, Sacramento, Calif.

Dear Mr. Ehrer:

As a preliminary explanation, a picture cast upon an emulsion in the form of an image should be considered as a mosaic formation of many, many points of focus. This is contrary to the common conception that a picture is a single focus of the object. Each small point of detail is carried from the object through the beam of light into the lens system and is carried through to the emulsion depending upon the basic factors which include distance of object, focal length of lens, and distance of image. When the image is cast upon the emulsion at the distance which corresponds to the focal length of the lens and the object is placed at infinity, we have the smallest circle of confusion for that particular lens.

The circle of confusion, according to my idea is the focus of a single point in its smallest conceivable form which retains sharpness of detail. Since the size of the image varies with focal

length, we have circles of confusion of different sizes with separate focal lengths.

These small circles which are in reality, points of focus, are circular in form due to aberration and distortion, but since they are small in comparison to the image size we do not see them as actual circles. It is only by throwing the picture out of focus that the circles become large enough to distinguish them as such, and as they overlap each other in becoming larger, they ruin detail within their own circle and all adjacent ones. A blurred mass results and the picture is spoiled. However, we in cinematography are dealing with lenses of the shortest focal lengths, except in telephotography, and circles of confusion are the smallest in existence. It is only because of this small circle of confusion or sharpness of detail that we are able to project the image, enlarged thousands of times on the screen, and retain this detail. As the enlargement increases, however, the blur is more apparent. Thus, perfect focus is necessary to keep the size of the circle down to a minimum. While the circle of confusion is a theoretical term, it actually exists. Optical engineers go farther with this study to break it down to microscopic proportions, but for our purposes we are more concerned with end results.

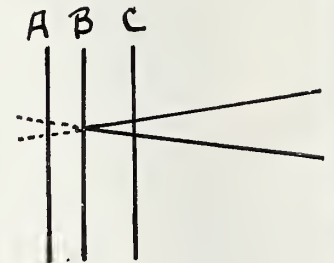

The accompanying drawing may explain somewhat the effect as we can best visualize it. Note that we have three different positions to illustrate the dis-

• Continued on Page 611

CRAIG "Makes Editing a Pleasure"

CRAIG MOVIE SUPPLY CO.
1053 S. OLIVE ST. • LOS ANGELES, CALIF.

DO IT TODAY!

SEND IN YOUR ENTRY FOR THE



(Reg. U. S. Pat. Off.)

Screen Naming CONTEST



\$1,050.00 IN 139 PRIZES

Contest Closes December 31, 1940

FIRST PRIZE, Cash . . \$200.00

3 Second Prizes, Cash, Each \$40.00

10 Third Prizes of Da-Lite PROJECTOR STANDS

Retail Price Each — **\$18.00***

These stands are adjustable in height and have tilting rotating platform. They are ideal for showing movies, for use as a camera tripod or a support for clamp-on type light reflectors.



25 Fourth Prizes of Da-Lite No. 2 UNIPODS

Retail Price Each — **\$6.00***

This popular camera support has a neck strap and is adjustable in height from 11" to 17". For movie or still camera. Weighs only 12 oz.



100 Fifth Prizes of Da-Lite

22" x 30" JUNIOR SCREENS

Retail Price Each — **\$4.00***

This has Da-Lite's Glass-Beaded screen surface and special two-ply spring wire support for setting up on a desk or table.



Used as a Hanging Screen

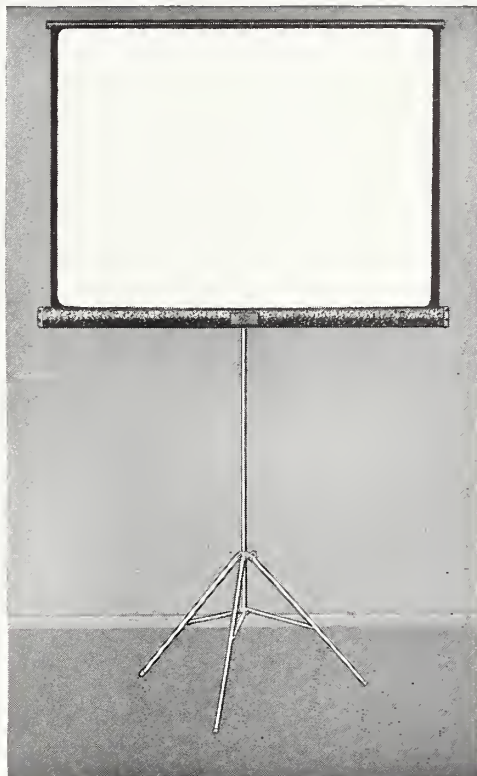

Used as a Tripod Screen

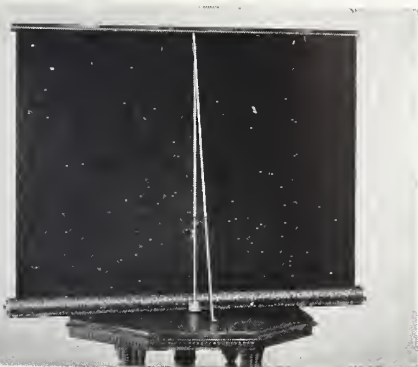

Used as a Table Model

THREE SCREENS IN ONE \$7.50*

SIZE 30" x 40"

Contest Closes December 31st, 1940

So, if you want to win that \$200.00 first prize or any of the other 138 valuable prizes, send in *your* entry today! Nothing to buy. All you do is suggest a name for Da-Lite's new low-priced triple duty screen. These facts about the screen will help you in selecting an appropriate name. It is a triple duty screen that can be used as (1) a tripod screen, (2) a map-type hanging screen, or (3) a table screen. The surface is Da-Lite's famous Glass-Beaded surface, which reflects more light and stays white longer than any other white surface. This screen (a 30" x 40" size) with case, folding tripod, and special Da-Lite two-ply spring support for setting up on a table, sells for only \$7.50*. This is the first time that a screen of this size, style and quality, has ever been offered for so low a price. See this new Da-Lite Screen at your dealer's! Ask him for entry blanks. There will be 139 prizes totalling \$1,050.00, and you may win one of them. *Send your entry today to Da-Lite Screen Contest Editor, 215 N. Michigan Ave., Chicago, Ill.*

*Prices slightly higher on Pacific Coast.

DA-LITE SCREEN COMPANY, INC.

2723 N. Crawford Ave.

Dept. 12 H.M.

Chicago, Illinois

FOLLOW THESE EASY RULES!

1. Suggest a name for DA-LITE'S NEW GLASS-BEADED Combination Tripod-Hanging-Table Screen and give in 25 words or less your reason why you think this name is best.
2. Send in as many entries as you wish. Mail to DA-LITE Screen Contest Editors, 215 N. Michigan Ave., Chicago, Illinois.
3. The contest closes December 31st, 1940. Your entries must be post-marked not later than midnight, December 31st, and must be received by us within ten days.
4. An independent, experienced contest organization will have complete charge of the contest. They will judge all entries from the standpoint of originality, uniqueness and applicability of the name suggested in conjunction with the sender's reason for recommending it. Decision of judges will be final. In case of ties, duplicate prizes will be awarded. All entries become the property of the DA-LITE Screen Company, Inc., Chicago, Ill. No entry will be returned.
5. Anyone living in continental United States may compete, except employees of DA-LITE Screen Company, Inc., and its advertising agency or their families. The contest is subject to Federal, State and Local regulations.
6. Prizes with a total value of \$1,050.00 will be awarded. First prize is \$200.00 cash. See complete list of prizes at upper right.
7. All winners will be notified by mail. A complete list of the winners will be sent on request of any contestant enclosing stamped, addressed envelope.

ENTRY BLANK Mail Now!

CONTEST CLOSING DECEMBER 31, 1940

DA-LITE SCREEN CONTEST EDITOR
Dept. 12 H.M.

215 North Michigan Avenue, Chicago, Ill.

For the new Da-Lite Glass-Beaded Triple Duty Screen I suggest the name:

My reasons are:

Limit statement to 25 words or less.

NAME

ADDRESS

CITY

STATE

NAME OF DEALER

Date

IT'S HERE AT LAST!

WHAT EVERY MOVIE MAKER WANTS

PERFECTLY SYNCHRONIZED SOUND

AT A PRICE YOU CAN AFFORD

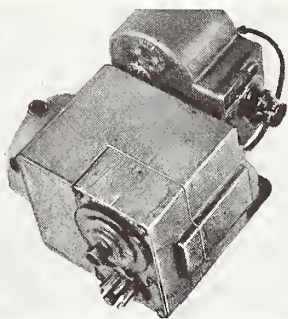

B & H 8mm. camera with electric motor drive.

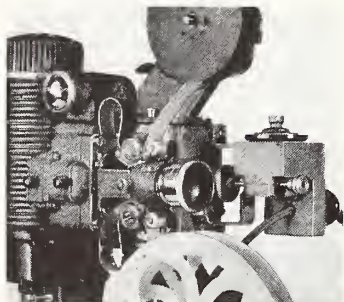

B & H 16mm. projector with syncro-sound unit.

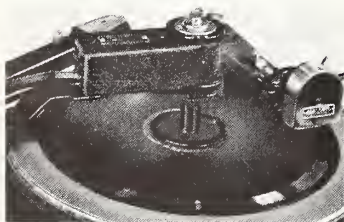

Presto recorder with syncro-sound unit.

PRESTO RECORDERS

make and reproduce high fidelity synchronized recordings. The model K (illustrated) makes records that play 5 minutes. The Presto model Y 16" recorder makes records that play 15 minutes continuously, sound for a complete 400' reel of 16mm. film.

WITH the new PRESTO SYNCRO-SOUND SYSTEM you can make 8mm. or 16mm. talking pictures of your family or friends singing, playing, acting dramatic sketches. You'll see and hear them on the screen, their voices synchronized perfectly with every lip motion.

You can bring your silent pictures to life with narrative comment, musical backgrounds, sound effects. Your sound will match each action on the screen with split-second accuracy.

The PRESTO SYNCRO-SOUND SYSTEM gives you theatre quality, synchronized sound on disc at 1-10th the cost of sound on film. It's simple to operate, no intricate adjustments, no fumbling with speed controls; the synchronization is completely automatic from start to finish. Ideal for home, industrial or educational movies.

To make and show talking pictures you need a Presto recorder and 3 SYNCRO-SOUND attachments, one for the recorder, one for your silent projector and the electric drive for your camera. To show silent pictures with post-recorded narrative you need only the projector attachment and the turntable attachment which can be used on any home phonograph or record player. Numerous photographic dealers and recording studios are being equipped to make synchronized records for you.

Write today for prices and our FREE BOOKLET entitled "How to Make Talking Pictures at Home."

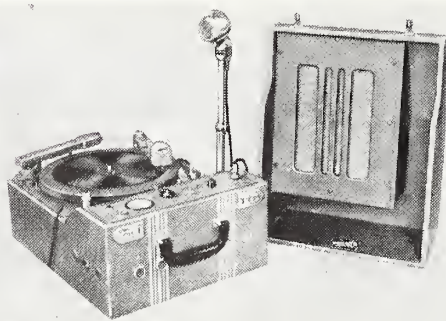

Presto Model K—*inexpensive—portable—easy-to-use.* Makes professional 6", 8", 10" or 12" phonograph records that you can play back instantly, on the same turntable.

PRESTO RECORDING CORPORATION
242 West 55th Street, New York, N. Y.

World's Largest Manufacturers of Instantaneous Sound Recording Equipment and Discs

Information PLEASE

Early Articles (J. K. Smithers, Boston Mass.)

Can you tell me in what past issues of HOME MOVIES articles have appeared on the subject of "trick effects"?

In the December issue each year, there appears an index to all articles which appeared in HOME MOVIES for the preceding eleven months plus the articles included in that issue. By referring to this index you may find the key that will enable you to locate any or all articles on any given subject in which you may be interested.

In this instance, the directory pages of this issue reveal that articles on trick effects may be found on pages 78, 168, and 177. Checking further, you will find that these articles appear in the February and April issues for 1940.

Train Shots (J. H. Brown, Chicago, Ill.)

In shooting from observation platform of a train, what is the best method to secure smooth shots?

If you have a tripod, use it. If not, some other solid support on which you may place your camera or hold it against. To hold the camera without some such support will result in pictures weaving or "jerking" on the screen as your body will naturally move with the sideway of the train. If your camera is equipped with multiple speeds, shoot from trains at the 24 or 32 frames per second speed. This will smooth out any motion due to movement of the train. This also applies to shooting from an automobile.

Lens Adapter (J. H. Spade, New York City, N. Y.)

When adapting 16mm lenses to my 8mm B & H camera what would be the effect on the focusing scale of the lens? Would it alter the stop readings?

The fact that the lens was originally made for a 16mm camera does not affect the

• READERS: This department is for your benefit. Send in your problems and our technical board of professional cameramen will answer your question in these columns. If an answer by mail is desired, enclose addressed stamped envelope.

focusing scale or the stop readings when adapted to an 8mm camera. Focus is always computed from the film plane to the nodal point of the lens (that point where the light beams cross between the lens elements—usually at the iris) regardless of the size of the film. It is obvious, therefore, that 8mm film would be just as far from the nodal point as 16mm film.

"Stops" are figured by dividing diameter of the lens into its focal length regardless of the size of the camera on which it is mounted. The 16mm lens, being larger in diameter covers a wider film area than does the 8mm camera lens and for this reason the 8mm camera lens could not be adapted satisfactorily to a 16mm camera. In other words, you can adapt lenses made for larger cameras—16mm, and 35mm—to the smaller 8mm cameras, but cannot make the 8mm camera lens work on the 16's or 35's.

Hardener (W. Beckwith, San Francisco, Calif.)

What hardener should I use in my home processing? Is ordinary Hypo o.k.?

Hypo serves two purposes in home processing—to remove the unexposed silver and to harden the film emulsion. Hardening solutions usually do little else but harden the emulsion. Thus you can see that a hardener isn't quite the same as Hypo.

Film Speeds (A. R. Gains, Philadelphia, Pa.)

Translating speed ratings into stops, what is the difference—or more definitely—how would you determine by the Weston rating when

• Continued on Page 625

Gifts
**THAT
 KEEP
 MEMORIES
 BRIGHT**



Revere

**8^M/_M CAMERAS and
 PROJECTORS**

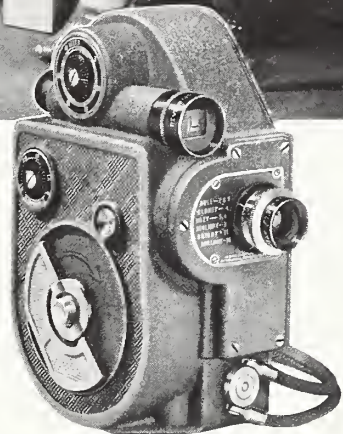

REVERE MODEL 88 CAMERA

Has 5 speeds, built-in parallax-corrected viewfinder, film footage counter, exclusive Revere Sprocket Film Control (to form loop in film automatically and prevent film jamming) and many other advanced features. With Wollensak 12.5mm, F3.5 lens in removable universal focus mounting. COMPLETE\$29.50
 With F2.5 lens COMPLETE\$39.50

**RECORD YOUR HAPPIEST MOMENTS
 IN BRILLIANT COLOR MOVIES**

No other gift can keep the memory of your Christmas so bright. With a Revere 8mm Camera you can capture, in brilliant color or beautiful black and white movies, all of the thrilling events of that happy season. With the powerful Revere 8mm Projector, you can show your movies with theatre-quality steadiness and enjoy again and again, fleeting expressions of your children, the gay coloring of decorations and other details that you might otherwise forget. Revere equipment is precision-built to insure perfect home movies. Modern manufacturing facilities and scientific production methods bring you these remarkable instruments at popular prices. See your dealer today and select your Revere outfit before the Christmas rush. Write for literature.

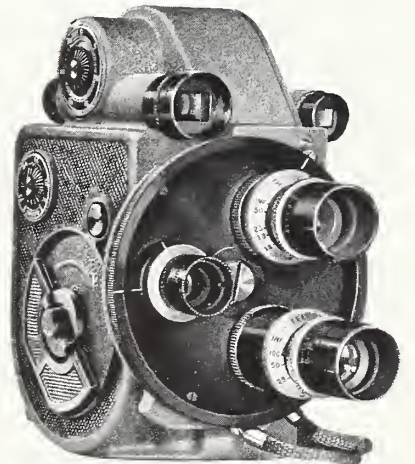

REVERE MODEL 99 TURRET CAMERA

Offers all the conveniences of the professional type cameras at a remarkably low price. Like the 88 it has Revere's exclusive Sprocket Film control and is easy to load and to use. With two optical viewfinders and one Wollensak 12.5mm, F2.5 lens. COMPLETE\$65.00

Revere Double 8 Cameras are Licensed under Eastman Spool and Spindle Patents.

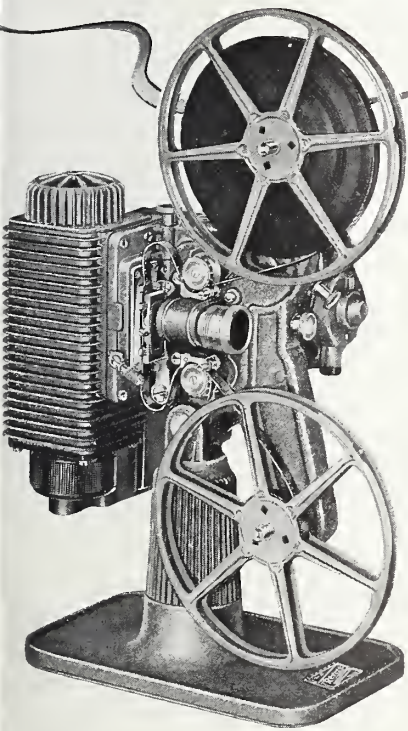

REVERE MODEL 80 SERIES B PROJECTOR
 Has everything—500 watt lamp, F1.6 lens; duplex shuttle film movement 10½ to 1 ratio; double blower cooling system for lamp and film, automatic "quick-action" safety shutter; enclosed rewind mechanism, etc. COMPLETE only\$59.50

REVERE CAMERA COMPANY • CHICAGO
 PHILADELPHIA • KANSAS CITY • MINNEAPOLIS • LOS ANGELES • DALLAS

REVERE CAMERA COMPANY,
 Dept. 12HM, 328 East 21st Street, Chicago, Ill.
 Send complete facts on Revere 8mm Cameras and Projectors.

NAME.....
 ADDRESS.....
 CITY..... STATE.....

*For Canadian prices, write to Ryerson Film Service,
 299 Queen St., West, Toronto*

Announcing...

**THE NEW, INEXPENSIVE
EXPOSURE METER FOR MOVIE MAKERS**

Just in time for gift giving! A compact, extremely simple exposure meter that will enable the ciné fan to get every frame exposed with "on-the-dot" accuracy... every time! It is quickly pre-set for the type of camera, emulsion speed and frames-per-second... and can be left that way unless a different camera speed or film speed is used. Thus it is virtually instantaneous in use... with no adjustments or calculations to make while shooting. Priced at only \$15.50. And it's WESTON built... assuring dependability and long life. See it at dealers today, or write for literature. Weston Electrical Instrument Corporation, 585 Frelinghuysen Avenue, Newark, New Jersey.



**THE
WESTON
JUNIOR CINÉ
Exposure Meter**

For Christmas Filming
USE VICTOR
Fotoflood Lighting Equipment

No. 250 — \$2.65
for No. 2 Floodlamps

CLAMP these excellent reflectors to any convenient support and you're ready to film Christmas events in your home—in black and white or color. No. 250 has an 11-inch parabolic reflector spun from substantial gauge aluminum. It has a fine oxide interior, polished exterior, heat proof push-tip socket switch and 10-ft. rubber cord and plug. No. 300 has a more effective 12-inch reflector, detachable from hood by less than a turn, 15-ft. heavily insulated rubber cord and easy acting feed-thru switch. Both are most highly recommended by professional and amateur movie makers. They make most excellent gifts, too! See your dealer or mail the coupon, at once.

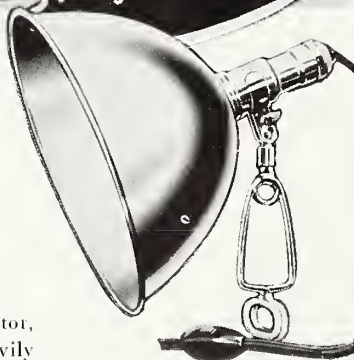

No. 300 — \$3.95
Detachable Neck Model
Reflectors nest compactly for storage or carrying. This reflector is also available on stand units: Nos. 310, 320.



**And DON'T FORGET
The Sunreflector**

Replaces cumbersome reflecting panels indoors as well as out when filming single figures. It's a 9-inch convex mirror supported in a swivel mount. Also available with stand mounting. If desired. Price \$4.75

MAIL THE COUPON

JAMES H. SMITH & SONS CORP.
1200 Lake Street, Griffith, Indiana.
Rush your 66th Year Folder describing your complete line of lighting equipment for indoor movies.

Name.....
Address.....
City.....
State.....

With **ADVANCED**
Cinefilmmers...

"Glendale on Parade," a 16mm motion picture in sound and color which depicts the industrial, cultural and civic assets of Glendale, California, has just been completed by Harold C. Jewel. The film, originally begun, as an ordinary home movie effort, proved so interesting to the Exchange Club of that city, they got behind it financially, enabling Jewel to extend it to 1600 feet and add sound narrative. A copy of the film has been placed in the hands of Glendale's Chamber of Commerce for distribution to schools and civic organizations.



Elmer F. Way, of Grand Rapids, Michigan, recently completed a traffic safety film in 16mm for the Grand Rapids Safety Council. Intended to promote pedestrian safety as well as more cautious driving on the part of motorists, the film will be made available to schools, civic, church and P.-T.A. groups. Officers from the ranks of Grand Rapids' police department served as actors. The film will run from 30 to 45 minutes.

miere showing recently before an impressive gathering of notables and educators. The film, originally 8900 feet of Kodachrome in length was filmed in sound with the aid of the latest C. H. Skinner 16mm recorder. Half of the sum for production of the picture was supplied by the Sisters themselves, and the balance was donated by a Cincinnati philanthropist. Although originally intended for showings only at Notre Dame institutions, it is rumored that a California distributor is interested in releasing the picture.

"Beautiful American Gardens" and "Charm Spots of Our Exotic South" are the titles of two films recently completed by Wm. H. Harrison Clauser, member of the teaching staff of Dale Carnegie Institute. The films, all color, are used in conjunction with Mr. Clauser's lectures and are so edited they can form a complete subject in screening time varying between 40 and 90 minutes. This required careful editing and titling so that screening of either subject may be concluded with any reel, depending upon the time allotted for each lecture.

The Professional 16mm camera for use in Hollywood's motion picture studios was recently tested by Metro-Goldwyn-Mayer and Paramount studios. Reports are that the camera not only incorporates all of the features of present-day 35mm studio cameras, but several other improvements which make for easier operation. For example, the camera housing shifts on a ball-bearing base from lining-up position to taking position and vice versa. Ultra magnification of the scene in the camera viewfinder is said to be an advance over 35mm apparatus. Should this camera ultimately prove 100 per cent successful, we may expect to see more and more movies filmed directly on 16mm film for theatrical release. Biggest field at present is for slot-machine movies.

Produced by the Sisters of Notre Dame de Namur, famed religious order of Cincinnati, Ohio, and with the assistance of Ralph Haile, "A Century in America," running 3841 feet in Kodachrome had its pre-

The Daily Variety, newspaper of the show world, in its November 14th edition announced successful experiments had been com-

• Continued on Page 625

WHY YOU GET Superior Performance

AMPRO "8"
Precision Cine Equipment

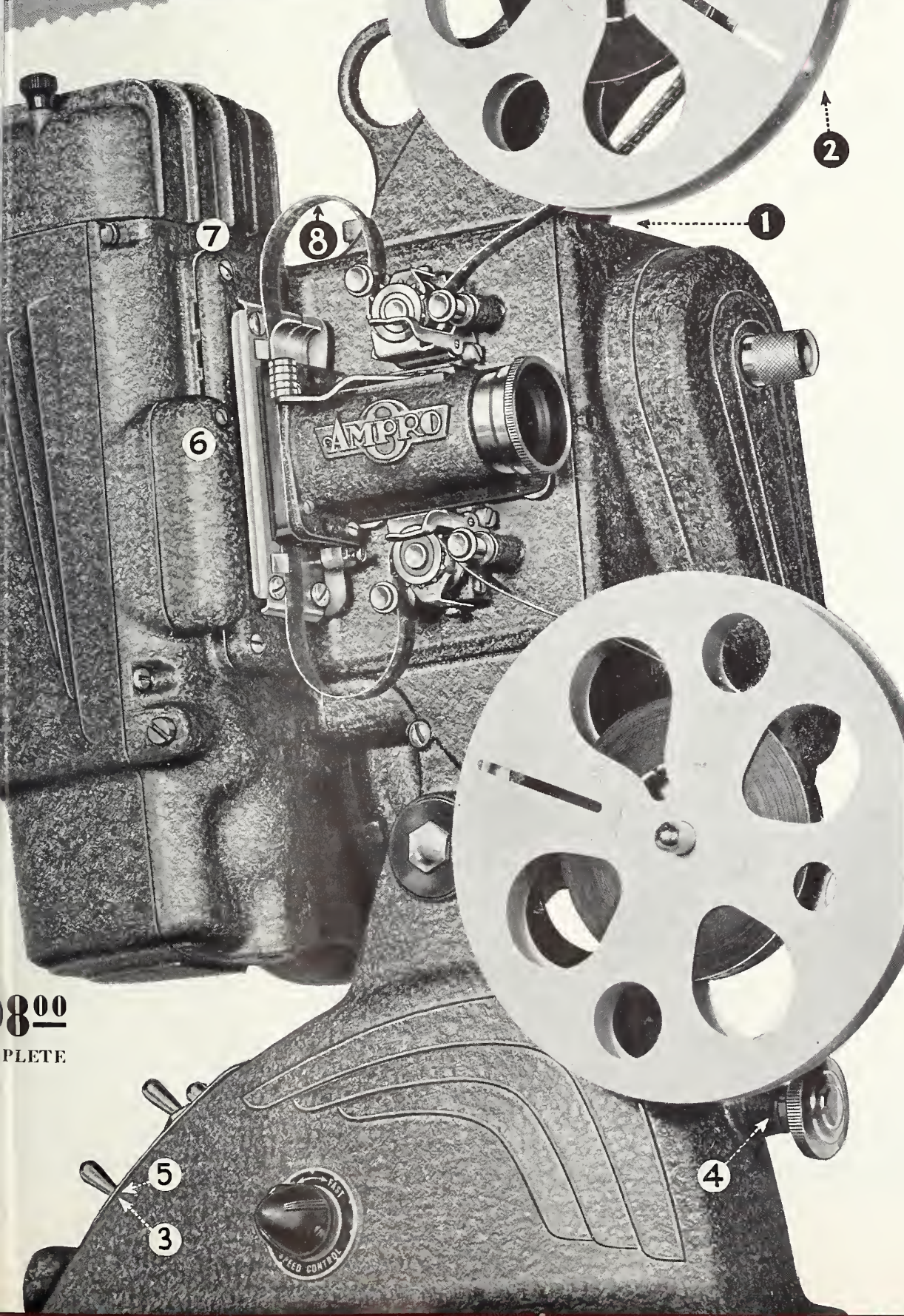

FROM THIS NEW 8mm. PROJECTOR

Here are a few of the reasons why this new Ampro "8" gives you full 16mm. quality projection—why it enables you, at last, to show your 8mm. pictures under ideal conditions.

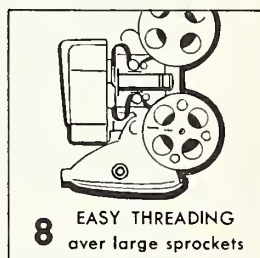
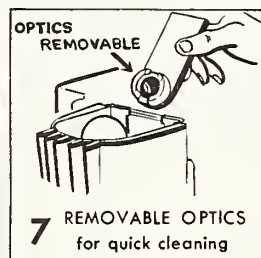
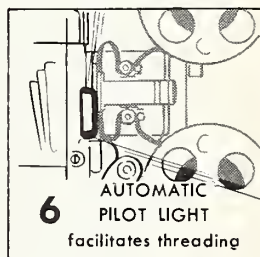
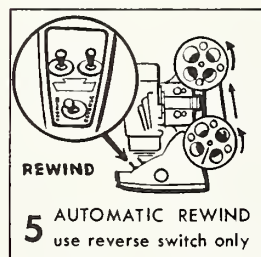
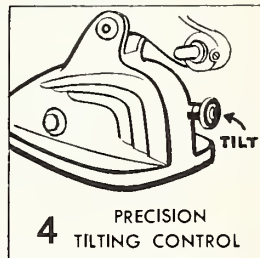
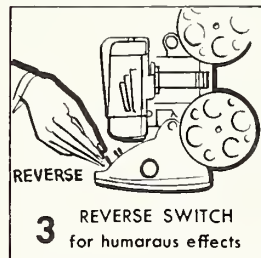
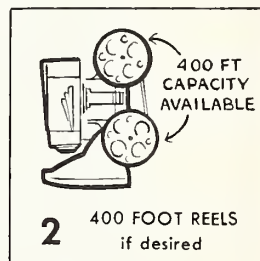
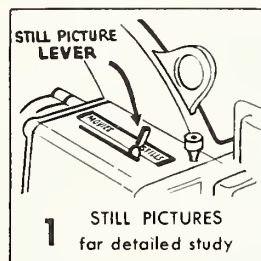

SEND FOR CATALOG

giving all the features and specifications of this new Ampro "8"—and full information on the complete Ampro line of 16mm. silent and sound-on-film projectors. Ampro projectors are standard equipment in many thousands of schools, universities, government departments, U. S. Army and Navy, churches, clubs and homes.

Ampro Corp., 2839 N. Western Ave., Chicago, Ill.

Ampro Corp., 2839 N. Western Ave., Chicago, Ill.
 Please send me full details on the new 8mm Ampro Projector. Also the complete Ampro 1940 Catalog of 16mm Projectors.

Name

Address

City State

HM-1240

AMPRO

800
COMPLETE

FOR BETTER MOVIES AND CHRISTMAS GIVING!



BROWN TITLE MAKER The precise, all-metal titler that makes possible effects of the professional screen. Quick and certain alignment of camera lens with easel assures properly centered titles. Includes opal glass, clear glass and cork backgrounds, 9" x 12" . . . two reflectors with adjustable brackets . . . 12-ft. extension cord . . . vertical pivot bearing . . . target sight and auxiliary lens holder . . . field chart for lens . . . and full instructions. . . . **\$27.50**

BOOL CINE FADER
Now you can make fades and lap dissolves as you go—with the handy Bool Cine Fader. 64 different and pleasing effects. Will also work as fader over the lens of any projector. . . . **\$17.50**

Cinea 30 "Master" TITLE KIT
222 characters, including upper and lower case. Plain back . . . or, if desired, pin back on special order. Packed in partitioned box with exclusive templet composing gauge and instructions. . . . **\$12.50**
SPLICER
For 8mm and 16mm sound and silent films. Makes better splices with less effort and considerably more speed. All steel, precise construction. . . . **\$10.00**
Ask your dealer, or order direct!

AMERICAN BOLEX COMPANY, Inc. • 155 EAST 44th STREET, NEW YORK CITY

**IN A CAR IT'S THE MOTOR
IN THE CAMERA IT'S THE LENS
IN PROJECTION IT'S THE SCREEN**

Write for your FREE 5" x 7" SAMPLE of this amazing screen fabric and test chart. Test it in your own home as a projection engineer would. We challenge any other screen to give you the projection qualities of the BRITELITE TRUVISION Wide Angle Crystal Beaded Screen Fabric. This unique surface spreads and reflects light in a perfect fan shaped area. It provides better overall definition—NO GLARE—NO DISTORTION—NO HALATION. The BRITELITE Wide Angle Beaded Fabric is your best buy for black and white or color.

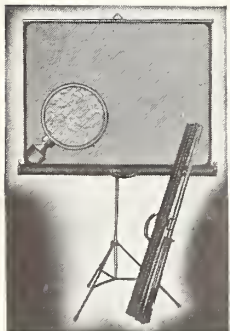

TRIPOD SCREEN
30 x 40 — \$15.00
Other sizes \$18.50 to \$35

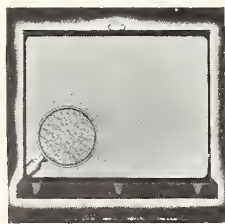

NU-MATIC SCREEN
30 x 40 — \$17.50
Other sizes \$19.75 to \$28.50

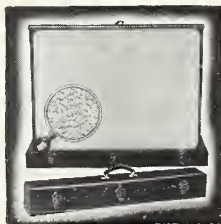

DeLUXE A MODEL
30 x 40 — \$15.00
Other sizes \$13.00 to \$57.50

See the Britelite Line of Screens, Reflectors, Spotlights, Utility Cases, etc., at your dealer, or write for Catalog and Test Package.



MOTION PICTURE SCREEN & ACCESSORIES CO., Inc.
351 West 52nd Street, New York City

• TITLE TROUBLES •

By GEORGE W. CUSHMAN

IF YOU have any questions concerning titles or title making, Mr. Cushman will be glad to help you. You can address him in care of this magazine or direct to his home address, 3425 Witmer Parkway, Des Moines, Iowa. Include all the information you can, such as type of film used, illumination, developer, etc. Don't forget to enclose a self-addressed, stamped envelope for your reply.

minutes, the blacks aren't blacks, while more than this time gives me whites that are gray. Your suggestions will be appreciated.—G. L., San Diego, Calif.

Q. In making backgrounds for titles, which gives the better results in general, a dark subject properly exposed and developed or an ordinary subject under-exposed and printed dark?—U. V. DeV., Pensacola, Fla.

A. With the information you have furnished, there are three conditions which may cause this trouble. First, does the title itself have sufficient contrast? Is the background clear white and the letters a jet black? Second, are you using a good contrast developer and for the right length of time? And third, it is very possible that you are over-exposing the title. My suggestions are that you make sure the title has good contrast and that you are using your contrast developer for the maximum length of time. When this is done, you can determine the correct exposure to give you the desired results with this procedure.

A. This would depend on the subject, and unless a specific instance were offered, it would be hard to say. Even the dark subject, if properly photographed, would no doubt have some white in it somewhere which might detract from the contrast between letters and background. An ordinary scene printed dark would, it seems to this writer, make a better background, since backgrounds in general should be dark, massive, symbolic, and lacking in contrast.

Q. Why is it that so many articles give the correct developing times for developers, correct temperature, etc., but seldom if ever do they give an accurate exposure. With one film and one developer, wouldn't the exposure always be the same?—C. F., North Tona-wanda, N. Y.

Q. Is a movie printer used to print titles?—Chicago, Ill.

A. This could lead most quickly to a technical argument as to what is exposure, but suffice it to say that for this question exposure is taken to mean a given amount of light necessary to reach the film in proportion to the developer to be used in developing it. In this case the exposure would always be the same, but as always we would have to vary the stop opening to correspond with the illumination. If all amateurs used the same light intensity, the correct lens opening could always be given, but since no two workers use the same amount of light, how can the lens opening ever be given? It is too bad that the amount of photographic

A. No, a movie printer does not print words or letters of any kind. A movie printer is a machine designed to take two films—the negative and the positive—and print the negative image on the positive film while the two are running through the machine together at the same time. Although called a printer, it prints on the positive film only what is on the negative. Titles are made only by photographing closeups of printed cards.

Q. I can't seem to get sufficient contrast in my titles. If I develop less than two

• Continued on Page 624

America's Outstanding Titler!

ON EVERY MOVIE MAKERS' "WANT LIST"

Cine Master TITLEER

★★ A Four Star Product ★★

It has everything!

NOTE THESE FEATURES

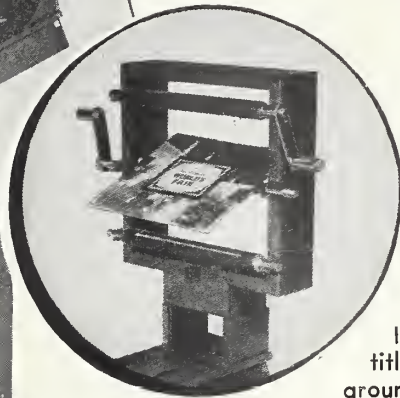

A larger "field area" is created by photographing titles at a 12" distance. This larger area allows more room for hand lettering, printing, drawing and special effects. Title cards may also be photographed at 4", 6" and 8" in addition to the 12" distance. ★★★★★ Zoom titles and superimposed titles are easily made on the Titleer. ★★★★★ Title backgrounds and animation sets appearing each month in Home Movies are readily accommodated. ★★★★★ Accurate alignment is assured with a custom made camera base for your particular camera, eliminating all fuss and bother in lining up titles. Bases for all popular cameras are interchangeable on the Titleer. ★★★★★ All parts are adjustable on the Titleer base, making it ideal for table top copy work and ultra close-up photography. ★★★★★ Titleer may be used on any tripod or suspended in a vertical position. ★★★★★ The lighting assembly is easily removed or placed at any position on the Titleer base. Custom camera bases to fit Revere 8, Eastman Magazine 8, Bell & Howell, Keystone, and all other popular cameras.

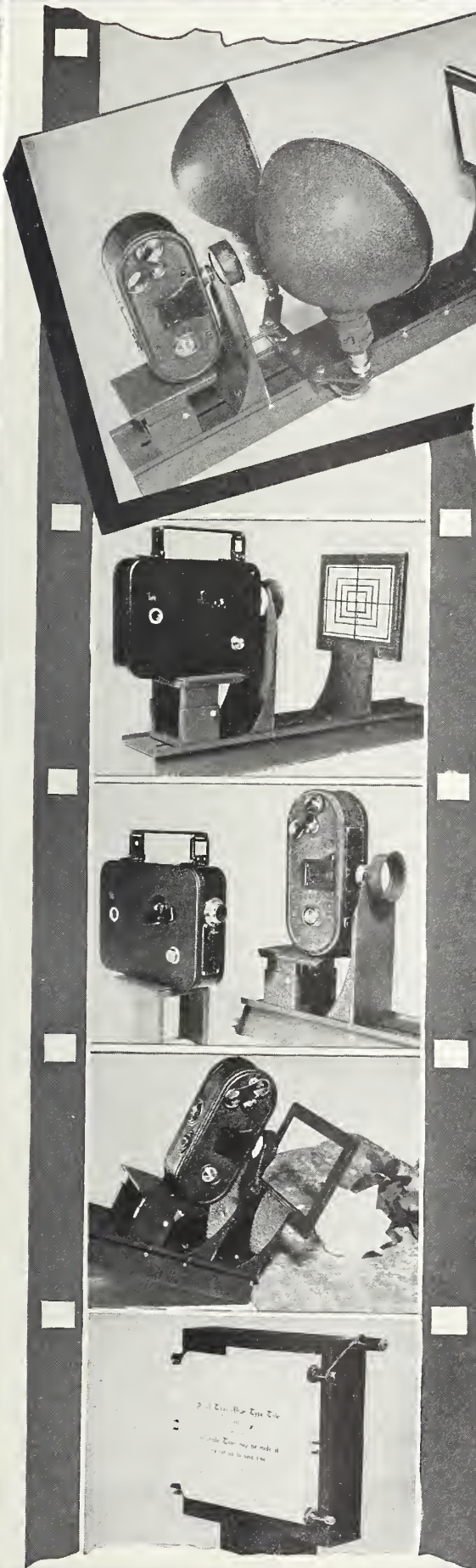

\$6⁹⁵

LESS LIGHTS

\$9⁹⁵

WITH LIGHTS

Complete with two auxiliary lenses, celluloid target, instructions and valuable titling data.

And Now A New Accessory! TITLEER PROFESSIONAL ATTACHMENT

With this new attachment it is possible to make Turnover, Turnabout, Turn-around, Flop Up and Flop Down, Revolving, Horizontal and Vertical Scroll and Rolling Titles. Superimposed, Pushout or Wipe Off Effect Titles, Zoom combinations and many other professional titles. The Professional Attachment is instantly attached to the Cine Master Titleer.

PROFESSIONAL ATTACHMENT \$3⁹⁵

TITLEER ACCESSORY KIT No. 1

Includes an 8" auxiliary lens, set of 25 Titles and Backgrounds, a translucent screen for rear projection shots and two sheets of clear celluloid for superimposed titles.
Complete Kit..... \$1⁹⁵

At Your Dealer or Write to

HOLLYWOOD CINE PRODUCTS CO. 3221 SO. FIGUEROA ST. LOS ANGELES, CALIF.



Bathing Beauty

CONSIDERING the poor light, they never expected to capture her smile but . . .

. . . they used *Agfa 16 mm. Triple S Pan Reversible!* The extreme speed of this fully panchromatic film makes it your best choice for indoor movies or for slow-motion work under poor light conditions. Wide latitude, fine-grain size and a gradation that is balanced for brilliant results under either natural or artificial light are

your additional assurances of fine pictures.

And, thanks to the highly effective Agfa anti-halation coating, your projected pictures retain all the sharpness of detail recorded on the film.

Ask your dealer for *Agfa 16 mm. Triple S Pan Reversible Film* today. It comes in 100-foot rolls (at \$6.00) and 50-foot rolls (at \$3.25). These prices include processing and return postage. **Agfa Ansco, Binghamton, New York.**

Agfa

**16 mm. TRIPLE S PAN
FILM**

MADE IN U.S.A.



HOME MOVIES

Published in Hollywood
DECEMBER 1940



Some new ideas for CHRISTMAS filming . . .

By R. E. WORSTEL

THIS is a subject for the more venturesome home movie enthusiasts.

There is probably more footage of film shot between the hours of six and nine on Christmas morning than in any other three-hour period. Sentiment and uninhibited action make Christmas photography the highlight of the year.

In recent years the custom of decorating the exterior of the home has come into widespread popularity. Should not this, too, offer possibilities for the amateur cinematographer? Are the difficulties insurmountable? Let's take a look!!

In its routine manner the sun sets every day and this suggests one solution to the problem — twilight photography. Christmas decorative lighting

as a general rule cannot be depended upon to provide much illumination except for objects in the immediate vicinity. What we are interested in getting is a faint outline of the house and its main architectural features. Structural details are unimportant and detract from the decorative theme. Briefly, what is required then is an underexposed view of the house silhouetted against the slightly lighter tone of the sky. (See Fig. 1.)

At exactly what time during the twilight period the shots should be made is a matter of judgment. An exposure meter should help in this regard. However, be sure to take readings with the decorative lighting off. The average Christmas tree string of bulbs will show up quite clearly at F/3.5, normal speed, with fast pan, film having a Weston speed of 80 for tungsten. Naturally, one-half speed

• Continued on Page 622

• Exterior Christmas decorations of gaily festooned lights may be filmed in evening twilight with fast black and white film and an f/3.5 lens.





Courtesy Castle Films

behind the 8-ball on Christmas day. So play it up big!

Main title: "Our Christmas — 1940."

Scene 1: Medium long shot. Interior of kitchen. Dad entering kitchen from back door. Carries Christmas trees and several packages containing toys and gifts.

Scene 2: Medium closeup of wife taking pan of cookies from oven. Looks up at father as he enters. Puts finger to lips for him to enter quietly.

Scene 3: Back to scene 1. Dad spies cookies. Moves to snatch a couple and in so doing, brushes pan of uncooked cranberries from stove with Christmas tree. Looks toward wife with humble look.

Scene 4: Closeup of wife as she looks first at cranberries and then towards Dad with expression of exasperation.

Scene 5: Medium closeup of children's feet running toward kitchen.

Scene 6: Medium closeup of Dad (same position as in scene 3.) as he hears children's approach. Looks about room excitedly. Opens broom closet and thrusts packages inside, closing door quickly just as children enter room.

Scene 7: Door at opposite end of kitchen. Children enter. Register joy and surprise at sight of tree. Look down at cranberries on floor. Then run to father and take tree from him. Fade-out.

Scene 8: Fade-in. Medium long shot. Interior of living room. Tree in background partly decorated. Dad on chair arranging ornament at top of tree. Mother is distributing ornaments among

Mother, dad and the children star in

By J. H. SCHOEN

this CHRISTMAS scenario!

CHRISTMAS is the Nation's home movie making day. Probably more movies will be filmed this Christmas than on any day of the ensuing year. Cameras will be clicking in the early hours of Christmas morning, recording the joy of youngsters — and oldsters, too — as they discover their gifts beneath gaily decorated trees. And filming will continue throughout the day until the last of the holiday's festivities are ended.

But this year, Christmas movies are going to be more than just a lot of exposed footage, judging from the many requests for holiday filming ideas. Much sought are complete Christmas continuities with a punch and a laugh or two that encompass the whole family —

stories that will make such pictures interesting screen fare long after this Christmas is forgotten.

Just such a home movie script is "Our Christmas — 1940." From the pen of LaNelle Fosholdt, official scripter for the Long Beach Cinema Club, this story is tailor-made for the average family — Pa, Ma, and two or three youngsters. The plot is flexible enough so that Grandma, Uncle, or other Yule guests may be included in the cast.

To inject the maximum comedy into the picture, emphasis must be placed upon Dad's penchant for eating — nibbling at apples, popcorn, and the candy canes hanging on the Christmas tree. It is this over-indulgence that puts Dad

children who are assisting in dressing tree.

Scene 9: Semi-closeup of Mother handing small son an ornament. He registers pleasure, and is about to place it on branch of tree when Dad's hand enters into scene and takes ornament from him. Boy registers disappointment.

Scene 10: Medium shot of Dad, son and Mother before Christmas tree, a. Dad takes ornament from son and places it on tree. As he steps back to admire his handiwork, he nonchalantly plucks a candy cane from the tree and takes a generous bite.

Scene 11: Semi-closeup of Mother handing an ornament to another child who likewise starts to hang it on tree

Dad's hand enters scene and takes ornament, as child registers disgust.

Scene 12: Medium shot of Dad as he takes ornament from child and officiously explains to it that it looks better here he placed it. As he stops to admire tree, he dips into a bowl of popcorn on a nearby table, takes up a generous handful and stuffs it into his mouth. Turns to child as though asking child's approval for his decorative prowess.

Scene 13: Closeup of child, scowling and pouting. Turns away in disgust and starts to exit from scene.

Scene 14: Medium shot of all the children sitting dejectedly across the room and watching Dad spoil their fun — trimming the Christmas tree.

Scene 15: Medium shot. Dad ascending ladder with tree light in hand. Starts to screw it into socket. (Here according to your wishes, you can have a flash occur, indicating a short circuit; or pretend the globe burst in Dad's hands, hitting him severely.) Dad moves with

sudden jolt, indicating he's been injured. Places injured finger in mouth, etc. Mother enters scene to inspect injury, and urges him to come down from ladder for first aid treatment.

Scene 16: Back to scene 14. As children watch Dad descend from ladder, smiles appear on their faces as they glance knowingly at each other.

Scene 17: Medium shot. Dad and Mother exiting through room door.

Scene 18: Back to scene 16 as children get to feet and rush over to tree.

Scene 19: Medium long shot of children excitedly trimming tree in parents' absence.

Scene 20: Closeup of one of children as he fumbles an ornament and it drops from his hands to the floor.

Scene 21: Flash closeup of ornament as it strikes floor and breaks.

Scene 22: Back to scene 20. Horrified expression of child who dropped ornament.

Scene 23: Back to scene 17. Dad and Mother re-enter room. Dad is holding injured finger bandaged in exaggerated manner. Dad stops wild-eyed as he looks toward broken ornament on floor.

Scene 24: Closeup of broken ornament on floor (Same as scene 21).

Scene 25: Back to scene 23. Dad looks around at children with scowl, then speaks:

TITLE: "You should have waited for me! Now get a broom and sweep it right up!"

Scene 26: Medium closeup of children as they hear father's words. They move toward door to fetch broom as ordered.

Scene 27: Back to scene 25. Dad

• *Continued on Page 608*

• Below are all of the titles for this Christmas scenario — printed and ready to shoot, except the "End" title which may be found on the page of title backgrounds elsewhere in this issue. They're made to fit your typewriter titler and may be filmed with either positive or reversal film. For Kodachrome, cover the titles with colored cellophane.



"You should have waited for me! Now get a broom and sweep it up!"

". . . and please, God, don't let Daddy break my toys."

"Let's put Mother's and Dad's presents under the tree!"

"I only want to see if all the parts are here."

"I'm just checking to make sure everything's running all right . . ."

"Oh, yeah?"

"Here, Dad — this is your present."

"Gee — Christmas sure is hard on Daddy!"



How I filmed my **PRIZE** **WINNING** picture . . .

By J. ALLYN THATCHER, D.D.S.

WHEN Hollywood makes a "hit" picture, credit for its success is usually claimed wholly and not in part by the producer; the writer; the director; the star; or the publicity department. Sometimes all five dispute the honor. In the case of "Christmas Well Spent," there was no writer, director, nor publicity man to consider, and the "stars" of the picture are as yet too young to offer me — their father — an argument. Still, I'm not laying claim to any special honors for making this picture which HOME MOVIES' Editors awarded First Place in the Family Films Class of their 1940 Annual Amateur Contest.

Rather I believe that "Christmas Well Spent" is one of those movies such as many of us make after the mistakes of previous filmings are well behind us and the lessons learned in preceding cinefilming well assimilated. Eventually, if a fellow keeps trying, he's going to ring the bell. I'm really pleased with the honor accorded my picture.

Since becoming interested in amateur cinematography, I have filmed a picture each Christmas involving our two youngsters. Thus I have built up a library of pictures of the children showing their development from year to year — pictures that are not just random shots of the kiddies, but complete with some semblance of a plot. And I have found that it paid to do this for these pictures are always welcome screen fare to friends or members of the family no matter how frequently seen.

• Dr. Thatcher, with his home-made sunshade and mat box equipped Bolex "8," filmed "Christmas Well Spent" which captured First Award in Home Movies' 1940 Annual Amateur Contest and proved that movies of children can be something more than cine snapshots.

When this series of pictures was started, the children were quite young and the stories naturally centered around the subject of Santa Claus. But as they grew older and learned there wasn't a real Santa Claus, the scripts became more difficult to write. As a natural consequence, 1940 found them concerned with obtaining the necessary funds to finance their personal Christmas shopping for other members of the family and this furnished the theme for last year's Christmas picture.

After carefully reviewing the finished script, it was decided advantageous to shoot most of the exterior scenes prior to Christmas in order to take advantage of the good weather then prevailing. Briefly, the story concerned a small brother and his sister planning to buy gifts for their father and mother. At the beginning of the story we see them prying open their toy bank only to find the savings much less than anticipated.

Undaunted, brother and sister set out to earn additional money. They cut lawns, rake leaves, etc., (they could do this at Christmas time, living in California, you know!) until their supply of cash appeared sufficiently ample, and then they set out shopping — to the jewelers for a necklace for mother and to the photographic store in quest of a camera for dad. Of course they find these things far above their means and ultimately they complete their gift buying in the local five and ten cent store.

The closing scenes show them putting elaborate wrapping and decorations about their dime-store purchases and then presenting them to Dad and Mother Christmas morning. As may be seen, the plot is quite simple. It called for no extraordinary acting — just the plain natural action of a couple of enthusiastic kids at Christmas time.

THERE are a few highlights that may prove interesting from a technical standpoint. Three tracking or "dolly" shots were used in the picture. Two of these were made from a camera support constructed and attached to the lawnmower. It was a simple three legged affair that enabled placing the camera in a low position, five feet out in front of the lawnmower. This permitted shooting a tracking closeup of the boy pushing the mower, showing only the head and shoulders plus a close-up of the whirring mower blades. The other tracking shot was made from a tripod dolly which preceded the youngsters entering the door of the store and followed them right up to the merchandise counter inside.

A montage effect was used to show quickly, the numerous chores done by the children to earn extra money. It consisted of a series of slightly overlapped iris dissolves with a double-exposed

• Continued on Page 621

CHRISTMAS CAROL

An excellent study in composition and lighting that suggests a thematic scene for Christmas movies. Use this picture as a title background.

Photo By

Ralph F. Morgan



BUILD YOUR

It's surprising what one can do with hammer and saw and materials to be had from the dime store . . . !

AMONG his intimates, Demetris Emanuel is regarded the nation's Number One Cinebug. Doubtless there will be others to challenge this acclamation, as time goes on, and as Emanuel's accomplishments become better known. But until then, certainly Emanuel's record as an all-around movie amateur justifies the appellation.

In the parlance of amateur movie makers a "cinebug" is an amateur whose activities in movies extend beyond the filming of pictures. A cinebug builds things to make his movie hobby easier, more pleasant, and interesting. He designs and builds gadgets for filming, editing, titling, or processing home movies that are not always available in photographic stores. He gets a far greater kick out of building it himself—frequently a greater kick than from shooting his movies.

In this instance, however, Emanuel makes right good movies, too. His 16mm picture, "El Lobo," was the Movie of the Month for April, 1940. It was while watching him shoot scenes for his latest production, "On The Spot," that we became intrigued with the gadgets that led to discovery of his cinebugging accomplishments. Emanuel doesn't do things by halves. When he needs a light, or a reflector, or some other accessory, he builds it himself. When he needs an interior setting that cannot be shot within his own home, he builds the desired set in his garage!

The photos on this page illustrate a few of the cinefilming accessories constructed entirely by Emanuel. On the opposite page are sketches showing construction details of some of these gadgets for the benefit of those cinebugs who'd like to try their hand at making them.

The first photo shows the camera dolly and track which Emanuel built for dolly shots—moving the camera toward or away from the subject while shooting. Dolly shots are very effective in scenarized movies, are used frequently in theatrical pictures, yet unless a filmer has the right equipment for such filming, his attempts prove mediocre. The frame of this camera dolly was constructed of half-inch galvanized pipe. The joints were welded. Rubber-tired wheels obtained from a toy repair shop were used. The smaller

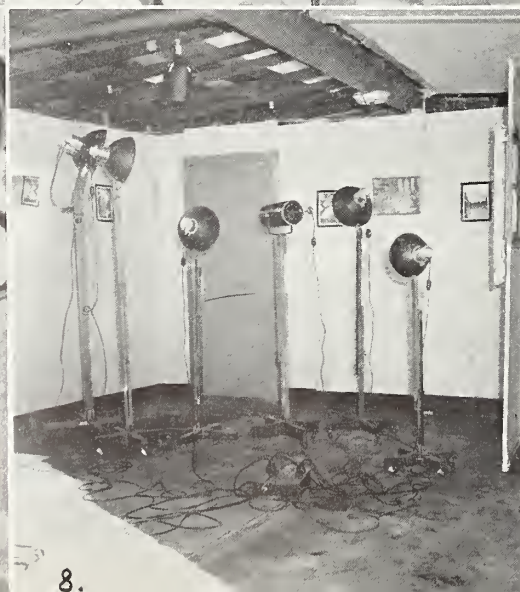
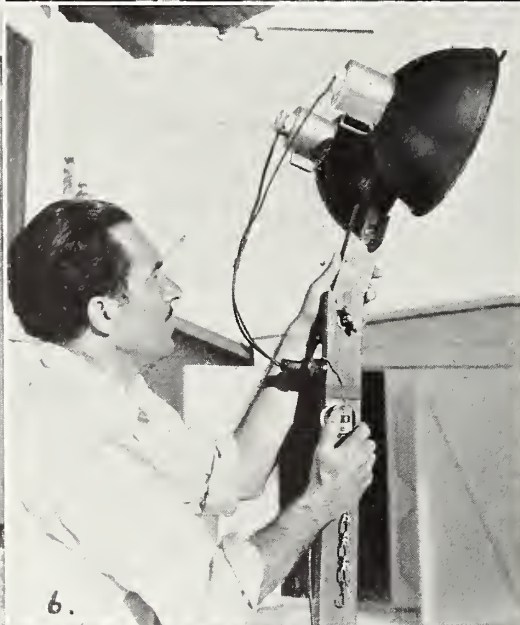
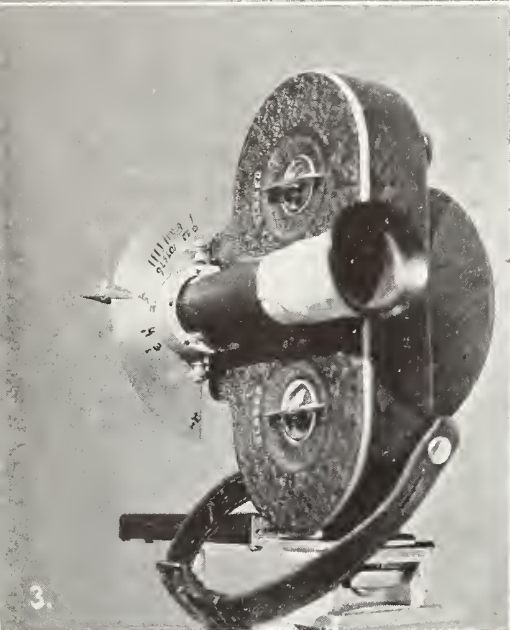
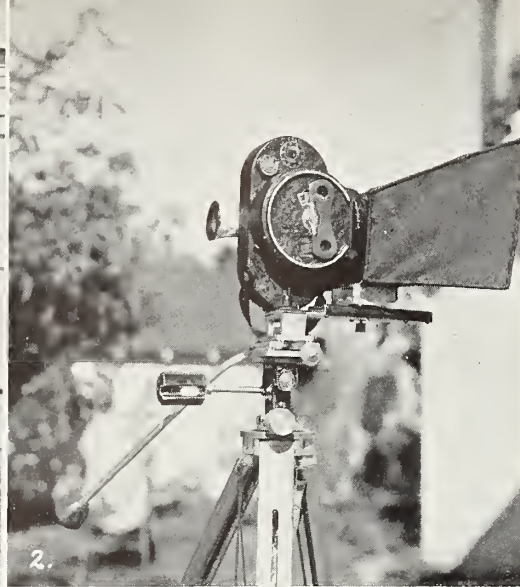

Authored by
CURTIS RANDALL

UN equipment as this cinebug did . . . !

ear wheels may be adjusted to rotate like castors when required.

The wooden track was constructed from two lengths of two-by-fours. One-by-two-inch battens nailed on one surface form a track for the dolly wheels to follow. Track and dolly are small enough so they may be carried in the trunk compartment of Emanuel's car.

Photo No. 2 is a closeup of the camera on the tripod in picture No. 1. This shows the sunshade Emanuel made for his Filmo 70-DA and which is not unlike the design of some sunshades used on 5mm studio cameras. The group of sketches indicated at "Fig. 5" give an idea of the construction of this sunshade and also of the adjustable mounting which holds it to the tripod head.

First, a wire frame was made and welded together. This was covered with heavy muslin and sewed to the wire frame in the same manner as fabric is attached to a lampshade. The muslin was then coated with black paint inside and out.

At the base of the framework is the movable section of the slide "A". This fits the support "B" by means of a track constructed of ready-made aluminum moulding, a cross-section of which is indicated at "C". This moulding is obtainable from almost any heavy hardware store dealing in metals, and Emanuel found in it the basis for some of his most valuable gadgets.

THE cross-section diagrams of members "A" and "B" show how this moulding was attached to form the track for the sunshade that permits sliding it forward from the camera when adjustment of lens is necessary. The whole assembly is held in place upon the tripod by means of member "B", one end of which fits over the tripod screw and between the camera base and tripod head.

In order to make successful dolly shots with the camera-dolly and track previously mentioned,

• Continued on Page 615

• Photos on opposite page show some of the gadgets and accessories built by Demetris Emanuel, of Los Angeles, for his movie filming. Sketches below show details of construction.

STOVE-PIPE SPOTLIGHT

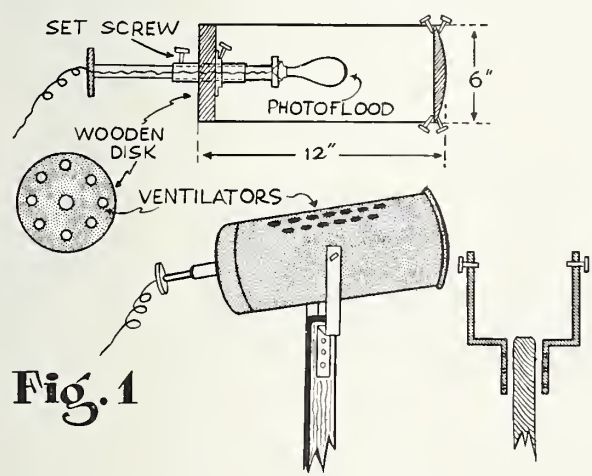

Fig. 1

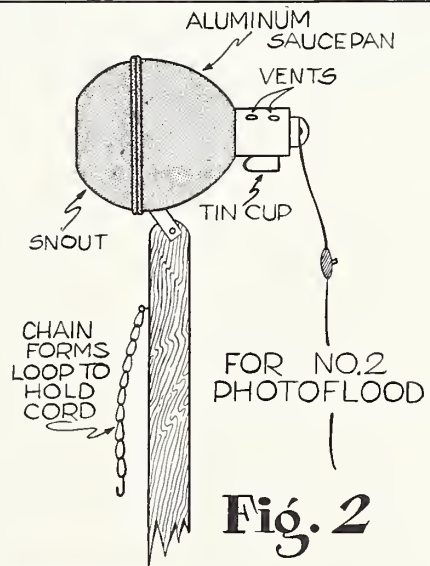

Fig. 2

DETAIL OF LAMP STAND

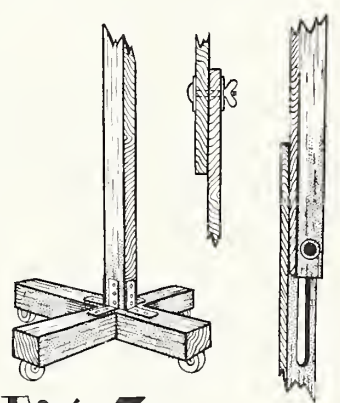

Fig. 3

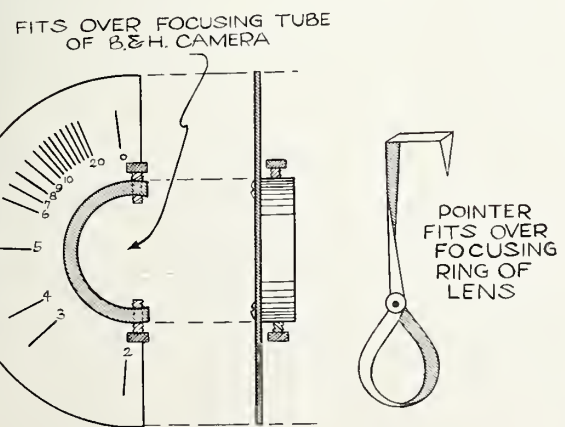

Fig. 4

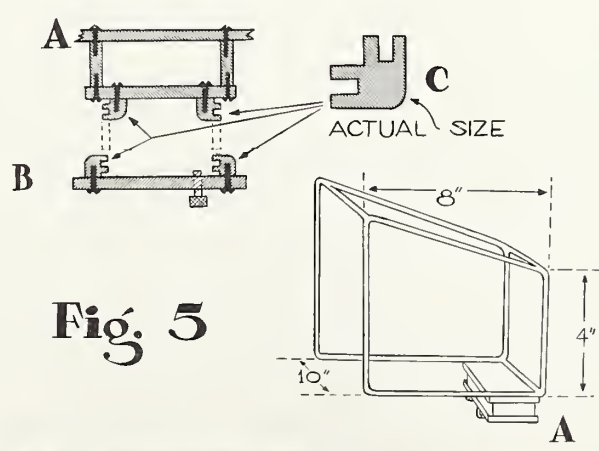

Fig. 5

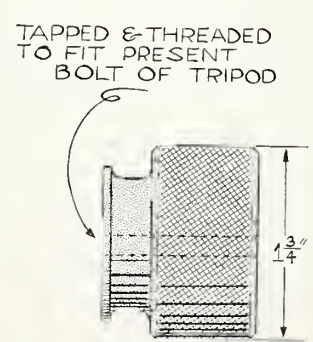

Fig. 6

72.

Authored by
JACK IRWIN



lenses as well as a sunshade for the regular camera lens.

Thus Soucy has combined a well designed lens turret with the recently developed discovery among amateurs that sport binoculars may be coupled with a camera lens to convert it to a telephoto. The two-power lens and the bakelite parts for the barrel, Soucy relates, were obtained from a pair of \$1.00 sport binoculars. Elements for the four-power telephoto are regular Wollensak lenses obtained at a cost of \$3.00.

Not a single change was required in either the camera mechanism or case—all the original screw holes and screws (of the front plate) being used in attaching the turret to the camera. Thus, if the camera is to be traded in at a later date the turret may be detached.

AN interesting feature is the fact that as either of the lenses are snapped into taking position, a corresponding finder mask comes into position before the front of the camera viewfinder, indicating exact field for that lens. These masking apertures are to be seen in photo No. 4.

Another innovation is the focusing tube, shown in photo No. 2, which permits direct "through the lens" focusing of each telephoto when indexed in position over this tube.

Inasmuch as the camera lens is concealed within the turret housing, means was provided for adjustment of focus through a lever attached

A TURRET with built-in tele-lenses for KEYSTONE "8"

• Pictured here are views of Harold Soucy's turret and built-in telephoto lens adaptors for the Keystone 8mm camera. Photo No. 1 shows appearance of camera fitted with turret and lenses. No. 2: Rear of turret showing focusing tube and lens aperture adjustment lever. No. 3 shows rotor plate of turret removed revealing how aperture adjustment lever is attached to lens. No. 4: Rotor plate with one lens seat removed.

SOMETHING new and different in the way of an amateur-made lens turret for cine cameras is the combination turret and telephoto lens assembly constructed by Harold J. Soucy of Worcester, Massachusetts, for his Keystone 8mm camera. Unlike Leonard Bauer's turret described in the July issue, Soucy's provides—in fact, does include as a part of the turret—telephoto lens assemblies which convert the regular one-inch camera lens into a two or four power telephoto by merely swinging the desired telephoto into place over the camera lens.

Although Soucy's imposing turret pictured above appears rigged with three lenses, actually only two of the barrels are fitted with lens elements. The third, or shorter one, aside from its purpose of balancing the appearance of the turret, serves as a holder for filters and supplemental

directly to the iris ring and extending across and out through the back of the turret housing as shown in photos 2 and 3. The end of this lever which protrudes through a semi-circular slot, as shown in the above photos, forms a pointed tip which, when placed opposite an f/ stop marked on the back of the turret, sets the lens at the corresponding stop.

Presented on the opposite page, for the benefit of readers who may be interested in duplicating this novel accessory for their cameras, are true scale diagrams of all the essential parts of the Soucy-designed turret and telephoto lenses. Fig. 1 is a plan section through the turret assembly which shows how the turret is fitted to the camera and just how each telephoto fits over the camera lens when moved into taking position.

• Continued on Page 622

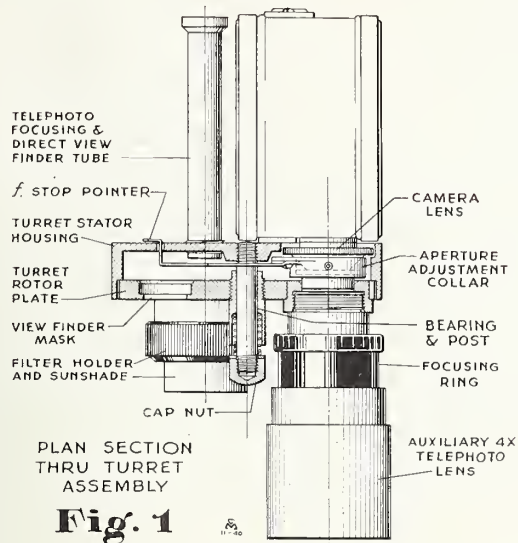

Fig. 1

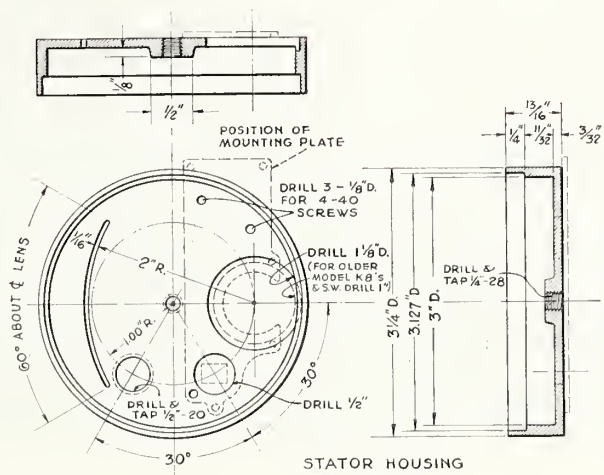

Fig. 2

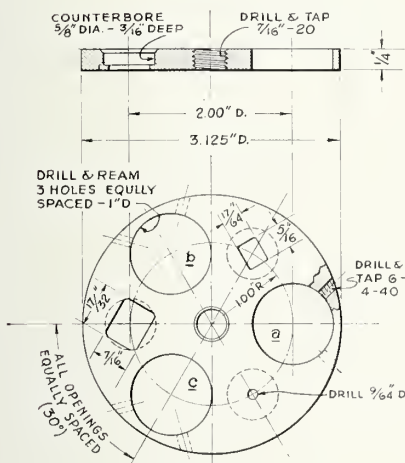

Fig. 3

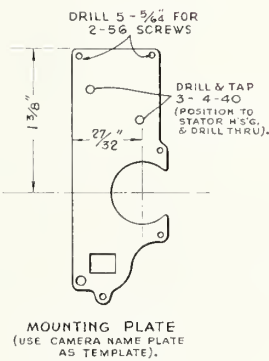

Fig. 4

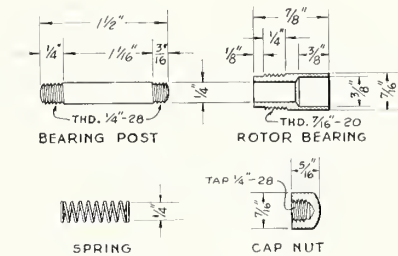

Fig. 5

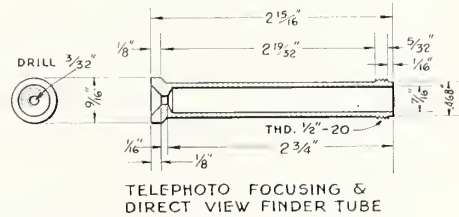

Fig. 6

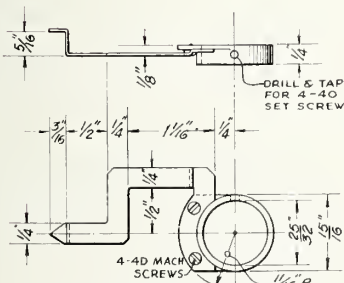

Fig. 7

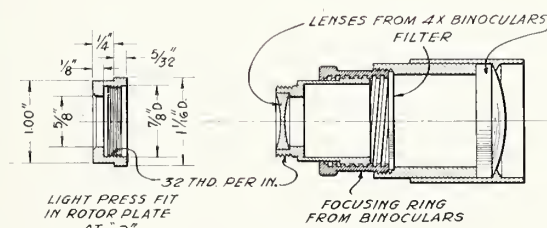

Fig. 8

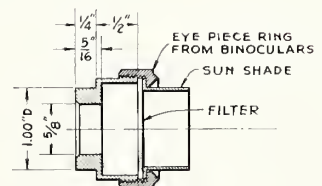

Fig. 10

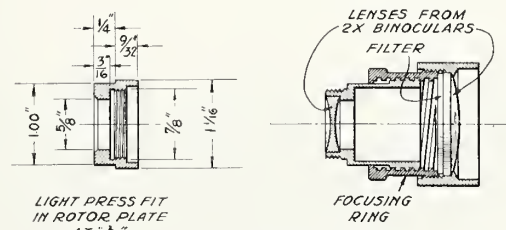
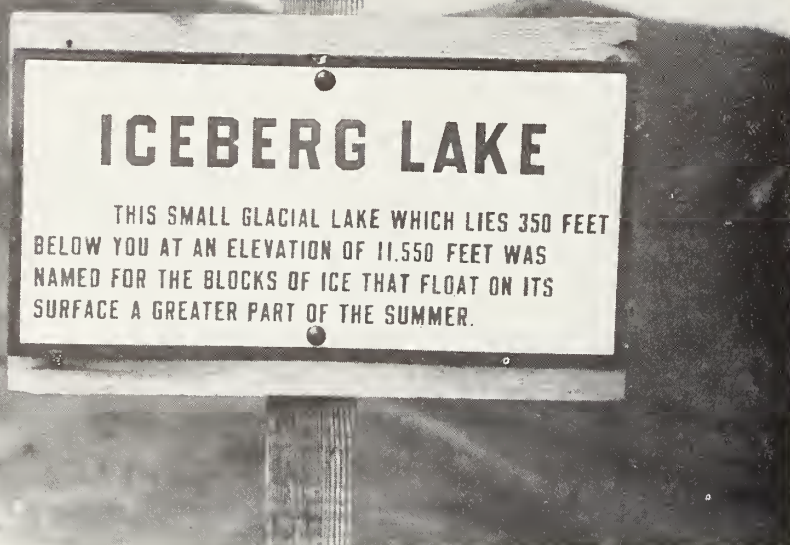

Fig. 9

Details of Lens Turret and Telephoto Adaptor Lenses for Keystone "8"

Authored by
GEORGE W. CUSHMAN



Three ideas that make TITLING easier . . .

ISN'T it strange how many times the simplest and easiest way of doing a thing is so often the best way? That's often true with titles, too. Many a worker neglects to title his films because he looks upon title making as a long and tedious job.

There are many kinds and types of home motion pictures. Each requires a different medium of explanation, editing, and so on. What will do in one case won't often do in another.

To explain the point in question, let's take an example of a home record film depicting the every day experience of two small children. One amateur wrote his titles for such a film in verse, explaining entirely by rhyme the incidents in the film. This no doubt came easily for this camera owner, but most movie enthusiasts would probably find writing titles in verse the hardest way to get the job done.

And so, just the opposite of this procedure would be to write the verses first, then shoot the picture depicting them. Does that seem a bit back-

wards — writing the titles first? It shouldn't, for the best movies are all written out carefully in advance.

But still, that means poetry writing, and this does not come easy to many of us. Here's an idea though that will make rhyming titles easy. Buy a book of child's poems — use them for the titles. And if you want to find still an easier way, find a book in which the poems are printed in just the size to fit your titler.

It is now a simple matter to select the poems required to fit the action, photograph them in the titler (the titler can be merely tipped on end and placed against the printed page) and the problem of title making for this particular film is completed, and in a most simple and easy manner. Imagine getting the verses already written and printed just the required size! Simple? Of course a little time must be spent in looking for the right book of verses — but let the wife or girl friend do that if she likes to shop.

Christmas is but a few weeks away. More than one movie fan will use the famous poem "Twas the Night Before Christmas" to make just such a yuletide film. This poem makes an excellent one with numerous possibilities, and, where difficult shots are called for, the verses can be omitted. But just think: "Twas the night before Christmas, when all through the house Not a creature was stirring, not even a mouse." Following this is a chance for a swell opening shot of the living room with the tree lighted, a few presents around it, and so on. "The stockings were hung by the chimney with care, In hopes that Saint Nicholas soon would be there." Of course this means a close-up of the stockings hung by the chimney.

"THE children were nestled all snug in their beds, While visions of sugar-plums danced in their heads." Obviously this calls for a shot of the youngsters fast asleep; and if you care to try

• Continued on Page 617

• Shots of road markers and highway signs, like the one above, make excellent titles for travel and vacation movies and may be filmed as you go. Newspaper headlines are titles made to order for the news events you successfully filmed! An example is illustrated below. If you're "stumped" for words — having trouble with composition — try titling in rhyme as did one filmer, one of whose titles appears below. A book of poems will provide a surprising number of titles for all types of movies.

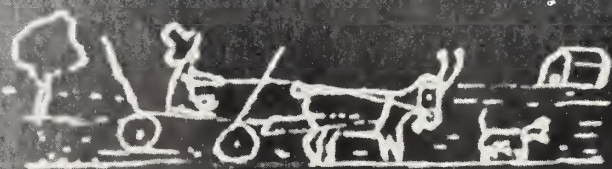

The roads a boy and dog may take
Touch magic lands, and then
Farm lost trails that a boy grown tall
Can never find again.



FIG. 1



FIG. 2

Tips on MAKE-UP for home movies . . .

By JACOB DESCHIN, A.R.P.S.*

TO dramatize the good features and subdue the bad are the principal functions of make-up. There is only one way to achieve the flattering Hollywood quality of smoothness and satiny texture that is so much desired by the advanced amateur cinefilmer engaged in serious movie making. To subdue chins, reshape a nose, shadow imperfections, highlight good features and give that softened, luminous quality to the entire face, make-up especially designed for black and white photography must be used.

There is nothing at all tricky nor expensive about make-up. On the market now are complete kits which include a variety of easily applied powder bases, panchromatic face powders, rouge, and eye shading necessary for making up male or female faces—blonde or brunette. Use of these kits is increasing among cine clubs active in producing club pictures with a photographic quality approaching theatrical productions.

There are two general classes of make-up. One is the routine treatment for concealing skin blemishes and discolorations as well as minor corrections, such as eye shadow, etc., and the other is corrective, having to do with subduing, with the aid of proper lighting, certain unsightly facial contours. The first requires no more experience or knowledge than the average woman already has in making up for the street; the second calls for nothing more than an appreciation of the fact that in make-up we use the lighter make-up shades for high-lighting desirable features, and the darker shades for darkening or shading objectionable features, just ordinary common sense aided by a make-up kit especially designed to make the work easy going even for the beginner.

As we all know, make-up for movies makes it imperative the work be done so completely that the subject may move about at varying angles with relation to the camera without showing

make-up demarcation lines. It is important, therefore, that the make-up treatment be complete over the entire face and around the neck.

Another point is that the movie-maker seeking the most agreeable results must eschew heavy make-up as he would the plague. Crudeness in make-up treatment is particularly noticeable in this respect; rather than work for the improvement of features, such efforts may even introduce objectionable details that are lacking in the subject herself. This is not to be confused, however, with shades of make-up which, under strong lightings, such as outdoor beach scenes, may be darker than when working indoors with normal amateur movie-making light sources.

Glamorizing is the special field of the movies and the new make-up kits are particularly adapted to this task since the make-up may be applied a little more heavily in such instances than usual without the disastrous results commonly seen in such efforts. It is understood, of course, that make-up is employed on men as well as women, although in the first case the work is usually limited to absolute essentials.

IN using make-up, there are a few rules that are indispensable to success in this work. The first is that application should be done sparingly, "almost to a nothingness," just a thin film that will catch the light pleasantly and give the skin texture a vibrant, alive appearance without obliterating the natural texture lying underneath the application.

The second point, no less important than the first, is that the worker must "blend highlights and shadows off softly, leaving no sharp edges." This seems obvious enough, yet is a serious pitfall that some may overlook in their first attempts. The final goal of make-up is to give no inkling of make-up at all, providing a general improvement that looks as real as life. Actually, the func-

• Above — Richard Willis, Warner Brothers' make-up expert demonstrates method of applying make-up: Fig. 1 — In applying eyebrow pencil, follow the natural line, and soften the starting and finishing points of the eyebrow. Fig. 2 — Foundation base should be applied in five light dabs; on the forehead, cheeks, nose and chin, and then smoothed over the face with tips of fingers.

*Courtesy Hampden Makeup Co.

• Continued on Page 618

Authored by
DR. A. K. BAUMGARDNER
Illustrations by the Author

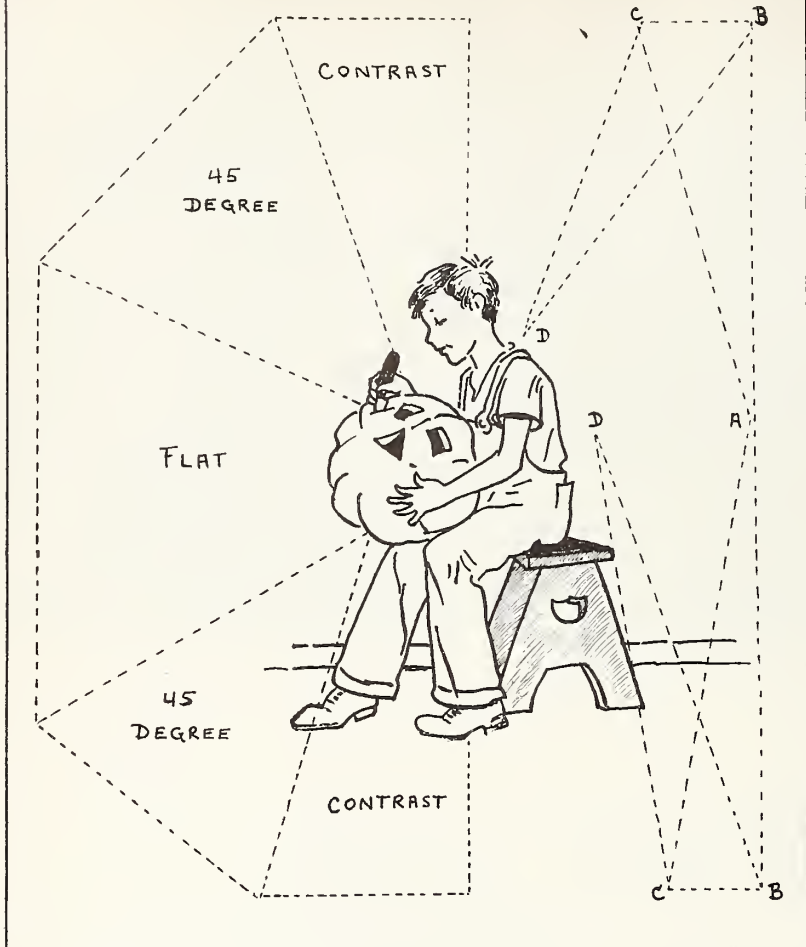

FIG. 1

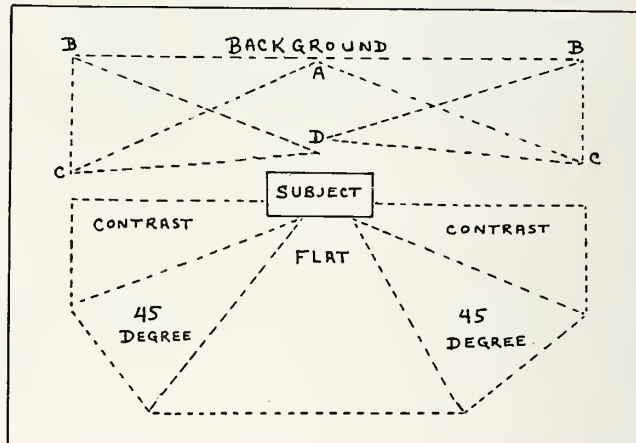

FIG. 2

ZONE LIGHTING *for* *cine photography . . .*

• Zone Lighting involves the placement of lights in those positions where they will create definite results. Key positions are indicated in diagrams on this page.

HAVING progressed with the general rules for manipulation of the camera, the next logical problem seems to be that of controlled illumination. Most amateurs agree that the indoor phases of cine work are more fascinating than those pertaining to outdoor work, mainly because of the positive control of light.

Lighting problems are not difficult to solve, although indoor work is generally considered an advanced form of photography. Professionals have used for many years a rather simple system which we can apply to our amateur work. This is generally known as zone lighting and embodies the placement of lighting units in those positions where they will create definite results.

To analyze this subject, we must first establish the zones which are classified into two general groups, viz. the horizontal diagram and the vertical diagram. We shall first consider the horizontal diagram or floor plan as it is commonly called.

As an example, we place the

subject a few feet ahead of the wall in order to consider background effects. In figure 2, the background lights cover the zones represented by the two triangles ABC. The lights are placed slightly forward but directed toward the background. This is not to be confused with backlighting, as these zones are entirely for the purpose of lighting the background to eliminate shadows and to increase depth. The two triangles BCD are the zones for backlighting and with the units placed in approximately the same position as for the background they are directed away from the wall or toward the back surface of the subject. The effect thus obtained is for model improvement and while it also increases depth, its main purpose is to create more natural effects of fine detail, rounding out the front illumination and adding glint to the hair.

IF we were to stop here and make an exposure with these lights, using no other units, we would produce silhouettes. The forward zones are Contrast, on each side of the subject; 45 degree also on each side but slightly forward; Flat zone immediately in front of the subject which is also usually considered the camera angle. By placing one unit in the contrast zone, it is obvious that we would brightly illuminate one side of the subject, but keep the opposite side heavily shaded. If another unit is placed in the opposite contrast zone, we neutralize the shadow effect. By placing the light unit slightly forward in the 45 degree zone, we reduce contrast by forcing the shadow more to the back of the subject. If both 45 degree zones are used, the front of the subject is rather evenly illuminated and the shadows are lost in the background lights. The flat zone, which is directly ahead of the subject gives a very limited, model

• Continued on Page 61

FIG. 3





Lloyd Bacon 1st honorary member

By WARREN GARIN

of the REEL FELLOWS

IN HOLLYWOOD, where "big time" movies are made, Reel Fellows have an enthusiastic brother-member in Lloyd Bacon, whose name is not unfamiliar wherever Warner Brothers' pictures are screened. In recognition of the encouragement and support given the amateur movie maker by Director Bacon, the Reel Fellows recently made him the first Honorary Member of their organization.

Recalling well how, in earlier days, Hollywood's motion picture makers also formed an organization — the Academy of Motion Picture Arts and Sciences — to stimulate and encourage cooperation among its movie producers, Director Bacon sees in the Reel Fellows a kindred association, beneficial to beginning and advanced movie amateurs alike.

Lloyd Bacon, even though he's one of Hollywood's highest paid directors and the most important on Warner Brothers' lot, does not look down upon the home movie maker as small fry. On the contrary, Lloyd Bacon is himself a home movie maker — has been since advent of the first practical cine camera back in 1923. And he's solidly behind the movement of the Reel Fellows to widen activities of the nation's movie amateurs.

Home movies is not only one of the finest of

hobbies, Lloyd Bacon believes, but by making his own personal movies the amateur becomes more appreciative of Hollywood's motion pictures — gets more out of the pictures presented for entertainment on theatre screens.

Moreover, Director Bacon is of the opinion that out of the ranks of amateur movie makers will come some of the future directors and cameramen of professional motion pictures. He cites as example that already many advanced cinefilmmers have established themselves as business and instructional film producers. Many of us still remember that a highly successful amateur movie was purchased by Metro-Goldwyn-Mayer not so very long ago and re-made into a Pete Smith short.

Of course, not every amateur aspires to Hollywood movie making. The average amateur takes up home movies purely as a hobby, or perhaps more as an artistic pursuit as one would painting, sketching, or sculpturing.

To all amateurs, Lloyd Bacon offers this advice: To get the most out of your hobby, indulge in it

• That's not a campaign button HOME MOVIES' publisher, Charles VerHalen, is pinning on Lloyd Bacon, but a Reel Fellows' emblem. Occasion was the induction of Warner Brothers' ace director as First Honorary Member of the Reel Fellows — nation-wide organization of movie amateurs.

• Continued on Page 625

TITLE CENTERING GUIDES

*. . . for models B-8 and C-8 Univex,
and 16mm Keystone Cameras*

THE title centering guides which appear on this page are the last of the series of guides which begun several issues back and which cover all makes and models of 8mm and 16mm cine cameras.

They are especially drawn to fit the average typewriter titler and may be used in conjunction with Title Backgrounds, published each month in HOME MOVIES, as a means of accurately centering same.

To use with typewriter titlers, insert guide in card holder, line up title area within opening of card holder. Then, sighting through viewfinder, line up camera with viewfinder area and lock in position.

To shoot titles without a titler, place centering guide on wall and, with camera mounted on tripod, line up camera with viewfinder area and lock in place. Title card is placed over "title area."

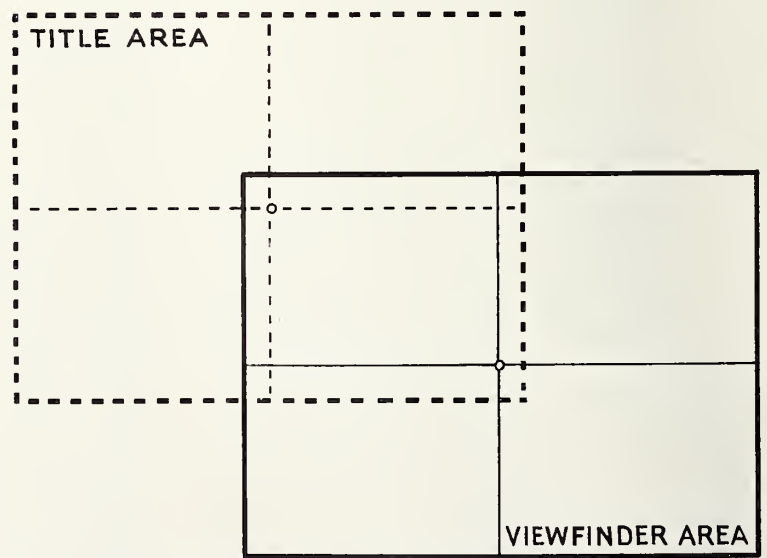
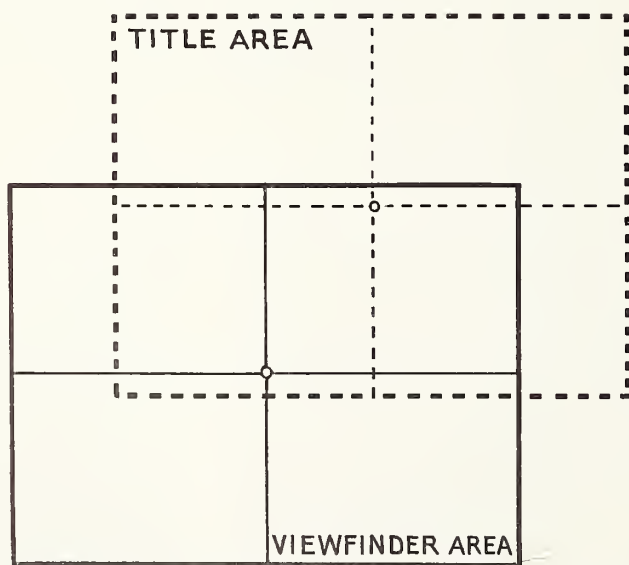
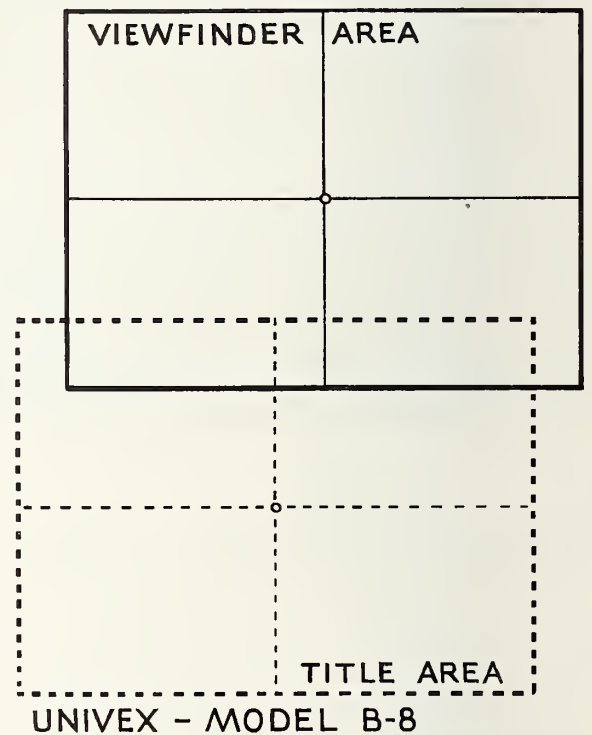

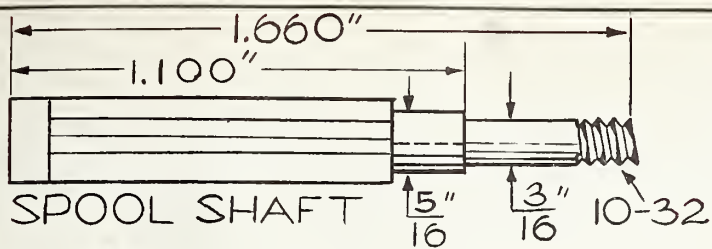

Fig. 29

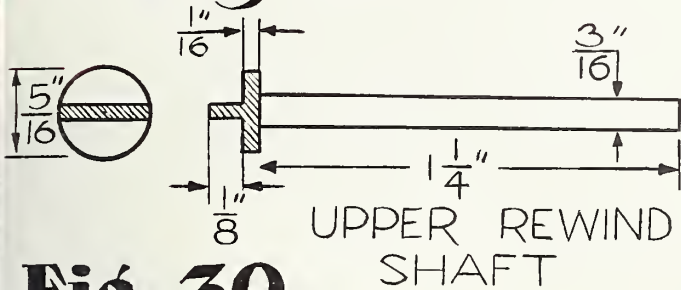

Fig. 30

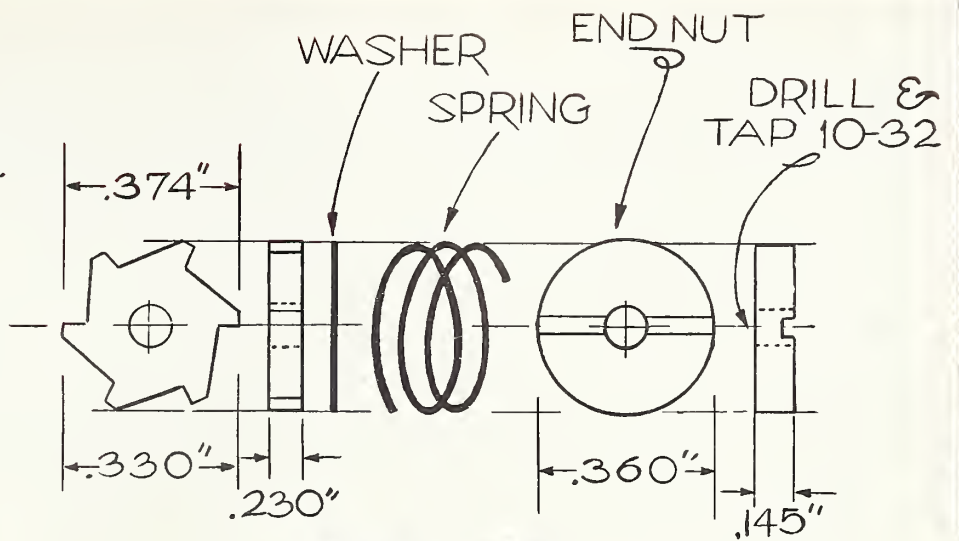

Fig. 31

F.Z.

Final conversion steps for "GLORIFIED 16"

IN winding up the conversion of the Filmo model 70 series camera to a "Glorified 16," only the free-wheeling takeup spindle, backwinding mechanism, and the effects masks and slot need to be completed.

Operation of the "free-wheeling" shaft is such that when film is being wound backwards, the shaft is mechanically disconnected and prevents film from being unwound faster than it can be taken up.

If this were not done, it would be entirely possible that the film would gain on itself and become unhooked from the spool causing jamming.

First operation is to remove the outer nut from the lower shaft, after which the shaft is then sawed off, drilled and tapped for 10-32 thread.

A short length of $\frac{3}{16}$ " rod is then threaded on one end for a distance of approximately $\frac{1}{2}$ ". This is screwed tightly into the spool shaft. Fig. 29 shows necessary dimensions for performing these operations together with the necessary parts as required.

The sawtoothed wheel slides onto the spool shaft inside the housing. Into each tooth recess fits a small roller. Thus, if the shaft is rotated so that the expanding taper contacts the rollers, they are forced outwards against the housing, causing a locking action between the two. If the direction is

reversed, the force is immediately taken away from the rollers, thereby freeing any connection between the two.

By placing a spring around the spool shaft, a variable friction between the shaft and the sawtoothed wheel will be effected. This is necessary so that when the housing and wheel are locked together, there will be the customary slip between the driving mechanism and takeup shaft.

This is a necessary essential, as the takeup movement is always faster than the takeup of the film, hence the requirement of some means of slip between the two.

ASSEMBLY of the unit should proceed as shown in Fig. 31 with care taken to insure that the sawtoothed wheel is placed in the housing in correct relation to the takeup.

With this accomplished, the upper spool shaft is slotted $\frac{1}{8}$ " deep and $\frac{1}{16}$ " wide on the end facing the film chamber cover. This slot accommodates the shaft fitted through the film chamber cover for rewinding the film on the top side when cranking backwards.

A brass bushing $\frac{5}{16}$ " diameter, $\frac{9}{16}$ " long and with a $\frac{3}{16}$ " hole through it is fitted and soldered in

• Continued on Page 619

Authored by
ARTHUR H. HART

• Illustrated here are details for the final steps in converting the Filmo 70-DA camera to the "Glorified 16." These include installation of the "free-wheeling" takeup shaft; windback shaft and knob; and mask slot and masks.

FIG. 34.



FIG. 33.

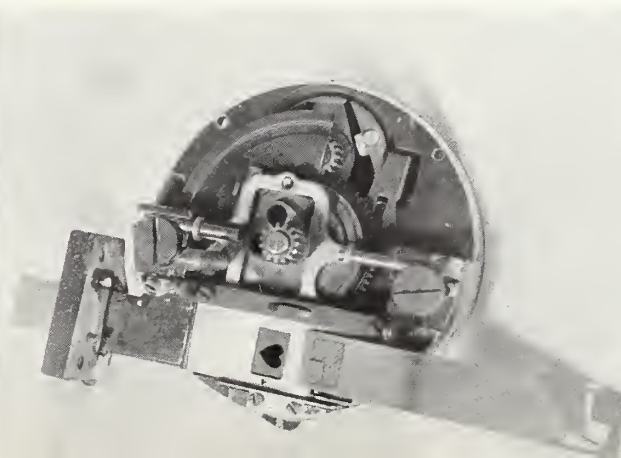
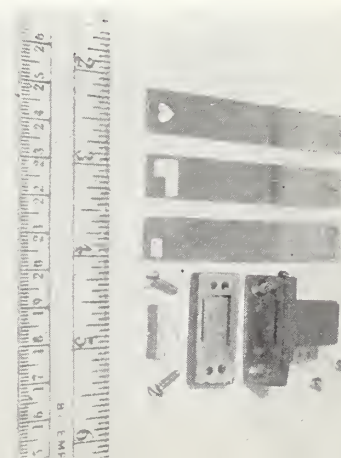
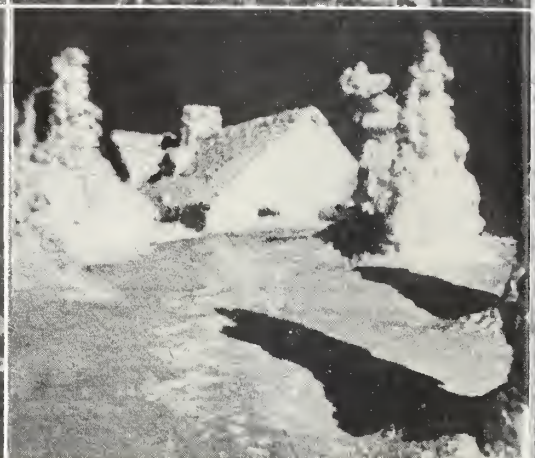

FIG. 32.



SPOKANE and the INLAND EMPIRE



MOVIE *of the* MONTH

**December award goes
to Burton Belknap's 800-
foot documentary film**

By J. H. SCHOEN

CONTRIBUTING the final entry on the year's roster of Movies of the Month is Burton Belknap's "Spokane and The Inland Empire," as fine a documentary movie as one would wish to see. Running approximately 800 feet in 16mm Kodachrome, this picture contains some of the most beautiful scenic shots yet screened by the editors.

The photographic skill of Belknap at once becomes apparent as the main title appears on the screen. Preceding it by perhaps a second is a beautiful skyline view of Spokane. Fleecy clouds fleck the deep blue sky in the background. Then the main title fades in, superimposed over this delightful scene in a well executed bit of double exposure work, and this title is followed by two supplemental introductory titles, lap-dissolved and also superimposed over the same scene.

Instead of beginning with a pictorial description of the city of Spokane, this picture first takes us through the surrounding country — Spokane's "Inland Empire" as it is justly termed — and the opening scenes cover Washington's, or perhaps we should say Spokane's, lumber industry. There are a number of fine scenes of the timber country, and these are followed with medium and closer shots of the felling of trees and their transportation to the sawmill.

A commendable sequence is that of the sawmill where Burton has carefully edited his scenes depicting the conversion of a huge log to commercial lumber. The log is "squared" in the automatic saw jig that handles the huge mass as though it were a fence post. Next we are shown the planks — sawed from this log — moving by conveyor belt to graders, and thence to the yard where they are stacked to mountainous heights, all of which were very professionally depicted by good fast cutting and proper camera angles.

The next sequence dealt with the Empire's farming industry. The opening scene of this sequence is one long to be remembered. Belknap set up his camera at the foot of a small rise in a huge wheat field. A gentle breeze blowing across the field whipped up ripples on the surface of the vast golden sea of wheat as it might the waters of any of Spokane's nearby inland lakes. And then, over the top of the hill came the tractor-reaper, harvesting the golden tops that yearly add millions to the wealth of Spokane. Here again the cutting and editing is so smooth, so deft, one hardly appreciates it until reflecting upon it leisurely after the close of the picture.

FROM grain, the picture takes us through Washington's berry farms. From beautiful long shots of vast strawberry and raspberry acreage, Belknap brings us up close to the berry picker and then tantalizes one's appetite with crisp close-ups of crates of the berries.

Following this are episodes showing fine corn fields, with closeups of the giant size ears of corn harvested in this area; watermelon patches, highlighted by scenes of a couple of boys raiding a patch and eating the stolen melon in a corn field; the dairy industry; and sheep raising.

The next sequence boasts, as well it might, of the state's National Parks with some of the mo

● Pictured above are enlargements from Burton Belknap's fine 16mm documentary picture — "Spokane and the Inland Empire." Good exposure, sharp focus, and excellent composition mark this picture an outstanding amateur effort.

● Continued on Page 6

Reviews by
THE EDITORS



Some **FILMING IDEAS** that "clicked"...

IN the reviews of readers films that appear each month in HOME MOVIES may be found many ideas that can be adopted by other filers. Each picture selected for published review is chosen with this idea in mind — to benefit other amateurs. Frequently in these reviews, errors are pointed out with suggestions for their correction, which serve to guide other amateurs with similar problems.

Following are three films recently reviewed, two of which merit a rating of three stars, and the other — two stars. All are good filming ideas worthy of consideration by amateurs seeking new suggestions for home movies.

"VARIETY IN FIGURES" ★★★

Continuity: A scenario type picture that has as its basic plot, the trials and tribulations of a newlywed who chooses to "step out" on his bride.

Mr. Newlywed is obliged to work overtime one evening during the first week of his marriage, much to the consternation of his wife. As he leaves the office late that evening, he is met at the door by two pals who urge him to change his style of figures from those on books to those of a cabaret floor show. Reluctantly he consents, becomes drunk, and gets into a fight which nets him a scar over the left eye — which his wife eyes with some suspicion the next morning.

But at the breakfast table his troubles really begin when he finds a photo in the morning paper taken of him in the cabaret the night before. From here on follow amusing efforts of the bridegroom to conceal the newspaper from his wife. His wife almost sees it when he is called to the phone momentarily, and he becomes so excited he dashes from the house without kissing his wife goodbye.

This is too much for his bride, whereupon she dons his overcoat and pursues him down the street. Looking back, Mr. Newlywed observes his wife in pursuit and believing she has learned of his escapade, he starts to run. As he passes a man reading a paper, he retraces his steps and snatches the paper from him. Then, he snatches all the papers from a newsdealer. But his wife catches up with him and when she does she starts to bawl him out for — guess what? For not kissing her goodbye!

Hubby, considerably relieved, drops the newspapers at her feet, kisses her and walks briskly away. As wife looks down at the newspapers, the damning photo stares her in the face. Her ire now completely aroused, she starts after the husband, snatching a baseball bat from a group of kids in her flight. The kids join the chase and the final chase scenes are reminiscent of the old Keystone Comedy technique which is always sure fire. These latter scenes were shot at 8 frames per second to speed up the action.

Commendable is the very Hollywoodian manner in which this filer injected the element of surprise and suspense and kept it running throughout the picture.

Photography: Most of the scenes of this picture were shot indoors and the consistency of exposures is a real accomplishment. The whole picture was shot on negative stock from which positive prints were made.

Editing: This amateur is to be congratulated on his editing which was very good throughout. All scenes are kept to a consistently interesting length.

Titling: Generally good. Main and introductory titles were made on a blackboard. Subtitles were sufficient to knit the story together nicely. All were well exposed and accurately centered.

"IN SPITE OF ADAM" ★★★

200 Ft. 8mm Kodachrome — by C. I. L.

Continuity: A very fine and interesting picture built around the subject of apples and apple culture — hence the unusual title. One of the interesting features is the manner in which this filer choose and placed his descriptive titles which aided greatly in strengthening continuity.

The picture opens with a general scene of an apple orchard.

• Continued on Page 620

• Photos of top are enlargements from the 16mm picture, "Variety in Figures." Below: A scene from "In Spite of Adam," on 8mm Kodachrome picture, and "Cabin of Dreams," on 8mm home processed film.



What are you

THE same Santa Claus who brought the cine camera or projector invariably fails to repeat on the following yuletide with gadgets and accessories that make home movies so much fun. One may hint broadly for a new exposure meter or a splicer—right up to December 24th—only to find socks, ties, and a bathrobe when the gifts are unwrapped Christmas morning.

Must this frustration continue Christmas after Christmas? Indeed not! You can play Santa Claus yourself—and to yourself! In a few weeks, when you get that bonus or Christmas savings check, start your Christmas shopping at your nearest camera store. Buy that exposure meter, or that splicer, or the other gadgets you've been wanting so long. Give *yourself* a present this Christmas!

Just in case your memory needs jogging on the accessories you've planned to buy, we've prepared a list below of some important gadgets and accessories and have classified them according to cost in various price groups. Thus, if you have but \$5.00 to spend, you can find the gadget to fit your purse in the "\$1 to \$5" group. (If any gadgets are omitted in the following descriptions, it is not intentional—just that we couldn't remember them all!)

Don't neglect to review all of the items. For if there's something not quite within reach of your pocketbook, remember it probably can be bought on liberal budget terms from your dealer.

\$1 to \$5

Craig Junior Splicer \$2.50
For 8mm and 16mm films. All-metal, precision built, and mounted on attractive wooden base. Complete with emulsion scraper, bottle of cement, and water bottle.

Craig Movie Supply, Los Angeles, Calif.

4-Star Beaded Screens \$3.95, up
Other models up to \$17.95. Available in easel and self-erecting box models. Feature special felt backing that prevents loosening of glass beads by friction as screen is rolled or unrolled.

Hollywood Cine Products Co., Los Angeles.

Cine Cable Release \$2.00
Includes adapter for attaching to Keystone, Filmo, Eastman and Victor Cameras, providing for remote control of starting button. Just the thing for single frame exposure.

Garmur Products, Los Angeles, Calif.

Filters and Sunshades \$1.50 up
Famed Harrison & Harrison filters available in all colors and sizes for 8mm and 16mm cameras, mounted or unmounted. H & H Sunshades and filter holders, \$1.00 up.

Harrison & Harrison, Hollywood, Calif.

• Pictured here are many accessories that make home movies a more enjoyable hobby. If Santa can't be trusted to bring the one you want this Christmas, buy it yourself!

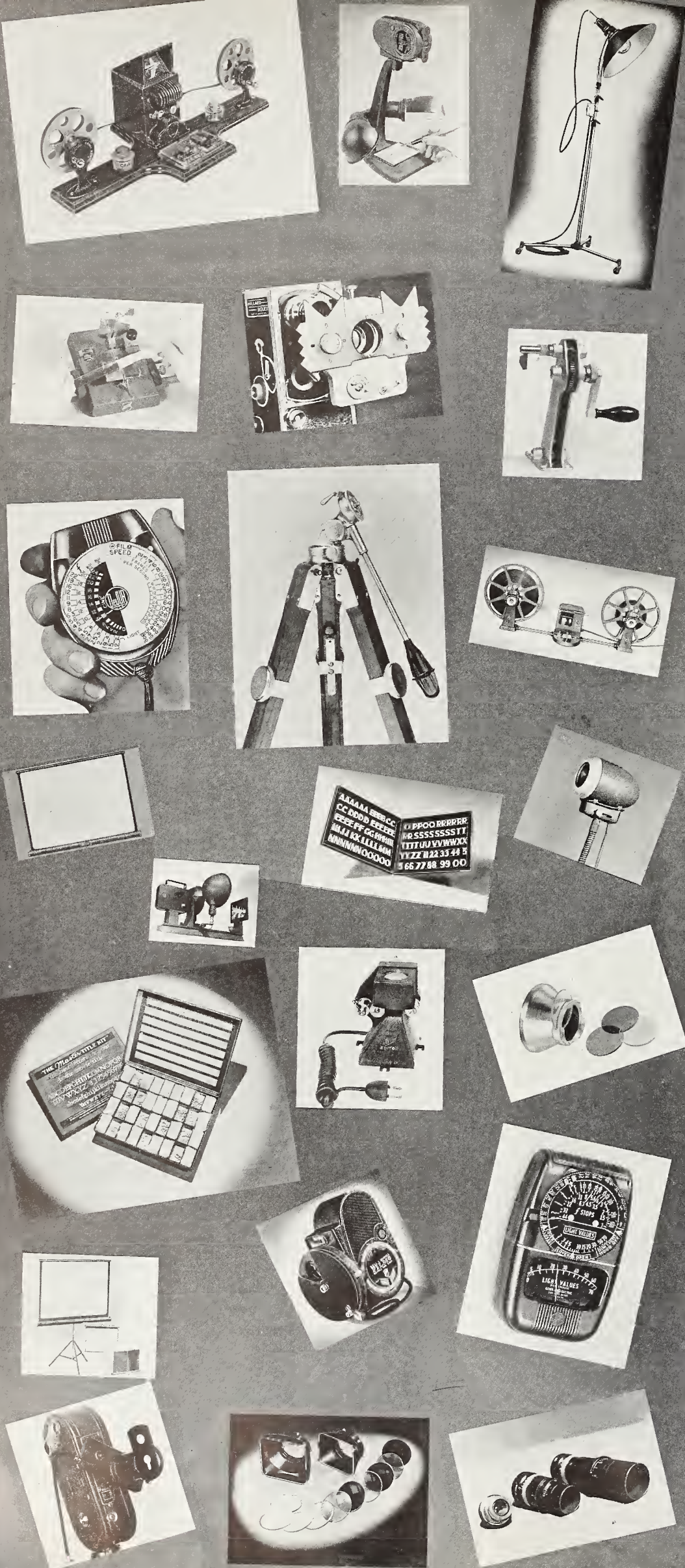

ing YOURSELF for Christmas?

- Airtelite Clamp Reflectors**\$3.50
Efficient clamp reflector for making indoor movies with photoflood lamps. Equipped with rubber finished clamp for attaching to furniture or other objects, making tripods or standards unnecessary. Takes No. 1 or 2 photofloods or 500 watt T-20 bulbs.
Motion Picture Screen & Accessories Co.,
New York City.
- Home Movies Subscription**\$2.00
A valuable gift for yourself or brother cinebug which will bring each issue safely to the door every month. \$2.00 pays for 12 issues or a 3 years subscription may be had for \$5.00—a saving of \$1.00. Another gift idea is a 1-year subscription and a handsome binder which holds 12 issues—total value \$3.25—for only \$3.00. Order direct from
Ver Halen Publications, Hollywood, Calif.
- Seemann Splicer**\$2.95
An efficient splicer for both 8mm and 16mm films that features "dry splicing" without need of moistening film with water.
Seemanns, Inc., Hollywood, Calif.
- Movie Tinting Outfit**\$2.00
Novel kit enabling any amateur to make artistic hand-lettered titles for his movies.
Jacob Stein, New York City.
- Film Releases**\$1.75
Castle Films' famed movies of topical events as well as cartoons, dramas, etc. Now available, Castle Films' latest release—"News Parade of the Year" in 100 and 360 foot lengths in 16mm and 50 and 180 foot lengths in 8mm. All Castle Films are now processed for protection against scratches and to insure longer life.
Castle Films, New York City.
- Baia Film Slitter**\$2.50
For accurately slitting double 8mm film into two separate single 8mm widths. All-metal precision construction with cutting wheels of hardened steel. Guaranteed by manufacturer.
Baia M. P. Engr. Co., Detroit, Mich.
- Da-Lite Beaded Screens**\$2.00 up
Brilliant glass beaded screens famed for their durability and efficiency available in table, box, wall and tripod models; also special models controlled by motor for large homes and auditoriums.
Da-Lite Screens, Chicago, Ill.
- Wesco Fade-O-Mask**\$2.50
A companion accessory of the Wesco Fadette. Constructed of plastic, it attaches to the Fadette for holding a variety of masks for special effects in home movies.
Western Movie Supply, San Francisco, Calif.
- Exotic Title Letters**\$2.50
Title letters with a permanent, re-usable adhesive backing enabling the letters to be used time and gain. Size of letters 13/16" high. Set consists of 240 characters.
Accurate Cinema Service, Chicago, Ill.
- G-E Photofloods**15c
A "must" for every movie maker shooting indoors or making titles. Usual G-E standard in filament and globe construction assures maximum light output and efficiency. No. 2 size, 30c each.
General Electric Co., Cleveland, Ohio.
- Haile Film Slitter**\$2.50
Precision device for slitting double 8mm film into two single 8mm widths. Essential for home processors. Cutting wheels of hardened steel.
J. C. Haile & Sons, Cincinnati, Ohio.
- Knight Title Letters**\$4.28
Handsome all-metal capital letters. Set consists of 126 characters. Variety of face styles. Set of 222 capitals and small (lower case) letters available at \$7.16
Knight & Son, Inc., Seneca Falls, New York.
- Gibbs Flood-Guns**\$2.75
Twin floodlight reflectors mounted on horizontal bar. Attaches to camera and provides portable lighting equipment that moves about scene with camera.
Arthur E. Gibbs, Portland, Ore.
- Reel Fellows Membership**\$1.00
A new nation-wide association of American movie amateurs. Initial membership fee brings gold emblem, membership card, and insignia for camera. Join now and make a gift membership to a fellow cinebug, too!
Reel Fellows, 6060 Sunset Blvd., Hollywood, Calif.
- Filmo Splicer**\$4.50
Model 72-L for 8mm and 16mm films. Makes a durable diagonal splice. Metal working parts mounted on attractive wooden base. Included are scraper blade, bottle of cement, and water bottle.
Bell & Howell Co., Chicago, Ill.
- Victor Clamp Reflectors**\$2.65
Aluminum reflectors with sturdy clamp for attaching to back of chair, etc., in place of tripod or standard. Accommodates No. 1 photofloods and throws even brilliant light.
Jas. H. Smith & Sons Corp., Griffith, Ind.
- Film Releases**\$1.50 up
Walt Disney Cartoons of Mickey Mouse, Donald Duck, etc.; Oswald Rabbitt, the three monkeys—Meany, Miny, and Moe; also a large selection of comedies, westerns, and educational subjects. Prices depend upon length and subject. Catalog available for asking.
Hollywood Film Enterprises, Hollywood, Calif.
- Mittens Title Letters**\$4.75 up
Handsome plastic three dimensional letters available in various styles and sizes in prices from \$4.75 and up depending upon number of characters desired.
Mittens Display Letters, Redlands, Calif.
- \$5 to \$10**
- Cine Splicer**\$10.00
For both 8mm and 16mm sound or silent films. All-metal construction with exclusive cutting device and film alignment that insures smooth, durable splices.
American Bolex Co., New York City.
- Raygram Beaded Screens**\$10.00 up
A fine box screen that is available in sizes from 22" x 30" to 39" x 52" at corresponding prices. Features self-erecting frame, graded blue-white glass beads, and high quality Dupont Fabric.
Raygram Corporation, New York City.
- Wesco Fadette**\$5.95
For most 8mm and 16mm cine cameras. Produces rectangular fades at any speed. Rugged plastic construction. Readily demountable.
Western Movie Supply, San Francisco, Calif.
- Cine Transito, Junior**\$5.95
For making fades, lap-dissolves, wipe-offs, etc., with any 8mm or 16mm camera. Clamps to lens and controlled manually through cable release.
Baia Mtn. Pic. Engrs., Detroit, Mich.
- Royal Tripod**\$7.50
All-metal tubular chrome plated steel and bar construction. Quick lock adjustment. Rubber tipped legs. Sturdy, yet light in weight. (Tilt-top, \$5.00 extra.)
Albert Specialty Co., Chicago, Ill.
- Fisher Film Cleaner**\$6.50
Mounts on table or editing board for automatically cleaning 8mm or 16mm film during editing or re-winding operations.
Marks & Fuller, Inc., Rochester, New York.
- Title Printers**\$8.25 up
Small hand printing presses complete with type and ink for printing title cards for typewriter titlers.
Kelsey Presses, Meriden, Conn.
- F-R Hi-Spot**\$9.95
Fresnel Lens equipped miniature spotlight. Fitting for mounting on tripod or light standard. Finger tip focusing. Uses 150 Watt F-R Hi-Spot projection lamp.
Fink-Roselieve Co., Inc., New York City.
- Add-A-Color**\$7.50
Multi-color wheel consisting of eight colored cellophane segments which may be rotated in front of projector lens to add color to black and white movies. May be used with any 8mm or 16mm projector.
Friedel's, Huntington Park, Calif.
- Filmo Rewinds**\$8.00 Pr.
Take either 8mm or 16mm reels up to 400 foot size. Both rewinds geared permitting re-winding in either direction. Priced separately at \$4.00 each.
Bell & Howell Co., Chicago, Ill.
- Craig "Senior" Splicer**\$10.00
A professional-like splicer for 8mm or 16mm film, also 16mm sound film. Four easy operations produces a perfect straight splice and without moistening film. Dry emulsion scraper built in.
Craig Movie Supply, Los Angeles, Calif.
- Bolex Cinea Winders**\$9.00 Pr.
Said to be only film rewinds with adjustable tension and drag. Take both 8mm and 16mm reels up to 400 foot capacity. Precision made.
American Bolex Co., New York City.
- Besbee Titrer**\$8.75
A universal titler for all 8mm and 16mm cameras. Makes titles from small typewriter size to 9" x 12". Provides exclusive camera alignment guide and adjustable camera base. Set of adhesive title letters included with each titler.
Albert Specialty Co., Chicago, Ill.
- F-R Cine Action Editor**\$7.95
Just the thing for precision editing of 16mm movies. Shows film image in actual motion through magnifying element. Especially designed for attaching to table or editing board.
Fink-Roselieve Co., Inc., New York City.
- Da-Lite "Triple-Duty" Screen**\$7.95
DaLite's latest beaded projection screen that may be used three ways—hung on the wall, erected on a table, or suspended from metal standard which is part of the screen equipment.
Da-Lite Screen Co., Chicago, Ill.

Authored by
JESSE S. COHEN
Photos by Jeffrey Quinn



o "Lighting was our big problem . . . scenes had to be lighted brightly enough to be shot between f/8 and f/11 in order to get sufficient depth of focus that would permit the demonstrator to move around freely within the scene."

FIG. 1

Lighting interiors in TEACHING film productions

MANY amateurs, particularly teachers, have been called upon to make educational films. While these people usually have an excellent grasp of their subject matter, making their films exceedingly valuable for teaching purposes, frequently the technical quality of the film is poor, and the maximum teaching effectiveness is not gained.

The professional cinematographer, confronted by the problem of producing such films, is faced by many of the same difficulties which arise to harass the amateur. The difference in the final result is mainly due to experience, and a few tricks which are not commonly known to

people not in contact with professional film production. Most of these tricks will be outlined as we proceed.

Our group, Contemporary Films, has specialized for years in the production of documentary short subjects, many of which, such as the "Getting Your Money's Worth" series, have had wide theatrical distribution on 35mm. With this background we were called upon to make a series of art education films, the series "Techniques." These were to be produced directly on 16mm film, rather than make reduction prints on 16mm from a 35mm negative.

This in itself is no problem — excellent 16mm cameras are available. Concerning film, since a great many copies would be needed, we decided to use negative stock — the same brand and type as we had been using in 35mm, since we were already thoroughly familiar with its characteristics. This, incidentally, is one of the greatest mistakes the average amateur makes — changing brands or types of film frequently in one production. The resulting changes in tone of the picture are ruinous to continuity and distracting to the student who sees the finished film.

Lighting was our big problem — not, however,

• Continued on Page 612

FIG. 2



FIG. 3



FIG. 4



Authored by

WM. J. INSKEEP

Photos Courtesy Univ. of Iowa

U. of I. supply center for TEACHING FILMS

WHILE state, county, and city political divisions present the most logical and most prevalent major sources of supply for visual aids to school systems, there yet remains a broad province of schools not reached, for reasons of geography or economics, by the systems evolved by these units. Moreover, a function of coordination and of consultation and advice based on inside knowledge of the subject is a most important one in the yet embryonic field in many moderate-sized systems, and this is a function which could not be filled by a system supported by any political unit. The obvious, and admirable, answer to this need is the state university, which today occupies a position precisely between the local and state systems, often taking the place of the latter where no clearly defined state system exists.

Outstanding among state universities which operate a visual education supply system for schools lacking complete local facilities is the University of Iowa, which, through its Extension Division, was a pioneer in the field and now boasts one of America's most completely developed visual instruction departments. The expressed intention of the department, when founded, was "to make the best collections of visual materials available to schools and other interested organizations."

The department was started in Iowa City in 1917, with a collection of lantern slides only, by a graduate student of the Extension Division, H. W. James, who is now president of New Mexico State Teachers' College. Five years later a part-time assistant named Lee W. Cochran was hired, and today Mr. Cochran is Supervisor of Visual Education in the University, operating a large system extending well beyond the boundaries of the state.

Progress of the department from a modest collection of slides to its present proportions has been marked by the utmost care in the selection of subjects, and a continual study of the practical distribution and use of films and slides by the ultimate user. In 1918 a number of 35mm motion picture films were added to the collection; commercially produced in Hollywood, they were carefully edited before being placed in distribution. The department was entirely made up of slides and 35mm film until 1928, when Cochran intro-

duced 16mm, all additions since then being 16mm. Distribution of moving pictures saw a low ebb in 1928 to 1932, due to the lack of projection equipment in the field and lack of funds with which to procure it, but under Cochran's constant

• Continued on Page 623



• Top photo shows filing system for University of Iowa's vast library of teaching films. In lower photo, Lee W. Cochran at camera and Vernon Putnom at sound controls prepare to shoot a scene in a recent University visual instruction production.

THE EXPERIMENTAL

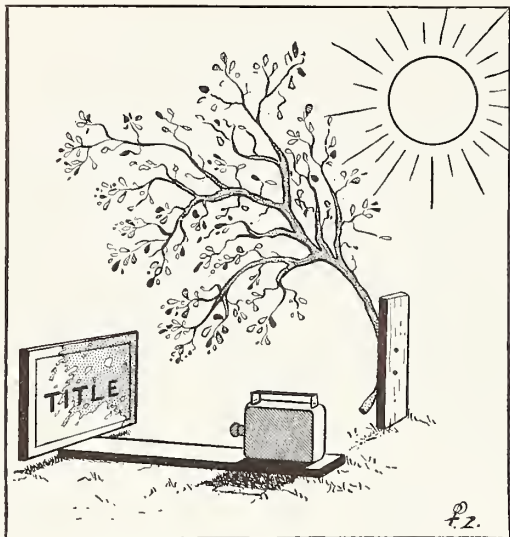

Title Background Effect

A very interesting effect may be given titles photographed as shown in accompanying illustration. The object is to project on the title card the lacy shadows of foliage moving in a breeze. The titler may be set up out of doors where the shadows of an extended branch of a tree will project upon a portion or all of the title card; or, if more convenient, a small branch may be attached to a stake driven in the ground close to the camera as illustrated. If no breeze is stirring to move the leaves, the branch may be moved slowly by hand to impart the same effect.

This idea is equally effective when shooting with positive film — black letters on white title card. The moving pattern of leaves will produce an interesting mottled effect to such titles.

— Chuck Neuzil.

For Title Cards

As a source of supply for interesting title card material, I have been using wallpaper from sample books which are easily obtainable from paint and wallpaper houses at the close of each season. Wallpaper makes excellent title card material for either color or black and white titles. Also, I have found the sample booklets issued by linoleum manufac-

turers contain reproductions in color of various linoleum patterns which make excellent title backgrounds.

— Walter J. Wrobel.

Glare Shield

Owners of most movie projectors can eliminate bothersome leakage of light from the aperture plate by the simple installation of a hinge on the lamphouse as shown in the photo. The hinge swings back out of the way for threading the machine and is merely flipped into place after projector is started.

An "off-set" hinge from the dime store makes the neatest arrangement

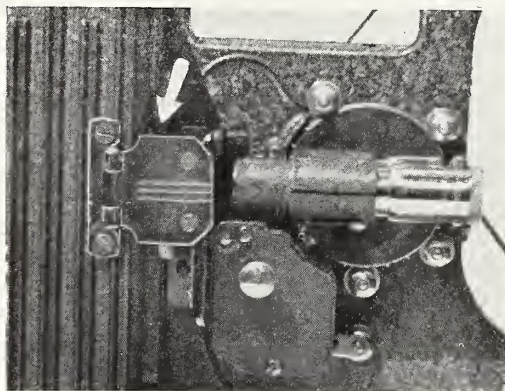

with the narrow portion bolted to the lamphouse — the larger side being left to swing. The screw holes in this latter section may be filled with solder and filed smooth.

— Wilton E. Cobb.

Gas Pipe Titler

The accompanying sketches show the home-made titler I recently built, mostly of gas pipe, and which has given me good results. Only wooden parts are the baseboard, 9 1/2 x 24 x 1 inches, and the

title card holder, dimensions of which are shown. List of necessary parts and details of construction may be had from studying the sketches. All of the pipe and hardware is obtainable from any plumbing shop or hardware store.

— John F. Szanca.

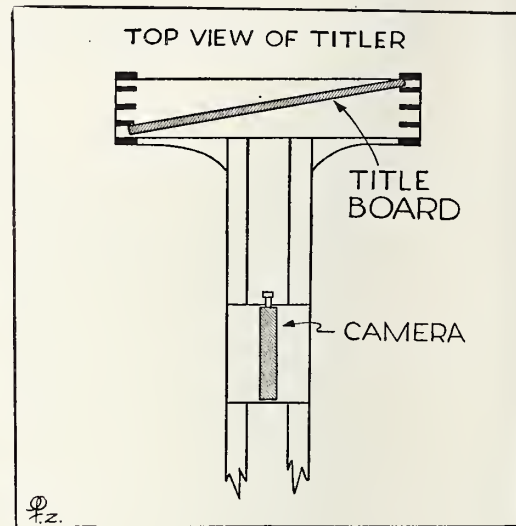

Titler Kink

Here's an idea I hit upon while making titles with the "Home Movies Titler" I recently constructed from your plans. I found that when using plastic or block letters, they usually looked flat when projected. In order to obtain the required three-dimensional effect of such letters, I altered the title card holder so that the title board would set at a slight angle, as shown in accompanying sketch. Thus the full effect of the block letters is obtained which is further enhanced by the ability to photograph more of the shadow cast by the letters when properly lighted.

— James Strom.

CINEBUGS!

• If you have an idea for a gadget, trick, or shortcut in filming, titling, editing or processing home movies, pass it on to your fellow Cinebugs through these columns. If your idea is published you will receive two reels for your efforts. Extraordinary ideas will net you a roll of film.

Ideas not published will be held for future publication unless they duplicate ideas previously received. Endeavor also to send along photos or rough sketches illustrating your suggestions. There is no limit to number of suggestions you may submit.

Important: When submitting ideas, be sure to mention whether equipment you use is 8mm or 16mm, enabling us to promptly forward orders adaptable to your use.

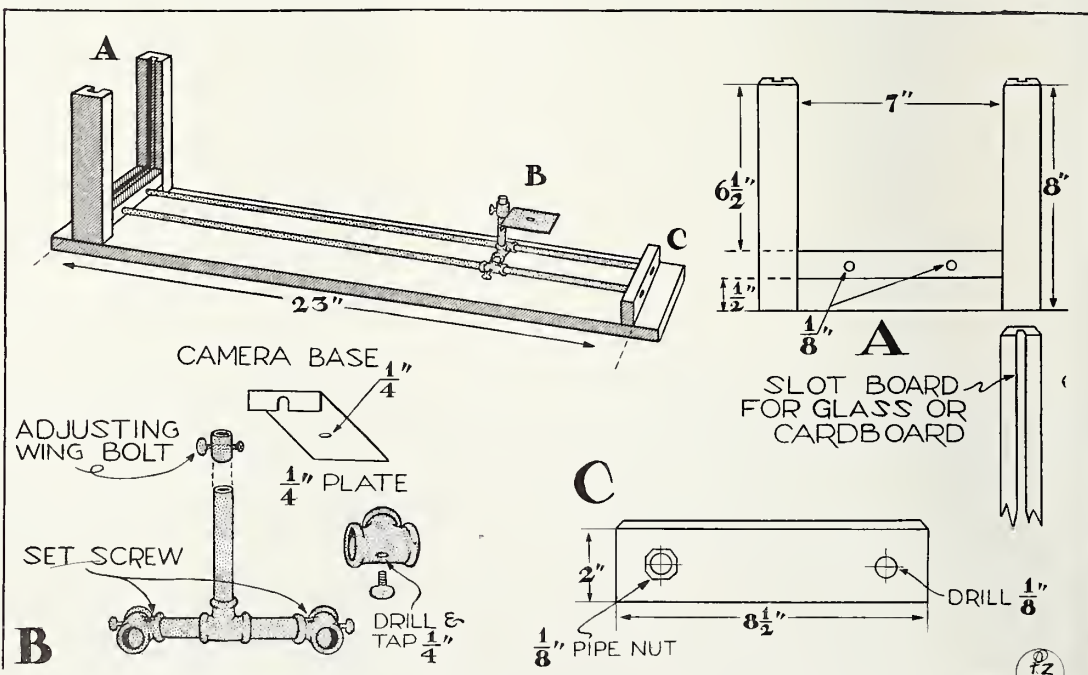

CINE WORKSHOP

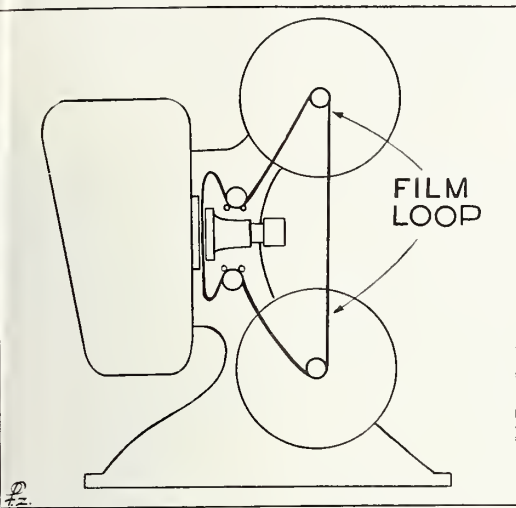

Focusing Aid

As a means for pre-focusing my projector before projecting films to an "outside" audience, I have made a "pre-focusing strip" of a piece of waste film in the form of a loop which I thread into the projector immediately after setting it up. Proper setting of lens for sharp focus is made by projecting this strip on the screen for a moment, thus avoiding burning spots in my good films when trying to focus with projector stopped. Also, a more pleasing screening of films results when the pictures start right out properly focused.

For best results, the focusing strip or loop should be made of a section of titles instead of pictures.

— John F. Ryan, Jr.

Humidor Tabs

If you store your 8mm or 16mm films in one of the many storage cabinets now on the market, you will find the removal of each reel container will be made easier if small tabs are attached to each as illustrated here.

The tabs are made of 1/2- or 3/4-inch adhesive tape, and attached to each hu-

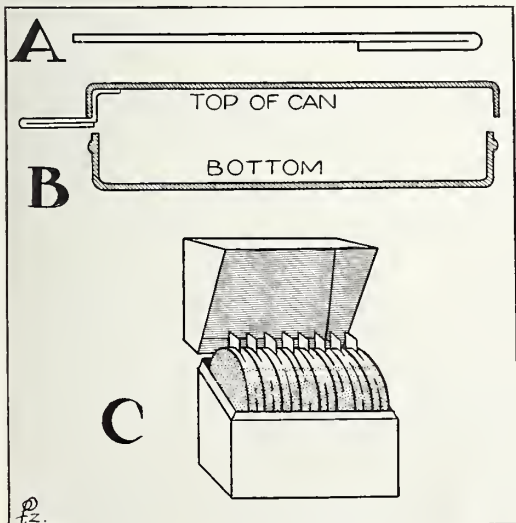

midor as shown. Thus when one humidor is to be removed from a closely-packed cabinet, it may be lifted by the tab — a real fingernail saver!

— Oscar B. Fetterman.

Projection Trick

Your projection lens may be made to serve a dual purpose—that of projecting pictures satisfactorily beyond its rated maximum distance as well as for throws for which it is rated.

I found that by removing the rear element of a projection lens, a smaller picture is projected. Thus, by moving my projector farther to the rear, or by using it in a larger room or auditorium, the picture area projected at the greater distance will equal that of average room projection when both elements are retained in the lens. In other words, removing the rear lens element reduces picture area one-half. By moving projector back twice the distance, the normal projection field is obtained.

— Ray Fosholdt.

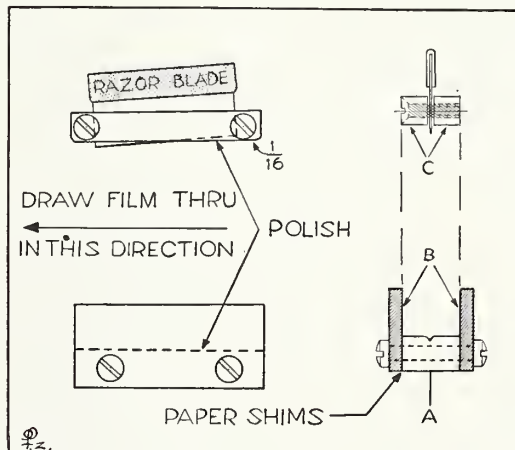

Film Slitter

Illustrated here is a simple film slitter that can be made in a short time with only a few tools. Obtain one base block "A" 5/8 inch wide and about 2 inches long. Thickness is unimportant. The two side pieces "B" can be of any width and thickness but of equal length — 2 inches.

For the cutter clamps that hold the razor blade, cut two pieces 5/16 inch square and 2 inches long. Clamp on either side of razor blade as shown by means of two small screws. Assemble the block by fitting the two "B" pieces to the base block "A" by means of two small bolts. Use paper shims if necessary in order to space side blocks proper distance to accommodate film snugly.

If cutter does not fit within the film trough, file off each side as required—taking an even amount off both sides to insure that razor blade remains accurately centered.

— Edwin D. Miller.

gadgets, tricks and short cuts contributed by Cinebugs

Projection Screen

A good projection screen suitable not only for showing moving pictures but also stills and color transparencies is of recognized value for display purposes, but the cost is sometimes prohibitive. A practical screen for such purposes, however, can be prepared with comparatively little expense by the use of either of the following glycerine-containing coating compositions applied on suitable fabrics:

1. Glycerine 1 lb.
White glue 1 lb.
Zinc oxide (good quality) 2 lb.
Hot water 1 gal.
Apply while hot. The fabric should be stretched on a smooth surface during the coating and until dry. One gallon will cover a screen 10 feet square.
2. Stick glue 1/2 lb.
Glycerine 1/2 lb.
Zinc oxide 1 lb.
Hot water 1 gal.

Melt the glue in the hot water, add the glycerine and thoroughly stir in the zinc oxide. Apply hot with a large brush to the stretched screen and let dry before removing from the stretcher. The screen may be rolled without breaking or cracking and gives very good detail.

— Glycerine Producers Association.

Novel Titles

If your home is fitted with venetian blinds, one of them may be used in conjunction with your title making to produce interesting fade-in and fade-out titles. After placing a black drape in back of the blind, the title is arranged upon the slats with cut-out or "stick-on" letters as shown. Before shooting the title, the blind should be opened so that slats are fully horizontal. Then, starting the camera, the blind is gradually closed

• Continued on Page 625



"IT'S NEW TO ME"

By CINEBUG SHOPPER



Castle Films

Castle Films have made available for the Holiday season a fine array of 8mm and 16mm movies and animated cartoons. Particular attention was given the fact that more and more movie films are being given as presents each Christmas.

Among new Castle Films just released are: "Santa Claus' Story," an out and out Christmas motion picture — not a cartoon. Santa Claus tells two children about monkeyland. He also has an answer for all the doubters who say, "There Ain't no Santa Claus"!

"Boy Meets Dog" is an especially appropriate movie for gift time. A new type of animated cartoon, it relates the experiences of a lad whose father would not allow him to be a "reg'lar feller" until pixie friends of all boys and dogs enter the picture and hilariously convert the parent.

Highly important is Castles' "News Parade of the Year—1940" which depicts scenes of practically every important event taking place during 1940.

Castle Films are available from principal camera stores in every city, according to the makers.

Master Title Kit

Recently completed for amateur movie-making fans is the new "Master Title Kit" now being marketed by the American Bolex Company, Inc. According to our reports, the "Master Title Kit" affords home movie fans the ultimate in title letter facilities.

The kit consists of 222 white all-metal characters, including both upper and lower case letters, as well as assorted numerals and punctuation marks. The letters may be colored

with water colors for Kodachrome work—and these colors may be easily washed off again. The regular letters in the "Kit" have plain backs. However, pin-back letters are available on special order.

Home Movies Binders

The American Binder Co., 253 Fifth Ave., New York, announce a complete line of Permo magazine binders with a special binder to accommodate 12 issues of HOME MOVIES magazines. It's a swell gift item and reasonably priced.

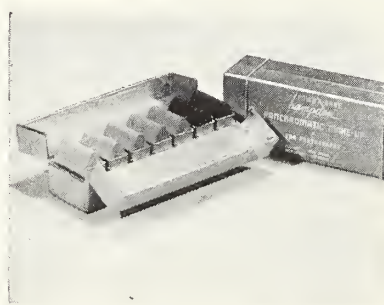

Makeup Kit

Especially acclaimed for amateur movie use is the Hampden Panchromatic Makeup Kit, now being distributed by Raygram, New York. Created for black and white photography, the kit contains five panchromatic shades of complexion foundation, three shades of powder, lip rouge, eyebrow pencil, eye shadow, lip brush and powder puff.

New Da-Lite Screen

The announcement this month of Da-Lite's new triple duty low-priced screen and contest for naming it is good news for the readers of this magazine. Not only does the screen offer many new attractive features at a remarkably low price, but the 1939 prizes, in cash and merchandise, totaling \$1050.00, are distinctly worth shooting at.

Everyone who has seen this new screen is enthusiastic. It can be used in three different ways. (1) It can be used as a tripod screen, (2) a map type

hanging screen, (3) a table screen.

For tripod use it has its own separate tripod. There is a bracket attached to the case for hanging on the wall. This bracket also fits Da-Lite's two-ply spring support, furnished with the screen, for setting up on a table. The surface is Da-Lite's famous Glass-Beaded surface, which provides maximum illumination to wider angles than the ordinary beaded screens and stays white longer than any other white surface. The beaded surface (30" x 40" size) is spring-roller-mounted in handsome black crystal-finished metal case.

Each contestant should submit the name he thinks most appropriate and his reasons in 25 words or less. More than one suggestion may be submitted. Entries should be sent to Da-Lite Screen Contest Editor, 215 No. Michigan Ave., Chicago. Contest closes December 31, 1940.

Besbee Prices Lowered

Albert Specialty Company, Chicago, manufacturers of Besbee movie titling equipment, announce new low prices on this line, despite the fact that titling sets have been enlarged and improved.

The Universal Title Maker,



Model 1941, now includes an 150-letter Title Letter Set, title illuminator with two reflectors, centralizer, 9 x 12 background and background guide card.

Foldex Tripod

A new collapsible tripod whose legs snap into picture-taking position automatically and instantly by simply pressing a catch on each leg is announced by Albert Specialty

Company of Chicago, manufacturers of photographic equipment.

Legs of this new tripod are aluminum, providing great strength and rigidity as well as extreme light weight.

Free Title Frame

The "A to Z" Movie Accessories Co. (formerly Jacob Stein, Mfr.) announce a special attractive Christmas package for movie fans who make their own titles. With the purchase of the "A to Z" Movie Titling Outfit and Figurettes, they offer as a Christmas gift a newly designed title frame. This frame is conveniently light and removable. It is especially designed to take titles up to 7" x 9". This gift is given free with purchase of the titling outfit and figurettes. Complete outfit is Christmas wrapped. It can be obtained only from manufacturer, 175 Fifth Ave., New York City.

Britelite Sunspot

Newest of Britelite accessories for amateur movie makers is their Sunspot — attractive and efficient focusing spotlight.

Designed for still and home movie-making amateurs, it is mounted on a steel yoke to permit unusually broad titling range.

It can be interchangeably mounted on a table base or tripod at will. It has an approved on and off switch and generous cable, and the optical system has been designed to take advantage of the high actinic value and lumin output of the

• Continued on Page 625



"FOOTBALL Thrills OF 1940"

Yours To Own On Castle Films!



FLASHING runs... Smashing tackles... Thrill-packed moments of breathless suspense! Own them! Share them with your family and friends right in your own living room with this sensational Castle Film! See for yourself the most amazing plays of the year—those heart-breaking bursts of skill and daring that will make football history!

Be there when Army and Navy clash—Have a seat on the fifty yard line when Harvard meets Yale—See Ohio State and Michigan churning up the turf! And those are just a few of the games that go into making this the greatest home movie *buy* of the year! If you like action—if you like thrills—if you like football—buy this picture!

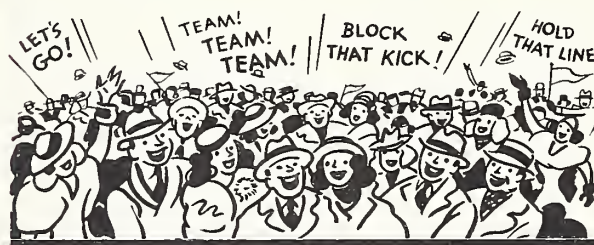

Seats for you on these 50 yard lines!*

ARMYvs.....NAVY
 HARVARDvs.....YALE
 NOTRE DAME .vs..NORTHWESTERN
 MICHIGANvs.....MINNESOTA
 FORDHAMvs.....TULANE
 PENNSYLVANIA vs.....YALE
 BOSTON COLL. vs..GEORGETOWN
 PITTSBURGH ..vs..CARNEGIE TECH.
 OHIO STATE ..vs.....MICHIGAN
 CORNELLvs.....ARMY
 NOTRE DAME .vs..GEORGIA TECH.
 TENNESSEE...vs.....DUKE

* Listing of games subject to change

**DON'T LET A DAY GO BY
 SEND THIS COUPON TO
 YOUR PHOTO DEALER NOW!**

Please send Castle Films' "FOOTBALL THRILLS of 1940" in the size and edition checked.

	16 mm SIZE
Headline 100 Feet	\$2.75
Complete 360 Feet	\$8.75
Sound 350 Feet	\$17.50
	8 mm SIZE
Headline 50 Feet	\$1.75
Complete 180 Feet	\$5.50

Name _____
 Address _____
 City _____
 State _____

CASTLE FILMS

30 ROCKEFELLER PLAZA
 NEW YORK

FIELD BUILDING
 CHICAGO

RUSS BUILDING
 SAN FRANCISCO

PLEASE THE
MOVIE-DIRECTOR
OF THE FAMILY!
GIVE THIS
WESCO GIFT
COMBINATION!



Amateurs can Get "Big Studio"
Results in their HOME MOVIES
by Shooting a Wesco

Home Movie Scenario
with this professional

FADE-IN & FADE-OUT and these
6 POPULAR
MASKING
EFFECTS



Attached to
Keystone
Camera

Wesco's

FADETTE

combined with

FADE-O-MASK

regular price \$8.45

specially priced
complete with halder and
three double masks \$7.75

WESCO FADETTE—the only vignetter producing a rectangular fade at ANY desired speed. Gradual Fading—In or Out—Fast or Slow at the will of the operator. NO SUDDEN SHUT OFF. Light weight . . . rugged construction. Fits most all cameras. \$5.95 Comes with cable release and filter holder.

Special adapter for Eastman lenses 75c. When ordering specify make and model of camera.

WESCO FADE-O-MASK—holder of durable tenite, takes the place of filter holder. Attached quickly and easily to the Fadetite. The Wesco Fade-O-Masks of thin flexible pyralin are quickly and easily interchangeable, and give the movie maker an unlimited range of novel effects. \$2.50

Home Movie Scenario

Professional Hollywood Shooting Scripts for amateur movie makers with filmed Titles, clever props, Title cards — your name on a screen credit card — all to double your film fun.

What a Picnic \$1.00 Shapes of Bath \$2.00
Pickle Party Pranks . . \$1.75 Home-e-o and You-li-et . . \$3.00
Plots & Blots \$1.75 We do the Darndest Things \$2.50

Ask Your Dealer for a Demonstration.

WESTERN MOVIE SUPPLY CO.
254 SUTTER STREET SAN FRANCISCO

What are you giving yourself . . . ?

• Continued from Page 599

4-Star Titrer \$9.95
All-metal universal typewriter titler for making titles at distances from 4", 6", 8" and 12". Facilities for making "zoom" and superimposed titles. Additional equipment available at slight extra cost for making scroll, flop-over, and turn-around titles. Fits all 8mm and 16mm cameras and has fitting enabling mounting on regulation tripod. The same titler, less lights, sells for \$6.95.

Hollywood Cine Products Co.,
Los Angeles, Calif.

Quixet Magnetic Title Letters \$9.50
Three dimensional plastic letters with minute magnets fixed in the back of each that enables them to cling securely to metal title board covered with appropriate title backgrounds of photos, illustrations, and drawings. Set consists of 10" x 14" metal background and 91 Quixet title letters. Additional characters available at 10c each.

Quixet, Inc., Dayton, Ohio.

\$10 to \$15

Britelite Beaded Screens—\$10.00 up
Available in a wide variety of models for home, school, or auditorium use. High quality glass beaded surface.

Motion Picture Screen & Access.
Co., New York City.

Wollensak Lenses—\$10.00 and up
Wollensak Optical Company, one of the foremost lens manufacturers of America, offer amateur movie makers a wide variety of standard as well as wide angle and telephoto lenses for either 8mm or 16mm cameras. Prices vary over a wide range depending upon size and quality of lens desired.

Wollensak Optical Co.,
Rochester, N. Y.

Britelite Sun-Spots \$10.95
A radically different spotlight for the amateur. Has 4½" Fresnel-type lens; uses No. 1 photoflood lamps; tilting table base; and practical ventilating system.

Motion Picture Screen & Access.
Co., New York City.

Bolex Master Title Kit \$12.50
Consists of 222 cast title letters, numerals, and punctuation characters in handy divided box. Letters 5/8" in height. Available in plain back or pin back as desired.

Amer. Bolex Co., New York City.

Raven Screens \$15.00 up
One of the foremost manufacturers of screens for motion picture theatres also produces an excellent line of opaque and beaded screens for home movie use. Available in all types—table models, tripod models and wall type screens.

Raven Screen Corporation,
New York City.

Hollywood Tripod \$11.25
An all-metal tubular tripod, lightweight but rigid, weighing but 3¼ lbs. Corrosion and tarnish resistant. Readily adjustable. Complete with title-pan head, \$15.75.

R. J. Pagliuso Mfg. Co.
Glendale, Calif.

Eastman Splicer \$12.50
A sturdy universal splicer for both 8mm and 16mm (sound or silent) films. Produces a straight neat splice. All-metal construction finished in brown crackle and nickel trim.

Eastman Kodak Co.,
Rochester, N. Y.

Thalmetal Tripod \$14.00
Complete with tilt-pan head. A new and different all-metal cine camera tripod with patented "sure-foot" leg tips that insure against slippage on any surface.

Thalhammer Co., Los Angeles.

Dinky-Inky Spotlight \$15.00
Powerful, all-purpose 100-150 watt spot for indoor movie making. Focus from 8 degree spot to a 44 degree floodlight. Handy lever for focusing. Lens diameter 5½".

Bardwell & McAllister Co.,
Hollywood, Calif.

B & H Splicer \$12.50
A sturdy splicer designed along professional lines for particular 8mm or 16mm filmer. Produces a neat diagonal splice. Features a built-in dry scraper, and all-metal construction.

Bell & Howell, Chicago, Ill.

\$15 to \$25

DeJur "Critic" Meter \$15.50
Model 40-C exposure meter designed especially for use in filming home movies. Rated sensitivity 1 to 4000 candles. One scale for all light intensities. Viewing angle especially adapted to angle of cine camera lenses. An American-made meter famous for its one-hand operation.

DeJur Amsco Corporation,
Shelton, Conn.

Boal Cine Fader \$17.50
Fits any cine camera enabling one to make fades and dissolves as he films. Produces 64 different effects. Timed and operated by small clock-like mechanism.

Amer. Bolex Co., New York City.

Eastman Film Viewer \$20.00
A compact and efficient viewer for 16mm films adaptable to mounting in small space on any editing board. Shows film image highly magnified.

Eastman Kodak Co.,
Rochester, N. Y.

Weston Jr. Exposure Meter . . \$15.50
A compact, extremely simple exposure meter that aids in getting "on the dot" exposure everytime. Quickly pre-set for type of camera, emulsion speed, and frames per second. No dials to turn.

Weston Elec. Inst. Co.,
Newark, N. J.

Eastman Rewinds & Splicer . \$22.50
Mounted on attractive base, the rewind is of the professional type insuring the most accurate of splices for either 8mm or 16mm films, including 16mm sound film. Rewinds are both geared and take either 8mm or 16mm reels up to 400-foot capacity.

Eastman Kodak Co.,
Rochester, N. Y.

Windbacks \$24.00
Custom-built windbacks for the Filmo 8, including small 24 frame counter. A valuable accessory for making lap-dissolves and wipeoffs. All work guaranteed by manufacturer.

MacFan Mfg. Co., San Diego, Calif.

Filmo Fader \$17.50
Readily attachable to any Bell & Howell Filmo camera for making fades and dissolves. Fades are made with rotating disc which is graduated from opaque black to clear and back again to opaque. It may be operated by hand-held cameras as well as those tripod-mounted.

Bell & Howell, Chicago, Ill.

Filmo 16mm Titrer \$21.50
Made especially for models 141, 70, and 121 Bell & Howell cameras. Film titles at distances of 12". Spacer rods hold camera mount and title card base in correct alignment and spacing. Lighting reflectors clamped at each side where they may be moved about for various lighting effects. Reflectors take standard No. 1 photofloods.

Bell & Howell, Chicago, Ill.

\$25 and Up

Filmation Viewer \$49.50
New action viewer for 8mm and 16mm films (separate model for each). Shows film image as a motion picture in enlarged miniature screen. Provides complete protection of films against damage or scratching during editing operations. Price includes splicer and rewinds.

Bell & Howell, Chicago, Ill.

Brown Micro-Matic Titrer . . \$27.50
A better titler that provides optical-bench precision so essential to good title making. Features include vertical or horizontal mounting; self-locking camera mount; positive lens and easel alignment; lights; self-centering supplemental lens holder; demountable title frame which holds title cards from small typewriter size to 9" x 12"; and other accessories. Provides for making flopover titles; zoom and receding titles; turn-around and silhouette effects, etc.

Amer. Bolex Co., New York City.

Craig Projecto Editor \$49.50
A professional-like 16mm film inspecting and editing apparatus that shows film image in action on brilliant miniature screen. Allows careful inspection of film at any speed—slow motion or fast. Mounted complete on attractive wooden base with Craig Senior Splicer and pair of geared rewinds. Same device for 8mm films but with Craig Junior Splicer and Rewind combination, \$27.50.

Craig Movie Supply
Los Angeles, Calif.

Turrets \$28.00
Custom-built turret fronts for Keystone 8mm and 16mm cameras. A guaranteed precision job.

MacFan Mfg. Co., San Diego, Calif.

Dissolving Shutter \$75.00
 A custom-built automatic dissolving shutter fitted on 16mm Victor, Filmo 70-D or 70-DA, and Bolex 8mm and 16mm cameras that opens or closes automatically at the touch of a button. Produces smooth fades and accurately aligned and exposed dissolves.
 MacFan Mfg. Co., San Diego, Calif.

Dallmeyer Telephoto \$73.00
 A fine 4" F/3.5 telephoto lens famed for quality and definition. An ideal "extra" for any 16mm camera.
 Medo, New York City, N. Y.

Exposure Meter \$21.00
 General Electric Exposure Meter. Geared for three ranges of lighting, low, medium, and high. Readings from .05 to 1700 foot candles.

Bakelite case. Easy, "one-hand" operation.
 General Electric Co., Schenectady, New York.

Photrix Cine Meter \$22.75
 A guaranteed photo-electric exposure meter for cine camera use. Large, easy-to-read scale. Palm size plastic case.
 Intercontinental Marketing Co., New York City.

Reflex Focuser \$42.00
 For 16mm cameras. Voids parallax between finder and lens. Provides full size ground glass image magnified 10 times. Adaptable to lenses 3" and up. Also useful as extension tube for shorter focus lenses.
 C. P. Goerz Amer. Optical Co., New York City.



Order Your Copy Now . . . !

HOW TO MAKE HOME MOVIE GADGETS \$1 COPY

A new book containing over 100 illustrations and descriptions of handy gadgets any amateur can build for special effects, titling, lighting, photography, etc.

HOME MOVIES
 6060 Sunset Boulevard Hollywood, Calif.



\$9.95
 (Includes a special 200 Watt Hi-Spot Lamp)

REMEMBER *This* XMAS
 with the
F-R HI-SPOT
 HOLLYWOOD TYPE SPOTLIGHT

Here's the spotlight to make any Xmas memorable. Compact, light-in-weight, made of die cast aluminum it possesses power out of proportion to its size and has many features usually found only in larger and more costly equipment. Some of these are: the famous Fresnel lens, finger-tip focusing from a large to a small spot, complete directional control, tripod mounted or adapted to standard light stands, heat dissipating fins and many others. Get glamour, life, vitality in every picture by using the F-R HI-SPOT — photography's finest spotlight buy for both still and movie camera users.

F-R CINE *Action* EDITOR
 FOR 16 MM MOVIE FILM

This editor, patterned after Hollywood standards, is another reason to make this a real Merry Xmas — for now you can edit your movie films in a professional manner. Many new and special features make editing the "F-R way" more efficient, more enjoyable and less costly. Examine it yourself and see: films edited while actually moving or stopped for prolonged inspection • smooth, continuous viewing of films magnified four times original size • simplicity in operation (just place it between two rewinds) • high efficiency though using low wattage lamp which gives all the essential illumination without excessive heat. "Foreword" to "Finis" be proud of your pictures.

F-R brings these and many other fine F-R Products, acknowledged among photography's finest, to eager photographers everywhere. Whether you buy them for yourself or for someone you are most anxious to please—this will be the Christmas to remember. At leading dealers everywhere.



\$7.95

For Christmas
MAKE SURE OF PERFECT PICTURES



Ask Santa
FOR THE
NEW
G-E EXPOSURE METER

Here's a sure, easy way to get better movies . . . sparkling "stills" . . . beautiful color! A way to avoid wasted film . . . or loss of precious scenes because you guessed wrong! The new G-E exposure meter gives you correct exposure every time.

3 METERS IN ONE

- an exposure meter that helps you take shots you're proud of
- a darkroom meter that makes printing, enlarging, duplicating easier
- a light meter that makes it easier to balance indoor lighting for better pictures . . . better color

NOTE THESE FEATURES

Rapid one-hand operation with positive finger-tip control of exposure calculator. Extreme sensitivity . . . measures three ranges of light (bright, medium, dim) . . . lets you use exclusive new "incident light" method used in Hollywood. *Amazing accuracy* . . . so important to color. Sharply directional measurement in ultra-brilliant snow or sunlight . . . your meter sees what the camera sees. *Exceptional sturdiness* . . . won't be thrown off by rough handling or tropic humidity. And most important of all, it's made by General Electric. Price \$21, at good photographic dealers everywhere. General Electric, Schenectady, N. Y.

GENERAL ELECTRIC
606-20

Christmas Scenario . . .

• Continued from Page 583

watches children move toward door. He starts to move toward camera (toward tree out of scene). Stops suddenly as he remembers packages are in broom closet.

Scene 28: Closeup of packages in broom closet.

Scene 29: Back to scene 27. Dad turns excitedly towards children and calls them back.

Scene 28A: Same as scene 26. Children about to enter kitchen. Turn toward camera upon hearing Dad's words, then retrace steps (toward camera).

Scene 29A: Medium long shot of room. Dad hurries past children, enters kitchen.

Scene 30: Closeup of children as they nudge one another and look quizzically at Dad as he leaves room.

Scene 31: Back to scene 29. Dad re-enters room with broom and dustpan.

Scene 32: Same as scene 19. Dad sweeping up ornament.

Scene 33: Same as scene 30. Mother enters scene and herds children off to bed.

Scene 34: Back to scene 32 as Dad starts for kitchen with dustpan laden with broken ornament.

Scene 35: Medium closeup of children's faces as they kneel at bedside in prayer. One of them lifts up his face toward ceiling as he says:

TITLE: ". . . and please, God, don't let daddy break my toys."

Scene 36: Back to scene 35 as child finishes prayer simultaneously with others. Cut as children start to climb into bed.

Scene 37: Closeup of one child, now in bed and under covers, sitting up suddenly and reaching for alarm clock. Taking it in his hands he sets alarm for 6 o'clock.

Scene 38: Ultra closeup of face of clock, showing alarm hand being set for 6 o'clock.

Scene 39: Medium shot of Dad standing near kitchen table with presents stacked about him. Before him is an open package. He is holding toy train in

hands, spinning the wheels, etc.

Scene 40: Medium closeup of Mother entering door to kitchen. As she spies Dad playing with train, she admonishes him to put it down, etc.

Scene 41: Same as scene 39. Upon hearing Mother, Dad places train in box just as Mother enters scene. She hands him some ribbon and wrapping paper, and both proceed to wrap presents.

Scene 42: Same as scene 37, except medium shot. One of the children suddenly sits up in bed, switches on light. Others awake and look quizzically toward him. He speaks:

TITLE: "Let's put Mother's and Dad's presents under the tree!"

Scene 43: Back to scene 42 as child finishes speech. Other children nod assent and they clamber cautiously out of bed and start for door.

Scene 44: Closeup of children's feet tip-toeing to Christmas tree.

Scene 45: Same as scene 41. Dad trying to do up packages in clumsy fashion. He's all thumbs, and as he tries to tie a knot he sticks his tongue out, etc. The toy train is in an open package in the foreground, and Dad steals a yearning glance toward it. But remembering Mother's watchful eye, he proceeds with his wrapping.

Scene 46: Medium closeup of some of children cautiously placing parents' presents under tree and then hastily retreating toward bedroom.

Scene 47: Medium shot of one child putting something into Mother's and Dad's stockings over the fireplace, then suddenly dart out of the scene toward bedroom.

Scene 48: Medium long shot. Mother and Dad enter living room loaded with wrapped gifts. Proceed to tree. As Dad nears fireplace he spies bulge in his sock over fireplace. Feels of it. Then looks around to see if Mother is watching.

Scene 49: Closeup of

Dad — same business as above. He reaches into sock and brings out a huge red apple. Expresses delight and bites into it.

Scene 50: Medium closeup of Mother, kneeling on floor and arranging presents beneath tree. Looks up towards Dad. Sees him eating, and gives him a disgusting look, etc.

Scene 51: Same as scene 48. Mother arises from floor. Tells Dad to distribute presents beneath tree. She exits from scene.

Scene 52: Closeup of Dad as he spies toy train in open box beneath tree. Looks cautiously around to make sure Mother isn't looking, then removes train and starts putting it together.

Scene 53: Another closeup of Dad lying on floor, engrossed in putting toy train together. Startled by Mother's re-entrance to room (out of scene) he rolls over, dropping train, and faces toward her.

Scene 54: Medium shot, from low camera angle, of Mother as she re-enters room with more packages. Looks down toward Dad with a sigh of exasperation.

Scene 55: Back to scene 53. Dad starts to explain: Speaks—

TITLE: "I only want to see if all the parts are here . . ."

Scene 56: Back to scene 54 as Mother says, "Humph" and proceeds toward tree (out of scene).

Scene 57: Medium shot. Mother placing remaining gifts around tree. Dad, having returned train to box, arising, yawns, scratches head, and walks slowly out of room.

Scene 58: Interior of Dad's bedroom. Dad lays pajamas out on bed. Sits on edge of bed and cups chin in hands as he stares into space. With a deep sigh, he starts to unlace shoes. Fade-out.

Scene 59: Fade-in. Closeup of clock showing time — 10:00 o'clock. Dissolve into same clock showing time — 12:00 o'clock.

Scene 60: Medium closeup of Dad dressed in pajamas, lying on floor in front of Christmas tree, and playing with train. The track is now fully assembled and Dad has the train running.

Scene 61: Closeup of

train as it jumps track and turns over.

Scene 62: Medium shot of Mother, in bed, as she hears noise in living room. She slips out of bed and into slippers and robe and exits from room.

Scene 63: Medium shot of mother as she appears in living room door and looking down at Dad with a threatening expression.

Scene 64: Semi-closeup of Dad as he looks up suddenly at Mother. Sheepish grin appears on face and he starts to explain. Speaks:

TITLE: "I'm just checking to make sure everything's running all right."

Scene 65: Back to scene 64 as Dad finishes speaking.

Scene 66: Flashback to scene 63 as Mother says "Oh Yeah?!"

TITLE: "Oh Yeah?!"

Scene 67: Back to scene 65 as Dad starts to arise. Fade-out.

Scene 68: Fade-in. Close-up of alarm clock set at 6 o'clock and alarm ringing. Hand enters scene and shuts off alarm.

Scene 69: Interior of chil-

dren's bedroom. As child shuts off alarm, others jump out of bed and all dash out of room.

Scene 70: Medium shot of youngsters dashing into living room and running towards tree. As they reach tree each searches excitedly for the toys and presents that are his.

Scene 71: Medium close-up of Dad entering living room, yawning and tying his robe. He walks sleepily toward children grouped about tree.

Scene 72: Medium shot of children and Mother seated on floor in front of tree. As Dad enters scene, mother hands him a package. Dad sits down before opening it. He starts to untie package, then spies train. Hesitating a moment, he nonchalantly reaches for an apple, bites into it, and then reaches for train, taking it out of hands of son.

Scene 73: Medium close-up of Son as train leaves his hands. He pouts. Then spying partly opened package in Dad's lap, picks it up and vainly offers it to Dad,

GIVE YOURSELF A GRAPHIC

UNLESS you are already the proud possessor of a Speed Graphic, you have certainly wanted one. You've wanted to give your picture-making ability full scope by having at your command the performance of this camera's 1000th-second focal plane shutter; its 400th-second Kodak Supermatic, the world's finest between-the-lens shutter; both capitalizing on its superb f/3.7 Kodak Ektar lens. And you've wanted to be able to work with the many emulsions available in sheet film, roll film, film packs, and plates.

This brilliant new 2 1/4 x 3 1/4 model, for \$132, makes all this possible... See your dealer now — then give yourself a Graphic.

Graphic and Graflex cameras are made by the Folmer Graflex Corporation

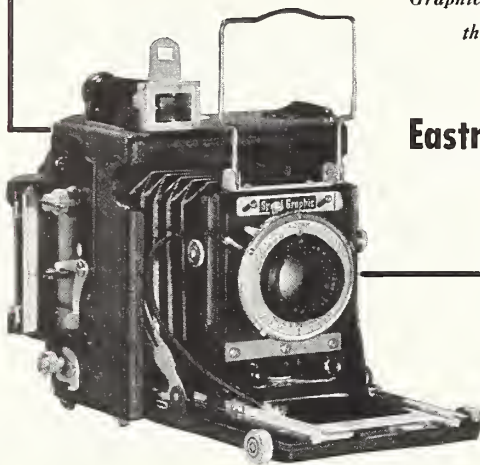

Eastman Kodak Company
Rochester, N. Y.

HOW TO MAKE YOUR CAMERA SELF-SUPPORTING

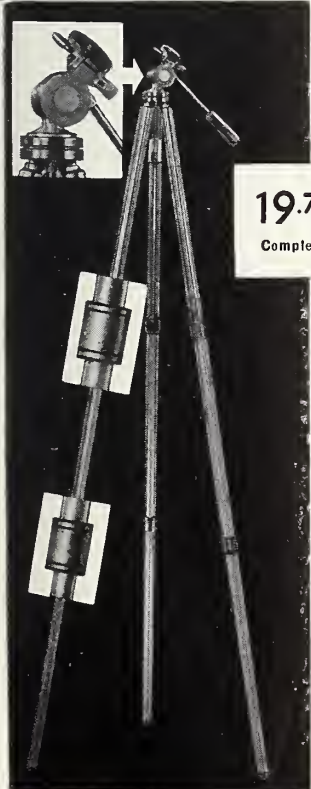

19.75
Complete

← Royal De Luxe New Automatic Leg-Locking Aluminum Tripod . . .

Extremely light weight only 3 1/2 lbs., without top, yet amazingly rigid tripod. Features new automatic device for locking and unlocking legs instantaneously at any height and new, smooth-action pan and tilt top. This top has a new single lever control for panning and tilting, and a new lock for rapid mounting of camera. Anodized mar-proof finish. Extends to 60"; folds to 26". Tripod only \$15. Top only, \$7.50. Complete, (Tripod and Top), \$19.75.

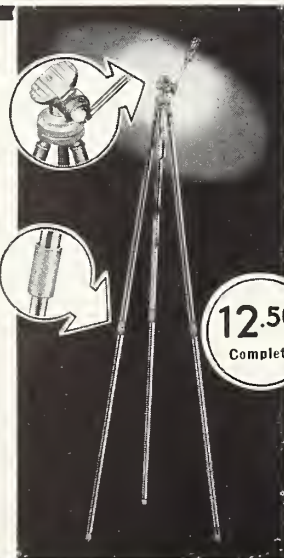

12.50
Complete

← The Royal Tripod

Holds heaviest movie or finest miniature camera without a quiver. Legs are instantly adjustable by means of "Quick-Lock" friction control. Rubber tips. Chromium finish. Opens to 56", closes to 30". With Tilt Top, \$12.50.

Foldex →

Compact Collapsible Aluminum Tripod . . .

Each leg snaps into position instantly and automatically by simply pressing a catch. Rigid, vibrationless support. Anodized finish. Price, only . . . \$5.95.

See these Tripods today at your dealer



Legs Open Automatically

Weights only 1 3/4 lbs.

\$5.95

ALBERT



SPECIALTY CO.

NEW YORK • CHICAGO • LOS ANGELES
Main Office and Factory: 231 S. Green Street, Chicago

Get Ready..!

● Home Movies' 1941 Annual Amateur Contest starts January 1st . . . closes September 30, 1941. Open to all amateur-produced 8mm and 16mm films, it is America's most important contest for amateurs which each year brings the famed Lloyd Bacon Trophy to the producer of the best picture.

● *Twelve other prizes and achievement awards make this contest attractive to seasoned and beginning movie amateurs alike. Every amateur is eligible to compete and enter one or more films. It's an opportunity to attain nation-wide recognition; to match talents with other amateurs. You do not have to be a subscriber to HOME MOVIES in order to compete.*

● In addition to the awards for best pictures produced in each class, special trophies will be awarded for outstanding achievement in photography, editing, titling, and technical accomplishment. A complete list of prizes will be announced in February.

● *Don't wait until the final weeks to submit your films. Although closing date of the contest has been advanced this year to September 30th for benefit of those wishing to enter films produced during summer vacations, other films should be submitted as soon as completed. They will be reviewed, judged, and graded and returned promptly.*

● Entries limited to amateur-produced 8mm and 16mm films. Transportation must be paid both ways by entrant. Film reels and containers should be labeled with name and address of entrant. No entry blanks are necessary. Enclose data with film as to camera and equipment used. Submit as many entries as you wish.

HOME MOVIES

H O L L Y W O O D ' S M A G A Z I N E F O R T H E A M A T E U R

TYPICAL Peerless VALUES

WRITE FOR COMPLETE CATALOG "A"

Filmo Sportster, f2.5, 4 speeds, L.N. \$52.50
 Filmo Companion, f3.5, 4 speeds, like new. 37.50
 Levere Double 8, f2.5, 5 speeds, like new. 159.00
 Bolex Sum, f1.9, like new. 17.50
 Kodascope 8, Model 20, used. 49.50
 Bell & Howell 12.2, 8mm Projector, L. N. 94.00
 Levere 8, 500W Projector, new. 60.00
 Cine Kodak Magazine, f1.9, like new. 49.50
 Cine Kodak Magazine, f1.9, like new. 49.50
 Bolex H16, 1" f1.4 Hektor, 14mm W. A. 298.00
 Victor 5, 1" f1.5 Kinetoplast, 2" f3.5 149.50
 Bell & Howell 70D with 1" f1.5 Wollensak, like new. 97.00
 Bolex H16, 1" f1.5 Primoplan, 15mm W. A. 269.00
 Trioplan, Case, like new. 48.00
 Kodascope EE, f2.5, 750W Projector, L. N. 89.50
 Kodascope G, f1.8, 750W Pro., L. N. 111.00
 Bell-Howell Filmaster, 750W Projector, L. N. 207.00
 Ampro Sound X, 750W Projector, Box Screen 7.25
 30"x40" Crystal Beaded Tripod Screen 5.95

FREE PHOTO UTILITY RULER

PEERLESS CAMERA STORES, Inc.
 East 44th Street : New York, N. Y.

8mm SLITTER
 Perfectly 16mm width film to exact 8mm width. Die cast body with hardened steel cutting wheels. New price, each, \$2.50.

DEVELOPING RACKS
 Stainless steel take 30 feet 16mm or 8mm width film. Can be used in 11x14 or 8x10 flat trays respectively. Complete with loading and, each, \$6.75. Specify type wanted.

At Your Dealer's or Direct

J. C. Haile & Sons
 Motion Picture Dept.
 5 Walnut Street Cincinnati, Ohio

THIS XMAS MORN LOAD WITH ONYX HI-SPEED FILM

100 ft. 16mm.....\$5.25
 25 ft. 8/8mm.....1.60
 30 ft. Univex.....1.10

Rating of 50
 Reversal Free of Charge

Write for price list of all types and grades of film. Processing chemicals for Home use.

KENWOOD FILMS
 1231 E. 46th St. Chicago, Ill.

MR. 16mm PRODUCER
 We offer you complete facilities for adding

SOUND

BLACK & WHITE • KODACHROME
 SPECIAL EFFECTS • ART TITLES

GEO. W. COLBURN
 LABORATORY
 97-A Merchandise Mart CHICAGO

IN PHILADELPHIA

CAMERAS
 and Everything Photographic

KLEIN & GOODMAN
 18 S. 10th STREET

hoping he'll return his train. Boy speaks:

TITLE: "Here, Dad — this is your present . . ."

Scene 74: Back to scene 73 as boy finishes speech.

Scene 75: Dad returns train to son apologetically, then, feeling a queer pain in stomach, looks momentarily at apple in his hand, then clutches abdomen in pain.

Scene 76: Medium shot. Children and Mother looking inquiringly at Dad. Mother arises, goes over to Dad and helps him to near-by couch. Children gather about him inquiringly.

Scene 77: Medium close-up of Dad lying on couch. Children gathered about him. Mother enters scene with glass of water, spoon, and bicarbonate of soda. Mixes soda in water and gives to Dad.

Scene 78: Closeup of son watching Dad, looks at child next to him and says:

TITLE: Gee—Christmas sure is hard on Daddy."

Scene 79: Back to scene 78 as son finishes speaking. Suddenly realizes he has toy train in arms, looks toward Dad with knowing look, then dashes away to play with train on track beneath tree. Fade-out.

TITLE: "The End."

Reader Speaks

• Continued from Page 572

tance of the emulsion. In actual photography, all points of focus are not in the same plane, therefore, that principal subject which is in focus will have a smaller circle of confusion than those which are either ahead or behind the focus.

Consider that emulsion B is placed at the proper focal length and the rays of light

TO OUR READERS

We will appreciate calling our attention to any misleading claim made by any advertiser in HOME MOVIES whose product or service proves unsatisfactory.

Should an article prove other than advertised or if a service is not prompt, immediate notification will enable us to enforce upon the advertiser necessity of adjusting his product or service to the maximum high standard of quality required by this publication of its advertisers.

JUDGE SOLAR VALUE BY PROJECTION PRINT QUALITY

FOR SALON AND EXHIBITION PRINTS

Your first Solar Enlargement will prove a thrilling experience. Your most commonplace negatives are transformed to pictorial gems in Solar's perfected light and optical system. Your prints will sparkle with brilliance and contrast—from deep rich blacks to clear sparkling highlights.

In addition to Solar's perfected light and optical system with its adjustable double condensers, you get these extra features; horizontal or vertical projection; instant conversion to a view, copy or portrait camera and adaptability for use as a copy stand. See a Solar before you buy. Prices start at \$34.50.

ENLARGING TREATISE FREE

Prepared by experts and written in the amateur's own language. 36 pages, profusely illustrated. Tells you how to produce perfect enlargements—gives valuable tips on dodging, double printing, diffusing, etc. Answers every problem in enlarging to the mounting of your prints. Every amateur should have a copy. Valuable Enlarging Treatise HM1240. Free.

BURKE & JAMES, Inc., (EST. 1897) 223 W. Madison St. Chicago

"Professional" Fades, Wipes and Vignettes

ADAPTERS TO FIT ALL LENSES

WIPE-DISC

VIGNETTER

FADE-DISC

TIMED AND OPERATED BY CLOCKWORK MECHANISM

In personal movies, scene transitions, i.e. the change from one scene to another, are important for continuity and greater interest. Fade-ins, fade-outs, lap-dissolves (with back-winding cameras) and real wipe effects are easy if you own a Ciné-Transito, Jr. Small, compact, light . . . efficient and ever-ready.

Complete with cable release, fade disc, wipe disc, vignetter, and lens adapter. **\$14.85**

BAIA CINÉ-TRANSITO, JR.

See your dealer, or order direct!

AMERICAN BOLEX COMPANY, Inc.
 155 East 44th Street • New York City

Tie a string around your finger!

— remember the big

ANNUAL BEGINNERS' NUMBER*

of

HOME MOVIES!

Off the Press January 1st, 1941

The big issue devoted each year to problems of the beginning amateur. Chock full of movie making information to start the new cinecameraist off on the right foot! Scores of helpful articles written by expert cinefilmmers! Pages of new ideas for making gadgets for filming, processing, editing and titling home movies!

The other 11 issues during 1941 will be equally important; but DON'T miss the January issue — the big, super BEGINNERS' NUMBER!

Better put a \$2.00 check or money-order in the mail today for your 12 months' subscription for 1941! (\$3.00 for Canadian and Foreign subscriptions.)

*Just 19,000 copies will be printed. Be sure to reserve yours!

VERHALEN PUBLICATIONS
 6060 SUNSET BLVD. HOLLYWOOD, CALIF.

I'm glad I discovered...

KIN-O-LUX No. 3 Gold Seal

writes still another new user of this FINER movie film for indoor use (and other occasions except bright sunlight).



NO OUTDOOR RATINGS

RATINGS

WESTON TUNGSTEN 100 SCHEINER TUNGSTEN 29°

"Now," he continues, "I get even finer results than ever before — yet it costs me less. At last I'm satisfied." And he'll continue to be so—for KIN-O-LUX No. 3 with its Super Pan Emulsion and speed offers wide latitude and exceptionally fine grain. For outdoor use or for any movie making — there is a KIN-O-LUX film to give you better results — and save you money. Ask for KIN-O-LUX by name. Insist on it. If your dealer is out of stock — write directly to Dept. B-11. 100 ft. \$6.00, 50 ft. \$3.50. (All prices include processing, scratchproofing and return postage.)

Other KIN-O-LUX Movie Films are:

KIN-O-LUX No. 1 (Weston 8, Scheiner 18°) 100 foot \$3.00; KIN-O-LUX No. 2 (Weston 12, Scheiner 20°) 100 foot \$3.50; KIN-O-LUX No. 3 (Weston 50 Tung. 40, Scheiner 26° Tung. 24°) 100 foot \$6.00.

ECONOMY • RELIABILITY • FINER RESULTS

KIN-O-LUX, INC.

105 West 40th Street New York City

come to a smaller point of focus. Notice how emulsion C intercepts them before they have been allowed to complete that focus, resulting in a large circle of confusion. Also emulsion A, getting the rays of light after they have been allowed to focus at B and crossing in the pathway of the dotted lines, will create a circle of confusion as large

as that on emulsion C if the distance is the same.

By using a smaller diaphragm opening, we may reduce the angle or the pencil of light thereby retaining more definition by keeping the circles smaller. A wide aperture, admitting a larger pencil of light will introduce stray rays around the periphery destroying the circles in the outer field

to the extent that the central subject even though in focus, will suffer from blur.

The article in HOME MOVIES gives the method of demonstrating this blur to extremes by enlarging the circles. The candle flame points represent separate points of focus, and therefore should be used as described.

Dr. A. K. Baumgardner.

Lighting teaching film productions . . .

• Continued from Page 600

for the same reason that makes it a problem to the amateur. We had plenty of lighting equipment. But the films were to be shot in the studios of the artists who were to be featured. And in no case were these studios wired for more than 30 amperes, using all available lines. In other words, we would have to use the same types of photo-flood equipment available to the amateur.

Most amateur indoor shots are under-lit — dependence is placed on fast film and f:1.9 lenses to achieve full exposure. But, while this is satisfactory for close-ups, and scenes containing little movement, it would not do for teaching films. Some of our shots were 15 feet from the camera, some only 1 foot away. In order for the lighting in all these takes to match, so that they could be freely edited and intercut, a large area had to be lighted. And this is important — it had to be lighted brightly enough to be shot between f:8 and f:11, in order to get sufficient depth of focus to permit the demonstrator to move around freely.

The usual procedure of the inexperienced when faced by this problem is to pile all available light on the subject, saving perhaps one light for a back or side light. The general result is something like figure 4, which is a preliminary still made for the first film — the one on silk screen printing. Made with a Speed Graphic and two flashbulbs, the lighting here parallels exactly the usual amateur lighting with only two powerful units of limited carrying power.

The most obvious flaw

in this picture is the background. With only the spill light from the lamps on it,

it has a tendency to break up into a mass of dim, confusing spots. Thus the pic-

EXPOSURE TABLES FOR PHOTOFLOOD LAMPS										
For Use With Good Reflectors										
Photoflood Lamps	Distance Lamps Subject in Feet	*Diaphragm opening for films with Weston Mazda speeds of:								
		3	5	6	8	12	16	20	40	64
One No. 1 Lamp	3½	...	f2.8	...	f3.5	f4.5	f5.6	f6.3
	4	...	f2.8	...	f3.5	f4.5	f5.6	f6.3
	4½	f1.9	f8
	5	f2.8	f6.3	f8
	5½	f1.5	f1.9	f3.5	...	f5.6	...
	6	f1.9	...	f2.8	...	f3.5	...	f6.3
	6½	f1.9	...	f2.8	...	f4.5	f5.6
	7	...	f1.5	f5.6
	7½	f1.5	f4.5
	8	f1.9	...	f2.8	...	f3.5
	8½	f1.5	...	f1.9
9	f1.9	...	f1.9	...	
10	f1.9	...	f2.8	
11	f1.5	f3.5	
Two No. 1's or One No. 2 or One No. R2	3½	f3.5	f4.5	f5.6	f6.3	f8	f8	f11
	4	f3.5	f4.5	f5.6	f6.3	f8	f8	f11
	4½	f2.8	f5.6	f6.3	f8	f11
	5	...	f3.5	...	f5.6	f6.3	f8	f11
	5½	f1.9	f2.8	f3.5	...	f5.6	f6.3	f8
	6	...	f2.8	f4.5	f5.6	f8
	6½	f2.8	f3.5	f4.5	f6.3	f8	...
	7	f1.5	f1.9	...	f2.8	f3.5	f4.5	f5.6	f6.3	...
	8	f3.5	f4.5	f5.6	f6.3	...
	8½	...	f1.9	f1.9	...	f2.8	f3.5	f4.5	f5.6	...
	9	f1.9	f1.9	...	f2.8	f3.5	f4.5	...
10	...	f1.5	f1.9	f3.5	f4.5	
11	f1.5	f3.5	
12	f1.9	f3.5	
13	f1.9	...	f2.8	
14	f1.9	...	
15	f2.8	
16	f1.5	f3.5	
Three No. 1's or One No. 2 and One No. 1	3½	...	f4.5	f5.6	f6.3	f8	f8	f11	...	f16
	4	...	f4.5	f5.6	f6.3	f8	f8	f11	...	f16
	4½	f3.5	f5.6	f6.3	f8	f11
	5	f2.8	f5.6	f6.3	f8	f11
	5½	...	f3.5	f4.5	...	f5.6	f6.3	f8
	6	...	f3.5	f4.5	...	f5.6	f6.3	f8
	6½	f1.9	f2.8	f3.5	f4.5	f4.5	f5.6	f8
	7	...	f2.8	...	f3.5	f4.5	f5.6	f8
	7½	f1.5	f1.9	...	f2.8	f3.5	f4.5	f5.6	f8	...
	8	f2.8	f3.5	f4.5	f5.6	f8	...
	8½	...	f1.9	f1.9	...	f2.8	f3.5	f4.5	f5.6	...
9	f2.8	f3.5	f4.5	f5.6	...	
10	f1.9	f4.5	f5.6	
11	f4.5	
12	...	f1.5	...	f1.9	
13	f2.8	
14	f1.5	
15	f2.8	
16	f1.5	f3.5	
Four No. 1's or Two No. 2's or Two No. R2's or One No. 2 and Two No. 1's or One No. 4	3½	...	f4.5	f5.6	f6.3	...	f11	f11	f16	...
	4	...	f3.5	...	f6.3	f8
	4½	f5.6	f6.3	f8	f16
	5	...	f4.5	f6.3	f8
	5½	...	f4.5	f4.5	...	f5.6	f6.3
	6	f2.8	f3.5	f5.6	f6.3
	6½	f6.3
	7	f3.5	f5.6	f11
	7½	...	f2.8	f4.5
	8	f3.5	f5.6	f8
	8½	f1.9	f2.8	...	f3.5	f4.5	f4.5	f5.6	f6.3	...
9	f2.8	f3.5	f4.5	f4.5	f5.6	f6.3	...	
10	...	f1.5	f2.8	f3.5	...	f5.6	f8	
11	f6.3	
12	f1.9	f3.5	...	f4.5	f5.6	
13	f5.6	
14	...	f1.5	...	f1.9	
15	f1.5	f3.5	
17	f1.9	f3.5	
18	f4.5	

*For Weston speeds of popular films refer to Exposure Meter Guide on another page. (See table of contents). This data based on interiors and subject of medium color. For light colored subjects and interiors close diaphragm one-half stop. For dark colored subjects and interiors open diaphragm one-half stop.

SPEND CHRISTMAS
in
Wonderland!



Give yourself, your family, your friends, a swell Christmas treat! Take them with Alice to Wonderland. Or join a tiger hunt in Bengal. Or show the kids the zoo — without taking a step!

"ALICE IN WONDERLAND," 1 Reel
Gorgeous fantasy. In all her b'onde loveliness, Joan Bennett plays Alice. Music by Irving Berlin. More delightful to see than it ever was to read!

"TIGER HUNT IN BENGAL," 1 Reel
Completely authentic. Fascinating picture of an actual tiger hunt in India. You'll thrill to every second!

"ZOO IN MANHATTAN," 1 Reel
A 10-minute stroll through New York's famous Central Park Zoo. Lions, tigers, monkeys, elephants — the whole animal kingdom. An education for the kids and an absorbing 10 minutes for you!

Each of these may be had in
16mm, with sound \$17.50
16mm, silent 12.00
8mm 7.50

Sold by dealers everywhere. If your dealer cannot supply you, write to

NU-ART FILMS, INC.

145 W. Forty-fifth St. New York, N. Y.

ture tends to make what is really a well lighted studio appear like a dim, dingy attic. Imagine a similar lighting used in a film staged in a modern apartment — or, worse yet, a hospital room.

Here, then, we have the cardinal principle of modern interior lighting. If the background is to be black, as in a dramatic film, it must be completely black. If not, and in all cases in commercial and educational film, the background *must* be lit as well as the subject.

Now the problem arises — how to light a large room with sufficient brilliance to shoot about f:8 and not use more than 25 amperes of current. Bunching all lights near the camera won't do it. The more light piled on, the more detail will be burned out of near objects, without noticeably increasing the brightness of the background. It's quite obvious that near objects will always be brighter than those far from the lamps, regardless of how bright the lamps are and how efficient the reflectors.

The answer is really simple — the trick is to spread the lights. Not indiscriminately; no light can be wasted. Every light must do its work. But try this simple experiment. Arrange a close-up at one end of a long room. Light it bright enough to get a meter reading of, say, f:5.6. Chances are that two No. 2 photofloods will do it. Now take a third No. 2 on an extension cord and bring it down to the other end of the room, out of the view of the camera but illuminating that part of the background that shows in the finder. Move it in till your exposure meter reads f:5.6 on the wall. Now shoot the scene and when it is returned from the processing station you'll find you've apparently lit a 20- or 30-foot room from end to end with but three No. 2 photofloods.

This applies mainly to close-ups. With 3/4 or full-length shots, some additional lighting must be done. When all the lights are up on stands the floor and bottom parts of objects in the picture suffer the same falling off of illumination as does the background. The picture gets darker toward the bottom. Furniture ap-

parently stands in pools of ink — black shadows. Obviously the cure is the same. Individual lighting must be applied to the bottom of the scene.

Now that we have the entire scene lit to the same intensity, some means must be found to separate the subject from the background. Either back or edge light is used. Edge lighting is simpler: just a single flood bulb parallel to the scene, striking the subject from the side. Either one side or both may be so lit. It is not necessary, surprisingly enough, for this light to be very strong. A burnt-out high-light around the subject is not essential to modeling. Just enough sidelight to give a plastic roundness to the subject is all that is needed.

What about spotlights? They are the most misused tool in photography. Yet, properly used, they work wonders. No matter how carefully a scene is lighted, there is always some spot where one object casts a shadow on another equally important object. This is where the spotlight comes in. Carefully adjusted, it can throw a narrow beam into these shadows, plugging up "holes" in the illumination, without raising the general over-all light level.

By now we seem to have a great many lights on the set and violated our major premise — we were going to light this picture with not more than 25 amperes. Let's look at an actual scene. Fig. 3 is a shot of Sculptor Milton Hebard in our film "The Technique of Plaster Sculpture." It was shot with a still camera placed at the same position as the cine, loaded with the same film and given the same exposure. The data follows:

Camera Speed . . . 16 frames/sec. (1/4 sec.)
Aperture f/11
Film . . Agfa Superpan Supreme

Note first that the background, though not far from the subject, has been separately lighted, just the same. Even a background this close would be quite a lot darker if not separately illuminated. Second, the bottom of the work table and the artist's legs are just as well lit as the top of the scene. Third, the hand with the chisel, though nearer the

CHRISTMAS..



time for Movies!



Get G-E PHOTOFLOODS
for clear, crisp scenes

Precious shots like this may come but once in a lifetime. Get a supply of G-E MAZDA Photoflood lamps now so you'll be ready to catch them this Christmas.

Whether you're shooting color or black and white, G-E Photofloods give you grand results. They are the same high-efficiency type lamps that Hollywood uses . . . built to fit *your* needs. Two popular sizes fit most requirements; No. 1, **15c**; No. 2, **30c**. And for an extra light for special effects, try G-E MAZDA Photoflood No. R-2, **85c**.

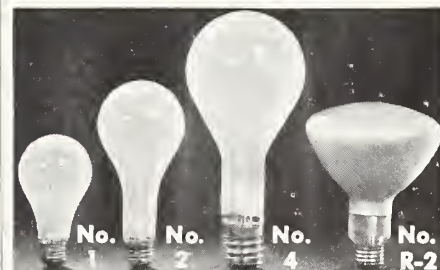

GENERAL ELECTRIC
MAZDA PHOTO LAMPS

Save ON PHOTOGRAPHIC EQUIPMENT

Write for our **FREE CATALOG** no obligation!

Everything you need for the enjoyment of your camera hobby, "Still" or "Movie." **WRITE TODAY!**

SUNNY SCHICK
National Brokers
403 W. WASHINGTON BLVD.
FORT WAYNE, INDIANA

MODERNIZE—Trade in Your Equipment!

100 FT. 16 MM AMBERTINT FILM 200

Includes Machine Processing
Fine grain, rev., safety film. Packed on daylight spool ready to load and shoot.

HOLLYWOOD STUDIOS
"The West's Greatest Film Mail Order House"
Southgate Write for Bulk Film Catalog California

Calif. buyers include sales tax.

The most versatile of all . . . the

CINE Kodak Special

The scientist, teacher, layman all find the possibilities limitless. Bass will send you an illustrated booklet on request and will include his new **CINE BARGAIN-GRAM No. 245.**

Bass CAMERA CO. Dept. H. M.
179 W. MADISON ST. CHICAGO, ILL.



Double
Your
Film
Fun!

Here's the Ideal
**CHRISTMAS GIFT
FOR HOME
MOVIE MAKERS**



Wesco HOME MOVIE SCENARIOS

from the clever-ideo studios of Home Movie Script Service, creators of professional Hollywood "shooting" scripts for omoteur cinematographers.

**CLEVER!
FASCINATING!
AMUSING!**

You Be the Director! Your Home Folk Can Be the Players! EASY to Shoot!

Complete with shooting script, filmed moin title . . . reddy to splice in, with complete set of title cords, reddy for home filming . . . ond clever film props.

HERE ARE A FEW SCRIPTS FOR HOLIDAY PARTIES

TOYS IN STRANGE INTERLUDES, the ideal home movie to film this Christmas. A novel revue of kiddies in Toyland, with Bossboy Junior directing the picture and a Wee Lady the star **\$2.00**

WE TOUR EGYPT. Now you can film exciting "glass shots" and thus bring the illusion of the scenic wonders of Egypt to your own backyard for a travelogue in which your home folks can appear in amusing action **\$5.00**

PICKLE PARTY PRANKS, ideal to film at your New Year's party: **\$1.75**

HOME-E-O and YOU-LI-ET, a real 400-foot comedy, right in the holiday spirit **\$3.00**

Money Back If Not Satisfied

SPECIAL OFFER

Your name, either as producer or cinematographer, on a special credit card which can be used in any or all of your reels. **10c**

See Your Dealer or Send for Catalog Listing

OTHER WESCO HOME MOVIE SCENARIOS.

HOME MOVIE SCRIPT SERVICE

331 TURK ST., SAN FRANCISCO, CALIF.

light than the left hand is the same tone. The left hand was lit with a spotlight to accomplish this. Rim lighting, as previously pointed out, is present but not too obvious, except on the seat of the chair, where its reflection shows. Otherwise it just helps to model the edges of the subject. No one light, for that matter, is obvious. An even blend is the goal.

Figure 2 is a similar shot, except that here the model of the cat threw a shadow on the arm holding the chisel, and a spotlight was used to fill in the hole in the illumination. The work table had been moved out from the background to permit the sculptor to walk around it, yet due to its separate lighting the background remains the same tone.

Now, specifically, how were these scenes lit? Figure 1 shows the exact setup, and was photographed

during production conditions. At the extreme left may be seen a tall stand carrying the biggest reflector—an 18-inch bowl with a No. 4 photoflood. This serves for general or foundation light. Due to its power, it need not be placed very close to the set, and therefore its beam spreads to cover the entire scene quite evenly.

Next is a lower stand with one bowl reflector carrying a No. 2 photoflood. This is directed at the artist and the block of plaster to be carved.

On the floor is a clip reflector carrying a No. 2 photoflood. This serves two functions. The direct light from this lamp floods the lower part of the scene to balance out the top lighting. In addition, since it is in quite close and to the side, the spill light from the reflector serves to edge light

the artist's back. This light, incidentally, is clipped to the top of an unused reflector—a handy way to get a light down lower than the usual stand will permit.

Next is a photoflood spotlight, carrying a No. 1 photoflood. While not very powerful, this spot is excellent for filling in small dark shadows.

Finally, at the extreme right, another clip unit, directed away from the camera onto the background. This is the all important background light, and no more fuss than that.

Now, the score:

One No. 4 photoflood	8.8 amperes
Three No. 2 photofloods (4.4 amp. each)	13.2 amperes
One No. 1 photoflood	2.2 amperes
	<hr/> 24.2 amperes

Which is a current load that can be drawn almost anywhere, even in a small apartment.

Zone lighting for cine photography

• Continued from Page 592

effect and is to be avoided except for special effects. This describes briefly the horizontal diagram.

The vertical diagram is made up of the same zones except that we consider them in vertical positions. Figure 1 illustrates effectively the vertical diagram and the same effects are obtained, in relationship to the subject.

By combining the two diagrams and placing lighting units in proper zones to provide for both diagrams, we can make one unit serve two zones. For example, a light placed in the flat zone horizontal, on the floor will create contrast in the vertical zone. To properly illuminate the subject in the 45 degree zone, the light should be placed 45 degree horizontal and vertical, one light serving for both. To balance, another light can be placed in the opposite 45 degree zone, considering both horizontal and vertical planes. A 45 degree vertical unit can produce contrast by moving it to the contrast horizontal zone. By moving the same unit forward into the flat horizontal zone, there will be less contrast.

This description shows the many possibilities of controlling illumination, and while the zones are to be considered as average positions, by moving the units closer to one zone or the other, we are able to reduce or increase the effect of that particular zone. For instance, if lighting is too flat the unit may be placed closer to the 45 degree or contrast zone, or vice versa.

While it is generally considered good practice to use one unit as a main light source, balancing can be accomplished in the other zones by variation of distance of light to subject. To review simple rules, we know that the intensity of light varies inversely as the square of the distance from the light source. For example, a light unit placed at two feet from the subject delivering 1000 watts is as much light as 4000 watts placed at 4 feet. If the unit which we considered at two feet is moved back to four feet, the intensity will be 1/4 although the light will be distributed over an area four times as great.

Considering also that the angle of incidence is equal

to the angle of reflection, we must avoid placing the units in such position that we set up reflections particularly from flat surfaces. Using one unit as a main source of light, and placing the secondary units at greater distances, we are able to control highlights and shadow and round out the features by the use of slight shading. Figure 1 is drawn especially to illustrate the need of zone lighting, as the subject presents some difficulty if this is not considered. Contrast zones can be used for model

• We want suggestions and ideas for random "backyard" filming; also for simple home movie scenarios. Those which are published will bring the contributors either a 100-ft. 16mm or a 50-ft. 8mm film subject selected from the advertisements in HOME MOVIES magazine.

For ideas that can be adapted to a feature length article we will reward the contributor with two rolls of panchromatic film. Address your suggestions to BACKYARD MOVIES, care of HOME MOVIES, 6060 Sunset Boulevard, Hollywood, Calif.

WE EXTEND

Our Thanks

To the many firms and individuals who have given our product such a fine reception during the past three months. We are deeply appreciative.

• As we approach the Holiday Season, we wish everyone, everywhere, a Happy and Prosperous 1941.

O'SULLIVAN FILM PROCESS

5184
Santa Monica
Boulevard
Hollywood



NEW LOWER PRICES FOR YOUR XMAS MOVIE FILM

ESSCO movie film was always a real bargain. But, just in time for Xmas, we've cut our prices 10 to 15 per cent on the most popular sizes!

	16mm 100 ft.	16mm 50 ft.	8mm 25 ft.
ESSCO No. 8, Weston 8 semi-ortho	\$1.79	\$1.19	
ESSCO No. 12, full ortho, wide latitude, non-halation, Weston 12	1.98	1.39	.98
ESSCO No. 24, extra fast, Weston 24-16, panchromatic, fine grain...	3.69	2.49	1.39
ESSCO No. 100, Pan, non-halo, Weston 100 Tuneston. Not for use in bright daylight	3.98	2.69	1.69

Processing and return postage included. Each roll on daylight loading spool. In metal box and strong carton. 24 hr. processing. ORDER DIRECT FROM THIS AD.

ESSCO FILM PRODUCTS
Dept. H.M., 6117 S. Campbell Ave.
CHICAGO, ILL.

For GOOD PICTURES
Ask for



COMPLETE LINE OF 16mm AND 8mm CAMERA AND PROJECTION FILMS
Also large assortment of HOLIDAY SUBJECT FILMS. Write for Holiday Catalog H. At Your Dealer, or Write Direct RIDGFIELD PARK, N. J.

DO FILTER FACTORS FLOOR YOU?

... then ask about the new HARRISON Duraline FILTER SET — 4 Filters, a Holder and Shade to meet 99% of all your requirements. With compact leather case—Easy instructions. New low prices. See them at your dealer today! ... Or write for folder.

HARRISON & HARRISON
Optical Engineers
8351 SANTA MONICA BLVD. HOLLYWOOD, CALIF.

FREE bargain BOOK

First Step to Successful Pictures
Free illustrated catalog, crammed with hundreds of new and used bargains. Lists everything photographic—still and movie cameras, films, lenses, equipment—at tremendous savings. Liberal trade-in allowances. Satisfaction guaranteed or your money back. 10-day trial. Write for your FREE copy—just out. Hurry!

Dept. L-9
CENTRAL CAMERA CO.
230 So. Wabash Ave., Chicago, Ill. Since 1899

secondary lights, as deep shadows would be formed if we used the contrast zone with heavy illumination. Flat zone lighting should be avoided here as depth would be lost.

Figure 3 shows a common photographic subject, but a difficult one to illuminate if we ignore zone lighting. If our main light is directed toward the cake, heavy shadows will be formed on the figure of the girl, unless we place the light up in the 45 degree vertical zone as well as the 45 degree horizontal zone. A secondary light on the opposite side in the same zone could be directed back of the cake on produce depth and remove shadows. If we consider background lighting in this subject, we have three planes in all, making another unit necessary. Unless a dramatic contrast effect is desired each plane should be provided with sufficient direct light. Subjects like this provide interesting material for unusual effects, but such effects must be obtained through proper application of zone lighting to prevent undesirable overtones which easily get out of control if improperly balanced.

A few simple rules for application of the zone system can be established according to their accepted value in professional portraiture. Subjects of various types will photograph better to enhance their features which are most desirable or to suppress those undesirable ones. The contrast zones are often used heavily for subjects with

round fat faces where shadows are produced from the circles of the face, but never where angular features predominate. A sharp nose or chin, or flat cheeks should not be exaggerated with contrast lighting. For normal features, where dramatic effects are desired, contrast lighting can be employed to accent these features, but usually normal features should be photographed with light from the 45 degree zones. Children or adults with thin faces or figures photograph better with flat lighting, with the intention of avoiding all possible contrast.

This subject of zone lighting is intended to apply particularly to black and white photography, the beauty of which is still not a lost art. Black and white expression remains the main interest of many professionals as well as amateurs in spite of the popularity of color. For those who desire to obtain good results economically with black and white photography, the zone system offers a wider range of expression than is ordinarily considered possible. Any application of the idea will show noticeable improvement over haphazard methods. Even with a limited amount of equipment, units wisely placed will perform more efficiently than more units scattered about carelessly. Good reflectors are always advised to increase the efficiency of each unit. Fewer lights with proper reflectors will deliver better light, more evenly distributed and hence more easily controlled.

Build your own equipment

• Continued from Page 587

Emanuel found it necessary to adjust focus of the camera as it approached or retreated from an object so that the scene or principle subject remained in sharp focus throughout the full forward or receding movement of the camera. To accomplish this in the easiest way, Emanuel designed and built the variable focus control shown in photo No. 3 and illustrated in detail in Fig. 4. It consists of a semi-

circular scale plate which fits over the Filmo focusing tube and an indicator arm which is attached to the focusing ring of the camera lens. The indicator arm is so attached to the lens that the pointer is always opposite the corresponding figure on the scale plate. The gadget is readily detachable when its use is not required.

There are several interesting gadgets to be seen



A TELETAR LENS FOR TELEPHOTO SHOTS

Is a Gem of a

CHRISTMAS GIFT

Made in Mounts to Fit
8 and 16mm Cameras

A Telephoto Lens is ideal for long distance shots.

Unrivalled as a gift for your camera-fan friends—and yourself! The new Teletar Lenses perform with amazing brilliance from start to finish. Perfect for anastigmatism, color and special aberration, it brings sharpness to every shot you take... gives a new brilliance and clarity when projected on the screen.

Priced Unbelievably Low!

Teletar Lenses in Focusing Mounts FOR 8MM CAMERAS

1 inch F 3.5	\$18.00
1 1/2 inch F 3.5	24.00

In Mounts to Fit
Keystone, Revere, Revere Turret, Bolex

FOR 16MM CAMERAS

3 inch F 3.5	\$35.00
--------------	---------

In Mounts to Fit
Keystone, Victor, Bolex, Filmo

Please specify the type of mount when ordering.

**MAIL ORDERS FILLED;
WRITE DEPT. H. M. T.**

If It's Photographic You'll Find It at

Willoughbys

32nd St. near 6th Ave., New York
World's Largest Camera Store
Built on Square Dealing





**Tops all Gifts
ON XMAS MORN!**

Watch the camera owner beam with delight when he unwraps that WESTON Exposure Meter. For this is the gift he really wants . . . the gift that will enable him to get correctly exposed pictures every time he uses his still or movie camera. If he's a serious photographer, give him the WESTON Master model . . . but for the beginner, the inexpensive WESTON Junior model meets every need. Makes a gift that will be used and cherished all through the year. WESTON Exposure Meters are sold by leading photographic dealers everywhere. Literature sent on request. Weston Electrical Instrument Corporation, 585 Frelinghuysen Avenue, Newark, N. J.



in photo No. 4, but the illustration is intended to point out two swell ideas every serious amateur will want to adopt for his tripod. The first is the idea of placing uniform inch or footage marks upon the tripod legs which enable the user to extend each leg to a uniform point without guesswork. The second is the oversize adjustment knobs for the tripod legs. Is your tripod equipped with those small "thumb-screw" type adjustment knobs? Then you'll appreciate the ease with which you can adjust a tripod fitted with these newer, man-size knobs. They were turned on a lathe of 1 3/4-inch Dural and shaped as shown in Fig. 6.

Probably more amateurs are deterred from shooting indoor movies for want of lighting equipment or a sufficient quantity. But if they'll follow Emanuel's initiative they'll soon have all the lamps and standards they need, providing of course they have access to a dime store and a lumber yard and can use a hammer, saw, and a soldering iron.

Photo No. 5 shows some of the lighting equipment built by Emanuel. The reflectors of the floodlights were constructed of aluminum saucepans obtained from a dime store. A tin cup, attached as shown in Fig. 2, formed the extension that permitted use of No. 2 Photofloods. Some of the lamps were fitted with "snouts" for controlling the light beam as illustrated in this sketch. These were made of another saucepan with the bottom removed and clamped to the reflector as shown.

Fig. 1 shows construction of the "stove-pipe" spotlight which appears in photo No. 5. Actually a section of stovepipe was used for the housing. A regulation 6-inch spotlight lens was fitted in the front as shown. The rest of the details are self-explanatory.

All lamp standards, as may be noted, are made of wood; and construction details of same appear in Fig. 3. These standards are light, but durable, and readily adjustable to to a height of 7 feet. One of the

adjustment features is demonstrated by Emanuel in photo No. 6.

Photo No. 7 shows the cable terminal and switching panel built for the lighting units. The terminal provides for tapping eight separate light cords to the main power source. There is a fuse for each two outlets. One switch controls the entire panel and a red light indicates when the switch is on—a valuable feature when terminal is placed some distance from the camera or in an adjoining room.

Mentioned earlier were the interior sets constructed by Emanuel in his garage. One of the sets used in his production, "On The Spot" is pictured in photo No. 8. As may be seen, Emanuel's double garage was converted into a "studio" which affords ample room for construction of ordinary room-size sets. Indeed, Emanuel's versatility does not end with the making of gadgets and accessories. He's an A-number-one carpenter, painter, and paperhanger, too, as evidenced by the fine, professional-like sets he builds.

Construction follows the same principles employed in

regulation studio and stage set construction. The frames for the "flats"—the sections used for walls—are made of 1- by 2-inch pine, properly re-inforced at the corners. The frames are covered with canvas drawn tight and tacked. Over this is applied wall-paper to suit requirements of the setting.

Here is an incident that illustrates Emanuel's knack for "pulling rabbits out of a hat" when confronted with a problem. In filming one of the location scenes for "On The Spot," it called for one of three gangsters to fire the revolver that finally snuffs out the life of "Louie," rival gangster, and chief character in the play. Just as Emanuel was set to make this scene, a policeman happened along and held up production with advice that no firearms could be discharged on a city street without first obtaining a police permit—even though blank cartridges were used.

To another, this might have meant changing the script—but not to Emanuel. While the cast and production staff were

Movie of the Month

● Each month the editors of HOME MOVIES select the best picture sent in for analysis and designate it "The Movie of the Month." This movie is given a detailed review and a special leader is awarded the maker.

This award does not affect the eligibility of such films for entry in the annual HOME MOVIES CONTEST. They are automatically entered for rejudging with those films submitted especially for the annual contest. Films awarded the honor of MOVIE OF THE MONTH during past 12 months are:

1940

JANUARY: "The Cauldron," produced by Dr. R. E. Gerstenkorn, Beverly Hills, Calif. A 16mm picture 400 ft. in length.

FEBRUARY: "Whistling Wings," produced by W. H. Nordin, Austin, Minn. A 16mm Kodachrome picture 400 ft. in length.

MARCH: "Checking Off the Budget," produced by B. W. Johnson. An 8mm Kodachrome film 1000 ft. in length.

APRIL: "El Lobo," produced by Demetris Emanuel. A 16mm picture 400 ft. in length.

MAY: "From A to Z," produced by Vernon Altree, Stockton, Calif.

A 16mm Kodachrome film 400 ft. in length.

JUNE: "Peetie," produced by Edmund Turner, Detroit, Mich. A 16mm Animated Cartoon, 400 ft. in length.

JULY: "Song of the Soil," produced by E. C. Denny, Buffalo, N. Y. A 16mm Kodachrome film 800 ft. in length.

AUGUST: "St. Margarets," produced by Gordon MacCormack, Montreal, Canada. A 16mm Kodachrome film 400 ft. in length.

SEPTEMBER: "Angels Are Made of Wood," produced by Herman Bartel, New Rochelle, N. Y. An 8mm Kodachrome film 200 feet in length. (Winner Lloyd Bacon Trophy, 1940 Amateur Contest.)

OCTOBER: "Driftwood," produced by A. O. Jensen, Seattle, Wash. An 8mm Kodachrome film 400 feet in length.

NOVEMBER: "Father's Time," produced by Raymond Fosholdt, Long Beach, Calif. A 16mm picture, 400 feet in length.

DECEMBER: "Spokane and The Inland Empire," produced by Burton Belknap, Spokane, Washington. A 16mm Kodachrome picture, approximately 800 feet in length.

Cine-X Reversal Laboratories

xmas offer

"PLUS+VIOLET" FILM

(Film Speed of 12)

30 ft. Single 8mm on Univex Spool
60c per roll; 2 for \$1.00

25 ft. Dbl. 8, \$1 per roll; 4, \$3.50

100 ft. 16mm \$2.35; 4 rolls \$8.00

— Also —

CLIMATIZED FILM
(Film Speed of 8)

4 100 ft. 16mm rolls, \$6.00

4 25 ft. Dbl. 8mm rolls, \$2.75

4 30 ft. Str. 8mm rolls, \$1.75

**DAYLIGHT LOADING SPOOLS,
PROCESSING and RETURN
POSTAGE INCLUDED**

(Calif. Buyers add 3% Sales Tax)

Film Cost Insured Against Loss or
Damage Until Returned, Processed!

7404 Santa Monica Boulevard

Hollywood, Calif..

GLASS-BEADED

MOVIE SCREENS

Easily Made!

Make your own sparkling beaded screens—at a fraction of their usual cost! Crystal beads can be applied to cloth, cardboard or almost any smooth surface. Complete directions with each pound. (No fractions of pounds sold.)
Glass Beads to cover 20 sq. ft. (1 lb.)
Finest \$1.25
D. GARD, C-10, 54 WEST 74th ST., NEW YORK CITY



WIDE ANGLE LENS ADAPTOR
In Focusing Mount
 Fits 12 1/2mm and 13mm lenses, converting them to wide angle lenses. Doubles size of area photographed.
 Corrected for color and fully guaranteed in all respects. Price \$21.00
 California buyers please include sales tax. Orders will be filled in the order in which they are received.
MacVAN MFG. CO.
 3829 El Cajon Blvd. San Diego, Calif.

NEW ULTRA HIGH SPEED SOLAR MOVIE FILM

Weston 150, Daylight Mazda 110. Wide latitude, fine grain. Non-rotation coating. Even most modern equipment produces unbelievable results using film of this tremendous speed. You get night pictures, theatricals, indoor movies heretofore beyond reach of the amateur! Costs little more than ordinary speed film.
 25 ft. 8mm \$2.25 16mm \$6.00 16mm 50 ft. \$3.50
 YOU EVEN PAY LESS for standard speed SOLAR movie films. Look at these low prices...
 Dbl. 8mm 16mm 16mm 8mm
 Rating 100 ft. 50 ft. 25 ft.
 Solar ECONOMY Outdoor... 8 \$2.50 \$1.75
 Solar SUPER Outdoor... 12 2.95 1.95 \$1.39
 Solar HI-SPEED... 24 5.50 3.25 2.00
 Prices include 24 hour processing at SOLAR laboratories in Chicago, Kansas City, Miami, and Arlington, Calif.
 100 dealers in 201 towns and cities. If your dealer hasn't SOLAR film, ask him to get it for you, or order direct from this ad.
SOLAR CINE PRODUCTS, INC.
 3827 Archer Ave. Dept. 1A Chicago, Ill.

EXPERT PHOTOGRAPHY MADE EASY

Successful photography as a career, for sparetime earnings or as a hobby—made easy through New York Institute Training! Practical, thorough, personal coaching by leading photographers. Fascinating field. Splendid opportunities. Commercial, News, Portrait, Motion Picture, Advertising and Color Photography. Personal Attendance and Home Study Courses. Booklet FREE! N. Y. Institute of Photography, Dept. 114, 10 West 33 Street, New York, N. Y. (30th Year)

FREE
 16mm -- 8mm SILENT AND SOUND-ON-FILM
 RENTAL LIBRARY CATALOGUE
 Films Shipped Anywhere—Large Selection
 Write Today for Your Copy
NATIONAL CINEMA SERVICE
 71 Telegram Sq. New York City

Print Your Own Film Titles
 Photo titles, stationery, greeting cards, bookplates, advertising. Easy rules furnished. Junior Outfits \$8.25 up. Senior \$17 up. Print for Others, Big Profits. Sold direct from factory only. Write for free catalog and all details. Kelsey Presses, W-94, Meriden, Conn.

8 ENLARGED TO 16 REDUCED TO 8
GEO. W. COLBURN LABORATORY
 Special Motion Picture Printing
 1197-A MERCHANDISE MART CHICAGO

MAKE YOUR OWN TITLER!
 For all types of titles, close-up and copy work. Complete kit of finished parts—optically ground lens—easy instructions. Assemble in 15 minutes! Money Back Guarantee. State camera model.
 Distinguive Title Card—"Photography by (your name)"—35c
ONLY \$1.95 IN KIT FORM
 For All 8 or 16 MM CAMERAS
HOLLYWOOD MOVIE SUPPLY COMPANY
 NORTH HOLLYWOOD • CALIFORNIA

discussing the problem, Emanuel disappeared. Almost before they missed him, he was back on the scene with another revolver and a can of talcum powder. But this gun, while it had all the appearances of a 32 calibre revolver, shot lead pellets by compressed air, just like your old "Daisy" air rifle.

Into the barrel Emanuel poured a small quantity of talcum, handed the gun to the actor and cried, "camera!" As the gun was discharged there was no report, but a small puff of talcum shot from the barrel which gave a genuine appearance of smoke. On the screen it looked like the real thing.

Three titling ideas

• Continued from Page 590

a little double-exposure work, you can bring in some sugar-plums dancing above them. "And Mama in her kerchief and I in my cap had just settled down for a long winter's nap." Here is a chance to bring in Mom and Dad as well as the kiddies. A glance at the other verses will offer varied interpretations, and the greater one's imagination, the more interesting such a film can be.

Another type of home movie, and the type most amateurs make, is the travel film. These are nearly all made during the annual vacation. More and more amateurs are using highway signs and road markers as ready made titles for their travel films, for they find that such titles are not only the simplest and easiest to film, but are often the best obtainable. They get away from that "manufactured" look and seem to be more a part of the film itself.

Included in this type are close-ups of any of the various signs one encounters upon a vacation. A title of the name of a town is always more difficult to make and never as "natural" as a brief shot of the sign on the railroad depot or the city limits sign on the highway.

Many Chambers of Commerce have erected large billboards at the outskirts of a town telling of the many advantages of the town. These are usually good examples of what not to shoot, for they are usually much too long for a title, and unless they explain the forthcoming scene or scenes, they have no place in the film. Name posts giving one or two important

facts, such as the elevation of a mountain, the width of a river, are sufficient and worth shooting since no picture can show either of these on the screen.

The third classification of home movies which can easily use the ready made title is the news reel type of picture. Every amateur shoots at one time or another the more popular events and happenings of the home town—a parade, the laying of a corner stone, a big fire, a train wreck, etc. Most of these, unless sensational, are most valuable as soon as they are shot, and since title making does take time, the film is shown again and again before the titles are made, and by the time the amateur does get around to making the necessary captions, he considers the film too old and not now worth titling.

If the event is worth filming, the chances are ten to one that the local paper will carry a full account of it in the next edition. Here is one of the best possible sources for titles of news events—the newspaper. There they are—all printed out—headlines and all. The filmer again uses his small titler and exposes the paragraphs needed for the shots he has taken.

Such procedure has many possibilities, depending upon how the amateur desires to work them. If the event carried a banner headline across the front page, the sequence might begin with the close-up of the newsboy hollering "Wuxtree, wuxtree", and follow this with a close-up of the front page. Following this comes the sub-heads, etc. It isn't



THANK SANTA FOR THESE GIVE-AWAY PRICES

Do Your Christmas Shopping from This Ad!
 Buy everything you need from one reliable source. Make up a complete order and save money on movie film, processing equipment, developing, powders, and accessories. "Home Processing Headquarters" guarantees complete satisfaction or money back. Every item shipped postpaid same day we get your order. Send only 25 percent deposit with order if you prefer, and we'll ship C.O.D. for balance. You save postal charges when you remit in full.

GRAPHICHRROME BULK MOVIE FILM

Type	Size	25'	50'	100'	400'
Graphicchrome Regular	Dbl. 8	.45	.85	1.50	—
	Single 8	—	—	.90	3.50
Weston 8	16mm	—	.65	1.15	4.00
Mazda 3	10mm	—	—	—	4.00
Graphicchrome Plus	Dbl. 8	.65	1.05	1.85	—
	Single 8	—	—	1.10	3.75
Weston 12	16mm	—	.75	1.30	4.65
Mazda 6	—	—	—	—	—
Graphicchrome Colortone	Dbl. 8	.50	—	1.65	—
	Single 8	—	—	1.00	3.60
Weston 8	16mm	—	.75	1.25	4.50
Mazda 3	—	—	—	—	—

Available in Pink, Amber, Lavender and Yellow. 4-25' lengths double 8mm Colortone in 4 assorted colors. \$1.75.

Graphicchrome Superpanex #100	Dbl. 8	1.50	—	4.50	—
	Single 8	—	—	2.50	8.00
Weston 100	16mm	—	1.95	3.65	14.50
Mazda 60	—	—	—	—	—
Graphicchrome Superpanex #24	Dbl. 8	1.25	—	3.50	—
	Single 8	—	—	2.00	7.00
Weston 24	16mm	—	1.75	3.15	12.00
Mazda 16	—	—	—	—	—

Home Processing Outfits
 Develop your own movie film and save! This outfit includes everything you need, 110 ft. capacity developing reel, drying rack, and complete set of developing powders, and instruction book. Reel handles 110 ft. 16mm or double 8mm film. \$1.50 Tray included. SPECIAL... \$1395
 Same as above, but with smaller reel, capacity 34 ft. double 8mm. Tray included. Special \$950
REVERSAL CHEMICALS—Genuine "Graphicchrome" reversal powders, including 2 in 1 developer, bleach, clearing bath. Special fixer and hardener for making 1/2 gal. each solution. Simple instructions included. \$135

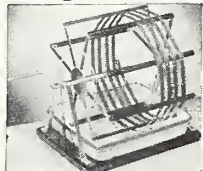

HOME PROCESSING MADE EASY
 Illustrated book tells how, gives formula, plans and instructions for building your own developing outfit. 25c
LONGER LIFE FOR MOVIE FILM
 "Permalac" your film for longer life and sustained projection quality. Use the film preservative professional producers use to preserve film life. Prolongs flexibility, prevents scratching and brittleness. Easy to use. Small bottle treats 1500 ft. double 8 or 16mm. \$100

SUPERIOR FILM SLITTER
 Single 8mm film users, get this film slitter and buy your film in economical double 8mm bulk rolls, then slit and load in your camera. Accurately made. \$1 Easy to use.

BEADED SCREENS Now \$495
 New 30" x 40" 3-way tripod screens. Stand on tripod, hang on wall, or use with easel on table. Black crackle finish, dustproof metal case. High quality crystal beaded surface with black border. Slight imperfections, hardly noticeable, guaranteed not to impair projection qualities. \$12.50 value.
 ★ WRITE FOR PROCESSING RATES!
 Prices and full details on other accessory bargains. CAMERA SPOOLS, PROJECTOR REELS, SCREENS, FILM CEMENT, PROJECTION LAMPS, SPLICEERS, TITLERS, etc. Your inquiry will get prompt and careful attention. Circulars covering all items FREE on request. Order today direct from this ad.

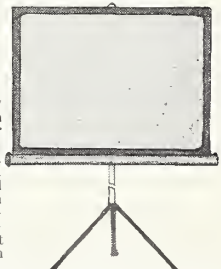

SUPERIOR BULK FILM CO.
 "Home Processing Headquarters"
 188 W. Randolph St., Dept. HM12 Chicago

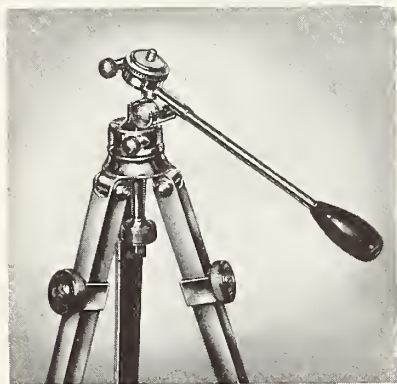

NO FINER GIFT THAN THE TRI-METAL

A Thalhammer TRI-METAL Tripod under the Christmas tree will delight the heart of a camera fan. This beautiful, all-metal tripod combines the utmost strength, sturdiness and versatility with strikingly handsome appearance. Priced at \$18.50 complete with smooth-action, flexible, pan-tilt head.

Inspect It at Your
Camera Dealer's Today!



THALHAMMER CO.
1015 W. Second St. Los Angeles, Calif.



CRITICAL FOCUSING
IN A WIDE ANGLE LENS
FOR 16MM CAMERAS

HERE'S the movie lens you've longed for... precise micrometer focus from 1 foot to infinity. Wide angle of view for confined space shots, interior shots, panoraming. 15mm focus, f2.7 speed, correction for good color and black and white movies under moderate lighting. For 16mm cameras (including turret). Economical, too. You'll need one this winter.

Get it now.

WRITE
FOR
LITERATURE



Wollensak Optical Co., 535 Hudson Ave., Rochester, N. Y.

WOLLENSAK

necessary to photograph each paragraph exactly as the newspaper has printed it. Photograph the paragraphs which describe the scenes taken and use them as needed. Many workers who use this method of titling for news shots save a few feet of film on each roll for these titles, sending the entire footage into the processing laboratory at the same time. Thus when the scenes are back, the titles are ready at the same time, and the film is complete when projected.

The beginner at this method of titling will usually have too much footage of the newspaper and will try to photograph most of the article. Try to avoid this by selecting the best three or four paragraphs and letting them carry the weight for the entire sequence.

The effect is lost if each paragraph is cut out before being photographed. Leave it intact, and if too much of the adjoining paragraphs appear, cover them with one or two thicknesses of light blue cellophane—one if the

film is pan film and two or maybe more if the film is positive film. This will darken the unwanted portions, making the desired paragraph stand out by comparison.

These are merely three examples of how the amateur can many times lighten his title making by using ready made titles. A little care and thought in their execution is all that is needed to make the titling problem of these types of films a comparatively simple yet effective one.

Tips on Make-up for home movies

• Continued from Page 591

tion of make-up is to compensate for the drawbacks of the film emulsion which even the most masterly lighting effect cannot entirely eliminate. As a matter of fact, make-up and lighting work hand in hand, the one making the task easier for the other.

Third: Be wary of applying make-up where it is questionable whether make-up will result in improvement. For example, take the shadow over the eyes. If natural shadow is already sufficient, it would be like carrying coals to Newcastle to add artificial shadow.

Fourth: The final powdering, which is applied only after all make-up "re-touching" has been completed, should be patted on gently not rubbed on as many women do. Frequently, the latter method will cause the make-up underneath the powder to streak, with obvious consequences.

Following is a brief outline of the steps that should be followed in applying make-up and contains some interesting pointers for the amateur about to use make-up for the first time.

Where the kit is to supply make-up for more than one individual, it should consist of an assortment of foundation bases in at least five different and photographically-correct flesh tints. If the materials are true motion picture make-up, they can be relied upon to be photographically-correct

—made so by much research among Hollywood's leading make-up artists, camera men, and lighting experts. In addition the kit should include shadow, lip rouge, brush for applying lip rouge, an eyebrow pencil, and an assortment of panchromatic make-up powders and a powder puff.

The first step is to remove all make-up from the face (if a woman) and cleanse the skin thoroughly either with soap and water or cold cream.

Next select the general foundation base as recommended for the person to whom make-up is to be applied. Apply base sparingly in five light dabs; on the forehead, cheeks, nose, and chin. Smooth over the entire face and neck lightly. Do not rub in. The base should not go into the skin, but should remain on the surface.

The third step: If shadowing or highlighting is needed to minimize or eliminate some imperfection, lighter or darker shades of the foundation base should be applied as required.

Then the special panchromatic face powder is next applied. But first, the skin should be examined closely and wherever highlights and shadows have been applied, the shades should blend into one another softly. There should be no sharp edges. Pat—do not rub—on the powder. Make sure no powder is left in the "corners"—such as around the nostrils and at the corners of eyes and mouth.

The sixth step is the application of lip rouge. This should be done sparingly with the brush and following the natural line of the

• All Amateurs, whether subscribers of HOME MOVIES or not, are invited to submit their films to the editors for review and helpful criticism. Unless otherwise requested, reviews of some of the films which we believe would benefit other amateurs will be published each month.

Reviewed films will be rated one, two, three, and four stars, and films qualifying for two or more stars will receive, free, an animated leader indicative of such award. Detailed reviews, with suggestions for improvement—if any—will be mailed to amateurs submitting their films.

Exceptional films qualifying for

the distinction of the "Movie of the Month" will be treated in detail in a feature length article in a following issue of HOME MOVIES. In addition, a certificate evidencing the award of "Movie of the Month" and a special animated "Movie of the Month" leader will be returned with such films after review.

When submitting films for review and analysis, please advise make of camera, speed of lens, whether or not tripod was used, or if you used filters, exposure meter, or other accessories. While this information is not essential to obtain analysis of your film, we would like to pass it on for the benefit of other amateurs.

THE IDEAL GIFT SUGGESTION

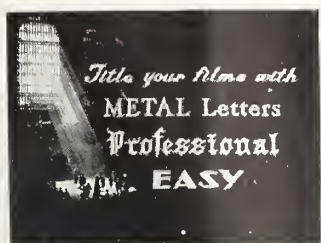

The most beautiful capital and lower case letters made. Complete sets (222 pcs.) as low as \$7.16; 126 caps only \$4.28.

Specify White or Black Letters

KNIGHT & SONS, Inc.

P. O. Box B Seneca Falls, N. Y.

NEW

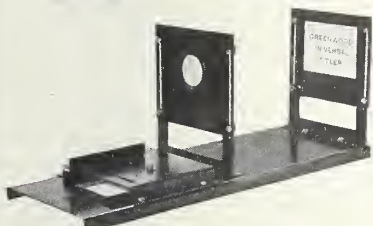

GREENWOOD UNIVERSAL TITLER

Adjustable to a completely rigid unit for use with any 8 or 16mm camera

PRICE \$4.00

Attractive Dealers' Discounts

Greenwood Photographic Devices Co.

North Hills, Pennsylvania

REVERSE YOUR OWN FILMS

for Brilliant Projection
Use **GENERA** P D Q REVERSAL PROCESSING POWDERS

Anyone can do it—it's easy and inexpensive, and also thrilling. Doubles your enjoyment. Simple instructions.

No. 1 Set—½ gal. size: PD12 Developer 65c; Bleach 15c;

Clearing 25c; Hardener 15c; Set, postpaid, \$1.20.

No. 2 Set—1 gal. size: PD12 Developer 95c; Bleach 25c;

Clearing 40c; Hardener 25c; Set, postpaid, \$1.85.

Simplified Processing Outfits including our Prepared

Powders: For 8mm and 35mm \$3.35, postpaid; Dble.

8 and 16, \$4.95, express. Instructions included.

Reducing Powders for dense films, 1 gal. size.....35c

Write for FREE CATALOGUE and Bulk Film Prices

THE GENERA COMPANY, Davenport, Iowa

For Sale— \$50.00 2" Dallmeyer F2.9 Telephoto

for 16mm Cameras \$34.50; \$105.00 6"

Cook F4.5 Telephoto for 16mm Cameras, like new,

\$44.50. Write for big list. Fromaders, Davenport, Iowa.

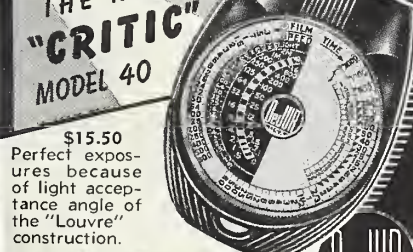

DeJur-Amsco CORPORATION

SHELTON, CONNECTICUT

DEATH VALLEY

An authentic pictorial of this colorful region. 16mm, silent. Color—400 ft. \$50.00. B & W \$20.00. Other lengths available. Also large selection Northern California scenes.

Special Assignments Solicited

W. JENNINGS LUCAS

2638 Portola Way Sacramento, Calif.

lips. Ordinarily, lip rouge is not used on men.

Mascara is generally used on female subjects only, being applied to both upper and lower lids. Occasionally it is used to darken the upper lashes on male subjects, when they are found to be extraordinarily light.

The final step is to carefully brush the powder out of the eyebrows and apply the eyebrow pencil, following the natural line, and

wherever desirable, extending the eyebrow slightly. Be sure the starting and finishing points of the eyebrow line are softened.

It is important to mention here that frequently when making up for the motion picture camera, the tendency among amateurs is often to use too much make-up. It cannot be too strongly emphasized that, for best results, use make-up sparingly.

"Glorified Sixteen . . ."

• Continued from Page 595

the center of the upper lock swivel of the film chamber door. A shaft is then cut to size as shown in Fig. 30 and placed through the hole from the inside, a suitable knob being attached to the shaft on the outside.

This completes the necessary conversion changes required for the production of fades, wipes, laps, etc., and the following will be devoted to the installation of a mask slot and the making of masks.

In the making of the mask slot, a great deal of dimensions cannot be given due to various factors involved. However, the general layout will be outlined and should be sufficient to enable in the construction of one.

Fig. 34 shows the entrance to the mask slot. This top is made up of two separate pieces. The lower, being the main base into which is soldered the mask housing which extends down into the camera.

The upper section is milled out for a small slide that is fitted with a spring at the rear. This small slide acts as a light trap so that when no mask is in place within the slot, it covers the slot to exclude all light from film.

Introducing a mask into the hole, the slide recedes allowing the mask to enter. Fig. 32 shows this assembly with several of the masks. Fig. 33 shows lens mount with the mask slot in position.

It will be noted that the mask carrier extends only down as far as the film plate, from there on the mask runs under the film plate. To accomplish this, a channel must be milled in back of the film plate in the

lens mount. It is ½" in width and extends deep enough to allow the mask to extend beyond aperture in the film plate approximately ⅛".

Upward from the top of the film plate, the lens mount must be milled out large enough to allow the mask carrier to fit into it so that when the mask comes through, it will just slide under the film plate.

The masks are made from ⅜" x ½" cold rolled round edge flats, and cut long enough to extend above the top of the mask slots to suit the individual.

Probably the best way for locating the masking area is to enter a blank in the slot, then with a sharp instrument outline the film gate area on the blank. The desired mask then may be cut out. Considerable care must be exercised in making these masks to insure accuracy.

Masks can be made that will weld two different scenes together so as to blend perfectly with no line showing.

In locating the position where the mask carrier goes through the case, this can be readily accomplished by laying out the area on the inside of the case with the lens mount in position, then drill up from the inside, using a small file to shape out the carrier hole.

After this has been done, the top piece should be cut to fit the carrier, and then shaped to fit the contour of the camera case.

With all parts made and fitted in place, the job would not really be complete unless the parts were finished



Yes, it does exactly that—it adds color, on the screen, to any and all black-and-white pictures.

Eight-segment selector-disc (8 colors), mounted on its own stand, is placed in front of projector lens and revolved by a flick of the hand while picture is screening. Projects two pre-selected colors simultaneously (on upper and lower portions of screen respectively) or tones entire scene one color.

Usable with all projectors, 16mm and 8mm.

Set up in a moment, "ADD+COLOR" takes minimum space. Does not disturb screen, film or projector.

Enjoy the thrill of seeing your "good old black-and-whites" acquire new life and sparkle with "ADD+COLOR."

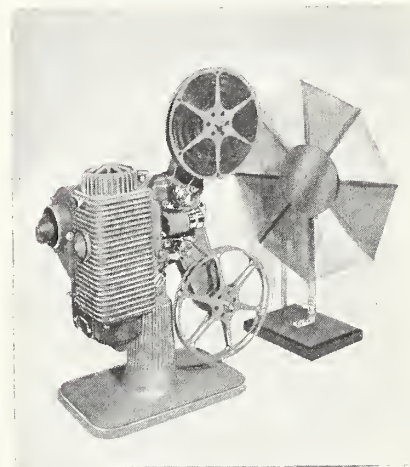

Useful, too, with projector, for color-lighting title sets in Kodachrome filming; also for color-lighting interiors (e. g., injecting red glow around fireplace) in Kodachrome work.

An Ideal Xmas Gift!

"ADD+COLOR"
POSTPAID \$7.50 C.O.D.
ORDER FROM YOUR DEALER
OR DIRECT FROM
FREIDEL'S
2564 ZOE AVENUE
HUNTINGTON PARK, CALIF.
Get Yours TODAY

California Customers add 3% Sales Tax

Quality Bulk Movie Film

8mm • 9½mm • 16mm • 35mm

Complete New Reversal and Title Instructions Free with Film Orders. Separately, 25c each. Cash, check or money order for quick service. Deposit \$1.00 required with C. O. D. orders. Special delivery, 15c; air mail \$1.00 extra. Overpayments refunded or credited. SPECIAL PURCHASE... LIMITED SUPPLY... SCORED Genuine Anti-Halo, SUPER PANCHRO, MICROGRAN, & High Speed ORTHO, in 96 ft. rolls. Lab. packed cut into convenient 32 ft. lengths.

SUPER PANCHRO REVERSAL

Speed 24-16 - Anti-Halo Backing	400 ft.	96 ft.	32 ft.
Double 8	\$13.00	\$3.60	\$1.30
Single 8	7.00	2.00	.80
16mm	12.00	3.50 (100 ft.)	

MICROGRAN PANCHRO REVERSAL

Speed 24-16 - Anti-Halo Backing, Extra Fine Grain	400 ft.	96 ft.	32 ft.
Double 8	\$12.00	\$3.30	\$1.20
Single 8	6.75	1.85	.70
16mm	11.50	3.20 (100 ft.)	

HIGH SPEED ORTHO REVERSAL

Speed 16-8 - Anti-Halo Backing

Prices Same as for Microgran Reversal

SUPER CINEPAN PLUS REVERSAL

Speed 50-40 - Non-Halation Base	400 ft.	100 ft.	33 ft.
Double 8	\$13.50	\$3.85	\$1.45
Single 8	7.00	2.15	.80
16mm	12.50	3.50	

SUPER CINEPAN REVERSAL

Speed 24-16 - Non-Halation Base	400 ft.	100 ft.	33 ft.
Double 8	\$12.00	\$3.35	\$1.25
Single 8	6.50	1.90	.70
16mm	11.75	3.25	

CINECHROME REVERSAL

Speed 8-2 - Non-Halation Base	400 ft.	100 ft.	33 ft.
Double 8	\$5.75	\$1.75	\$.75
Single 8	3.50	1.15	.50
16mm	5.25	1.50	

SPEED 8 SEMI-ORTHO REVERSAL

400 ft.	100 ft.	33 ft.	
Double 8	\$4.00	\$1.50	\$.60
Single 8	2.75	1.00	.40
16mm	4.00	1.15	

Clear 8mm, UNSCORED

Clear, Blue, Yellow in 16mm.

Scored film available in near future.

CINE-KODAK POSITIVE TITLE FILM

Darkroom Loading, Laboratory Packed

NOT Scored

400 ft.	100 ft.	33 ft.	
Double 8	\$4.10	\$1.35	\$.60
Single 8	2.15	.90	.40
16mm	4.00	1.00	

Clear, Purplehaze, Yellow, Red, Amber, Special Blue.

CAMERA SPOOLS WITH CANS—Each

Unirex 8	.35	Keystone St. 8	\$.25
Filmo St. 8	.20	16mm, 50 ft.	.50
Filmo St. 8	.50	16mm, 100 ft.	.60
Eastman Double 8	.40		

EXTRA CANS, Double 8 and Straight 8 size	.05
100 ft. and 50 ft. 16mm size	.10
Non-Humidor, 400 ft. 20c; 6 for	1.00

PRECISION PERFORMING

16mm Films for Use in Double 8 Cameras
50 ft., \$1.00 100 ft., \$1.50 400 ft., \$4.50
Satisfactory in all cameras except Keystone K-8

MISCELLANEOUS

RAIA Precision All Metal 8mm Sitter	\$2.50
FOTOFAXE DYE, for making Chemicals, Fades	1.00
FOTOFAXE WIPE-OFF TAPE, per roll	.60
CINETINTS, 6 Colors and Instructions	3.60
DUPONT VISCOSSE SPONGES, each	.35
HOW TO TITLE HOME MOVIES, book, each	1.00
HOME MOVIES, Back Issues, 1936-37-38-39	.15
Not all months Back Issues, 1940, each	.30
TITLE DEVELOPER, tubes, each make 16 oz.	.15

FILM PROCESSING—PER ROLL

Reversal	Title Developing			
100 ft.	33 ft.			
Double 8	\$2.00	\$.65	\$1.75	\$.75
Single 8	1.00	.35	.75	.40
16mm	1.50		1.25	

WE STOCK EVERY MAKE FILM

Write for Complete NEW Price Lists

A PERSONAL MOVIE SERVICE

Telephone Lincoln 1207

W. STUART BUSSEY FILM LAB.

17 E. St. Joseph St. Indianapolis, Ind.

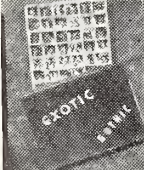

Adhesive Title Letters
REMOVABLE AND REUSABLE
13/16" Gothic (240 letters) \$2.50
1 1/2" Exotic (240 letters) \$3.50
NO-HALO FILM—WESTON 12
100 ft. Dble. 8mm (200 ft.)
8mm Bulk \$1.25
100-ft 16mm, bulk \$1.15
100-ft. 16mm Da-Light
Leader, bulk \$1.25
ACCURATE CINEMA SERVICE
& LABORATORY
2609 Morse Ave. Chicago, Ill.

FIVE HUNDRED MILLION FEET YEAR AFTER YEAR WHY?
No Miracles
Just Honest Film Protection
VAP O RATE
VAPORATE CO., INC. 130 W. 46th St. New York City
BELL & HOWELL CO. 1801 Larchmont, Chicago
716 N. La Brea, Hollywood

DECORATED-ILLUSTRATED
16mm TITLES 8 WORDS OVER 5/8" WIDE
MINIMUM ORDER \$1 PLUS POSTAGE
25¢ EA.
KODACHROME TITLES, MAPS, CHARTS, PRICES, REQUEST
TITLE SERVICE FREE ANIMATED PHOTO WITH ORDER
1600 BROADWAY NEW YORK, N.Y.

to match or harmonize with trim of the camera. Some may wish to plate all the parts; others may find the crackle enamel in better harmony with the camera, leaving only the screws in bright nickel finish.

At any rate, the essential step—in case one intends to apply the finish himself—is to thoroughly clean each part before spraying with the material that produces

the crackle finish. Otherwise the enamel will eventually chip off.

Sherwin-Williams manufacture a product known as "Kem" which is easy for the amateur to apply. It should be sprayed evenly over the surface of each part and allowed to dry for at least 15 minutes to one hour.

The sprayed parts should then be subjected to baking at temperatures ranging

from 200 to 275 degrees F. for a period of 30 minutes.

The wipe-off fan should be finished in flat black which may be applied with either brush or spray gun.

Next month we shall conclude with a description of the many special effects that may be accomplished with the "Glorified 16" and describe the steps necessary for each effect.

Filming ideas that "clicked" . . .

• Continued from Page 597

Closeups show manner in which young trees are guarded against foraging rabbits. Other scenes explain technique of pruning, spraying, etc., with interesting titles explaining much of the process.

Then follows scenes of picking, sorting, and packing the apples for market.

All in all, it is a very thorough job of documentary picture making with consistent exposure and a steady camera highlighting the photography. There is an occasional jump between scenes noticeable on the screen due to the fact the same setup was used between shots or because the camera was stopped momentarily in the midst of shooting a scene. In such instances it is advisable to change camera setup, providing a clean, distinct break between scenes.

Editing: As a whole, this phase of the picture was well handled. There are spots where a little too much footage is allowed the harvesting scenes. There's a scene following a title relative to pruning that could be deleted as its content is irrelevant to pruning. The scene referred to in the title should immediately follow it.

Titling: Titling was very good with interesting title backgrounds that resembled a wall paper design. The long rolling or "scroll" title at the beginning aided in establishing interest in the subject. The titles succeeded nicely in telling of the many ways in which the apple has played an important part throughout history.

Equipment: Filmo double

8mm camera with f/2.5 lens; Weston exposure meter; tripod; and Seemann Titler. Main title made with wooden block letters cemented to glass. Scroll titles were filmed on Eastman tinted base film. Closeups of blossoms were filmed with aid of supplemental lens. Parallax for closeups was determined with aid of Home Movies chart.

"CABIN OF DREAMS" ★★
100 Ft. 8mm — by R. D. P.

Continuity: Commendable is the fact this filmer worked out a nice continuity from many scenes shot previous to acquiring the idea. By using well planned titles he developed interest in his picture that would be wholly lacking without their explanation.

The picture explains the enjoyment to be had from ownership of a cabin in the woods and gives reasons for the various activities depicted—boating, fishing, and hunting.

Photography: With a little more attention to technical details this filmer

should soon be turning out more than ordinary movies. In this picture there is just a little too much shooting from moving vehicles as well as one scene made while walking with the camera. Best movies are those made with the camera still. A movie camera is intended to record motion not to lend motion to a scene.

Editing: A little editing is still necessary in some parts of the picture—particularly where scenes are preceded by irrelevant titles. Frequently the scene described in the title does not immediately follow the title. In another instance, one moving title should be changed, and encompassed in one single title, as it is used, intercut, between two scenes with some of the text of the previous title showing in the succeeding title.

Titling: Was good. This filmer has a genuine feel for titles and only needs additional study of the technique of properly placing them in the film.

Movie of the Month . . .

• Continued from Page 596

inviting scenic shots ever screened by this reviewer. Included are scenes of lakes, mountain passes, trout lairs, cool camping spots, wild flowers, in fact everything that a Chamber of Commerce publicist tries to describe with words in those travel folders!

Hundreds, perhaps, thousands of movie amateurs have trained their cameras on these same spots, have

recorded approximately the same scenes; yet we'll venture to say that few of them captured the beauty of this country as did Belknap with his keen eye for framing and picture composition. Every distant shot was artistically framed by a branch of a tree, a shrub swaying in the breeze, or perhaps filmed through an arch of some natural rockformation. And there was action, too, in

Adaptor and 10" Cable
for
BELL & HOWELL FILMO
Companion, Sportster, 141
KEYSTONE K-8
Specify front or side trigger
EASTMAN 20, 25, 60
VICTOR 3, 4, 5

Avoid groping for the trigger and jarring the camera. Enter the picture yourself. Operate the camera and pan head with one hand. Adaptors no larger than a half dollar, instantly attached and detached, will not interfere with loading, winding or tripod mounting. Can be left on camera permanently. Simplifies single frame exposure, straight filming, and can be locked for continuous running.

\$2.00 postpaid in U. S. (plus tax in Calif.)
See your dealer, or write
GARMUR PRODUCTS
P. O. 6073 Metropolitan Station
Los Angeles, California
Also: Matus Camera Supply Co.
5208 Wilshire Blvd. Los Angeles, California

Save on Holiday Shooting
USE THRIFTY 16mm FILM

THRIFTY ORTHOTYPE **\$1.60**

For OUTDOOR... non-halation base, fine grain, fast... Machine processed. Per 100-ft. rolls...
THRIFTY Panchromatic... \$3.75
THRIFTY Super-Panchromatic... \$4.25
Thrifty Films save you 50%. Three films to choose from—each a leader in its class. THRIFTY FILM is a proven value and our complete laboratory is one of the best in the West.

California Buyers Please Include Sales Tax
Sold and Processed Only by
THRIFTY FILMS
Drawer 98, Watts Station Los Angeles, Calif.

Kodachrome Main Titles

16MM KODACHROME 1.00
8MM KODACHROME .50
SAMPLES—INFORMATION—PRICE LIST
UPON REQUEST

FRANCIS S. NELSON
737 MICHELTORRENA ST. LOS ANGELES, CAL.



A DIME-A-DAY BRINGS FUN TO STAY
Enjoy home movies on Don's Dime-a-Day pay plan—\$2.50 down on Keystone and other 8mm and 16mm cameras, projectors, etc.—bal. in 10 easy payments, no interest, no carrying charge. Send 10c for illustrated catlg. Write Dept. HM2.
don elder's home movies
739 BOYLSTON ST., BOSTON, MASS.

Why use anything else when
TITLES BY PARK CINE
cost no more than ordinary titles.
Catalog Free on Request
PARK CINE LABORATORY
120 West 41st Street New York City

FRAME-COUNTING WINDBACKS
Guaranteed accurate. Expertly engineered and installed. Money-back guarantee.
Keystone... \$15.00 • Filmo... \$19.95
Precision Built Accessories for Every Need
Write Us Your Requirements
Custom Built Camera Accessories Co.
4124 Rawlins Dallas, Texas

Our new catalogue is now ready. It lists the largest library in the world of 16mm sound, 16mm silent, and 8mm silent films.
IDEAL PICTURES CORPORATION
28-34 East 8th St. Chicago, Ill. 2402 West 7th St. Los Angeles, Calif.

TUBULAR ALL-METAL
The one tripod engineered to an accuracy of one thousandth of an inch. Has unequalled features in design and operation.
Complete Unit—Tripod and Head, \$15.75
For literature write: R. J. Pagliuso Mfg. Co., 1000 E. Mountain, Glendale Calif.
HOLLYWOOD TRIPOD
R. J. PAGLIUSO MFG. COMPANY

most of these scenic shots—something moving within every scene—people, trees, or a waterfall.

From this point, the travelogue takes us into Spokane which is introduced with many fine long shots of the cities principal thoroughfares and its imposing business district. Following these scenes, we are shown Spokane's beautiful residential districts; its huge city parks with many scenes devoted to the recreational facilities afforded; the important factory and industrial district; Spokane's transportation system; its airports; and source of its hydroelectric power.

One of the best bits of photographic work in the entire picture is a scene where several orange colored transportation buses emerge from the shadows of an overhead viaduct into the bright late afternoon. The effect of the changing color of the buses as they turn into the bright light is spectacular.

There are other photographic highlights in this picture—far too numerous for description in the limited space allotted here. What makes these scenes—in fact the entire picture—remarkable for photographic excellence is the fact Belknap shot every foot without the aid of an exposure meter. His only guide was the simple exposure chart attached

to his Model "B" Eastman Cine Kodak—proving again that a good artist can make swell movies with the simplest of equipment.

He failed to state in the letter accompanying his film just how he accomplished the fine double exposure and dissolve effects which highlight his picture. But these effects are in the film and we are sure that one capable of shooting so much footage so consistently well exposed is also capable of other cinematic tricks.

The closing scenes are night shots filmed in the business section, and appear to have been exposed at 16 frames per second at f/1.9. Exposure of these night scenes is remarkable for color film, particularly as the movement of people and automobiles within the scenes appears at normal rate.

The final scene is a panorama overlooking the lighted city at night, over which the closing subtitle and end title are double exposed.

There aren't too many titles in this picture, but when one is necessary to impart facts to the audience, it appears in neat type over a deep blue background.

"Spokane and The Inland Empire," aside from its achievement as a commendable effort in amateur cinematography, has all the ingredients of an excellent promotional film. Spokane's Chamber of Commerce will undoubtedly hear about it.

Prize winning picture

• Continued from Page 584

background of calendar leaves falling downward to denote the number of days of their money making activities followed by closeups of hands dropping money into the palms of the youngsters. Lap-dissolves were used in several places to indicate change in locale or bridge over lapse of time. These effects were not at all difficult and required little extra equipment.

One of the problems most frequently confronting the ambitious amateur filming a scenarized story is the difficulty in obtaining suitable settings—particularly interiors. Many of us frequently are required to dis-

card a scene or alter our scripts to conform with the settings available to us. To overcome this obstacle, I found that faking a scene often produces an effect comparable if not better than what might have been obtained with an elaborate setting. Illusions are often simply created.

The script of this picture called for a considerable amount of footage to be shot inside of stores which I later found would be impractical to secure. However, the situation was saved by a good friend of mine—an employee of a large optical and photo-

GOERZ
KINO-HYPAR
LENSES
f:2.7 and f:3
For regular and color movies of surprising quality—high chromatic correction...
Focal lengths 15mm to 100mm—can be fitted in suitable focusing mounts to Amateur and Professional Movie Cameras.



GOERZ Reflex FOCUSER
—Patented—
For 16mm Movie Cameras—voids PARALLAX between finder and lens—provides full-size ground-glass image magnified 10 times. Adaptable to lenses 3" and up. Also useful as extension tube for shorter focus lenses for close-ups. Extensively used in shooting surgical operations, small animal life, etc.



GOERZ Parallax-Free FOCUSER and FIELD FINDER CONTROL
No more off-center pictures, for Filmo 121 and Simplex-Pockette magnifies 4 and 8x.
For Detailed Information Address Dept. HM-12
C. P. Goerz American Optical Co.
317 East 34th St., New York
American Lens Makers Since 1899

DE LUXE
FILM CASE



ONLY \$5.00
Ideal Christmas Gift

In storing films, as in packing cigars, wood has just the proper amount of moisture to prevent deterioration. Artificial leather or striped covering gives the advantage of luggage appearance.

- Two sizes—16mm and 8mm.
- Holds eight 400 foot cans; six 100 foot boxes; index book.
- Suitcase construction... Strong... Durable... Dust proof.
- Covering washable and water proof.
- Genuine leather handle, a lock, and key.
- Complete with loose leaf index book.
- Color: Black, brown, stripe.
- 16mm \$5.00; 8mm \$3.75.
- Order direct or from your dealer.

GEO. T. PURVES COMPANY
519 W. 40th St. INDIANAPOLIS, IND.

FREE! Catalog of Home Movie Buys

Lafayette has all the equipment you want to make better home movies—at money saving prices! No wonder thrifty, happy home-movie makers use this Lafayette catalog to order again and again. It's a great money-saver! Saves time, too, because you can order everything at home, and have it speedily. Get to know Lafayette—you'll enjoy movie making more than ever. Rush your order today!

BIG Lafayette VALUE!

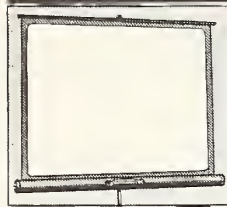

Now you can own a genuine crystal beaded tripod screen. It's big in everything but price. Efficient 30" x 40" crystal beaded surface, adjustable in height on sturdy metal tripod support, rubber protectors on tripod feet. Easy set-up, folds to compact unit. Shpg. wt. 18 lbs. Big value at \$789

DeLuxe model has screen area 36" x 48". Shpg. wt. 22 lbs. \$1089

TO GET SCREEN, attach check or money order with coupon and mail. Send at once. Remember to ask for big FREE catalog.

Lafayette Camera

NEW YORK, N. Y. 100 Sixth Ave.
CHICAGO, ILL. 901 W. Jackson Blvd.
ATLANTA, GA. 265 Peachtree Street
BOSTON, MASS. BROMK. N. Y.
NEWARK, N. J. JAMAICA, L. I.

LAFAYETTE CAMERA
Dept. 80M—901 W. Jackson Blvd., Chicago, Ill.
or 100 Sixth Ave., New York, N. Y.

I enclose \$..... Rush my order.
 Please Rush FREE Catalog.

NAME.....
ADDRESS.....
CITY..... STATE.....

Make Prize Winning Color Shots!

WITH

The PB Movie Filter Kit for Color Film
\$3.95 COMPLETE

- 1 PB Lens Shade and Filter Holder
- 1 PB Haze Filter (for Kodachrome)
- 1 PB Conversion Filter (for converting type A to Daylight)
- 1 PB Filter Pouch

For 8mm Eastman, Bell & Howell, Revere, Keystone and others.

Order from your nearest dealer or direct from:
PONDER & BEST 1015 S. GRAND AVE., LOS ANGELES, CALIF.

Guaranteed 24-Hour PROCESSING

EXCLUSIVE with ESO-S Pictures is the modern soft-flash system reversal process which insures an even, correctly tone-balanced, fine-grain reel of films consistently!

- Double 8mm, up to 34 feet..... 45c
- Single 8mm, up to 34 feet..... 25c
- Univex Std. and U. P., and ALL ESO-S single 8mm films..... 15c

These prices apply to all bulk films, including the new Gavaert Ortho, Microgan and Super Panthro, DuPont, Eastman positive, and our own complete line of reversal films.

REELS AND CANS RETURNED WITH THE FINISHED FILMS UPON REQUEST

ESO-S PICTURES
"Quality 8mm Service"

3945 Central Street Kansas City, Missouri

When You Buy BAIA You Buy the Best

Precision Made; Guaranteed Perfect

\$2.50

From Your Dealer or Direct
BAIA MOTION PICTURE ENG.
259 Gerald, Highland Park (Detroit), Michigan

graphic supply store — who kindly arranged for the use of his employer's store on a Sunday afternoon. This particular "set" was used for two purposes — for a jewelry store scene, and scenes of the interior of a photographic store. By first filming the two children looking in a near-by jewelry store window and then, as they started toward the entrance, making a lap dissolve of them as they approach the counter within the store, the desired effect was secured particularly because all shots were held to tight closeups that revealed

little of the surroundings. The same counter within the store, re-dressed with cameras and other photographic goods, and photographed from another angle, served for the shots comprising the photographic store scenes. In this case some longer shots were used to include more equipment in the background. Several closeup shots filmed in the store did not come up to expectations and as it would be inconvenient to return to the store for re-takes, the shots were re-filmed at home — faked. This was accomplished by

using a different camera angle and shooting the scenes in tight close-ups with a black drop behind the characters. Frequently I am asked for advice for successfully directing children in home movies. Since starting the series of pictures of which "Christmas Well Spent" is the most recent, we make it a sort of a game with the children, allowing the imagination of the youngsters to do the actual interpretation of each scene. Thus a naturalness of expression is obtained without necessity of rehearsal.

New ideas for Christmas filming . . .

• Continued from Page 581

or a larger lens diaphragm opening will give an effect of more life and sparkle. The brighter colored bulbs, white, red, orange, are very distinct with a film having a tungsten speed as low as 20. It is advisable, therefore, to photograph the scene at the larger diaphragm openings in order to get good exposure of the decorative elements and adjust the time of day the shots are made accordingly. This is better than stopping down to simulate deep twilight in which case underexposure of the strings of bulbs and other decorations might result.

In addition to a distance shot try one up closer to include the windows in back of which the Christmas tree is placed. This, too, may be a twilight photograph. At night, a photoflood or two in reflectors directed at the house will help to bring out the faint outline of the building adjacent to the lighted windows. (Fig. 3.)

Be sure that the tree itself is adequately illuminated. Photofloods are good sources to use for floodlighting it. Dark green does not photograph well at best with panchromatic films and it is imperative that some supplementary light be used in addition to the Christmas tree strings. Strings of pop corn, tinsel, and metallic-foil streamers all help to give life to the tree.

What about a scene from the outside of the act of dec-

orating the tree? Perhaps you could be so fortunate as to catch old Kris Kringle placing the presents around the tree. This could be followed by a shot of the same action from inside.

With small, light-colored houses, the floodlighting of the entire front of the building with, say, four R-2 Photoflood lamps is not out of the question. (Fig. 4.) Two or three R-2 lamps or No. 2's in reflectors directed at the entrance will enable action shots to be made — guests arriving, etc., which can be followed by sequence shots inside.

Scenes such as accompany this article could be used as backgrounds for titles for a Christmas movie. Double exposure of background and title could be made, or more simply, a print from a still camera could be used as the background with the letters of the title in front.

Snow adds much to Christ-

mas exteriors, so if possible take the scenes when snow is on the ground.

What about color? This may be asking too much in view of the great range in contrast between the luminous bulbs and the dark surroundings. With a particularly colorful display, it might be well worth while shooting a few feet in color. Use Type A Kodachrome, open the lens up wide (F/1.9) and use one-half speed. A scene such as Fig. 3 would be particularly effective in color. Likewise, with Photofloods flooding the front entrance there would be no difficulty in picking up Santa Claus in his colorful red suit as he approached and entered the home.

I am sure that for the sake of a good Kodachrome shot even Santa would use the front door rather than the chimney.

Turret for Keystone "8"

• Continued from Page 588

Fig. 2 is the stator or turret housing — that part which connects directly to the camera and within which the rotor plate of the turret revolves. This may be turned on a lathe from a solid piece of aluminum or dural.

Fig. 3 is the rotor plate to which is fitted the collars that receive the telephoto lens assemblies — indicated

at a, b, and c. Also shown is detail of viewfinder masking areas.

Fig. 4 is the mounting plate which replaces the regular engraved plate on the front of the camera. This was made of 1/16" brass using the regular camera plate as a template.

Fig. 5 covers construction of the rotor spindle and



Title Backgrounds

Put class into your titles with these artistic printed title cards—each one different—designed especially for typewriter titlers. Cards for main, credit, and end titles. Choice of two assortments: No. 1, for Black and White film; and No. 2, for Kodachrome. Be sure to specify when ordering! Sets of 25 cards —

50c
Postpaid



The latest and most complete book on titling home movies. Includes complete plans for building the renowned Home Movies' titler; title area chart; lighting chart; diopter lens chart; data on use of shims for ultra-close-ups; and instructions for making trick titles. Approximately 100 pages jam-packed with vital information.

\$1.00
Postpaid

Ver Halen Publications
6060 Sunset Blvd. Hollywood, Calif.

Large 8mm-16mm Film Library

Highest prices paid for your own subjects in exchange

REELS		CANS	
8mm	24c	8mm	25c
16mm		16mm	29c
BULBS			
Both 8mm-16mm			
200 watt	\$1.65		
300 watt	2.00		
500 watt	2.50		
750 watt	2.85		
Fully Guaranteed 30 Hrs.			
SPLICERS		NEW and USED	
Craig	\$1.98	Projectors and Cameras	
Senior	6.98	at Large Discounts	
Trade in your old camera or projector for a brand new model. Join our Rental Library. Ask for our Catalogue.			

ABBE FILMS 1265 Broadway, New York
Murray Hill 4-1237

"It Always Gets the Picture"

G FILM

100' 16mm (inc. Proc., postpaid)\$1.50
100' Dble. 8mm (inc. Proc., postpaid) 1.75
100' Sgle. 8mm (inc. Proc., postpaid) 1.00
Unspooled to Save You Money Scheiner 18

Send for New Free Illustrated Folder

M-G-M PHOTO SERVICE

1485 Oak Street San Francisco

CINE SHOP TITLES
WRITE FOR NEW CATALOG
Cine Shop
1812 PIEDMONT CHARLESTON, WEST VA.

bearing upon which the rotor plate revolves.

Fig. 6 is the direct viewfinder tube, described earlier, which enables focusing directly through each telephoto lens. This tube is connected to the rear of the turret housing as shown in photo 2.

The aperture adjustment lever and collar, shown in photo 3, is illustrated in detail in Fig. 7. The pointer protrudes through the slot in the turret housing. The lever is fitted over the iris ring of the lens and locked in place so that the pointer indicates correctly the f/ stop setting.

Figures 8, 9, and 10, present detail of construction of each of the telephoto lens tubes and the smaller, combination filter holder and lens shade. While part of the bakelite tubing from the original binoculars is used, the extension sections were turned from dural, as also were the threaded ends of each lens tube.

To insure both parallel and vertical accuracy in fitting the telephoto lens assemblies to the turret, separate lens seats were

constructed for each as shown in the drawings. These seats in turn were press fitted into the rotor plate and further secured by means of small set screws as shown in Fig. 3. Photo No. 4 shows one of the lens seats removed.

Of course, for some amateurs, the construction of this turret will entail the employment of a machinist to turn out the necessary lathe work but the cost should be nominal for both labor and materials. Any amateur should be able to put the parts together once they are finished according to the diagrams.

Considering that this turret provides for using inexpensive but nevertheless practical binoculars for telephotos instead of two regular telephoto lenses, the saving certainly justifies the attempts of any dyed-in-the-wool cinebug owning a Keystone 8mm camera to try his hand at constructing it. Soucy claims excellent results have been had with the binocular telephotos and one cannot deny that the turret and lenses certainly add a bit of class to the appearance of the camera.

U. of I. film supply center . . .

• Continued from Page 601

"merchandising" of the visual idea to elementary school officials, it has grown rapidly during the past decade. During the depression years, when the per-teacher student load was increased, visual education took a sharp up-turn when Cochran pointed out the fact that the overburden of such teachers was lessened by using visual aids to supplement personal classroom work.

The present policy of the Iowa library is that films and other aids are available to superintendants, principals, boards of education and "other responsible parties" on a rental basis, both in Iowa and in neighboring states. But Cochran avoids "competition" with other distributing centers; for instance, schools in the western part of Illinois, closer to Iowa City than to Champion, may receive films from the Iowa Uni-

versity. Closer to Illinois University, they will first be referred to that school, unless the film they seek is something which Iowa has and Illinois has not. For instance, Iowa is one of the first universities to go into production of films, and last year, films on special subjects were produced and sent to every state in the Union.

Cooperation with elementary schools is on a simple basis: the department publishes an annual catalogue, which is added to periodically, covering its own library and films available to it from outside sources. A participating school has only to select its films and mail-order them from the University. Booking is usually restricted to one day, to keep the stock fluid and facilitate the servicing of all requests. Fees are \$1 for a day's use of

Say-

"Merry Xmas"
with a
RAVEN SCREEN

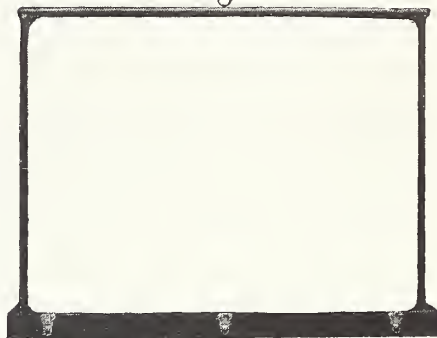

Raven was chosen by Eastman Kodak for the Cavalcade of Color at the World's Fair. Now, more than ever before Raven should be your choice, too—because new reduced prices mean even greater values. For yourself and those you want to please.

DE LUXE AUTOMATIC COLLAPSIBLE MODEL

WITELITE—a smooth "flat-white" surface (now costing no more than an ordinary beaded screen), HAFTONE—an exceptionally fine quality and three other fabrics in six sizes, 22" x 30" to 54" x 72", serve every purpose. See these and other fine Raven Screens at leading dealers everywhere or write—

RAVEN SCREEN CORP.
314 East 35 Street New York City

Something New From Washington!

Byron's Specially Designed

FLOOD LIGHTS

\$3.95

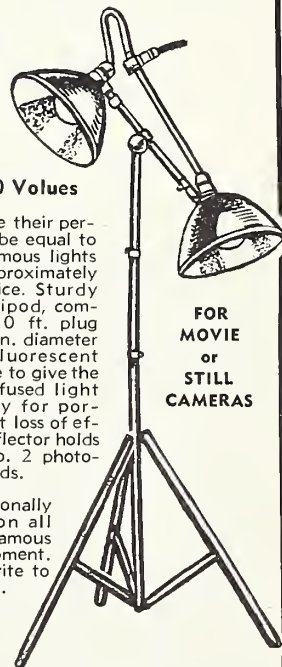

\$6 to \$7.50 Values

We guarantee their performance to be equal to nationally famous lights listed at approximately twice the price. Sturdy adjustable tripod, complete with 10 ft. plug and cord, 9 in. diameter reflectors. Fluorescent etched inside to give the desirable diffused light so necessary for portraits without loss of efficiency. Reflector holds No. 1 or No. 2 photo-floods.

Also sensationally low prices on all Nationally famous movie equipment. For prices write to Dept. H.

FOR MOVIE OR STILL CAMERAS

BYRON'S, Inc.

625 15th STREET
WASHINGTON, D. C.

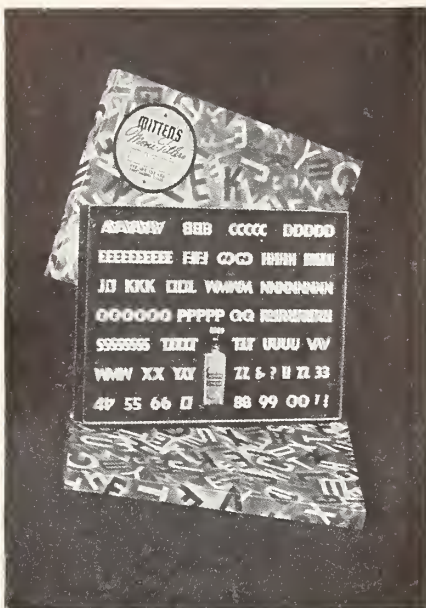

TITLES make movies talk for themselves!

Why not take full advantage of the pleasures of your hobby? When you fail to title your films . . . you fail to enjoy the thrill of making a real finished home movie.

Ask your dealer about the PIN AND SANDED BACK TITLE LETTER SETS. They are ideally suited for making theatre quality titles with any 8mm or 16mm camera.

PIN LETTER SETS
\$5.50 Up

SANDED BACK LETTER SETS
\$4.75 Up

Write for Descriptive Literature and Information on Our Complete Line of Letters

MITTENS LETTER COMPANY
REDLANDS, CALIFORNIA

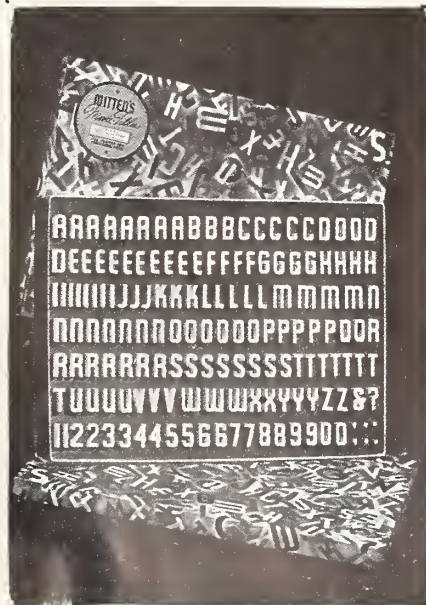

silent film or \$1.50 for sound film, except for films available to the University from outside sources, without charge, which are passed on for only a small service fee. The user pays transportation both ways and insures the preservation of the film. Lantern slides are sent out on the same basis at 50c per set. In addition to the supply function, the Extension Division is contemplating a wide service in preparing and furnishing school film lesson courses to accompany films and slides for certain courses of study.

The financial end of Iowa's Visual Instruction Department is interesting: although almost self-supporting from its rental and service operations, it is non-profit making, the proceeds going back into replacements of worn films and the purchase of new subjects. An appropriation for the department is made from the University funds which represents about one-fourth of the department's expense, in return for which the department furnishes the University with complete service for any department, including films, equipment and operator. This means that for each \$1 appropriated for the department by the University, it gets \$1 worth of service for its own operations, in addition to furnishing the state \$4 worth of instruction department. During the past year, films from the Iowa library reached an estimated 1,625,500 people in 2,800 showings, with slides reaching approximately 80,000 persons.

The chief problem in distribution, Cochran finds, is meeting the booking dates required by the borrowers. Since the aids must be correlated with the current classroom schedules to have their maximum value, meeting the requested delivery schedules is important, yet duplications of requests often complicate this. From this condition, Cochran has developed one important point of policy as a tip to any supply administration: he duplicates as many of the worthwhile subjects as possible, preferring to have five copies of one good sub-

ject than single copies of five different subjects.

Another prevalent obstacle is, of course, the lack of projection equipment in the elementary schools. School boards are often reluctant to spend the money, and laymen still regard movies as entertainment rather than education. To overcome this condition, Cochran and his assistants visit school board and parent-teacher meetings to show sample educational films, and to explain the position of visual education in the school system. Without exception, the schools they have so visited have bought projection equipment. The Iowa Visual Instruction department does not, of course, sell any equipment. The Iowa Visual Instruction department does not, of course, sell any equipment, nor recommend any certain make of machine, though another of its important functions is to advise interested schools on the purchase of proper and necessary equipment.

Still another step Cochran's department has taken in "selling" visual education and preparing educators to do the same with their constituents is the department's activities during summer session. At this time, the major portion of the student body consists of teachers doing post-graduate work, and members of the I.V.I. department present a series of visual aid demonstrations and exhibits. Arrangements are made for those interested to secure instruction and information regarding the operation of the equipment and the workings of a system of supply and distribution.

In the past only a small percentage of films distributed by the department have been of its own production, but with the addition of sound-recording equipment this October, production schedules are now being broadened. The first project in sound recording will be incorporated into a film now being shot titled "State of Iowa" planned to be four reels in color picturing historic and scenic Iowa, showing what Iowa "was, is, and has". Sound pictures will also be produced for research prob-

lems in speech, speech correction, psychology, and child welfare.

To further interest schools and instruct their personnel in the use and application of visual aids, a Visual Instruction Conference was sponsored on the Iowa campus early in October. Visitor lecturers were invited from other states, Iowa teachers presented their individual problems of treatment and administration, and a preview of new films and equipment was shown.

The importance and potentialities of the state university as a unit in visual education distribution and application is plainly manifold. First, such a department is relatively easily financed, getting its start from University funds, soon after which it can become nearly self-supporting. It can then function not only as a state-wide center of distribution, but also as the prime mover in "selling" visual education to school boards and to the public, in teaching elementary school teachers the technique of application, as a consulting board in matters both of equipment investment and in administration and use, and can form the nucleus of a state production activity, which is the next step in bringing visual education home to residents of individual states.

Title troubles

• Continued from Page 578

light reflecting from an object such as a title cannot be measured in relation to the strength of the developer that is to be used on the film. Should such a schedule be worked out, it would then be possible to say that with a given film and a given developer, the exposure factor is so and so. By consulting a table, the worker would then be able to tell exactly the right opening to use for any given illumination. But this remains to be done.

Q. Can you please tell me some of the ways of producing fades on positive film titles? — B. K. T., Salem, Mass.

Christmas Gift Order Blank *

HOME MOVIES

Sunset Boulevard Hollywood, California

Send find \$ _____ for which enter one-year
subscriptions to HOME MOVIES to go to the following ad-

Renewal

Send Gift Card

Renewal

Send Gift Card

HOME MOVIES subscription price \$2.00 a year in United States and
possessions. Canada and Foreign Subscriptions \$3.00

Specialty printed Christmas Gift Card naming you as donor will be
sent with the first copy.

A. One of the best ways of producing a fade-in or -out on any film is with the use of the commercial dye preparation known as Foto-fade. The finished film is dipped into the solution, the speed of the immersion controlling the speed of the fade on the screen.

Another way to make fades on positive film is to expose the title at a small aperture, then slowly open up the diaphragm to f 1.9. Still another way is to make a lap dissolve with a white sheet of paper. To do this, you decrease the exposure gradually, either with a fading glass, rheostat, or by closing down the lens. Next you re-wind the film the length of this decrease, and then increase the exposure as you expose on the white sheet of paper in the same proportion. That is, if you decreased the exposure with a fading glass for two seconds, you wind back the film about 32 frames and then increase with the fading glass for two seconds again.

Information please

• Continued from Page 574

one film is a full stop faster or slower than another?

Film speeds are multiplied by two to indicate one full stop in speed; divided by two to indicate one full stop slower speed. Thus, a film rated at Weston 24 is one full stop faster than Weston 12. Weston 12 is one stop faster than Weston 6, and Weston 8 would be one-half stop faster than Weston 6. 32 would be one stop faster than 16 but two stops faster than 8.

Advanced Cinefilmmers

• Continued from Page 576

pleted by several Hollywood studios and film laboratories that will make for wider use of 35mm Kodachrome in place of Technicolor. Although it is claimed Kodachrome still possesses some limitations that prevent its immediate adoption for the rigid quality requirements of general feature production, it has already been perfected to a point where it

can be used successfully for outdoor work.

Advanced Cinefilmmers faced with requirements for better equipment for producing fades, lap-dissolves and other professional effects in their movies are finding the facilities of the MacVan Manufacturing

It's new to me...!

• Continued from Page 604

economical 15-cent, three hour photoflood lamp.

New Office

Films Incorporated, 330 West 42nd Street, New York City, has just announced that a Los Angeles branch office will be opened September 1st at 1709 West 8th Street, Suite 918, Halliburton Building, Los Angeles, California. The telephone number is Fitzroy 6300.

A representative stock selected from their vast library of 16mm sound features and short subjects will be installed at this office and available for convenient rental to schools and institutions located in the southwestern United States. Convenient listings and literature on the film service will be supplied upon request to above address.

Victor Lighting Book

Available to amateurs writing to Jas. H. Smith & Sons, Corp'n., Griffith, Ind., is their latest complete catalog on Victor Lighting Equipment which contains valuable data and illustrations concerning indoor lighting for amateur cinefilmmers. This timely booklet will be welcomed by many amateurs now engaging in indoor movie making.

Hobby Film

Walter O. Gutlohn, Inc., 35 West 45th Street, New York City, announces the completion of a two reel instructional motion picture "The Elements of Photography." This film is intended for instructional use in photography classes and camera clubs and illustrates the technique and steps in taking the picture and de-

veloping and enlarging the negative.

Company of San Diego, California, timely. This firm in recent months has designed and perfected backwinds, frame counters, and dissolving shutters for 8mm and 16mm cameras that place such cameras almost on a par with standard 35mm equipment.

veloping and enlarging the negative.

Reel 1. *Taking the Picture.* Loading the film holder, loading the camera, the actual working of the camera and its parts, taking the exposure and actual taking of the picture.

Reel 2. *Developing and Enlarging.*

Reel Fellows

• Continued from Page 593

sincerely. Study its every phase through the reading of books and periodicals devoted to the subject. Keep active, making pictures until you have mastered all departments of movie making — photography, continuity, editing, titling, etc. Mingle freely with those actively interested in home movies. The free exchange of ideas will gain more, sometimes, than all the reading of books. If there's an amateur cine club in your town, join up. Be an active member.

Reel Fellows may indeed be proud to have as a fellow member Lloyd Bacon, whose enthusiasm and encouragement for the amateur is bound to be an inspiration to every member of the rapidly growing Reel Fellows' organization.

Cine workshop . . .

• Continued from Page 603

to produce the fade-in effect and left in "closed" position for the duration of time title is to remain on the screen. To fade-out, slowly open venetian blind until the slats are in horizontal position again.

— David S. Alexander.

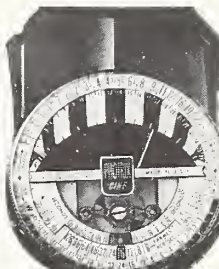
A real
MOVIE METER

DESIGNED in every detail for the special requirements of movie work

Unique in its simplicity of reading... needle indicates F-stops directly... no resetting between shots. The ideal movie meter for amateurs and professionals, for color and black-and-white. Also usable for stills.

\$22.75

Made in U.S.A. TOPGRAIN COWHIDE ZIPPER CASE... \$1.25

INTERCONTINENTAL MARKETING CORP.
8 WEST 40th ST., NEW YORK

THRILL your audiences!
WITH Sensational Films



GET NEW PRINTS
Lowest PRICES
Order from Producers
SPECIAL PRICE LIST
SAMPLE FILM 10¢

Exciting new films now ready
WRITE TO Sensational Films
BOX 1504 - HOLLYWOOD, CAL.

CORONA 8mm 16mm

BETTER REVERSIBLE FILMS	Super Anti-halo	Semi Ortho	Semi Outdoor
16mm, 100 ft.	\$ 4.50	\$2.50	\$2.00
8-8, 25 ft.	1.75	1.25	1.00

Above includes processing and daylight spooling.

BULK FILMS — Same Price — 16mm or 8-8

100 ft.	\$ 3.15	\$1.30	\$1.20
400 ft.	11.60	4.25	4.00

Film laboratory packed. Processing not included.

Double 8mm Camera Spools with cans. Each 30c

REVERSAL PROCESSING — 16mm and 8mm

100 ft.	.85c	50 ft.	.65c	25 ft.	.50c
---------	------	--------	------	--------	------

All orders shipped postpaid except C. O. D.

CHRISTMAS SPECIALS—Discounts on New Projectors, Cameras, Features, Short Subjects. Write for Literature.

Corona Film Laboratories
200 East 34th St. Brooklyn, N. Y.

YOU'VE BEEN WAITING FOR IT —

Here it is!

"A to Z" TITLE FRAME FREE!

Given away with the purchase of our **SPECIAL CHRISTMAS PACKAGE**

Everything for making beautiful professional titles

- 1—"A to Z" \$2.00 MOVIE TITLING OUTFIT
Famous tracing method used by thousands for making titles in black and white or colors. Anyone can do it. All cameras may be used.
- 2—"A to Z" \$1.00 FIGURETTES FOR BACKGROUNDS
36 subjects in brilliant colors. Re-usable, stick to anything, no moistening, modern.
- 3—FREE—"A to Z" TITLE FRAME
Designed especially to take titles up to 7" x 9". Always upright, convenient, and detachable.

ALL 3 COMPLETE FOR ONLY **\$3.00** POSTPAID

Order direct. Money-back guarantee.

"A TO Z" MOVIE ACCESSORIES CO.
175 Fifth Avenue Dept. H20 New York, N. Y.

FILMGRAPH
VOICE AND MUSIC RECORDINGS

Making your own "Talkies" now possible with newly patented FILMGRAPH. Instantaneous and permanent play-back. Cost of recording only 25c per hour. Over 13 hours of Indexed VOICE, RADIO, CODE, TELEPHONE recording on a single reel of film costing \$3.00 up. Bulletin free.

MILES REPRODUCER CO., INC.
Dept. H.M.A. 812 Broadway New York City

Directory Of Amateur Cine Clubs.

ARIZONA

PHOENIX: Phoenix Movie Club — Fred T. Summerfield, Sec'y, 754 E. Culver St.
TEMPE: Tempe Cine Club (8mm and 16mm) — Howard Lindly, Sec'y, 103 E. 5th St. Meet 2nd Wednesday.

CALIFORNIA

ALHAMBRA: La Casa Movie Club (8mm and 16mm) — H. P. Carnahan, Pres., 21 S. Garfield. Meet 3rd Monday each month.
AZUSA: Sunkist Movie Makers of the San Gabriel Valley (8mm and 16mm) — Albert B. Griffith, Sec'y, 708 E. Bonita Ave. Meet 1st Monday each month.
BERKELEY: Berkeley Amateur Motion Picture Club — Micky Ambrose, Sec'y, 1719 E. 15th St., Oakland.
BURLINGAME: Peninsula Home Movie Club (8mm and 16mm) — Thomas J. Branson, Jr., Sec'y, 125 Lorton Ave. Meet 1st and 3rd Tuesdays, Burlingame Recreation Hall.
EL MONTE: Cine Club (8mm and 16mm) — Mrs. Pegge Leahy, Sec'y, Anderson Photo & Gift Shop.
EL SEGUNDO: South Bay Camera Club — Heath L. Martz, Vice-Pres., 314½ Virginia St.
FRESNO: Fresno Movie Makers — R. C. Denny, Sec'y, 750 Vassar Ave.
GLENDALE: Snicker Flicker Club (8mm and 16mm) — N. Johnson, Sec'y, 1847 Pelanconi Ave.
HANFORD: Kings Camera Club — G. Meldrum, Pres., 206 W. Grangeville Blvd.
HAYWARD: Hayward Cinema Club (8mm and 16mm) — Harvey Reed, Jr., Sec'y, 230 Pearce St. Meet 2nd and 4th Thursdays.
HERMOSA BEACH: Amateur Movie Club of Hermosa Beach — Robert Balfour, Producer.
HIGHLAND PARK: Highland Park 8mm Club (8mm) — Howard Timmons, Sec'y, 4530 W. Avenue 41. Meet 2nd week of month.
LONG BEACH: Long Beach Cinema Club (8mm and 16mm) — Raymond Fosholdt, Sec'y, 134 W. Broadway. Meet 1st and 3rd Wednesday each month at Y.W.C.A.
LOS ANGELES: Los Angeles 8mm Club — Leo Caloia, Sec'y, 143 West Avenue 28. Meet 2nd Tuesday each month.
Los Angeles Cinema Club (8mm and 16mm) — Wm. Hight, Sec'y, 361 N. Formosa Ave. Meet 1st Tuesday each month.
Northeast Home Movie Club (8mm and 16mm) — D. C. White, Pres., 5632 N. Figueroa St. Meet 3rd Friday each month.
Southwest 8mm Club (8mm) — Mrs. W. B. Blanchard, Sec'y, 2127 Glendon Ave. Meet every 3rd Tuesday.
LYNWOOD: Southern Cinema Club (8mm and 16mm) — Don Hunt, Sec'y, 3522 Firestone Blvd., South Gate, Calif. Meet 4th Tuesday each month.
NORTH HOLLYWOOD: North Hollywood Cine Club (8mm and 16mm) — Ted Knight, Sec'y, 4873 Lankershim Blvd. Meet 1st Tuesday each month.
NORWALK: The Tri City Movie Club (8mm and 16mm) — Bert P. Teets, Sec'y, 804 Pine. Meet 1st and 3rd Wednesdays of the month.
OAKLAND: Bay Empire 8mm Movie Club (8mm) — R. J. Shattock, Sec'y, 4132 Opal St. Meet 2nd and 4th Wednesday of month.
The Greater Oakland Motion Picture Club (8mm and 16mm) — B. F. Pratt, Sec'y, 2039 Shattuck Ave., Berkeley. Meet 2nd and 4th Monday each month.
PASADENA: Pasadena Movie Club (8mm and 16mm) — Lloyd G. Rittenhouse, Sec'y, 748 S. Marengo Ave. Meet 3rd Wednesday each month.
POMONA: Pomona Valley Club — T. J. Hebert, 155 S. Garey St.
RED BLUFF: Tehame County Movie Club (8mm and 16mm) — Hank Schafer, Sec'y, 415 Madison St. Meet every 3rd Thursday of the month.
SACRAMENTO: Sacramento Movie Club (8mm and 16mm) — Wilfred Meacham, Sec'y, c/o Associated Oil Company. Meet 1st Thursday of month.
Sacramento Movie Forum — Harold N. Richards, Sec'y, 2427 W. St.
Sierra Camera Club (8mm and 16mm) — John Pardee, Sec'y, 1207 K St. Meet 2nd Tuesday and last Thursday.
SAN DIEGO: San Diego Cinema Club (8mm and 16mm) — G. E. Taylor, Sec'y, 4522 Utah. Meet 2nd and 4th Wednesday each month.
SAN FRANCISCO: Cinema Club of San Francisco (8mm and 16mm) — Edwin L. Sargent, 1980 Washington St. Meet 3rd Tuesday each month.
8-16mm Movie Makers (8mm and 16mm) — Margaret Bauer, 1080 W. 17th St. Meet 1st and 3rd Thursday each month.

• Amateur movie makers interested in joining a cine club may make inquiry of the secretary of the club nearest their vicinity whose headquarters are given on this page.

If you are interested in forming a new cine club, HOME MOVIES will be glad to assist you. You are invited to write to the editors for free data that will be of assistance to you in organizing a club.

Listing of additional clubs will be made to this directory from time to time

as the data is received from club secretaries. Every amateur cine club in the United States, Canada, and Mexico is invited to participate. Clubs not as yet listed are requested to furnish the necessary information for listing.

Stars indicate clubs from whom club-produced films are available to other clubs on exchange basis on payment of transportation charges.

This directory is another of HOME MOVIES' exclusive services for the amateur movie maker.

TERRITORY OF HAWAII

HILLO: The Family Movies Club — P. O. Box 106.
HONOLULU: Honolulu Amateur Cinema Club (8mm and 16mm) — Richard G. Bailey, Sec'y, c/o Nuuanu Y. M. C. A., Fort St. Meet 1st and 3rd Tuesdays each month.

GEORGIA

ATLANTA: Atlanta Movie Club (8mm and 16mm) — Douglas Cone, Sec'y, P. O. Box 74, Station C. Meet 1st and 3rd Friday each month.
THOMASTON: Thomaston Movie Club (16mm and 8mm) — J. Lee Abernathy, Sec'y, 308 W. Main St. Meet every other Sunday.

IDAHO

BOISE: Boise Camera Club (8mm and 16mm) — Mabel M. Sturgis, Sec'y, 1505 N. 15th St. Meet 1st and 3rd Tuesday each month.
NAMPA: Nampa Movie Club (8mm and 16mm) — Art French, Sec'y, c/o Northwest Photo Shop. Meet 1st Monday.

ILLINOIS

BERWYN: Suburban Amateur Movie Club (8mm and 16mm) — John Triska, Sec'y, 2415 S. Highland Ave. Meet 1st and 3rd Mondays each month.
CANTON: Canton Movie Camera Club (8mm and 16mm) — Lefe Drury, Sec'y, Main and Walnut. Meet 2nd and 4th Mondays.
CHICAGO: Camera Adventurers' Club (8mm) — Mrs. Frank H. Crowe, Sec'y, 6508 N. Richmond St.
Chicago Cinematographers — S. F. Warner, 1538 Marengo Ave., Forest Park. Meet 1st Tuesday each month.
Circle Camera Club, 1400 N. Clark St. (8mm and 16mm) — E. J. Etges, Sec'y. Meet every 4th Wednesday.
Commonwealth Edison Camera Club — Arnold R. Hatch, 72 W. Adams St., Room 737.
Lane Tech Movie Club — A. P. Heflin, Sec'y, 2501 Addison St.
Metro Movie Club of River Park (8mm and 16mm) — J. W. Claywell, Sec'y, 5100 N. Francisco Ave. Meet every Wednesday night.
Shutter Snapper Club — Faith Church, Pine and Augusta.
Southcast Cine Club (8mm and 16mm) — B. Fox, Sec'y, 6900 Jeffery Ave. Meet 2nd and 4th Mondays each month.
South Side Cinema Club (8mm and 16mm) — Caroline Hetzner, Sec'y, 7321 St. Lawrence Ave. Meet 2nd and 4th Wednesday each month.
Triangle Cinema League of Chicago (8mm and 16mm) — Leo Brooks, Sec'y, 1528 S. Harding Ave. Meet Sunday afternoons, once or twice a month.
Westlawn Cinema Club — Walter Sengstock, Sec'y, 1517 S. Kostner Ave.
Windy City Movie Club (8mm) — Eddy Moore, Sec'y, 5449 W. Ohio St. Meet last Thursday each month.

EVANSTON: Northwestern Amateur Club.
HOMEWOOD: 3H Camera Club, Movie Division — George Durand, Sec'y, 1750 Linden Rd.
OTTAWA: Ottawa Cine Club — C. F. Grover, Sec'y.
PEKIN: Pekin Cinema Club (8mm and 16mm) — Howard E. Miller, Sec'y, Box 262. Meet every other Monday night.
PEORIA: Peoria Cinema Club, Inc. (8mm and 16mm) — Miss Lena R. Hoerr, Sec'y, 1102 Frye Ave. Meet every 3rd Tuesday.

ROCKFORD: Rockford Movie Makers (8mm and 16mm) — Betty Knudson, Sec'y, 1411 4th Ave. Meet 1st Monday each month.
ROCK ISLAND: Tri-City Cinema Club (8mm and 16mm) — Albert N. Mueller, M.D., 550 26th St. Meet 4th Friday each month.

INDIANA

ELKHART: Conn Camera Club — Florindo Viti, Sec'y, Conn Entertainment and Athletic Ass'n.
FORT WAYNE: Fort Wayne Amateur Cinema Club (8mm and 16mm) — B. J. Olander, Sec'y, 2560 E. Brook Dr. Meet 2nd Monday each month.

FORT WAYNE: The Fort Wayne Movie Club (8mm and 16mm) — L. R. Branderberry, Sec'y, 1406 Kitch St. Meet 2nd Monday each month.

HAMMOND: Calumet Movie Makers (8mm and 16mm) — Gladys Patrick, Sec'y, 5411 Price Pl. Meet every 3rd Monday.

INDIANAPOLIS: Indianapolis Amateur Movie Club (8mm and 16mm) — Alfred F. Kaufman, Sec'y, 4623 N. Arsenal Ave. Meet 1st and 3rd Wednesdays each month.

Indianapolis Bell Camera Club (8mm and 16mm) — E. J. Rohrman, 2242 Union St.

Public Service Company Camera Club — James Genders, Sec'y, 4935 W. 11th St.
Super-Art Productions of Indianapolis — W. Stuart Bussey, 17 E. St. Joseph St.

VINCENNES: Vincennes Camera Club (8mm and 16mm) — Robert M. Johnson. Meet 1st Thursday.

IOWA

DES MOINES: Y. M. C. A. Movie and Camera Club of Des Moines (8mm and 16mm) — Mary H. Platt, Sec'y, 3223 2nd St.

NEWTON: Newton Amateur Cinema Club (8mm and 16mm) — Merlin D. Willis, Sec'y, Box 665. Meets 2nd Monday each month.

SIoux CITY: Amateur Cinema Club of Sioux City (8mm and 16mm) — Don Goodwin, Sec'y, 3733 7th Ave. Meet 3rd Tuesday each month at Hunt School.

KANSAS

PRATT: Camera Club (16mm and 8mm) — Benjamin F. Henry, First Presbyterian Church.

WICHITA: Wichita Amateur Movie Club — Mrs. Martin Lentz, Sec'y, Martin W. Lentz Co., 111 W. William St.

MARYLAND

PARKVILLE: Parkville Amateur Cinema Club (8mm and 16mm) — G. E. Aro, Sec'y, 2806 Linwood Ave.

MASSACHUSETTS

ATTLEBORO: Attleboro Movie Club — Francis J. O'Neil, 37 Pleasant St.

BOSTON: Boston Cinamateur Club (8mm and 16mm) — Fannie Tinkham, Sec'y, Cambridge Photographic Society, 631 Massachusetts Ave. Meet 2nd and 4th Mondays.

HOLYOKE: Prospect Movie Camera Club (8mm and 16mm) — Henry M. Bader, Sec'y, 19 Charles St. Meet 1st Monday each month.

LOWELL: Lowell Amateur Cinema Club — Leslie R. Lawson, Sec'y, 311 Westford St.

LYNN: Greater Lynn Camera Club, Movie Division — Max Hurwitz, Sec'y, 46 Central Square.

PITTSFIELD: Berkshire Museum Camera Club (8mm and 16mm) — A. C. Hindle, Sec'y, 19 North St. Meet 2nd Wednesday each month.

SOUTHBRIDGE: ★ Southbridge Amateur Movie Makers Club (8mm and 16mm) — Joseph R. Seremet, Sec'y, 124 Highland St. Meet 2nd Friday each month.

MICHIGAN

BATTLE CREEK: Photographic Society of Battle Creek (8mm and 16mm) — Neil E. Elliott, Sec'y, 215 Fairfield Ave.

DETROIT: Detroit Society of Cinematographers (8mm and 16mm) — James A. Harris, Sec'y, c/o McGregor Library. Meet 4th Monday.

FLINT: Flint Amateur Movie Club — Lynn J. DePree, 2006 Mountain Ave. Meet 1st Wednesday each month.

JACKSON: Jackson Amateur 8mm Camera Club (8mm) — Lila O. Redinger, Sec'y, 1040 S. Jackson St. Meet 3rd Friday each month.

KALAMAZOO: Kalamazoo 8mm Cinematographers (8mm) — Grant Kinch, Pres., 806 S. Park. Meet 1st and 3rd Thursdays.

LANSING: Capitol Camera Club (8mm and 16mm) — R. B. Gould, Sec'y, 1414 Corbett St. Meet 2nd Monday each month.

LAPEER: Lapeer Cinema Club (8mm and 16mm) — Peter Skeberdis, Sec'y, 1665 Inlay City Rd. Meet 3rd Tuesday of each month.

PONTIAC: ★ Pontiac Amateur Cinematographers (8mm and 16mm) — Welton J. Jones, 583 E. Tennyson. Meet 1st Monday each month.

SAGINAW: The Saginaw Movie Club (8mm and 16mm) — Clarence R. Krueger, Sec'y, P. O. Box 671. Meet every other Thursday.

MINNESOTA

AUSTIN: Austin Camera Club (8mm and 16mm) — Lon Enochson, Sec'y, 205 N. 2nd St. Meet 2nd Tuesday each month.
MINNEAPOLIS: Minneapolis Octo-Cine Guild (8mm) — C. G. Crosby, Sec'y, 5617 12th Avenue S. Meet last Thursday each month.

Minneapolis Cine Club (8mm and 16mm) — Dr. Reinhold Ericson, Sec'y, c/o R. A. Riebeth, P. O. Box 22, Commerce Station, Minneapolis.
 Suburban Cine Club (8mm and 16mm) — J. M. Devoy, Sec'y, 309 Blake Rd., Hopkins. Meet last Thursday.
 ST. PAUL: Gopher Movie Club (8mm and 16mm) — Mrs. L. T. Thiets, Sec'y, 580 Wentworth. Meet last Friday of each month.
 St. Paul Amateur Movie Makers (8mm and 16mm) — Walter Gayman, Sec'y, 314 W. Kellogg Blvd. Meet 1st and 3rd Tuesday each month.
 Metropolitan Cine Club (8mm and 16mm) — T. C. Hotchkiss, Sec'y, 303 S. Cleveland Ave. Meet 1st and 3rd Wednesdays.

MISSOURI

KANSAS CITY: The Heart of America Movie Club (8mm and 16mm) — Cooper Jenkins, Sec'y, 616 W. 26th St. Meet 1st Monday of each month.
 Kansas City Cinema Club (8mm and 16mm) — E. P. Witte, Sec'y, 3125 Broadway. Meet 2nd and 4th Wednesday each month.
 ST. JOSEPH: St. Joseph Amateur Movie Camera Club (8mm and 16mm) — Ruthanna Beard, Sec'y, 610 E. Missouri Ave. Meet 2nd and 4th Wednesdays.
 ST. LOUIS: Amateur Motion Picture Club of St. Louis (8mm and 16mm) — Miss Eloise Koch, Sec'y, 2738 Accomac St. Meet 2nd Wednesday each month.

MONTANA

BILLINGS: Billings Movie Club — Louis M. Moos, Sec'y, 311 Wyoming.

NEW JERSEY

BAYONNE: Bayonne Cine Club (8mm and 16mm) — Thos. A. Dolan, Sec'y, 232 Danforth Ave., Jersey City. Meet 2nd and 4th Fridays.
 Bayonne Amateur Cine Club (8mm and 16mm) — F. Robert Gross, Sec'y, Industrial Y. M. C. A., 22nd St. and Ave. A. Meet 1st and 3rd Friday each month.
 CLIFTON: Clifton Cinema Club (8mm and 16mm) — J. G. Elgersma, Sec'y, 43 Sears Pl.
 EAST ORANGE: Cinema Club of the Oranges (8mm and 16mm) — Gordon T. Butz, Sec'y, 480 Clifton Ave., Newark. Meet 3rd Friday each month.
 MAPLE SHADE: The Wedgewood-Draper Club (8mm) — William Hoover, Sec'y. Meet 2nd and 4th Wednesdays.
 MAPLEWOOD: The Maplewood Amateur Movie Club (8mm and 16mm) — Mrs. Fred W. Miller, Sec'y, 13 Rynda Rd.
 MILLBURN: Gibraltar 8mm Club (8mm) — M. H. Sanders, 85 Greenwood Dr.
 NUTLEY: ★Cinemem Club of North Essex (8mm and 16mm) — J. E. Nestell, Sec'y, 18 Shepard Pl. Meet 3rd Thursday each month.

PASSAIC: Passaic Y. M. C. A. Cinema Club.
 TRENTON: Trenton Movie Makers (8mm and 16mm) — Jules Y. Shein, Sec'y, 521 S. Warren St. Meet either 1st or 2nd Friday each month.

NEW YORK

BINGHAMTON: Cinema Club of The Triple Cities — Edwin Moody, Sec'y.
 BRONX: Bronx Amateur Cinema Club (8mm and 16mm) — Nicholas H. Zella, Sec'y, 384 E. 193rd St.
 BROOKLYN: Brooklyn Amateur Cine Club — Irving Pollock, Pres., 91-01 64th Rd., Rego Park, L. I. Meet every two weeks.
 BUFFALO: Amateur Cinema Club of Buffalo — Edward C. Denny, Sec'y, 385 La Salle Ave.
 Niagara Cinema League (8mm and 16mm) — K. N. Hadley, Sec'y, 103 Villa Ave. Meet 3rd Wednesday each month.
 ELMIRA: Southern Tier Cinema Club (8mm and 16mm) — Wm. J. McCarthy, Sec'y, 504 Dewitt Ave. Meet last Friday each month.
 JOHNSON CITY: I. B. M. Cinematographer's Club — W. M. Muir, Pres., R.D. No. 2.
 LONG ISLAND: Queens Cine Club (8mm and 16mm) — Jack Jacoby, 103-17 125th St., Richmond Hills, L. I.
 MOUNT KISCO: Mount Kisco Cinemats (16mm) — Robert F. Gowen, Sec'y, Chilmark Park, Assining, N. Y. Meet 1st Monday of each month.
 MOUNT VERNON: Mount Vernon Movie Makers (8mm and 16mm) — N. W. Knight, Sec'y, 258 Westchester Ave. Meet 3rd Tuesday.
 NEWBURGH: Newburgh Amateur Cinema Club (8mm and 16mm) — Robert S. Kelly, Sec'y, 217 North St. Meet 2nd Thursday each month.

NEW YORK CITY: Metropolitan Motion Picture Club, Inc. (8mm and 16mm) — Robert M. Coles, Sec'y, 35 E. 20th St. Meet 2nd Thursday each month.
 Graphic Photo Guild — 1924 Washington Ave. Nat Rosenthal, Recording Sec'y.
 New York City 8mm Motion Picture Club — Walter C. Mills, 35 Park View Rd., Bronxville. Meet 3rd Monday.
 Telephone Camera Club of Manhattan — Thos. G. Herendeen, Room 1958, 195 Broadway.
 PEEKSKILL: Peekskill Sport Center, Inc., 830 South St.

ROCHESTER: Rochester Amateur Movie Club (8mm and 16mm) — D. W. MacFarlane, Sec'y, 52 Edgemoor Rd. Meet 1st and 3rd Thursdays each month.
 ROCKVILLE CENTER, L. I.: Rockville Amateur Cinema Club.

SCHENECTADY: Schenectady Photographic Society Movie Group (8mm and 16mm) — E. H. MacMullen, Sec'y, 13 State St. Meet 1st Wednesday each month.

STATEN ISLAND: Staten Island Cinema Club (8mm and 16mm) — Frank E. Gunnell, Sec'y, 34 Colonial Court, West New Brighton. Meet 2nd Tuesday each month.

Staten Island Movie Makers (8mm and 16mm) — Harry S. Wilson, Sec'y, 34 Rokeby Pl.

SYRACUSE: Syracuse Amateur Movie Makers (8mm and 16mm) — Benjamin Franklin, Sec'y, 221 Marguerite Ave. Meet every other Monday.

VALLEY STREAM, L. I.: Valley Stream Camera Club (8mm and 16mm) — John H. Trunk, Sec'y, 34 Cherry St. Meet 1st and 3rd Wednesday each month.

NORTH CAROLINA

MORGANTON: Morganton Camera Club, Movie Division — Edw. H. Hairfield, Jr., Sec'y, Box 793.

OHIO

AKRON: Buckeye Camera Guild (8mm and 16mm) — W. G. Marksity, Sec'y, 1080 Brown St. Meet every other Monday.

CLEVELAND: Arema Club (8mm and 16mm) — L. C. Neuffer, Pres., Box 1719. Meet every 3rd Tuesday.

Cine Hobbyist (8mm and 16mm) — Harold Munv, 2709 Mayfield Road, Cleveland Heights. Meet every Friday night.

Cleveland Amateur Cinematographers (8mm and 16mm) — Miss Dorothy Boetticher, Sec'y, 1394 W. 3rd St., c/o Strong, Carliss & Hammond Co. Meet 1st and 3rd Wednesdays each month in Hotel Carter.

COLUMBUS: Columbus Movie Makers — Arthur Robinson, Sec'y, 34 N. 3rd St.

DAYTON: Cinema Research Club — F. H. Bickford, Jr., Chairman, 1529 S. Broadway.

Dayton Cinema League — P. C. Beach, Sec'y, 2240 E. 5th St.

FINDLAY: Findlay Camera Club — Ralph L. Stears, Sec'y, 208 Lark St.

GALION: Galion Camera Club (8mm and 16mm) — Mary Postance, Sec'y, 377 N. Market St. Meet 1st and 3rd Tuesdays each month.

HAMILTON: The Movie Makers Club — Clinton W. Bergen, Pres., 1269 Harmon Ave.

MANSFIELD: Mansfield Movie Club — Dr. L. B. McCullough, 78 Park Ave. W.

MOUNDSVILLE: Trojan Production Co. — Jacquelyn Rusen, Sec'y.

MOUNT VERNON: Mount Vernon Camera Club (8mm and 16mm) — Frank J. Van Vorhis, Sec'y, 306 N. Main St. Meet 1st and 3rd Tuesdays each month.

NORTH CANTON: North Canton Cinema Club (8mm and 16mm) — R. L. Wearstler, Sec'y, R. D. 6, E. Maple St. Ext. Meet 1st Friday each month.

SPRINGFIELD: Springfield Flicker Club — Alfred W. Schmid, Sec'y, 17½ W. Grand Ave.

TOLEDO: The Toledo Cine Club (8mm and 16mm) — 517 Madison Ave. H. Kline, Sec'y, 4613 Whiteford Rd. Meet 3rd and 4th Mondays.

NEWARK: Y.M.C.A. Movie Makers (8mm and 16mm) — C. I. Grimm, Pres., Arcade Annex. Meet 1st and 3rd Wednesdays.

WOOSTER: Wooster Amateur Movie Makers (8mm and 16mm) — Howard W. Keister, Sec'y, 218 W. University St. Meet 3rd Monday each month.

YOUNGSTOWN: Youngstown Amateur Movie Club (8mm and 16mm) — Fred Deiter, Sec'y, 52 Wesley Ave. Meet 1st and 3rd Mondays.

OKLAHOMA

NOWATA: Nowata Movie Club (8mm and 16mm) — Miss Thelma Hagan, Sec'y, 802 S. Peran St. Meet 1st Friday each month.

OKLAHOMA CITY: Movie Makers Club of Oklahoma City — Mary Francis, Sec'y, 312 Fidelity Bldg.

TULSA: Tulsa Am-Mo Club — J. B. Close, Pres., Box 854. Meet 1st and 3rd Wednesdays.

OREGON

EUGENE: Cascade Lens and Screen Club (8mm and 16mm) — Lynn Harris, 1511 Moss St.

MEDFORD: Medford Movie Club (16mm) — Mrs. George F. Tucker, Sec'y, 37 Kenwood Ave. Meet 3rd Saturday.

NORTH BEND: Coos Bay Camera Club (8mm and 16mm) — Ernest Rollins, General Delivery.

Southern Oregon Cinema Club — W. Bernard Roberts, Pres., 922 Reddy Ave.

PORTLAND: Portland Cine Club, Inc. (8mm and 16mm) — Arthur E. Gibbs, Sec'y, 1925 N. E. Knott St.

PENNSYLVANIA

ALLENTOWN: Allentown Y. M. C. A. Cinema Club — Aral M. Hollenbach, Sec'y, 1229 N. 19th St.

EAST MCKEESPORT: Amateur Cinematographers of East McKeesport (8mm and 16mm) — J. J. Carbaugh, 914 4th St., East McKeesport.

LEBANON: Lebanon Valley Camera Club (8mm and 16mm) — George Kline, Sec'y, 470 N. 4th St.

NORRISTOWN: Mrs. Mary Leonard, Sec'y (8mm and 16mm), 618 De Kalb St. Meet every 3rd Monday.

PHILADELPHIA: 8-8 Club (8mm) — Mrs. Robert H. Connor, Sec'y, 6707 Linmore Ave. Meet 1st and 3rd Thursday each month.

★The 8-16 Movie Club — Louis Sobel, Sec'y, 4916 Ormes St.

Philadelphia Cinema Club (8mm and 16mm) — George A. Pittman, Sec'y, 1808 E. Tulphocken St. Meet 2nd Tuesday each month.

PITTSBURGH: Pittsburgh Amateur Cinema Club (8mm and 16mm) — Miss Rose Goldman, Sec'y, 319 Amber St. Meet 1st and 3rd Wednesday each month.

North End Cinema Club (8mm and 16mm) — R. C. Straka, Sec'y, 1711 Harpster St., N. W. Pittsburgh. Meet 1st and 3rd Tuesdays of each month.
 North Borough's Y. M. C. A., 629 Lincoln Ave., Bellevue.

POTTSTOWN: Pottstown 8mm Movie Club (8mm) — Wm. J. Weiss, Sec'y, 874 N. Charlotte St. Meet 1st Tuesday each month.

READING: Berks Camera Club (8mm and 16mm) — Stephen Lawrence, 310 N. 12th St. Meet every Monday night.

SUNBURY: Sunbury Amateur Cinema Club (8mm and 16mm) — David Lenker, Sec'y, 346 Chestnut St. Meet 1st and 3rd Mondays.

SOUTH DAKOTA

SIOUX FALLS: Sioux Falls Amateur Cine Club — (16mm and 8mm) — H. E. Hanson Harold's, 308 S. Phillips Ave. Meet 1st Monday each month.

YANKTOWN: Yanktown Camera Club — Arthur J. Smith, Pres., 414 Capitol St.

TENNESSEE

JACKSONVILLE: Jacksonville Movie Makers, P. O. Box 56.

MEMPHIS: W. G. Snowden, Sec'y, Box 2073, DeSoto Station.

TEXAS

DALLAS: Dallas Cine Club — Stan Everman, Pres., 1504 Young St.

FORT WORTH: Movie Makers Club (8mm and 16mm) — J. C. Duvall, Pres., 604 Burk-Burnett Bldg.

LUBBOCK: The Hub Cine Club (8mm) — E. M. Copp, Sec'y, 1608 23rd St. Meet every other Monday.

UTAH

LOGAN: Logan Amateur Cinema Club (8mm and 16mm) — Mrs. E. L. Hansen, Sec'y, Logan, Utah.

SALT LAKE CITY: Utah Amateur Movie Club (8mm and 16mm) — C. F. Solomon, Jr., Sec'y, 1471 Browning Ave. Meet 2nd Monday of each month.

VIRGINIA

LYNCHBURG: Hill City 8 Movie Club (8mm) — Nowlin Puckett, Corresponding Sec'y, 822 Floyd St. Meet once a month.

NORFOLK: Norfolk Amateur Movie Club (8mm and 16mm) — Claude D. McMillan, Jr., Sec'y, 720 Carolina Ave. Meets 3rd Tuesday.

WASHINGTON

EVERETT: The Home Movie Club of Suohomish County (8mm and 16mm) — C. L. Arnold, Sec'y, Box 702B, Route 3. Meet 2nd Tuesday each month.

SEATTLE: Northwest Amateur Cinema League — Carlos E. Grant, 915 Green Bldg., Seattle, Wash.

Roosevelt Movie Club (16mm) — Jayne Stokes, Sec'y, Roosevelt High School, 2032 Franklin Ave. Meet every other Wednesday.

★Seattle 8mm Club (8mm) — W. B. Bowden, Sec'y, 546 Dexter Horton Bldg. Meet 2nd Tuesday each month.

TACOMA: Tacoma Cinema Club (16mm) — Don Flag, Sec'y, 829 S. Ferry St. Meet 4th Monday each month.

WALLA WALLA: Walla Walla Cinema Club (8mm and 16mm) — Cromie L. Wilson, Sec'y, 715 Catherine St. Meet 4th Monday.

WENATCHEE: Wenatchee Cine Club (8mm and 16mm) — Evelyn Shotwell, Sec'y, Box 920.

YAKIMA: Yakima Amateur Movie Club (8mm and 16mm) — William Hassell, Pres., 1208 W. Yakima Ave. Meet 4th Wednesday.

Amateur Movie Club: Paul Thompson, Pres., 709 S. 4th St.

WEST VIRGINIA

HUNTINGTON: Huntington YMCA Amateur Movie Club (8mm and 16mm) — James Warfuel, Sec'y, 629 6th St. Meet each 3rd Friday.

TRIADPHIA: St. Vincent's Cinematic Club — E. Dietrich, Rt. 1, Box 93.

WHEELING: ★Cinematography Group of the Ohio Valley Camera Club (8mm and 16mm) — R. E. Dempster, 162 15th St. Meet every other Friday.

WISCONSIN

FOND DU LAC: Fond du Lac Camera Club (8mm and 16mm) — Miss Mildred E. Weber, Sec'y, 333 S. Marr St. Meet 4th Monday each month.

MADISON: Cine 8 Club — Ruth Hoffman, Sec'y, 535 W. Dayton St. Meet 1st Tuesday each month.

Maple Bluff Camera Club — John B. Casaday, Sec'y, 1005 Power & Light Bldg.

MILWAUKEE: The Amateur Movie Society of Milwaukee (8mm and 16mm) — Miss Parmelia M. Mills, Sec'y, 530 N. 20th St. Meet 2nd and 4th Wednesday.

City Club of Milwaukee (8mm and 16mm) — E. H. Hallows, Chairman, 756 N. Milwaukee St. Meet 3rd Friday each month.

Cream City Cinema Club — E. R. Glaesner, Sec'y, 3730 W. Lisbon Ave.

Globe Movie Makers (8mm and 16mm) — Paul Barkhauser, 413 E. Dean Road.

Milwaukee Movie Makers — Harold Francke, Sec'y, 1926 E. Fernwood Ave.

NEENAH: The Winnebago Camera Club, Movie Division — Duane Raiche, Sec'y, 247 4th St.

WINNEBAGO: Oshkosh Cine Club (8mm and 16mm) — Edw. L. Fredrick, Sec'y, c/o Winnebago State Hospital. Meet 3rd Friday each month.

WYOMING

CASPER: Casper Amateur Motion Picture Club (8mm and 16mm) — A. F. Everitts, Sec'y, 1544 S. Cedar St. Meet 1st Tuesday each month.

LOVELL: Lovell Camera Club (8mm and 16mm) — J. T. Fuller, Pres., 521 Montana Ave. Meet 4th Thursday each month.

CANADA

CALGARY, ALBERTA: Calgary Amateur Motion Picture Club (8mm and 16mm) — Mrs. A. F. McKenna, 2316 2nd St. W. Meet 3rd Thursday each month.

EDMONTON, ALBERTA: The Edmonton Cine Club (8mm and 16mm) — H. B. Holloway, Sec'y, Ste. 2, 10617 98th Ave. Meet 1st and 3rd Monday each month.

NEW CLUBS FORMING

● Cinefilmmers interested in joining a new amateur club now forming in Los Angeles are invited to communicate with C. H. Dillinger, 725 Venice Boulevard, Los Angeles, or phone Richmond 0225. The club is open to both 8mm and 16mm fans.

● A new amateur cine club is to be formed in Marin County, Calif., for both 8mm and 16mm movie makers, and will be known as the Marin Movie Club. Amateurs interested in becoming a member are urged to communicate with Ed Steacy, 226 Sir Francis Drake Blvd., San Anselmo, Calif.

● Movie amateurs — both 8mm and 16mm — residing in South Bend, Ind., and vicinity will be interested to know a new cine club is being formed by L. E. Collier, 706 East Pennsylvania Avenue, of that city. Those interested in becoming a member of this new club are asked to communicate with Mr. Collier.

● Edward W. Turner, 73 Fourth Street, Norwich, Conn., is interested in hearing from other 8mm and 16mm amateurs in his vicinity interested in forming a club.

● 8mm and 16mm cine fans residing in Oroville, California, and vicinity who are interested in joining an amateur cine club now forming are requested to communicate with Jack Mayr of that city.



TITLE Backgrounds

By FELIX ZELENKA

SHARING this page with the usual title backgrounds this month is another series of animated title backgrounds which amateurs, interested in this phase of title making, will find appropriate for the main title of their Holiday pictures. The movement in this series is the smoke spiraling lazily skyward and the snowflakes. Close inspection of each drawing will reveal that each of the snowflakes in drawing number 1, move one step downward and towards the right with each successive drawing.

Thus, the drawings, filmed in order—1, 2, 3, 4, and 5, and then repeating 1, 2, 3, 4, and 5 as often as required will give an animated picture of the smoking chimney and falling snowflakes.

To superimpose the title lettering over the drawings letter the title text with india ink or poster color on a small panel of clear celluloid and lay it over the drawings as they are photographed.

Care must be taken to line up each drawing accurately in the titler each time. If this is not done either or both the title letters and the background will jump about on the screen. Full details for animating title backgrounds of this size appeared on page 477 of the October issue and it would be advisable to review it again before proceeding with filming the animated title drawings appearing on this page.

Recommended is an exposure of two frames for each drawing to insure smoothest action. For faster action, shoot one frame per drawing. It is important also to shoot the drawings in complete rotation, i. e., 1, 2, 3, 4, and 5; 1, 2, 3, 4, and 5; and etc.

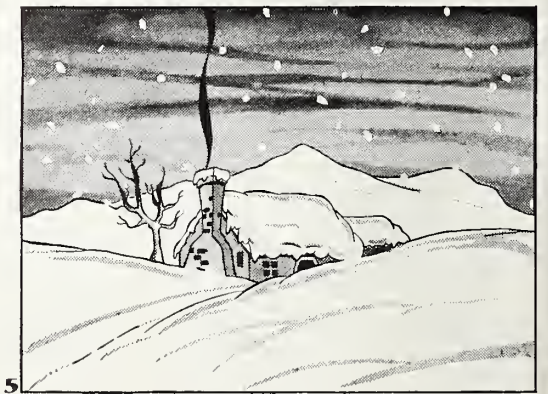
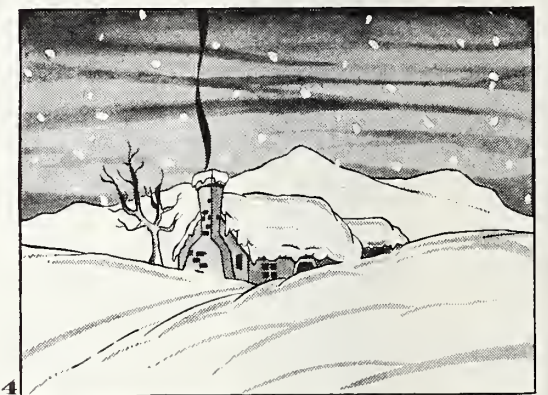
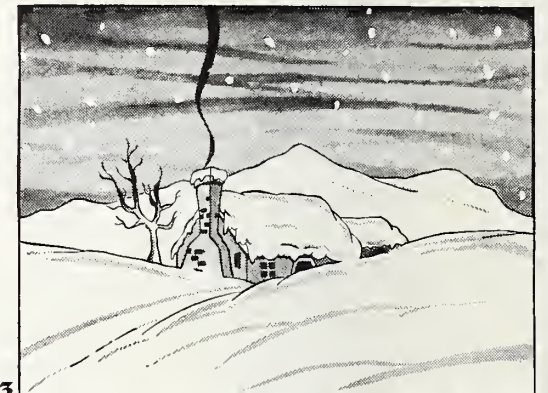

CLASSIFIED

ADVERTISING

EQUIPMENT FOR SALE

● BASS SAYS: Merry Christmas! Here are gifts for you with money left over because of low prices.

USED CAMERAS

8mm Cine Kodak Model 20, F:3.5 lens, \$19.75.
8mm Cine Kodak Model 20, F:2.5 lens, \$27.75.
8mm Cine Kodak Model 60, F:1.9 lens, \$49.50.
8mm Movikon, F:2 lens, case, \$137.50.
16mm Cine BB, F:1.9 lens, with case, \$37.50.
16mm Filmo 70-A, F:3.5 Cooke lens, and case, \$37.50.
Bell & Howell 16mm Model 141 Magazine, Cooke F:2.7, \$75.00.
Bell & Howell 16mm Model 141 Magazine, Wollensak F:1.5 in focusing mount, \$92.50.
Victor 16mm Model 5, 1" F:3.5, 2" F:3.5, 3" F:4 lenses, \$107.50.
Bolex 16, Hektor F:1.4 lens with carrying case, \$225.00.

USED PROJECTOR BARGAINS

16mm Kodascope B, automatic threading, with case, \$32.50.
16mm Keystone A-81, 750 watt, \$45.00.
16mm Bell & Howell Diplomat, 750 watt, with case, \$135.00.
16mm Bell & Howell Showmaster, 1600 foot reels, with case, \$142.50.
For trades that are fair and for everything in Cine apparatus, 8mm, 16mm or sound, you must send for our 84-page Bass Cine Bargaingram, most complete exposition of Cine equipment. Free on request.

BASS CAMERA COMPANY

Dept. HC 179 W. Madison St. Chicago, Ill.

HOLIDAY SPECIALS

● Keystone Cameras and Projectors Like New.
16mm Models A-7 camera—F:1.5 lens—\$57.00
F:2.7 lens—\$35.00
Model B-1—F:3.5 lens—\$24.00
Projectors—C-16—200 watt—\$19.75
A-72—300 watt—\$35.50
A-81—750 watt—\$55.00
8mm K-8 camera—F:3.5 lens—\$21.50
F:2.5 lens—\$27.50
Projectors—CC-8—300 watt—\$23.75
R-8—500 watt—\$39.75
Excel camera Model 40, like new—\$20.00

BULK FILM

AEROCHROME REVERSAL
Speed 8-2—400 ft. 100 ft.
Double 8 or 16mm—\$3.75 \$1.25
AEROPAN REVERSAL
Speed 24-16—400 ft. 100 ft.
Double 8 or 16mm—\$11.25 \$3.10
SUPERAERO PAN
Speed 50-40—400 ft. 100 ft.
Double 8 or 16mm—\$12.50 \$3.40
Copying—2 1/2 c ft.
Printing—3 c ft.

Full line of chemicals and accessories, Castle Film Library, R. C. CAMERA & PHOTO SUPPLY CO., 3357 E 66 St., Cleveland, Ohio.

● LIST PRICE ALLOWED for your Eastman Model 20 or Keystone F:3.5 toward purchase of Bell-Howell Sposter, Eastman 8mm Magazine, or Revere Turret. List price allowed for Eastman Model 25, Keystone F:2.7, Revere 3.5, or Bell-Howell Companion, toward new 8mm Eastman Magazine. List price allowed for Model 90 projector toward new Ampro 8mm or Bell-Howell 8mm projector. AS NEW: Bell-Howell Sportster with Wind-Bak, \$75. Bell-Howell Companion with Wind-Bak, \$49.50. Bell-Howell Turret with Wind-Bak, \$129.50. Model 60 Eastman F:1.9, list price \$67.50, priced at \$42.50. 1 1/2" F:3.5 Telephoto for Bell & Howell, \$33.50; for Keystone, \$27.50. 2" F:1.9 Dallmeyer lens, \$49.50. 1" F:1.3 Laack Lens, \$39.50. 15mm F:1.5 Dallmeyer lens, \$49.50. 30 x 40 beaded screen with tripod, \$5.95; 36 x 48, \$10.50; 39 x 52, \$12.50. Hundreds of other bargains. Most liberal traders in the country. Write NATIONAL CAMERA EXCHANGE, established 1914, 11 So. 5th St., Minneapolis, Minn.

● AMPRO PROJECTOR—Practically new, 16mm, 750-watt, pilot light, new bulb, fully reconditioned. Cost \$175, will sacrifice for \$95.00. Box 5, HOME MOVIES, 6060 Sunset Blvd., Hollywood, Calif.

● CINE KODAK Model K with F:1.9 lens; leather case. Cost \$90.00. Sell for \$55.00. J. D. PHILLIPPI, 417 Montgomery, San Francisco.

● VICTOR Model 4, 16mm with 1" F:1.5; 15mm F:2.7; and 2" F:1.9. Like new—used very little, \$145.00, including case. Also Keystone projector, 750 watt model A-81 and case, \$45.00. HALLERBERG, 7832 S. Winchester, Chicago, Ill.

● VICTOR 16mm Sound-on-disc projector, 24 frames, 750 watt, \$75.00. J FULLER, 17018 Kenyon Rd., Shaker Heights, Ohio.

● 16MM ENLARGER. Made by Eastman, with projector for lamphouse. Gives enlargement approximately 4x5 of your 16mm frame. Can also be used as viewer for editing. Originally sold for \$90.00. The first \$20.00 takes it. Perfect con-

● Ten cents per word; minimum charge, \$2.00 cash with order. Closing date, tenth of preceding month. ● HOME MOVIES does not guarantee goods advertised.
● Send ads to 6060 Sunset Boulevard, Hollywood, California.

EQUIPMENT FOR SALE

dition. Box RR, Home Movies Magazine, 6060 Sunset Blvd., Hollywood, Calif.

● BARGAINS in used, like new, Keystone K-8, F:3.5, \$15.50; Keystone K-8, F:2.7, \$20.00; Kodak model 90 magazine, \$65.50; Wollensak telephoto, 1 1/2" focus, F:3.5, \$21.50; R-8 projector, 500 watts, \$28.00; Kodak model 70 projector, 8mm, \$46.00; new Keystone K-8, F:3.5, \$23.85; new R-8 projector, \$44.78. Will accept trade ins. MALENA CO., 616 Market St., Philadelphia, Pa.

EQUIPMENT FOR SALE

● SLIGHTLY USED, like new, Keystone 8mm camera, \$14.50, Telephoto lens, F:1.5 for Keystone or Revere cameras, \$12.50. Trade in your old camera, projector. MALENA CO., 616 Market St., Philadelphia, Pa.

● PROJECTOR, combination 16mm and 8mm Ditmar. You can show either 16mm or 8mm pictures on this 500-watt projector. Switchover very simple. Original price more than \$200.00. For quick sale, \$125.00. A-1 condition. Box RT, Home Movies Magazine, 6060 Sunset Blvd., Hollywood, Calif.

EQUIPMENT FOR SALE

● PAILLARD BOLEX Headquarters for the West is Morgan Camera Shop. Try the multi-featured Bolex 16mm or 8mm camera before buying. See them at 6262 Sunset Blvd., Hollywood, California.

● MOVIE Cameras, Films, Projectors, etc., bought, sold, and exchanged. Big lists Free. Art samples, 25c. PEERLESS, Box 1310-H, Hollywood, Calif.

● BARGAINS galore! 16mm—8mm projectors, supplies, library films. Complete home movie listings, Free. NO-WAT-KA, 11 River Drive, Passaic, N. J.

FILM RELEASES

● 8MM FILMS! Purchase one subject, screen 125 subjects on low-cost exchange basis. Write RIEDEL FILMS, 2221 W. 67th St., Cleveland, Ohio.

● NEW TRAVELOGUES—over 200 feet, \$1.75. Free Storage can. Art sample, dime, re-ferred. ARTCRAFT, 1219 East 6th Ave., Gary, Ind.

● LATEST 8-16mm War, Comedy, Travel, Unusual Subjects. Send 10c for sample and lists. A personal service. RIO, 413-H Elmira, N. Y.

● SOUND and Silent Films exchanged, bought, sold, rented. Bargains always. New Free lists FRANK LANE, 5 Little Bldg., Boston, Mass

● UNUSUAL ART Film Catalogue. All latest releases. Send 10c for sample. ERWINES CINE LABORATORIES, 43 North Ninth St., Allentown, Pa.

● LARGEST 8mm—16mm Rental Library. We pay both ways. Send for free Catalogue. ABBE FILMS, 1265 Broadway, New York City.

TITLING SERVICE

● TITLES printed, eight words or less—8mm, 15c; 16mm, 20c. Minimum order, \$1.50. Samples and complete hand lettered "The End," 10c. State size, MIDWEST TITLE SERVICE, 1024 Quincy, Topeka, Kansas.

● MAIN TITLES—hand set. Distinctive photographic backgrounds. 3 for \$1.00. Send trial order or write for samples. CINE-KRAFT, Mankato, Minn.

PROCESSING SERVICE

● MOTION PICTURE Processing—100' 16mm 75c; 50' 16mm, 50c; 25' 8/16mm, 35c; 25' 8mm, 25c. Write for film price list. RITTER FILM SERVICE, 629 Lyman Ave., Oak Park, Ill.

EXCHANGE OR TRADE

● SHOTGUNS. Target Pistols and Binoculars accepted in trade on everything photographic, including Liecas, Contaxes, Eastman and Bell & Howell motion picture equipment and Da-Lite Screens. Write for Catalog. Convenient time payments may be arranged on anything new or used. NATIONAL CAMERA EXCHANGE. Established in 1914. 11 So. Fifth St., Minneapolis, Minn.

WANTED

● BERNDT-MAURER recorder and camera, other 8-16-35mm cameras, lenses, accessories; projectors, sound—silent. Write, giving lowest prices. CAMERA MART, INC., Dept. "G," 70 West 45th St., New York.

HOBBY BOOKS

● Are you a "beginner" in the ranks of amateur movie makers? Would you like to know how to use your camera to the very best advantage, yet avoid the mistakes and wasted film that so often results from lack of knowledge of fundamentals of cine camera operation? Then order a copy of "How to Use a Movie Camera." Just 50c, and well worth it.

Would you like to learn how to process your own movie film so that you can buy inexpensive film in bulk? Let us send you "How to Process Home Movie Film," a book chock full of instructions and advice by experts plus complete, easy-to-understand plans for building your own simple processing equipment. Sent postpaid for 50c.

Would you like to know how to make your own titles? What equipment to use—what exposure to use—all about auxiliary lenses—title areas, etc? Would you like complete plans for building a very simple and versatile home movie titler? Then send for "How to Title Home Movies"—the latest and one of the most authentic books ever written on the subject. Price \$1.00 per copy. We pay the postage.

VER HALEN PUBLICATIONS
6060 Sunset Blvd. Hollywood, Calif.

Join now . . . !

The REEL FELLOWS

Sponsored exclusively by Home Movies Magazine, the REEL FELLOWS is a friendly, chummy, coast-to-coast organization of movie amateurs whose purpose is to further the pleasure of amateur movie making and to encourage a wider and more beneficial contact among amateurs.

If you shoot 8mm or 16mm movies, or if you are interested in any of the aspects of amateur movie making, you are invited to become a member of the REEL FELLOWS. \$1.00 membership fee is so low no amateur can afford not to join.

Wear your REEL FELLOWS pin to identify you wherever you go! Upon receipt of your membership application, you will be sent membership card, gold pin, and insignia for your camera. Be the first in your community to join! Fill out the REEL FELLOWS membership application below and send it in immediately!

DETACH HERE

MEMBERSHIP APPLICATION

THE REEL FELLOWS

REEL FELLOWS
c/o Home Movies
6060 Sunset Boulevard
Hollywood, Calif.

I am enclosing \$1.00 membership fee, for which please enroll me as a member of the REEL FELLOWS and send me membership card, gold pin, and camera insignia.

I have been shooting movies (length of time).....

My equipment is: 8mm16mm.....

Name.....

Address.....

City..... State.....

ANNUAL INDEX

HOME MOVIES

VOLUME VII — 1940

Index by Titles

Page	
2	..The Reader Speaks
4	..I've Got a Problem
6	..Backyard Movies
8	..Title Backgrounds
9	..Don't let Exposure Throw You!
10	..Hollywood Editors cut for Color Continuity
12	..Four "Hows" for making Good Home Movies
14	..My Friends Like My Films—Here's Why!
16	..16mm Camera Grows Up, goes Professional!
18	..Movie of the Month
19	..Tell me — How Can I Improve My Film?
20	..Even Beginners Can Shoot Indoor Movies
22	..Titles Are Important and Easy to Make
24	..Speed Often Leads the Beginner Astray
26	..Portraits With 100-Watt Spotlights
26	..Taking the Developer Apart
27	..Infra-Red Photography — How to Use It
27	..Selecting the Right Filter
28	..Kinks and Gadgets
29	..It's New To Me
30	..The Experimental Cine Workshop
47	..Directory of Amateur Cine Clubs
48	..Classified Advertising
56	..I've Got a Problem
58	..The Reader Speaks
60	..Backyard Movies
62	..Title Troubles
65	..When a Beginner I Made Mistakes Too...!
66	..Amateur Movies "click" in Theaters...!
68	..Davlight can look bright, yet be Weak..
70	.. "Whistling Wings" Movie of the Month
71	..Six Things a movie Needs to give it "oomph"
72	..Hollywood's Lighting Secrets are Yours!
74	..There's Filming to do In Winter too
76	..Tell Me — How Can I Improve My Film?
77	..These Novel Effects are fun to Make
78	..A Tip or two on Filming Tricks and Effects
79	..You Can Build This 16mm Continuous Printer!
80	..It's New To Me
82	..The Experimental Cine Workshop
86	..Title Backgrounds
97	..Exposure Tables for Photoflood Lamps
99	..Directory of Amateur Cine Clubs
100	..Classified Advertising
106	..I've Got a Problem
108	..The Reader Speaks
108	..Cine Quiz
110	..Backyard Movies
112	..Title Troubles
115	..Watch Your Framing for Better Composition
116	..Amateur's Local Newsreel Makes Good!
118	..Try These Trick Shots with Your Camera!
120	..Table-Top Movies with Hand-Made Cast of Characters
122	..Confessions of a Cinebug's Wife..
124	.. "Oomph" Lighting for Small Groups
125	..You Filmed It — Now Record It!
126	..Negative-Positive Developing Kit Easily Built
127	..Simple Methods for Centering Titles
128	.. "Checking Off the Budget" — Movie of the Month
129	..Tell Me — How Can I Improve My Film?
130	..The Experimental Cine Workshop
132	..It's New To Me
146	..Exposure Meter Guide
150	..Directory of Amateur Cine Clubs
152	..Classified Advertising
160	..The Reader Speaks
162	..Backyard Movies
164	..Information Please
167	..Practice Perfects Home Reversal Results!
168	.. "Pro's" Effect Tricks no Longer Secret!
170	..Spotlights Light the Way for Better Filming
172	..Title Backgrounds
173	..The Magic Wand — Script, Titles and all!
174	..Here's the 1940 "Dream" Camera!

176	..This New Device Speaks Your Titles
177	..Here's Tip for Filming Trick "Ghost" Shots
178	.. "Finland Fights" Filmed at 40 Below Zero!
179	..Movie of the Month
180	..It it's Color You Want, Try Toning!
181	..Tell Me — How can I Improve My Film?
182	..The Experimental Cine Workshop
184	..It's New To Me
196	..Exposure Meter Guide
200	..Exposure Tables for Photoflood Lamps
201	..Title Backgrounds
202	..Directory of Amateur Cine Clubs
204	..Classified Advertising
210	..Information Please
212	..The Reader Speaks
214	..Backyard Movies
216	..With the Pro-16's
218	..Title Troubles
221	..Showings for Shut-Ins Gains Momentum
222	.. "From A to Z" Movie of the Month
224	.. "The Family Champ" — a Knockout Scripts with Titles
227	..A Guide for Amateurs Filming the Fair
228	..Rare Adventure Awaits Cinefilmmers — Down Mexico Way
230	..You can Build this Robot Camera Control
231	..Pep Up Your Movies with New Title Tricks
232	..More About 1940 "Dream" Camera
233	..Tell Me — How Can I Improve My Film?
234	..Three Ways to Improve Exposure Quality
235	..There's No Mystery About "F" Stops!
236	..The Experimental Cine Workshop
238	..It's New To Me
252	..Exposure Meter Guide
257	..Title Backgrounds
258	..Director of Amateur Cine Clubs
260	..Classified Advertising
268	..Information Please
270	..The Reader Speaks
271	..Backyard Movies
273	..Hyper-Sensitizing Aids Night Filming with Kodachrome
274	..Plan a Cinematic Treasure Hunt on Treasure Island
276	..For a Kiddie Scenario, You'll Like the "Little Housekeeper"
278	..Adding Sound? Try These Simple Sound Effects
280	..Movie of the Month
281	..For Novel and Variety Titles, Build This Vertical Multi-Plane Titler
282	.. "Bombs Over Europe" Filmed During "Blitzkrieg!"
283	..Backgrounds in Motion, Pep Up Titles
284	..Title Centering Guides
285	..A Telephoto Lens Any Amateur Can Build
286	..Amateur Builds 200 ft. 8mm Film Magazine
287	..Tell Me — How Can I Improve My Film?
288	..The Experimental Cine Workshop
292	..It's New To Me
294	..With the Pro-16's

297	..Exposure Meter Guide
309	..Title Backgrounds
310	..Directory of Amateur Cine Clubs
312	..Classified Advertising
318	..The Reader Speaks
320	..Information Please
322	..With the Pro-16's
325	..Coating Lens Increases Its Speed
326	..Movie of the Month
328	..Here's Next Sunday's Shooting Script
330	..Build This Turret for Your Keystone "8"
332	..Make Way for Home Movies In Your New Home Plans
334	..Home Movie Shows Bring Cheer to Old Folks
335	..Wind Back, Fade, Dissolve, and Wipe Off with This Glorified 16!
336	..So You Want to Know How To Do It
337	..Simple Test for Homemade Tele-Lens
338	..Title Centering Guides
339	..Tell Me — How Can I Improve My Film
340	..The Experimental Cine Workshop
342	..It's New To Me
344	..Chart of Titling Exposures
346	..Filter Factors for Reversal Cine Films
354	..Exposure Meter Guide
355	..Title Backgrounds
356	..Classified Advertising
364	..The Reader Speaks
366	..With the Pro-16's
369	..Perspective and Balance Chief Factors in Good Composition
370	..Club's Cinematography Course Improves Members' Technique
372	..Chicago Cinefan's Home Theatre Tops Them All
374	..Running Gags and Tie-in Shots Make Vacation Films Complete
376	..Vary Camera Speed for Tricks, Smoother Action
377	..Title Composition Simple as A-B-C
378	..Title Centering Guides for Filmos
379	..Homemade Gadgets for Filming Under Water
380	..Let's Get Acquainted with Our Camera Lens
381	..Plans and Data for Building the "Glorified 16"
382	..Ski Picture Voted Movie of the Month
383	..Tell Me — How Can I Improve My Film?
384	..The Experimental Cine Workshop
386	.. "It's New to Me"
391	..Exposure Meter Guide
399	..Title Backgrounds
400	..Classified Advertising
406	..Information Please
408	..Title Troubles
410	..Backyard Movies
413	..What Type Film Should I Use?
414	..Announcing HOME MOVIES' 1940 Contest Winners
418	..Light and Lenses in Cine Photography
420	..Home-Made Wind-Back for Less Than Five Dollars
422	..Film This Simple Animated Cartoon!
424	..Title Centering Guides
425	..Pro Results with Amateur Equipment in Home Processing
426	..Tell Me — How Can I Improve My Film?
427	..Here are Details of Gear Box for the "Glorified 16"
428	..The Experimental Cine Workshop
430	..1600 Schools Served by Ohio V.I.E.
431	..Planning the School Film
432	..Educational Film Treatments
436	.. "It's New to Me"
445	..Chart of Titling Exposures
453	..Directory of Amateur Cine Clubs
455	..Title Backgrounds
456	..Classified Advertising
462	..Information Please
464	..Backyard Movies
466	..The Reader Speaks
468	..Title Troubles
471	..The Winner Tells All
472	..We Shot New York Our Way
473	..Movie of the Month
474	..A Demountable Turrent Any Amateur Can Build

Page Number Guide

1940 ISSUES OF

HOME MOVIES

January	2
February	54
March	106
April	158
May	210
June	266
July	318
August	362
September	406
October	462
November	520
December	570

- 477..Accurate Alignment Essential in Animating Cartoons
 478..It's Easy to Tint and Tone Your Films
 479..What an Auxiliary Lens will do
 480..Are You Prepared for Indoor Filming?
 481..Detail? It depends upon the Emulsion
 482..Frame Counters and Gears for "Glorified 16"
 483..Teach Your Dog to Act in Your Home Movies
 484..Title Centering Guides
 485..Tell Me—How can I Improve My Film?
 486..The Experimental Cine Workshop
 488..Schools can Successfully Produce Teaching Films
 489..Cooperative Visual System Succeeds
 490..Educational Film Treatments
 492..It's New to Me
 506..Exposure Meter Guide
 509..Directory of Amateur Cine Clubs
 511..Title Backgrounds
 512..Classified Advertising
 520..The Reader Speaks
 522..Information Please
 524..Backyard Movies
 526..With the Pro-16's
 529..Avalanche of Memberships Swells Ranks of Reel Fellows
 530..Here's Title Trick That Won 1940 Award
 531..The Lowdown on Continuity
 532..Third Sequence Concludes Animated Cartoon Series
 534..Completing Assembly of the "Glorified Sixteen"
 536..Is Yours a Where, What, or a Who Picture?
 537..At Least . . . Successful Sound for 8mm and 16mm Movies
 538..Films, Like Rare Volumes, Sought By Collectors
 539..5 Factors of Successful Cinematography
 540..17 Cine Clubs Stage Big "Get-Acquainted" Funfest
 541..Movie of the Month
 542..Title Centering Guides
 543..Tell Me—How Can I Improve My Film?
 544..The Experimental Cine Workshop
 546..It's New to Me
 530..Exposure Meter Guide
 563..Animated Title Backgrounds
 564..Classified Advertising
 572..Reader Speaks
 574..Information Please
 576..With Advanced Cinefilmmers
 578..Title Troubles
 582..Mother, Dad and The Children Star In This Christmas Scenario.
 584..How I Filmed My Prize Winning Picture.
 586..Build Your Own Equipment As This Cine-bug Did!
 588..A Turret with Built-in Tele-lenses for Keystone "8"
 590..Three Ideas That Make Titling Easier
 591..Tips on Make-up for Home Movies
 592..Zone Lighting for Cine Photography
 593..Lloyd Bacon 1st Honorary Member of the Reel Fellows
 594..Title Centering Guides
 595..Final Conversion Steps for "Glorified 16"
 596..Movie of The Month
 597..Some Filming Ideas That "Clicked"
 598..What Are You Giving Yourself This Christmas?
 602..Experimental Cine Workshop
 604.. "It's New To Me!"
 612..Indoor Lighting Chart
 626..Directory of Amateur Cine Clubs
 628..Title Backgrounds
 629..Classified Advertising
 630..Annual Index

Index by Topics

A

- Absorbing projector noise, idea for: 429.
 Adult continuities: 328.
 Air-brush backgrounds: 31.
 Amateur equipment for home processing: 425.
 Amateur films in Theaters: 66.
 Amateur newsreel: 116.
 Animal continuity (dog): 162.
 Animated cartoons: problem: 320.
 Animated title backgrounds: 563.
 Animation: 120; 422; 532.
 Auxiliary lenses: 477.
 Auxiliary lens holder: 341.

B

- Baby scenario: 524.

- Backgrounds, air-brush: 31.
 Backgrounds for titles: 8; 86; 153.
 Backgrounds for titles, moving: 384.
 Backgrounds in motion for titles: 283.
 Backyard movies: 6; 110; 162; 214; 271; 464; 524.
 Bag for film changing: 183.
 Balance in composition: 369.
 Bands for reels: 236.
 Binoculars as tele-lens: problem: 106.
 Binocular-telephoto, making a: 130.
 Bluing water for scenes: 182.
 Bonfire filming: problem: 56.
 Brake for rewind: 341.
 Brown stain on film in home processing: problem: 106.
 Building a Bell & Howell 8 mm. demountable turret: 474.
 Building a disc recorder: 125.
 Building a telephoto lens: 285.
 Building 200 ft. 8mm magazines: 286.

C

- Cabinet, making a film: 30.
 Cable release bracket: 289.
 Camera case, making a: 182.
 Camera control, making a robot: 230.
 Camera handle, making a: 30.
 Camera lens, knowing the: 380.
 Camera speeds for tricks: 376.
 Cartoons: 422.
 Cement for film: problem: 268.
 Cement saving, splicing: 428.
 Centering close-ups, guide for: 182.
 Centering gadget for camera, making a: 236.
 Centering guide for titles: 284.
 Centering titles: 22; 30; 284.
 Centering title methods: 127.
 Chain retractor: 341.
 Changing bag for film: 183.
 Changing projection lens focal length: 603.
 Chemical exposure: item, 522.
 Children continuities: 6; 10; 162; 173; 214; Christmas Scenario: 582.
 271; 276.
 Cine Quiz: 108; 160.
 Circle of confusion: 572.
 Classified Advertising: 48; 100; 152; 204; 260; 312; 256; 400; 456; 512; 564.
 Close focus: item, 522.
 Close-up centering guide: 182.
 Close-ups, fuzzy: problem, 56.
 Close-ups, ultra: 355.
 Clubs cinematography course: 370.
 Coating lenses: 325.
 Collectors, film: 538.
 Color continuity: 10.
 Color titles: 288.
 Component parts of a developer: 24.
 Composition: 369.
 Composition in titles: 377.
 Composition in your movies: 115.
 Confessions of a cine bug's wife: 122.
 Contest winners, Home Movies 1940: 414.
 Continuities: 6; 60; 162; 173; 214; 224; 271; 328; 410; 464.
 Continuity: 531.
 Continuity for Home Economics: 449.
 Continuity in color, cutting: 10.
 Continuity complete with titles: 173.
 Continuity for one person: 56.
 Continuity with titles for animated cartoons: 422.
 Continuous 16mm printer: 79.
 Cooperative visual system: 489.
 Copying film: 237.
 Crank gear and housing for "Glorified 16", building: 381.
 Cup for holding cable release, making a: 486.
 Custom requirements on film: Item, 164.

D

- Dancer continuity: 10.
 Darkroom, emergency: 130.
 Daylight, filming in tricky: 68.
 Dog continuity: 110.
 Density range and gamma of negatives: 28.
 Depth of focus for lenses: 78.
 Developer, taking a part: 26.
 Developing kit, building a: 126.
 Developing reversal: 167.
 Dial for exposure meter, augmenting: 487.
 Diopter value of light and lenses: 418.
 Diaphragm opening, explanation: 539.
 Directory of amateur clubs (a list of all clubs in United States and Canada): 47; 99; 150; 202; 258; 310; 453; 509; 629.
 Disc recordings with movies: 125.
 Dissembling Filmo to make "Glorified 16": 381.

- Distance of focus, explanation of: 539.
 "Dream Camera" for 1940: 174; 232.
 Drum developing, motor for: 544.
 Drum reversal development: 167.
 Dual tripod head: 428.

E

- Editing Aid: 183.
 Editing pictures: 536.
 Editing Safeguard: 30.
 Editor from projector: 429.
 Educational film releases: 437; 491.
 Educational film treatments: 430; 490.
 Effects and tricks: 78; 168; 177.
 Eight mm. Bell & Howell projector accommodation for large reel: 544.
 Eight mm. Eastman 400 ft. projection reel, making: 545.
 Eight mm. sound: 537.
 Eight mm. 200 ft. magazines, building: 286.
 Electrically driven 16 mm. camera, making: 174.
 Emulsions, film: 478.
 Emulsion speeds explained: 539.
 Enlargements of cine film: 139.
 Extension tubes on lenses: problem, 149.
 Experimental Cine Workshop: 30; 82; 130; 182; 236; 288; 341; 384; 428; 486; 544; 602.
 Exposure: 9; 68.
 Exposure chart, following an: problem, 56.
 Exposure for 8 frames: problem, 4.
 Exposure for titles: 22; 445.
 Exposure of infra-red: 27.
 Exposure meter, using an: 234.
 Exposure quality, improving: 234.

F

- "F" stops, explaining the: 235.
 Fade, building means for a 16mm camera: 335.
 Fades thru manipulation of iris: 486.
 Fading device, making a: 82.
 Fading glass, making a: 289.
 Family continuities: 6; 60; 224; 410; 464.
 Family films, ideas for: 14.
 Film cabinet, making a: 30.
 Film changing bag: 183.
 Film cleaner: 385; 487.
 Film editor: 131.
 Film emulsions: 479.
 Film, explaining types: 413.
 Film fastener used in processing: 183.
 Film grain; problem: 56.
 Film grips, making: 182.
 Film moistener: 236.
 Film retainer: 289.
 Film reviews: 19; 76; 129; 181; 282; 287; 339; 383; 426; 485.
 Film speed checking: 288.
 Film slitter, constructing a: 486.
 Film slitter: 603.
 Film speeds for effects: 78.
 Film tinting: 385.
 Film toning: 180.
 Film too fast: problem; 268.
 Filming in Death Valley: 68.
 Filming in Winter: 74.
 Filming the "Fair": 227; 274.
 Filming under water: 377.
 Filter factors for cine films: 346.
 Filter safety catch: 545.
 Filters: 27; 68.
 Focus indicator: 340.
 Focus distance, explanation of: 539.
 Focus, soft: problem, 4.
 Focusing aid: 237.
 Focusing aid for projector: 603.
 Focusing titles: 22.
 Footage counter, building a film: 288.
 Footage gauge, building: 340.
 Formula for reversal developing: 167.
 Formula for negative film: 134.
 Formula for negative reduction: 28.
 Formula, positive film: 134.
 Formulas for home processing: 425.
 Frame counter for "Glorified 16": 480.
 Frame lines; problems; 106.
 Framing "kink" for projector: 237.
 Fuzzy close-ups: problem; 56.

G

- Gadgets: 586.
 Gadgets for filming under water: 377.
 Gamma and negative density range: 28.
 Gauge, building a footage: 340.
 Gear box details for "Glorified 16": 427.
 Geared pan head: 183.
 Gear for 16mm "Glorified 16mm": 480.
 "Ghost" shots, making: 177.
 Glare shield for projector: 602.

Glorified 16mm camera, building: 335, 379; 427; 480; 534; 595.
 Good home movies, 4 "Hows" for: 12.
 Good movies, 6 things for: 71.
 Grain, film: problem, 89.
 Grips for film, making: 182.

H

Heads cut off: problem, 4.
 Holding 8 mm. ends on processing drum: 82.
 Hollywood's lighting secrets: 72.
 Home-made windback for "K" Cine Kodak less than \$5.00: 420.
 Home processing equipment: 425.
 Home theatre in cinefan's Chicago home: 372.
 Humidor cans, tabs for: 603.
 Hyper-sensitizing: 273; 406.

I

Indoor light standard: 31.
 Indoor lighting: 20; 72; 124; 478; 612.
 Indoor lighting with spotlights: 180.
 Information Please: 164; 210; 268; 320; 406; 462; 522; 574.
 Infra-Red photography, explanation of: 27.
 Ink for titles on glass: 544.
 It's New to Me (new products): 29; 80; 132; 184; 238; 292; 342; 386; 436; 492; 546; 604.
 I've Got a Problem: 4, 56; 106.

K

Keystone 8mm turret, building a: 330.
 Kodachrome, more detail with: problem, 210.
 Kodachrome, Hyper-sensitizing: 273.

L

Lap dissolves, making a hand crank for: 333.
 Leaders for bulk film, splicing: 253.
 Lens caps: 340.
 Lens coating increases speed: 325.
 Lens, fundamentals of the camera: 380.
 Lens holder, making an extra: 82.
 Lens speeds: 24.
 Lens case, making a: 486.
 Lenses: 418.
 Lenses, auxiliary: 477.
 Lenses in relation to light: 418.
 Lenses, supplementary: problem, 268.
 Light explaining rays, beams, watts, etc.: 418.
 Light in relation to lenses: 418.
 Light values, explanation: 539.
 Light stand, making an indoor: 31.
 Lighting for portraits: 24.
 Lighting indoors: 478.
 Lighting interiors in teaching film productions: 600.
 Lighting infants: problem: 106.
 Lighting, interior: 20; 72; 124; 180.

M

Makeup for Home Movies: 591.
 Mask and wipe-off device: 31.
 Masking: 77.
 Matte box for 8mm: 429.
 Matte box for titler: 384.
 Mechanism removed from camera: problem, 320.
 Mexico filming: 228.
 Miniature photography: 120.
 Mistakes of the beginner: 65.
 Movie of the Month: 18; 70; 128; 179; 222; 28; 326; 382; 472; 541; 596.
 Moving backgrounds for titles: 283.
 Multi-plane titler: 281.

N

Negative density range and gamma: 28.
 Negative film developer: 134.
 Negative-positive developing kit: 126.
 Negative reduction: 28.
 News films, "Finland fights: 176 "Bombs over Europe": 282.
 Newsreel, amateur: 116.
 New York, filming: 472.
 Night filming, hyper-sensitizing Kodachrome for: 295.
 Non-skid tripod base, building: 340.

O

Odd shot reel, continuity for: 254.
 Overhead shooting: 288.

P

Pan head, geared: 183.
 Parallax corrector, making a: 236.
 Perspective in composition: 369.
 Photoflood exposure table: 97; 200.
 Photoflood stand, making a: 130.
 Photo lamp protection: 428.
 Polaroid: item, 522.
 Pola Screen Guide: 487.

Portrait lighting: 26.
 Positive film developer: 134.
 Printer, building a 16mm continuous: 79.
 reel: 384.
 Processing equipment for home: 425.
 Processing, temperature control in home: 82.
 Processing time limit: item, 164.
 Professional 16mm movies: 16.
 Projection aid: 544.
 Projection aid, Pilot light and extension card
 Projection screen, materials for: 603.
 Projector turntable: 544.
 Projector as action editor: 429.
 Projector as spotlight: 92.
 Projector automatic pilot light: 429.
 Projector belts: 289.
 Projector case, building a: 340.
 Projector case, making a: 82.
 Projector framing kind: 237.
 Projector safety: 289.
 Projector lamp saving switch: 428.
 Projector shield (no glare): 82.

R

Range finder, making a simple: 82.
 Recording unit: 125.
 Reducing negatives: 28.
 Reel book covers: 183.
 Reel bands: 236.
 Reel Fellows: 529; 593.
 Reflection elimination: 130.
 Reflector replacement: 131.
 Reflectors for a few cents: 385.
 Reflectopod, building a: 340.
 Remote control: 130.
 Reversal development: 167.
 Reverse action 8mm: 486; item, 522.
 Reviewing films: 19; 129; 181; 238; 287; 339; 383; 426; 485; 543.
 Rewind brake: 341.
 Rewind Reel retainer: 237.
 Rewinding film, safeguard when: 30.
 Rewinds from gas pipe: 428.
 Robot camera control: 230.

S

Scenario: 271.
 School film, planning: 429.
 Schools produce successful teaching films: 488.
 Scratching by projector, prevention: 428.
 Screen tripod mount: 340.
 Script with titles: 173; 224; 276; 326.
 Shrunken film: problem: 268.
 Shut-in showings: 320; 334.
 Side-Show continuity: 96.
 Single frame gear and shaft, installation of: 232.
 Sixteen mm. continuous printer, building: 79.
 Sixteen mm. professional movies: 16.
 Sixteen mm. pro's, with the: 216; 322; 366; 526.
 Sixteen mm. sound: 537.
 Slitting aid, film: 30.
 Small group interior lighting: 127.
 Soft focus: problem, 4.
 Some new ideas for Christmas filming: 581.
 Sound: 406.
 Sound effects, making: 278.
 Sound for 16mm: 537.
 Speaking titles: 176.
 Speed checker for projector: 545.
 Speeding lens with coating: 325.
 Speeds of cameras for tricks: 376.
 Speedy developer: item, 58.
 Splice life: item, 164.
 Splicing leaders (bulk film): 253.
 Spot light of projector: 82.

Spotlights, using: 170.
 Stage curtain control: 487.
 Stand for Photoflood: 130.
 Stop motion for Keystone 8's: 340.
 Storage of film: item, 522.
 Sunset shots: problem, 320.
 Superimposed titles, making: 168; 254.
 Supplementary lenses: problem, 268.
 "Syncing" sound: 406.

T

Table top photography: 120.
 Teaching Films: 601.
 Teaching films produced by schools: 488.
 Teaching your dog to act: 481.
 Tele-lens, testing the home made: 337.
 Telephoto from binoculars: 130.
 Telephoto lens, building: 285.
 Telephoto lens, making an inexpensive: 429; 545.
 Temperature control in home processing: 82.
 Tension control, film: 131.
 Theaters and amateur movies: 66.
 The Reader Speaks: 2; 58; 108; 160; 212; 270; 318; 364; 466; 520.
 Tinting films: 385; 476.
 Title background effect: 602.
 Title backgrounds: 8; 86; 153; 201; 257; 309; 355; 399; 458; 511; 602; 628.
 Title cards: 602.
 Title centering: 31.
 Title centering guides: Eastman Cine Kodaks, 284; Bell & Howell Filmos, 378; 424; 16mm Bolex, 16mm Victor, 8mm Keystone 484; 8mm Bolex, Cine Kodak 90, 8 mm Revere, 542; Univex, and Keystone 16mm, 594.
 Title centering methods: 31.
 Title composition: 377.
 Title exposures: 22; 445.
 Title troubles: 62; 112; 218; 408; 468; 578.
 Title tricks: 231; 530.
 Titler board: 602.
 Titler, building a multi-plane: 281.
 Titler camera mount: 545.
 Titler lighting unit: 289.
 Titler made of gas pipe: 602.
 Titler, making an accurate: 236.
 Titler, tripod mount: 237.
 Titles, color: 288.
 Titles, making superimposed: 168; 254.
 Titles making, typewriter, black or pin letter: 22.
 Titles with moving backgrounds: 283.
 Titles, Venetian shade for: 603.
 Toning film: 180; 476.
 Toning, sepia: 340.
 Trick effects: 77; 118; 177.
 Trick shot gadget, making a: 237.
 Trick tiles: 530.
 Tricks and effects: 78; 168.
 Tricks with titles: 231.
 Tripod head, making a: 30.
 Tripod level: 544.
 Tripod, when to use a: item, 28.
 Turret, building an 8mm Bell & Howell de-mountable: 474.
 Turret for 8mm Keystone: 588.
 Turret for Keystone 8mm, building a: 330.
 Two hundred foot 8mm film magazine, building: 286.

U

Ultra close-ups: 544.
 Upside-down filming: 182.

V

Vacation continuity: 271; 464.
 Vacation films need running gags and tie-in shots: 374.
 V.I.E. Services 1600 schools: 430.
 Visual Educational Department: 428; 488.

W

Wedding scenario: 561.
 Whirring effects gadget for camera: 384.
 Windback for less than \$4 to "K" cine Kodak, home made: 420.
 Windback, making a: 174.
 Windback, building a: 335.
 Winner of HOME MOVIES contest tells all: 471.
 Wipe off and mask device: 31.
 Wipe off, building: 335.
 Wipe-off fan, mounting the "Glorified 16": 532.
 Wipe off, making a: 168.
 Wipe off titles, method for: 385.
 With advanced cinefilmmers: 576.

Z

Zone lighting for cine photography: 592.

BACK ISSUES of HOME MOVIES

The Annual Index concluded on this page lists every article and important news item which appeared in the twelve issues of HOME MOVIES during 1940.

If you missed an issue containing information on a subject of interest, we may be able to supply a back number.

Limited quantity of back issues still available at 25 cents per copy while they last.

VER HALEN PUBLICATIONS

6060 Sunset Blvd. Hollywood, Calif.

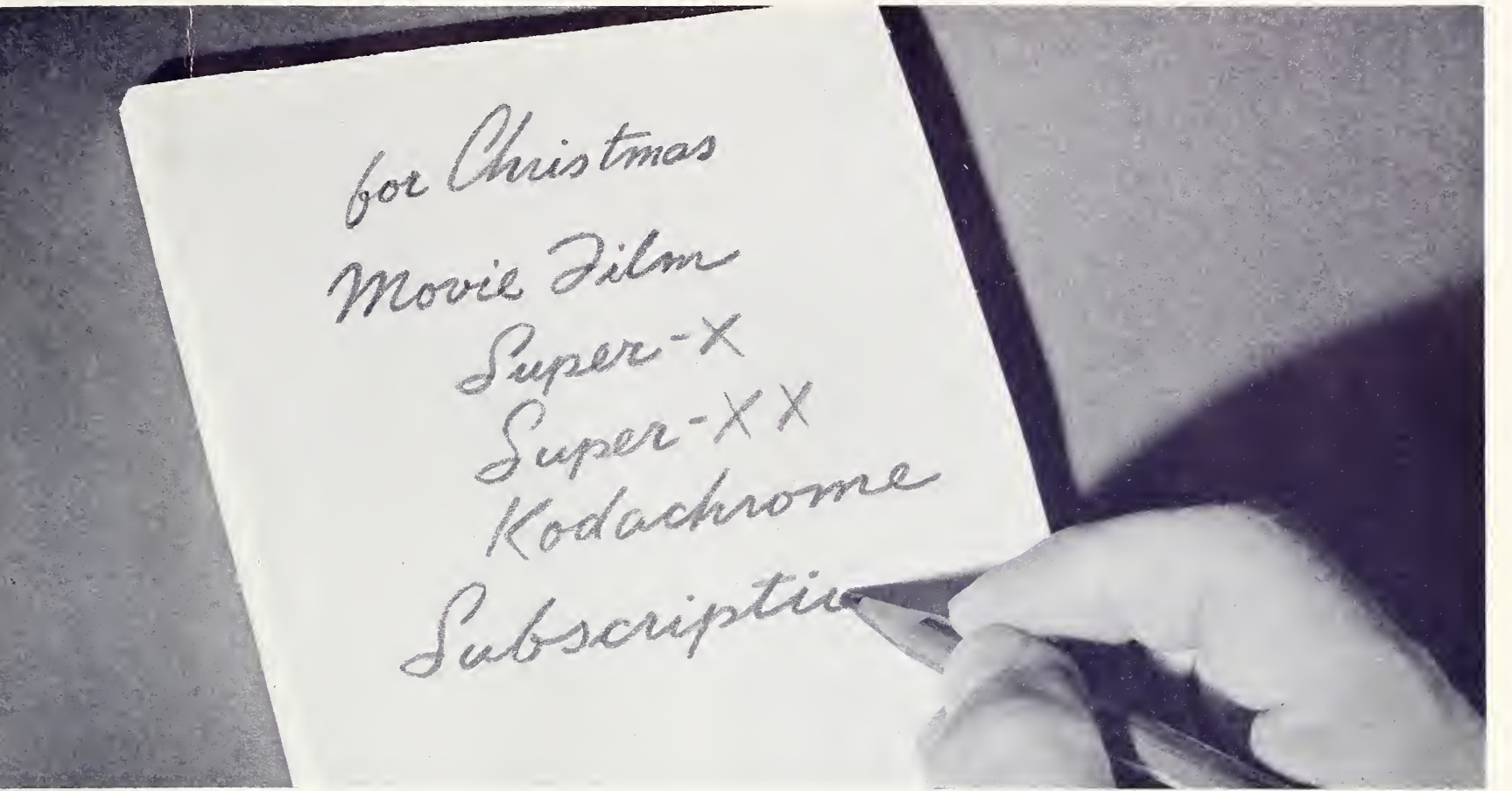

for Christmas
Movie Film
Super-X
Super-XX
Kodachrome
Subscriptions

Tops a Movie Maker's List...

CINÉ-KODAK FILM

SOMETIMES friends and family overlook the simple, obvious thing. *The one gift a movie maker can always use is movie film—Ciné-Kodak Film.*

And Ciné-Kodak Film is a gift the pleasures of which are shared by the movie maker's whole circle of friends and family. For with it, he makes clear, sparkling, memorable movies not only of Christmas but of other days and delights.

Ciné-Kodak Film is top quality film, available in a variety of types for both 8 mm. and 16 mm. cameras. There's speed film for indoor shots, superb extra-fine-grain film for general movie making, and magnificent full-color Kodachrome Film. "Too much film" is a phrase that simply doesn't make sense to a movie maker—provided, of course, it's Ciné-Kodak Film.

Here are the Ciné-Kodak Films. The price of each includes the cost of expert processing and return, ready for projection.

16 MM. CINÉ-KODAK FILMS

SUPER-X, a panchromatic film perfectly adapted for most outdoor work. Fine in grain, brilliant in quality. 100-ft. roll, \$6; 50-ft. roll, \$3.25; 50-ft. magazine, \$3.50.

SUPER-XX, the brilliant, high-speed film for indoor movies or outdoors under adverse light conditions. 100-ft. roll, \$6.75; 50-ft. roll, \$3.75; 50-ft. magazine, \$4.

KODACHROME, the beautiful full-color film. Regular for daylight, Type A for indoor shots by Photoflood light. 100-ft. roll, \$8; 50-ft. roll, \$4.30; 50-ft. magazine, \$4.65.

SAFETY "PAN," a general utility panchromatic film of good quality, available only in 100-ft. rolls at \$4.50.

8 MM. CINÉ-KODAK FILMS

SUPER-X is the 8 mm. speed film. 25-ft. roll (equal to 100-ft. 16 mm. roll in projection time), \$2.25; 25-ft. magazine, \$2.50.

8 MM. "PAN," the fine-grain film that made 8 mm. movies possible and popular. 25-ft. roll, \$2.

8 MM. KODACHROME. The full-color film. In two types, Regular and Type A. 25-ft. roll, \$3.40; 25-ft. magazine, \$3.75.

EASTMAN KODAK COMPANY, ROCHESTER, N. Y.



Know What?

**I'M GOING TO GIVE MYSELF
A *Filmo* MOVIE CAMERA!**

PERHAPS you feel the same way about it. You have wanted a new Filmo Motion Picture Camera for a long time. You know that any Filmo Camera you choose is a fine-quality precision instrument standing head and shoulders above anything else of its type. You know that sooner or later your skill will demand the ability and versatility that only a Filmo can give you. So why not give yourself that Filmo you've been wanting? . . . Yes—*now!*

—and Three Great "Eights"

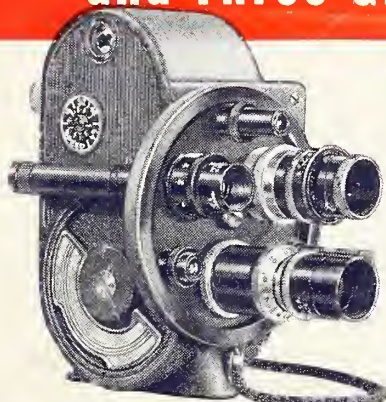

With one lens—Taylor-Hobson 12½ mm. F 2.5 . . . \$140
With provision for film wind-back for making lap dissolves and double exposures . . . \$172
Filmo "Companion" 8, with film speeds of 8, 16, 24, 32 and B&H 12½ mm. F 3.5 universal focus lens . . . \$49.50
Filmo "Sportster" 8, with speeds of 16, 32, 48, and 64 and Taylor-Hobson 12½ mm. F 2.5 universal focus lens . . . \$75

**Filmo "Companion" 8
Filmo "Sportster" 8
Filmo Turret 8**

If it is an "eight" you want—step into your camera dealer's and give the Filmo Turret 8 your most critical inspection. Compare the workmanship . . . the finish . . . the features it provides . . . the work it is capable of doing. You'll see why it is miles ahead!

The turret mounts three lenses and their matching viewfinders. Both are placed in position by rotating the turret. Five fine, color-corrected lenses are available for it. Its positive viewfinder eliminates errors in composition. Its magnifying, critical focuser shows you the entire frame through the lens. Four speeds, including slow motion . . . single frame exposure . . . built-in exposure calculator . . . automatically reset film footage dial . . . and other desirable features.

Finest magazine-loading cameras that Bell & Howell ever built

**FILMO AUTO LOAD
AUTO LOAD SPEEDSTER
AUTO MASTER WITH TURRET HEAD**

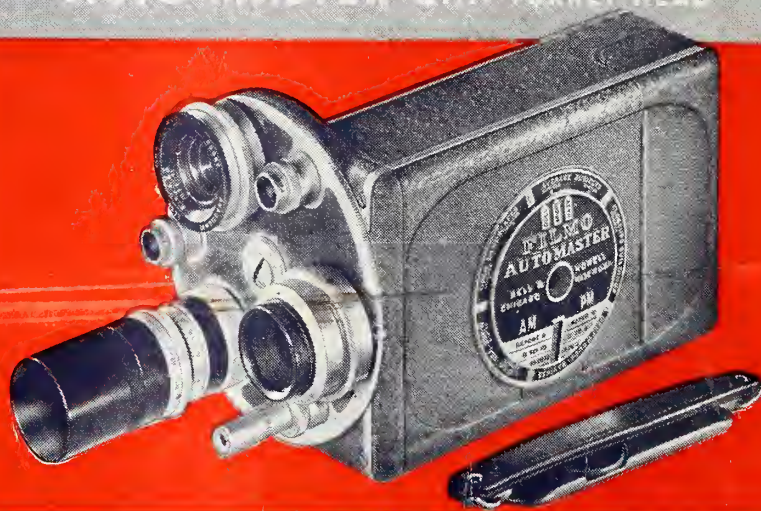

FILMO Auto Master is the only 16 mm. magazine-loading motion picture camera with a turret head. Precision-built by the makers of Hollywood's professional motion picture equipment, it provides features that will match your skill no matter how far you go.

Loading is a three-second operation. The pre-threaded film magazine drops into place. You can change from black-and-white to color film in mid-reel without fogging a single frame. Any three of a wide range of lenses and their matching viewfinders may be mounted on the turret head. When the desired lens is rotated into photographing position by a quick turn of the turret—its viewfinder is also

automatically positioned. You get those now-or-never shots. The lens you need is always at your finger tips. The positive-type viewfinder, enclosed and protected, provides brilliant image—and *what you see, you get*. A built-in exposure chart gives readings at a single setting for both color and black-and-white film.

Slow-motion scenes and animated cartoons can be filmed without extra attachments . . . the fast, color-corrected lens of the Auto Load is interchangeable with a full range of special-purpose lenses. Steady-strap handle; light weight; compact; pocket-fitting smooth contours; durable and beautifully finished. Guaranteed for a lifetime!

FILMO AUTO MASTER, with film speeds of 16, 32, 48, and 64, Taylor-Hobson 1" F 2.7 universal focus lens . . . \$195

FILMO AUTO LOAD mounts one fast, color-corrected Taylor-Hobson 1" F 2.7 universal focusing lens, provides film speeds of 8, 16, 24, 32 . . . \$115

FILMO AUTO LOAD "SPEEDSTER", identical twin of the Auto Load except that it provides film speeds of 16, 32, 48, and 64; with Taylor-Hobson 1" F 1.5 focusing lens . . . \$160.50

FILMO ACCESSORIES make the ideal gifts for the movie makers in your family and among your friends. Your dealer can show you the complete line—or mail the coupon for any desired information.

TWO MASTER PROJECTORS—BOTH SUPER-VALUES!
Both Have All-gear Drive . . . Both Are Built to Protect Your Film



FILMO-MASTER 16 MM. PROJECTOR

Built with true B&H precision. Embodies features heretofore found only on higher-priced Filmos: all-gear drive, no belts inside or out; speedy power-rewind; 750-watt lamp; new Magnilite condenser for 32% brighter pictures; fast 2-inch F 1.6 lens in two-speed focusing mount, with lens lock; instant lens interchangeability; Safe-lock Sprocket guards to prevent incorrect threading; two-way tilt; reverse; still picture clutch; "floating film" protection; metered lubrication. Capacity, 400-foot 16 mm. reels. Greatest Bell & Howell projector value ever offered. Price, complete with case, only \$139.

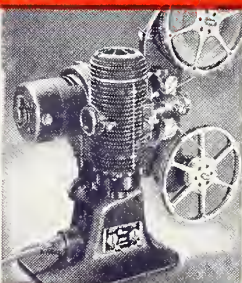

FILMO-MASTER 8 MM. PROJECTOR

Screen pictures are rock steady because of camera-matched film registering mechanism. Brilliant illumination by the 400- or 500-watt lamp and efficient direct optical system. Flicker is banished by 11-to-1 shutter movement. All-gear drive; power film rewind; clutch for "still" picture projection; fast F 1.6 lens, interchangeable with special lenses for longer or shorter throws; lens lock; tripod socket in base makes any tripod a projector stand; "floating film" protection; metered lubrication; line and lamp switches centralized on one panel; two-way tilt. With case, \$118.

BELL & HOWELL COMPANY
1825 Larchmont Ave.
Chicago, Ill.

Send me detailed information on () Filmo Auto Master; () Filmo Auto Load; () Filmo Auto Load "Speedster"; () Filmo 8 mm. Cameras; () Filmo-Master 8 mm. Projector; () Filmo-Master 16 mm. Projector; () Filmo Accessories.

Name FEB - 1 1946
Address _____
City _____ State _____ HM 12-49

**PRECISION-
MADE BY**

Bell & Howell







LIBRARY OF CONGRESS



0 021 997 935 6