

402978

A.32

THE
MATHEMATICAL SCIENCES:

INCLUDING

SIMPLE ARITHMETIC, ALGEBRA, AND THE ELEMENTS OF EUCLID.

BY J. R. YOUNG,
LATE PROFESSOR OF MATHEMATICS.

PLANES. SPHERICAL TRIGONOMETRY. SERIES, LOGARITHMS,
AND MENSURATION

BY THE REV. J. F. TWISDEN, M.A.,
PROFESSOR OF MATHEMATICS SANDHURST.

AND

PRACTICAL GEOMETRY.

BY ALEXANDER JARDINE, ESQ.,
CIVIL ENGINEER.

LONDON:

W^m. S. ORR AND Co., AMEN CORNER, PATERNOSTER ROW.

MDCCCLIV.

1854



ORR'S
CIRCLE OF THE SCIENCES:

A Series of Treatises

ON

THE PRINCIPLES OF SCIENCE.

WITH THEIR APPLICATION TO PRACTICAL PURSUITS.

—◆—
THE MATHEMATICAL SCIENCES.
—◆—

LONDON:

W^m. S. ORR AND Co., AMEN CORNER, PATERNOSTER ROW.

MDCCLIV.

1854.

PREFACE.

THE present volume of the "CIRCLE OF THE SCIENCES" contains a series of Treatises upon *Elementary Mathematics*. In this we comprise Arithmetic—including Algebra, Geometry, and Trigonometry; and of each of these we propose to say a few words.

Arithmetic is the science of *numbers*, and therefore treats of the various combinations of which numbers are susceptible, and of the relations existing between symbols that express numbers. The symbols employed to denote numbers may be either *particular*, as 5. 6. 7 . . . , each of which expresses a certain determinate number; or *general*, as *a. b. c. . . .*, each of which may express numbers, but not necessarily the same number in two different operations. In the former case the science is termed Arithmetic, in the restricted sense which is generally given to that word; in the latter case it is termed *Algebra*, or, more accurately, *Arithmetical Algebra*. Considered speculatively, the latter is antecedent to the former, the rules of *Arithmetic* being founded, as special cases, on the demonstrations of *Algebra*; and in our present volume the treatises on Arithmetic and Algebra may, in some degree, be considered as of corresponding scope; the one treating of certain classes of questions concerning numbers, by means of rules and particular symbols; the latter treating of similar classes of questions, by means of demonstrations and general symbols.

The science of Algebra admits of many developments besides those contained in the treatises above referred to. Some account of these generalizations will be found in the treatise on Series and Logarithms, of which a word must be said. This treatise consists of two parts,—an algebraical part, discussing the properties of certain Series, and an arithmetical part, containing an exposition of the mode of calculating Logarithms, and rules for using them when calculated. In this treatise the speculative order is observed, the rules of the arithmetic of Logarithms being deduced from algebraical demonstrations. The same order could not be observed in the earlier part of the volume, since a man's mind cannot entertain speculative views of the science of numbers till it has obtained some familiarity with their more elementary combinations; so that it is necessary to teach Arithmetic empirically. It will be observed, that in discussing the question of Series it has been no further dealt with than was necessary for treating the subject of Logarithms with sufficient fulness.

This restriction was necessary, to prevent the discussion of the nature

of Series from running to an interminable length ; for, strictly speaking, the subject of Series is endless. M. De Morgan very justly observes, that "The theory of Series is both difficult and incomplete. So far from being an isolated branch of Algebra, it is an infinite subject, in which every question answered will point out questions to ask."

In regard, then, to the arithmetical part of this volume, we may say that it contains Fractional, Decimal, and Logarithmic Arithmetic, with a full description of the principles on which they rest.

The treatise of Geometry is founded on Euclid's Elements ; the first Four and the Sixth Books, together with the Tract on Planes, being very nearly the same as in Euclid's treatise. The Fifth Book of Euclid's Elements has been replaced by a tract on Proportion, the object of which Mr. Young has fully explained. It is to be observed that Arithmetic, and the science of Geometry as treated by Euclid, differ essentially ; since the conception of equality employed in Geometry is quite different from the conception of equality employed in Arithmetic. In the former case two magnitudes are considered equal which can be so adjusted as to coincide, or fill the same space ; in the latter, two magnitudes are considered as equal which contain the same number of units. In consequence, these two sciences admit of entirely independent development. To what extent this independent development might be carried is doubtful ; but certainly to a far greater extent than is usual in our treatises on Geometry ; as it is found that the more difficult questions in Geometry are solved with greater ease by employing algebraical symbols to represent geometrical magnitudes, than by the process of reasoning conducted after Euclid's method. In the present volume the tract on Proportion, like most of the propositions in the treatise on Mensuration, is an instance of this application of Algebra to the discussion of geometrical questions.

The difference between Geometry and Algebra may be very conveniently expressed by saying, that Geometry is a science of *construction* ; Algebra (or Arithmetic) of *calculation*. Thus, when certain sides and angles of a triangle are given, we may by rule and compass construct that triangle ; whereas, if we treated the same question algebraically, we should, after representing the sides and angles numerically, calculate the remaining sides and angles. And it is to be observed, that a determination by the latter means is very far more accurate than by the former. In obtaining the means for such process of calculation there are considerable difficulties to be overcome in arriving at a satisfactory mode of measuring angles. The mode actually adopted is to measure angles by certain straight lines, or ratios of straight lines, related in a certain fixed manner to the angles. These are called the sines, tangents, &c. of the angles. Their relations and axes are discussed in the treatise on *Plane Trigonometry*, which contains :—1. A view of the relations between the sines, &c., of the same and of different angles, which part of the subject is often called the *arithmetic* of sines, and

PREFACE.

the expressions for the chief relations between the sides and angles of triangles :—
 2. A somewhat full view is given of the mode of constructing tables that give for fixed intervals, *e.g.* of 1' or of 10", the sines, &c., of every angle from 0° up to 90°, and the logarithms of those sines, &c ; this part of the subject being completely analogous to the treatise on Series and Logarithms :—3. A full account of the application of the formulas of 1, by means of tables calculated as explained in 2, to the actual calculation, from certain data, of the sides and angles of triangles.

The treatise on Mensuration may be regarded as an Appendix to that on Plane Trigonometry. It contains a considerable variety of questions on the determination of heights and distances, of areas, of surfaces, and contents of solids—of nearly all such as are likely to occur in practice. The results in this treatise are always given as formulas, which, it is thought, are more easily remembered, and more readily reduced to numbers than rules—though in several cases, where a rule seemed to possess any advantage, it is stated, as well as the formula on which it is founded ; *e.g.*, in the case of the area of a surface bounded by an irregular curve.

The treatises on Spherical Geometry, Spherical Trigonometry, and Practical Geometry, scarcely require any special mention,—the authors of the respective articles having stated everything that appeared essential.

The present volume, treating only of *Elementary* Mathematics, contains no general discussion of questions involving the idea of a limit, or any general investigation of the properties of conic sections ; however, in a few cases it has been found necessary to overstep the boundary thus imposed on the writers. Wherever any reasoning about a limiting value is introduced, it is of so simple a kind as to present no serious difficulty. Moreover, the general conception of a limit has been stated explicitly in page 330. Certain questions depending on conic sections are sometimes of practical importance ; and some of the determinations in the treatise on Mensuration, presume a knowledge of their more elementary properties. These properties have been proved at the end of Mr. Jardine's Treatise on Practical Geometry, where they occur as demonstrations of the constructions for which he gives rules. They also supply everything that is required for the complete understanding of pages 376 and 377, and of pages 398 and 399.

Before bringing our Preface to an end, we must offer a few words of advice to our readers who are inclined to study Mathematics earnestly. The reader will find several hints given in the body of the work which he will find useful, as in the introduction to Arithmetic (page 1), the remarks on Euclid's First Book (page 68), and elsewhere. We may here observe, that those parts of the subjects which are distinct problems, as distinguished from those which are instruments of further investigation, do not require so much labour in the acquiring as the latter. The parts of the present volume which the student may look upon as instruments of investigation, without a thorough knowledge of which

further advances in Mathematical Science are simply impossible, are these:—Fractional, Decimal, and Logarithmic Arithmetic. The Elementary processes of Algebra, the first part of Trigonometry (pages 292 to 329), and the six books of Euclid's Geometry, the earnest student ought not merely to understand, but to be thoroughly familiar with—as familiar as he probably is with the common operations of Arithmetic. He will find, in these parts of the subject, a variety of exercises, all of which we strongly recommend him to perform, and to test his knowledge of the text by writing out *from memory*—and that more than once—the substance of articles above indicated. This may seem rather stern counsel, but it is necessary. Self-examination by *writing* is the only way in which real knowledge of any kind can be tested; and it is specially needed in Mathematical Science, in which the least vagueness is not partial knowledge but *ignorance*.

In regard to the other parts of the volume—that is, in the exposition of the mode of constructing tables of Logarithms—it is not so essential that the student should always have that ready at hand to refer to on a moment's notice. It is sufficient that he do not leave it till he thoroughly understands the method of investigation.

It is also to be observed, that the student should always make a point of forming a *distinct conception* of every proposition he reads; otherwise he can never really understand his subject. Perhaps one of the most valuable results of Mathematical studies is, that they compel the student to form clear conceptions of things that can be clearly conceived; and from this circumstance they derive their name of Mathematical, that is, disciplinary studies. The value of the mental training derived from obtaining a thorough mastery of even as much as the first six books of Euclid, can hardly be over-rated. Compared with this, the practical applications of the science, which are themselves by no means unimportant, are of trifling value. Of course, to obtain this benefit the student's powers must be employed *actively*. He must *think*, as well as *attend*; and must exercise care and judgment in ascertaining whether he has really understood what he has read. There are comparatively few people ready to undergo this labour, and this circumstance at one time made us feel doubtful whether the mathematical volumes of the "CIRCLE OF THE SCIENCES" would meet with so favourable a reception as some other departments of our work. The increased sale of the later numbers, however, has proved our fears to be unfounded, and seems to show that we have a large number of readers who are ready to accompany us through the more abstruse sciences.

THE EDITOR.

AMEN CORNER, October, 1854.

CONTENTS.

PAGE	PAGE
ARITHMETIC introductory to Geometry	2
Uses of the Science	3
The Ten Figures, and their local value	6
The Simple Rules of Arithmetic	7—19
The Compound Rules	21—25
FRACTIONS	26—30
Proportion, and Rule of Three	31, 33
DECIMALS	36—38
Extraction of the Square Root	38
Table of Factors	41
GEOMETRY, PLANE	43
Elements, &c., of Euclid	43—48
Propositions of Book I.	48—68
Commentaries on, and Exercises	69, 85
Propositions, &c., of Book II.	87—92
————— of Book III.	97—112
————— of Book IV.	116—124
The Quadrature of the Circle	126
Exercises in the First Four Books of Euclid	128
PROPORTION, intended as a Substitute for Euclid's Fifth Book	129
Propositions, &c., of Book VI.	144—168
ALGEBRA; its general Principles	161
Addition and Subtraction	166, 168
Multiplication and Division	179, 187
Exponents, Roots, and Surds	191
Evolution	193
FRACTIONS	196—201
Equations	201—217
Ratio and Proportion	218
Arithmetical and Geometrical Pro- gressions	220—224
Extraction of Square Roots	228—232
To Extract the Cube Root of Compound Quantities.	235
PLANES, embracing the Eleventh Book of Euclid	241—250
SFERICAL GEOMETRY	251
LOGARITHMS	261—261
Permanence of Equivalent Forms	261
On the Theory of Indices	262
On Impossible Expressions	262
The Convergent and Divergent Series 264, 265	
The Binomial Theorem	266, 269 et seq.
On the Calculation of Logarithms	275
Calculation of the Arithmetical Values of Quantities expressed by Infinite Series	275
How Logarithms facilitate Calcula- tions	276, 277
Practical Advantage of Calculating Logarithms to the Base	10, 278
How every number has a Calculable Logarithm	279
How Value may be derived from the Logarithmic Series	279
The Numerical Value of Logarithms	281
Use of a Table of Logarithms	283, 284
Method of Finding the Characteristic	286
To Find the Logarithm of a Number not given in the Tables	286
Various Problems for Finding Loga- rithmic Numbers	286—288
Method of Finding any Power of a Number	289, 291
PLANE TRIGONOMETRY	292
On representing Lines and Angles by Numbers	292
Definition of the Science	292
The Circular Measure of an Angle	293

PAGE	PAGE		
Definitions of the Trigonometrical Sines and Ratios	294, 298	The Distance between two Points	369
The Use of the Negative Sign to denote Position	298	The Mensuration of Areas	371'
Extension of the Definitions of Angles and Trigonometrical Ratios	298, 300	To find the Area of a Rectangle	371
On the Magnitudes of the Trigonometrical Functions of Angles	301	Of a Trapezoid	372
Angles which have the same Sine or Cosine	303	Areas of Trapeziums and Polygons	373
The Trigonometrical Functions of different Angles	304	To determine the Area of a Circle and its Segments	374, 375
Methods of proving the different Formulas	305, 308	Of an Ellipse	376
Relation between the Four Fundamental Formulas or Expressions	309	Of a Parabola	377
The Sines and Cosines of Multiples of given Angles	310	Of a Plane Figure bounded by a Curve	378
Ambiguities arising from the use of Formulas	311 et seq.	Of a Curvilinear Figure	379
Numerical Value of Sines, Cosines, &c.	315	Of a right Prism, of a Cylinder, and of a Cone	380, 381
Trigonometrical Ratios of Angles	316, 317	Of the Surface of a Sphere	382
Formulas connecting inverse Trigonometrical Ratios	318, 319	The Mensuration of Solids	383, 384
The Use of Subsidiary Angles	320, 321	The Equality of Parallelepipeds	385, 386
Relation between the Sides and Angles of Triangles	322	Volume of Prism	387
Deduced and Derived Formulas	323	Volume of the Pyramid	388, 389
Formula for Logarithmic Calculation	325	Volume of a Frustum of a right Prism	389-391
Theorems	326, 329	Volume of a Prismoid	391
On Trigonometrical Series and Tables	330—530	To Find the Solid Content of a Railway Cutting	393
Method of checking the Calculations	351	Of a Military Earthwork	394
Calculation of Tangents and Cotangents, &c.	352	Volume of Frustum of a right Cone	395
Tables of Natural Sines	353	Volume of a Sphere	397, 393
Tables of Logarithmic Sines	355		
Logarithmic Sines of small Angles	357, 359		
Delambre's Method	360		
Numerical Solution of Right-angled Triangles	361—366		
MENSURATION	367		
On Heights and Distances	367		
On determining the Height of a Tower	367, 368		
		SHERICAL TRIGONOMETRY	401
		Sines of the Angles of a Spherical Triangle	402
		Fundamental Formulas	403
		To prove the Formulas	406
		Napier's Analogies	407
		The Solution of Right-angled Spherical Triangles	408
		PRACTICAL GEOMETRY	421
		Instruments for Use	421
		CONIC SECTIONS	438
		Properties of the Ellipse	439
		Construction of an Oval	443
		The Parabola	444
		The Hyperbola	446
		The Cycloid	447



THE MATHEMATICAL SCIENCES.

Introductory.—THE present volume is to be devoted to that branch of study implied in the term **MATHEMATICS**,—a term which comprehends one of the most extensive and important departments of human knowledge. By most people, it is considered also as one of the most *difficult* departments; and many, with time and talents for the task, are deterred from entering upon a study which would amply repay the expenditure of both, by this mistaken prejudice. Every science, no doubt, has its hard and knotty points; and in no intellectual pursuit can distinction be attained without labour, thought, and perseverance; yet if there be one subject of scientific inquiry which, more than any other, is distinguished by the simplicity, certainty, and obviousness of its fundamental principles,—by the irresistible evidence by which position after position is established,—and by the systematic gradations by which layer after layer of the intellectual structure is completed,—that subject is Mathematics.

In other topics of research, there is generally more or less of hypothesis, or conjecture: there are obscure recesses, into which the light of truth and demonstration cannot penetrate, and where fancy and imagination are sometimes permitted to guide our steps. But there are no perplexities of this kind in mathematics,—no ingenious theories to mislead, and no conflicting opinions to bewilder; our progress here is exclusively under the unerring direction of **TRUTH** herself; and it is her torch alone that lights up the path.

Whatever, therefore, may be the difficulties connected with the study of mathematics, it is plain that they do not arise from our having to grope our way in darkness and uncertainty; the asperities of the road are as clearly revealed before us as the level and

unobstructed track; and all that the earnest student requires, is some friendly hand, to aid him in surmounting those in the earlier stages of his progress.

It is this sort of aid that we here propose to supply. We do not undertake to conduct the scientific inquirer through the entire regions of mathematical research—ours is a far less ambitious aim: we write for the young—for the self-dependent—the solitary—and, perchance, the unfriended student. The office we here take upon ourselves will be performed, if we succeed in the endeavour to assist *him*. This is the only object at which we now aim, and we think it right thus explicitly to declare it, in order to forewarn those who may desire information on the more recondite researches of science, that the present volume is not intended for them.

It may be proper to mention, however, that although we now propose to limit our labours to an exposition of the elementary principles of mathematical learning, and to economize space as much as possible; yet, within the bounds prescribed, we shall take care that every subject receive a full and fair elucidation, and that it be discussed to an extent amply sufficient for the purposes of general education. We hope, too, by avoiding all attempts at magisterial dignity of style, and addressing our readers in the familiar language of social intercourse, to secure their attention, and win their confidence; and that we may be fortunate enough, by clearness and simplicity of explanation, to awaken in some a genuine love for science, and a desire to prosecute their researches in writings of wider scope and higher pretensions: we shall endeavour to gratify such desire in a subsequent volume.

We have thought it advisable to commence our work on elementary Mathematics with a preliminary treatise on Arithmetic—the groundwork upon which the entire system, with the exception of pure geometry, ultimately rests. Books on arithmetic, however, are so numerous, and so easily accessible, that we might have been held excused from introducing so hackneyed a subject into a work which, though confessedly of the most elementary character, is, nevertheless, intended to embrace a range of topics beyond the ordinary limits of a school-boy course. But it unfortunately so happens, that books on arithmetic, with few exceptions, are little more than mere depositories of practical rules and mechanical operations; and are, therefore, but ill-suited to prepare the young for that higher kind of exertion—higher, because more intellectual—which science, properly so called, always demands.

A boy who has gone through his “Walkingame,” and who, as matter of course, is then introduced to “Euclid,” is naturally enough bewildered by the total dissimilarity of the two authors—not from difference of subject, but of manner of exposition: the former has abundantly supplied him with *rules*, but no reasons; the latter gives him *reasons*, but no rules: the one has loaded his memory, and employed his fingers; while the other appeals to his judgment, and exercises his understanding.

To make, in this way, the passage from arithmetic to geometry, an abrupt transition from the mechanical to the intellectual, we conceive to be a capital defect in educational training. Arithmetic is as much a science as geometry: there is not a rule in the one, any more than there is a theorem in the other, that is not founded on reason, and demonstrably true. And even viewing arithmetic merely in reference to its practical utility in commercial affairs, to the demands upon it in the counting-house and the shop,—we still contend that its principles should be rationally taught—not authoritatively declared, inasmuch as that which has engaged the understanding, and been received from a conviction of its truth, is more securely retained in the memory than what is committed to it by rote. Rules, unsupported by reasons, are hard to learn, and hard to remember; but, when the

practical precept is associated in the mind with the theoretical principle on which it depends, we learn and remember with ease and satisfaction; for, instead of words, we get knowledge.

These considerations have prevailed with us; and have determined us to render this course of elementary mathematics complete, by commencing at the very foundation. It must be borne in mind, however, that our design is not to exhaust here any subject of which we treat: it is rather to excite an appetite for knowledge, than to satiate it. It will not be expected, therefore, that our treatise on arithmetic is to be co-extensive with what, under that name, is usually put into a schoolboy's hands; the bulk of such books arises, in a great measure, from the system of instruction condemned in the preceding observations; the object of which system seems to be to inculcate a knack of readily applying *rules*, by experimenting upon numerous examples, under the guidance of the prescribed directions. This, as the reader has already been made aware, is not our object; we propose to explain *principles*, and to furnish the reasons that justify the rules; persuaded that, if the former be thoroughly apprehended, there need be but little anxiety felt about the mere verbal memory of the latter.

The subjects to be treated of in the present volume are as follows:—Arithmetic, Geometry, Algebra; Logarithms and Series; Probabilities, and the Principles of Life Assurance; Trigonometry, Conic Sections, Mensuration, Differential Calculus, Integral Calculus; Applications of the last two subjects to Mechanical and Physical inquiries; and a short treatise on the Theory of Equations.

It would extend these introductory remarks far beyond the space that can be allotted to them, to enter into any detailed account here of the several particulars to be introduced under the above-mentioned heads; but we cannot conclude them without a few words more especially addressed to those who have resolved to place themselves under our instructions.

It is a common thing with young students in science to be frequently making inquiries as to the *use* of what they are learning. "What is the *use* of this?" is a question put at every turn; generally to the annoyance of the teacher, and often to the discredit of the learner.

The use of any intellectual pursuit—employing the term *use* in its higher and more honourable signification—is to be realised in the mental satisfaction and the mental elevation it communicates. You do wrong to estimate science solely and exclusively in proportion as it visibly contributes to our animal wants and enjoyments; there is an intellectual pleasure in the very process of acquiring knowledge, while the conscious possession of it raises the human being in the scale of creation, and thus enables him to contemplate its wonders from a more exalted position. It is in this way that knowledge, like virtue, to which indeed it is allied, is said to be its own reward; for the study of science is accompanied with gratifications of the purest and loftiest kind; and is productive of advantages to the student, altogether distinct from the benefits conferred by its applications to the practical purposes of life; it invigorates and enlarges the faculties—refines and elevates the desires—and adorns and dignifies the entire character, withdrawing our thoughts from what is mean and degrading, and inclining them to the noblest and worthiest of objects—to the love and veneration, and therefore to the practice, of *TAUTU*.

These advantages, though unconnected with outward and tangible results, are surely too precious to be entirely overlooked in any correct estimate of the value of scientific

pursuits. When, in the course of these, you find yourself engaged in an inquiry that may seem to have but little relation to the things of sense, and are, on this account, disposed to ask—what is the *use* of it? just reflect whether the intellectual exercise has not been combined with intellectual gratification; and whether there be not an abstract beauty in the result arrived at, that awakens pleasurable feelings, practically realised, though hard to be described. We think the reflection will, in general, suggest an answer to the inquiry in some measure satisfactory.

Those tranquil and purely intellectual enjoyments have prompted and encouraged the efforts of the wisest of men—have cheered and sustained them amidst penury and neglect; and, under the persecutions of power, wielded by ignorance, have supplied a consolation second only to that which Divine revelation affords; and they have finally been regarded as no mean reward for a life thus tried, and toils thus endured. They were considered as compensation sufficient for the labours even of NEWTON,—many of whose discoveries in science would, in all probability, never have been given to the world but for the urgent interference of private friends.

We are anxious that you should be influenced by considerations such as these; and that you should regard science as something more than a ministering agent to our animal comforts, or even to our social gratification and convenience. The practical benefits of science—and more especially of those departments of it connected with the subjects of the present volume—are in little danger of being overlooked or under-valued; they are spread profusely around us; and are felt and enjoyed by all. And there thus seemed to be all the more need for directing your attention to collateral advantages—less palpable and striking, and therefore less likely to be duly appreciated.

We shall now proceed to the business before us; we shall assume no knowledge at all on your part in reference to the topics to be discussed; and, in even so simple a subject as ARITHMETIC, we shall begin at the beginning.



Arithmetic.—Arithmetic is that branch of knowledge that teaches us how to perform calculations by means of numbers. The rules which direct the various operations constitute the *art* of arithmetic: the reasons and principles on which these are founded belong to the *theory* of arithmetic, and the theory and practice united, form the *science* of arithmetic. It is this that I am now going to explain. You are aware that the symbols, or marks, employed in this subject are called *figures*, and that they are as follow: 1, 2, 3, 4, 5, 6, 7, 8, 9, together with the mark 0, called *nought*, or *cipher*, or *zero*, and which stands for *nothing*. This 0 is also called a *figure*, so that there are *ten figures* in arithmetic: the number of *units*, or *ones*, which each stands for, is here written,—

nothing,	one,	two,	three,	four,	five,	six,	seven,	eight,	nine.
0	1	2	3	4	5	6	7	8	9

Each of these figures is also called a *number*: but the word number has a wider meaning. Thus, 26, 43, 57, &c., are all numbers, each of which consists of *two figures*; the first number is *twenty-six*, the second *forty-three*, the third *fifty-seven*, and so on; so that, you see, the 2 in the first stands for *two tens*, the 4 in the second for *four tens*, and the 5 in the third for *five tens*. In like manner 368 is a number of *three figures*. The first figure, 3, stands for *three hundred*; the second, 6, for *six tens*, or *sixty*; and the third, 8, for *eight ones*, or *units*: the number itself standing for *three hundred and sixty-eight*.

You thus perceive that a figure which, when written singly, stands merely for so many *units*, changes its meaning, or value, according to the *place* it occupies in a number of several figures. If it occupy the last, or right-hand place, it still stands for units; but if it be in the next place, to the left, it stands for so many *tens*; if in the place next to that, for so many *hundreds*; and if it occupy the fourth place from the end, it stands for so many *thousands*: the number 7362, for instance, is seven thousand three hundred and fifty-two.

Figures thus have a *local* value, that is, a value depending upon the places they occupy in a number. The following is a number of *twelve* figures; and when the local values of these figures are written against them, it supplies what is usually called the

NUMERATION TABLE.

2	4	6	8	7	3	1	5	9	4	3	8
hundreds of thousands of millions.	tens of thousands of millions.	thousands of millions.	hundreds of millions.	tens of millions.	millions.	hundreds of thousands.	tens of thousands.	thousands.	hundreds.	tens.	units.

And this number is read thus,—two hundred and forty-six thousand eight hundred and seventy-three MILLION, one hundred and fifty-nine THOUSAND, four hundred and thirty-eight.

A person beginning to learn arithmetic will be enabled, by means of the above table, to read any number,—that is, to express its value in *words*. In a large number like that here given, the easiest way to proceed is this. Cut off the *last three* figures, then the next three, then the next, and so on; thus dividing the figures into sets of three as far as possible. A glance at the *table* shows that the leading figure of each set is *hundreds* of something; that of the first set, on the right, is *hundreds* of *units*, or simply *hundreds*; that of the next set is *hundreds* of thousands; that of the next, *hundreds* of millions; and so on. And by thus finding out the *local* value of the leading figure in each *period*, as it is called, you may read the number with ease. For example, the number 68547329, when divided into periods, as here proposed, is 68,547,329: pointing to the 3, you say *hundreds*, and passing to the 5, *hundreds* of thousands; the incomplete period, 68, must therefore be 68 *millions*; and the entire number 68 million, 547 thousand, 329; or, expressing the value wholly in words, it is sixty-eight million, five hundred and forty-seven thousand, three hundred and twenty-nine. In a similar way we find the number 42638572613, or 42,638,572,613, to be 42 thousand 638 million, 572 thousand, 613. If you wished to put this wholly into words, all you would have to do would be to write forty-two for 42, six hundred and thirty-eight for 638, five hundred and seventy-two for 572, and six hundred and thirteen for 613. The leading figure of a complete period, you know, is always *hundreds*; and when you have found by the *table* what these hundreds are, or from practice can recollect what they are, you can have no difficulty in reading

the number. When any of the figures are *noughts*, a little extra care is, however, necessary. Thus, the number 460305007, which, divided into periods, is 460,305,007, is read four hundred and sixty million, three hundred and five thousand, and seven.

From what has now been said, you clearly see what is meant by the *local* value of a figure. If it occupy the place of *units*, its value is so many *ones*; if it be in the place of *tens*, its value is *ten times* as many ones, that is, it represents so many *tens*; if it be in the place of *hundreds*, its value is *ten times* as many *tens*; if in the place of *thousands*, it is *ten times* as many *hundreds*; and so on. So that, as you advance a figure, place after place, towards the left, you increase its value *tenfold* at every remove: thus, 8 is simply eight *ones*; 80, where the 8 is now in the *second* place, and *nothing*, or *nought*, in the first place, is *eighty*, or *ten times* eight; 800, where the 8 is in the *third* place, and *noughts* in the first and second places, is *eight hundred*, or *ten times* eighty; and so on. This tenfold increase in the value of a figure, when it is removed one place from right to left, explains why our system of numeration is called the *decimal system*; the word *decimal* being derived from a Latin word, meaning *ten*. It was a beautiful contrivance thus to give a *local*, as well as an absolute value, to the symbols, or figures, used in the *notation* of arithmetic.* You see that by this happy idea we are enabled to express all numbers whatever by the help of only *ten* different marks, or symbols: whether we owe it to the Arabs, or to the Greeks or Romans, is a question on which there is still some doubt.

It ought, perhaps, to be mentioned, that although the numbers considered above do not extend beyond twelve figures, numbers with more figures than these may occur, and that there are words to express the additional periods. If the number have *thirteen* figures, the leading figure on the left would stand for so many *billions*; and if a complete additional period were joined to a number of twelve figures, making a number of *fifteen* figures, then the leading figure on the left would, of course, be *hundreds* of billions. But *billions*, *trillions*, *quadrillions*, &c., are names so seldom employed or wanted, that the numeration table need not be encumbered with them. It may be worth a passing notice, too, that no distinct ideas are conveyed by any of these terms; beyond a very moderate extent our notions of the value of numbers become confused. The number of *ones* in a million, even, is hard to conceive: it is a thousand thousand, and would take you more than twenty-three days to count, though you kept at it for twelve hours a-day, and counted one every second. Our ten figures, or *digits*, as they are often called (*digitus* being Latin for finger, and our ten fingers suggesting the word†),—our ten figures thus enable us accurately to express on paper, without the error of a single unit, numbers too great to be even conceived or imagined.

Before concluding these remarks on numeration, it may be as well to show the beginner how a number expressed in *words* may be translated into *figures*. This is not quite so easy as to translate figures into words; the plan is as follows:—

Write down a row of *noughts*, or *ciphers*, and, as if these blanks were numbers, mark off the *periods*: then, commencing at the first cipher on the left, put under each the proper *figure* in the number proposed, taking care that it be in its proper *place*: if any *vacancies* appear under the corresponding ciphers, fill them up with *noughts*. Thus, let it be required to put into figures the number five hundred and six million, thirty-four thousand, and forty-eight. We know that the place of *millions* has *six* places to the

* The marks, or symbols, made use of in any science, constitute the *notation* of that science.

† Names frequently throw light on the origin of things: it is interesting to notice that the name *digit* is plainly significant of the early rude method of counting on the fingers; and that the name *calculation* as plainly refers to the primitive practice of reckoning with *pebbles* (*calculus*, a pebble).

right of it; we therefore put a nought for the millions, and write six noughts after it, and, as we see, from *hundreds* being the leading word in the written expression, that the first period will be a *complete* period, we *prefix* two noughts more. The requisite row of noughts, divided as proposed, is as in the margin, and under these we now have to write, in their proper places, the figures 5, 6, 3, 4, 000 000 000
4, 8, and then to fill up the gaps with noughts; we thus find 506 034 048
the number, when written in figures, to be 506,034,048. The learner will be able to do without such helps as these after a little practice; he should accustom himself to express in words the numbers he uses, when these are of moderate extent, and not content himself with merely looking at them.

I shall now proceed to the four fundamental operations of arithmetic: these are *addition*, *subtraction*, *multiplication*, and *division*. There are no calculations, however long and intricate, that are not composed of one or more of these four.

Simple Addition.—Addition teaches us how to add numbers together, and so to find the *sum* of all. It is called *simple* addition, when the numbers to be added either have no reference to particular *things* or *objects*, or when the things referred to are *all of the same denomination*: thus, if 24 pounds, 37 pounds, 82 pounds, &c., were all to be added together, the operation would be that of simple addition; but if 24 pounds 7 shillings, 37 pounds 2 shillings, 82 pounds 12 shillings, &c., were to be added, then, as pounds and shillings are different things, the operation would not be *simple*, but *compound* addition; one of the first set of things being called a *simple* quantity, and one of the other set a *compound* quantity. The rule for performing simple addition is as follows:—

Rule.—Arrange the numbers to be added one under another, so that the first column of figures on the right may be *units*, the next column *tens*, the next *hundreds*, and so on. This is nothing more than preserving each figure in its proper place. Add up the units' column: if it amount to a sum expressed by only *one* figure, put this figure down under the units' column. But if it be a number of more than one figure, the *last* figure only of that number—the *units'* figure—is to be put down, and the number expressed by what is left, after rubbing out the figure thus put down, is to be *carried* to the next, or *tens'* column, and added in with that column.

If the sum of the *tens'* column be a single figure, it is to be put down under that column; but if it be a number of more than one figure, then, as before, only the last, or *units'* figure, of that number, is to be put down, and the number which is expressed, after the figure put down is rubbed out, is to be carried to, and added in with, the figures in the next column, and so on; observing, that when the last column is reached, the entire sum of that column is to be put down. Suppose, for example, the following numbers are to be added together,—namely, 246, 357, 26, 148, and 6; then, writing the numbers, one under another, as in the margin, so that the *first* column on the right may be a column of *units*, the next a column of *tens*, and the next a column of *hundreds*, we proceed, under the direction of the rule, as follows:
6 and 8 are 14, and 6 are 20, and 7 are 27, and 6 are 33; there are, therefore, in the first column, 33 units; that is to say, 3 *tens*, and 3 *units*: the 3 *units* we put, of course, under the column of units, but we carry the 3 *tens'* to the next, or *tens'* column, and say,—3 and 4 are 7, and 2 are 9, and 5 are 14, and 4 are 18; that is 18 *tens*: the 8 we put down, but the number left, after rubbing this out, namely 1, we carry to the next column, as it is clear we ought to do; for this 1 is one more place to the left; it stands for *one hundred*, and therefore

246
357
26
148
6
—
783

belongs to the hundreds column : any figure next, on the left, to a figure that stands for *tens*, must, from the principles of numeration, stand for *hundreds*. Carrying, therefore, the 1 to the hundreds' column, we say, 1 and 1 are 2, and 3 are 5, and 2 are 7 ; that is, 7 *hundreds* : so that the sum of the proposed numbers is 783 ; that is, seven hundred and eighty-three. From this operation you see that the figures of the *sum* are all carefully put in their proper places, so that each has its own *local* value ; the numbers *carried* from one column to the next, are so carried because they really *belong* to the place, one in advance, to the left. As a second example, let the numbers 8462, 873, 758, 4702, and 7003 be added together. Arranging these numbers one under another, as before, taking care not to disturb their local positions, we proceed thus :

3 and 2 are 5,	8462
and 8 are 13, and 3 are 16, and 2 are 18 ; 8 and carry 1 : 1 and 5 are 6, and 7 are 13, and 6 are 19 ; 9 and carry 1 : 1 and 7 are 8, and 7 are 15, and 8 are 23, and 4 are 27 ; 7 and carry 2 : 2 and 7 are 9, and 4 are 13, and 8 are 21 ; therefore the sum is 21798 : that is, twenty-one thousand seven hundred and ninety-eight. It is plain, from the foregoing illustrations, that the rule for addition is in strict accordance with the system of notation and numeration already explained, and that it must always lead to the correct result. There is no <i>figure</i> higher than 9 : <i>ten</i> , of any denomination (<i>hundreds, thousands, &c.</i>), is <i>one</i> of the next higher denomination ; so that in adding up any column of figures, all of the same denomination, for every <i>ten</i> in the sum, <i>one</i> must be carried to the next column ; and, therefore, as many <i>ones</i> as <i>tens</i> .	873
	758
	4702
	7003
	21798

You have already seen that the marks used in the *notation* of arithmetic are *figures* : besides these, other marks are frequently employed to *indicate operations* with these figures, and to express relations among them : thus, instead of saying 2 and 5 are equal to 7, the form $2 + 5 = 7$, is used to express the same thing : the mark $+$ being the *sign for addition*, and the mark $=$ the *sign for equality* : this must be borne in mind : $+$ is called *plus* ; so that $2 + 5 = 7$, may be read 2 *plus* 5 equals 7, or 2 *plus* 5 are equal to 7. The following, therefore, are statements in symbols, instead of in words, which you will at once understand : $2 + 5 + 1 = 8$; $3 + 4 + 2 = 9$; $6 + 5 + 3 + 1 = 15$. A few examples in addition are here given under this form. You will have to arrange the numbers in them in columns, as in the two examples worked above ; and, if the results of your addition be correct, they will be found to agree with the numbers to the right of the sign of equality :—

- (1.) $321 + 643 + 201 + 16 = 1214$. (2.) $56 + 320 + 708 + 17 + 3 = 1081$.
 (3.) $5684 + 340 + 7006 + 309 + 824 = 14163$.
 (4.) $20065 + 8473 + 751 + 92083 + 564 + 92 = 122028$.

Simple Subtraction.—Subtraction teaches us how to subtract the smaller of two numbers from the greater, or to find their difference, which is called the *remainder*. The operation is called *simple* subtraction when the numbers refer to things of the same denomination, as in *simple* addition. The rule for simple subtraction is as follows :

RULE.—Put the smaller number under the greater, taking care, as in addition, that *units* shall be under *units*, *tens* under *tens*, and so on.

Then, beginning at the *units*, subtract each figure in the lower row from the figure above it, if the lower figure be not the *greater* of the two, and put the remainder underneath (see the operation in the margin, where 34572 is subtracted from 68594, and the remainder found to be 34022).

From 68594
Subt. 34572
Rem. 34022

But if you come to a lower figure, which is *greater* than the figure above it, add 10

to the upper figure, and then subtract, putting down the remainder as before, and taking care to *carry* 1 to the next figure of the lower row.

For example: let it be required to subtract 27385 from 64927; then, placing the former number below the latter (as in the margin), we proceed thus: 5 from 7, and 2 remain: 8 from—not 2—but 12, and 4 remain; carry 1: 4 from 9, and 5 remain: 7 from 14, and 7 remain; carry 1: 3 from 6, and 3 remain.

From 64927
Subt. 27385

Rem. 37542

All that requires explanation here is the *carrying*, as in the former rule. In the preceding example we see that the 8 cannot be taken from the figure above it, because *this* is only 2: we, therefore, add 10 to the 2, converting it into 12; but the adding 10 to any figure is simply putting 1 before it; that is, it is adding 1 to the *preceding* figure, which 1, by carrying it to the next lower, or subtractive figure, is taken away again at the next step. In like manner the 4, in the upper row, is converted into 14, and the 1 thus prefixed to it is afterwards taken away, by 1 being carried to the next lower figure, and 3 subtracted instead of 2. It is plain that in *subtraction* the carrying can never amount to more than 1.

As another example, let 86025704 be subtracted from 130741392: then, having arranged the numbers as in the margin, we proceed thus: 4 from 12, 8; carry 1: 1 from 9, 8: 7 from 13, 6; carry 1: 6 from 11, 5; carry 1: 3 from 4, 1: 0 from 7, 7: 6 from 10, 4; carry 1: 9 from 13, 4: therefore the remainder is 44715688.

From 130741392
Subt. 86025704

Rem. 44715688

There is a *sign for subtraction* as well as one for addition: it is the little mark — placed before the number to be subtracted; it is called *minus*: 5—2 is therefore 5 *minus* 2, that is, 5 *diminished* by 2; the remainder, or difference, is of course 3: so that 5—2=3. By help of the plus and minus signs, we can easily connect together in a single row a set of numbers, of which some are to be added, and others to be subtracted; thus, 4+6—3—2 means that 4 and 6 are to be *added*, and 3 and 2 are to be *subtracted*; so that 4+6—3—2=5. Instead of subtracting first 3 and then 2, we may, of course, subtract 5 at once; so that the above is the same as 10—5=5; and whenever addition and subtraction operations are indicated in this way, it will always be best to find first the sum of the *additive* quantities, then the sum of the *subtractive* quantities, and then, as in the foregoing example, to find the *difference* of the two results: in this manner the result of 125+427—684+237—15, is computed as in the margin, and found to be 90. So that 125+427—684+237—15=90.

125	684
427	15
237	-----
-----	659
789	
699	-----
-----	90 result.

I shall here add a few examples to be worked in a similar manner:

- (1.) 361+483—246—179=419.
- (2.) 573—184+602—67=924.
- (3.) 86243+721—649—70+13—9=86319.
- (4.) 12064+700628—109641+637—2604=601084.
- (5.) 23596—625+72311075—13758—35062.5+6879=68820882.

In order to *prove* whether subtraction is correctly performed, *add* the remainder to the number which has been subtracted,—that is, to the *lower* of the two proposed numbers; the *sum* will be the *upper* number, if the work be correct: thus, in each of the two examples above, we have

Subtractive number	27385	86025704
Remainder . . .	37542	44715688
-----	-----	-----
Upper number . .	64927	130741392

Simple Multiplication.—Multiplication is the method of finding the *sum* of any number of *equal* quantities, without the trouble of repeating them, one under another, and adding them up; it is a short way of obtaining the *results of addition*, when the numbers or quantities to be added are all *equal*. When the quantities are not only equal, but all of one denomination, the operation is called *simple multiplication*.

To perform this operation readily, a *table*, called the *multiplication table*, must first be learnt; and the result which arises from multiplying one number by another, provided neither be greater than 12, must be committed to memory; it is one of the few operations in arithmetic where the memory of rules is indispensable.

The number by which another is to be multiplied, is called the *multiplier*; the number which is multiplied, the *multiplicand*; and the result obtained, and which, as just stated, is the same as would be got by writing down the multiplicand as often as there are units in the multiplier, and adding all up,—this result is called the *product*. The multiplication table shows what the product is in every case in which neither multiplicand nor multiplier exceeds 12; and, by knowing this table, the product may always be found, whatever numbers be proposed as multiplicand and multiplier. It may be as well to mention here that the numbers called by these names, when spoken of together, are generally called *factors* of the product, as they *make* or produce it: thus, 2 and 3 are *factors* of 6, since 3 taken twice, or 2 taken three times, make or produce 6.

MULTIPLICATION TABLE.

Twice	3 times	4 times	5 times	6 times	7 times	8 times	9 times	10 times	11 times	12 times	
1 are 2	1 are 3	1 are 4	1 are 5	1 are 6	1 are 7	1 are 8	1 are 9	1 are 10	1 are 11	1 are 12	
2	4	2	6	2	8	2	10	2	12	2	14
3	6	3	9	3	12	3	15	3	18	3	21
4	8	4	12	4	16	4	20	4	24	4	28
5	10	5	15	5	20	5	25	5	30	5	35
6	12	6	18	6	24	6	30	6	36	6	42
7	14	7	21	7	28	7	35	7	42	7	49
8	16	8	24	8	32	8	40	8	48	8	56
9	18	9	27	9	36	9	45	9	54	9	63
10	20	10	30	10	40	10	50	10	60	10	70
11	22	11	33	11	44	11	55	11	66	11	77
12	24	12	36	12	48	12	60	12	72	12	84

That the product in any case is really what the table states it to be, the learner can easily prove for himself; he has only to take the multiplicand as often as there are units in the multiplier, and, by addition, to find the sum of all; thus, the table states that 3 times 6 are 43, which is true, because 6, written eight times, and all added, produce 48, that is,

$$* 6 + 6 + 6 + 6 + 6 + 6 + 6 + 6 = 48.$$

and so of any other pair of *factors* within the limits of the table.

I. When the Multiplier is not greater than 12.

RULE.—Put the multiplier under the multiplicand, units under units; and, by aid of the table, multiply each figure of the multiplicand, commencing at the units' figure, by

the multiplier. Set down the right hand figure only of the product when it is a number of more than one figure, and carry as in addition.

For example: multiply 6432 by 4. The multiplier 4 being placed under the multiplicand 6432, as in the margin, we proceed thus: 4 times 2 are 8; 4 times 3 are 12; 2 and carry 1: 4 times 4 are 16, and 1 are 17; 7 and carry 1: 4 times 6 are 24, and 1 are 25.

A beginner, with the table before him, can easily perform operations of this kind; but he must learn to work them without looking at the table. It is as well to show him the time and trouble saved, by actually exhibiting the work of such examples by addition, as here annexed. The following, worked like the example above, require no further explanation:—

6432			
6432	78326	9073214	57387
6432	8	9	10
6432			12
25728	626608	81658926	573870
			3169620

The multiplication by 10, as in the third of these examples, requires, in fact, no actual work, or reference to the table. You know that a number becomes ten times as great by simply putting a 0 after the figures; this causes each figure to advance a place to the left, so that its local value is increased tenfold. In like manner, a number becomes multiplied by 100 when two 0's are added to it; by 1000 when three are added, and so on, as is evident from *numeration*. The *cipher*, though in itself of no value, thus plays an important part in our notation; by filling up what would otherwise be gaps between figures, it keeps them in their proper places, and preserves their local values; and by being put after a number, it has the effect of multiplying that number by 10, 100, &c., according as it is written once, twice, &c.

The *sign* for multiplication is \times placed between the *factors*, thus: (1.) $346 \times 7 = 2422$. (2.) $6047 \times 5 = 30235$. (3.) $246053 \times 6 = 1476318$. (4.) $53274 \times 800 = 42619200$. In working this fourth example, the plan is to consider 8 only as the multiplier, and to put the ciphers to the right of it, as in the margin, annexing them afterwards to the product by 8. (5.) $470329 \times 11 = 5173619$. (6.) $375842 \times 12 = 4510104$.

II. When the Multiplier is greater than 12.

RULE.—Place the multiplier under the multiplicand, units under units, tens under tens, &c.

Commencing with the units' figure, multiply by *each* in succession, and arrange the several rows of results, so that the first figure on the right in each row may be *directly under* the multiplying figure that produced it. Add up all these products, and the sum will be the complete product.

For example, if we have to multiply 426 by 34, we place the 34 under the 26, and proceed thus: 1 times 6 are 24; 4 and carry 2: 4 times 2 are 8, and 2 are 10; 0 and carry 1: 4 times 4 are 16, and 1 are 17. The first row is now completed, and we begin anew, with the next figure, 3, as multiplier, taking care to put the first figure we get in the new row directly under this 3. 3 times 6 are 18; 8 and carry 1: 3 times 2 are 6, and 1 are 7: 3 times 4 are 12. The rows are now completed, so that, drawing a line and adding up, we find the product to be 14484.

426
34
—
1704
1278
—
14484

You see from the local position of our second multiplier, 3, that it is in reality 30, and $426 \times 30 = 12780$: adding this product to the former product, that given by the 4, as in the margin, the whole product by 34 must necessarily be the result; and you see that it agrees with that above.

If our multiplier had been a number of *three* figures, as 534, then, to the *partial* products above, we must have added the product due to the 5; which, having regard to its local value, is 500; and if we retain the noughts, the whole operation would be as here annexed. And it is plain that we may always omit the noughts, provided we take care, as the rule directs, to put the first figure of each partial product directly under the multiplying figure, which supplies that product. It is worthy of notice, too, that the product will always be the same, whichever of the two numbers be regarded as the multiplier: you may easily satisfy yourself that 426 multiplied by 534, is the same as 534 multiplied by 426. To be convinced that this principle is perfectly general, you have only to assure yourself of the fact within the limits of the multiplication table, which you may do by replacing multiplication by addition, as shown in the first example, p. 11; that is, proving to yourself that 3 times 7 is the same as 7 times 3; that 5 times 8 is the same as 8 times 5, and so on, as the table declares: because, whatever be the two factors, the multiplication of one by the other is made up only of multiplications within the limits of the table. It is in general most convenient to take that for the multiplier which gives the fewer partial products, or rows of figures. (See the operations in the margin.) The learner may now exercise himself in the process, by showing that the following statements are true:—

	2647	
	356	2647
	15882	2492
	13235	1424
	7941	2136
	943332	712
		942332

(1.) $4214 \times 24 = 101136$. (2.) $698 \times 243 = 159894$.

(3.) $3264 \times 2300 = 7507200$. (4.) $15607 \times 3094 = 48288058$.

(5.) Show that $243 \times 616 = 9 \times 9 \times 11 \times 8 \times 7 \times 3$. (6.) Show that $2048 \times 1936 = 64 \times 121 \times 32 \times 16$.

When the multiplier consists of two figures, forming a number greater than 12, there are two partial products, or rows of figures, to add up; but, with a little address, the product may be written down at once, whenever the multiplier does not exceed 20. Suppose, for instance, it were 16, then, if we multiply by the 6, and, as we go on, add in not only what we *carry* from any figure of the multiplicand, but also the immediately *pre-*
ceding figure of the multiplicand, the complete product will be obtained in one line, as in the margin; the operation being carried on thus: 6 times 8 are 48; 8 and carry 4: 6 times 7 are 42 and 4 are 46 and 8 are 54; 4 and carry 5: 6 times 3 are 18 and 5 are 23 and 7 are 30; 0 and carry 3: 6 times 2 are 12 and 3 are 15 and 3 are 18: 8 and carry 1: 1 and 2 are 3. It will be advisable for the learner to practise this short way with the multipliers, 13, 14, 15, 16, 17, 18, 19. Multiplication, which is thus performed in one line, is called *short* multiplication; when there are more lines, it is *long* multiplication.

	2378	
	16	
	38048	
	2378	This is the same as
	14268	
	2378	
	38048	

Method of proving multiplication by casting out nines.

I shall here mention a useful method of trying whether the product of two numbers is correct; but I must postpone the explanation of the *principle* of the method till you arrive at *Algebra*. I can only mention here, that if any number be divided by 9, the remainder will be the same as would arise from

dividing the *sum* of the figures in that number by 9: for 10 is equal to *once* $9+1$; 100 is equal to 11 times $9+1$; 1000 to 111 times $9+1$; and so on: that is, the remainder arising from dividing 1, followed by any number of *noughts*, by 9, is always 1. Consequently the remainder arising from dividing 2, or 3, or 4, &c., followed by any number of *noughts*, is 2, or 3, or 4—the same as the figure preceding the *noughts*. It therefore follows, that whether we divide a number, such as 4326, which is of course $4000+300+20+6$, by 9, or simply divide $4+3+2+6$, that is 15—the sum of the figures—by 9, we must, in each case, get the same remainder. This property, taken in connexion with the principle referred to above, and to be proved in Algebra (see the multiplication of compound quantities in Algebra), suggests the following rule:—

RULE.—Add together the figures of the multiplicand, not counting any 9 that may occur, rejecting also 9, whenever, in adding up, the sum amounts to 9 or more: when all the figures are added, the result will therefore be less than 9: note this result. Proceed in like manner with the figures of the multiplier; noting the result. Multiply the two results together; retaining, as before, only what is left after the rejection of all the *nines* the new result contains. Do the same thing with the figures of the product; and compare this third result with that just found: if the two be the same, the work may be presumed to be correct; if they differ, it is certainly wrong.

The usual way of noting the four results is to make a cross, to put the first in the left hand opening; the second in the opposite opening; the third above, and the fourth below. If the upper and lower results are the same, the work is *most likely* correct, but otherwise it is wrong.

Let us proceed in this way to test the accuracy of the work at page 12. Commencing at the right of the multiplicand, we say 7 and 4 are 11, therefore rejecting 9, 2 and 6 are 8 and 2 are 10: the first result, therefore, rejecting 9 from this 10, is 1, which we place in the opening of the cross to the left. Taking now the multiplier, we say 6 and 5, 11; 2 and 3, 5, the second result, which we place opposite the former. The product of the two is 5, with no 9 to reject: this is the third result, to be placed above. Lastly, taking the product, we say 2 and 3 are 5 and 3 are 8 and 2 are 10: 1 and 4 are 5; which is the fourth result, and, as it agrees with the preceding, we conclude the work to be correct.



It is plain, however, that if any of the figures in the product were made to exchange places, the agreement of the third and fourth results would remain, though the product would be wrong; as would also be the case if one figure of it were increased and another diminished, by the same number: all, therefore, that we can safely infer, is, that the agreement spoken of *must* have place if the work be correct; so that if it fail the work is wrong. Suppose, for instance, that we had made $73084163 \times 7581 = 554270392192$: then, applying the test, we get, from the first factor, the result 5; from the second, the result 6; and from the product of these, the result 3: but, from the above-stated product of the two numbers, the result is 4: this product, therefore, is incorrect; and, upon revising the multiplication, we find that the 3, after the *nought*, should have been a 2.



Simple Division.—The operation by which we find how many times one number or quantity is contained in another number or quantity of the same kind, is called *division*. It is also the operation by which we find the 4th part, the 5th part, &c. of a number or quantity. The number or quantity divided is called the *dividend*; that by which we divide it, the *divisor*; and the result obtained, the *quotient*.

You must not fall into the common mistake of considering the quotient to express always *how many times* the dividend contains the divisor: the 4th part of a mere number tells us how many times that number contains 4; but the fourth part of a *quantity*—a sum of money, for instance—is just the fourth part, and nothing else:—it is itself also a sum of money. The division is called *simple* when the quantities concerned are of but one denomination; when you come to the division of *compound* quantities, you will find some further remarks on the true nature of division in general; at present both *dividend* and *divisor*, and therefore the *quotient*, are to be regarded as mere *numbers*.

I. When the Divisor is not greater than 12.

RULE.—Place the divisor to the *left* of the dividend, with a mark of separation, thus), between the two.

Draw a line beneath the dividend, and, by the multiplication table, find how many times the divisor is contained in the first figure of the dividend, or in the number expressed by the first *two* figures, or even in the number expressed by the first *three* figures, should the number given by the first, and even by the first two, be *smaller* than the divisor; and write the quotient under the line, taking care to observe what is *over*, as the divisor may be contained a certain number of times in the number expressed by the leading figure or figures, and leave something *over*.

Proceed to the next figure of the dividend; regard what was over, if anything, to be *prefixed* to it; and find how many times the divisor is contained in the number you thus get; putting the quotient down, and, as before, carrying what is over to the next figure of the dividend, to which you must regard it as *prefixed*. And in this way figure after figure of the complete quotient is to be found, till all the figures of the dividend have been used. Should there be anything over at the end, this is called the *remainder*: it is to be written beside the quotient figures, with the divisor placed under it, and a line of separation between them.

Suppose, for example, we have to divide 25602 by 3, then placing divi- 3)25602
 dend and divisor (3) as in the margin, we proceed thus:—3 is contained in 8534
 2, *no* times; so that nothing is to be placed under the 2: 3 is contained in 25, —————
 8 times and 1 over; 8 and carry 1: this 1, regarded as *prefixed* to the 6, 8534
 gives the number 16: we therefore say: 3 in 16, 5 times and 1 over: 3 in 10, 3 times
 and 1 over: 3 in 12, 4 times. Therefore, the quotient is 8534; and this is the *complete*
 quotient, as there is no *remainder*.

Again, suppose it were proposed to divide 7509223 by 5, we should 5)7509223
 say, 5 in 7, 1; and 2 over: 5 in 28, 5; and 3 over: 5 in 30, 6: 5 in 1500244
 4, 0: 5 in 19, 9; and 1 over: 5 in 12, 2; and 2 over: 5 in 23, 4; and 3
 over. As there is here a remainder 3, we annex it, with the divisor 1500244
 5 under it, to the figures of the quotient, and call 1500244 $\frac{3}{5}$ the *complete quotient*.

The principle upon which the foregoing operation depends is pretty evident: the leading figure in the dividend above is 7000000: the fifth part of this is 1000000 and 2000000 over: that is, with the local value of the next figure 8, 2000000; the fifth part of this is 500000, and 300000 besides; the fifth part of which is 60000: the fifth part of the 4000—the local value of the next figure—is 0 thousands, and 4000 over; this, with the local value of the 6, is 4600; of which the fifth part is 900, and 100 over; this, with the 20, is 120; the fifth part of which is 20, and 20 over; and lastly, the fifth part of the remaining 23 is 4, and 3 over; and, to imply that this 3 still remains to be divided, it is put down with the 5 underneath; because one number, placed in this way under another, is a form frequently used to denote that the *upper* number is to be divided by the *lower*. Hence the fifth part of the proposed number is 1500244, and the fifth part of 3 besides: this quotient being made up of the several parts which arise from taking a fifth of each of the above-mentioned component portions of the number.

The *sign* for division is \div , which stands for the words *divided by*: thus, $6 \div 2 = 3$ is a short way of stating that 6 divided by 2 is equal to 3. As noticed above, there is another way of indicating division, namely, by putting the dividend above and the divisor below, a short line separating the two: thus, $\frac{6}{2} = 3$ expresses the same thing as the notation above. The learner may exercise himself in the rule just explained by proving by it the truth of the following statements expressed in one or other of the forms of notation here adverted to:

- (1.) $2185095 \div 3 = 728365.$
 (2.) $2208184 \div 8 = 276023.$
 (3.) $47051112 \div 6 = 7841902.$
 (4.) $\frac{462508}{4} = 115627.$
 (5.) $\frac{837465}{6} = 139244\frac{1}{2}.$
 (6.) $\frac{13900424}{7} = 1985774\frac{6}{7}.$
 (7.) $\frac{2375920}{11} = 215992\frac{8}{11}.$
 (8.) $\frac{46285439}{12} = 3857119\frac{7}{12}.$
 (9.) $\frac{65283029}{10} = 6528302\frac{9}{10}.$

It is plain that division by 10 requires no work: the quotient is always the dividend itself, wanting the last figure, which is the *remainder*, and which, therefore, written as in this last example, with the divisor underneath, completes the quotient. In a similar way, to divide by 100 we have simply to cut off *two* figures from the dividend for remainder; to divide by 1000, to cut off *three* figures; and so on: thus,—

$$\frac{78516}{100} = 785\frac{16}{100}, \quad \frac{78516}{1000} = 78\frac{516}{1000}, \text{ \&c.}$$

All this is obvious, because

$$78516 = 78500 + 16 = 78500 \div 100 + 16, \text{ \&c.}$$

II. *When the Divisor is greater than 12.*

RULE.—Place the divisor to the left of the dividend as in the former case, and to the right mark off a place for the figures of the quotient.

Find how many times the *leading figure* of the divisor is contained in that of the dividend, or in the number expressed by the first *two* figures, if the leading figure of the dividend be smaller than that of the divisor; and put the figure expressing the number of times in the quotient's place.

Multiply the divisor by this first quotient-figure, and subtract the product from the number formed by the leading figures of the dividend, and to the remainder annex the next figure of the dividend. The number thus formed will be a new dividend, and the number of times it contains the divisor—to be found as before—will be the second quotient-figure, the product of which and the divisor, being subtracted from the new dividend, will give a second remainder, to which the *next* figure of the original dividend is to be joined, and the operation continued till all the figures of the dividend have been used.

An example worked at length will explain the operation better than any verbal rule.

Let it be required to divide 256438 by 346.

Placing the divisor on the left of the dividend, and marking off a place for the quotient on the right, we look at the leading figure of the divisor and also at that of the dividend, with the view of seeing whether the latter contains the former, which it does not, 3 being greater than 2: we therefore commence with the number 25, formed by the first *two* figures of the dividend, and seeing that 3 is contained in 25, 8 times, we should put 8 for the first quotient figure; but bearing in mind that, when the *whole* divisor is multiplied by this 8, we must attend to the *carryings*, we perceive that 8

$$\begin{array}{r} 346)256438 \quad (741 \\ \underline{2422} \\ 1423 \\ \underline{1384} \\ 398 \\ \underline{346} \\ 52 \end{array}$$

is too great, we therefore try 7, and find 7 times 346 to be 2422, a number less than 2564 above it, so that we can obey the direction of the rule and subtract: the remainder is 142, which, when the next figure of the dividend is brought down, becomes 1423. We now take this as a dividend; and, looking only at leading figures in this new dividend and in the divisor, we see that the latter will go, as it is called, 4 times; we therefore put 4 for the second quotient-figure; and multiplying and subtracting, we get 36 for the second remainder; and, by bringing down another figure, 398 for a new dividend: the divisor goes into this once; so that the quotient is 741, and the final remainder 52: this remainder, as in the former case, must be annexed, with the divisor underneath, to the quotient-figures; so that the complete quotient is $741\frac{52}{346}$, which is the 346th part of 256438. Of the truth of this you may convince yourself by observing that 256438 has been cut up into portions, and the 346th part of each portion found; for the work above is nothing else but that here annexed, with useless repetitions suppressed. According to this arrangement it is at once seen that 700 is the 346th part of 242200, that 40 is the 346th part of 13840, and that 1 is the 346th part of 346, and that of 52, the 346th part, still remains to be taken. Now, $242200 + 13840 + 346 + 52 = 256438$; consequently 741, together with $\frac{52}{346}$, is the 346th part of the number proposed.

It must be noticed that if any dividend, formed by a remainder and a figure brought down, should be less than the divisor, that the divisor will go no times in that dividend; so that a 0 will be the corresponding quotient-figure; and that then a second figure must be brought down, as in the operation here annexed; where the complete quotient is $102\frac{11}{346}$.

There is another thing also to be attended to. Sometimes the divisor ends with zeros or noughts: when such is the case, the best way is to cut the ciphers off, and entirely to disregard them in the division, cutting off, however, at the same time, as many figures from the end of the dividend, which latter figures help to form the final remainder: you will see by operating on the same example first with the ciphers retained, and then with the ciphers dismissed, that nothing is omitted but useless ciphers: the complete quotient being, by either way, $61\frac{138}{346}$. In thus completing the quotient, by means of the final remainder, you must, of course, take care to restore the ciphers that were temporarily cut off from the divisor: in some books on arithmetic this has been forgotten. The following examples are submitted for practice:—

- (1.) $\frac{13801}{47} = 293.$
- (2.) $\frac{159694}{658} = 243.$
- (3.) $\frac{278648}{35} = 7961\frac{18}{35}.$
- (4.) $\frac{780967}{3700} = 211\frac{1517}{3700}.$
- (5.) $\frac{38326896}{1342} = 27069\frac{128}{1342}.$
- (6.) $\frac{3939028647}{8889} = 57727\frac{128}{8889}.$

346)256438(700	
242200	
346) 14238(40	
13840	
346) 398(1	
346	
52	
472)48165(102	
472	
965	
944	
21	
2700)164826(61	
16200	
2826	
2700	
Rem. 126	
27,00)1648,26(61	
162	
26	
27	
Rem. 126	

To prove whether the quotient, in any case, is correct, you have only to multiply it

and the divisor together: the product will be the dividend, if the operation is correct, as in division; for the object of division is to find a number such, that that number of times the divisor shall make the dividend. In thus proving division; if there be a remainder, you add this remainder to the product of the divisor and quotient-figures. For example: to prove whether the work at page 18 is correct, we multiply and add as in the margin; and as the result is the same as the dividend, we may be sure that the quotient is right.

473
192
—
944
473
21 Rem.
—
48136

III. When the Divisor is composed of Factors, none of which exceeds 12.

The operation just explained is called *long division*, to distinguish it from the shorter process of the preceding case, where the divisor is not greater than 12. If any divisor be found to be the product of factors, each of which does not exceed this limit, the division may be performed by successive applications of the shorter rule: for you may divide first by one factor, then the quotient by another factor, the new quotient by a third factor; and so on, till all the factors have been used.

It is possible that the division by the first factor may leave a remainder; if so, it must, of course, be preserved: the division by the second factor may also leave a remainder; if so, you must multiply it by the first divisor, and add in the former remainder; the result will be the complete remainder as far as the operation has been carried: if there be a third division, and a third remainder, you must multiply it by both the first and second divisors, adding in the former complete remainder: and so on, till all the divisions are completed. For example, suppose we have to divide 38214 by 63: then since $63 = 7 \times 9$, we may operate as in the margin: the final quotient being 606 $\frac{2}{3}$. In like manner, if we have to divide 24611 by 126; then, since $126 = 3 \times 6 \times 7$, the operation, by short division, is that here annexed: the remainder from the first division is 2; that from the second is 1; and this 1, multiplied by the first divisor 3, and the former remainder being taken in, gives 5 for the complete second remainder: the remainder from the third division is 2, which multiplied by 3, and by 6, both the former divisors, that is by 18, gives 36; which, with the preceding remainder 5, makes 41;—the final complete remainder: hence the complete quotient is 195 $\frac{1}{3}$.

7) 38214
—
9) 5499...1
—
606...26rem.
3) 24611
—
6) 8203...2
—
7) 1367...5
—
195...41rem.

The method here described of obtaining the final remainder, and thence completing the final quotient, cannot be clearly explained till some knowledge of *fractions* is acquired: parts of a whole, as one-half, one-third, two-fifths, &c., and which are denoted by $\frac{1}{2}$, $\frac{1}{3}$, $\frac{2}{5}$, &c., are called *fractions*: when you are a little acquainted with the management of these, you will plainly see the reason of the foregoing directions.

Upon the principles now delivered depend all the operations of arithmetic. In what has preceded, they have been applied only to what are called *abstract numbers*, without any reference to particular objects or articles. It remains to show the application of the same principles to *concrete quantities*; that is, to real commodities, or things—as to money, weight, measure, &c. And, in order to this, a few *Tables* connected with these matters must be given.

is too great, we therefore try 7, and find 7 times 346 to be 2422, a number *less* than 2564 above it, so that we can obey the direction of the rule and *subtract*: the remainder is 142, which, when the next figure of the dividend is brought down, becomes 1423. We now take *this* as a dividend; and, looking only at *leading figures* in this new dividend and in the divisor, we see that the latter *will go*, as it is called, 4 times; we therefore put 4 for the second quotient-figure; and multiplying and subtracting, we get 39 for the second remainder; and, by bringing down another figure, 398 for a new dividend: the divisor goes into this *once*; so that the quotient is 741, and the final remainder 52: this remainder, as in the former case, must be annexed, with the divisor underneath, to the quotient-figures; so that the complete quotient is $741\frac{52}{346}$, which is the 346th part of 256438. Of the truth of this you may convince yourself by observing that 256438 has been cut up into portions, and the 346th part of each portion found; for the work above is nothing else but that here annexed, with useless repetitions suppressed. According to this arrangement it is at once seen that 700 is the 346th part of 242200, that 40 is the 346th part of 13840, and that 1 is the 346th part of 346, and that of 52, the 346th part, still remains to be taken. Now, $242200 + 13840 + 346 + 52 = 256438$; consequently 741, together with $\frac{52}{346}$, is the 346th part of the number proposed.

It must be noticed that if any *dividend*, formed by a remainder and a figure brought down, should be *less* than the divisor, that the divisor will go *no times* in that dividend; so that a 0 will be the corresponding quotient-figure; and that then a *second* figure must be brought down, as in the operation here annexed; where the complete quotient is $102\frac{47}{346}$.

There is another thing also to be attended to. Sometimes the divisor ends with zeros or noughts: when such is the case, the best way is to cut the ciphers off, and entirely to disregard them in the division, cutting off, however, at the same time, as many figures from the end of the dividend, which latter figures help to form the final remainder: you will see by operating on the same example first with the ciphers retained, and then with the ciphers dismissed, that nothing is omitted but useless ciphers: the complete quotient being, by either way, $61\frac{135}{3700}$. In thus completing the quotient, by means of the final remainder, you must, of course, take care to restore the ciphers that were temporarily cut off from the divisor: in some books on arithmetic this has been forgotten. The following examples are subjoined for practice:—

$$(1.) \frac{13801}{47} = 283.$$

$$(2.) 159894 \div 658 = 243.$$

$$(3.) \frac{278643}{35} = 7961\frac{3}{5}.$$

$$(4.) 780967 \div 3700 = 211\frac{367}{3700}.$$

$$(5.) \frac{36326599}{1342} = 27069\frac{1349}{1342}.$$

$$(6.) 8939040647 \div 6889 = 571787\frac{879}{6889}.$$

$$346)256438(700$$

$$\underline{242200}$$

$$346) 14238(40$$

$$\underline{13840}$$

$$346) 398(1$$

$$\underline{346}$$

52

$$472) 48165(102$$

$$\underline{472}$$

$$965$$

$$\underline{944}$$

21

$$2700)164826(61$$

$$\underline{16200}$$

$$2826$$

$$\underline{2700}$$

Rem. 126

$$27,00)1648,26(61$$

$$\underline{162}$$

$$28$$

$$\underline{27}$$

Rem. 126

To *prove* whether the quotient, in any case, is correct, you have only to multiply it

and the divisor together: the product will be the dividend, if the operation is correct, as is obvious; for the object of division is to find a number such, that that number of times the divisor shall make the dividend. In thus proving division, if there be a *remainder*, you add this remainder to the product of the divisor and quotient-figures. For example: to prove whether the work at page 16 is correct, we multiply and add as in the margin; and as the result is the same as the dividend, we may be sure that the quotient is right.

$$\begin{array}{r}
 472 \\
 102 \\
 \hline
 944 \\
 472 \\
 \hline
 21 \text{ Rem.} \\
 \hline
 48165
 \end{array}$$

III. When the Divisor is composed of Factors, none of which exceeds 12.

The operation just explained is called *long* division, to distinguish it from the shorter process of the preceding case, where the divisor is not greater than 12. If any divisor be found to be the product of factors, each of which does not exceed this limit, the division may be performed by successive applications of the shorter rule: for you may divide first by one factor, then the quotient by another factor, the new quotient by a third factor; and so on, till all the factors have been used.

It is possible that the division by the first factor may leave a remainder; if so, it must, of course, be preserved: the division by the second factor may also leave a remainder; if so, you must multiply it by the *first* divisor, and add in the former remainder; the result will be the complete remainder as far as the operation has been carried: if there be a third division, and a third remainder, you must multiply it by both the *first and second* divisors, adding in the former complete remainder: and so on, till all the divisions are completed. For example, suppose we have to divide 38214 by 63: then since $63 = 7 \times 9$, we may operate as in the margin: the final quotient being $606\frac{2}{3}$. In like manner, if we have to divide 24611 by 126; then, since $126 = 3 \times 6 \times 7$, the operation, by short division, is that here annexed: the remainder from the first division is 2; that from the second is 1; and this 1, multiplied by the first divisor 3, and the former remainder being taken in, gives 5 for the complete second remainder: the remainder from the third division is 2, which multiplied by 3, and by 6, *both* the former divisors, that is by 18, gives 36; which, with the preceding remainder 5, makes 41;—the final complete remainder: hence the complete quotient is $195\frac{41}{126}$.

$$\begin{array}{r}
 7) 38214 \\
 \hline
 9) 5459...1 \\
 \hline
 606...36\text{rem.} \\
 3) 24611 \\
 \hline
 6) 8203...2 \\
 \hline
 7) 1367...5 \\
 \hline
 195...41\text{rem.}
 \end{array}$$

The method here described of obtaining the final remainder, and thence completing the final quotient, cannot be clearly explained till some knowledge of *fractions* is acquired: parts of a whole, as one-half, one-third, two-fifths, &c., and which are denoted by $\frac{1}{2}$, $\frac{1}{3}$, $\frac{2}{5}$, &c., are called *fractions*: when you are a little acquainted with the management of these, you will plainly see the reason of the foregoing directions.

Upon the principles now delivered depend all the operations of arithmetic. In what has preceded, they have been applied only to what are called *abstract* numbers, without any reference to particular objects or articles. It remains to show the application of the same principles to *concrete* quantities; that is, to real commodities, or things—as to money, weights, measures, &c. And, in order to this, a few *Tables* connected with these matters must first be given.

TABLES OF MONEY, TIME, WEIGHTS, AND MEASURES.

I.—MONEY.

Gold Coins.

Name.	Value. s. d.	Weight troy. dwt. gr.*
Sovereign (<i>one pound</i>)	20 0	5 3 11
Half-sovereign	10 0	2 13 11
Guinea †	21 0	5 9
Half-guinea	10 6	2 16 11

Silver Coins.

	Value. s. d.	Weight troy. dwt. gr.
Crown	5 0	18 4 11
Half-crown	2 6	9 2 11
Shilling	0 12	8 15 11
Sixpence	0 6	1 19 11
Fourpenny-piece	0 4	1 5 11
Threepenny-piece	0 3	21 11

Pence Table.

	s. d.		s. d.		s. d.
4 farthings make	0 1	50 pence make	4 2	100 pence make	8 4
12 pence "	1 0	60 " "	5 0	108 " "	9 0
20 " "	1 8	70 " "	5 10	110 " "	9 2
24 " "	2 0	72 " "	6 0	120 " "	10 0
30 " "	2 6	80 " "	6 8	130 " "	10 10
36 " "	3 0	84 " "	7 0	132 " "	11 0
40 " "	3 4	90 " "	7 6	140 " "	11 8
48 " "	4 0	96 " "	8 0	144 " "	12 0

A farthing,—that is, *one-fourth* of a penny,—is represented thus, $\frac{1}{4}d.$; a halfpenny, thus, $\frac{1}{2}d.$; and three farthings, thus, $\frac{3}{4}d.$ To express a fraction of a farthing, the letter *f* is put against the fraction: thus, $\frac{1}{2}f.$ means half a farthing; $\frac{3}{5}f.$ three-fifths of a farthing, &c.

II.—TIME.

60 seconds	make 1 minute.
60 minutes	" 1 hour.
24 hours	" 1 day.
7 days	" 1 week.
52 weeks 1 day, or 365 days	" 1 year.
366 days	" 1 leap year.

III.—AVOIRDUPOIS WEIGHT.

16 drams (<i>dr.</i>)	make 1 ounce.
16 ounces (<i>oz.</i>)	" 1 pound.
28 pounds (<i>lb.</i>)	" 1 quarter.
4 quarters (<i>qr.</i>), or 112lb.	" 1 hundredwt.
20 hundredweight (<i>cwt.</i>)	" 1 ton.

IV.—TROY WEIGHT.

24 grains (<i>gr.</i>)	make 1 pennywt.
20 pennyweights (<i>dwt.</i>)	" 1 ounce.
12 ounces (<i>oz.</i>)	" 1 pound.

V.—APOTHECARIES' WEIGHT.

20 grains (<i>gr.</i>)	make 1 scruple.
3 scruples (\mathcal{R})	" 1 dram.
8 drams (\mathcal{D})	" 1 ounce.
12 ounces (<i>oz.</i> , or \mathcal{L})	" 1 pound.

VI.—MEASURES OF LENGTH, OR LONG MEASURE.

12 inches	make 1 foot.
3 feet	" 1 yard.
6 feet	" 1 fathom.
5½ yards	" 1 rod, pole, or perch.
4 perches, or 100 links	" 1 chain (22 yards).
40 poles	" 1 furlong.
8 furlongs	" 1 mile.
3 miles	" 1 league.

Cloth.

2½ inches	make 1 nail.
4 nails	" 1 qr. of a yard.
5 quarters	" 1 English ell.
3 quarters	" 1 Flemish ell.

* The mark *dwt.* stands for *pennyweights*, and *gr.* for *grains*: see the table of Troy weight. The learner can scarcely require to be informed that \mathcal{L} stands for *pounds*, *s.* for *shillings*, and *d.* for *pence*.

† The *coin* guinea has been long abolished, but the *name* is still retained for 21s. The *name pound* is given to 20s., because the quantity of silver in this sum originally weighed a pound troy.

VII.—MEASURES OF SURFACE, OR SQUARE MEASURE.

144 square inches	make 1 square foot.
9 square feet	” 1 square yard.
80½ square yards	” 1 square rod, pole, or perch.
40 square perches	” 1 rood.
4 roods, or 160 square perches	” 1 acre.
10 square chains, or 100,000 sq. links	” 1 acre.
640 acres	” 1 square mile.
100 square feet	” 1 square of flooring.
272½ square feet	” 1 square rod of brick work.

VIII.—MEASURES OF SOLIDS, OR CUBIC MEASURE.*

1728 cubic inches	make 1 cubic foot.
27 cubic feet	” 1 cubic yard.

IX.—MEASURES FOR LIQUID AND DRY GOODS.

4 gills	make 1 pint.	4 pecks	make 1 bushel.
2 pints	” 1 quart.	8 bushels	” 1 quarter.
4 quarts	” 1 gallon.	2 cwt. of coals	” 1 sack.
2 gallons	” 1 peck.	10 sacks	” 1 ton.

*. It may be well to notice here, that the *avoirdupois* pound contains 7,000 grains, of which 5,760 make a pound *troy*; so that 144 pounds *avoirdupois* are equal to 175 pounds *troy*. The ounce *troy* exceeds the ounce *avoirdupois* by 42½ grains. The gallon contains 10 pounds *avoirdupois* of distilled water, and its solid measure is 277 cubic inches and 274 thousandths of an inch.

Reduction.—Arithmetic is now to be applied to *concrete* quantities, such as those named in the foregoing tables: hitherto its operations have been confined to *abstract* numbers. The name *reduction* is given to the methods by which quantities are changed to others of the same values but of different denominations; as, for instance, the changing, or *reducing*, pounds to shillings, pence, to farthings, yards to miles, minutes, hours, &c. to years,—and so on. There are two rules for such reductions: the one applying when the quantity is to be converted from a higher to a lower denomination,—as, for instance, from pounds to pence; and the other applying when the change is to be from a lower denomination to a higher, as from pence to pounds

I. To reduce a Quantity to one of Lower Denomination.

RULE.—From the table see how many of the *next* lower denomination make 1 of the higher; multiply by this *number*: the product will be the number of quantities of the next lower denomination. If any of the lower denomination be connected with the proposed quantity, the number of those must be added in with the product.

Suppose, for example, we have to reduce £136 8s. 4½d. to pence. Then, as 20s. make £1, we multiply the number 136 by the number 20, adding in the number 8: the product is 2728, the number of shillings. Again, since 12 pence make 1s., we multiply this last number by 12, taking in the 4: the product is 32740, the number of pence. And lastly, multiplying this by 4, because 4 farthings make 1d., and taking in the 3, the number of farthings, we get 130963 for the number of farthings required.

£	s.	d.	
136	8	4½	
	20		
<hr/>			
2728	numb. of shillings.		
12			
<hr/>			
32740	numb. of pence.		
4			
<hr/>			
130963	numb. of farthgs.		

* A *cube* is a solid of six equal square faces, like a common die. If the *edge* of this figure be 1 inch, the solid is a *cubic* inch, while each face is a *square* inch. In a similar solid, of which the edge is 1 foot, there are 1728 of the smaller cubes, or cubic inches.

You perceive here that, although we have been dealing with *concrete* quantities, yet, after all, our operations are performed entirely with *abstract* numbers. We do not multiply £136 by 20, because we should then get £2728 for the product; much less do we multiply by 20 *shillings* (as some books direct us to do), for to attempt to multiply by *shillings* is to attempt an absurdity: "20 shillings times 136 pounds," is a mode of expression as ridiculous as it is meaningless.

As a second example, let it be required to reduce 217 days 14 hours and 36 minutes to minutes. Since 24 hours make one day, we multiply the number
 d. h. m. 217 by 24; and in adding in the 14, we include the *units* in the units' amount of the product,—that is, in the first result of the first partial product,—and the *tens* (1) in the first result of the second partial product. We thus get 5222, the number of hours; this number we multiply by 60, because 60 minutes make 1 hour, and we add in the 36,—units with units, and tens with tens, as before. and we thus find the number of minutes to be 313356.

Sometimes we have to multiply by a *fraction*, as, for instance, when perches of *length* are to be reduced to yards; for you see by the table that $5\frac{1}{2}$ yards make 1 perch: also, in reducing *square perches* to *square yards*, we have to multiply by $30\frac{1}{4}$, the number of square yards in 1 square perch. Now, to multiply by $\frac{1}{2}$ means simply to take *half* the multiplicand, that is, to divide it by 2; and to multiply by $\frac{1}{4}$, means to take a *fourth part*, or to divide the multiplicand by 4. This is certainly a departure from the primitive meaning of the word *multiply*; but it is sanctioned by common practice. It is customary to speak of two-and-a-half times this, or three-and-a-quarter times that; and so on: thus, two-and-a-half times 4 we know to mean 10; and two-and-a-quarter times, 9. The way to introduce such fractional parts in the arithmetical operation will be sufficiently seen from the two examples worked in the margin; the first being to reduce 248 *linear perches* to *linear yards*, and the second to reduce 248 *square perches* to *square yards*. If the number of perches had been 249, the multiplier $\frac{1}{2}$ would have given $124\frac{1}{2}$, and the multiplier $\frac{1}{4}$, $62\frac{1}{4}$. By aid of the tables, which ought, indeed, to be committed to memory, you will easily be able to show the truth of the following statements, namely:—

- | | |
|--|---|
| (1.) 13s. 4d. = 160d. | (2.) £32 1s. 6d. = 7698d. |
| (3.) £5 12s. 4½d. = 4914 farthings. | (4.) 27 cwt. 2 qr. 22 lb. = 3102 lb. |
| (5.) 17 lb. 6 oz. 14 dwt. troy = 4214 dwt. | (6.) 131 mls. 3 fur. 10 per. 8 yds. = 231278 yds. |
| (7.) 29 days 3 hours 21 min. = 41961 min. | (8.) 37 acres 3 roods 12 perches = 183078 yds. |
| (9.) 289½ gals. = 7664 gills. | (10.) 327 square perches = 9891¼ sq. yards. |
| (11.) 263 tons 18 cwt. 3 qr. 21 lb. = 591211 lb. | |

To reduce a Quantity to one of Higher Denomination.

RULE.—Find by the table how many of the given denomination make 1 of the next higher, and divide by this number; the quotient will express how many of the next higher denomination are in the proposed quantity. In like manner, divide by the

Linear perches.	2) 248
	5½
	1240
	124 for ½.
	1364 yards.
Square perches.	4) 248
	30¼
	7440
	62 for ¼.
	7502 sq. yds.

number expressing how many of the new denomination make 1 of the next higher to it; and so on, till the required denomination is reached. Suppose, for instance, we had to find how many pounds there were in 2640397 farthings. Dividing the number of farthings by 4, we get the number of pence—namely, 660099, and one farthing over. Dividing the number of pence by 12, we get the number of shillings—namely, 55008, and three pence over; and lastly, dividing by 20, we get the number of pounds—namely, 2750, and 8s. over. Consequently, in the proposed number of farthings, there are £2750 8s. 3½d.

4) 2640397
 12) 660099...½d.
 20) 55008...3d.
 £2750 8s. 3½d.

Again: let it be required to convert 591241 lb. into tons, cwt., &c. As 28 lb. make 1 qr., the next higher denomination to pounds, we divide first by 28, or by 7 and by 4, the two factors of 28, as it is better to use *short* division: we thus get 21115, the number of quarters, with 21 lb. over. This number, divided by 4, gives the number of cwt.—namely, 5278 and 3 qrs. over: and lastly, dividing by 20, the number of cwt. in 1 ton, we get finally 263, the number of tons: so that there are 263 tons 8 cwt. 3 qr. 21 lb. in 591241 lb.

7) 591241
 4) 84463
 4) 21115...21 lb.
 20) 5278...3 qrs.
 263 t. 8cwt. 3 qr. 21 lb.

All this is so easy and obvious that I am sure I need not occupy space with any more worked-out examples. I shall merely give one cautionary direction—it is this: that when you have to *divide* by 5½, bring both this divisor and the dividend into *halves*; that is, double both; making the divisor 11, instead of 5½; but remember that the *remainder* will be so many *halves*. In like manner, when you have to divide by 30½, bring all into *quarters*; that is, divide 4 times the dividend by 121, which is 4 times 30½; remembering, however, that the *remainder* will be *quarters*; so that a fourth part of the number, which is the remainder, will be the number of *wholes*. See the operation in the margin, where the factors of 121, viz., 11, 11, are used to get the quotient by short division. This quotient shows that there are 81 square perches, and 51 *quarter-yards* over; that is, 12½ square yards: the result would therefore be written, 81 square perches, 12½ square yards.

Square yards.
 2465
 4
 11) 9852
 11) 895...7
 81...51

The examples given at page 20 may be employed for exercise in this rule, by taking in each the quantity on the right of the sign of equality, and converting it into that on the left; but two or three others are added here:—

- (1.) 28635 seconds=7 h. 57m. 15 sec. (2.) 10085760 gr.=1751 lb. troy.
 (3.) 638600 inches=10 miles. (4.) 397024 yds.=225 mi. 4 fur. 26 per. 1 yd.
 (5.) 91476 sq. ft.=2 ac. 0 rds. 16 per. (6.) 100000 cubic in.=2 cub. yds. 3 ft. 1504 in.

The four fundamental operations of arithmetic may now be applied, in order, to *compound* quantities; that is, to concrete quantities, of several denominations.

Addition of Compound Quantities.—To add together a set of concrete quantities of different denominations, the rule is as follows:—

RULE.—Arrange the quantities to be added one under another, so that all in the same vertical column may be of the same denomination.

Add up the quantities of *lowest* denomination: find how many of the next denomination are contained in the sum: put the *remainder* under the column, and carry the quotient to the next column.

Proceed in this way, from column to column, till all have been added up.

The principle of this rule is too obvious to require any explanation ; the carryings merely transfer the quantities of advanced denominations to the columns in which those denominations are arranged, just as in the addition of abstract numbers.

Thus the sums of money in the margin are arranged so that the denomination *farthings* forms one column, the denomination *pence* the next, *shillings* the next, and *pounds* the next. The sum of the *farthings*' column is 10 farthings, in which are contained 2 pence, and there are 2 farthings, or $\frac{1}{2}$ over; this $\frac{1}{2}$ is therefore put down, and the 2 pence carried to the pence column; the sum of this column is 30 pence, that is, 2s. 6d.: the 6d. is put down, and the 2s. carried to the shillings' column, the sum of which is 54s., that is, £2 14s.; we therefore say 14, and carry 2; and this 2 added in with the pounds' column, makes the amount of that column £85; therefore the sum of the whole is £85 14s. 6 $\frac{1}{2}$ d.

It may be noticed that in adding up the shillings' column of an account, the best way is to disregard the *ten* in that column till all the *units* have been added; then, having reached the top unit-figure, to proceed downwards taking in every *ten* that appears. Thus, in the present example, the sum of units' column of shillings is 24; so that, proceeding downwards, taking in each *ten* as we meet with it, we say 34, 44, 54; so that the sum is 54s., or £2 14s.

Two other examples are here annexed; the one in *avoirdupois weight*, and the other in *Time*. In the former the sum of the drams is found to be 56 dr.; by reduction, we find that in these drams there are 3 oz. 8 dr., we therefore put down 8 dr. and carry the 3 oz. to the next column, which gives 46 oz., or 2 lb. 14 oz.; writing down the 14 oz., and carrying the 2 lb. to the column of lbs., we get 41 lb. for the sum of this column: therefore the whole sum is 41 lb. 14 oz. 8 dr.

In the next example the column of seconds amounts to 110 seconds, that is, to 1 minute 50 seconds: the 50 seconds is put down, and the 1 minute carried to the next column, the amount of which is 79 minutes, that is, 1 hour 19 minutes, 19 and carry 1: the hour column amounts to 83 hours, or 3 days 11 hours; 11 and carry 3 to the day's column, the amount of which is 119: therefore the whole amount is 119 days, 11 hours, 19 minutes, 50 seconds.

Subtraction of Compound Quantities.—The subtraction of concrete quantities, of different denominations, is effected by the following rule:

RULE.—Place the less of the two quantities under the greater, arranging the denominations as in addition.

Commence with the *lowest* denomination, and subtract, if the upper number be sufficiently great; if not, increase it by as many as will make 1 of the *next* denomination, and then subtract, taking care afterwards to carry 1, as in subtraction of abstract numbers: and proceed in like manner with each denomination till the subtraction is finished.

In this way the difference between £124 16s. 9 $\frac{1}{2}$ d. and £75 19s. 3 $\frac{1}{2}$ d. is found, as in the margin. Since 3 farthings cannot be taken from 2 farthings, we increase the 2 farthings by 4 farthings, or 1d., and say 3 from 6 and 3 remain, that is, $\frac{1}{2}$ d.: carry 1: 4 from 9 and 5 remain: 19 from 36

£	s.	d.
17	9	3 $\frac{1}{2}$
42	13	4 $\frac{1}{2}$
16	10	2 $\frac{1}{2}$
7	2	9 $\frac{1}{2}$
1	18	10 $\frac{1}{2}$

85	14	6 $\frac{1}{2}$
----	----	-----------------

lb.	oz.	dr.
8	13	11
9	10	13
4	6	9
11	11	16
7	3	8

d.	h.	m.	s.
34	13	9	15
18	9	0	37
27	21	11	19
14	18	23	4
10	7	14	16
13	14	21	19

119	11	19	50
-----	----	----	----

£	s.	d.
124	16	9 $\frac{1}{2}$
75	19	3 $\frac{1}{2}$
48	17	5 $\frac{1}{2}$

(increasing the 16s. by 20s.*) and 17 remain; carry 1 : 6 from 14 and 8 remain; carry 1 : 8 from 12 and 4 remain: therefore the difference is £48 17s. 5½d.

Again, suppose we have to subtract 24 miles, 6 furlongs, 21 perches, 2 yards from 43 miles, 1 perch, 1 yard. Then, having placed the quantities as in the margin, and seeing that the 1 yard is too small, we increase it by 1 perch, that is by 5½ yards, and subtract 2 yards from 6½ yards, we thus get the remainder 4½ yards; and carry 1 : and as 40 perches make 1 furlong, we subtract 22 from 41, and get 19 for remainder: carrying 1 to the 6 we subtract 7 from 8—the furlongs in 1 mile—and get 1 for remainder: and carrying 1 to the 4, it merely remains to subtract 25 from 43: the complete remainder is therefore 18 miles, 1 furlong, 19 perches, 4½ yards.

If the complete remainder in an operation of this kind be added to the compound quantity immediately above it, that is to the subtractive quantity, the sum will be equal to the upper row, that is, to the quantity which has been diminished: so that we may prove in this way the correctness of the subtraction. The following examples, if thus worked and proved, will afford exercise both in subtraction and addition:—

- (1.) Subtract £374 11s. 8½d. from £920 17s. 7½d.
- (2.) Subtract £173 9s. 4¾d. from £200.
- (3.) Subtract 8 lb. 4 oz. 23 gr. from 23 lb. 11 oz. 21 gr.
- (4.) Subtract 342 mls. 6 fur. 4 per. 4 yds. from 687 mls. 3 fur. 1 per.
- (5.) Subtract 324 gallons 2 quarts 1 pint from 570 gallons 1 quart.
- (6.) Subtract 3 roods 7 perches 23 yards from 2½ acres.
- (7.) Subtract 121 sq. yds. 7 ft. 132 in. from 237 sq. yds. 3 ft. 101 in.
- (8.) Subtract 18 c. yds. 37 ft. 211 in. from 47 c. yds. 13 ft. 73 in.

Multiplication of Compound Quantities.—From the nature of multiplication, it is plain that a concrete quantity can be multiplied only by an abstract number; indeed, whatever be the multiplicand, the multiplier, which simply denotes how many times the former is to be taken, must necessarily be a mere number. Strange to say, however, books on arithmetic, of the most recent date, are to be found, in which the multiplication together of concrete quantities is insisted upon, and pretended to be taught. People have disputed over and over again about the product of £19 19s. 11¾d., multiplied by itself! They might as well have disputed about the multiplication of Cheapside by Lombard Street; or, as Mr. Walker pithily expresses it, about multiplying “5lbs. of beef by 3 bars of music.”† This last operation, palpably absurd as the thing is, the arithmeticians referred to would not for a moment hesitate to undertake, provided the beef and music occurred in a rule-of-three question, as indeed they very well might; for they refer to the rule-of-three in justification of such a process.‡ Is it not ridiculous to appeal to a rule instead of to reason and common sense, in a subject which professes

* Instead of thus increasing the upper term by the unit of next higher denomination, the learner will find it a little easier to subtract at once from this unit, expressed in the lower denomination, and to add the remainder to the term above: thus we may say, 19 from 20, 1; and 16 make 17.

† “Philosophy of Arithmetic,” p. 58.

‡ Paganini was a very wonderful performer on the violin. Many people would have given a good deal of beef for a few bars of his music. Suppose, in time of need, he had exchanged 11 bars for 5lb., how many lb. might have been exchanged, at the same rate, for 3 bars? This is a rule-of-three question, and there are plenty of books (Walkingame, for instance) that would direct the following stating:—

Bars of music	lb. of beef.	bars of music.	lb. of beef.
11	5	3	1½
:	:	:	:
1	14	11	7½

And to get this 1 4-11 lb. of beef, they would direct the beef and the music, in the second and third terms, to be multiplied together! The author of this, when learning arithmetic (?), would have preferred to incorporate the beef and music, without the slightest compunction.

to be founded on rational principles, and supported by demonstration? I wish to warn you earnestly against this: receive no rule in any department of mathematics, the truth of which is not evident to your own understanding; and, therefore, in strict accordance with common sense. Multiplication is merely a short way of doing addition, and addition may always replace it: you have only to write the multiplicand down the proposed number of times, and to add all up. The *sum* is what in multiplication is called the *product*; but how could a sum of money be written down £19 19s. 11 $\frac{1}{2}$ d. *times*? Even in common reduction, similar absurdities are to be met with in the books. If you wish to convert pounds into shillings, you are told to multiply the *pounds* by 20, and sometimes, which is worse, to multiply them by 20s. But if you multiply pounds by 20, you get—not shillings—but 20 times as many *pounds*, as is obvious: what you really do, is to multiply the *number* denoting *how many* pounds by 20; because there must be 20 times that *number* of shillings.

The following is the rule for multiplying a compound quantity by a number:—

RULE I.—*When the Multiplier is not greater than 12.*

Put the multiplier under the quantity of least denomination: multiply that quantity by it, and divide the product by the *number* that expresses how many of such quantities make 1 of the next denomination: put down the *remainder*, and carry the quotient to the product arising from the multiplication of the next term,—and so on till all the terms have been multiplied.

When the multiplier is greater than 12, and is yet such as to admit of being formed from factors, multiply by each factor in succession, as in short multiplication.

The table of factors at the end will be found very useful in enabling us to tell at a glance whether any number not exceeding 100,000, can be decomposed into factors, within the limits of the multiplication table; and if so, what the factors are.

Multiply £23 14s. 7 $\frac{1}{2}$ d. by 7. Putting the multiplier 7 under the farthings, and multiplying them by the 7, the product is 21 farthings; and dividing 21 by 4, the number of farthings in a penny, we get 5 and 1 over; so that in 21 farthings there are 5 pence and 1 farthing: we put down the one under *farthings*, and carry the 5 pence to the 49, the pence product; which gives 54 pence, or 4s. 6d: we put down the 6d., and carry the 4 to the shillings' product, and thus get 102 shillings, or £5 2s.; and

putting down the 2s., we carry the 5 to the pounds' product. The complete product is thus £166 2s. 6 $\frac{1}{2}$ d.

Suppose the multiplier had been 105, then, seeing by the table that $105 = 7 \times 5 \times 3$; after the multiplication by 7, as above, we should have again multiplied by 5, and then by 3, as in the margin; from which we see that 105 times £23 14s. 7 $\frac{1}{2}$ d. is £2491 17s. 9 $\frac{1}{2}$ d.

RULE II.—*When the Multiplier exceeds 12, and is not divisible into factors, each less than 13.*

Take that number in the table which is *nearest* to the proposed multiplier, whether greater or less, and use the factors of this number. To the final product *add*, if the number be *less*, and *subtract* from it if the number be greater, the product arising from multiplying the given quantity by the *difference* between the multiplier and number taken from the table: the result will obviously be the complete product required.

£	s.	d.
23	14	7 $\frac{1}{2}$
7		
166	2	6 $\frac{1}{2}$
5		
830	12	7 $\frac{1}{2}$
3		
2491	17	9 $\frac{1}{2}$

For example, if the multiplier of the sum above had been 107 instead of 105, we should still have taken 105, and have used the factors of it, as just shown; but to the product by these factors, we should have *added* twice the multiplicand; we should thus have got 105 times the sum and twice the sum, that is 107 times the sum as proposed. If the multiplier had been 109, then from 112 times, that is from $8 \times 7 \times 2$ times, we should have *subtracted* 3 times the original multiplicand as in the margin, and should thus have found £23 14s. 7½d. \times 109 = £2586 16s. 4¾d.

£	s.	d.	
23	14	7½	$\times 3$
			8
<hr/>			
189	17	2	
			7
<hr/>			
1329	0	2	
			2
<hr/>			
2658	0	4	
			71 3 11½
<hr/>			
2586	16	4¾	

The following statements are left for the learner to verify after the manner now shown:—

- (1.) £3 18s. 6d. \times 6 = £53 11s. 0d.
- (2.) £148 7s. 0½d. \times 9 = £1335 3s. 2½d.
- (3.) £148 7s. 0½d. \times 63 = £9346 2s. 3¾d.
- (4.) 6s. 10½d. \times 97 = £33 6s. 10½d.
- (5.) 15 mil. 3 fur. 2 per. 4 yds. \times 75 = 1153 mil. 6 fur. 3 yds.

Division of Compound Quantities.—Division of concrete quantities may be viewed under two aspects, accordingly as the divisor is itself a concrete quantity or merely an abstract number.

If you have to divide by a concrete quantity, your object is to find *how many times* the smaller quantity—the divisor—is contained in the larger—the dividend. But if you have to divide by an abstract number, you then seek to divide the proposed quantity into *as many equal parts* as there are units in the divisor. These, you see, are two different objects; and precision and accuracy of thought require that you should bear in mind the distinction. When you divide one concrete quantity by another, your quotient is, of course, an *abstract number*: but when you divide a concrete quantity by an abstract number, your quotient is also a *concrete quantity* of the same kind. You will remember that I am not here writing a book on Arithmetic exclusively with a view to mercantile practice. I am endeavouring to prepare you for a course of mathematical study; and I therefore wish you to cultivate habits of thought and reflection—to know what you are actually about, and not to feel contented by merely following a *rule*. I shall not insist upon any marked departure from the customary forms of expression, in the practical directions for working an example; but I *do* insist upon accuracy of *thought*, whatever want of precision in *language* custom may authorize.

To divide a compound quantity by a *number*, the rule is this:—

RULE.—Commence with the *highest* denomination, and take the proposed part of it; reduce what is over to the next denomination, and carry the result to the next term of the dividend; take the proposed part of the sum, reducing what is over, and carrying as before; and so on, to the end.

Thus, if the 7th part of £22 15s. 9d. be required, we find it as in the margin: the 7th part of £22 is £3 and 20s. over: this, carried to the 15s., gives 35s.; the 7th part of which is 5s., and there is nothing to carry: the 7th part of 9d. is 1d.; and 2d., or 8 farthings, over; the 7th part of which is 1 farthing, and ¼ of a farthing; hence, the 7th part of the proposed sum is £3 5s. 1¼d. + ¼f.

£	s.	d.
7)22	15	9
<hr/>		
3	5	1¼

If the divisor exceed 12, we must proceed, upon the same principle, by long division, unless the divisor can be decomposed into convenient factors; when the operation need to consist only of successive steps like the single step above.

When the divisor, instead of being an *abstract number*, is a *concrete quantity*, of the same kind as the dividend, the rule is as follows:—

RULE.—Reduce both dividend and divisor to the *lowest denomination* found in *either*, and then perform the division exactly as in the case of mere numbers: the quotient will denote the *number of times* the smaller quantity is contained in the greater.

For example, let it be required to divide £63 7s. by £13 2s. 3d. Then, as *pence* is the lowest denomination that occurs, we reduce *both* quantities to *pence*, and then divide as in

£	s.	d.	£	s.
13	2	3	63	7
20			20	
262			1267	
12			12	
3147)			15204(4	
			12588	
			2616	

the margin: the quotient shows that the smaller sum is contained in the larger between 4 and 5 times: it is contained in it 4 times and a *fractional part* of a time, represented by $\frac{262}{1045}$, which is nearly another time, but not quite. You may shorten the work a little by reducing the two quantities—not to *pence*, but to *three-pences*—as shown below; observing, that as 4 three-pences make 1 shilling, we multiply the number of shillings by 4, and take in the 1 three-pence. From this mode of working, we should conclude that the dividend contains the divisor 4 times and a part of a time, denoted by the fraction $\frac{262}{1045}$, which differs from the former fraction only in

appearance—not in value; for if we wish to express that one number is to be divided by another, we may, as you are aware, do so by writing the latter below the former, or by writing twice, three times, &c. the latter below twice, three times, &c. the former; as is pretty obvious, since the quotient of dividend and divisor is the same, whatever number *both* be multiplied by; and you see that the upper and lower numbers of the first fraction are only those of the second, each multiplied by 3.

There is no room in this treatise for many examples. I shall here give you two. The first is to show that £33 15s. 6d. divided by 13 gives £2 11s. 6d. for quotient; the second is to show that the same sum divided by £13 gives $2\frac{11}{13}$ for quotient. In working the second example, you had better reduce to *sixpences*, not to *pence*.*

Fractions.—What has preceded suffices to convey a general, and, I hope, a pretty accurate notion of the arithmetic of *integral* quantities. I am now to show how the fundamental operations are to be applied to *fractions*. I have found it impossible to avoid allusion to fractions in the foregoing part of the subject, because they force themselves upon our notice even when operating upon *integers*; but the arithmetic of fractions remains to be explained, and, indeed, the formal definition of a fraction to be given. In strictness, a fraction is a part of a *whole*—that is, it is *less* than the quantity of which it is said to be a fraction. Thus, $\frac{1}{3}$, $\frac{2}{5}$, $\frac{4}{13}$, &c., are strictly fractions—*proper* fractions. The first denotes a third part of unit, or 1, the second a fifth part of 2, the third a forty-third part of 26, &c., each part being *less* than one whole. But $\frac{4}{3}$, $\frac{7}{5}$, $\frac{13}{13}$, &c., are also called fractions, though four-thirds, seven-fifths, sixty-four forty-thirds, &c., are all greater than one whole, as is plain; fractions such as these, where the upper number, called the *numerator*, is not less than the lower, called the *denominator*, are said to be *improper fractions*. You will readily see why these terms, numerator and denominator, are, so applied: the upper number *enumerates*, or states the number of parts of that particular *denomination* indicated by the

* For a great variety of instructive examples in all the rules of arithmetic, as well as for a comprehensive view of the theory, see the "Rudimentary Treatise on Arithmetic," published by Mr. Weale.

£	s.	d.	£	s.
13	2	3	63	7
20			20	
262			1267	
4			4	
1049)			5068(4	
			4196	
			872	

lower number. Thus, $\frac{3}{4}$ means *three* of the parts called *fourths*: if it were $\frac{3}{4}$ of £1, then, since one-fourth is *5s.*, three-fourths, or $\frac{3}{4}$, would be *15s.*, and so on. Instead of reading this fraction *three-fourths*, we may, if we please, say *three divided by four*. Three pounds divided by the number 4, is evidently the same as three-fourths of one pound; and any fraction may be viewed in either of these two ways—thus it is matter of indifference whether you call $\frac{5}{7}$, *five-sevenths*, or *5 divided by 7*: a moment's reflection will convince you that five-sevenths of anything, is the same as a seventh part of *five* such things; for a seventh part of one of them added to a seventh part of another, then again this sum increased by a seventh part of another, and so on, till a seventh part of each of the five has been taken, and all these sevenths added,—I say it is plain, that in this way we get 5 times a 7th part of *one*—that is, *five-sevenths* of it—as the result of all five divided by 7.

The fractional notation is perfectly general—*any number* may be expressed in it; a whole number, or an *integer*, as well as a fraction properly so called. Thus 6, 8, &c., may be written $\frac{6}{1}$, $\frac{8}{1}$, &c.; and it is sometimes convenient to write integers this way. Here the denominator is *unit*, or 1; but you may express an integer in the form of a fraction with *any* denominator you please. Thus, if you choose 7 for denominator, the two numbers, 6, 8, may be written $\frac{42}{7}$, $\frac{56}{7}$, as is evident: you have only to multiply the number by the chosen denominator, and to place the factor, thus used as a multiplier, underneath—that is, as a divisor. The numerator and denominator are called the *terms* of the fraction; and when an integer is united to a fraction, the whole is called a *mixed number*. Thus, $2\frac{1}{2}$, $3\frac{1}{4}$, &c., are *mixed numbers*.

To reduce a Mixed Number to an Improper Fraction.

The rule is this: multiply the integer by the denominator of the fraction; add the product to the numerator, and put the denominator underneath. Thus, $2\frac{1}{3} = \frac{7}{3}$, $3\frac{2}{3} = \frac{11}{3}$; for 2 is evidently $\frac{6}{3}$, and $\frac{6}{3} + \frac{1}{3} = \frac{7}{3}$. In like manner 3 is $\frac{6}{2}$, and $\frac{6}{2} + \frac{1}{2} = \frac{7}{2}$; and so on. Here are other examples: $5\frac{2}{3} = \frac{17}{3}$; $4\frac{1}{2} = \frac{9}{2}$; $7\frac{1}{3} = \frac{22}{3}$; $12\frac{1}{11} = \frac{133}{11}$, &c. &c. To accomplish the contrary purpose—that is,

To reduce an Improper Fraction to a Mixed Number,

You have only to perform the division indicated by the denominator, and to annex to the quotient the fractional correction as in common division. Thus, $\frac{7}{3} = 2\frac{1}{3}$, $\frac{11}{3} = 3\frac{2}{3}$, $\frac{17}{3} = 5\frac{2}{3}$, $\frac{9}{2} = 4\frac{1}{2}$, $\frac{22}{3} = 7\frac{1}{3}$, and so on.

To reduce Fractions with Different Denominators, to others of the same Value with Equal Denominators.

This is one of the most important operations in the arithmetic of fractions; for till fractions appear with a *common denominator*, they can neither be added to nor subtracted from one another: the reduction of fractions to a common denominator is thus a preliminary indispensably necessary to the application to them of the first rules of arithmetic. The operation is also useful in enabling us to discover at a glance which of two fractions, however nearly equal, is really the greater. Thus, of the two fractions, $\frac{3}{7}$, $\frac{4}{7}$, we see in a moment which is the greater, *because* their denominators are the same; but you could not so readily and confidently state which is the greater of $\frac{3}{4}$ and $\frac{4}{7}$; yet the former are only these reduced to a common denominator—the values are the same.

The rule for reducing fractions to a common denominator is as follows:—

RULE.—Multiply *each* numerator by the product of the denominators of all the *other* fractions; we shall thus get the *numerators* of the changed fractions.

Multiply *all* the denominators together; the product will be the *common denominator* belonging to each changed numerator.

For example: in order to reduce the fractions $\frac{2}{3}$, $\frac{1}{3}$, $\frac{4}{7}$, to others of the same value with the same denominator, we proceed as follows:—

$$\left. \begin{array}{l} 2 \times 3 \times 7 = 70 \\ 1 \times 3 \times 7 = 21 \\ 3 \times 3 \times 5 = 45 \\ 3 \times 5 \times 7 = 105 \end{array} \right\} \begin{array}{l} \text{the new numerators;} \\ \\ \\ \text{the common denominator;} \end{array}$$

therefore the equivalent fractions, changed in form as required, are $\frac{70}{105}$, $\frac{21}{105}$, $\frac{44}{105}$.

If you compare these with the original fractions, you will see that they each arise from multiplying numerator and denominator of the former by the same number. Thus,

$\frac{70}{105} = \frac{2 \times 35}{3 \times 35}$; and it is obvious that one number divided by another (in this case 2 by 3),

is the same as 35 times the former divided by 35 times the latter, or any number of times the former divided by the same number of times the latter. If you have any doubt of this, just consider, if you had to divide 2*s.* among 3 people, whether the *share* of each would not be the same as if you had to divide 35 times 2*s.*—that is, 70*s.*—among 35 times 3 people—that is, 105 people. It is plain that, in either case, each would get a third part of 2*s.*, or two-thirds of 1*s.*; or, to view the matter more generally, it is self-evident that if you *multiply* any quantity by a number, and then *divide* by the same number, you virtually leave the quantity, as to *value*, untouched; for multiplication and division by the *same* number, are two operations which mutually neutralise one another: we may, therefore, always multiply numerator and denominator of a fraction by any number, without changing the value of the fraction.

The rule just given will *always* effect the object proposed by it; but not always in the shortest way. In particular cases it will be desirable to proceed differently. Thus, if the fractions $\frac{2}{3}$, $\frac{1}{3}$, $\frac{4}{7}$, are to be changed into equivalent ones with a common denominator, you see, by looking at the denominators, that the thing may be brought about without interfering with the middle fraction at all: you have only to multiply the terms of the first fraction by 2, and those of the third by 3, to get the desired result—the changed fractions being found in this way to be $\frac{4}{6}$, $\frac{2}{6}$, $\frac{4}{6}$. If you had applied the *rule*, the new fractions would have been $\frac{14}{21}$, $\frac{7}{21}$, $\frac{44}{105}$, forms far less simple than those above, although the same in *value*; they would be got by multiplying the terms of the simpler fractions, each by 6. In bringing fractions to a common denominator, you should always be on the look out for the simplest multiplier of the terms of each that will accomplish the object, and use the *rule* only as matter of necessity—that is, only when simpler multipliers than the rule supplies do not present themselves. Suppose you had $\frac{2}{3}$, $\frac{1}{4}$, $\frac{4}{7}$, do you not see, from a glance at the denominators, that if the first be multiplied by 3, the second by 4, and the third by 8, that the products will be all alike? Multiply, then, the terms of the first fraction by 3, those of the second by 4, and those of the third by 8, and you will get the following—viz., $\frac{6}{12}$, $\frac{4}{12}$, $\frac{32}{12}$, for equivalent fractions with a common denominator. The *rule* would have given you these— $\frac{16}{24}$, $\frac{11}{24}$, $\frac{44}{24}$, which, although equal to, are far less simple than the former.

The *smallest* number that can be a common denominator of a row of fractions is evidently the smallest number that is divisible by each of the given denominators: it is called the *least common multiple* of those denominators. There is a rule for finding the least

common multiple of a set of numbers,* but you see that it may often be discovered, without any rule, by a little reflection. I shall give you but one more instance here, since the reduction of fractions to a common denominator, as observed above, will form a necessary preparation for addition and subtraction. Let the fractions be $\frac{2}{3}$, $\frac{5}{6}$, $\frac{1}{2}$, $\frac{2}{3}$: here you see that the first two are brought to a common denominator by merely multiplying the terms of the first by 3; so that these two fractions are $\frac{4}{6}$, $\frac{5}{6}$. Again, the last two are brought to a common denominator by merely multiplying the terms of the fourth by 3; so that these two fractions are $\frac{3}{6}$, $\frac{4}{6}$. We have, therefore, now only to find the *least* number which will divide by 9 and 6; and it requires but little thought to discover that 18 is that number: so that we reach the desired result by the following steps:—

$$\begin{array}{cccc} \frac{2}{3}, & \frac{5}{6}, & \frac{1}{2}, & \frac{2}{3} \\ \text{or, } & \frac{4}{6}, & \frac{5}{6}, & \frac{1}{2}, & \frac{2}{3} \\ \text{or, } & \frac{4}{6}, & \frac{5}{6}, & \frac{3}{6}, & \frac{4}{6} \end{array}$$

where you see that a fraction in either of the lower rows is merely that above, with its *terms* multiplied by the same number. If you had applied the rule to the first row of fractions, you would have got $3 \times 9 \times 6 \times 2 = 324$ for a common denominator, instead of the mere simple number 18.

Addition and Subtraction of Fractions.—**RULE.**—Reduce the fractions to equivalent ones, having a common denominator: then add or subtract the numerators, as proposed, and put the common denominator under the result.

For instance, let the fractions be $\frac{2}{3}$ and $\frac{1}{2}$: these, reduced to a common denominator, are $\frac{4}{6}$ and $\frac{3}{6}$; therefore $\frac{4}{6} + \frac{3}{6} = \frac{7}{6}$; their *sum*: $\frac{4}{6} - \frac{3}{6} = \frac{1}{6}$; their *difference*.

Again, let it be required to find the value of $\frac{2}{3} + \frac{2}{5} - \frac{1}{2}$. Here the second and third fractions will have a common denominator, if the terms of the third are multiplied by 3: the differing denominators will then be 5 and 9; that is, we shall have $\frac{2}{5} + \frac{2}{5} - \frac{3}{9} = \frac{4}{5} - \frac{1}{3}$; that is, by the rule for the common denominator, $\frac{4}{5} - \frac{1}{3} = \frac{12}{15} - \frac{5}{15} = \frac{7}{15}$.

Suppose the value of $1 - \frac{2}{5} - \frac{3}{5}$ were required. It is easy to see that the denominators will be made alike if the first be multiplied by 4 and the second by 3; so that, multiplying numerators, as well as denominators, we have $1 - \frac{2}{5} - \frac{3}{5} = 1 - \frac{8}{15} - \frac{9}{15} = \frac{15}{15} - \frac{17}{15} = -\frac{2}{15}$.

And in like manner are the results following obtained:—

$$(1.) \frac{1}{2} + \frac{1}{3} = \frac{5}{6}. \quad (2.) \frac{1}{2} - \frac{1}{3} = \frac{1}{6}. \quad (3.) \frac{2}{3} + \frac{1}{2} + \frac{1}{3} = 2\frac{1}{6}. \quad (4.) \frac{1}{2} - \frac{1}{3} = \frac{1}{6}. \quad (5.) 6\frac{1}{2} - 5\frac{1}{2} = 1\frac{1}{2}. \quad (6.) 11\frac{1}{2} + 8\frac{1}{2} - 9\frac{1}{2} = 10\frac{1}{2}$$

In the subtraction of mixed quantities, it sometimes happens that the fractional part of the subtracted quantity is greater than the fractional part of the other: when this is the case, it is better to convert a unit of that other into a fraction, and to incorporate it with the fractional part: we shall thus have an improper fraction, from which the subtractive fraction may be taken; thus, if we had to take $3\frac{1}{2}$ from $5\frac{1}{3}$, we see, when the fractions are brought to a common denominator, by multiplying the terms of the first by 4, and those of the second by 3, that the subtractive fraction $\frac{12}{6}$ is greater than $\frac{2}{6}$, the other fraction; we therefore *fractionize* a unit of the 5, considering 5 to be $4\frac{3}{3}$, and therefore $5\frac{1}{3}$, or $5\frac{2}{6}$, to be $4\frac{4}{6}$; so that the work stands thus: $5\frac{2}{6} - 3\frac{1}{2} = 5\frac{2}{6} - 3\frac{3}{6}$.

* The rules for finding the greatest common measure, and the least common multiple, of a set of numbers, are seldom actually employed in the management of fractions. The investigation of these rules, too, is generally long and troublesome: the simplest investigation of them, to which I can refer, is to be found in the "Rudimentary Treatise on Arithmetic," published by Mr. Weale; and in the Key to that work a shorter method of arriving at the common measure will be found than any other book furnishes.

Multiplication and Division of Fractions—Multiplication.—If we have to multiply a fraction by a whole number, the product will, of course, be as many times that fraction as there are units in the whole number: thus, $\frac{2}{5} \times 3 = \frac{6}{5}$; that is, 3 times two-fifths: the denominator is not operated upon, because this merely states the denominations, not the number of them. If, instead of 3, the multiplier had been only a fourth part of 3, that is $\frac{3}{4}$, then only a fourth part of the above product, $\frac{6}{5}$, could have resulted. A fourth part of $\frac{6}{5}$ is $\frac{6}{20}$, because a number (in this instance 6) divided first by 5, and then again by 4, gives the same result as a single division of it by 20. We know, therefore, that $\frac{2}{5} \times \frac{3}{4} = \frac{6}{20}$; that is, it is the product of the numerators, divided by the product of the denominators.

The same reasoning evidently applies, whatever be the fractions to be multiplied together: the product of the numerators, divided by the product of the denominators, is the product of the fractions.

Division.—Let us now try to discover how fractions are to be divided; and first let us consider the case in which the divisor, like the multiplier, in the foregoing instance, is a whole number.

If we have to perform the operation $\frac{2}{5} \div 3$, we see that the quotient of 2 by 5 is to be divided by 3: but this we know, from simple division, is the same as the quotient of 2 by 15; for, if anything is divided by 5 and then the quotient by 3, the result is the same as we should get by dividing that thing at once by 5×3 or 15; therefore, $\frac{2}{5} \div 3 = \frac{2}{15}$.

But if, instead of 3, the divisor were $\frac{3}{4}$, that is, only a fourth part of 3, it is plain that the quotient ought to be 4 times as great; namely, $\frac{8}{15}$; so that $\frac{2}{5} \div \frac{3}{4} = \frac{8}{15}$; the same result as we should get by inverting the divisor $\frac{3}{4}$, and multiplying, instead of dividing; for $\frac{2}{5} \times \frac{4}{3} = \frac{8}{15}$. And as the reasoning evidently applies, whatever be the fractions chosen, we infer that division of fractions may always be converted into multiplication by inverting the terms of the divisor; that is, in fact, by turning the divisor upside down. Thus, $\frac{2}{5} \div \frac{3}{4} = \frac{2}{5} \times \frac{4}{3} = \frac{8}{15}$. We are thus led to the following rules, viz. :—

RULE.—For multiplication.—Multiply the numerators together for the numerator of the product.

Multiply the denominators together for the denominator of the product.

RULE.—For division.—Invert the terms of the divisor, and then proceed as in multiplication.

It is desirable that fractions which appear in the results of any operations, should be reduced to their lowest terms; that is, that both numerator and denominator should be divided by whatever number will divide them. Thus, in the instance above, where the product of $\frac{2}{5}$ and $\frac{3}{4}$ was found to be $\frac{6}{20}$, the result should be freed from the factor 2, common to both numerator and denominator; that is, we should divide both terms by 2, and write the result in the more simple form, $\frac{3}{10}$. The division of both terms by the same number cannot alter the value of the fraction, otherwise the multiplication of the terms of a fraction by the same number would alter its value, which we know to be not the case.

In multiplication and division, we may often prevent the entrance of these superfluous factors in the result; and it is of course better to do so than to allow them to enter, and then to remove them: thus, in multiplying $\frac{2}{5}$ by $\frac{3}{4}$ we foresee that, as 2 occurs in a numerator and 4 in a denominator, 2 will also occur in both numerator and denominator of the product, unless we previously prevent its entrance: this we should do by regarding the proposed fractions as $\frac{1}{5}$, $\frac{3}{2}$; the product of which is $\frac{3}{10}$. You should always

suppress, in this way, all the factors that enter alike into numerators and denominators, for you then get your product in the simplest form at once, without being at the trouble to reduce it to lower terms. I shall here give an example or two of this :

(1.) $\frac{7}{8} \times \frac{11}{12} = \frac{7}{4} \times \frac{11}{12} = \frac{77}{48}$. (2.) $\frac{2}{3} \times \frac{3}{5} = \frac{2}{3} \times \frac{3}{5} = \frac{2}{5}$. (3.) $\frac{4}{5} \div \frac{11}{12} = \frac{4}{5} \times \frac{12}{11} = \frac{48}{55}$.
 (4.) $\frac{12}{14} \div \frac{4}{5} = \frac{12}{14} \times \frac{5}{4} = \frac{3}{7} \times \frac{5}{2} = \frac{15}{14}$. (5.) $\frac{10}{12} \div \frac{3}{5} = \frac{10}{12} \times \frac{5}{3} = \frac{5}{6} \times \frac{5}{3} = \frac{25}{18}$.

In this way the entrance of common factors into the numerator and denominator of each result in the following examples is to be provided against :—

(1.) $\frac{7}{8} \times \frac{11}{12} = \frac{77}{96}$. (2.) $\frac{10}{12} \div \frac{3}{5} = \frac{25}{18}$. (3.) $\frac{10}{12} \div \frac{3}{5} = 9$. (4.) $\frac{3}{4} \div \frac{1}{11} = 2\frac{3}{4}$. (5.) $\frac{12}{14} \div \frac{4}{5} = 1\frac{1}{7}$. (6.) $\frac{7}{8} \times \frac{4}{5} = 1$.

In these examples, the rules are applied to pure fractions. If we have to deal with mixed quantities, then we must reduce them to improper fractions before using either rule :

Proportion.—Four quantities are said to be in *proportion* when the first divided by the second is the same *abstract number* as the third divided by the fourth : thus, the four numbers, 6, 3, 8, 4 are in proportion, because $\frac{6}{3} = \frac{8}{4}$; and of any two equal fractions the four terms are in proportion.

The quotient which arises from dividing one quantity by another of the same kind, is called the *ratio* of the former to the latter : thus, the ratio of 6 to 3 is 2, and the ratio of 8 to 4 is 2; *ratio* being only another name for the *quotient* of two quantities of the same kind. A proportion is thus said to be an equality of ratios : *ratio* implies two terms; *proportion*, four. The first term of a ratio (the dividend) is called the *antecedent*, the second (the divisor) its *consequent*. Instead of writing the antecedent and consequent as the numerator and denominator of a fraction to express the ratio, the same thing is indicated by simply putting two dots between them; thus, 6 : 3 is the same as $\frac{6}{3}$; and 8 : 4 the same as $\frac{8}{4}$; so that the proportion above may be expressed in this way, 6 : 3 = 8 : 4; but, instead of the sign of equality, it is more common to use four dots, and to write the proportion thus : 6 : 3 :: 8 : 4, which is read, 6 is to 3 as 8 is to 4; a form of expression intended to imply that 6 is related to 3, in point of magnitude, just as 8 is related to 4. This idea of relative or comparative magnitude, which is essential to the correct notion of proportion, forbids our considering the term *ratio* in the same unrestricted sense as the term *quotient* : the two terms are to be regarded as meaning the same thing only when dividend and divisor are quantities of the same kind : *ratio* is always an *abstract number*; but the name quotient, as we have seen, is applied not only to abstract numbers, but to the concrete quantities that arise from taking the third, fourth, fifth, &c. part of concrete quantities. Be careful to observe this distinction; and to remember that the ratio of an antecedent to its consequent *always* has reference to the *number of times*, and parts of a time, which the former contains the latter : so that it would be absurd to speak of the ratio of one thing to another of a different kind; as, for instance, of the ratio of £6 to the number 3; or of 8 cwt. to £4, &c.

It thus appears, that if four quantities, ranged in order as above, form a proportion, the first and second must necessarily be of the same kind; and also that the third and fourth must be of the same kind : thus the following are proportions; they express equal ratios, the ratio in each case being the abstract number 2—

£6 : £3 :: 8 cwt. : 4 cwt. ; 6 yds. : 3 yds. :: 8 oz. : 4 oz.

From what has now been said, you see that the essential condition, and the only

condition which four quantities must fulfil, in order that they may form a proportion, is this, namely—

First term Third term

Second term Fourth term

each of these fractions being an abstract number. If two fractions are equal, we know that two equal fractions will also result from inverting their terms, so that from the above we may infer that

Second term Fourth term

First term Third term

These being abstract numbers, we may multiply *any* quantity by either: the results will, of course, be equal, whichever we take for multiplier, since they themselves are equal. Let us multiply "Third term" by each: the results will be

Second term.

_____ × Third term = Fourth term.

First term

You can have no doubt about the second result, as you know that divisor, multiplied by quotient, gives dividend; and the fraction above, on the right, denotes the *quotient* of the division of "Fourth term" by "Third term."

It appears, then, that in order to find the fourth term of a proportion, when the first three terms are given, we have only to divide the second by the first, and to multiply the third by the abstract number furnished by the quotient. Now, if the first and second terms are concrete quantities, you know that you *cannot* divide one by the other, and thus get the abstract number here spoken of, till the quantities are reduced to the same denomination (see p. 26). When, however, this is done, you may entirely disregard *denomination*, and consider the resulting numbers to be *abstract* numbers; for the *quotient* is the same in both cases: thus $\frac{£6}{£3}$ is the abstract number 2; and so is $\frac{6}{3}$, or $\frac{6 \text{ cwt.}}{3 \text{ cwt.}}$, or

3 yds.

This, though a very obvious, is yet an important fact; as we learn from it that, when the first and second terms of a proportion are reduced to the same denomination, we may consider both numerator and denominator of the fraction $\frac{\text{Second term}}{\text{First term}}$ as abstract numbers, as well as the fraction itself; and therefore that, without violating any principle of arithmetic, we may write the above equality, namely—

Second term
_____ × Third term = Fourth term
First term

in the form,

Second term × Third term
_____ = Fourth term
First term

which is often the more convenient in practice; that is, after the reduction to the same denomination, as spoken of above, we may multiply the third term by the second (regarded as a *number*), and divide the product by the *number* denoting the first term.

We have thus established the general principle of what is called the *Rule of Three*, the object of which is, when three terms of a proportion are given, to find the fourth.

Rule of Three.—1. Write the three given terms in a row, taking care that the *third* term is a quantity of the same kind as the required *fourth* term; and also taking care that, according as this fourth term is to be greater or less than the third, so may the *second* of the given terms be greater or less than the first. This is called *stating* the question.

2. Having thus properly stated the question, bring the first and second terms to the same denomination; and regard the results as *abstract numbers*, the *denomination* being suppressed.

3. Multiply the third term by the second, which is now a *number*; and divide the product by the first, which is also a number: the quotient will be the required fourth term, in the same denomination, of course, as that in which the third term was used.

You may sometimes simplify this operation: for the first and second terms may each be divisible by the same number; in which case you may employ only the quotients instead of the quantities themselves, on the principle that a fraction is not altered in value by discarding factors common to numerator and denominator. You may, also, in like manner, divide the first and third terms, when possible, on the same principle; and I would recommend you, in rule-of-three operations, to be always on the look-out for these means of simplification.

I shall now show the application of the rule to an example or two.

1. If 16 cwt. cost £42 8s., how much will 26 cwt. cost?

As the answer or fourth term of the proportion is to be *money*, the £42 8s. given in the question must be the third term.

$$\begin{array}{r}
 16:26 :: 42\ 8:68\ 18 \\
 8:13 \quad 20 \\
 \hline
 848 \\
 13 \\
 \hline
 2544 \\
 848 \\
 \hline
 8)11024s. \\
 2,0)1378s. \\
 \hline
 \pounds 68\ 18s.
 \end{array}$$

As the greater the number of cwt. the greater will be the cost, we must arrange the first two terms of the proportion, so that the second may be the greater; consequently, the stating will be 16 cwt.:26 cwt.:£42 8s.:the required fourth term. But, as the first and second terms are already in the same denomination, namely, cwt., no reduction of them is necessary; we, therefore, in the stating, entirely disregard this common denomination, and insert merely the abstract numbers, 16 and 26, in the margin. But, a glance at these two numbers shows that each is divisible by 2; we, therefore, replace them by the quotients 8 and 13; and it now only remains to multiply £42 8s. by the number 13, and to divide the product by 8, to get the sum of money required. For convenience, we reduce the given sum to shillings, and thus bring out the answer or required fourth term in shillings, and then convert these into pounds, and when the work is finished, as here annexed, we complete the proportion, in the stating, by putting the result, viz., £68 18s. for the fourth term.

You see that, by dividing the first and second terms in the stating by 2, we have effected a little saving of figures in the work: but we might have simplified further, and have shortened the operation still more, by dividing the third term and the reduced first term both by 8; so that, having regard to the utmost attainable simplicity, we should have proceeded with the preliminary statings as here annexed, and thus have reduced the subsequent work to the small amount of figures here shown; 13 times 6s. is 78s.; that is, £3 18s.: putting down the 18s., and carrying the £3, we have 13 times £5 = £65; and the £3 carried makes £68. Here is another example:

$$\begin{array}{r}
 16:26 :: 42\ 8 \\
 8:13 \\
 1:18 :: 5\ 6 \\
 \hline
 18 \\
 \hline
 \pounds 68\ 18s.
 \end{array}$$

2. If 28 persons reap a harvest in 36 days, how many will be required to reap it in 21 days?

As the answer is to be number of persons, the 28 persons given in the question must be the third term of the proportion; and as the fewer the days the greater must be the number of workmen, we arrange the first two terms of the proportion so that the second may be the greater; the stating is, therefore, 21 days : 36 days :: 28 persons : the number of persons required.

	Persons.	Persons.
21 : 36 ::	28	: 48
7 : 12		
1 : 12 ::	4	
	12	
	—	
	48 persons.	

But, as the first two terms are in the same denomination, we suppress *denomination*, and use only the abstract numbers 21 : 36. These we see have a common divisor, 3; we therefore replace them by the quotients 7 : 12; but the 7 and the 28 in the *third* term will divide by 7; we thus get the stating in the simple form 1 : 12 :: 4 persons; and then proceed as in the margin.

One example more must suffice.

A mass of 106 lb. of Australian gold, found in July 1851, sold at the rate of £3 6s. 8d. per ounce: how much did it fetch?

Stating the question as in the margin, putting the greater weight in the second term, because the greater sum must be in the fourth, we see that the first and second terms differ in denomination; we must, therefore, reduce the second to ounces, before we can regard the stating in the proper form for working with: it then becomes 1 oz. : 1272 oz. :: £3 6s. 8d.

	£	s.	d.	£
1 oz. : 106 lb. ::	3	6	8	: 4240
	12		20	
	—			
		1272	66	
		800	12	
	—			
	12)	1017600	800	
	—			
		20)	8480.0	
	—			
			£	4240

The common denomination *ounces* is now suppressed, and, for convenience, the money is reduced to *pence*, the denomination in which the required fourth term must therefore appear: we have then merely to multiply 800 *pence* by the abstract number 1272; and the required value comes out 1017600 *pence*; for, as the first term is 1, there is no division.

Instead of making 1272 the multiplier of 800, we make 800 the multiplier of 1272, for convenience; as we know that the *number*, furnished for the product, is the same in one case as the other; this *number*, therefore, is so many *pence*; which, when reduced to *pounds*, is £4240.

The following are a few examples for exercise:—

- (1.) If 57 cwt. cost £216, what will 95 cwt. cost?—Ans. £360.
- (2.) If 148 gallons cost £119 10s., how many gallons will £99 12s. 6d. buy?—Ans. 111.
- (3.) What is the value of 2 qr. 24 lb. at £5 7s. 4d. per cwt.?—Ans. £3 16s. 8d.
- (4.) What is the income of a person who pays £22 7s. 5d. for income tax, at the rate of 7d. in the pound?—Ans. £767.
- (5.) 44½ guineas used to be coined out of 1 lb. of standard gold: how many sovereigns are now coined out of this weight?—Ans. 46½.
- (6.) 66s. are coined out of 1 lb. of standard silver: what is gained in coining £100 of silver, if the price of the silver be 6s. 2d. per oz.?—Ans. £6 9½s.

The Double Rule of Three.—The double rule of three is so called because there are at least *two* single rule-of-three statings implied in it. The following is an example, namely:—

If 12 horses plough 11 acres in 5 days, how many horses will plough 33 acres in 18 days?

This may be divided into two single rule-of-three questions: thus—1st. If 12 horses plough 11 acres, how many will plough 33 acres in the same time? By the former rule,

$$11 : 33 :: 12 \text{ horses} : \frac{12 \times 33}{11} \text{ horses} = 36 \text{ horses.}$$

2nd. If 36 horses can perform a work in 5 days, how many can perform the same in 18 days? By the former rule,

$$18 : 5 :: 36 \text{ horses} : \frac{36 \times 5}{18} \text{ horses} = 10 \text{ horses.}$$

It is plain that by these two single rule-of-three operations, the correct answer to the question is obtained; but it is more readily obtained by the following arrangement:—

$$\begin{array}{l} 11 : 33 \\ 18 : 5 \end{array} \} :: 12 \text{ horses} : \frac{12 \times 33 \times 5}{11 \times 18} \text{ horses} = 10 \text{ horses.}$$

The fourth term of this *compound proportion*, as it is called, being got by multiplying the third term by the product of the *consequents*, and then dividing by the product of the *antecedents*; and it is by the same multiplications and divisions that the final result is arrived at in the two distinct statings above. This more compact form of working is described in the following rule:—

RULE.—Put for the third term that one of the given quantities which is of the same kind as the quantity sought, just as in the single rule of three.

Then taking any pair of the remaining quantities like in kind, complete the stating, as if for the single rule of three, paying no regard to the other quantities, or rather considering them to remain the same.

Then take another pair, like in kind, as a new antecedent and consequent to be placed under the former pair; these, with the third term above, completing a second single rule-of-three stating. And proceed in this way till all the pairs are used.

Multiply the third term by the product of all the consequents, and divide the result by the product of all the antecedents, and the answer will be obtained.

Each given antecedent and consequent is of course to be regarded as an abstract number. It is convenient to *indicate* merely the several multiplications, at first, to place the divisor under the dividend, in the form of a fraction, as in the above example, and then, before performing the operations, to expunge factors common to numerator and denominator.

EXAMPLE.—If £15 12s. pay 16 labourers for 18 days, how many labourers will £35 2s. pay, at the same rate, for 24 days?

As the answer is to be a certain number of *labourers*, the given 16 labourers is to be the third term; then taking *days* for the first antecedent and consequent, and *money* for the second antecedent and consequent, attending to whether either consequent should be greater or less than its antecedent, as in the former rule, the operation is as follows:—

$$\begin{array}{l} 24 \quad : \quad 18 \\ \text{£}15 \text{ } 12\text{s.} : \text{£}35 \text{ } 2\text{s.} \end{array} \} :: 16 \text{ labourers} : 27 \text{ labourers.}$$

$$\begin{array}{r} 24 \\ \hline 20 \\ \hline 212 \\ \hline 16 \times 18 \times 702 \\ \hline 24 \times 312 \end{array} \text{ lab.} = \frac{4 \times 3 \times 351}{156} \text{ lab.} = \frac{351}{13} \text{ lab.} = 27 \text{ lab.}$$

The 18 is placed in the second term, because fewer labourers are required for 24 days, the work being the same, than for 18; and the £35 2s. is placed in the second term, because more labourers can be paid for that sum than for £15 12s., the time being the same. If the question had been worked by two single rule-of-three statings, we should have had

$$\text{1st. } 24 : 18 :: 16 \text{ lab.} : \frac{16 \times 18}{24} \text{ lab.}$$

$$\text{2nd. } 312 : 702 :: \frac{16 \times 18}{24} \text{ lab.} : \frac{16 \times 18 \times 702}{24 \times 312} \text{ lab.} = 27 \text{ lab.}$$

You see, therefore, that the double rule of three merely compounds the several single proportions into one; it is thus called *compound proportion*.

I add two examples for exercise in this rule:—

1. If 8 persons can be boarded for 16 weeks for £42, how long will £100 support 6 persons at the same rate?—Ans. 50 $\frac{2}{3}$ weeks.

2. If a family of 13 persons spend £64 in butcher's meat in 8 months, when meat is 6d. per lb., how much money, at the same rate of consumption, should a family of 12 persons spend in 9 months, when meat is 6 $\frac{1}{2}$ d. per lb.?—Ans. £72.

In this example, there would be three separate statings, if the question were worked by the single rule of three; these are here to be compounded into one.

Decimals.—It was observed at the commencement of this treatise, that in our system of arithmetic numbers are expressed in the *decimal* notation, and the reason for this designation was stated:—it is simply this—namely, that the unit of any figure in a number is always ten times the unit of the figure in the next place to the right. Thus, in a number consisting of unit-figures—as for instance, in the number 1111—the second unit, beginning with right-hand one, is 10 times the first, the third 10 times the second, the fourth 10 times the third, and so on; or beginning with the first on the left, the second is the tenth part of the first, the third the tenth part of the second, and so on till we come down to the last unit, which is merely one. Now, we may evidently extend this principle still further; and, on the same plan, may represent one-tenth or one, one-tenth of this, or one-hundredth of one, one-thousandth of one, and so on, by simply putting some mark of separation between the *integers* and these *fractions*. The mark actually used is a *dot*, thus: 1111·1111. The unit next the dot, on the left, is 1; the unit one place from this on the left is 10; the next is 100; the next, 1000; and so on. In like manner, the unit one place from the 1 on the right, is $\frac{1}{10}$, the next $\frac{1}{100}$, the next $\frac{1}{1000}$, and so on. This being agreed upon, it is easy to interpret such a number as 36·427: it is 36 + $\frac{4}{10}$ + $\frac{2}{100}$ + $\frac{7}{1000}$; each figure, to the right of the point, being a *fraction* of known denominator; the denominator being 10 for the first figure, 100 for the second, 1000 for the third, and so on. The sum of the fractions represented by the decimal ·427, above, is obviously $\frac{427}{1000}$; in like manner, the fraction expressed by ·2643 is $\frac{2643}{10000}$; and in general the denominator of the equivalent fraction is always 1 followed by as many zeros as there are decimal places, the numerator being the number itself, when the prefixed dot, or *decimal point*, as it is called, is suppressed. You will thus easily see that the following are so many *identities*—namely:—

$$24 \cdot 6 = 24 \frac{6}{10}; 136 \cdot 54 = 136 \frac{54}{100}; 73 \cdot 641 = 73 \frac{641}{1000}; 2 \cdot 07 = 2 \frac{7}{100}, \&c.$$

Any decimal may therefore be converted into its equivalent fraction at sight; it will be shown presently how any fraction may be converted into its equivalent decimal, though not with the same rapidity.

It is pretty evident that whatever whole number be prefixed to a decimal, the same may be prefixed to the numerator of the fraction which replaces that decimal: thus, taking the values above, we have

$24 \cdot 6 = \frac{246}{10}$; $136 \cdot 54 = \frac{13654}{100}$; $73 \cdot 641 = \frac{73641}{1000}$; $2 \cdot 07 = \frac{207}{100}$, &c.; for this is only reducing the foregoing *mixed quantities* to improper fractions.

To reduce a Proper Fraction to a Decimal.

RULE.—Annex a zero to the numerator, and then actually divide by the denominator: if there be a remainder, annex another zero, and continue the division, still annexing a zero, either till the division terminates without remainder, or till as many decimals as are considered necessary are obtained; the quotient, with the decimal point before it, will be the value of the fraction in decimals.

For example: let it be required to express $\frac{3}{8}$ in decimals; the operation is that in the margin. That $\frac{3}{8} = \cdot 375$ is easily proved; for $\frac{3}{8} = \frac{3000}{8000}$; consequently, dividing numerator and denominator by 8, we have $\frac{3}{8} = \frac{375}{1000} = \cdot 375$, from the very nature of decimals. If an *improper* fraction had been chosen, the operation would clearly have been just the same, only there would have been an integer prefixed to the decimal: thus, the operation for $\frac{19}{8}$ would have been as here annexed, showing that $\frac{19}{8} = 2 \cdot 375$. We need not take the trouble of actually annexing the zeros, as here: it is enough that we proceed as if they were inserted, as in the marginal work, for reducing $\frac{1}{11}$ to a decimal; where it is plain, from the remainders, that 54 would recur continually; so that $\frac{1}{11}$ is equal to a *recurring* decimal; the recurring *period* being 54. As a final example, let it be required to convert $\frac{113}{118}$ into a decimal. When one 0 is annexed to the 8, the divisor 118 will go *no times*; therefore, the first decimal place is to be occupied with a 0. Annexing now a second 0, the next decimal figure is 7, and the work proceeds as in the margin: the *noughts* being suppressed, though conceived to be annexed to the 8, and brought down one at a time, as in ordinary division. The quotient shows that $\frac{113}{118} = \cdot 07079$, &c.: the decimals may be carried out to any extent; but if we stop the work here, the error cannot be so great as $\cdot 00001$; that is, it is less than $\frac{1}{100000}$: but it is obvious that, by continuing the work, we can make the error as small as we please.

The following are a few examples for exercise:—

- (1.) $\frac{1}{8} = 1 \cdot 875$. (2.) $\frac{1}{4} = 4375$. (3.) $\frac{1}{10} = 275$.
 (4.) $\frac{1}{32} = 08125$. (5.) $\frac{1}{18} = 076923$, &c. (6.) $\frac{1}{1024} = 00488$, &c.

Addition and Subtraction of Decimals.—The rules for these fundamental operations are in reality the same as those for integers. We must here be careful not only to place units under units, tens under tens, and so on, but also to place *tenths* under *tenths*, *hundredths* under *hundredths*, &c.: that is, the *decimal points* must all range under one another in the same vertical line. This attended to, the operations are just the same as those with integers. See the operations in the margin.

Addition.	Subtraction.
23·628	14·705
4·1056	3·9281
0·137	<hr/>
0·042	10·7769
75	<hr/>
<hr/>	1·84
28·8015	0·657
<hr/>	<hr/>
	1·2743

Multiplication of Decimals.—Multiplication requires no special rule. The multiplier is to be placed under the multiplicand, just as if both were integers, no regard being paid to the decimal points. The only thing to be attended to is the marking off the proper number of decimal places in the product; and this is a very easy matter. We have seen that a number involving decimals is, in fact, a fraction with that number, the decimal point being suppressed, for numerator, and 1, followed by as many ciphers as there are decimal places, for denominator. Two such fractions multiplied together, being the product of the numerators divided by the product of the denominators, will therefore be a fraction of which the denominator is 1, followed by as many ciphers as there are in both factors. Consequently, in the multiplication of decimals, as many decimal places are to be marked off in the product as there are decimal places in *both* factors.

The example in the margin will suffice for illustration. As there are three decimals in the multiplicand, and two in the multiplier, *five* are marked off in the product.

Division of Decimals.—This operation, like that of multiplication, is the same for decimals as for integers; and the way to estimate the number of decimal places in the quotient is suggested by the plan adopted in multiplication.

All the decimals employed in the dividend, including, of course, whatever ciphers may have been added to it to carry on the division, are to be counted. We have then only to provide so many in the quotient, that when added to the number of them in the divisor, we may have just as many as in the dividend.

If the quotient figures, though all be considered as decimals, be too few in number to make up, with those in the divisor, the number in the dividend, then ciphers sufficient for this purpose are to be prefixed to the quotient figures, and the decimal point to be placed before them. See the second example in the margin. In the first of these examples, *six* have been used in the dividend, and as there are *two* in the divisor, there must be *four* in the quotient, which is therefore 10·0515. The last decimal, 5, is a little too great, but it is easy to see that if we had made it 4, the error in defect would have exceeded the present error in excess; and in limiting the number of decimals, we always make the *last* figure as near the truth as possible. In the second example, *five* decimals have been used in the dividend; and as there is but *one* in the divisor, *four* are required in the quotient; and to make up this number, a cipher is prefixed. The quotient is, therefore, ·0265, as far as the decimals have been carried: that is, to four places.

The following examples will serve for exercise in these two rules:—

$$(1.) \cdot 321096 \times 2465 = \cdot 079150164.$$

$$(2.) 464 \cdot 3 \times \cdot 00521 = 2 \cdot 419003.$$

$$(3.) 56 \cdot 10533 \div 17 \cdot 371 = 3 \cdot 23.$$

$$(4.) 2 \cdot 419003 \div 464 \cdot 3 = \cdot 00521.$$

Extraction of the Square Root.—If a number be multiplied by itself, the product is called *the second power*, or the *square*, of that number. If this also be multiplied by the same number, the product is called *the third power*, or the *cube* of that number: and so on for the *fourth power*, *fifth power*, &c. This raising of

23462
1731

23462
70386
164234
23462

49312722

121
1175

25
235

115
1175

824)86 (0265
648

212
1944

176
1620

140

powers, which is also called *involution*, is therefore nothing more than the multiplication together of *equal factors*, and is easy enough. But the reverse operation—that is, to find the factor which, involved in this manner, shall produce a *given number*—is a problem not so readily disposed of. The factor referred to is called the *root* of the power; so that the reverse problem spoken of is the problem of the *extraction of roots*. To extract the *square root* of a given number, is to find a number which, when squared, or raised to the second power, or, which is the same thing, when multiplied by *itself*, shall reproduce the given number. The rule for this operation is as follows:—

RULE.—Commencing at the units' figure, cut off *two* figures, then two more, and so on, thus dividing the number into *periods*, as they are called.

If the number of figures be *even*, we shall therefore have two figures in every period; but if *odd*, the first period, on the left, will have but a single figure.

Take the square root of this first period, or find the root of the nearest square to it, which nearest square is not, however, to be *greater* than the number forming the first period. The root thus found will be the leading figure of the root of the proposed number, and the square of this leading figure is to be subtracted from the first period.

To the remainder annex the second period: the resulting number will be the *first dividend*, and the divisor for it is to be found as follows:—

Put *twice* the root-figure, just found, in the divisor's place; the leading portion of the complete divisor will thus be obtained. This leading portion, as in common division, is enough to suggest the corresponding quotient-figure, which is now to be found, and annexed to the former root-figure, and *also* to the leading portion of the divisor employed in finding it. the divisor will then be *completed*; so that proceeding as in common division, a second remainder will be obtained, to which the *next* period being united, a *second dividend* will result.

To find the corresponding divisor, put *twice* the number, of *two figures*, now in the root's place, in the divisor's place: we shall thus have the leading portion of the complete divisor, by aid of which a *third* root-figure may be found; which, as before, is to be annexed to the former root-figures, and *also* to the incomplete divisor, in order to complete it; and the work is to be then carried another step, as in common division; and so on, till all the periods have been brought down, and annexed, step after step, to the successive remainders, thus supplying the successive *dividends*. If there be a remainder after all the periods have been brought down, the operation may be continued by annexing successive periods of *ciphers* to the successive remainders, or successive periods of the decimals in the given number, should any be there: in either case, the root-figures become *decimals* from the time that ciphers or decimals are annexed.

As the root multiplied by itself produces the original number, the decimal places in the root must, of course, always be just *half* as many as have been employed in determining it. And the root is only to be regarded as an *approximation* to the truth, whenever a remainder is left at the step where the work terminates. As in division of decimals, the departure from strict accuracy may be made as minute as we please by extending the decimals of the root.

Here follow three examples, worked by these precepts: the first is to find the square root of 459684, the second to find the square root of 31640625, and the third to find the square root of 3.65.

<p>(1.) $45,96,84(678$ $\quad 36$ $\quad \underline{\quad}$ $127)996$ $\quad 889$ $\quad \underline{\quad}$ $1348)10784$ $\quad 10784$</p>	<p>(3.) $3,65(1,910497, \&c.$ $\quad 1$ $\quad \underline{\quad}$ $29)261$ $\quad 261$ $\quad \underline{\quad}$ $381)400$ $\quad 381$ $\quad \underline{\quad}$ $38204)190000$ $\quad 152816$ $\quad \underline{\quad}$ $382089)3718400$ $\quad 8438801$ $\quad \underline{\quad}$ $3820987)27959900$ $\quad 26746909$ $\quad \underline{\quad}$ $11245)56225$ $\quad 56225$</p>
---	--

The symbol for the operation of the square root is $\sqrt{\quad}$; which is no doubt a degenerated form of *r*, the initial letter of the word *radix*, or *root*: it appears from the foregoing operations that

$$\sqrt{459684} = 678; \sqrt{31640625} = 5625; \sqrt{3,65} = 1,910497, \&c.;$$

the last root being true as far as the sixth decimal place.

By the same process it is found that

$$\begin{aligned} (1.) \sqrt{478256} &= 687,936. & (2.) \sqrt{784,375} &= 28,0067. & (3.) \sqrt{11} &= 3,316625. \\ (4.) \sqrt{3236068} &= 5688645. & (5.) \sqrt{794\frac{1}{2}} &= \sqrt{794,2} = 28,18155425. \end{aligned}$$

I here terminate this introductory treatise on the general principles of arithmetical computation. The plan of the present work has precluded the possibility of any extensive application of these principles to the various particular objects usually considered, under special heads, in books entirely devoted to Arithmetic. But I believe nothing has here been omitted which can be considered as essential to the clear understanding of these practical inquiries; for a comprehensive view of which, in moderate compass, the learner is referred to the work mentioned at page 29; and, for further remarks on the philosophy of the subject, to Professor De Morgan's "Elements of Arithmetic."

Those who wish to inquire into the early history and progress of Arithmetic, should consult Peacock's elaborate article in the "Encyclopædia Metropolitana," and De Morgan's "Account of Arithmetical Books;" also, Leslie's "Philosophy of Arithmetic," and Delambre's "Arithmétique des Grecs," or the Review of it in No. XXXV. of the "Edinburgh Review."

To those especially who regard the literature of Arithmetic, this latter work, and the able review of it to which I have alluded, will afford matter of the highest interest; since the Greeks were ignorant of our system of decimal notation, and marked their numbers by the letters of their alphabet.

The explanation of the process above given, for the extraction of the square root, will be found in the ALGEBRA—the department of science to which the investigation of the principle of it properly belongs; and it is to this subject that the learner must refer for the necessary particulars respecting the cube-root.

A TABLE

OF THOSE FACTORS OF THE COMPOSITE NUMBERS FROM 75 TO 10000, WHICH FALL
WITHIN THE LIMITS OF THE MULTIPLICATION TABLE.

No.	Factors.	No.	Factors.	No.	Factors.
75	5 5 3	405	9 9 5	1029	7 7 7 3
98	7 7 2	432	12 9 4	1056	12 11 8
105	7 5 3	441	9 7 7	1078	11 7 7 2
112	8 7 2	448	8 8 7	1089	11 11 9
125	5 5 5	462	11 7 6	1125	9 5 5 5
126	9 7 2	484	11 11 4	1134	9 9 7 2
128	8 8 2	486	9 9 6	1152	12 12 8
135	9 5 3	495	11 9 5	1155	11 7 5 3
147	7 7 3	504	9 8 7	1176	8 7 7 3
154	11 7 2	512	8 8 8 •	1188	12 11 9
162	9 9 2	525	7 5 5 3	1215	9 9 5 3
165	11 5 3	528	12 11 4	1225	7 7 5 5
168	8 7 3	539	11 7 7	1232	11 8 7 2
175	7 5 5	567	9 9 7	1296	12 12 9
176	11 8 2	576	12 12 4	1323	9 7 7 3
189	9 7 3	588	12 7 7	1331	11 11 11
192	12 8 2	594	11 9 6	1344	8 8 7 3
196	7 7 4	605	11 11 5	1372	7 7 7 4
198	11 9 2	616	11 8 7	1375	11 5 5 5
216	12 9 2	625	5 5 5 5	1386	11 9 7 2
224	8 7 4	648	9 9 8	1408	11 8 8 2
225	9 5 5	672	12 8 7	1452	12 11 11
231	11 7 3	675	9 5 5 3	1458	9 9 9 2
242	11 11 2	686	7 7 7 2	1485	11 9 5 3
243	9 9 3	693	11 9 7	1512	9 8 7 3
245	7 7 5	704	11 8 8	1536	8 8 8 3
252	12 7 3	726	11 11 6	1568	8 7 7 4
256	8 8 4	729	9 9 9	1575	9 7 5 5
264	11 6 4	735	7 7 5 3	1584	12 12 11
275	11 5 5	756	12 9 7	1617	11 7 7 3
288	12 12 2	768	12 8 8	1694	11 11 7 2
294	7 7 6	784	8 7 7 2	1701	9 9 7 3
297	11 9 3	792	12 11 6	1715	7 7 7 5
308	11 7 4	825	11 5 5 3	1728	12 12 12
315	9 7 5	847	11 11 7	1764	9 7 7 4
324	9 9 4	864	12 9 8	1782	11 9 9 2
336	12 7 4	875	7 5 5 5	1792	8 8 7 3
343	7 7 7	882	9 7 7 2	1815	11 11 5 3
352	11 8 4	891	11 9 9	1848	11 8 7 3
363	11 11 3	896	8 8 7 2	1875	5 5 5 5 3
375	5 5 5 3	924	12 11 7	1925	11 7 5 5
378	9 7 6	945	9 7 5 3	1936	11 11 4 4
384	8 8 6	968	11 11 8	1944	9 9 8 3
385	11 7 5	972	12 9 9	2016	9 8 7 4
392	8 7 7	1008	12 12 7	2025	9 9 5 5
396	11 9 4	1024	8 8 8 2	2048	8 8 8 4

No.	Factors.	No.	Factors.	No.	Factors.
2058	7 7 7 6	3872	11 11 8 4	6336	11 9 8 8
2079	11 9 7 3	3888	9 9 8 6	6468	12 11 7 7
2112	11 8 8 3	3969	9 9 7 7	6534	11 11 9 6
2156	11 7 7 4	3993	11 11 11 3	6561	9 9 9 9
2178	11 11 9 2	4032	9 8 8 7	6615	9 7 7 5 3
2187	9 9 9 3	4096	8 8 8 8	6655	11 11 11 5
2205	9 7 7 5	4116	12 7 7 7	6776	11 11 8 7
2268	9 9 7 4	4125	11 5 5 5 3	6804	12 9 9 7
2304	9 8 8 4	4158	11 9 7 6	6875	11 5 5 5 5
2352	8 7 7 6	4224	11 8 8 6	6912	12 9 8 8
2376	11 9 8 3	4235	11 11 7 5	7056	9 8 7 7 2
2401	7 7 7 7	4312	11 8 7 7	7128	11 9 9 8
2464	11 8 7 4	4356	11 11 9 4	7168	8 8 8 7 2
2475	11 9 5 5	4374	9 9 9 6	7203	7 7 7 7 3
2541	11 11 7 3	4375	7 5 5 5 5	7392	12 11 8 7
2592	9 9 8 4	4455	11 9 9 5	7425	11 9 5 5 3
2625	7 5 5 5 3	4536	9 9 8 7	7546	11 7 7 7 2
2646	9 7 7 6	4608	9 8 8 8	7623	11 11 9 7
2662	11 11 11 2	4704	12 8 7 7	7744	11 11 8 8
2673	11 9 9 3	4725	9 7 5 5 3	7776	12 9 9 8
2688	8 8 7 6	4752	11 9 8 6	7875	9 7 5 5 5
2695	11 7 7 5	4802	7 7 7 7 2	7938	9 9 7 7 2
2744	8 7 7 7	4851	11 9 7 7	7986	11 11 11 6
2772	11 9 7 4	4928	11 8 8 7	8019	11 9 9 9
2816	11 8 8 4	5082	11 11 7 6	8064	9 8 8 7 2
2835	9 9 7 5	5103	9 9 9 7	8085	11 7 7 5 3
2904	11 11 8 3	5145	7 7 7 5 3	8192	8 8 8 4 4
2916	9 9 9 4	5184	9 9 8 8	8232	8 7 7 7 3
3024	9 8 7 6	5292	12 9 7 7	8316	12 11 9 7
3025	11 11 5 5	5324	11 11 11 4	8448	12 11 8 8
3072	8 8 8 6	5346	11 9 9 6	8506	9 9 7 5 3
3087	9 7 7 7	5376	12 8 8 7	8575	7 7 7 5 5
3125	5 5 5 5 5	5445	11 11 9 5	8624	11 8 7 7 2
3136	8 8 7 7	5488	8 7 7 7 2	8712	11 11 9 8
3168	11 9 8 4	5544	11 9 8 7	8748	12 9 9 9
3234	11 7 7 6	5625	9 5 5 5 5	9072	9 9 8 7 2
3267	11 11 9 3	5632	11 8 8 8	9075	11 11 5 5 3
3375	9 5 5 5 3	5775	11 7 5 5 3	9216	9 8 8 4 4
3388	11 11 7 4	5808	11 11 8 6	9261	9 7 7 7 3
3402	9 9 7 6	5832	9 9 9 8	9317	11 11 11 7
3456	9 8 8 6	5929	11 11 7 7	9375	5 5 5 5 5 3
3465	11 9 7 5	6048	12 9 8 7	9408	8 8 7 7 3
3528	9 8 7 7	6075	9 9 5 5 3	9504	12 11 9 8
3564	11 9 9 4	6125	7 7 5 5 5	9604	7 7 7 7 4
3584	8 8 8 7	6144	12 8 8 8	9625	11 7 5 5 5
3645	9 9 9 5	6174	9 7 7 7 2	9702	11 9 7 7 2
3675	7 7 5 5 3	6237	11 9 9 7	9801	11 11 9 9
3696	11 8 7 6	6272	8 8 7 7 2	9856	11 8 7 4 4
3773	11 7 7 7				

PLANE GEOMETRY.

THE ELEMENTS OF EUCLID : BOOKS I.—VI.

IN order to acquire clear conceptions of a *point*, a *line*, and a *surface*, with the definitions of which Euclid sets out, it will be best for the learner to consider them, at first, in connection with a *solid*; that is, with something that has *length*, *breadth*, and *thickness*. All external objects—things that can be seen and felt—are *solids*; and however small the solid may be, it must have some length, some breadth, and some thickness: using these terms in their ordinary acceptation—that is, in the sense in which they are used in common discourse.

The *boundaries* of a solid are called the *surface*, or the *superficies*, of the solid; and, as a *boundary*, cannot have *thickness*; because, if it had, it would be a *part* of the solid, and not a *side*, or *face*, or *boundary* of it: it follows that a surface can have *length* and *breadth* only.

Again: the surface itself has its boundaries, or limits: *these* boundaries are called *lines*: and as a *boundary* of a surface cannot have either breadth or thickness, since it is no *part* of the surface, much less a part of the solid, it follows that a line has *length* only.

Lastly, a line has its limits—a beginning and a termination: we speak of these, in common language, as the *ends* of the line. Euclid calls them *points*; and it is plain that a point, being no *part* of the line, cannot have length; and as breadth and thickness are excluded even from the line itself, it follows that a point has no dimensions or *magnitude*. It merely indicates *position*; the position, namely, of the commencement or termination of a line.

Euclid frequently speaks of taking a point *in* a line, without meaning an *extremity* of the line; but we may conceive a line to be crossed, or cut by other lines, and thus to be divided into shorter portions. Each portion has its *extremities*; so that we may conceive as many points in the line as we please. We cannot represent *length only* to the eye; it is necessary, therefore, in contemplating the black marks on paper, by which lines are represented, entirely to disregard the *breadth* of them; and to fix the attention upon the *length alone*: the eye may see breadth and thickness; the *mind* takes note of length only.

BOOK I.

DEFINITIONS.

I.

A *point* has no magnitude: it has *position* only.

II.

A *line* is *length* only.

III.

A *straight line* is that which lies *evenly* between its extreme points.

It is distinguished by uniformity of direction: a *straight line* is a *stretched line*.

IV.

A *surface*, or *superficies*, is that which has length and breadth only.

V.

Therefore the boundaries of a surface are *lines*.

VI.

A *plane surface*, or simply a *plane*, is that in which, whatever two points be taken, the straight line, having these points for extremities, lies *wholly* in that surface.

VII.

A *plane rectilineal angle* is the *opening* between two straight lines, which meet together, but which do not unite so as to form one continued straight line.

Thus the two straight lines AB , CB , meet each other in the point B , forming an *opening*, of which BA and BC are the boundaries, or limits: this opening is called a *plane rectilineal angle*, or simply an *angle*.

The two straight lines AB , CB , in the second representation, also meet each other; but they form no *opening* or *angle*; they unite in forming a continued straight line, AC .

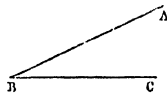
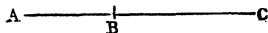

An angle is sometimes referred to by simply naming

the letter, placed at the point in which the lines forming the angle meet: in this way reference is made to the angle B , or the angle F , meaning the opening between BA , BC , or that between FD , FE . But if there be two or more openings, or angles, at the same point, this mode of reference will not do: the *sides*, or *boundaries*, of the particular one of those angles meant, must also be pointed out. Thus, if we wish to refer to the angle whose sides are BG , BH , attention must, in some way, be distinctly directed to these sides; because, as there are several angles at B , a reference to this point *alone* would be insufficient. The plan adopted is this: not only the letter (B) at the *vertex* of the angle, as this point is called, is used, but the other two letters (G , H) which mark the *sides* of the angle—the former letter being always placed *between* these two. Thus GBH , or HBG , means the angle whose *vertex* is B , and whose sides are BG , BH . In like manner ABH , or HBA , refers to the angle whose *vertex* is B , and whose sides are BA , BH : but there is no necessity to use three letters to denote an angle when there are no other angles at the same point or *vertex*.

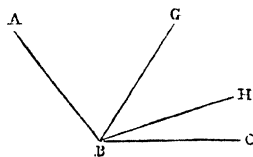
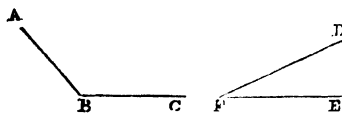

VIII.

When a straight line (AB) standing on another straight line (CD) makes the adjacent angles (ABC , ABD) equal to one another, each of the angles is called a *right angle*; and the straight lines are said to be *perpendicular* to each other.

Thus the two lines, AB , CD , are perpendicular to each other.

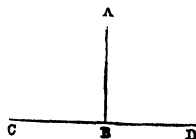

IX.

An *obtuse angle* is that which is greater than a right angle.



X.

An *acute angle* is that which is less than a right angle.



XI.

A *figure* is that which is enclosed by one or more boundaries.

XII.

A *circle* is a plane figure enclosed by one line, which is called the *circumference* of the circle: it is such, that all straight lines, drawn from a certain point within the figure to the circumference, are equal to one another.

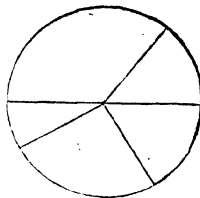

XIII.

This point is called the *centre* of the circle.

And any line drawn from the centre to the circumference is called a *radius* of the circle.

XIV.

A *diameter* of a circle is a straight line drawn through the centre, and terminated both ways by the circumference.

A radius is therefore half the diameter, or a *semidiameter*.

XV.

A *semicircle* is the figure contained by a diameter and the part of the circumference cut off by the diameter.

XVI.

Rectilineal figures are those which are enclosed by straight lines only.

XVII.

Trilateral figures, or *triangles*, are enclosed by three straight lines.

XVIII.

Quadrilateral figures, by four straight lines.

XIX.

Multilateral figures, or *polygons*, by more than four straight lines.

The term polygon, however, is often employed as a general name for rectilineal figures of all kinds, without regard to the number of the sides; so that the rectilineal figures defined above may, without impropriety, be called polygons of three and of four sides respectively.

XX.

An *equilateral triangle* is that which has its three sides equal.



XXI.

An *isosceles triangle* has two of its sides equal.



XXII.

A *scalene triangle* has its three sides unequal.



XXIII.

A *right-angled triangle* has one of its angles a right angle.

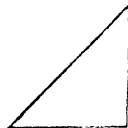

XXIV.

An *obtus-angled triangle* has one of its angles *obtusae*, or greater than a right angle.

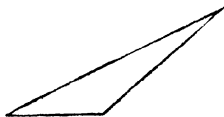

XXV.

An *acute-angled triangle* has each of its angles *acute*, or less than a right angle.



XXVI.

Of four-sided figures, a *square* is that which has all its sides equal, and all its angles right angles.

If the four sides are *equal*, and only *one* of the angles affirmed to be right, the other three angles must be right, of necessity, as will be hereafter proved; this definition is therefore *redundant*.



XXVII.

A *rectangle* is that which has all its four angles right angles, whether its sides be equal or not.

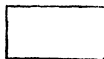

XXVIII.

A *rhombus* is that which has all its sides equal, but its angles are not right angles.



XXIX.

A *rhomboid* is that which has its opposite sides equal to one another, but all its sides are not equal, nor its angles right angles.



XXX.

Parallel straight lines are such as are in the same plane, and which, being produced ever so far both ways, do not meet.

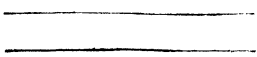

XXXI.

If each pair of opposite sides of a quadrilateral be parallel lines, the figure is called a *parallelogram*.

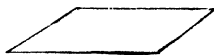

It will be seen hereafter that squares, rectangles, rhombuses, and rhomboids, are all *parallelograms*.

XXXII.

All other four-sided figures, besides those here defined, are called *trapeziums*.

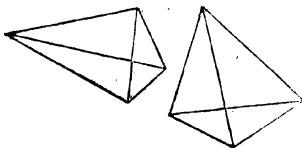

XXXIII.

A line drawn across a figure, joining two opposite corners, or *vertices*, is called a *diagonal*.

POSTULATES.

I.

Let it be granted that a straight line may be drawn from any one point to any other point.

II.

That a terminated straight line may be prolonged to any length in a straight line.

III.

And that a circle may be described from any centre, at any distance from that centre.

AXIOMS.

I.

Things which are equal to the same thing are equal to one another.

II.

If equals be added to equals, the wholes will be equal.

III.

If equals be taken from equals, the remainders will be equal.

IV.

If equals be added to unequals, the wholes will be unequal.

V.

If equals be taken from unequals, the remainders will be unequal.

VI.

Things which are double of the same are equal to one another.

VII.

Things which are halves of the same are equal to one another.

VIII.

Magnitudes which coincide, or which may be conceived to coincide, with one another, are equal.

IX.

The whole is greater than its part.

X.

Two straight lines cannot enclose a space.

XI.

All right angles are equal to one another.

MARKS AND SIGNS USED FOR ABBREVIATION.

$=$ is the sign of equality, and signifies that the quantities between which it is placed are equal.

$+$ is the sign of addition, and signifies that the quantities between which it is placed are to be added.

$-$ is the sign of subtraction, and implies that the quantity after it is to be subtracted from the quantity before it.

\therefore stands for the word *therefore*, or *consequently*.

Besides these marks the following contractions are also frequently used; namely, *ax.* for *axiom*; *post.* for *postulate*; *prob.* for *problem*; *theo.* for *theorem*; *prop.* for *proposition*; *const.* for *construction*; and *hyp.* for *hypothesis*. Q. E. D. stands for "*Quod erat demonstrandum*," which was to be demonstrated.

PROPOSITION I.—PROBLEM.

To describe an equilateral triangle (A B C) upon a given finite straight line (A B).

* Post. 3. With centre A, and radius AB, describe the circle BCD;* and with centre B, and the same radius, BA, describe the circle ACE.

From C, the point in which the circles cut each other,

* Post. 1. draw CA, CB,* the triangle ABC shall be equilateral.

+ Def. 12. Because A is the centre of the circle BCD,

* Ax. 1. $AC = AB$,† and because B is the centre of the circle ACE, $BC = AB$, $\therefore AC = BC$;* so that AC, BC, AB, are equal to one another, consequently the triangle ABC is equilateral, and it is described upon AB, which was to be done.

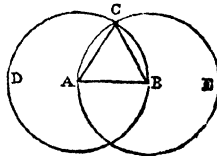

PROPOSITION II.—PROBLEM.

From a given point (A) to draw a straight line (AL) equal to a given straight line (BC).

* Post. 1. From A to B draw AB,* and upon AB describe the equilateral tri-

* Pr. 1. angle BDA.* With centre B, and radius BC, describe the circle
 † Post. 3. CGH,† and produce DB to meet it in
 G. Again: with D as centre, and DG as radius, describe
 the circle GKL, and produce DA to meet it in
 * Post. 2. L;* AL shall be equal to BC.
 Because B is the centre of the circle CGH, BC =
 † Def. 12. BG.†
 Because D is the centre of the circle GKL, DL =
 DG.

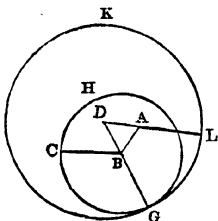

* Const. But DA, DB, parts of DL, DG, are also equal,*
 † Ax. 3. ∴ the remainders, AL, BG, are equal; † so
 that AL, BC are each equal to BG, and are, consequently,
 * Ax. 1. equal to each other.* Wherefore, from the given point, A, a straight
 line, AL, has been drawn equal to BC. Which was to be done.

PROPOSITION III.—PROBLEM.

From the greater (AB) of two given straight lines (AB and C), to cut off a part equal
 to the less (C).

* Pr. 2. From A draw AD = C,* and with
 centre A, and radius AD, describe the circle
 † Post. 3. DEF,† cutting off AE from AB:
 AE shall be = C.

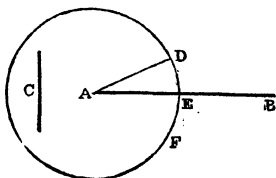

Because A is the centre of the circle DEF,
 * Def. 12. AE = AD.* But C = AD, † ∴ AE = C;
 † Const. and C are each = AD, ∴ AE = C;* so
 * Ax. 1. that from the greater line, AB, a
 part, AE, has been cut off, equal to the less, C. Which
 was to be done.

PROPOSITION IV.—THEOREM.

If two triangles (ABC, DEF) have two sides (AB, AC) of the one equal to two sides
 (DE, DF) of the other, each to each; that is, AB = DE, and AC = DF, and have
 likewise the angles contained by those sides equal, that is, the angle A = the angle D, then
 their bases or third sides (BC, EF) shall be equal, and also their other angles each to
 each, namely, those to which the equal sides are opposite, that is, the angle B = the angle
 E, and the angle C = the angle F; the surfaces of the triangles shall also be equal.

For, conceive the triangle ABC to be laid upon, or applied to, the triangle DEF
 so that the point A may be on D, and the line AB
 on DE; then the point B shall fall on E, be-

* Hyp. cause AB = DE.* And AB thus
 coinciding with DE, AC must fall on DF,

† Hyp. because the angle A = the angle D; †
 also the point C must fall on F, because AC =

* Hyp. DF.* But B was proved to coin-
 cide with E; and since B coincides with E, and
 C with F, the base BC must coincide with the

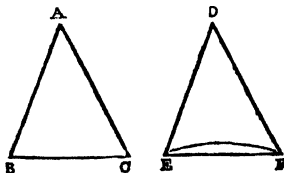

base EF, otherwise the two straight lines BC, EF, thus made to coincide at their
 † Ax. 10. extremities, would inclose a space, which is impossible; † ∴ the base

* Ax. 8. BC , coinciding with the base EF , is equal to EF .* Moreover, since the two lines $A B, B C$ coincide with the two $D E, E F$, the angle B coincides with the angle E ; and since the two lines $A C, C B$ coincide with the two $D F, F E$, the angle C coincides with the angle F ; \therefore the angle $B =$ the angle E , and the angle $C =$ the

* Ax. 8. angle F .* And as the triangle $A B C$ thus coincides, in every respect, with the triangle $D E F$, the surfaces of the triangles must be equal; \therefore if two triangles, &c. Q. E. D.

PROPOSITION V.—THEOREM.

The angles ($A B C, A C B$) at the base ($B C$) of an isosceles triangle ($A B C$) are equal; and if the equal sides ($A B, A C$) be prolonged, the angles ($D B C, E C B$) upon the other side of the base shall be equal.

In $B D$ take any point, F , and from $A E$, the greater, cut off $A G = A F$, the less;* and draw $F C, G B$.

† Const. Because $F A = G A$,† and $A C = A B$ * $\therefore F A, A C$ are equal to $G A, A B$.

* Hyp. each to each; and the angle A is common to both the triangles $A F C, A G B$; $\therefore F C = G B$,† the angle † Pr. 4. $A C F =$ the angle $A B G$,† and the angle $A F C =$ the angle $A G B$,† these being the angles to which the equal sides are opposite.

Again: because the whole $A F =$ the whole $A G$, and that the parts $A B, A C$ are equal, the remainders $B F, C G$

* Ax. 3. are equal;* and it was proved that $F C = G B$, \therefore the two sides $B F, F C$, are equal to the two $C G, G B$, each to each: it was also proved that the angle $B F C =$ the

† Pr. 4. angle $C G B$, \therefore the angle $F B C =$ the angle $G C B$,† and the angle $B C F =$ the angle $C B G$. And since it was demonstrated that the whole angle $A B G =$ the whole angle $A C F$, the parts of which, the angles $C B G, B C F$, are also

* Ax. 3. equal, \therefore the remaining angle $A B C =$ the remaining angle $A C B$.* These are the angles at the base of the isosceles triangle $A B C$, and the angles $F B C, G C B$, before proved to be equal, are the angles on the other side of the base. Therefore the angles at the base, &c. Q. E. D.

COROLLARY.—Every equilateral triangle is equiangular.

PROPOSITION VI.—THEOREM.

If two angles ($A B C, A C B$) of a triangle are equal, the sides ($A C, A B$) which subtend, or are opposite to, the equal angles shall be equal.

For, if $A B$ be not equal to $A C$, one of them, as $A B$, must be the * Pr. 3. greater. Let a part $B D$, equal to $A C$, the less, be cut off,* and draw $D C$. Then, because in the triangles $D B C, A C B$, $D B = A C$, and $B C$ common to both, the two sides $D B, B C$ are = the two sides $A C, C B$, each to each; and the angles $D B C, A C B$ are

* Hyp. equal,* \therefore the triangle $D B C =$ the triangle $A C B$,†

† Pr. 4. a part to the whole, which is absurd. Therefore, $A B, A C$ are not unequal—that is, they are equal; \therefore if two angles, &c. Q. E. D.

Cor.—Every equiangular triangle is equilateral.

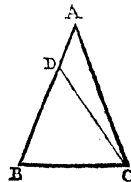
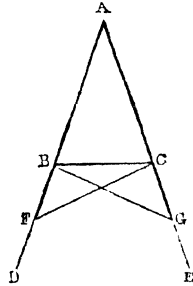

PROPOSITION VII.—THEOREM.

Upon the same base (AB), and on the same side of it, there cannot be two triangles (ACB, ADB), having their sides (AC, AD), which are terminated in one extremity of the base, equal to one another, and likewise (BC, BD) those which are terminated in the other extremity.

Join CD: then, in the case in which the vertex of each triangle is without the

* Hyp. other triangle, because $AC = AD$,* the angle
 + Pr. 5. $\angle ACD = \angle ADC$.† But the angle $\angle ACD$ is greater than the angle $\angle BCD$, which is only a part of it; \therefore the angle $\angle ADC$ is greater also than $\angle BCD$: much more, then, is the angle $\angle BDC$ greater than $\angle BCD$. Again: because $BC =$
 * Hyp. BD ,* the angle $\angle BDC = \angle BCD$;† but it has
 + Pr. 5. been demonstrated to be greater than $\angle BCD$, which is impossible, \therefore in this case it is impossible that $AC = AD$, and likewise $BC = BD$.

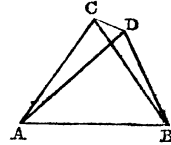

But if one of the vertices, as D, be within the other triangle, prolong AC, AD

* Hyp. to E, F. Then, because $AC = AD$ * in the triangle $\triangle ACD$, the angles $\angle ECD, \angle FDC$, upon the other
 + Pr. 5. side of the base CD, are equal;† but the
 * Ax. 9. angle $\angle ECD$ is greater than $\angle BCD$,* $\therefore \angle FDC$ is likewise greater than $\angle BCD$: much more, then, is $\angle BDC$ greater
 + Hyp. than $\angle BCD$. Again: because $BC = BD$,† the
 * Pr. 5. angle $\angle BDC = \angle BCD$;* but $\angle BDC$ was proved greater than $\angle BCD$, which is impossible, \therefore in this case also it is impossible that $AC = AD$, and likewise $BC = BD$.

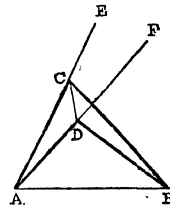

The case in which the vertex of one triangle is upon a
 + Ax. 9. side of the other, needs no demonstration.†
 Therefore, upon the same base, &c. Q. E. D.

PROPOSITION VIII.—THEOREM.

If two triangles (ABC, DEF) have two sides (AB, AC) of the one equal to two sides (DE, DF) of the other, each to each, and have likewise their bases or third sides (BC, EF) equal, then the angle (A) contained by the two sides of the one shall be equal to the angle (D) contained by the two sides equal to them of the other.

For if the triangle ABC be applied to DEF, so that the point B may be on E, and BC on EF, the point C shall coincide

* Hyp. with F, because $BC = EF$.*
 And BC thus coinciding with EF, BA and AC must coincide with ED and DF; for if the base BC, coinciding with EF, the sides BA, AC could fall otherwise than on ED, DF, and have different situations, as EG, GF, then upon the same base EF, and on the same side of it, there

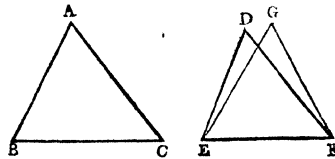

could be two triangles having the sides ED, EG, terminated in one extremity of the base, equal to one another, and likewise the sides FD, FG terminated in the other
 + Pr. 7. extremity. But this is impossible;† \therefore if the bases coincide, the remaining

sides cannot but coincide, and \therefore the angle A must coincide with the angle D, and be equal

* Ax. 8. to it.* Therefore, if two triangles, &c. Q. E. D.

PROPOSITION IX.—PROBLEM.

To bisect a given rectilineal angle (BAC); that is, to divide it into two equal angles.

* Pr. 3. Take any point D in AB, and from AC cut off $AE = AD$:* draw DE, and

† Pr. 1. upon it describe an equilateral triangle DEF,† so that the vertex F may be on the opposite side of DE to the vertex A. Draw AF, then AF shall bisect the angle BAC.

* Const. Because $AD = AE$,* and that AF is common to the two triangles DAF, EAF: the two sides DA, AF are = the two sides EA, AF, each to each, and the base DF = the base EF; \therefore the angle DAF

* Pr. 8. = the angle EAF;* \therefore the given angle BAC is bisected by the straight line AF. Which was to be done.

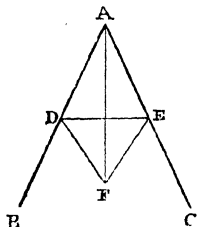

PROPOSITION X.—PROBLEM.

To bisect a given finite straight line (AB); that is, to divide it into two equal parts.

* Pr. 1. Upon AB describe an equilateral triangle ABC,* and bisect the angle

† Pr. 9. ACB by the straight line CD;† AB shall be cut into two equal parts in the point D.

Because $CA = CB$, and CD common to the two triangles ACD, BCD, the two sides CA, CD are = the two CB, CD, each to each; and the angle ACD = the angle BCD; \therefore the base AD = the

* Pr. 4. base BD;* \therefore the given line AB is divided into two equal parts in the point D. Which was to be done.

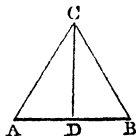

PROPOSITION XI.—PROBLEM.

To draw a straight line at right angles to a given straight line (AB), from a given point (C) in it.

Take any point D in AC, and make $CE = CD$. Upon DE describe an equilateral

* Pr. 1. triangle DFE,* and draw CF; CF shall be at right angles to AB.

Because $DC = EC$, and that FC is common to the two triangles DCF, ECF; the two sides DC, CF are = the two EC, CF, each to each, and the base DF = base EF; \therefore the angle DCF

* Pr. 8. = angle ECF,* and they are adjacent angles. But when the adjacent angles which one straight line makes with another are equal,

† Def. 8. each is called a right angle;† \therefore from the given point C in the given straight line AB, a straight line CF has been drawn at right angles to AB. Which was to be done.

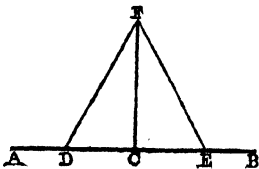

PROPOSITION XII.—PROBLEM.

To draw a straight line perpendicular to a given straight line (A B) of unlimited length, from a given point (C) without it.

Take any point D upon the other side of A B, and with centre C and radius C D
 * Post. 3. describe the circle E G F *
 meeting A B in F, G; bisect F G in H, †
 † Pr. 10. and join C, H.

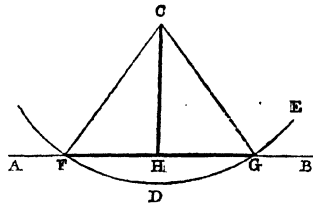

The straight line C H shall be perpendicular to A B.

Draw C F, C G. Then because F H =
 * Const. G H,* and H C common to the
 two triangles F H C, G H C, the two sides
 F H, H C are = the two sides G H, H C,
 each to each, and the base C F = the base
 † Def. 12. C G; † ∴ the angle C H F = the
 * Pr. 8. adjacent angle C H G; * each of
 them is ∴ a right angle, † and consequently C H is perpendicular to
 † Def. 8. A B; † ∴ from the given point C a perpendicular C H to the given line A B
 has been drawn. Which was to be done.

PROPOSITION XIII.—THEOREM.

The angles which one straight line (A B) makes with another (D C) upon one side of it, are either two right angles, or are together equal to two right angles.

For the angle A B C is either equal to A B D, or it is not.

* Def. 8. If A B C be = A B D, each is a right angle.* But if they are not equal,
 from B draw B E at right angles to

† Pr. 11. D C; † then the angles
 E B C, E B D are right angles, also
 E B C = E B A + A B C. To each
 of these equals add E B D, ∴ E B C
 + E B D = E B D + E B A +

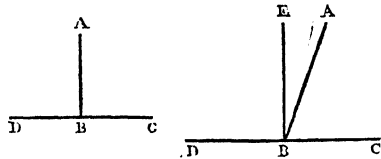

* Ax. 2. A B C.* Again: A B D
 = E B D + E B A. Add A B C to
 each of these equals, ∴ A B D +
 A B C = E B D + E B A +

+ Ax. 2. A B C; † but it was demonstrated that E B C + E B D are equal to the
 * Ax. 1. latter three angles, ∴ A B D + A B C = E B D + E B C: * that is, the two
 angles A B D, A B C are together equal to two right angles.

Therefore the angles which one straight line, &c. Q E D.

Cor. 1.—It is manifest from this, that if two straight lines cross one another, forming four angles at the point of intersection, these four angles are together equal to four right angles.

Cor. 2.—And moreover, that if in a straight line any point between its extremities

be taken. from which any number of straight lines are drawn, some on one side and some on the other, all the angles thus made at the point will together be equal to four right angles; those on one side of the proposed line being together equal to two right angles, and those on the other side equal also to two right angles.

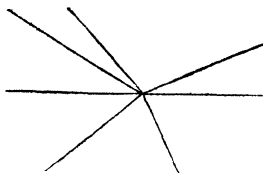

PROPOSITION XIV.—THEOREM.

If at a point (B) in a straight line (AB) two other straight lines (BC, BD), upon opposite sides of it, make the adjacent angles (ABC, ABD) together equal to two right angles, the two straight lines (BC, BD) shall be in one and the same straight line.

For, if BD be not in the same straight line with CB, let BE be in the same straight line with it. Then because AB makes, with the straight line CBE upon one side of it, the angles ABC, ABE, these are together = two right

* Pr. 13. angles.* But ABC, ABD are

† Hyp. likewise together = two right angles,†

* Ax. 1. ∴ ABC + ABE = ABC + ABD.*

Take away the common angle ABC, and there

† Ax. 3. remains ABE = ABD,† the less

to the greater, which is impossible; ∴ BE is not

in the same straight line with BC. And in like manner may it be proved that no line, except BD, can be the prolongation of CB; ∴ CB, BD are in one and the same straight line. Wherefore, if at a point, &c. Q. E. D.

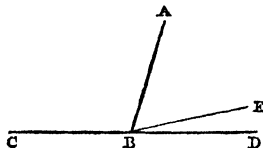

PROPOSITION XV.—THEOREM.

If two straight lines (AB, CD) cut one another, the vertical (or opposite) angles shall be equal; that is, AEC = DEB, and CEB = AED.

The angles which AE makes with CD, on one side of it, are together equal to two

* Pr. 13. right angles;* that is, AEC +

AED = two right angles. Again: the angles

which DE makes with AB are also together

† Pr. 13. equal to two right angles;* that

is, DEA + DEB = two right angles; ∴

† Ax. 1. AEC + AED = DEA + DEB.† Take away the common angle

* Ax. 3. AED, and there remains AEC = DEB.* And in a similar manner it may be proved that CEB = AED. Therefore, if two straight lines, &c. Q. E. D.



PROPOSITION XVI.—THEOREM.

If one side (BC) of a triangle be prolonged, the exterior angle (ACD) shall be greater than either of the interior opposite (or more remote) angles (BAC, ABC).

* Pr. 10. Bisect AC in E,* draw BE, which prolong, and make EF = equal

† Pr. 3. BE:† join FC.

* Const. Because $AE=CE$,* and $EB=EF$;* $\therefore AE, EB$ are $=CE, EF$, each to each;
 † Pr. 15. and the angle $AEB=CEF$;† $\therefore AB$
 ‡ Pr. 4. $=CF$,‡ and the angle $A=ECF$:‡ but
 ACD is greater than ECF , $\therefore ACD$ is greater than A ; \therefore if one side, BC , of a triangle be prolonged, the exterior angle ACD is greater than the interior angle A opposite to the side prolonged: but if the side prolonged be AC , the exterior angle will be BCG , and the interior angle opposite, ABC ; $\therefore BCG$ is greater than ABC . But $ACD =$
 * Pr. 15. BCG ,* $\therefore ACD$ is greater than ABC ; and it was before proved that ACD is greater also than A , $\therefore ACD$ is greater than either of the interior opposite angles BAC, ABC . Therefore, if one side, &c. Q. E. D.

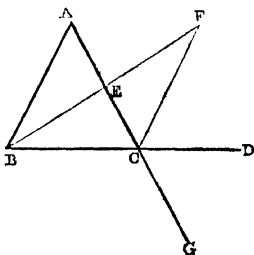

PROPOSITION XVII.—THEOREM.

Any two angles of a triangle (ABC) are together less than two right angles.

Prolong one of the sides, as BC to D ; then the exterior angle ACD is greater than

* Pr. 16. the interior opposite angle B .* To each of these add ACB ; then ACD, ACB are + Ax. 4. together greater than B, ACB ;† but ACD, ACB are together equal to two right

* Pr. 13. angles;* $\therefore B, ACB$ are together less than two right angles. And if BA be prolonged, it may be proved, in like manner, that A, B are together less than two right angles; or if CA be prolonged, that A and ACB are together less than two right angles. Therefore, any two angles, &c. Q. E. D.

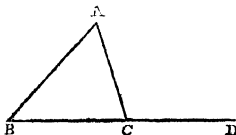

PROPOSITION XVIII.—THEOREM.

The greater side of every triangle (ABC) is opposite to the greater angle.

Let AC be greater than AB ; the angle ABC shall be greater than the angle C .

From AC the greater cut off $AD = AB$ the less, and draw BD . Then because ADB is an exterior angle of the triangle BDC , it is greater than

* Pr. 16. C ;* but $ADB = ABD$,† \therefore the angle † Pr. 5. ABD is likewise greater than C ; much more, then, is the angle ABC greater than C . Therefore, the greater side, &c. Q. E. D.

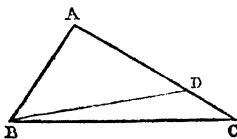

PROPOSITION XIX.—THEOREM.

The greater angle of every triangle (ABC) is subtended by the greater side, or has the greater side opposite to it.

Let the angle B be greater than C ; then AC shall be greater than AB .

For, if it be not greater, AC must either be equal to AB, or less than it. If it were equal,

* Pr. 5. the angle B would = C; * but it is not, \therefore AC is not = AB. If it were less, the angle

† Pr. 18. B would be less than C; † but it is not, \therefore AC is not less than AB; and it was shown that it is not equal to AB, \therefore AC is greater than AB, \therefore the greater angle, &c. Q. E. D.

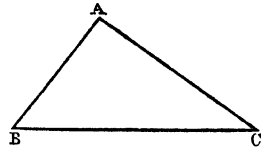

PROPOSITION XX.—THEOREM.

Any two sides (BA, AC) of a triangle (ABC) are together greater than the third side (BC).

* Pr. 3. Prolong one of the two sides, as BA, to D, and make AD = AC, * the other of the two sides: join D, C.

† Pr. 5. Because AD = AC, the angle ACD = D; † but the angle BCD is greater than ACD, \therefore BCD is greater than D. And because the angle BCD of the triangle DBC is greater than the angle D, and that the greater angle is sub-

* Pr. 19. tended by the greater side, * the side BD is greater than BC: but BD = BA + AD = BA + AC, \therefore BA + AC is greater than BC. Therefore any two sides, &c. Q. E. D.

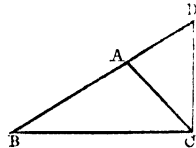

PROPOSITION XXI.—THEOREM.

If from the ends of a side of a triangle there be drawn two straight lines (BD, CD) to a point within the triangle, these shall be together less than the other two sides (AB, AC) of the triangle, but shall contain a greater angle.

Prolong BD to E. The two sides BA, AE of the triangle ABE are together

* Pr. 20. greater than BE. * To each of these unequals add EC, \therefore BA, AC are greater than BE, EC. Again: the two sides CE, ED of the triangle CED are together greater

† Pr. 20. than CD. † To each of these add DB, \therefore CE, EB are greater than CD, DB. But it was shown that BA, AC are greater than BE, EC; much more then are BA, AC greater than BD, DC. Again: the exterior angle BDC of

* Pr. 16. the triangle CDE is greater than CED; * and the exterior angle CEB of the triangle ABE is greater than BAC: * much more then is BDC greater than BAC. Therefore, if from the ends, &c. Q. E. D.

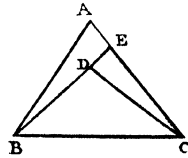

PROPOSITION XXII.—PROBLEM.

To make a triangle of which the sides shall be equal to three given straight lines (A, B, C),

* Pr. 20. each to each, but any two of these must be greater than the third. *

Take a straight line DE, terminated at the point D, but unlimited towards E, and make

† Pr. 3. DF = A, FG = B, and GH = C. †

With centre F and radius FD describe the circle DKL; and with centre G and radius GH describe the circle HKL, cutting the former in K. Draw KF, KG: the triangle KFG has its three sides equal to the three lines A, B, C.

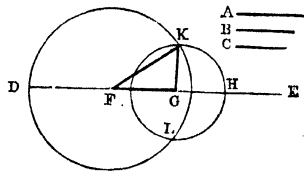

Because F is the centre of the circle DKL, $FD = FK$; but $FD = A$, $\therefore FK = A$. Again: because G is the centre of the circle LKH, $GH = GK$; but $GH = C$, $\therefore GK = C$; but $FG = B$, \therefore the sides of the triangle KFG are equal to A, B, C, each to each. Which was to be done.

NOTE.—It is plain that the circles could not cut unless their radii were together greater than the distance between their centres: if such were not the case, they would be wholly without one another. And if the distance of the centres, together with one radius, were smaller than or equal to the other radius, one circle would be wholly within the other: the hypothesis precludes both of these circumstances.

PROPOSITION XXIII.—PROBLEM.

At a given point (A) in a given straight line (AB) to make an angle equal to a given angle (C).

In CD, CE take any points D, E, one in each, and draw DE. Make the triangle AFG, the sides of which shall be equal to those of CDE, namely, $AF = CD$, $AG = CE$, and $FG =$

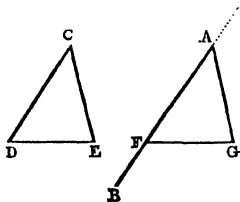

* Pr. 22. DE; * then the angle A shall be equal to C.

Because $AF = CD$, $AG = CE$, and $FG =$
* Pr. 8. DE, \therefore the angle A = the angle C, * \therefore at the given point, &c. Which was to be done.

PROPOSITION XXIV.—THEOREM.

If two triangles (ABC, DEF) have two sides (AB, AC) of the one equal to two sides (DE, DF) of the other, each to each, but the angle (BAC) contained by the two sides of one of them greater than the angle (EDF) contained by the two sides equal to them of the other; the base (BC) of that which has the greater angle shall be greater than the base (EF) of the other.

Of the two sides DE, DF, let DE be the side which is not greater than the other.

* Pr. 23. Make the angle EDG = A,* and

† Pr. 3. make $DG = AC$ or DF .† Draw EG, GF, and let H be the point where EG is cut, either by DF or by DF prolonged.

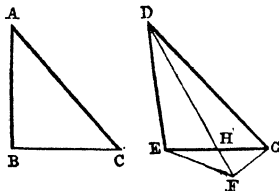

Because DE is not greater than DG, the angle

* Pr. 19. DGE is not greater than DEG; * but DHG is greater than DEG, \therefore DHG is greater than DGH, and \therefore DG is greater than

† Pr. 19. DH; † but $DF = DG$, \therefore DF is greater than DH, \therefore HGF is a part of DGF.

Again: the two sides BA, AC are = the two ED, DG, each to each, and the

* Hyp. & Const. angle $A = EDG$, * $\therefore BC = EG$. And because $DF = DG$, the † Pr. 5. angle $DFG = DGF$: † but it was proved that DGF is greater than EGF, \therefore DFG is greater than EGF; much more then is EFG greater than EGF, \therefore in the triangle FEG the angle EFG is greater than EGF, \therefore EG is greater than

* Pr. 19. EF; * but, as already proved, $EG = BC$, $\therefore BC$ is greater than EF. Therefore, if two triangles, &c. Q. E. D.

PROPOSITION XXV.—THEOREM.

If two triangles (ABC, DEF) have two sides (AB, AC) of the one equal to two sides (DE, DF) of the other, each to each, but the base (BC) of one greater than the base (EF) of the other, the angle (A) contained by the sides of that with the greater base shall be greater than the angle (D) contained by the sides equal to them of the other.

For if A be not greater than D , it must be either equal to it or less. A is not equal to D , for then

* Pr. 4. BC would be $= EF$; * but it is not.

A is not less than D , for then BC would be less than

* Pr. 24. EF ; * but it is not. † As therefore

† Hyp.

it is neither equal to nor less than D , A must be greater than D , \therefore if two triangles, &c. Q. E. D.

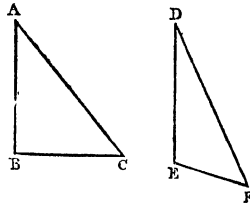

PROPOSITION XXVI.—THEOREM.

If two triangles (ABC, DEF) have two angles (B, C) of the one equal to two (E, F) of the other, each to each; and one side equal to one side, viz., either the sides (BC, EF) adjacent to the equal angles, or the sides (AB, DE) opposite to equal angles in each; then shall the other sides be equal, each to each, and also the third angle of the one to the third angle of the other.

First let $BC = EF$, the sides adjacent to the angles that are equal each to each. Then if AB, DE be unequal, one of them must be the greater. Let AB be the greater, and make

* Pr. 3. $BG = DE$, * and draw GC : then

† Hyp. because $BG = ED$, and $BC = EF$, †

and that the angle $B = E$, \therefore the angle $GCB =$

* Pr. 4. F ; * but the angle $ACB = F$, † \therefore

† Hyp. the angle $GCB = ACB$, the less to

the greater; which is impossible; $\therefore AB$ is not unequal to DE , that is, it is equal to it, \therefore in the two triangles ABC, DEF , the two sides AB, BC and the included angle B in the one, are respectively equal to the two sides DE, EF and the included angle E

* Pr. 4. in the other, $\therefore AC = DF$, and the angle $A = D$. *

Next let $AB = DE$, the sides opposite to equal angles; in this case, likewise, the other sides shall be equal, namely, $AC = DF$, and $BC = EF$; and also the angle $BAC = D$. For, if BC, EF be unequal, let BC be the greater, and make BH

* Pr. 3. $= EF$. * Join A, H : then because $BH = EF$, and $AB = DE$, the two $AB, BH = DE, EF$, each to each; and they contain equal

* Pr. 4. angles; $\therefore AH = DF$, * and the angle

† Hyp.

† Pr. 16. $BHA = EFD$: but $EFD = BCA$, † $\therefore BHA = BCA$, the exterior angle equal to the interior and opposite, which is impossible; * $\therefore BC$ is not unequal to EF , $\therefore BC = EF$: and $AB = DE$, \therefore the two $AB, BC = DE, EF$, each to each; and they contain equal angles, $\therefore AC = DF$, and $BAC = EDF$, \therefore if two triangles, &c. Q. E. D.

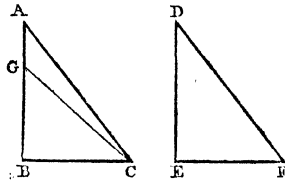

PROPOSITION XXVII.—THEOREM.

If a straight line (EF) falling upon two other straight lines (AB, CD) make the alternate angles (AEF, EFD) equal, these two straight lines shall be parallel.

For, if they be not parallel they will meet, when prolonged, either towards B, D, or towards A, C. Let them be prolonged and meet in the point G; then GEF will be a triangle, and its exterior angle AEF must

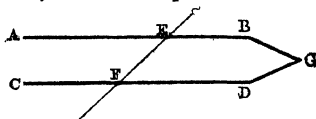

* Pr. 16. be greater than the interior and opposite angle EFG; * but it is also equal † Hyp. to it, † which is impossible; ∴ AB, CD, when prolonged, do not meet towards B, D. In like manner it may be proved that they do not meet towards A, C, ∴ * Def. 31. they are parallel, * ∴ if a straight line, &c. Q. E. D.

PROPOSITION XXVIII.—THEOREM.

If a straight line (EF) falling upon two other straight lines (AB, CD) make the exterior angle (EGB) equal to the interior and opposite angle (GHD) upon the same side of the line; or make the interior angles (BGH, GHD) upon the same side together equal to two right angles; the two straight lines (AB, CD) shall be parallel.

Because the angle EGB = the angle GHD, * and EGB = AGH, † ∴ AGH = * Hyp. GHD; and these are alternate angles, † Pr. 15. ∴ AB is parallel to CD. * † Pr. 27.

Again: because the angles BGH, GHD are together = two right angles, * and that AGH, * Hyp. BGH are together also = two right † Pr. 13. angles, † ∴ AGH + BGH = BGH + GHD. Take away BGH, then AGH = GHD; and these are alternate angles, ∴ AB is † Pr. 27. parallel to CD, * ∴ if a straight line, &c. Q. E. D.

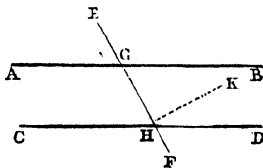

NOTE.—Propositions XXVII. and XXVIII. clearly prove the existence of parallel lines, or of lines such that, however far they be prolonged, they can never meet. And by aid of the first of these propositions, if a straight line be given, one parallel to it may always be drawn (see Prop. XXXI.) But, to proceed further in the doctrine of parallel lines, requires assent to a principle which must now be formally stated, and unhesitatingly admitted as true: it is the principle affirmed in Euclid's twelfth axiom. In most editions of Euclid, this is placed, with the other axioms, at the commencement of the Book. It has been here kept out of view till it can no longer be dispensed with; and this has been done because, in the first place, we should not be called upon to give assent to what concerns anything, of the possible existence of which there may be reasonable doubt: till he has reached Prop. XXVII. (which proposition is all-sufficient for the construction of Prop. XXXI.) the learner may fairly question whether it be possible for what are called parallel lines to exist: he now knows that parallel or never-meeting lines may be actually drawn.

In the next place, from the property demonstrated in Proposition XVII., namely, that any two angles of a triangle are together less than two right angles, he knows—what he could not know at an earlier stage of his progress—an important particular respecting a pair of meeting-lines, crossed by a third line, namely, that in a pair of

meeting-lines the two interior angles on one side of the crossing line are together *less than two right angles*; and, as a consequence (Prop. XXVIII.), that when these interior angles are together *equal to two right angles*, the lines crossed must be *non-meeting*, or *parallel lines*. It is the *converse* of the first-mentioned property that he is now to be called upon to receive as true; viz., that if a straight line, crossing a pair of lines, make the two interior angles, on the same side of it, together *less than two right angles*, the pair crossed shall be *meeting-lines*. This is the twelfth axiom, and is thus expressed in Euclid:—

AXIOM XII.—If a straight line meets two straight lines, so as to make the two interior angles, on the same side of it, taken together, *less than two right angles*, these straight lines, being prolonged, shall at length *meet* upon that side on which are the angles that are less than two right angles.

The propositions already referred to enable us to see distinctly what it is that this axiom assumes, and moreover inform us that the assumption is, at least, perfectly *consistent with demonstrated truth*; and that it itself is necessarily true, must be admitted, upon reflecting for a moment upon that peculiarity of a *straight line*, really implied in its designation, though not expressly adverted to in its definition—*its undeviating sameness of direction*.

It is obvious, from this uniformity of direction, that if two straight lines, however far prolonged, *never meet*, then, at no part of their course, can either make any approach towards the other; for if two straight lines *approach* one another, their continuance in the same undeviating directions necessitates their *meeting*, if indefinitely prolonged. We cannot doubt this, and yet have an accurate conception of an unlimited straight line; since *uniformity of direction* must enter that conception. It follows, therefore, that parallel lines must be, throughout, *equidistant lines*. But two *distinct* straight lines, through the same point, cannot be throughout equally distant from a third; so that two straight lines, through the same point, cannot *both* be parallel to the same straight line. It has been seen (Prop. XXVIII.) that one (C D) is parallel to another (A B), if the interior angles (B G H, D H G) be *equal to two right angles*; a *second* (H K), which would cause the interior angles (B G H, K H G) to be *less than two right angles*, being a distinct line from C D, must therefore *meet* A B if prolonged. And this is the assertion of the twelfth axiom.

PROPOSITION XXIX.—THEOREM.

If a straight line (E F) fall upon two parallel straight lines (A B, C D) it makes the alternate angles (A G H, G H D) equal; and the exterior angle (E G B) = the interior and opposite (G H D) upon the same side; and likewise the two interior angles (B G H, G H D) upon the same side together = two right angles.—[See the preceding diagram.]

For if A G H be not = G H D, one of them, as A G H, must be the greater. Add the angle B G H to each of them, ∴ A G H + B G H are greater than B G H + G H D.

* Pr. 13. But A G H + B G H = two right angles,* ∴ B G H + G H D are less
+ Ax. 12. than two right angles, ∴ A B, C D, if prolonged, will meet,† which is impossible, since (by hypothesis) they are parallel; ∴ A G H is not unequal to G H D,

* Pr. 15. that is, it is equal to it. Again: A G H = E G B,* ∴ E G B = G H D. Add to each of these B G H, ∴ E G B + B G H = G H D + B G H; but E G B +

+ Pr. 13. B G H = two right angles,† ∴ B G H + G H D = two right angles; ∴ if a straight line, &c. Q. E. D.

PROPOSITION XXX.—THEOREM.

Straight lines (AB, CD) which are parallel to the same straight line (EF) are parallel to each other.

Let the straight line GHK cut AB, EF, CD: then, because AB is parallel to EF, the

* Pr. 29. angle AGK = GHF,* and because EF, CD are also parallel, the angle

† Pr. 29. GHF = GKD, †. AGK = GKD,

* Pr. 27. ∴ AB is parallel to CD,* ∴ straight lines, &c. Q. E. D.

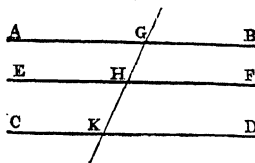

PROPOSITION XXXI.—PROBLEM.

To draw a straight line through a given point (A) parallel to a given straight line (BC).

In BC take any point D: join AD; and at the point A in AD make the angle * Pr. 23. DAE = ADC;* and prolong EA to F; then EF shall be parallel to BC.

Because AD, falling upon EF, BC, makes the alternate angles EAD, ADC equal, EF is parallel to BC,*

* Pr. 27. ∴ through the given point A a line EF parallel to BC is drawn. Which was to be done.

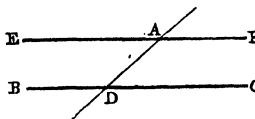

PROPOSITION XXXII.—THEOREM.

If a side (BC) of a triangle (ABC) be prolonged, the exterior angle (ACD) is = the two interior and opposite angles (A, B); and the three interior angles of every triangle are together = two right angles.

* Pr. 31. Through C draw CE parallel to AB;* then the alternate angles † Pr. 29. BAC, ACE are equal; † and because BD falls upon the said parallels, the exterior angle ECD is = the interior and opposite

* Pr. 29. angle ABC;* and it was proved that ACE = BAC, ∴ the whole exterior angle ACD = A + B, both the interior and opposite angles. To each of these equals add ACB, ∴ ACD + ACB = A + B + ACB: but ACD + ACB = two right

* Pr. 13. angles,* ∴ the three angles of the triangle are = two right angles, ∴ if a side of a triangle, &c. Q. E. D.

Cor. 1.—All the interior angles of any rectilinear figure, together with four right angles, are = twice as many right angles as the figure has sides.

For, any rectilinear figure ABCDE can be divided into as many triangles as the figure has sides, by drawing straight lines from a point F within the figure to each of its vertices. And, by the preceding prop., all the angles of these triangles are = twice as many right angles as there are triangles; that is, as there are sides of the figure. But these same angles are equal to the angles of the figure together with the angles at F, the common vertex of the triangles; that is, together

* Pr. 13. with four right angles,* ∴ all the angles of the figure, together with

Cor. 2. four right angles, are = twice as many right angles as the figure has sides.

For, any rectilinear figure ABCDE can be divided into as many triangles as the figure has sides, by drawing straight lines from a point F within the figure to each of its vertices. And, by the preceding prop., all the angles of these triangles are = twice as many right angles as there are triangles; that is, as there are sides of the figure. But these same angles are equal to the angles of the figure together with the angles at F, the common vertex of the triangles; that is, together

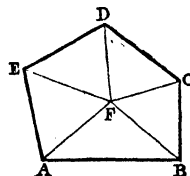

* Pr. 13. with four right angles,* ∴ all the angles of the figure, together with

Cor. 2. four right angles, are = twice as many right angles as the figure has sides.

COR. 2.—All the *exterior angles* of any rectilinear figure are together = four right

Because every interior angle ABC , with its adjacent exterior angle ABD , is = * Pr. 13. two right angles, * \therefore all the interior + all the exterior are = twice as many right angles as there are sides to the figure; that is, by the above corollary, to all the interior angles + four right angles, \therefore all the exterior angles are = four right angles.

This remarkable property can scarcely fail to arrest the student's special attention; as, previously to its demonstration, he would be little likely to expect that if the sides of a rectilinear figure be prolonged, one after another, the exterior angles thus formed would have the same amount whether the figure had three sides, or three thousand.

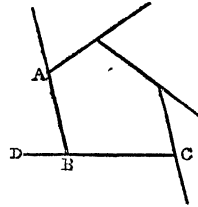

PROPOSITION XXXIII.—THEOREM.

The straight lines (AC, BD) which join the extremities of two equal and parallel straight lines (AB, CD) towards the same parts, are also themselves equal and parallel.

Draw BC , which joins the extremities of the parallels towards opposite parts; then the

* Pr. 29. alternate angles ABC, BCD are equal.*
And because $AB = CD$, and BC common to the two triangles ABC, DCB , the two sides AB, BC and the included angle are respectively = the two DC, CB and the included angle; $\therefore AC = BD$,†
† Pr. 4. CB and the included angle; $\therefore AC = BD$,† and the angle $ACB = DCB$; and these are alternate

* Pr. 27. angles, $\therefore AC$ is parallel to BD ; * and it was shown that $AC = BD$; \therefore the straight lines, &c. $Q. E. D.$

PROPOSITION XXXIV.—THEOREM.

The opposite sides and angles of a parallelogram $ACDB$ are equal, and the diagonal (BC) bisects it; that is, divides it into two equal parts.

DEF.—A parallelogram is a four-sided figure, of which the opposite sides are parallel; and the diagonal is the straight line joining two of its opposite vertices.

Because AB is parallel to CD , and BC meets

* Pr. 29. them, the angle $ABC = DCB$; * and because AC is parallel to BD , and BC meets them,

† Pr. 29. the angle $ACB = DBC$,† \therefore the two triangles ABC, DCB have two angles ABC, ACB , in the one = DCB, DBC , in the other, each to each,

and the side BC , adjacent to the equal angles, common to the two triangles; $\therefore AB =$

* Pr. 26. CD , and $AC = BD$; and the angle $A = D$. * Again: because the angle $ABC = DCB$, and the angle $DBC = ACB$, \therefore the whole angle $ABD =$ the whole angle ACD ; and it was proved that $A = D$, \therefore the opposite sides and angles of a parallelogram are equal. Also the diagonal bisects it: for it has been shown that the triangle ACB has two sides, and the included angle $A =$ respectively to two sides, and the included

* Pr. 4. angle D in the triangle DBC , \therefore these triangles are equal, * \therefore the diagonal BC divides the parallelogram into two equal parts.

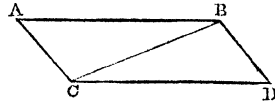

PROPOSITION XXXV.—THEOREM.

Parallelograms (ABCD, EBCF) *upon the same base* (BC) *and between the same parallels* (AF, BC) *are equal.*

Suppose, first, that the sides AD, EF, opposite to the base BC, terminate in the same point D; then, since each

* Pr. 34. parallelogram is double of the triangle BDC,* the parallelograms are equal.

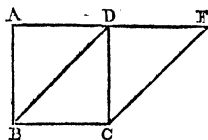

Next, let the sides AD, EF terminate in different

Pr. 34. points, D, E; then AD=BC, and EF=BC,† ∴ AD=EF, and DE is common, ∴ the whole, or remainder, AE=the whole, or remainder, DF: also AB

* Pr. 34. =DC,* ∴ AE, AB =DF, DC, each to each; also

† Pr. 29. the angle A=FDC,†

∴ the triangle EAB=triangle FDC. Take the triangle EAB from the trapezium ABCF, and from the same trapezium take the equal triangle FDC: the remainders must be equal; that is, the parallelogram EBCF=the parallelogram ABCD; ∴ parallelograms upon the same base, &c. Q. E. D.

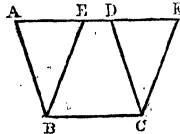
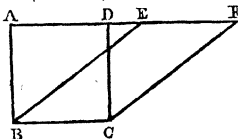

PROPOSITION XXXVI.—THEOREM.

Parallelograms (ABCD, EFGH) *upon equal bases* (BC, FG) *and between the same parallels* (AH, BG) *are equal.*

Draw BE, CH. Then because BC=FG, and FG=EH; ∴ BC=EH; and these are parallels, and joined towards the same parts by BE, CH, ∴ EB, HC are equal and paral-

* Pr. 33. lel,* ∴ EBCH is a parallelogram†

† Pr. 34. and it is =ABCD,* also EBCH

Def. =EFGH,* ∴ the parallelogram

ABCD =EFGH, ∴ parallelograms upon equal bases, &c. Q. E. D.

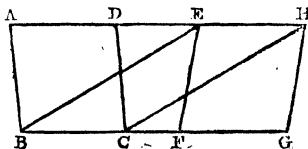

PROPOSITION XXXVII.—THEOREM.

Triangles (ABC, DBC) *on the same base* (BC) *and between the same parallels* (EF, BC) *are equal.*

This proposition is only a particular case of that which follows; and as the particular is not made use of in the more general demonstration, it may be omitted, as quite superfluous. Prop. XXXVIII. proves that triangles between the same parallels are equal, provided only that their bases are equal, without any restriction as to whether the bases coincide or not. Whatever is proved as to equal things is, of course, proved when the things are not only equal, but identical. Prop. XXXV. is, like the present, only a particular case of that next in order, but the proof of the latter requires that the particular case be previously established; so that, although Prop. XXXVI. really includes Prop. XXXV., yet Prop. XXXV. must not on that account be suppressed.

The enunciation of the present useless proposition is retained here, solely in order that Euclid's subsequent propositions may not be disturbed.

PROPOSITION

Triangles (ABC, DEF) upon equal bases (BC, EF) and between the same parallels (BF, GH) are equal.

* Pr. 31. Through B draw BG parallel to CA,* and through F draw FH parallel to ED,* the lines thus drawn terminating in GH. Then

† Pr. 34. GBCA, DEFH are parallelograms,† and, being on equal bases, and between the same parallels, they are equal,* ∴

* Pr. 36. their halves are equal, that is, the triangle ABC = the triangle DEF, ∴ triangles upon equal bases, &c. Q. E. D.

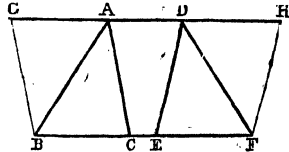

PROPOSITION XXXIX.—THEOREM.

Equal triangles (ABC, DBC) upon the same base (BC) and on the same side of it, are between the same parallels.

This proposition, like Prop. XXXVII, is superfluous; it is included in the next.

PROPOSITION XL.—THEOREM.

Equal triangles (ABC, DEF) on the same side of the same straight line, and having equal bases, are between the same parallels.

Draw AD. Then if AD be not parallel to BF, let some other line AG be parallel to BF, and draw

* Pr. 38. GF. The triangle ABC = the triangle GEF,* as they are on equal bases and between the same parallels. But the triangle ABC = the triangle DEF,† ∴ triangle DEF = triangle GEF, though one is only a part of the other, which is impossible, ∴ any other line AG is not parallel to BF, ∴ AD is the parallel to BF drawn from A, ∴ equal triangles, &c. Q. E. D.

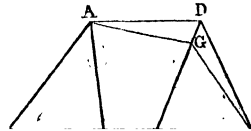

NOTE.—Whether the supposed parallel, AG, be considered to meet ED, or ED prolonged—that is, whether AG be imagined on the one side of AD, or on the other—the reasoning remains the same.

PROPOSITION XLI.—THEOREM.

If a parallelogram (ABCD) and a triangle (EBC) be upon the same base and between the same parallels, the parallelogram shall be double the triangle.

Draw AC, then triangle ABC = triangle EBC, because

* Pr. 37. they are on the same base and are between the same parallels.* But ABCD is double the triangle ABC,† ∴ ABCD is also double the triangle EBC, ∴ if a parallelogram, &c. Q. E. D.

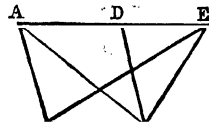

NOTE.—The learner will perceive that this theorem is unnecessarily restricted to the case in which the bases coincide; he may generalise it himself, proving that if a parallelogram and a triangle be upon equal bases, &c.

PROPOSITION XLII.—PROBLEM.

To describe a parallelogram that shall be equal to a given triangle (ABC), and have one of its angles equal to a given angle (D).

* Pr. 10. Bisect BC in E,* and make the angle CEF = D.† Also through A
 † Pr. 23. draw AFG parallel to BC, and through
 * Pr. 31. C, CG parallel to EF:* then FECEG
 is the parallelogram required. For draw AE: the
 † Pr. 38. triangle ABE = triangle AEC, †
 since they are on equal bases and between the same
 parallels, ∴ triangle ABC is double the triangle
 AEC. But FECEG is likewise double the triangle
 * Pr. 41. AEC,* ∴ parallelogram FECEG = tri-
 † Const. angle ABC, and the angle CEF = D, †. ∴ a parallelogram has been described
 as required.

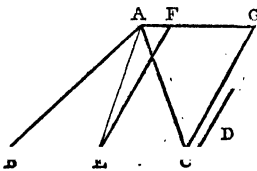

PROPOSITION XLIII.—THEOREM.

The complements (BK, KD) of the parallelograms (EH, GF) which are about the diagonal (AC) of a parallelogram are equal.

The parallelograms EH, GF, through which the diagonal AC passes, are said to be about the diagonal, and the remaining parallelograms BK, KD, which make up the whole figure, are called the complements of the former.

Because BD is a parallelogram, and AC its diagonal,
 * Pr. 34. ∴ triangle ABC = triangle ADC.* Again,
 because EH is a parallelogram, ∴ triangle AEK =
 † Pr. 34. triangle AHK; † and, for a like reason,
 triangle KGC = triangle KFC, ∴ AEK + KGC =
 AHK + KFC. But the whole ABC = the whole
 ADC, ∴ the remainders—that is, the complements BK,
 KD—are equal, ∴ the complements, &c. Q. E. D.

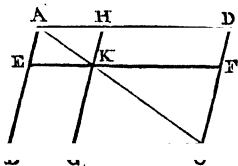

PROPOSITION XLIV.—PROBLEM.

To a given finite straight line (AB) to apply a parallelogram which shall be equal to a given triangle (C), and have one of its angles equal to a given angle (D).

Make the parallelogram BF = triangle C, and having the angle EBG =
 * Pr. 42. D,* and so that BE may be in the same straight line with AB; and
 † Pr. 31. prolong FG. Through A draw AI, parallel to BG or EF, † meeting
 the prolongation of FG in H, and draw HB.
 Then because HF falls on the parallels AH,
 EF, the angles AHF, HFE are together
 * Pr. 29. = two right angles,* ∴ BHF
 + HFE are less than two right angles, ∴ HB,
 † Ax. 12. FE, if prolonged, must meet. †
 Let them meet in K; and draw KL parallel
 * Pr. 31. to EA, or FH;* and prolong
 HA, GB, to L, M. Then LF is a parallelogram, of which the diagonal is HK; and
 LB, BF are the complements of the parallelograms AG, ME, about the diagonal,

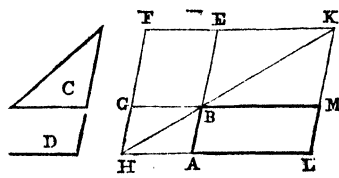

- † Pr. 43. $\therefore LB = BF$; † but $BF = C$, * $\therefore LB = C$. And because the angle
 * Const. $GBE = ABM$, † and $GBE = D$, * $\therefore ABM = D$, \therefore to the straight
 † Pr. 16. AB the parallelogram LB is applied $= C$, and having an angle $ABM =$
 * Const. D . Which was to be done.

PROPOSITION XLV.—PROBLEM.

To describe a parallelogram equal to a given rectilinear figure, and having an angle equal to a given angle (E).

First, let the figure be a four-sided one, $ABCD$. Draw DB , and describe the
 * Pr. 42. parallelogram FH = the triangle ADB , and having the angle $K = E$; *
 and to GH apply the parallelogram GM = the triangle DBC , having the angle GHM

† Pr. 44. = E . † The figure FM shall be the parallelogram required.

* Const. Because the angles K, GHM are each = E , * $\therefore K = GHM$. Add

to each of these the angle KHG , $\therefore K +$
 $KHG = GHM + KHG$; but $K + KHG$

† Pr. 29. = two right angles, † $\therefore GHM$
 † KHG = two right angles, and conse-
 quently KH, HM are in the same straight

* Pr. 14. line. * And because HG meets
 the parallels KM, FG , the angle $MHG =$

† Pr. 29. HGF ; † add to each of these
 the angle HGL , $\therefore MHG + HGL = HGF + HGL$; but the former are = two

* Pr. 29. right angles; * $\therefore HGF + HGL =$ two right angles, $\therefore FG, GL$ are in
 † Pr. 14. the same straight line. † And because KF, ML are each parallel to

* Pr. 30. HG , $\therefore KF$ is parallel to ML , * and KM, FL are by construction

† Pr. 34. parallel; $\therefore FM$ is a parallelogram. † And because the triangle ABD
 Def. = FH , and the triangle $DBC = GM$, * \therefore the whole $AC =$ the parallelo-

* Const. gram FM . Again, let the figure be five-sided: then, having drawn DC ,
 there will be, besides the four-sided figure AC , a triangle upon DC . A parallelogram,
 equal to this triangle, may be applied to LM , just as $GM = DBC$ was applied to
 GH ; and thus, however numerous be the sides, a parallelogram may be described equal
 to the given rectilinear figure, and having the angle $K =$ the given angle E .

Cor.—From this it is manifest how, to a given straight line, to apply a parallelogram
 which shall have an angle equal to a given rectilinear angle, and shall be equal to a
 given rectilinear figure.

PROPOSITION XLVI.—PROBLEM.

To describe a square upon a given finite straight line (A B).

- * Pr. 11. Draw AC at right angles to AB , * and make $AD =$
 † Pr. 3. AB . † Through D draw DE parallel to AB , and
 * Pr. 31. through B draw BE parallel to AD , * $\therefore AE$ is a
 † Pr. 34. parallelogram, $\therefore AB = DE$, and $AD = BE$; † but
 $AB = AD$, \therefore the four sides AB, AD, DE, EB are all equal, $\therefore D$
 AE is equilateral. Likewise, all its angles are right angles; for, since
 AD meets the parallels AB, DE , the angles $A + ADE =$ two right
 † Pr. 29. angles; * but A is a right angle, † $\therefore ADE$ is a right
 † Const. angle; but the opposite angles of a parallelogram are
 * Pr. 34. equal, * $\therefore B, E$ are each right angles, \therefore the figure AE

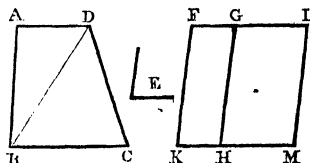

is rectangular, and it was proved to be equilateral; it is \therefore a square, and it is described upon the given straight line AB . Which was to be done.

Cor.—Hence, every parallelogram that has one right angle, has all its angles right angles.

NOTE.—It may be easily proved that the figure $A E$ is rectangular, provided it have one right angle A , and that it be equilateral; for if the diagonal $D B$ be drawn, the figure will be divided into two equal triangles (Pr. VIII.), $\therefore A = E$, \therefore the triangles are right-angled isosceles triangles, and (Pr. V. and XXXII.) each base angle is half a right angle, \therefore the angles A, B, E, D are all right angles. Hence a square is a four-sided figure, which has all its sides equal, and one of its angles a right angle; that the other three are also right angles is demonstrable, as above, and ought not to be assumed in a definition.

PROPOSITION XLVII.—THEOREM.

In any right-angled triangle (BAC), the square (BE) described upon the side (BC) subtending the right angle is equal to the squares (BG, CH) described upon the sides containing the right angle.

* Pr. 46. The squares being described,* through A draw AL parallel to BD or
 † Pr. 31. CE ; † draw also AD, FC . Then, because BAC is a right angle,* and
 * Hyp. that BAG is also a right angle, CA, AG are in the same straight
 † Pr. 14. line. † For a like reason, AB, AH are in the same straight line. Now
 the angle $DBC = FBA$, each being a right angle;
 add to each the angle ABC , $\therefore DBA = FBC$;
 also the two sides $AB, BD =$ the two FB, BC ,
 each to each, \therefore the triangle $ABD =$ the triangle

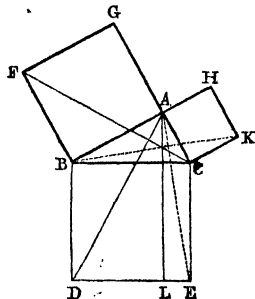

* Pr. 4. FBC .* Now the parallelogram BL is double the triangle ABD , because they are on the same base BD , and between the same parallels BD, AL ;
 † Pr. 41. AL ; † and the square BG is double the triangle FBC , because these also are on the same base, and are between the same parallels FB, GC ; but the doubles of equals are themselves equal, $\therefore BL = BG$.

In like manner, by drawing $A E, BK$, it may be demonstrated that $CL = CH$, \therefore the whole square $BE =$ the two squares BG, CH ; that is, the square described upon BC is equal to the squares described upon AB, AC , \therefore in any right-angled triangle, &c. Q. E. D.

PROPOSITION XLVIII.—THEOREM.

If the square described upon (BC) one of the sides of a triangle (ABC) be equal to the squares described upon the other two sides, the angle (A) contained by these two sides is a right angle.

* Pr. 11. From A draw AD at right angles to AC ,* and
 † Pr. 3. make $AD = AB$, † and draw DC . Then, because
 $AD = AB$, the square of $AD =$ the square of AB : to each of these add the square of AC , \therefore the squares of $AD, AC =$ the squares of AB, AC . But the squares of $DC =$ the squares of

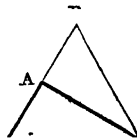

* Pr. 47. AD, AC , because DAC is a right angle,* and the square of BC is by hyp. $=$ the squares of AB, AC , \therefore the square of $DC =$ the square

of BC , $\therefore DC = BC$. Hence, in the two triangles ABC , ADC , there are two sides BA , AC in the one, equal to the two DA , AC in the other, each to each, and the base BC equal to the base DC , \therefore the angle $BAC = DAC$ *. But DAC is a right angle, $\therefore BAC$ is a right angle, \therefore if a square, &c. Q. E. D.

REMARKS AND COMMENTS ON THE FIRST BOOK OF EUCLID.

The following observations on the general character of geometrical reasoning, and on the First Book of Euclid in particular, are intended for the guidance and instruction of those whose acquaintance with the subject is limited to what has now been delivered. I think it very probable that, among such persons, there may be some who, however attentively they may have read the portion now completed, may yet have failed to perceive, so clearly as is desirable, the main object and intention of a course of geometrical study. It is true that the demonstrations themselves are so free from obscurity, and so thoroughly convincing, that no doubt can remain on the mind of an attentive reader as to the truth of the several conclusions arrived at; so that anything added to these demonstrations, by way of elucidation of the steps, or as confirmatory of the results, would be felt by the merest beginner to be an incumbrance rather than an aid.

There is no doubt, however, that Geometry is sometimes taken up with erroneous expectations as to what it teaches; and is read with a pliant docility of mind—a passive acquiescence in the dicta of the teacher—which Euclid himself would be the first to condemn. It is chiefly for the purpose of guarding you against such mistakes that I append the following remarks to the first book of the elements. I should have *prefixed* them, could I have been quite certain that you would have been familiar with the geometrical terms I shall be compelled to employ. I offer them here in the expectation that you will give the foregoing part a second reading, guided by the additional light I hope here to give you, in reference to the objects and advantages of Geometry, and also as regards the true spirit in which its principles should be studied.

A youth, destined ultimately for some mechanical or scientific occupation, is told—and properly told—that, to excel in his calling, he must study Euclid; this study is usually associated in his mind with a case of mathematical instruments, with scales, compasses, parallel-rulers, &c. Now, without expressly *forbidding* these things, it is of importance that he should be distinctly informed that, for aught that appears to the contrary, Euclid never handled, or even saw, compasses, parallel-rulers, &c., in his life. It is certain that he gives no countenance to the use of any such mechanical contrivances in his work. Had Euclid been asked, there is no doubt that he would have declared his inability to describe a circle, and even to draw a straight line. What we call *practical geometry* Euclid was entirely regardless of; indeed the application of geometry to the practical business of life was viewed by the ancient geometers rather as a degradation of the purely intellectual science they cultivated than as enhancing its value; and we accordingly find that but few of Euclid's *problems*, or practical constructions, are such as a skilful workman would follow.

Important and extensive as are the practical applications of geometry, it should nevertheless be borne in mind that the *Elements* would have existed, just as they now do, if these applications had never been thought of. The availability of geometry in practice is merely a contingent and accidental circumstance, un contemplated by the

geometricians, just as their theory of the conic sections was elaborated without any prospective regard to the future demands of physical astronomy, or to the discoveries of Newton.

And it is right to contemplate geometry under this purely intellectual aspect, and to study it as a strictly abstract science. Practical operations are all more or less imperfect. There are imperfections of vision, of the hand, of the instruments employed. Pure Euclidean geometry tolerates no such imperfections, however minute or unimportant they may be in a practical point of view. The circle of Euclid is a *perfect* circle—such a circle, in fact, as no human being ever formed. In like manner, the straight line of Euclid is rigorously what it is affirmed to be—*perfectly* straight, and *perfectly* breadthless. You see, therefore, that I was fully warranted in saying, as above, that Euclid could not describe a circle, nor draw a straight line; he has not, indeed, attempted to do either; the marks and diagrams which he exhibits to the eye, in connection with his reasonings, are nothing more than the outward symbols of what *actually exists in the mind alone*. And the truths of geometry become applicable to visible and tangible squares, circles, &c., only on the supposition or *assumption* that they are perfect copies of our intellectual conceptions of these things. A very able writer on Logic and Mental Philosophy (Mr. Stuart Mill) denies to the lines and figures of geometry the perfection here contended for. Assuming that all our conceptions of form originate in our contemplation of outward objects, which is no doubt true, he maintains that our ideas of squares, circles, &c., are only copies of the confessedly imperfect forms presented to our eyes. I would submit, however, that the mind can *conceive* what it may surpass the powers of the hand to *execute*; and that we can *imagine* a perfection which art cannot attain. A mere approximation to the perfect form—which is all that can be presented to the eye—will suggest the practically-unattainable perfection to the mind; and it may be safely asserted that the very infirmity of our visual organs contributes to this perfection; since defects, too minute to be visible in the outward object, cannot possibly accompany the mental impression of that object.

I have thought it right, in these introductory remarks, thus to state broadly, and I hope unambiguously, what the subject-matter of geometry really is. The objects with which it deals, and to which its reasonings are applied, are our perfect mental conceptions of figure, and not the imperfect pictured forms which, to help these conceptions, are traced upon the paper; these are merely the outward representations, or visible symbols, of the purely intellectual forms which they very conveniently serve to suggest; though, from the physical and instrumental imperfections which we know to be attached to them, they are not accurately the things themselves; these latter, by an act of abstraction, being freed from all material encumbrances; so that, in fact, the forms and figures of geometry are exclusively in the *mind*, and not in *matter*.

This is no bar to the practical applications of the science. Whether a tangible square be perfect or imperfect is of no moment, practically speaking, so long as its imperfections are undiscoverable by the senses; inasmuch as the rigorous conclusions of geometry may be applied to it without practical or appreciable error.

I now proceed to consider the basis upon which the entire structure of geometry rests—a basis so simple that a child might lay the foundation-stones; yet supporting a fabric which, though so extensive, is, at the same time, so secure, that the most powerful intellect cannot disturb its stability. I need scarcely say that I allude to the axioms and postulates of the science; and, in connection with the consideration of these, I shall take occasion to offer some suggestions as to the proper frame of mind in which Euclid should be studied.

Supposing, then, that you have your Euclid in your hands, I commence by first directing your attention to the fact, that the work is divided into distinct sections, or *Books*; and that each book commences with an explanation of the technical terms employed in it; with a concise but satisfactory description of the lines and figures to be reasoned about, and a statement of the elementary propositions to be *admitted as possible*, in the practical constructions, and of the elementary propositions to be *admitted as true*, in the reasonings.

You will at once see, that in entering upon any doctrine which is to be established, not by the influence of authority but by the force of reasoning and sound argument, it is of much importance that preliminaries such as these should be clearly and satisfactorily settled. If a person desire to communicate his own convictions to another, and, in undertaking to do so, make *reasoning* the only channel through which to convey them, there must be—first, a mutual concurrence as to the meaning of the terms employed; and secondly, a like concurrence as to the fundamental principles to be assumed by the one party, and admitted by the other. A good deal of what goes by the name of reasoning and argument, in the common affairs of life, is nothing but a sort of wrangling disputation, solely from the neglect to establish a clear understanding on these points at the outset. Euclid is careful to preclude this fertile source of ambiguity, confusion, and error. He commences the several portions of his subject with *Definitions* of the things to be discussed, and of the peculiar terms to be employed in the discussion; he then tells you what he expects you to admit as practically, or at least as *conceivably* possible; and lastly, what he requires you to concede, without demonstration, as necessarily true.

You should not hurry over the definitions; they have been framed with great care. The character of a good definition is this: that it is just sufficiently descriptive of the thing defined to distinguish it from all other things, but not more than sufficient for this purpose. If anything more than what merely suffices to identify the object defined be declared in a definition, that definition is said to be *redundant*: it involves the *assumption* of some property or peculiarity of the object, which it is the province of *reasoning* to deduce from the properly-restricted definition of it. All the properties of geometrical figures are in this way deduced from, or as it were drawn out of, the definitions of those figures; for in the definitions they are all virtually implied, and lie concealed. If you were to define an equilateral triangle as that which has three equal sides and three equal angles, you would make a statement which is quite correct, as a *statement*, but very faulty as a *definition*: the equality of the three sides *necessitates* the equality of the three angles (Prop. V. Cor.), so that the equality of the angles is virtually implied in the equality of the sides: a truth which must be discovered to us by reasoning, not assumed in a so-called definition. You will observe that Euclid invariably constructs his figures solely in reference to the descriptions of those figures embodied in the definitions, quite regardless, at the time, of all other properties of them; and you will perceive that he has furnished particulars just sufficient for this purpose, without one superfluous item.

I need scarcely state, that in speaking of Euclid here, the emendations of Simson and other modern editors are uniformly kept in view. It is much to be regretted that, in the editions of Euclid most generally studied, acknowledged blemishes are allowed to remain in the text, while the proper emendations are given in the form of notes at the end. Our veneration for a writer on science should never be considered as ground sufficient for us to endorse his errors and defects, nor even to except to them only indirectly, and in the form of supplementary annotation; they ought, in justice to him, as well as to those for whom he wrote, to be expunged from the text of his instructions.

In a work of taste or imagination, the case would be different; an editor would have no right to replace the author's views and peculiarities by his own; but a book of science, so extensively used in education as Euclid is, should be rendered as perfect as possible; and an editor of such a book could incur little blame for expunging every admitted blemish from the text of his author. I have generally acted under this impression.

Having thus previously established the *existence* of his geometrical forms, Euclid then proceeds, in his *Theorems*, to deduce, by reasoning, all those properties necessarily, though not obviously, implied in the definitions; but, as already noticed, before these existences can be proved, that is to say, before the constructions employed by Euclid in his *Problems* can be actually effected, assent must be given to the practicability, or, to be more explicit, to the conceivability of certain fundamental *operations*; these are enumerated in the *Postulates*: and that before the reasonings in his *Theorems* can be entered upon assent must, in like manner, be given to certain fundamental and necessary *truths*; these are enumerated in the *Axioms*. You perceive, therefore, that the definitions furnish the raw material worked upon, and that the postulates and axioms furnish the implements worked with:—the postulates supplying the elements of the constructions, the axioms the elements of the reasonings.

And here I must caution you against a very prevalent mistake. Do not for a moment imagine that Euclid required his postulates to be *granted* because the fundamental operations, under that head, are so easy of performance; nor that his axioms are to be assented to because the truths so-called are so easy of proof. His reasons for these preliminary stipulations were of a directly opposite kind; he bargains with you to grant the possibility of his fundamental problems (the postulates), solely because he is unable, practically, to perform them; and he calls upon you to admit, without proof, his fundamental theorems (the axioms) solely because he is unable to demonstrate them. A postulate and an axiom should each have a twofold character; a postulate should be a conceivable, but at the same time a really impracticable *operation*; an axiom should be a self-evident, but at the same time an indemonstrable *truth*. Euclid asks us to "*grant* that a straight line may be drawn from any one point to any other," from sheer necessity; the apparent simplicity of the operation is in reality a cause of its difficulty. What operation, still more simple, could be made subsidiary to the drawing of a straight line? And how could he direct the performance of the latter, without some operation still more elementary? Besides, an isolated straight line, according to Euclid's strict definition, has no visible or external existence. Euclid's *line* is merely the abstraction *length*; and length, unaccompanied by other dimensions, cannot, of course, be actually exhibited. The finest line that you or I could draw upon paper would be a solid bar of ink; and the finest line an artist could engrave upon steel would be a sunken channel, with both breadth and depth. You may possibly think that, as the physical or material lines here adverted to are so very slender, it is not worth while to make any objection to them on the score of their width or thickness; but the "near enough," or the "that'll do" system, has no place whatever in *Euclid's* system, which is one of rigid, uncompromising accuracy. A line that you could draw and exhibit would no more be regarded as a line that Euclid had defined, than a beam of timber would be so regarded. Remember that with *him* "a mis is as good as a mile."

As with the postulates, so with the axioms; they are inferred from necessity, and solely because Euclid was unable to demonstrate them. That self-evidence alone was not considered by him as sufficient to justify the claim of a proposition to a place among the axioms, is plain from his uniform practice of demonstrating whatever can be demon-

strated, and assuming only what cannot; taking care, however, *in general*, that the truth assumed shall be not only an ultimate truth, but also a thing perceived to be true as soon as enunciated. I say *in general*, because there is one remarkable exception—the 12th axiom of the first book is indemonstrable, but not self-evident; it has one of the characteristics of an axiom, but not the other. In the preceding book I have thought it prudent to keep this so-called axiom out of sight till the 29th proposition was reached; because up to that point its aid is not required, and because arguments, abundantly sufficient to produce full conviction of its truth, could be adduced *then*, though they could not have been employed at the opening of the subject.

Now you must not be surprised or disappointed that geometry—pre-eminently the science of demonstrated truth—should thus require to rest upon principles which must be gratuitously admitted. No reasoning process whatever can even be conceived to exist, unsupported by a like foundation. A proposition may be affirmed on the one side, and denied on the other; but the matter cannot be reasoned out—it cannot be *argued*, unless some common first principle or principles be at the commencement agreed to by both parties. If everything be denied, there may be assertion and contradiction, dispute and altercation, but certainly no *argument*. The noticeable thing in Euclid's first principles, or axioms, is, that with the exception mentioned above they are such as nobody in his senses would think of controverting, inasmuch as the truth of them is self-evident; that is, so immediately obvious, that nothing of the kind, anterior to them in obviousness and simplicity, can possibly be adduced; for if anything could, then *that* thing—being the more simple and elementary—would itself become the axiom, or first principle, by aid of which the former might be demonstrated. You see, therefore, that it is essential to the very nature of an axiom that it should be too simple and elementary to admit of demonstration by help of anything more simple and elementary. The axioms are, on this account, self-evident indemonstrable truths. Proposition II. of Book III.—namely, that “If any two points be taken in the circumference of a circle, the straight line which joins them shall fall *within* the circle”—is a proposition as self-evident, to any one who has a clear conception of a circle, as that which affirms that “two straight lines cannot inclose a space;” but as it is demonstrable it is very properly placed in the body of the work.

But it is time that I give you a few words of advice as to the disposition of mind with which you should sit down to the study of geometry, and to notice some of the intellectual advantages which you have a right to expect from the time and attention devoted to the subject.

You have already seen what the preliminary conditions are which Euclid makes with you: he considers these to have been conceded, without the slightest qualification or reserve. As far as he is committed, he will take care that they are faithfully adhered to, and he stipulates that they shall be equally binding upon you. They are fully and fairly placed before you in the Definitions, the Postulates, and the Axioms. In these matters he seems to assume a sort of magisterial authority, from which he allows no appeal. If you refuse to subscribe to the conditions which he himself lays down, he, on his part, refuses to be your guide: he can conduct you through the rich domain you wish to explore upon no other terms: he is inflexible as to his preliminary arrangements for the journey; and he as good as tells you, as he told King Ptolemy of old, that “there is no royal road to geometry.”

If, therefore, you have any notion still lingering in your mind, about a line, or a triangle, or a circle, &c., not strictly in accordance with what he authoritatively

declares to be *the* notion, you must dismiss either it or *him*. If you have any scruples or misgiving about his postulates, or axioms, you must, in like manner, overcome them: you must examine them, and re-examine them, till you are fully convinced that the postulates are really conceivable operations, and that the axioms are really unquestionable truths; for, depend upon it, he will tie you down most rigidly to the *conditions*, and allow of no escape, evasion, or qualification. It matters nothing to him by what process of mind you satisfy yourself of the truth of his axioms, nor by what mechanical contrivances you seek to give an outward representation of lines, triangles, and circles; you may use pen, ruler, compasses, or whatever you please, for your own individual convenience or assistance; but remember, that he himself takes no cognizance of these things. If, without any instrumental aid at all, and by mere freedom of hand, you were to sketch the outline of an inclosed figure, and make *that* the representation, to yourself, of a circle, Euclid would find no fault with you, provided only you still, in imagination, endowed it with the characteristics of the true circle that he had defined. You would find a carpenter, or a mason, much harder to please, in a matter of this kind, than you would find Euclid. If you have carefully read what has preceded, you will see that I am quite justified in making this statement; for you will have learned that Euclid is not concerned with the *representations*, but with the *things* themselves, the purely intellectual conceptions.

Taking it, then, as a settled matter, that you receive Euclid's definitions—that you *do* "grant" his postulates, and that you *do* fully acquiesce in the truth of his axioms, all preparatory ground is cleared; and you may proceed at once to the business proposed. And here, you are to observe, that both you and your author occupy different positions. Euclid at once, from this point, drops his authority as a master; you withdraw your submission as a docile and obedient pupil. What he *says*, you are to regard no longer—only what he *proves*. You are to exercise a vigilant watchfulness over every statement he makes, receiving just so much of it as you cannot help receiving, and no more. *Faith*, in anything he advances, is not to be thought of. Be as sceptical as you please—nay, as sceptical as you can. Euclid would not thank you for any gratuitous concession whatever; all he demands is, that you will honestly respect the preliminary articles of agreement; and, in spite of all your opposition, and of all your scepticism, he will *compel* you—however much against your wish—to do unqualified homage—not to *him*—but to the truths he propounds.

And this is the attitude of mind you are to assume in entering upon the propositions of geometry. There must be no yielding to the dicta of a teacher—no intellectual obeisance to the authority of a great name. Every truth you acquire, you must *so* acquire as to feel and know it to be a truth, from your own perfect individual conviction that it is so. Your conviction must be so thoroughly inwrought and complete, that if a Newton, or even a greater than Newton, should attempt to controvert a truth thus secured, the effect of such an attempt upon your mind would be about the same as an endeavour to convince you that you are an inhabitant of the moon.

Now I think that, from these unqualified statements, you may fairly make two inferences, well worthy of consideration. The first is, that even in this, our frail and erring state, there is offered to our notice a system of unadulterated and incontrovertible TRUTH, built up by purely human effort, and consolidated and rendered imperishable by purely human reason. The second inference is, that the reasoning process, by which such an intellectual structure has been reared, must surely be of the most faultless kind—no logical error can have been committed—no conceivable objection unanticipated, and no case of exception unprovided for.

These considerations alone seem to me amply sufficient to incline all who have the time and opportunity to a diligent study of geometry, apart from all regard to practical applications. Only reflect for a moment upon the *habits of mind* which such study must necessarily foster, where they in any way exist, or *create* where they are wanting. The frequent contemplation of *Truth* has a salutary and an ennobling influence. Next to Inspired Truth, the truths of pure science furnish the most exalted materials upon which the human mind can exercise its powers. He who is earnestly and *successfully* engaged in this exercise, comes, at length, to love truth for its own intrinsic excellence; to be fascinated with its unadorned beauty; and to entertain increased repugnance towards the deformities of falsehood. Habits of mind, whether good or bad, are the fruits of seeds usually sown in youth; they become formed and fixed from the natural effects of those trains of thought in which we most frequently indulge in early life; and hence the study of geometry, and of the sciences which carry out its pure principles, have an important influence, even in a *moral* point of view. To secure the operation of this influence is surely deserving an effort. The properties of geometrical figures may be matters of perfect indifference to us—we may take but little direct interest in what relates to triangles, and parallelograms, and circles; but we cannot be indifferent to a truthful habit of mind; and though all the theorems of Euclid be forgotten, yet if *this* remain as an abiding result, how great will be the acquisition we shall have made!

But the *intellectual* advantages connected with the study of the “exact sciences,” are even more certain and palpable than the *moral* advantages here alluded to. You cannot read a proposition of Euclid as it ought to be read—and indeed as it must be read, in order to be fully understood—without a concentration of attention more intense than most other subjects, out of mathematics, demand; and since, as noticed above, there must be no disposition to admit anything whatever, without the most complete conviction of its truth, a habit of scrutinizing evidence, and of distinguishing between plausibilities and proofs, is insensibly but securely acquired. There is, perhaps, no faculty of the mind which in early life stands in more need of cultivation than the reasoning faculty; for that every one reasons, or at least engages in what goes by the name of reasoning, is so generally admitted as a distinguishing peculiarity, that man has been even defined to be “a reasoning animal.” Locke says, “Would you have a man reason *well*—let him learn geometry;” that is to say, if to reason well be the only end in view—all the truths of Euclid being regarded as utterly valueless—still let geometry be studied. Yet geometry supplies no rules; it prescribes no directions for conducting a logical process; but, what is better, it places before us a collection of the most exquisite models. It teaches by example, not by precept; and no one, with proper attention, can fail to profit by its lessons.

You see, therefore, that Euclid is something more than a mere problem-book—the use of architects and surveyors: it is the most finished treatise on the “Art of Reasoning” that the world possesses; and it is chiefly as such that I am anxious to recommend to my young friends a careful study of its contents. It may fail to render you much direct professional service; but the mental discipline it furnishes will strengthen your judgment, improve your logic, give additional acuteness to your penetration, and, in fact, so enlarge and invigorate all the faculties of your mind, that you will be enabled to bring a higher degree of intellectual power to bear upon any pursuit in which you may earnestly engage. It is not the properties of geometrical figures that can do this: it is the reasonings by which they are established. The several stages at which

you arrive, in your progress through Euclid, may present but few points of attraction; but you *must* be benefited by the invigorating influence of the journey.

And here it may perhaps be as well, in order to prevent misunderstanding, that I should offer a remark or two in reference to a direction I have given you above—namely, that you should approach the demonstrations of Euclid in a *sceptical* spirit. It has been foolishly, and most unjustly, affirmed by some, that the study of pure science has a tendency to produce *general scepticism*. Now all truths are harmonious; they have common features and common attractions, recommending themselves to our homage by the same dignified aspect and bearing. How can scientific truth ever be out of keeping with inspired truth? A religious sceptic is generally something more than a mere *neutral* as respects divine things: he is usually a *denier*; that is, he embraces a *negative proposition*, and acts upon it without proof! How does geometry sanction this? In Euclid there are negative propositions as well as affirmative ones. I recommend you, anterior to proof, to be equally sceptical as to *both*. In things out of geometry, geometrical demonstration is, of course, not to be had: it would be folly to look for it; yet, if in such things an affirmative be declared on the one hand, and a negative on the other, do you not think that the logic of geometry, as well as the logic of common sense, would incline us to *that*, in support of which *some* evidence was offered, rather than to that which had no such support at all?

But there are sceptics of a different stamp from the class noticed above; men of literary and philosophical habits, who do not content themselves with a “cold negation.” They address themselves to the task of undermining the existing evidences for the truth of Christianity. Such a man was David Hume, a distinguished writer of the last century. He wrote an Essay to prove that a *miracle* never could have been performed, or, at least, that we have no reliable evidence of its performance. He laid down certain preliminary principles, and dressed his performance in the garb of *fair reasoning*. But Hume knew nothing of mathematics; and, in invading its province, he trod upon alippery ground—and *fell*. Those who *did* know something of the “exact sciences” betook themselves to the investigation; they started upon precisely the same principles as Hume did, without the assumption of a single additional particular, and they arrived, by a train of reasoning which it is impossible to disturb, at a conclusion *directly opposite to his*. Had Hume known but a little of mathematics, and had he revised his so-called *argument*, in the same sceptical spirit which I recommend to you, a regard for his own literary reputation merely would have precluded him from ever publishing to the world his “Essay on Miracles.”*

You have already seen that the propositions of geometry are of two kinds—problems and theorems. A proposition is called a *problem*, when the thing proposed is an operation to be performed—a construction to be effected: its object is a practical result, to be brought about by a suitable disposal and combination of the elementary materials furnished by the *postulates*. A proposition is called a *theorem*, when the thing proposed is a truth to be demonstrated; and for this demonstration the elementary materials are furnished by the *axioms*. It usually happens, however, that the proof of a theorem requires the previous introduction of certain lines and constructions; and hence it is that Euclid commences his first book with problems instead of theorems. The only theorem in this book, that is quite independent of a problem, is Proposition IV.

* “Bridgewater Treatise”—Appendix. Also Young’s “Three Lectures on Ma-

I suppose Euclid considered it to be more systematic to introduce the problems, which he foresaw would be indispensable as soon as the fourth proposition was disposed of, at the *beginning* of the book, than to interpose them between propositions so closely related as the fourth and fifth.

Of the three problems thus found to be necessary to meet the demands of the subsequent theorems, the second is the only one which seems to require any comment. Beginners in general find it difficult, and are apt to consider that there is an unnecessary parade of geometrical apparatus exhibited to effect so simple a matter as the drawing of one straight line equal to another. There is no doubt that a mere mechanic would pronounce the proceeding a very round-about one; he would accomplish the business at once, by drawing a straight line from A at random; and then, having taken the length BC in his compasses, he would apply one foot at A, fixing it there as a centre, and with the other foot would cut off the required length AL; thus dispensing with all Euclid's machinery—the circles and the equilateral triangle. Now this is all very well for the purposes of the practical workman, who neither seeks nor expects rigid accuracy in his constructions; but you must remember that Euclid ignores compasses, and that the instrumental transference of one line to another is not warranted by any postulate. No one can take *accurately* any stipulated length in a pair of compasses; the limitation of his vision precludes his pronouncing, with perfect certainty, that he has got *exactly* the proposed length, neither more nor less. If the minute error, whether in excess or in defect, be only so small as to escape his senses, he cannot take cognizance of it; and he not only practically, but from necessity, disregards it. But without any additional postulate, Euclid shows you how the thing proposed may be done without the possibility of any error at all. In the ordinary editions of Euclid, I think justice is scarcely done to the process indicated. You are directed, first, to draw a line A E longer than BC, and are then shown how to cut off a part A L equal to BC. The ingenuity of Euclid's mode of proceeding would be more apparent, if no superfluity of length were at first introduced. It certainly seems a thing of much greater difficulty to draw a line from a point A, till a certain prescribed length be attained, and then, but not till then, to stop. I would therefore recommend you to leave the prolonging of DA to the very last; so that, having performed every other part of the construction, prolong DA, as a final step, till the prolongation reaches to the circumference of the outer circle. A line AL will thus have been drawn equal to BC, and there will be no excess of length to throw away. This is the mode of proceeding adopted in the present edition.

As to the other two problems, the first and third, but little need be said; the directions given by Euclid, for the construction of them, are too clear and explicit to render further explanation necessary. It may be well, however, to invite your attention to two particulars in connection with Proposition I., which instructs us how to describe an equilateral triangle upon a given finite straight line. Some commentators object to the word *finite* as superfluous, considering the condition, "a given straight line," to imply that the length is fixed and determinate. But a line may be given in *position* only, without any limitation as to length, as in Proposition XI.; or it may be given in length merely, without any restriction as to position; thus the line to be constructed in Proposition II. is to have a given length, but is unrestricted as to position or direction. By "a given finite straight line," Euclid means a line of given length, and with given extremities; and if any objection at all is made, in reference to this word *finite*, I think it should be urged against the omission of it in Proposition II. rather than against the introduction of it in Proposition I. In the *first* proposition, I dare say Euclid thought

it prudent, to prevent all cavil, to state explicitly that the extremities, A, B , are given ; and that he did not consider it necessary to repeat this in Proposition II. Whenever a line is given in position merely, and restriction as to its length forbidden, Euclid characterizes it as "a given straight line of unlimited length," as in Proposition XII. ; but when it is matter of perfect indifference whereabouts the extremities are (position alone being all that we are concerned with), the terms "a given straight line" are those always employed, as in Proposition XXXI. A mere glance at this proposition will show you that the given straight line of Proposition I. cannot be so entirely free from restriction, as to length, as the given straight line of Proposition XXXI. ; and hence the propriety of the restrictive term *finite* in the former. I should not have said so much about a mere word, had it not been for the hypercriticism of others. You must therefore regard these remarks, not as a comment upon *Euclid*, but as a comment upon his commentators.

The other matter I should wish you to notice, in connection with this first proposition, is, that what is called "the point C , in which the circles cut," is in fact either of two points, one on each side of AB , so that a second equilateral triangle may be described, on the opposite side of the given line ; and it is this latter position which the equilateral triangle, introduced into the construction of Proposition IX., is to take. I shall only further notice, that it would have been somewhat more explicit, if Euclid had referred to the point C as where the *circumferences* cut, rather than as where the *circles* cut ; though it is quite true that the circles themselves interpenetrate there ; but the distinction, very properly made by Euclid in his definitions, between circle and circumference, is in danger of being overlooked by a beginner, in consequence of Euclid's mode of expression, in reference to intersecting circumferences.

Proposition IV. is the first of Euclid's *theorems* ; and, being the first, and involving no construction, its proof depends solely on the axioms. The demonstration hinges upon what has been called the method of *superposition* ; that is, the imagining one figure to be placed upon another, with a view to their perfect adaptation and coincidence, and thence to the inference of their complete *equality* (Axiom 8). If you wish to try the experiment, whether or not you have any taste or aptitude for geometrical reasoning, you may, if you please, *commence* with this theorem, and study the three preceding problems afterwards. It is a very beautiful specimen of Euclid's mode of argumentation ; and is quite within range of the powers of the merest beginner. But before you address yourself to it, it may be as well to reflect that the relative *positions* of two things can have nothing to do with their relative *magnitudes* ; that the two triangles, affirmed under certain conditions to be *equal*, and placed side by side before you on the paper, must remain equal, however their relative positions be altered ; whether one be turned upside down, or be made to overlap the other, can make no difference as to the equality or inequality of the two in *magnitude*. You will thus see that, for the purpose of instituting an inquiry as to the equality of the triangles, it is quite allowable to imagine one to be placed upon, or to be applied to the other, with the view of ascertaining whether, by a suitable adjustment, a complete adaptation may be brought about. In this manner Euclid directs you to apply the triangle ABC to the triangle DEF in a certain way—namely, so that the point A may be on D , and the straight line AB upon DE . He then affirms that B must coincide with E ; and as he never affirms anything without immediately answering the inquiry *why* ? he adds, *because* AB is *equal* to DE . The adjustment is thus brought about as far as the sides AB, DE are concerned. He then asserts that, this partial adjustment remaining undisturbed,

A C must fall upon D F, because the angle or opening A is equal to the angle or opening D. If A C fell beyond D F, the angle A would be greater than the angle D; and if A C fell short of D F, the angle A would be less than the angle D; Euclid's conclusion, therefore, is irresistible. As A C then necessarily falls upon D F, the point C must as necessarily fall upon or coincide with the point F, because A C is equal to D F. And thus having proved, first, that B coincides with E, and then that C coincides with F, he infers, in virtue of the 10th axiom, that the base B C must coincide with the base E F. Hence the adaptation is complete; there is perfect coincidence, and therefore perfect equality in every respect.

Proposition V. is always found to be more or less perplexing to a learner; and it is certainly one of the most, if not the most knotty of the propositions in the first book. I would recommend a beginner, after completing the construction as directed, to erase the base B C of the original triangle, in order that nothing may divert his attention from the two triangles A F C, A G B. The line thus expunged may be restored after these triangles have been proved to be in all respects equal: they are nothing more than the two triangles already considered in Proposition IV. in a different position, one triangle partially overlapping the other. Young students are sometimes deterred from prosecuting the study of Euclid by the length and difficulty of this proposition. They should be apprised that the propositions are not arranged in the order of their difficulty; that none more troublesome than this fifth will ever after be met with, and that the last theorem in the book is quite as easy as the first. A great point will be gained, if you master this fifth proposition; for you may then conclude with confidence that you will find yourself fully adequate to all that follows: but you must not come to this conclusion till, closing the book, you find yourself able to demonstrate the theorem step by step without a reference to it. This mode of testing your progress must be resorted to all along. It is not enough that you read and understand Euclid's demonstrations—you must acquire the ability of furnishing these demonstrations yourself; you may vary the language, but you must preserve the rigour of the argument, affirming nothing without a reason; which reason, mind, must be the reason.

I do not clearly see why the fifth proposition should be called *Pons asinorum*, or the asses' bridge. They say it is because "asses" stick at it; but I believe it was the twentieth proposition that was so designated by some of the ancients; for Proclus informs us, in his "Commentary on Euclid," that the Epicureans derided the twentieth proposition as being manifest "even to asses;" for if a bundle of hay were placed at one extremity of the base of a triangle, and an ass at the other, the animal would not be such an ass as to take the crooked path to the hay instead of the straight one; as he would know the direct course to be the shorter: this was therefore called the asses' bridge.

The sixth proposition you will find very easy after the fifth: it is what is called the converse of the first part of the former proposition. A theorem is said to be the converse of another, when the hypothesis and the consequence in that other change places. The hypothesis in Proposition V. is, that two sides of the triangle are equal; the inference or consequence is, that the two angles opposite to them are equal. The hypothesis in Proposition VI. is, that two angles of a triangle are equal; and the consequence is, that the two sides opposite to them are equal: the one proposition is therefore the converse of the other. In general, Euclid demonstrates the converse of a previous theorem indirectly, or by what is called the *reductio ad absurdum* method; that is, he commences with a denial of the truth stated; and, reasoning from the contradictory statement, as

if it were true, shows that an absurdity, or impossibility, is the unavoidable consequence; thus proving that the thing contradicted cannot be otherwise than true. Throughout the whole of this book, the last proposition is the only converse theorem that is not demonstrated in this indirect manner. It is not every theorem that is true both directly and conversely. You should take note of those that Euclid proves to be *convertible*, and endeavour to discover for yourself which of his propositions hold conversely, though only proved directly. For example, Proposition XXXIV. proves that if the opposite sides of a quadrilateral are *parallel*, they are likewise *equal*. It is also true conversely, that if the opposite sides are *equal*, they are likewise *parallel*, as you may prove for yourself, after the direct proposition has been established.

Proposition VII. is merely subsidiary to the proposition next following; it is what in some geometrical writings would be called a *Lemma*. You see that the demonstration of it rests almost entirely on Proposition V. In some modern books on geometry this proposition is dispensed with, and the eighth established independently of it; but, as an intellectual exercise, Proposition VII. is as useful as any in the book. Besides, a proposition, though manifestly introduced as merely subsidiary to something else, may yet possess intrinsic excellence of its own sufficient to justify its retention in the system. For instance, the proposition before us teaches us this fact, which is certainly not without interest; namely, that a physical triangle, supposed to have its sides freely moveable about joints at its vertices, cannot possibly be thrust out of shape by any force whatever. You may break the bars forming the framework, but you cannot make the frame itself assume another shape. It is a very different thing with the frame of a common school-slate, as I dare say you well know from practical experience; for I have no doubt that you have often twisted such a slate-less frame into a great variety of shapes. You now know, not from experiment, but from abstract science, that this would have been impossible if your slate-frame had been triangular, instead of rectangular.

Proposition VIII. is the *second* proposition, in the geometry of triangles, which proves that two triangles are equal in every respect—that is, that each is but an exact copy of the other—provided *three* things in one are respectively equal to three corresponding things in the other. The three things may be two sides and the included angle, as we learn by Proposition IV., or the three sides, as the present proposition teaches. And I may as well observe here, that there is only one other proposition in the Elements where the like equality of two triangles is inferred from an equality of three things in one to three corresponding things in the other: it is Proposition XXVI. On these three propositions the practical part of *plane trigonometry* is founded. A triangle, in the language of trigonometry, is said to have six *parts*—the three sides and the three angles; and when certain sets of *three* of these are given—either of the sets, namely, mentioned in Propositions IV., VIII., and XXVI.—the remaining three, which we see by these propositions must be fixed and invariable, become determinable, and are matters of computation.

And here it may not be amiss to say a word or two about the form of expression continually employed by Euclid, when comparing figures together, for the purpose of establishing their equality. He always speaks of two sides or angles of the one being equal to two sides or angles of the other, *each to each*. Learners are apt to omit this qualifying condition, "each to each," as if the frequent repetition of these words were only so much useless tautology; but precision requires that they should always be retained. If you were to say that two sides of one triangle are equal to two sides of

another, your meaning might be taken to be, that the *aggregate* or *sum* of the two sides of one triangle is equal to the aggregate or sum of the two sides of the other; but the addition of the words "each to each" would preclude the possibility of such a mistake, and would show that the sides, taken separately and individually in the one triangle, were affirmed to be equal to corresponding sides in the other.

The four propositions next following are *problems*. You may be pretty sure that Euclid has postponed them till they became indispensable. I don't think Euclid *liked* problems; at all events there is less careful finish about them than in his theorems. Proposition IX., for instance, needs mending a little; it professes to teach how to bisect an angle, of whatever magnitude it may be. Now, suppose that the triangle ADE , in the book, is an *equilateral* triangle, and that we want to bisect the angle DAE . Euclid tells us to construct an equilateral triangle on DE ; and without the diagram before our eyes, where the construction is exhibited in its completed state, we should naturally describe the equilateral triangle he directs, *above* DE , and not *below*; in which case we should get nothing; for our new equilateral triangle would simply cover the one already there, and the point, F , falling on A , would have no separate existence; so that there would be no guide to the drawing of AF , the bisecting line; it should have been distinctly stated, therefore, that the equilateral triangle, to be described on DE , should have its vertex, F , on the opposite of DE to the point A . This restriction is introduced in the present edition.

In going over Euclid's propositions without the book, as I have recommended above, always refrain from *copying the diagrams*. I know that such is the usual practice; but it should be condemned. The progress of the diagram should just keep pace with that of the text, and no line should be introduced till it is actually demanded by the text. It would be nearly as faulty as to write out the whole text, and then to supply the diagram (as the boy did who said he would tell the story first and draw the picture afterwards), as to commence with the completed diagram and then supply the text. In a printed book, the diagram must, of course, be presented *completed*; but in your own private practice you should make it grow to maturity along with the text. In the whole course of your geometrical studies, let me urge upon you never to allow your judgment or conviction to be in the slightest degree biased by your visual impressions from the *diagram*. Let two lines look ever so like two equal lines, don't forestall the reasoning, and conclude them equal from their appearance; remember always that you are engaged in a purely *intellectual* process, and that you are not to be allured by the *matter* from the *mind*. Graphical accuracy, in the figured form, is of no moment; logical accuracy, in the abstract reasoning, is all that you have to attend to; and therefore I think it worse than waste of time to be over-scrupulous with scale and compasses, in reference to the lines introduced into Euclid's demonstrations; but I have already given you some hints on this matter at pages 68 and 73.

I do not see anything that calls for special notice till we reach Proposition XVI. This is easy enough, as far as Euclid carries the demonstration; but when, at the close, he says, as in other editions of the Elements he is made to do, "in the same manner it may be demonstrated," a beginner is likely to feel a difficulty. There is really a good deal to do before the proof can be completed; and, when completed, "in the *same* manner," there is a needless amount of complication. I would advise you to finish the reasoning rather differently. By carefully looking at the argument, you will see that this truth is established, and nothing more; namely, that if one side of a triangle (*any* side, of course) be produced, the exterior angle is *greater than that interior angle which is*

opposite to the side thus produced; the angle ACD is thus greater than A . Let now AC be produced to G , then, since the exterior angle is greater than that interior one which is opposite to the side produced, the angle BCG is greater than ABC ; but BCG is equal to ACD (by the fifteenth), therefore ACD is greater than ABC ; but ACD was shown to be greater also than BAC ; therefore ACD is greater than either of the interior and opposite angles, BAC , ABC . It is this form of completing the demonstration that has been adopted in the present work.

Proposition XVII. would seem, at first sight, to have been introduced without any object. The truth of it is clearly implied in Proposition XXXII., and it is not required in any of the intervening propositions. But that Euclid had an object is not to be questioned; and it seems to have been this:—It was desirable that, at some convenient place, before the introduction of the theorems respecting parallel lines, something should be established by demonstration that would diminish the repugnance, very properly felt at the outset, to the *twelfth axiom*. You know I have recommended you (p. 59) to keep this axiom in the background till you arrive at Proposition XXIX., where a reference to it becomes indispensably necessary. The axiom is no other than the *converse* of this seventeenth proposition; this shows that if two meeting or non-parallel lines, BA , CA , be cut by a third line, BD , the two interior angles, CBA , BCA , on the same side of it, are together *less than two right angles*; and the twelfth axiom asserts, *conversely*, that if a straight line cutting two others make the two interior angles on the same side of it *less than two right angles*, those others must be non-parallel or meeting lines.

The seventeenth proposition, therefore, enables us to see more clearly the exact amount of assent demanded of us by the twelfth axiom, and prevents our overrating that amount; if two lines cut by a third *meet*, the two interior angles are less than two right angles—this is *proved*; if two lines cut by a third make the two interior angles less than two right angles, *they meet*—this is *assumed*.

Passing over, for the present, the intermediate propositions, let us suppose Proposition XXIX. to be reached. The two propositions immediately preceding sufficiently show that the lines called parallel lines *exist*; the twenty-ninth demonstrates a property of them, admitting the truth of the axiom just mentioned. Geometers without number have tried, some to evade this axiom altogether, and others to prove it by establishing the converse of Proposition XVII.; but all have failed. What can be the cause of this failure? Is it not in the imperfect definition of a *straight line*? Our conception of a straight line, independently of all formal definition, necessarily involves two ideas; namely, that of *length*, and that of *uniformity of direction*. *Length* is implied in the word *line*; and *invariability of direction* in the term *straight*. A line which changes its direction is a *crooked* line or a *curved* line; a line that never changes its direction is a *straight* line. Now it necessarily follows, from this uniformity of direction, that if two straight lines, however far prolonged, can *never meet*, then at no part of their course can either make any *approach* towards the other; for if two lines, proceeding in any two directions, *approach* and continue undeviatingly to pursue those directions, they cannot fail eventually to *meet*. It follows, therefore, that parallels must *throughout* be equidistant; but *two distinct straight lines, through the same point, cannot throughout be equidistant from a third*; so that *two straight lines through a point cannot both be parallel to the same straight line*. Proposition XXVIII. shows that *one* (CD) will be parallel to another (AB), provided a line, cutting both, makes the interior angles together *equal to two right angles*; a *second* line through H , which causes the interior

angles to be *less* than two right angles, being distinct from CD , must therefore meet AB , if prolonged; and this is the assertion of the twelfth axiom.

What is here said, remember, is not a *demonstration* of this axiom. An axiom, you know, is an indemonstrable truth. All I wish to show is, that it is an axiom; that is, a truth necessarily implied in the correct conception of the thing to which it refers. In you steadily contemplate your conception of a straight line, giving due consideration to its distinguishing peculiarity—*uniformity of direction*—you must see that *two*, from the same point, cannot *both* be equidistant from a third; *one* may be parallel to this third, or everywhere equidistant from it, since, as we have seen, parallels are *possible*; but *one* must of necessity meet it.

Of the propositions passed over, the 22nd and 24th are the only ones requiring any special notice here. Both these, as given in the text of Dr. Simson, are open to objection. In the first of them, it is taken for granted that the two circles employed in the construction must *cut* one another; and in the second, it is assumed that the point F falls *below* the line EG . You will find these defects acknowledged in the notes at the end of Simson's Euclid; but they were first pointed out by Mr. Thomas Simpson, in his "Elements of Geometry." The emendations of the latter were, however, but ill received by the "restorer of Euclid," who treated "the remarker," as he called him, with a good deal of contempt; the more to be reprobated, as the poor self-taught weaver (for such Simpson in early life was) was very superior as a man of science to his academical opponent, great as were the merits of the latter in the field of ancient geometry. The biography of Thomas Simpson is full of instruction and encouragement to the young and unaided student, who cannot fail to view with interest the steps by which a person in Simpson's position, without books, money, or friends, plying his humble calling among the lowest ranks of society, was conducted, by the force of perseverance, to the proud eminence which he eventually attained. In the annals of science he ranks among the most distinguished mathematicians of the last century; and yet, at the age of nineteen, he was ignorant of the first rudiments of common arithmetic.*

The defect above alluded to in Dr. Simson's version of the 24th Proposition is removed in the present edition; and the objection made to the reasoning in the 22nd may be disposed of as follows:—After having described the circles, as at page 56, reason thus: *One of these circles cannot be wholly without the other*, for then FG , the distance of their centres, would be either equal to, or *greater* than the sum of the radii; but, by hypothesis, it is *less*. *Neither can one of the circles*—as, for instance, that whose centre is G —*be wholly within the other*; for then the radius, FD , of the latter would be equal to, or *greater* than FH ; but, by hypothesis, it is *less*; hence, since one circle can be *neither wholly without the other, nor wholly within*—they must be *partly without* and *partly within* one another, \therefore they must *cut* in some point K . This completion of the proof may be introduced in a second reading of the first book.

Proposition XXXII. is among the most interesting theorems of this first book; but an objection to the demonstration of it may be made, the occasion for which had better be removed. You are directed to draw, through the point C , a line CE parallel to AB , by Proposition XXXI.; and it is then inferred that the alternate angles BAC, ACE are equal by an appeal to Proposition XXIX.; but to draw the parallel CE , surely everybody would proceed by making the angle ACE equal to BAC ; that is to say, we should first make the alternate angles equal to get the parallels, and should then make

* Some account of Simpson will be found in "The Pursuit of Knowledge under Difficulties;" as also in Dr. Hutton's "Mathematical and Philosophical Dictionary."

use of the parallels to prove the alternate angles equal. You will at once see that we should avoid this circuitous method of proceeding, by making the angle $\angle ACE$ equal to $\angle BAC$ by Proposition XXIII. ; and then inferring the parallelism of AB, CE from Proposition XXVII. ; so that Proposition XXXI. need not be called into operation at all.

The corollaries to this proposition are remarkably beautiful ; and the second, especially, cannot fail to excite, in a person who reads it for the first time, a feeling of surprise. It would indeed be a feeling of *incredulity*, if this were possible in geometry. That the sum of the exterior angles, formed by prolonging the sides of a rectilinear figure, should always be *exactly* the same, whether the figure have three sides or as many thousand, is a truth so far beyond the reach of practical observation and experiment, and apparently so improbable, that, in the absence of geometry, its existence could scarcely have been suspected, much less established ; and yet an argument of half-a-dozen lines produces in every mind the fullest conviction of the fact.

But the corollary that precedes this, though less striking, has, perhaps, the greater practical interest ; among other things, we learn from it that—the sum of the angles of a four-sided figure is *twice* as great as the sum of the angles of a three-sided figure ; the sum of the angles of a five-sided figure, *three* times as great ; of a six-sided figure, *four* times as great, and so on ; but the most noticeable practicable inference is, that only *three* regular figures,* namely, the equilateral triangle, the square, and the regular six-sided figure or *hexagon*, can, by repetition, completely cover a surface : in other words, that, without leaving any blanks or interstices, we may cover a surface with a mosaic work of equilateral triangles, or of squares, or of regular hexagons, but not with regular figures of any other kind. It would be impossible, for instance, to form a piece of tessellated pavement with slabs of any other regular figure but one of these three ; because the uniting together of any other forms, by adjusting side to side, would not fill up the space about the corners—there would be either left an angular gap, or else the stones must overlap one another. You will readily see the truth of this from the following considerations :—

Let us first consider the equilateral triangle : as the three angles make two right angles, each must be $\frac{1}{2}$ of two right angles, that is $\frac{1}{3}$ of *four* right angles ; consequently if *six* equilateral triangles were placed side by side, a corner or vertex of each being at the same common point, all the angular space about that point would be completely occupied ; and no one triangle would overlap another, for the angles about a point amount to just four right angles (Prop. XIII., Cor. 2). Let us next consider the square ; and, as each angle of a square is a right angle, it is plain that *four* squares, each with a vertex at the same point, when placed in contact, will exactly fill the space about the point.

The figure next in order is the regular *pentagon*, or five-sided figure. The corollary teaches us that the sum of its five equal angles amounts to six right angles ; consequently each angle is *one* right angle and a *fifth*. Now you cannot multiply $1\frac{1}{5}$ by any whole number that will make the product 4—no such number exists ; in other words, you cannot arrange the angles of pentagons round a point, as the common vertex of all, so as to fill up the *four* right angles about that point ; the pentagon, therefore, must be *rejected*. The next figure is the hexagon. By the corollary we learn that its six equal angles amount to eight right angles ; consequently each angle is equal to $\frac{2}{3}$ of eight right angles ; or, which is the same thing, to $\frac{1}{3}$ of four right angles. It follows,

* Right-lined figures are said to be *regular*, when they are both *equilateral* and *equiangular*.

therefore, that three regular hexagons, placed side by side, round a point, as a common vertex, will exactly fill the space about that point.

We need not extend the examination any further; for, as the sides of regular figures increase in number, the angles increase in magnitude; and, as it has just been seen that *three* angles of a six-sided regular figure make four right angles, more than *two* of a seven, or eight, or nine-sided figure, could never be required; but if *two* equal angles of any figure could make *four* right angles, each angle would equal *two* right angles, which is absurd. It thus follows, that if space about a point is to be filled up by the juxtaposition of regular figures, these figures must be either equilateral triangles, squares, or regular hexagons.

Of these three classes of figures, it is demonstrable, by more advanced principles, that the hexagon will inclose a given amount of space with less extent of outline or border than either of the others; so that if a given surface were to be divided into regular compartments, of equal area, by a network of costly materials, economy, guided by science, would suggest the hexagon as the figure to be chosen. And this is the figure selected by the bee in the construction of the honey-comb. You have seen that of all the figures of geometry, there are but *three* which can so cover a surface as to leave no waste of room—no interstices. The bee chooses one of *them*. Of these three, the hexagon is that which most economizes material:—the bee chooses *it*. It is necessary, too, as well for compactness and strength, as for the safe lodgment of the grub, that the hexagonal cell should terminate in a solid angle. Her choice of angles, that *would do*, is to be made from an infinite variety; but among all these, mathematicians have discovered, by a profound analysis, that there is *one*, and but one, mode of formation by which the object would be attained with the least expenditure of materials; and this one the bee adopts. She closes her hexagonal tube with an angular termination, formed by three plane faces. Each plane cuts off or excludes a portion of the tubular space; but the space within the solid angle just makes up for what is thus rejected; and the faces of the solid angle are so shaped, and so inclined, as to fulfil all the mathematical conditions of a *minimum* of surface; so that while the angular space just compensates for the tubular space cut off, it effects the compensation not only with *less* amount of material, but with the *least* amount possible. The compensating space might be secured in an infinite number of ways. Of this endless variety there is *one* way more economical than any other, and that one is chosen by the bee.

You must regard this reference to the architecture of the bee as a digression, into which I have been allured by the preceding examination of Euclid's corollary. But the subject is full of instruction; and when your mathematical knowledge is sufficiently extensive to enable you fully to estimate the science of the honeycomb, you may, like the ancient geometriician Pappus, feel even additional reverence for the Creator's power, and additional gratitude that you have been endowed with faculties to comprehend and admire the exquisite geometry of the bee.

I shall only further remark here, that this interesting subject will be fully investigated, on mathematical principles, in the treatise on the DIFFERENTIAL CALCULUS, to be hereafter given.

Proposition XXXVII. may be omitted. It is included in the more general theorem, which follows, and which is demonstrated independently of the particular case. What is proved of triangles upon *equal* bases is, of course, proved of triangles on the *same* base.

Propositions XXXV. and XXXVI., about parallelograms, seem to be related to one another, just as these two propositions about triangles are related. But there is a dif-

ference; for, although the thirty-fifth is only a particular case of that which follows, yet it is not superfluous, since the particular case is required in the proof of the general theorem. The thirty-ninth proposition, however, like the thirty-seventh, is superfluous; as the general theorem which follows does not require its aid. The forty-first, too, might have been replaced by a proposition of wider generality. You can give it the extension here suggested by putting "equal bases" for "the same base" in the enunciation, and modifying the construction and demonstration accordingly.

Before passing on to the few remaining propositions, it may be worth while to notice that the term *trapezium* is used in the thirty-fifth proposition for the first time. This is, in fact, the *only* place in which it occurs in the *Elements*, though it is a term frequently employed in the applications of geometry to practical matters, such as mensuration, surveying, &c.

Proposition XLII. requires a word or two. The line A E is improperly introduced, in other editions, into the *construction*; you will see, by attending to the details, that the required parallelogram is completed without any aid from this line; it is in the *demonstration* alone that A E becomes necessary, and therefore its introduction should be deferred till the construction is completed.

Of the forty-seventh proposition but little need be said here. It is stated to have been discovered by Pythagoras, who is recorded to have sacrificed a hundred head of oxen to the gods on the occasion; but this is probably fable. The multiplication table has also been generally attributed to the same philosopher; but the modern French geometrician, M. Chasles, in his historical researches, has shown this to be a mistake.

The proposition in question is one of the most important, in its practical applications, of all the theorems of geometry. Many forms of demonstration have been given; but that of Euclid is not to be surpassed in elegance and clearness.

The last proposition is remarkable only for the peculiarity of its demonstration; it is the converse of the preceding, and is demonstrated in the *direct* manner, contrary to Euclid's general practice of demonstrating converse propositions *indirectly*. As an exercise, you may supply an indirect demonstration yourself: other exercises on the first book are here subjoined.

EXERCISES ON BOOK I.

1. Prove that the two diagonals of a parallelogram bisect each other.
2. If in the sides of a square, at equal distances from the four vertices, four points be taken, one in each side, the figure formed by the four straight lines, joining the four points, will also be a square.
3. From two given points to draw two straight lines, to meet in a given straight line, and to make equal angles with it.
4. Prove that the two lines drawn, as in the last exercise, are together *less* than any other two lines from the points meeting in the given line.
5. To divide a right angle into three equal parts.
6. The diagonals of a rhombus intersect each other at right angles.
7. If the three sides of a triangle be bisected, the perpendiculars drawn to the sides from the three points of bisection will all meet in the same point.
8. The straight line which bisects two sides of a triangle will be parallel to the third side.

9. If the middle points in the sides of any quadrilateral figure are joined by four straight lines, the figure so formed will be a parallelogram.

10. The sum of the angles of a four-sided figure is twice as great as the sum of the angles of a three-sided figure; the sum of the angles of a five-sided figure, three times as great; of a six-sided figure, four times as great; and so on.

11. Through a given point, between two non-parallel straight lines, to draw a third straight line, terminating in the former, which shall be bisected at the given point.

12. From whatever point within an equilateral triangle perpendiculars be drawn to the sides, their sum shall always be the same.

13. If from any point within a parallelogram lines be drawn to the four vertices, each pair of opposite triangles thus formed will be together equal to half the parallelogram.

14. If two triangles have two sides of the one equal to two sides of the other, each to each, and if the angle contained by the two sides of the one, *together with* that contained by the two sides of the other, make two right angles, the two triangles will be equal in surface, or area.

15. In the figure to Proposition XLVII., if FD , GH , EK , be joined, the triangles FBD , GAH , KCE , will all be equal to one another, and to ABC .

16. Prove the *converse* of Proposition XXXIV., namely: if the opposite sides of a quadrilateral be equal, or if the opposite angles be equal, the figure will be a parallelogram.

17. If the points of bisection of the three sides of a triangle be joined, the triangle will be divided into four component triangles, all equal to one another.

ELEMENTS OF EUCLID.—BOOK II.

DEFINITIONS.

I.

Every right angled parallelogram, or *rectangle*, is said to be *contained* by any two of the sides which contain one of its angles: that is, by any two *adjacent* sides.

Thus the rectangle AC is said to be *contained* by the adjacent sides AB , BC , or by AD , DC , and is often called, for brevity, "the rectangle $AB \cdot BC$;" or "the rectangle $AD \cdot DC$." And when the adjacent sides are made equal to two detached lines, each to each, it is common to refer to the rectangle as contained by the lines to which the adjacent sides have been made equal. Thus the rectangle BH , in Proposition I. following, is referred to as the rectangle $A \cdot B$, because $BG = A$.

In every parallelogram, either of the parallelograms about a diagonal, together with the two complements, is called a *gnomon*. Thus the parallelogram HG , together with the complements AF , FC , is a gnomon; it is expressed by the *three* letters $A \cdot G \cdot K$, or $E \cdot H \cdot C$, at the opposite vertices of the parallelograms, which make the gnomon.

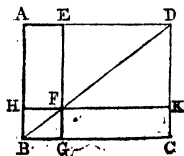

PROPOSITION I.—THEOREM.

If there be two straight lines (A and BC), one of which (BC) is divided into any number of parts, the rectangle contained by the two straight lines is equal to the rectangles contained by the undivided line and the several parts (BD, DE, &c.) of the divided line.

* 11 I. From B draw BF at right angles to BC,* and make BG=A. † Through
 + 3 I. G draw GH parallel to BC, and through D, E, C, draw DK, EL,
 * 31 I. CH parallel to BG.* Then the rectangle BH
 = BK + DL + EH; but BH is contained by A and BC,
 + Const. for BG=A, † and BK is contained by A and
 BD, for BG=A; also, DL is contained by A and DE, for
 * 34 I. DK=BG*=A; and, in like manner, EH is con-
 tained by A and EC, ∴ the rectangle A·BC=A·BD+A·DE+
 A·EC, however many divisions there may be in BC; ∴ if there
 be two straight lines, &c. Q. E. D.

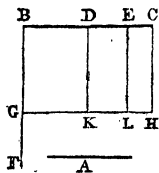

PROPOSITION II.—THEOREM.

If a straight line (AB) be divided into any two parts (AC, CB), the rectangles contained by the whole and each of the parts, are together equal to the square of the whole line: that is, AB·AC + AB·BC = AB².

* 46 I. Upon AB describe the square AE,* and through C draw CF parallel
 † 31 I. to AD or BE. † Then AE=AF+CE; but AE
 * Const. is AB²,* and AF = AD·AC=AB·AC, because
 AD=AB; also CE = AB·BC, for BE = AB, ∴ AB·AC +
 AB·BC = AB²; ∴ if a straight line, &c. Q. E. D.

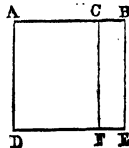

NOTE.—This proposition might have been made a corollary to the pre-
 ceding, since it is only that particular case of the former in which the
 two proposed lines (A, BC) are equal. It is also obvious that the re-
 striction of the number of parts to two is unnecessary.

PROPOSITION III.—THEOREM.

If a straight line (AB) be divided into any two parts (AC, CB), the rectangle contained by the whole and one of the parts is equal to the rectangle contained by the two parts, together with the square of the aforesaid part: that is, AB·BC = AC·CB + BC².

* 46 I. Upon BC describe the square CE;* pro-
 † 31 I. long ED to F, and through A draw AF parallel
 to CD or BE. † Then AE=AD+CE; but AE is the
 rectangle AB·BC, for BC=BE; and AD is the rectangle
 AC·CB, for CD=CB; also CE is BC², ∴ AB·BC
 = AC·CB + BC²; ∴ if a straight line, &c. Q. E. D.

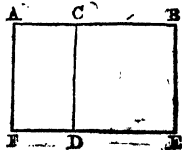

PROPOSITION IV.—THEOREM.

If a straight line (AB) be divided into any two parts (AC, CB) the square of the whole line is equal to the squares of the two parts, together with twice the rectangle contained by the parts: that is, $AB^2 = AC^2 + CB^2 + \text{twice } AC \cdot CB$.

- * 46 I. Upon AB describe the square AE: * draw BD; through C draw CGF
 † 31 I. parallel to AD or BE, and through G draw HK parallel to AB or DE; †
 * 29 I. then CF, AD being parallels, the angle BGC = ADB: * but ADB =
 † 5 I. ABD, because AB = AD, † AE being a square, $\therefore CGB =$
 * 6 I. $CB = CG$; * but $CB = GK$, and $CG = BK$, $\therefore CK$ is
equilateral. It is likewise *rectangular*, for CG, BK being parallels,
 † 29 I. the angles KBC, GCB are = two right angles: † but
 KBC is a right angle, $\therefore GCB$ is a right angle, $\therefore CGK, GKB$,
 * 34 I. opposite to these, are right angles: * $\therefore CK$ is *rect-*
angular; and since it is also *equilateral*, it is a *square*—the square
 of CB. For a similar reason HF is the square of HG, or of AC,
 $\therefore HF, CK$ are AC^2, CB^2 . And because the complement AG
 † 43 I. = the complement GE, † and AG is the rectangle
 $AC \cdot CB$, for $CG = CB$, $\therefore GE = AC \cdot CB$, $\therefore AG + GE = \text{twice } AC \cdot CB$; and HF
 $+ CK = AC^2 + CB^2$, $\therefore HF + CK + AG + GE = AC^2 + CB^2 + \text{twice } AC \cdot CB$;
 that is, $AB^2 = AC^2 + CB^2 + \text{twice } AC \cdot CB$, \therefore if a straight line, &c. Q. E. D.

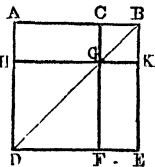

COR.—From this it is manifest, that parallelograms about the diagonal of a square are likewise squares.

PROPOSITION V.—THEOREM.

If a straight line (AB) be divided into two equal parts (in C), and also into two unequal parts (in D), the rectangle contained by the unequal parts, together with the square of (CD), the line between the points of section, is equal to the square of half the line: that is,

- * 46 I. Upon CB describe the square CF: * draw BE; through D draw DHG
 † 31 I. parallel to CE or BF, † and through A draw AK parallel to CL or BM.
 * 43 I. The complement CH = HF: * to
 each of these add DM, $\therefore CM = DF$: but $CM =$
 † 36 I. AL , † since $AC = CB$, $\therefore AL =$
 DF ; to each of these add CH, $\therefore AH = DF +$
 CH : but AH is the rectangle $AD \cdot DB$, for DH
 * 4 II. Cor. = DB; * and $DF + CH$ is the
 gnomon CMG, $\therefore CMG = AD \cdot DB$: to each of
 † 4 II. Cor. these add LG or CD^2 , † $\therefore CMG +$
 $CD^2 = AD \cdot DB + CD^2 = CB^2$; \therefore if a straight line, &c. Q. E. D.

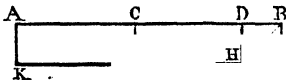

COR.—From this it is manifest, that the difference of the squares of two unequal lines, AC, CD, is equal to the rectangle contained by their sum and difference; that is,

PROPOSITION VI.—T

If a straight line (A B) be bisected (in C), and prolonged to any point (D), the rectangle contained by the whole line (A D) thus prolonged, and the prolonged part (B D), together with the square of (C B) half the line bisected, is equal to the square of (C D), the line made up of the half and the prolonged part: that is, $A D \cdot D B + C B^2 = C D^2$.

* 46 I. Upon C D describe the square C F;* draw D E, and through B draw B H G parallel to C E or D F, and through H
 † 31 I. draw K L M parallel to A D, or E F; †
 also through A draw A K parallel to C L or D M.
 * 36 I. Then because $AC = CB, AL = CH$;
 † 43 I. but $CH = H F$, † $\therefore AL = H F$: K _____ H _____ M
 to each of these add C M, $\therefore AM =$ gnomon
 C M G; but A M is the rectangle A D · D B, for
 * 4 II. Cor. $DM = D B$, * $CMG = AD \cdot DB$:
 † 4 II. Cor. add L G or C B² † to each of these,
 $\therefore CMG + LG = AD \cdot DB + CB^2$; but $CMG + LG = CF = CD$,² $\therefore AD \cdot DB + CB^2 = CD^2$; \therefore if a straight line, &c. Q. E. D.

PROPOSITION VII.—THEOREM.

If a straight line (A B) be divided into any two parts (in C), the squares of the whole line, and of one of the parts, are equal to twice the rectangle contained by the whole and that part, together with the square of the other part: that is, $A B^2 + B C^2 =$ twice $A B \cdot B C + A C^2$. [See Diagram, Prop. IV.]

* 46 I. Upon A B describe the square A E,* and construct the figure as in the
 † 43 I. preceding propositions. Then because $AG = GE$, † if C K be added to each,
 $AK = CE$, $\therefore AK + CE =$ twice AK . But $AK + CE =$ gnomon $AKF + CK$,
 $\therefore AKF + CK =$ twice AK ; but twice $AK =$ twice $A B \cdot B C$, for $BK =$
 * 4 II. Cor. BC , * $AKF + CK =$ twice $A B \cdot B C$. To each of these add $H F$ or
 $A C^2$, $\therefore AKF + CK + H F =$ twice $A B \cdot B C + A C^2$: but $AKF + CK + H F =$
 $A B^2 + B C^2$, $\therefore A B^2 + B C^2 =$ twice $A B \cdot B C + A C^2$; \therefore if a straight line, &c. Q. E. D.

PROPOSITION VIII.—THEOREM.

If a straight line (A B) be divided into any two parts (in C), four times the rectangle contained by the whole and one of the parts (B C), together with the square of the other part (A C), is equal to the square of the line (A D = A B + B C), made up of the whole and that part: that is, four times $A B \cdot B C + A C^2 = A D^2$.

* 3 I. Prolong A B to D, so that $B D = C B$;* and upon A D describe the square
 † 46 I. A F; † and construct two figures such as in the preceding. Then because
 * 34 I. $CB = B D$, and $CB = G K$, and $BD = K N$,*
 $\therefore GK = KN$. For a like reason, $PR = RO$; and because
 $CB = B D$, and $GK = K N$, $\therefore CK = B N$, and GR
 † 36 I. $R N$. † But $CK = R N$, being comple-
 * 43 I. ments,* $\therefore BN = GR$, \therefore the four rectangles,
 BN, CK, GR, RN , are equal, and are therefore quadruple of CK . Again, because $CB = B D$, and $BD =$
 † 4 II. Cor. $BK + CG$, and $CB = G K = G P$, † $\therefore CG$
 * 34 I. $= G P$, and because $CG = G P$, and $PR =$
 † 4 II. Cor. $= G P$, and because $CG = G P$, and $PR =$
 * 36 I. RO , $\therefore AG = M P$,* and $PL = R F$. But

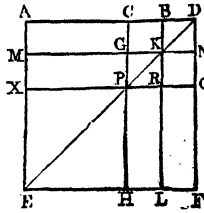

† 43 I. $MP = PL$, being complements, † $\therefore AG = EF$, \therefore the four, AG, MP, PL, EF , are equal, and are together quadruple AG . And it was proved that the four, CK, BN, GB, EN , are quadruple CK , \therefore the eight rectangles, which compose the gnomon AOH , are quadruple of AK ; and because $AK = AB \cdot BC$, for $BK = BC$, \therefore four times $AB \cdot BC =$ four times AK : but it was proved that $AOH =$ four times AK , * 4 II. Cor. \therefore four times $AB \cdot BC = AOH$. To each of these add XH or AC^2 , * \therefore four times $AB \cdot BC + AC^2 = AOH + XH$; but $AOH + XH = AD^2$, \therefore four times $AB \cdot BC + AC^2 = AD^2$; \therefore if a straight line, &c. Q. E. D.

NOTE.—For another and shorter demonstration of this proposition, see the remarks at the end of Book II.

PROPOSITION IX.—THEOREM.

If a straight line (AB) be divided into two equal, and also into two unequal parts (in C and D), the squares of the two unequal parts are together double of the square of half the line (AC), and of the square of the line (CD), between the points of section: that is, $AD^2 + DB^2 =$ twice $AC^2 +$ twice CD^2 .

* 11 I. From C draw CE at right angles to AB; * and make it = AC or
 † 3 I. CB. † Draw EA, EB; and through D draw DF parallel to CE, and
 * 31 I. through F draw FG parallel to BA; * draw also AF. Then because
 † 5 I. $AC = CE$, the angle $EAC = AEC$; † and because ACE is a right
 * 32 I. angle, the two others, AEC, EAC, must together make one right
 angle, * and as they are equal, each must be half a right angle. For a like reason, each
 of the angles, CEB, ECB, is half a right angle, $\therefore AEB$ is a right angle. And
 because GEF is half a right angle, and EGF a
 † 29 I. right angle, for it is = ECB, † \therefore the
 remaining angle EFG is half a right angle, $\therefore GEF =$
 * 6 I. EFG, and $\therefore EG = GF$. * Again, because
 B is half a right angle, and FDB a right angle, for it is
 † 29 I. = ECB, † \therefore the remaining angle, BFD,
 is half a right angle, $\therefore B = BFD$, and $\therefore DF =$
 * 6 I. DB. * And because $AC = CE$, $\therefore AC^2 = CE^2$, $\therefore AC^2 + CE^2 =$ twice
 † 47 I. AC^2 ; but $AE^2 = AC^2 + CE^2$, because ACE is a right angle, † $\therefore AE^2 =$
 twice AC^2 . Again, because $EG = GF$, $\therefore EG^2 = GF^2$, $\therefore EG^2 + GF^2 =$ twice
 * 47 I. GF^2 ; but $EF^2 = EG^2 + GF^2$, * $\therefore EF^2 =$ twice GF^2 ; and $GF =$
 † 34 I. CD, † $\therefore EF^2 =$ twice CD^2 . but $AE^2 =$ twice AC^2 , $\therefore AE^2 + EF^2 =$
 * 47 I. twice $AC^2 +$ twice CD^2 : but $AF^2 = AE^2 + EF^2$, * because AEF is
 a right angle, $\therefore AF^2 =$ twice $AC^2 +$ twice CD^2 : but $AD^2 + DF^2 = AF^2$, because
 † 47 I. ADF is a right angle, † $\therefore AD^2 + DF^2 =$ twice $AC^2 +$ twice CD^2 ;
 and $DF = DB$, $\therefore AD^2 + DB^2 =$ twice $AC^2 +$ twice CD^2 ; \therefore if a straight line, &c.
 Q. E. D.

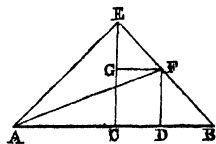

PROPOSITION X.—THEOREM.

If a straight line (AB) be bisected (in C), and prolonged to any point (D), the square of the whole line thus prolonged, and the square of the part of it prolonged (DB), are together double the square of (AC) half the line bisected, and of the square of (CD) the line made up of the half and the prolonged part: that is, $AD^2 + DB^2 =$ twice $AC^2 +$ twice CD^2 .

* 11 I. From C draw CE at right angles to AB, * and make it = AC or CB; †
 † 3 I. and draw AE, EB. Through E draw EF parallel to AB, and through

* 31 I. D draw DF parallel to CE.* Then because EC, FD are parallels, the
 † 29 I. angles CEF + EFD = two right angles, † ∴ BEF + EFD are less
 * Ax. 12. than two right angles, ∴ EB, FD, if prolonged, will meet towards B, D.*
 Let them meet in G; and draw AG. Then because AC = CE, the angle CEA =
 † 5 I. EAC, † and ACE is a right angle, ∴ CEA, EAC are each half a right
 * 32 I. angle.* For a like reason, CEB, EBC are each half a right angle, ∴
 AEB is a right angle. And because EBC is half a right angle, DBG also is half a right
 † 15 I. angle, for they are vertically opposite: † but BDG is a right angle, being
 = DCE, ∴ the remaining angle DGB is half a right angle, and is ∴ = DBG, ∴ BD
 * 6 I. = DG.*

Again, because EGF is half a right angle, and that F is a right angle, being = the
 † 34 I. opposite angle ECD, † ∴ the remaining
 angle FEG is half a right angle, ∴ FEG = EGF, ∴ GF

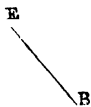

* 6 I. = FE.* And because EC = CA, ∴
 EC² = CA², ∴ EC² + CA² = twice CA²: but EA²
 † 47 I. = EC² + CA², † ∴ EA² = twice AC².

Again, because GF = FE, ∴ GF² = FE², ∴ GF² +
 * 47 I. FE² = twice FE²; but EG² = GF² + FE², †

† 34 I. ∴ EG² = twice FE², and FE = CD, † ∴ EG² = twice CD². But it
 was demonstrated that EA² = twice CA², ∴ AE² + EG² = twice AC² + twice CD²;

* 47 I. but AG² = AE² + EG²,* ∴ AG² = twice AC² + twice CD²; but
 † 47 I. AD² + DG² = AG², † ∴ AD² + DG² = twice AC² + twice CD²;

but DG = DB, ∴ AD² + DB² = twice AC² + twice CD²; ∴ if a straight line, &c.

NOTE.—For other demonstrations of the last two propositions, see the remarks at the
 end of this book.

PROPOSITION XI.—PROBLEM.

To divide a given straight line (AB) into two parts, so that the rectangle contained by the
 whole, and one of the parts, shall be equal to the square of the other part.

* 11 & 3 I. From A draw AC perpendicular and equal to AB; * bisect AC in
 † 10 I. E, † and draw BE. Prolong CA to F, making EF = EB,* and
 * 3 I. from AB cut off AH = AF: † AB shall be divided in H, so that

* 46 I. Complete the square BC, as also the square FH; * and prolong GH
 to K. Then because AC is bisected in E and prolonged to F, the

† 6 II. rectangle CF·FA + AE² = EF²; † but EF =
 * Const. EB,* ∴ CF·FA + AE² = EB²; but BA² +
 AE² = EB², because EAB is a right angle, ∴ CF·FA + AE² =
 BA² + AE²: take away AE², which is common to both, ∴ CF·FA
 = BA². But FK = CF·FA, for AF = FG; and AD = BA, †
 ∴ FK = AD. Take away AK, common to both, ∴ FH = HD:
 but HD = AB·BH, for AB = BD, and FH is AH², ∴
 AB·BH = AH²; ∴ AB is divided in H, so that AB·BH =
 AH². Which was to be done.

PROPOSITION XII.—THEOREM.

In an obtuse-angled triangle (A B C), if a perpendicular (A D) be drawn from either of the acute angles to the opposite side prolonged, the square of the side (A B) subtending the obtuse angle is greater than the squares of the sides (B C, C A) containing the obtuse angle, by twice the rectangle contained by the side upon which, when prolonged, the perpendicular falls, and the line, without the triangle, between the perpendicular and the obtuse angle; that is, $A B^2 = B C^2 + C A^2 +$ twice $B C \cdot C D$.



Because B D is divided into two parts in C, $B D^2 = B C^2$
 * 4 II. $+ C D^2 +$ twice $B C \cdot C D$. * To each of these add $D A^2$, $\therefore B D^2 + D A^2 = B C^2 + C D^2 + D A^2 +$ twice $B C \cdot C D$; but $A B^2 = B D^2 + D A^2$, and $C A^2 = C D^2 + 47 I. + D A^2$, $\therefore A B^2 = B C^2 + C A^2 +$ twice $B C \cdot C D$; that is, the square of A B is greater than the squares of B C C A by twice $B C \cdot C D$; \therefore in an obtuse-angled triangle, &c. Q. E. D.

PROPOSITION XIII.—THEOREM.

In every triangle (A B C), the square of a side (A C) subtending an acute angle, is less than the squares of the sides (C B, B A) containing that angle, by twice the rectangle (C B B D) contained by either of these sides, and the straight line intercepted between the perpendicular (A D) and the acute angle (B): that is, $A C^2 = C B^2 + B A^2 -$ twice $C B \cdot B D$.

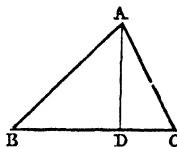

First, let A D fall within the triangle; then, because C B is divided into two parts in D, $C B^2 + B D^2 =$ twice $C B \cdot B D$
 * 7 II. $+ D C^2$. * To each of these add $A D^2$, $\therefore C B^2 + B D^2 + A D^2 =$ twice $C B \cdot B D + D C^2 + A D^2$: but $B A^2 = B D^2 + A D^2$, and $A C^2 + 47 I. = D C^2 + A D^2$, $\therefore C B^2 + B A^2 = A C^2 +$ twice $C B \cdot B D$. From each of these take twice $C B \cdot B D$, $\therefore A C^2 = C B^2 + B A^2 -$ twice $C B \cdot B D$.

Secondly, let A D fall without the triangle; then, because D is a right angle, A C B is greater than a right
 * 16 I. angle, $\therefore A B^2 = A C^2 + C B^2 +$ twice
 * 12 II. $B C \cdot C D$. † To each of these add $B C^2$, $\therefore A B^2 + B C^2 = A C^2 +$ twice $B C^2 +$ twice $B C \cdot C D$. But because B D is divided into two parts in C, $D B \cdot B C = B C \cdot C D$
 * 8 II. $B C^2$, * and the doubles of these being equal, $\therefore A B^2 + B C^2 = A C^2 +$ twice $D B \cdot B C$. From each of these take twice $D B \cdot B C$, $\therefore A C^2 = A B^2 + B C^2 -$ twice $D B \cdot B C$; \therefore in every triangle, &c.

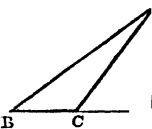

PROPOSITION XIV.—PROBLEM.

To describe a square that shall be equal to a given rectilineal figure (A).

* 45 I. Describe the rectangle $B D = A$. * Then, if the sides of it, $B E$, $E D$, are equal, it is a square, and what was required is now done; but if they are not equal,
 + 10 I. prolong one of them, $B E$ to F , and make $E F = E D$. Bisect $B F$ in G , †

and with centre G and radius GB, or GF, describe the semicircle BHF, and prolong DE to H. The square described upon EH shall be equal to the given figure A. Draw GH. Then, because BF is divided into two equal parts in G, and into two unequal parts in E, $BE \cdot EF + EG^2 =$

* 5 II. GF^2 ; * but $GF = GH$, $\therefore BE \cdot EF + EG^2 =$
 + 47 I. GH^2 ; but $HE^2 + EG^2 = GH^2$,
 $\therefore BE \cdot EF + EG^2 = HE^2 + EG^2$. Take away EG^2 , which is common to both, $\therefore BE \cdot EF = HE^2$;
 but $BE \cdot EF = BD$, because $EF = ED$, $\therefore BD = HE^2$;
 but $BD = A$, $\therefore HE^2 = A$; \therefore a square
 described upon EH is = to the given rectilinear figure.

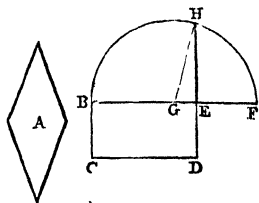

Which was to be done.

REMARKS ON BOOK II.

All the propositions in this book, except the last three, concern the divisions of straight lines into parts, and the equality of rectangles having certain of these parts for their sides. The first proposition is little more than an axiom, as its object is to show that any rectangle BH is equal to the sum of the partial rectangles BK, DL, &c., into which it is divided: but, as already observed (p. 72), Euclid does not regard as an axiom any proposition that admits of demonstration.

Proposition II. might, without impropriety, have been appended as a corollary to Proposition I., as already stated in the text; since, if the line A, in Proposition I., be considered to be equal to the line BC, this proposition will virtually include the next following.

Proposition V. authorises us to affirm, as an inference, that the rectangle contained by the two halves of a straight line, is greater than the rectangle contained by any two unequal parts of it, since it shows that to this latter rectangle something must be added to make up the square of half the line.

In attempting the propositions in this book, without reference to the text, you will find it useful to keep in remembrance that in all the constructions, up to Proposition VIII. inclusive, the greatest square mentioned in the enunciation is always to be described first; and that in each proposition after the fourth, the lines employed in that fourth are always to be introduced. After this partial construction, the completion of the diagram, in each case, will readily present itself.

It may, too, be deserving of notice that the demonstrations in Propositions V. and VI. may, with advantage, be conducted rather differently from the method of Euclid. Thus, in Proposition V., having proved, as in the text, that the projecting rectangle AL is equal to the marginal rectangle DF, we may proceed as follows:—Take each of these rectangles from the entire figure; then the remainder CF will be equal to the remainder AH + LG, that is, to the rectangle AD·DB (for DB = DH), and the square of CD, since LH = CD: and this completes the demonstration.

In like manner, in Proposition VI., having proved, as in the text, that the projecting rectangle AL is equal to the marginal rectangle HF, take each rectangle from the entire figure; then the remainder CF is equal to the remainder AM + LG: that is, $CD^2 = AD \cdot DB + CB^2$; which completes the proof.

Proposition VIII. is usually found, by a beginner, to be a little perplexing; and Propositions IX. and X., though very elegantly demonstrated by Euclid, are felt to be

somewhat lengthy. I shall, therefore, here show how these three propositions may be otherwise demonstrated.

Prop. VIII.—Having made $BD = CB$, the reasoning may be as follows :

$$\text{By Prop. IV., } AD^2 = AB^2 + BD^2 + 2 AB \cdot BD;$$

$$\text{that is, } AD^2 = AB^2 + CB^2 + 2 AB \cdot CB.$$

$$\text{Also, Prop. VII., } AB^2 + CB^2 = 2 AB \cdot CB + AC^2;$$

$$\therefore AD^2 = 2 AB \cdot CB + AC^2 + 2 AB \cdot CB$$

$$\text{that is, } AD^2 = 4 AB \cdot CB + AC^2.$$

Which was to be demonstrated.

$$\text{Prop. IX.—By Prop. IV., } AD^2 = AC^2 + CD^2 + 2 AC \cdot CD;$$

$$\therefore AD^2 + DB^2 = AC^2 + CD^2 + 2 AC \cdot CD + DB^2;$$

$$\text{that is, } AD^2 + DB^2 = BC^2 + CD^2 + 2 BC \cdot CD + DB^2.$$

$$\text{But, Prop. VII., } BC^2 + CD^2 = 2 BC \cdot CD + DB^2;$$

$$\therefore AD^2 + DB^2 = BC^2 + CD^2 + BC^2 + CD^2;$$

$$\text{that is, } AD^2 + DB^2 = 2 BC^2 + 2 CD^2 = 2 AC^2 + 2 CD^2.$$

Which was to be demonstrated.

Proposition X.—The demonstration of this may be made to depend on the preceding proposition, as follows :—

Prolong CA to H, making $AH = BD$;

then $HC = CD$, and $HB = DA$.

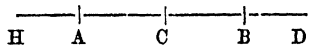

And since HD is divided equally in C , and unequally in B , \therefore by Proposition IX.,

$$HB^2 + BD^2 = 2 HC^2 + 2 CB^2;$$

$$\text{that is, } AD^2 + BD^2 = 2 CD^2 + 2 AC^2.$$

Which was to be demonstrated.

Although the foregoing demonstrations occupy less space than those of Euclid, I would by no means recommend them to your preference. Those of Euclid are among the finest of his specimens of clear and consecutive reasoning, and you will observe that they are altogether independent of second-book propositions. They are thus simpler, though longer than those given above. There is, too, a beauty in the reiterated appeals to the forty-seventh of the first book, that more than compensates for the length of the argument. The demonstrations above, however, may be useful as exercises on the application of second-book propositions.

There are but two *problems* in this second book; and each of these, as given in the editions of Simson and others, exemplifies the remark made in the commentary on the preceding book, in reference to Euclid's apparent indifference as to the neatness and finish of his *constructions*.

In the editions alluded to, the whole of the diagram in Proposition XI., with the exception of the prolongation of GH to K , is made to appear as essential to the construction of the problem; that is, to the determination of the point H . You have seen, however, that to the discovery of this point, the actual construction of the two squares AD , AG is not necessary; they are wanted only as part of the machinery in the *demonstration* that the point H , previously found, divides the proposed line as required.

In Proposition XIV., too, the drawing of GH is made to enter into the construction of the problem, instead of being postponed for use in the demonstration, as is done in this edition.

You will not fail to notice the connection between Propositions XII. and XIII., and Proposition XLVII., of the first book. The three together furnish certain corresponding

relations between one side of a triangle and the other two, whether the angle opposite that one be right, obtuse, or acute.

It may not, perhaps, be out of place here to notice, that the word *equal*, employed so frequently in this and in the preceding book, in reference to rectangles, triangles, &c., is used by Euclid in two somewhat different senses. In the earlier propositions of the first book—the fourth, eighth, and twenty-sixth, for instance—the test of equality is perfect *coincidence*, as the result of superposition; but in Propositions XXXV., XXXVI., &c., as also in most of the propositions of this second book, the condition of coincidence is excluded, and the figures are declared to be equal if they are proved to inclose the same extent of surface. Legendre, a distinguished French geometer, has proposed to discriminate between these two kinds of equality; figures which, though equal in surface, do not admit of coincidence, he prefers to call—not *equal* figures, but *equivalent* figures. I think the distinction an appropriate one; and, while upon these minor matters of mere phraseology, I would venture further to suggest, that instead of speaking of lines as *greater* and *less*, the more explicit and restrictive terms *longer* and *shorter* would be preferable; and that *part* of a line, or *portion* of a line, arc, either of them, designations that might appropriately supply the place of *segment* of a line.

EXERCISES ON BOOKS I. AND II.

1. In any triangle, the squares of the two sides are together equal to the square of half the base, and of the straight line from the vertex to the middle of the base.
2. The squares of the four sides of a parallelogram are together equal to the squares of the two diagonals.
3. If from any point lines be drawn to the four vertices of a rectangle, the squares of those drawn to opposite vertices will together be equal to the squares of the other two.
4. In every parallelogram the squares of the four sides are together equal to the squares of the two diagonals.
5. If from any point whatever lines be drawn to the four vertices of a parallelogram, twice the sum of their squares will be equal to the squares of the diagonals, together with eight times the square of the line drawn from the given point to the intersection of the diagonals.
6. From the last exercise prove that the following curious property has place, namely:—If from the point of intersection of the diagonals of a parallelogram a circle be described with any radius, the squares of the lines drawn from any point in the circumference to the four corners of the parallelogram, will always amount to the same sum.
7. In any quadrilateral the sum of the squares of the four sides is equal to the sum of the squares of the diagonals, together with four times the square of the line joining the middle points of the diagonals.
8. Prove the *converse* of Example 2 above, namely:—If the squares of the sides of a quadrilateral are together equal to the squares of the diagonals, the figure must be a parallelogram.
9. Let a straight line be divided according to Proposition XI. Book II., and from the greater segment cut off a part equal to the less: prove that this greater segment will thus be divided also according to the same proposition.

ELEMENTS OF EUCLID.—BOOK III.

DEFINITIONS.

I.

A straight line is said to *touch* a circle when it *meets* the circle, and being prolonged, does not *cut* it.

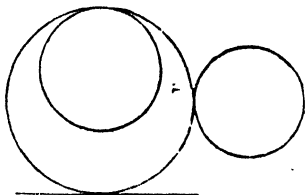

II.

Circles are said to *touch* one another, which *meet*, but do not cut one another.

III.

Straight lines are said to be equally distant from the centre of a circle, when the perpendiculars drawn to them from the centre are equal.

IV.

And the straight line on which the greater perpendicular falls is said to be farther from the centre.

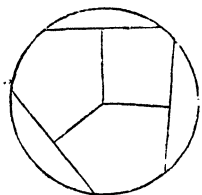

V.

An *arc* of a circle is any part of the circumference.

VI.

A *segment* of a circle is the figure contained by an arc of a circle and the straight line joining its extremities, which straight line is called the *chord* of the arc, or the *base* of the segment.



An *angle in a segment* is the angle contained by two straight lines drawn from any point in the arc of the segment to the extremities of the chord of the arc or base of the segment. Thus A is an angle in the segment BAC.

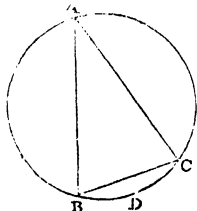

And an angle is said to *insist* or *stand* upon the arc intercepted between the straight lines that contain the angle. Thus A stands upon the arc BDC.

IX.

A *sector* of a circle is the figure contained by two straight lines drawn from the centre, and the arc between them. ABC is a *sector*, so is the remaining part of the circle.

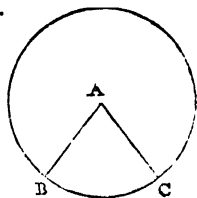

Similar segments of circles are those in which the angles are equal, or which contain equal angles.



PROPOSITION I.—PROBLEM.

To find the centre of a given circle (ABC).

Draw any straight line AB, terminating in the circumference, and bisect it in

- * 10 I. D : * draw DC at right angles to AB, † prolong it to E, and bisect CE
- † 11 I. in F : * the point F shall be the centre of the circle.
- * 10 I.

For if it be not, let G, a point out of the line CE, be the centre: and draw GA, GD, GB. Then because DA = † Const. DB, † and DG common to the two triangles ADG, BDG, the two sides AD, DG are = the two BD, DG, each to each, and the base GA = the base GB, because G is

* Def. 12 l. the centre, * ∴ the angle GDA = GDB : † † 8 I. but when a straight line standing upon another makes the adjacent angles equal, each angle is a right

* Def. 8 I. angle; * ∴ GDB is a right angle: but FDB is † Const. likewise a right angle, † ∴ GDB = FDB, the less to the greater, which is impossible, ∴ the centre cannot be at any point out of the line CE: it must ∴ be at a point in CE, and ∴ at the middle of CE, ∴ F is the centre, which was to be found.

Cor.—From this it is manifest that if a chord of a circle (as AB) be bisected by a perpendicular, that perpendicular will pass through the centre.

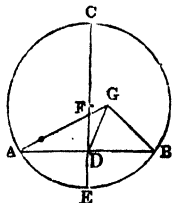

PROPOSITION II.—THEOREM.

If two points (A, B) be taken in the circumference of a circle (ABC), the straight line or chord (AB) which joins them shall fall within the circle.

* 1 III. For if not, let it fall without, as AEB. Find D, the centre of the circle, * and draw DA, DB. In the arc AB take any point F, draw DF,

† Def. 12 I. and produce it to E: then because DA = DB, †

* 5 I. the angle DAB = DBA : * and because AE, a side of the triangle DAE, is prolonged to B, the exterior angle

† 10 I. DEB is greater than DAE : † but DAE =

DBE, as just proved : ∴ DEB is greater than DBE; but to

* 19 I. the greater angle the greater side is opposite, *

† Def. 12 I. ∴ DB is greater than DE: but DB = DF, † ∴

DF is greater than DE, which is impossible, ∴ AB does not fall without the circle.

And since DB, the radius of the circle, is greater than DE, and that E is any point on the chord, between A and B, ∴ no point between A and B can be on the circumference,

∴ the chord AB is wholly within the circle; ∴ if any two points, &c. Q. E. D.

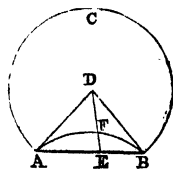

PROPOSITION III.—THEOREM.

If a straight line (CD) through the centre of a circle (ABC) bisect a chord (AB), which does not pass through the centre, it shall cut it at right angles; and if it cut the chord at right angles, it shall bisect it.

* 1 III. Take E, the centre of the circle, * and draw EA, EB. Then because

† Hyp. $AF = FB$, † and FE common to the two triangles AFE , BFE , and also

* 8 I. $EA = EB$, \therefore the angle $AFE = BFE$, *

† Def. 8 I. \therefore each is a right angle, † $\therefore CD$, drawn through the centre, bisecting the chord AB , that does not pass through the centre, cuts it at right angles.

Now let CD cut AB at right angles: CD shall bisect AB . For, the same construction being made, because $EA = EB$,

* 5 I. the angle $EAF = EBF$; * and the right angle $AFE = BFE$, \therefore in the two triangles, BAE , EBE , there are two angles in the one = two in the other, each to each; and EF , opposite to equal angles, one in each, is common to

+ 26 I. both, $\therefore AF = FB$; † that is, the chord AB is bisected by the diameter CD , which is perpendicular to it; \therefore if a straight line, &c. Q. E. D.

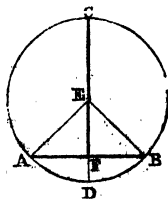

PROPOSITION IV.—THEOREM.

If in a circle ($ABCD$) two chords (AC , BD) cut one another, and do not pass through the centre, they do not bisect each other.

For let them cut in E ; and suppose $AE = EC$, and $BE = ED$. If one of the chords pass through the centre, it is plain it cannot be bisected by the other which does not pass through the centre, because the middle of the former is the centre. But if neither pass through the centre, take F ,

* 1 III. the centre; * and draw FE . Then, because FE , through the centre, bisects AC not through the centre,

+ 3 III. it cuts it at right angles, † $\therefore FEA$ is a right

* Hyp. angle. Again, because FE bisects BD , * a chord not through the centre, it cuts it also at right

+ 3 III. angles, † $\therefore FEB$ is a right angle; but it was proved that FEA is a right angle, $\therefore FEA = FEB$, the less

to the greater, which is impossible, $\therefore AC$, BD do not bisect one another; \therefore if in a circle, &c. Q. E. D.

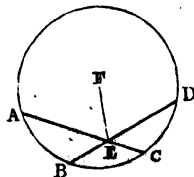

PROPOSITION V.—THEOREM.

If two circles (ABC , CDG) cut one another (as in the point C), they shall not have the same centre.

For, if it be supposed possible, let E be the common centre. Draw EC , and draw EFG , meeting the circumferences in F and G . Then, because E is the centre of the

* Def. 12 L. circle ABC , $EC = EF$. * Again, because E is the centre of the circle CDG , $EC = EG$. But it was shown that $EC = EF$, $\therefore EF = EG$, the less to the greater, which is impossible, \therefore the two circles have not a common centre; \therefore if two circles, &c. Q. E. D.

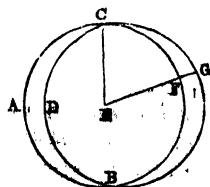

PROPOSITION VI.—THEOREM.

If two circles (ABC, CDE) touch one another they shall not have the same centre.

Let them touch at C, then if they have a common centre, let it be F. Draw FC, and FEB, meeting the circumferences in E and B. Then, because F is the centre of ABC, $FC =$

* Def. 12 I. FB ; * also, because F is the centre of CDE,

$FC = FE$; * but it was shown that $FC = FB$, $\therefore FE = FB$, the less to the greater, which is impossible, \therefore the two circles have not a common centre; \therefore if two circles, &c. Q. E. D.

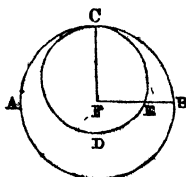

PROPOSITION VII.—THEOREM.

If any point (F), not the centre, be taken in the diameter (AD) of a circle (ABCD), then of all lines (FA, FB, FC, &c.) which can be drawn from it to the circumference, the greatest is that (FA) which passes through the centre (E), and (FD), the other part of the diameter, is the least. And of the others, that which is nearer to the line through the centre is always greater than one more remote. And from the same point (F) there can be drawn two, and only two, straight lines that are equal, one upon each side of the diameter.

Draw EB then because any two sides of a triangle are together greater than the * 20 I. third side, FE, EB are greater than FB; * but $EA = EB$, $\therefore FE + EA$, that is, FA is greater than FB, and FB is any other line, \therefore the line through the centre is the greatest. Again, draw EC: then, because $EB = EC$, and FE common to the triangles BEF, CEF, \therefore the two sides FE, EB are = the two FE, EC, each to each; but the angle BEF is greater

† 24 I. than CEF, \therefore FB is greater than FC, † \therefore the line nearer to that through the centre is greater than one more remote.

Again, draw EG: then, because $EF + FG$ are greater * 20 I. than EG, * and that $EG = ED$, $\therefore EF + FG$ are greater than ED. Take away the common part EF, \therefore FG is greater than FD, and FG is any other line, \therefore FD is the least of all the lines from F to the circumference.

Also two, but only two, equal straight lines can be drawn from F to the circumference, one upon each side of the diameter AD. For FG being any straight line from

+ 23 I. F, at E make the angle FEH = FEG, † and draw FH. Then, because $EG = EH$, and EF common to the triangles GEF, HEF, the two sides EG, EF are = * Const. the two EH, EF, each to each, and the angle GEF = HEF, * $\therefore FG =$

† 4 I. FH. † But, besides FH, no other line equal to FG can be drawn from F to the circumference. For, if there was, let it be FK: then, because $FK = FG$ and $EG = FH$, $\therefore EK = EH$; but one of these must be nearer to the line through the centre than the other, so that a line nearer to that through the centre is equal to one more remote, which has been proved to be impossible, \therefore besides FH no other line = FG can be drawn; \therefore if any point, &c. Q. E. D.

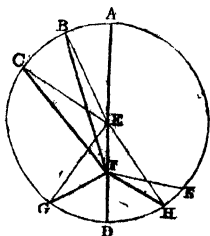

PROPOSITION VIII.—THEOREM.

If any point (D) be taken without a circle (ABF), and straight lines (DA, DE, DF, &c.) be drawn from it to the circumference, of which one (DA) passes through the centre (M), of those which fall upon the concave part of the circumference, the greatest is that (DA) which passes through the centre, and of the rest, that which is nearer to the one through the centre is always greater than one more remote. But of those which fall upon the convex part of the circumference, the least is that (DG) which, when prolonged, passes through the centre; and of the rest, that which is nearer to the least it always less than one more remote. Also two, and only two, equal straight lines can be drawn from the same point (D) to the circumference, one upon each side of the line through the centre.

* 1 III. Take M the centre of the circle,* and draw ME. Then because AM = EM, add MD to each, $\therefore AD = EM + MD$; but EM + MD are greater than \dagger 20 I. ED, $\dagger \therefore AD$ is greater than ED, and ED is any other line, $\therefore AD$, the line through the centre, is the longest.

Again, draw MF. Then, because EM = FM, the two EM, MD are = the two FM, MD, each to each; but the angle EMD is greater than FMD, $\therefore ED$ is greater than \dagger 24 I. FD;* that is, a line DE nearer to that through the centre is greater than DF, one more remote.

\dagger 20 I. Now draw MK. Then because MK + KD are greater than MD, \dagger and that MK = MG, \therefore the remainder KD is greater than the remainder GD; that is GD is less than KD, any other line from D to the convex part of the circumference, $\therefore DG$ is the least line. Draw ML: then because MLN is a triangle, and that MK, DK are drawn from the extremities of a side to a point K, within the triangle, $\therefore MK + \dagger$ 21 I. DK are less than ML + DL:* but MK = ML, \therefore the remainder DK is less than the remainder DI; that is, a line nearer to the least is less than one more remote.

Also, there can be drawn two, but only two, equal straight lines from D to the circumference, one on each side of DA, the line through the centre. For draw any straight line DK, and at M make the angle DMB = \dagger 23 I. DMK; \dagger and draw DB. Then because MK = MB, the two MK, MD are = the two MB, MD, each

* Const. to each; and the angle KMD = BMD,* \therefore \dagger 4 I. DK = DB, \dagger so that two equal lines can be drawn, and the demonstration is the same whether DK be drawn to the convex or to the concave part of the circumference. But, besides DB, no straight line drawn from D to the circumference, can be = DK. For, if there can, let it be DN. Then because DK = DN, and DK = DB, \therefore DN = DB; but one of these must be nearer to that through the centre than the other, \therefore a line nearer to that through the centre is = one more remote, which has been proved to be impossible; \therefore if any point, &c. Q. E. D.

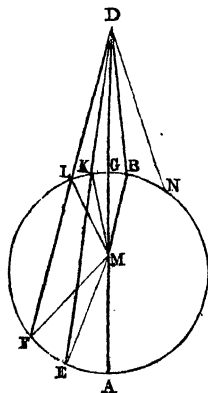

PROPOSITION IX.—THEOREM.

If any point be taken, from which there may be drawn more than two equal straight lines to the circumference of a circle, that point is the centre of the circle.

For if the point were *not* the centre, only *two* equal straight lines could be drawn * 7 & 8 III. from it to the circumference; * \therefore if any point, &c.

PROPOSITION X.—THEOREM.

One circumference of a circle cannot cut another in more points than two.

For suppose the circumference FABC to cut the circumference DEGF in more than two points, viz., in B, G, F. Take the centre K, of the circle

* 1 III. FABC, * and draw KB, KG, KF. Then because K is the centre of the circle FAB, these lines are all equal; so that from a point K, to the other circumference DEGF, more than two equal straight lines are drawn, viz., the three KB, KG, KF, \therefore K is the centre + 9 III. of the circle DEGF, † \therefore the same point is the centre of two circles that cut one another, which * 5 III. is impossible; * \therefore one circumference, &c.

Q. E. D.

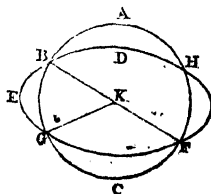

PROPOSITION XI.—THEOREM.

If one circle (ADE) touch another (ABC) internally in a point (A), the straight line which joins their centres being prolonged, shall pass through the point of contact (A).

Let F be the centre of ABC, and G the centre of ADE; FG when prolonged shall pass through A.

For if not, let FG, prolonged, cut the circumferences in D and H. Draw AF, AG:

then, because two sides of a triangle are together greater than the third side, FG + GA are greater than FA: * 20 I. but FA = FH, \therefore FG + GA are greater than FH. Take away the common part FG, \therefore GA is greater than GH: but GA = + Def. 12 I. GD, † \therefore GD is greater than GH, which is impossible, even could D, H coincide, \therefore FG being prolonged, cannot but pass through the point A; \therefore if one circle, &c. Q. E. D.

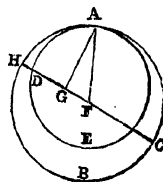

PROPOSITION XII.—THEOREM.

If two circles (ABC, ADE) touch each other externally in a point (A), the straight line which joins their centres shall pass through the point of contact (A).

Let F be the centre of ABC, and G that of ADE: FG shall pass through A.

For if not, let FG cut the circumferences in C, D, and draw FA, GA. Then because F is the centre of ABC, $FA = FC$: and because G is the centre of ADE, $GA = GD$, $\therefore FA + GA = FC + GD$, \therefore the whole FG is not less than FA + GA, even though C, D be supposed to coincide; but a side FG, of the triangle AFG, is less than * 20 I. the other two sides,* which is impossible, \therefore FG cannot pass otherwise than through the point of contact A; \therefore if two circles, &c. Q. E. D.

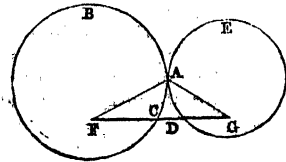

PROPOSITION XIII.—THEOREM.

One circle cannot touch another in more than one point, whether it touch it on the inside or on the outside.

For, if it be supposed possible, let the circle EBF touch the circle ABC in two points; and first on the inside, in the points B, D. Join B, D, and draw GH, bisecting * 10 & 11 I. BD at right angles.* Then because the points B, D are in the circumference of each of the circles, BD falls

+ 2 III. within each of them, \therefore their centres are in GH, which bisects * 1 III. Cor. BD at right angles,* \therefore GH passes through the point of contact B, and through the point of contact D: \dagger but the points B, D are without the straight line GH, which is absurd; \therefore one circle cannot touch another on the inside in more than one point.

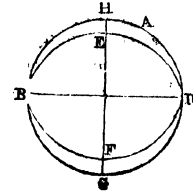
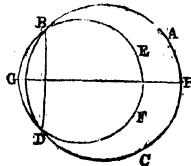

Nor can two circles touch on the outside in more than one point. For suppose the circles ACK, ABC to touch in two points, A, C. Join A, C: then because A, C are in the circumference ACK, AC, which joins them falls, within the * 2 III. circle ACK.* But the circle ACK is without the circle ABC, \dagger \therefore AC is without this last circle; but, because A, C are in the circumference ABC, AC must be within * 2 III. the same circle,* which is absurd, \therefore one circle cannot touch another on the outside in more than one point; and it has been shown, that they cannot touch on the inside in more than one point; \therefore one circle, &c. Q. E. D.

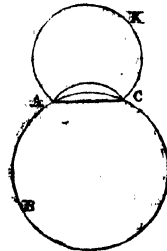

PROPOSITION XIV.—THEOREM.

Equal chords (AB, CD) in a circle are equally distant from the centre; and chords equally distant from the centre are equal.

* 1 III. Take E the centre of the circle ABDC,* and from E draw EF, EG perpendiculars to AB, CD; \dagger then if $AB = CD$, EF must be = EG. For draw EA, EC. Then because EF, from the centre, cuts AB, a chord not through the * 3 III. centre, at right angles, it bisects it,* $\therefore AF = FB$, $\therefore AB$ is double of AF, \dagger Hyp. For a like reason CD is double of CG. But $AB = CD$, \dagger $\therefore AF = CG$.

And because $EA = EC$, $\therefore EA^2 = EC^2$: but $AF^2 + FE^2 = EA^2$, because AFE is a right
 * 47 I. angle; * and, for a like reason, $CG^2 + GE^2 = EC^2$,
 $\therefore AF^2 + FE^2 = CG^2 + GE^2$: but $AF^2 = CG^2$, because $AF = CG$,
 $\therefore FE^2 = GE^2$, $\therefore FE = GE$; but chords of a circle are
 said to be equally distant from the centre when the perpen-
 + Def. 8 III. diculars drawn to them from the centre are equal,†
 $\therefore AB, CD$ are equally distant from the centre.

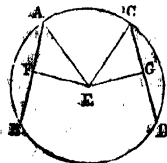

Next, let the chords AB, CD be equally distant from the
 centre: that is, let the perpendiculars EF, EG be equal: then
 shall $AB = CD$. For, the same construction being made, it
 may, as before, be demonstrated that AB is double of AF , and CD double of CG , and
 * Hyp. that $AF^2 + FE^2 = CG^2 + GE^2$: but $FE^2 = GE^2$, because $FE = GE$, *
 $\therefore AF^2 = CG^2$, $\therefore AF = CG$: but AB, CD are the doubles of AF, CG , as already
 proved, $\therefore AB = CD$; \therefore equal chords, &c. Q. E. D.

PROPOSITION XV.—THEOREM.

*The diameter is the greatest chord in a circle: and of all others, that which is nearer to the
 centre is always greater than one more remote: and the greater is nearer to the centre
 than the less.*

Let E be the centre of the circle $ABCD$, and let BC be nearer to it than FG : the
 diameter AD is the greatest chord, and BC is greater than FG .

Draw EB, EC . Then because $EA = EB$ and $ED = EC$, $\therefore AD = EB + EC$: but EB
 * 20 I. + EC are greater than BC , * $\therefore AD$ is greater than BC .

Again, draw EH, EK perpendiculars to BC, FG : then be-
 + Hyp. cause BC is nearer to the centre than FG ,†
 EH is less than EK ; and, as was demonstrated in the
 preceding proposition, $EH^2 + HB^2 = EK^2 + KF^2$: but EH^2
 is less than EK^2 , because EH is less than EK , $\therefore HB^2$ is greater
 * 8 III. than KF^2 ; but BC is the double of HB , * and
 FG the double of KF , $\therefore BC$ is greater than FG .

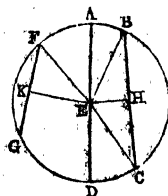

Next, let BC be greater than FG , then BC shall be nearer
 to the centre than FG ; that is, the same construction being made,
 EH shall be less than EK . Because BC is greater than FG ,
 BH is greater than FK , $\therefore BH^2$ is greater than FK^2 . And $BH^2 + HE^2 = FK^2 +$
 KE^2 , of which BH^2 is greater than FK^2 , $\therefore HE^2$ is less than EK^2 , $\therefore EH$ is less than
 EK , that is BC is nearer to the centre than FG ; \therefore the diameter, &c. Q. E. D.

PROPOSITION XVI.—THEOREM.

*The straight line drawn at right angles to the diameter (AB) of
 a circle (ABC), from the extremity of it (A) falls without
 the circle; and no straight line can be drawn from that
 extremity between the straight line and the circumference, so
 as not to cut the circle.*

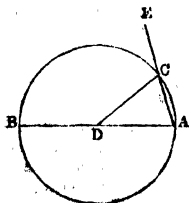

For if AE do not fall without the circle, let a part of
 it, as AC , fall within the circle; and from the centre D draw

DC, to the point C where AE meets the circumference. Then because $DA = DC$, the
 † 5 I. angle $DAC = DCA$; † but DAC is a right angle,* $\therefore DCA$ is a right
 * Hyp. angle, $\therefore DAC + DCA =$ two right angles, which is impossible, † \therefore a
 † 17 I. part of AE, at right angles to BA, does not fall within the circle. And it
 may be demonstrated, in the same manner, that AE does not fall upon the circum-
 ference; \therefore AE falls without the circle.

Moreover, between AE and the circumference no straight line can be drawn from
 A which does not cut the circle. For let AF be supposed to
 be drawn between them; from D draw DG perpendicular to

* 12 I. AF,* and let it meet the circumference in H.
 Because AGD is a right angle, and DAG less than a right
 † 17 I. angle, † DA is greater than DG;* but $DA =$
 * 19 I. DH, \therefore DH is greater than DG, a part than the
 whole, which is impossible, \therefore no straight line can be drawn
 from A between AE and the circumference; \therefore the straight line,
 &c. Q. E. D.

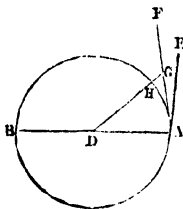

Cor. From this it is manifest that the straight line,
 at right angles to a diameter of a circle, from an extremity of that diameter, touches the
 circle; and that it touches it in one point only, because if it met the circle in two
 † 2 III. points, it would fall within it. † Also it is evident that there can be but
 one straight line which touches a circle in the same point.

PROPOSITION XVII.—PROBLEM.

To draw a straight line from a given point, either without or in the circumference of a circle
 (BCD), which shall touch the circle.

* 1 III. First let the given point be without the circle as A. Find E the centre,*
 and draw AE, cutting the circle in D; and with centre E, and radius EA, describe the
 † 11 I. circle AFG; from D draw DF at right angles to EA, † and draw EBF,
 AB. AB shall touch the circle BCD.

Because E is the centre of the circles BCD, AFG, $EA = EF$ and $ED = EB$, \therefore
 the two sides AE, EB are $=$ the two FE, ED, each to each,
 and the angle E is common to the two triangles AEB, FED,

* 4 I. \therefore the angle $EBA = EDF$;* but EDF is a
 right angle, \therefore EBA is a right angle and EB is a radius; but
 a straight line from an extremity of a diameter, at right angles
 † 16 III. Cor. to it, touches the circle, † \therefore AB touches the circle,
 and it is drawn from the given point A; which was to be done.

But if the given point be in the circumference, as at D,
 draw DE to the centre E, and DF at right angles to DE; DF touches the

* 16 III. Cor. circle.*

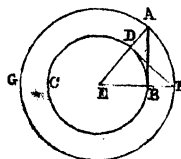

PROPOSITION XVIII.—THEOREM.

If a straight line touch a circle, the straight line drawn from the centre to the point of con-
 tact shall be perpendicular to the line touching the circle.

This proposition is really included in Prop. XVI.: It affirms that the diameter is perpendicular
 to the touching line at its extremity: and Prop. XVI. shows that the perpendicular to the
 diameter at its extremity is the touching line, and the only touching line at that extremity.
 The next proposition is equally superfluous: the only thing proved by either is this, viz.

that a line which is perpendicular to the diameter, must have the diameter perpendicular to it. The two enunciations are retained here only to avoid interruption in the numbering of the propositions.

PROPOSITION XIX.—THEOREM.

If a straight line touch a circle, and from the point of contact a straight line be drawn at right angles to the touching line, the centre of the circle shall be in that line.

PROPOSITION XX.—THEOREM.

The angle (BEC) at the centre (E) of a circle (ABC) is double of the angle (BAC) at the circumference upon the same arc (BC).

Draw AE and prolong it to F. And first let the centre E be within BAC. Because EA = EB, the angle EAB = * 5 I. EBA, * ∴ EAB + EBA is double of EAB; but † 32 I. BEF = EAB + EBA, † ∴ BEF is double of EAB. For a like reason FEC = double of EAC, ∴ BEC is double of BAC.

Next let the centre E be without BAC. It may be demonstrated, as in the first case, that FEC is double of FAC, and that FEB, a part of the first, is double of FAB, a part of the other, ∴ the remaining angle BEC is double of the remaining angle BAC; ∴ the angle at the centre, &c. Q. E. D.

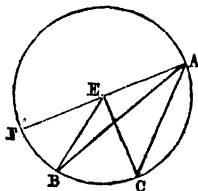
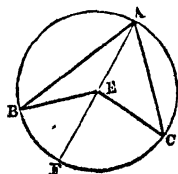

PROPOSITION XXI.—THEOREM.

The angles (BAD, BED) in the same segment (BAED) of a circle are equal.

* 1 III. Take F the centre of a circle: * draw FB, FD, as also the diameter AC; and join E, C. Because BFC, at the centre, is upon the same arc BC, as BAC at the circumference, ∴ BFC is † 20 III. double of BAC. † Again, because BFC, at the centre, is upon the same arc BC, as BEC at the circumference, ∴ BFC is double of BEC. But it was shown that BFC is also double of BAC, ∴ BAC = BEC. In like manner it may be proved that CAD = CED, ∴ the whole angle BAD = the whole angle BED; ∴ the angles, &c. Q. E. D.

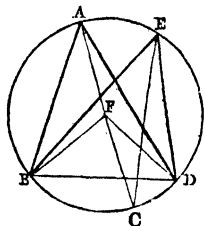

PROPOSITION XXII.—THEOREM.

The opposite angles of any quadrilateral figure (ABCD) inscribed in a circle (ABCD) are together equal to two right angles.

Draw the diagonals AC, BD. Then because the three angles * 32 I. of every triangle are together = two right angles, * ∴ CAB + ABC + BCA = two right angles; but CAB = † 21 III. CDB, † and BCA = BDA, ∴ CAB + BCA = CDA. To each of these add ABC, ∴ ABC + CAB + BCA = ABC + CDA, ∴ ABC + CDA = two right angles: and as the four angles * 32 I. of a quadrilateral = four right angles, * ∴ the other Cor. I. two opposite angles are also = two right angles; ∴ the opposite angles, &c. Q. E. D.

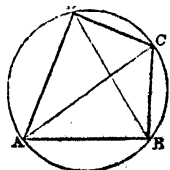

NOTE.—It appears from the foregoing property, that if one side (as AB) of a quadrilateral in a circle be prolonged, the exterior angle will be equal to the interior and opposite angle (D).

PROPOSITION XXIII.—THEOREM.

Upon the same straight line (AB), and on the same side of it, there cannot be two similar segments of circles not coinciding with one another.

For if it be supposed possible, let ACB, ADB be two similar segments, not coinciding with one another. Then, because the circles cut in the two points A, B, they cannot cut in any other point,* \therefore one
 * 10 III. segment must be within the other. Let ACB
 be within ADB: draw BCD, as also CA, DA. Then, because
 † Hyp. the segments are similar, † and that similar seg-
 * Def. 10 III. ments of circles contain equal angles,* \therefore the
 angle ACB = ADB, the exterior to the interior and opposite,
 † 16 I. which is impossible, † \therefore there cannot be two similar segments of circles upon
 the same side of the same straight line, which do not coincide. Q. E. D.

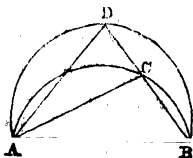

PROPOSITION XXIV.—THEOREM.

Similar segments of circles (AEB, CFD) upon equal chords (AB, CD) are equal to one another.

For if the segment AEB be applied to CFD, so that A may be on C, and AB on CD, B shall coincide with D, because AB = CD.

\therefore AB coinciding with CD, the segment AEB

* 23 III. must coincide with the segment CFD,*
 and is \therefore equal to it; \therefore similar segments, &c. Q. E. D.

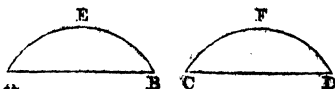

NOTE.—It obviously follows from this, that similar segments of circles upon equal chords have equal arcs.

PROPOSITION XX

An arc (ABK) of a circle being given, to describe the circle of which it is an arc.

Take any point B in the arc, from which draw any two chords BC, BD. Bisect
 * 10 I. them in E and F,* and draw EG, FH at right
 † 11 I. angles to BC, BD. These perpendiculars will
 cut each other in a point P, which will be the centre of the circle. For the centre of the circle to which the arc BC belongs, is in the line EG, bisecting the chord CB at right
 † 1 III. Cos. angles: * it is also in the line FH, bisecting
 the chord BD at right angles: the centre being thus in both
 the lines EG, FH, must be at P, where they intersect, \therefore
 with P as centre, and PM as radius, if a circle be described, it will be that of which the
 given arc is a part. Which was to be done.

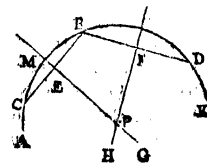

PROPOSITION XXVI.—THEOREM.

In equal circles (ABC, DEF) equal angles stand upon equal arcs, whether they be at the centres or at the circumferences.

First, let the angles BGC, EHF at the centres be equal. Take any point, A, in the arc BAC, and any point, D, in the arc EDF: draw AB, AC, DE, DF, BC, EF. Then, because the circles are equal, the radii GB, GC are equal to the radii HE, HF, each to

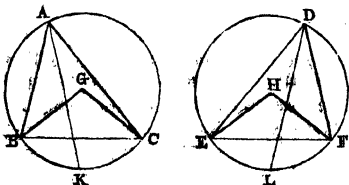

* Hyp. each; and the angle $G = H$,*
 † 4 I. $\therefore BC = EF$; † and because
 * 20 III. $BAC = EDF$,* the segment
 † Def. 10 III. BAC is similar to the segment
 EDF ; † and they have equal

* 24 III. chords, \therefore the segment $BAC =$ segment EDF :* but the whole circle $ABKC =$ the whole circle $DELF$, \therefore the remaining segment $BKC = ELF$, \therefore the arc $BKC =$ arc ELF .

Next let the angles BAC, EDF at the circumferences be equal. Find the centres G, H; † and draw GB, GC, BC; HE, HF, EF: then if BAC be less than a right angle, the angle BGC, at the centre, will stand on the same arc BKC as BAC, and * 20 III. will \therefore be double of BAC.* In like manner EHF will be double of EDF, \therefore the angles G, H at the centres are equal, and \therefore , as before proved, the arcs BKC, ELF must be equal. But if BAC be not less than a right angle, bisect

† 9 I. it, † as also the equal angle EDF, by the straight lines AK, DL, then the angles BAK, EDL being equal, and each less than a right angle, the arcs BK, EL, by the first case, = the arc EL. In like manner $KC = LF$, \therefore the arcs BKC, ELF are equal, \therefore in equal circles, &c. Q. E. D.

PROPOSITION XXVII.—THEOREM.

In equal circles (ABC, DEF) the angles (BAC, EDF), which stand upon equal arcs (BGC, EHF), are equal, whether they be at the centres or at the circumferences.

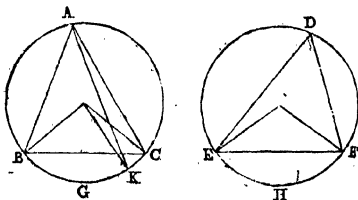

For if not, let one of them, as BAC, be the greater; and make the angle BAK =

* 23 I. EDF ,* then because in equal circles equal angles stand on equal arcs, † \therefore the arcs BGC, EHF are equal: but $BGC = EHF$,*

$\therefore BGC = BGC$, a part to the whole, which is impossible, \therefore the angles BAC, EDF cannot be the one greater than the other; that is, the angles are equal; \therefore in equal circles, &c. Q. E. D.

NOTE.—The demonstrations of the last two propositions differ considerably from those of Euclid, which, upon examination, will be found to be incomplete, since they exclude the case in which the angles BAC, EDF, at the circumferences, are each not less than a right angle.

It will be observed that the demonstration of the second of these propositions equally applies whether the angles BAC, EDF be at the circumferences, as in the diagrams, or at the centres. These points are left unmarked by letters, in order that, in going over the reasoning, the letters A, D may be mentally transferred to the centres, and thus both cases be included in the same demonstration.

PROPOSITION XXVIII.—THEOREM.

In equal circles (ABC, DEF) equal chords (BC, EF) cut off equal arcs (BAC, EDF, and BGC, EHF) the greater equal to the greater, and the less to the less.

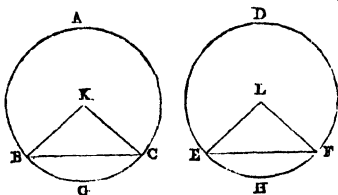

Take K, L, the centres of the circles,*
 * 1 III. and draw KB, KC, LE, LF.
 Then, because the circles are equal, KB, KC are = LE, LF, each to each, and BC
 + Hyp. = EF, † \therefore the angle BKC
 * 8 I. = ELF: * but equal angles at the centres stand on equal arcs, † \therefore the
 † 26 III. = ELF: * but equal angles at the centres stand on equal arcs, † \therefore the
 * Hyp. arc BGC = EHF: but the whole circumference ABC = the whole EDF,*
 \therefore the remaining part BAC = the remaining part EDF; \therefore in equal circles, &c.
 Q. E. D.

PROPOSITION XXIX.—THEOREM.

In equal circles (ABC, DEF) equal arcs (BGC, EHF) are subtended by equal chords (BC, EF).

[See preceding diagrams.]

If the arcs are semi-circumferences, then BC, EF are diameters; and as the circles are equal, these diameters must be equal. But if the arcs be not semi-circumferences, take
 * 1 III. K, L, the centres of the circles,* and draw KB, KC, LE, LF. Then,
 † 27 III. because the arc BGC = the arc EHF, the angle BKC = ELF; † and because the circles are equal, KB, KC are equal to LE, LF, each to each, and the
 * 4 I. angles K, L are also equal, \therefore BC = EF; * \therefore in equal circles, &c.
 Q. E. D.

NOTE.—It is plain that what is proved in the preceding propositions, as to equal circles, necessarily holds in reference to the same circle.

PROPOSITION XXX.—PROBLEM.

To bisect a given arc (ADB); that is, to divide it into two equal parts.

* 10 I. Draw AB and bisect it in C: * from C draw
 † 11 I. CD at right angles to AB: † the arc ADB shall be bisected in D. Draw AD, BD. Then, because AC = CB, and CD common to the triangles ACD, BOD, the two sides AC, CD are = the two BC, CD, each to each; and the
 * 4 I. angle ACD = BCD, each being a right angle, \therefore AD = BD.* But equal chords cut off equal arcs, the greater equal to the greater, and the less to the
 † 26 III. less, † \therefore arc AD = arc BD, each arc being less than a semicircle, because DC, or DC prolonged, passes through the centre; \therefore the given arc is bisected in D. Which was to be done.

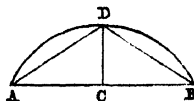

PROPOSITION XXXI.—THEOREM.

The angle (BAC) in a semicircle (BADC) is a right angle: the angle in a segment (ABGC) greater than a semicircle, is less than a right angle: and the angle (D) in a segment (ADC) less than a semicircle, is greater than a right angle.

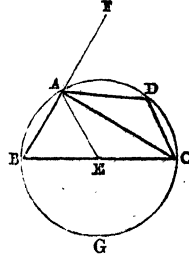

From the centre, E, draw EA, and produce BA to F.
 * 5 I. Then, because EB=EA, the angle EAB=EBA; * also because EA = EC, the angle EAC = ECA, ∴ the whole angle BAC = ABC + ACB: but FAC, the exterior angle of
 † 32 I. the triangle ABC, is = ABC + ACB, † ∴ BAC
 * Def. 3 I. = FAC, ∴ each is a right angle, * ∴ the angle BAC in a semicircle is a right angle. Again, because the two angles B, C, of the triangle ABC are together less than two
 † 17 I. right angles, † and that BAC has been proved to be a right angle, ∴ ABC must be less than a right angle, ∴ the angle B in a segment ABGC, greater than a semicircle, is less than a right angle. Lastly, because ABCD is a quadrilateral in a circle, the opposite angles B, D are together = two right
 * 22 III. angles: * but B has been proved to be less than a right angle, ∴ D, in a segment ADC less than a semicircle, is greater than a right angle; ∴ the angle, &c. Q. E. D.

PROPOSITION XXXII.—THEOREM.

If a straight line (EF) touch a circle, and from the point of contact (B) a straight line (BD) be drawn cutting the circle, the angles (DBF, DBE) which this line makes with the touching line shall be equal to the angles (A, C) in the alternate segments of the circle, each to each.

* 11 I. From B draw BA at right angles to EF: * take any point C in the arc DCB, and draw AD, DC, CB.

Then, because EF touches the circle in B, and that BA is drawn at right angles to

† 10 III. EF, the centre of the circle is in BA, † ∴ ADB, being an angle in a semicircle, is a right

* 31 III. angle, * ∴ BAD + ABD = a right angle; †
 † 32 I. but ABF likewise is a right angle, * ∴

* Const. ABF = BAD + ABD. Take away the common angle ABD, ∴ DBF = A, the angle in the alternate segment.

Again: because AC is a quadrilateral in a circle
 † 22 III. A + C = two right angles: † but DBF +

* 13 I. DBE = two right angles, * ∴ DBF + DBE = A + C; and it was been proved that DBF = A, ∴

DBE = C, the angle in the alternate segment; ∴ if a straight line, &c. Q. E. D.

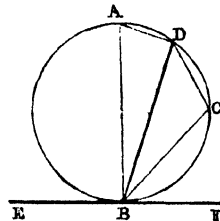

PROPOSITION XXXIII.—PROBLEM.

Upon a given straight line (AB) to describe a segment of a circle capable of containing an angle equal to a given angle (C).

* 10 I. First let C be a right angle: bisect AB in F, * and with F as centre, and radius FB, describe the semicircle AHB: then the angle H,

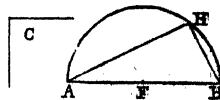

formed by HA, HB, drawn from any point H in the arc, being in a semicircle, is equal
 † 31 III. to the right angle C. †

* 23 I. But if C be not a right angle, make $\angle RAD = C$,* and draw AE at

† 11 I. right angles to AD. † Bisect AB in F,*

* 10 I. and draw FG at right angles to AB: †

† 11 I. FG will meet AE in some point G, be-

* Ax. 12. cause GAF is less than a right angle;*

and if from G as centre, with radius GA, a circle be described, it will pass through B, and the segment AHB will be that required. For draw GE: then because $AF = FB$, the two sides AF, FG are = the two BF, FG, each to each; and the angle AFG =

† Const. BFG, † $\therefore GA = GB$;* \therefore the circle,

* 4 I. with centre G, and radius GA, must pass through B. Again: because from A, an extremity of the diameter AE, AD is drawn at right angles to AE, \therefore AD touches the

† 16 III. Cor. circle: † and because AB, drawn from the point of contact, cuts the circle, the angle DAB

* 32 III. = H, in the alternate segment:*

† 32 III. = H, in the alternate segment:*

DAB = C, $\therefore H = C$; \therefore upon AB the segment AHB of a circle is described, which contains an angle H = C. Which was to be done.

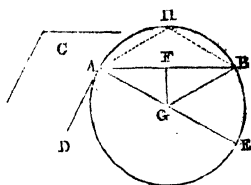
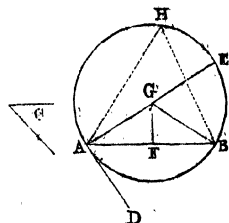

PROPOSITION XXXIV.—PROBLEM.

From a given circle (ABC) to cut off a segment, which shall contain an angle equal to a given angle (D).

Take any point B in the circumference, and draw EF touching the circle in

* 17 III. B,* and make the angle FBC = D. †

† 23 I. The segment BAC shall contain an angle A = D. Because EF touches the circle at B,

the angle FBC = BAC, in the alternate seg-

* 32 III. ment:*

† 32 III. = D, † \therefore the angle

† Const. A, in the segment BAC, is = D; \therefore

from the given circle the segment BAC is cut off containing an angle = D. Which was to be done.

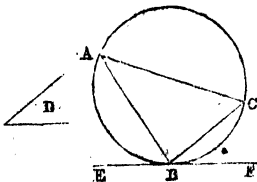

PROPOSITION XXXV.—THEOREM.

If two chords (AC, BD) in a circle, cut one another, the rectangle (AE · EC) contained by the segments of one of them, is equal to the rectangle (BE · ED) contained by the segments of the other.

If the chords intersect in the centre E, it is evident that AE, EC, BE, ED, being all equal, the rectangle AE · EC = BE · ED.

But if one of them, BD, pass through the centre, and cut

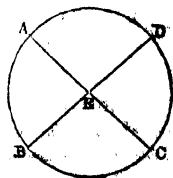

the other AC, which does not pass through the centre, at right angles, in E, then, if BD^2 be bisected in F, F is the centre of the circle; join A, F. Then because BD, through the centre cuts AC, not through the

* 8 III. centre, at right angles in E, $AE = EC$. * And because BD is cut into two equal parts in F, and into two

† 5 II. unequal parts in E, $BE \cdot ED + EF^2 = EB^2$, or

* 47 I. FA^2 ; but $AE^2 + EF^2 = FA^2$, * $\therefore BE \cdot ED + EF^2 = AE^2 + EF^2$. Take away the common square EF^2 ,

$\therefore BE \cdot ED = AE^2 = AE \cdot EC$. Again, let BD, which passes through the centre, cut AC, which does not pass through

the centre in E, but not at right angles; then, as before, if BD be bisected in F, F is the centre of the circle. Draw AF, and

* 12 I. from F draw FG perpendicular to AC, *

† 3 III. $\therefore AG = GC$, † $\therefore AE \cdot EC + EG^2 = AG^2$. To

* 5 II. each of these add GF^2 , $\therefore AE \cdot EC + EG^2 +$

† 47 I. $GF^2 = AG^2 + GF^2$; but $EG^2 + GF^2 = EF^2$, † and $AG^2 + GF^2 = AF^2$, $\therefore AE \cdot EC + EF^2 = AF^2 = FB^2$;

* 5 II. but $FB^2 = BE \cdot ED + EF^2$, * $\therefore AE \cdot EC + EF^2 = BE \cdot ED + EF^2$. Take away EF^2 , $\therefore AE \cdot EC = BE \cdot ED$.

Lastly, let neither of the chords AC, BD pass through the centre. Take the centre

† 1 III. F, † and through E, the intersection of the chords, draw the diameter GEFH. Then, because $AE \cdot EC = GE \cdot EH$, as also $BE \cdot ED = GE \cdot EH$, as already proved, $\therefore AE \cdot EC = BE \cdot ED$; \therefore if two chords, &c. Q. E. D.

PROPOSITION XXXVI.—THEOREM.

If from any point (D) without a circle (ABC) two straight lines be drawn, one of which (DA) cuts the circle, and the other (DB) touches it, the rectangle (AD · DC) contained by the whole line cutting the circle, and the part without the circle, shall be equal to (DB²) the square of the line which touches it; that is, $AD \cdot DC = DB^2$.

The line DCA either passes through the centre, or it does not; first let it pass through the centre E; and draw EB; then

† 13 III. B is a right angle; † and because AC is bisected

* 6 III. in E, and prolonged to D, $AD \cdot DC + EC^2 = ED^2$; * but $EC = EB$, $\therefore AD \cdot DC + EB^2 = ED^2$; but $ED^2 = EB^2$

† 47 I. + BD^2 , because B is a right angle, † $\therefore AD \cdot DC + EB^2 = EB^2 + BD^2$. Take away EB^2 , $\therefore AD \cdot DC = BD^2$.

But if DCA do not pass through the centre, take the centre

* 1 III. E, * and draw EF perpendicular to AC; † draw

† 12 I. also EB, EC, ED. Then because EF, passing through the centre, cuts AC, not through the centre at right

* 3 III. angles, it also bisects it, * $\therefore AE = EC$; and because AC is bisected

† 6 IX. in F, and prolonged to D, $AD \cdot DC + FC^2 = FD^2$. † To each of these add FE^2 , $\therefore AD \cdot DC + FC^2 + FE^2 = FD^2 + FE^2$; but $ED^2 = EC^2 + FE^2$, be-

* 47 I. cause EFD is a right angle; * and, for the same reason, $EC^2 = EG^2$. †

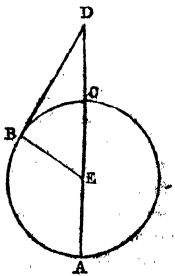
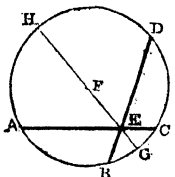
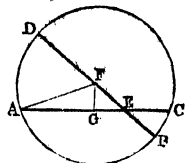
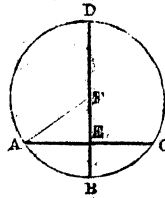

FE^2 , $\therefore AD \cdot DC + EC^2 = ED^2$; but $EC = EB$, $\therefore AD \cdot DC + EB^2 = ED^2$; but $EB^2 + BD^2 = ED^2$, because B is a right angle, $\therefore AD \cdot DC + EB^2 = EB^2 + BD^2$.
 Take away EB^2 , $\therefore AD \cdot DC = BD^2$.

COR. If from any point without a circle, two straight lines cutting it be drawn, the rectangles of the whole lines and the parts without the circle are equal; for each rectangle is equal to the square of the line drawn from the point to touch the circle.

PROPOSITION XXXVII.—THEOREM.

If from a point (D) without a circle (ABC) there be drawn two straight lines, one (DCA) to cut the circle, and the other (DB) to meet it; and if the rectangle ($AD \cdot DC$) of the whole cutting line and the part without the circle be equal to (DB^2) the square of the line which meets it, the line (DE) which meets shall touch the circle.

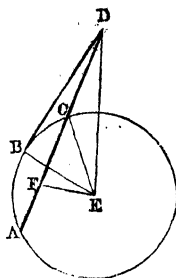

* 17 III. Draw DE touching the circle in E : * find the centre F , † and draw FE ,
 † 1 III. FB , FD : then E is a right angle.* And because
 * 18 III. DE touches, and DCA cuts the circle, $AD \cdot DC =$
 † 36 III. DE^2 : † but $AD \cdot DC = DB^2$,* $\therefore DE = DB$;
 * Hyp. also $FE = FB$, $\therefore DE$, EF are $= DB$, BF , each
 to each; and the base FD is common to the two triangles
 † 8 I. DEF , DBF , \therefore the angle $E = B$: † but E was
 shown to be a right angle, $\therefore B$ is a right angle: and BF pro-
 longed is a diameter: but the straight line which is drawn at
 right angles to a diameter, from an extremity of it, touches
 * 16 III. the circle,* $\therefore DB$ touches the circle ABC ; \therefore if from
 a point, &c. Q. E. D.

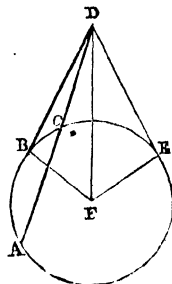

REMARKS ON BOOK III.

The third book is wholly occupied with propositions concerning the circle. In the definitions I have introduced two terms, the want of which is very much felt in the Elements—the terms *arc* and *chord*. The absence of this latter term has been the occasion of much looseness of expression in certain propositions of Euclid's Third Book: in Proposition I., for instance, as Thomas Simpson has justly noticed, we are directed to “draw within the circle any straight line AB ,” without the limiting condition that its extremities are to be in the circumference; and the same want of precision is observable in Propositions III. and IV. By “a straight line in a circle,” Euclid certainly means exclusively “a straight line in a circle, and terminated both ways by the circumference;” but this should have been expressly stated, and not left to be inferred from observation. Had Definition VII., Book IV. (Simpson's Euclid), been placed among the definitions of the third book, the objection here advanced would have been removed; since, according to that definition, “A straight line is said to be placed in a circle, when the extremities of it are in the circumference of the circle;” but it is better to call such a line a *chord*, the name given to it in all other geometrical inquiries.

The demonstration in Proposition I. of Simson's Euclid is imperfect, since all that it proves is that the centre of the circle must be in the line CE, without determining the particular *point* in that line; the omission is supplied in the present edition.

The enunciation of Proposition VI. in Simson is, "If two circles touch one another *internally*, they shall not have the same centre;" but as it is plain that each circle cannot be *within* the other, the word *internally* should be omitted. If two circles touch *externally*, then, since each must be wholly *without* the other, it is obvious that they cannot have the same centre. In Proposition VII. certain lines are introduced by Euclid—namely, the lines EC, EG—long before they are wanted; and the diagram is thus unnecessarily complicated at the outset of the demonstration. I have already told you (page 80), with a view to an orderly and systematic arrangement of the steps of your argument, that the diagram should not proceed in advance of the text: the more you depart from this plan, the more you depart from simplicity; since you thus encumber your diagram with lines that serve no purpose but to distract your attention. In demonstrating this seventh proposition without the book, you should commence by exhibiting in your diagram only the lines FB, FC, in addition to the diameter AD: you should then draw EB, for the purpose of proving that FA is greater than FB, whatever line, other than FA, FB may be: one part of the proposition is thus disposed of. The next step is to draw EC, the aid of which is now required—but not till now—to prove that FB, a line nearer to that through the centre, is greater than any other line FC more remote: another part of the theorem is thus demonstrated. You may now, if you please, introduce FG, and then draw EG, for the purpose of proving that FD is shorter than any other line drawn from F. I say you may introduce FG, *if you please*; for, in strictness, there is no absolute occasion for it; FC, or FB, already drawn, would answer the purpose equally well: of the remaining part of the construction nothing need be said here.

In Proposition VIII. I have actually omitted Euclid's superfluous line,—the line corresponding to that which, as just noticed, may be dispensed with in the preceding proposition. As the diagram here is somewhat more complicated, I thought that the suppression of an unnecessary line from D, and *consequently* of two lines in connection with it from M, would be a desirable relief to it. You will perceive it to be so if you compare the diagram here with that in other editions of Euclid.

The demonstration of Proposition IX., given in the present edition, is not that of Euclid, though substituted for it by De Chales, and some other editors. In the earlier copies of Euclid two different demonstrations of this simple theorem are given. They have both been preserved by Gregory, Stone, Williamson, and Bonnycastle. It is the second of these two only that Simson retains; but, as remarked by Williamson, there is a defect in the reasoning, which, however, it is scarcely worth while to remove. The demonstration given in the text is so easy and obvious, that, as Austin justly observes, "we cannot suppose Euclid would have overlooked it." It is probable, therefore, that the demonstrations here discarded are not Euclid's own, but the interpolations of some other writer.

Although it is proved in Proposition XX. that an angle at the centre of a circle is double that at the circumference subtended by the same arc, yet it must not be inferred that to *every* angle at the circumference there corresponds an angle at the centre, upon the same arc, which is double of the former. If the angle at the circumference stand upon a semi-circumference, there can evidently be *no* corresponding angle at the centre upon the same arc; and if the angle at the circumference stand upon an arc greater

than a semi-circumference, the angle at the centre, the sides of which terminate in the extremities of the same arc, will stand—not upon *that* arc—but upon the opposite part of the circumference.

The construction of Proposition XXV. is different in the present edition from that given in Euclid, which requires three diagrams: moreover, the “segment of a circle,” as Euclid has it, need not be given, only the *arc*. Propositions XXVI. and XXVII. differ also in matters of construction from those of Euclid; for, as they at present stand in Simson, they are insufficiently demonstrated; as noticed in the text.

Proposition XXXIII. In all the editions of Euclid that I have seen, there is a superfluous line (the line BE) introduced into the second of the three diagrams; and in some editions the line BE is also introduced into the third diagram, for what purpose I am unable to conceive; the tendency, though of course not the intention, is to mislead.

The demonstration applies equally to *both* diagrams. In the first, the line BE, which goes to form the angle E, is quite in keeping with the text, as this is really an angle in the segment spoken of. But in the second of these diagrams the line is not merely superfluous—it is *wrong*; since the angle E, of which it is a side, is an angle in a segment different from that to which the text refers. In order that the proper angle should be exhibited in both diagrams, the vertex of it should be at H, as shown by the dotted lines in this edition, but there is no absolute occasion to introduce this angle at all.

Propositions XXXV. and XXXVI. may be otherwise and more easily established, as follows:—

Proposition XXXV.—Let P be any point *within* a circle ABD. It is required to prove that whatever chord, AB, be drawn through P, the rectangle AP·PB will be always the same.

* 1 III. Find the centre C; * and draw CM at right
+ 12 I. angles to AB; † draw also CP, CB. Then,
* 3 III. because AB is divided equally in M, * and
+ 5 II. unequally in P, $AP \cdot PB + PM^2 = MB^2$. † Add
 CM^2 to each, $\therefore AP \cdot PB + PM^2 + CM^2 = MB^2 + CM^2$; that
* 47 I. is, $AP \cdot PB + PC^2 = BC^2$. * Take PC^2 from
each, $\therefore AP \cdot PB = BC^2 - PC^2$. But BC^2 is always the same

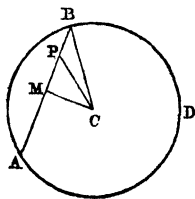

wherever in the circumference the point B may be, and PC^2 is always the same whatever chord be drawn through P, $\therefore BC^2 - PC^2$ is always the same, $\therefore AP \cdot PB$ is always the same, whatever chord (AB) be drawn through P; \therefore if two chords cut one another in any point P, the rectangle contained by the segments of one of them is equal to that contained by the segments of the other.

Proposition XXXVI.—Let B be any point *without* a circle PEF. It is required to prove that whatever line BPF be drawn, *cutting* the circle, the rectangle BF·BP shall be equal to the square of BE, a line drawn *touching* the circle.

* 1 III. Find the centre C, * and draw CB, CP, CE.
With this same centre C, and radius CB, describe a circle,
and produce BF to *meet* its circumference in A. Then
(last Proposition) $AP \cdot PB = BC^2 - PC^2 = BC^2 - EC^2$

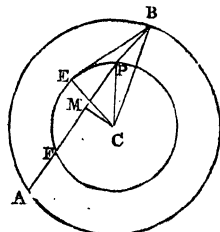

+ 47 I. $= BE^2$. † Draw the perpendicular CM to AB; then CM bisects both

* 3 III. AB and FP,* $\therefore AF = PB$, $\therefore AP = BF$. But it was proved that $AP \cdot PB = BE^2$; $\therefore BF \cdot BP = BE^2$, which was to be demonstrated.

An obvious corollary follows from this proposition, viz.—

COR. 1.—Since from any point without a circle two lines may be drawn to touch + 17 I. the circle, † these two touching lines must be equal.

I shall only further observe that, besides the particulars mentioned above, in which slight departures from the authorized text of Euclid have been made, other modifications, chiefly in the diagrams, have been introduced in certain propositions; but I believe I have nowhere ventured upon any change where the circumstances of the case did not fully justify and require it.

EXERCISES ON BOOKS I., II., III.

1. Prove the *converse* of Proposition XXII.—Book III., namely, if the opposite angles of a quadrilateral be together equal to two right angles, a circle may be described about it.

2. A trapezium may be inscribed in a circle, provided two of the opposite sides are parallel, and that the two non-parallel sides are equal.

3. If a quadrilateral be described about a circle, that is, if the four sides touch the circle, one pair of opposite sides will always be equal to the other pair.

4. If from the vertices of the three angles of a triangle perpendiculars be drawn to the opposite sides, they will intersect in the same point.

5. If two circles cut one another, the line joining the intersections of the circumferences shall be perpendicular to the line joining the centres.

6. If two circles cut one another, and from one of the points of intersection diameters be drawn, the extremities of these diameters shall be in the same straight line as the other point of intersection.

7. If any two chords of a circle intersect at right angles, the squares upon their four segments will together be equal to the square upon the diameter.

8. If two circles touch each other, any straight line through the point of contact will cut off similar segments.

9. If a quadrilateral be described about a circle, the angles subtended at the centre by one pair of opposite sides, will together be equal to those subtended by the other pair; that is, to two right angles.

10. Find a point in the prolongation of a diameter of a circle, from which, if a line be drawn to touch the circle, it shall be equal to a given straight line.

11. Two chords AD, BC, are drawn in a semicircle from the extremities of the diameter AB; the chords intersect in P. Prove that the rectangles AD·AP, BC·BP are together equal to the square of the diameter.

12. If from any point in the diameter of a semicircle two straight lines be drawn to the circumference, one to the middle of the arc, the other at right angles to the diameter, the squares upon these two lines always amount to the same sum, wherever the point be taken.

13. From a given point without a circle to draw a straight line to cut it, and to terminate in the circumference, such that the intercepted chord may have a given length, not greater than the diameter of the circle.

ELEMENTS OF EUCLID.—BOOK IV.

DEFINITIONS.

I.

A rectilinear figure is said to be *inscribed* in another rectilinear figure, when all the *vertices* of the former are upon the *sides* of the latter, each upon each.

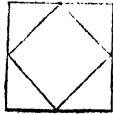

II.

A rectilinear figure is said to be *described* about another, when all the *sides* of the former pass through the *vertices* of the latter, each through each.

III.

A rectilinear figure is said to be *inscribed* in a circle, when all the *vertices* of the former are upon the *circumference* of the circle.

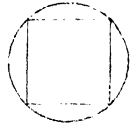

IV.

A rectilinear figure is said to be *described* about a circle when each *side* of the former *touches* the *circumference* of the circle.



V.

A circle is said to be *inscribed* in a rectilinear figure, when the *circumference* of the circle *touches* each *side* of the figure.

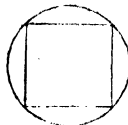

VI.

A circle is said to be *described* about a rectilinear figure, when its *circumference* passes through all the *vertices* of that figure.

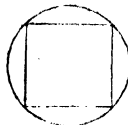

VII.

A straight line is said to be *placed* in a circle, when the *extremities* of it are in the *circumference* of that circle.

PROPOSITION I.—PROBLEM.

In a given circle (ABC), to place a straight line equal to a given straight line (D), which is not greater than the diameter of the circle.

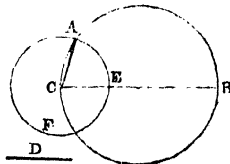

Draw BC, any diameter of the circle. Then if $CB = D$, the thing required is done; but if BC is not $= D$,

* Hyp. it is greater; * make $CE = D$; and with centre C and radius CE, describe the circle AEF; join CA; CA shall be $= D$.

* Const. Because C is the centre of the circle AEF, CA = CE; but D = CE,*
 ∴ D = CA; therefore in the circle ABC a straight line, equal to D, is placed, as
 required.

NOTE.—The enunciation of this proposition might have been as follows:—From a given
 point, in the circumference of a given circle, to draw a chord equal to a given straight
 line, which is not greater than the diameter.

PROPOSITION II.—PROBLEM.

In a given circle (ABC) to inscribe a triangle equiangular to a given triangle (DEF).

Take any point A in the circumference, and draw GAH to touch the circle in that

+ 17 III. point. † Make the angle HAC

+ 23 I. = E, and GAB = F,* and draw

BC: ABC shall be the triangle required.

Because HAG touches the circle, and AC

is drawn from the point of contact, the angle

HAC = B, in the alternate segment: † but HAC

+ 32 III. = E, ∴ B = E. For a like

reason, C = F, ∴ the remaining angle BAC

+ 32 I. = the remaining angle D; * ∴

the triangle ABC, inscribed in the circle ABC, is equiangular to DEF. Which was to
 be done.

NOTE.—If the angle HAC had been made equal to F, instead of E, the resulting triangle would
 still have been equiangular to DEF: but the construction above furnishes a triangle not
 only equiangular but similar in position to DEF. Like remarks apply to the next pro-
 position.

PROPOSITION III.—PROBLEM.

About a given circle (ABC) to describe a triangle equiangular to a given triangle (DEF).

* 1 III. Prolong EF both ways to G and H: find the centre K of the circle,*
 and draw any radius KB. Make the angle BKA = DEG, and the angle BKC =

+ 23 I. DFH: † and through A, B, C, draw

* 17 I. LM, MN, NL to touch the circle: * these
 lines will meet and form a triangle LMN equiangular
 to DEF.

Because LM, MN, NL touch the circle at A, B, C,
 the lines KA, KB, KC from the centre make the

+ 18 III. angles at A, B, C right angles, † ∴ AM,

BM would make with a line joining A, B, angles which
 are together less than two right angles, ∴ AM, BM,

* Ax. 12. must meet.* In like manner AL, CL,

meet; as also BN, CN: and because the four angles
 of the quadrilateral AMBK, are = four right

angles, for it can be divided into two triangles, and that two of the angles KAM, KBM,
 are right angles, ∴ the other two, AKB, AMB make two right angles. But DEG +

+ 13 I. DEF = two right angles, † ∴ AKB + AMB = DEG + DEF; but AKB

= DEG, ∴ AMB = DEF. In like manner it may be proved that LNM = DFE.

* 32 I. ∴ the remaining angle L = the remaining angle D; * ∴ the triangle

LMN is equiangular to the triangle DEF; and it is described about the circle. Which
 was to be done.

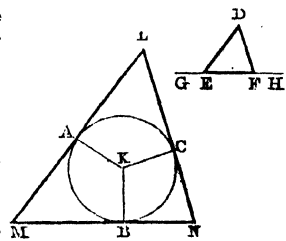
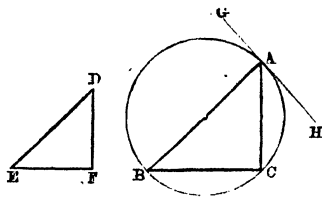

PROPOSITION IV.—PROBLEM.

To inscribe a circle in a given triangle (ABC).

* 9 I. Bisect the angles ABC, BCA * by the straight lines BD, CD, meeting one another in D, from which draw DE perpendicular to one
 † 12 I. of the sides. † The circle described with centre D, and radius DE, will be inscribed in the triangle.

For draw DF, DG, perpendiculars to the other sides:*

* 12 I. then, because the angle EBD = FBD, for

+ Const. ABC is bisected by BD, † and that BED =

* Ax. 11. BFD,* ∴ the triangles EBD, FBD have two angles of the one = two of the other, each to each; and the side BD, opposite to one of the equal angles in each, common
 † 26 I. to both, ∴ the other sides are equal; † that is,

DE = DF. For a like reason, DG = DF, ∴ DE = DG, ∴ DE, DF, DG are all equal; and the circle described with centre D, and either of these for radius, will pass through the extremities of all; and will touch AB, BC, CA, because the angles at E, F, G are right

* 16 III. angles; * ∴ the circle EFG is inscribed in the triangle ABC. Which was to be done.

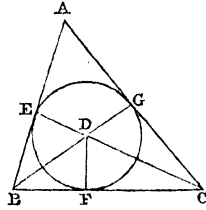

PROPOSITION V.—PROBLEM.

To describe a circle about a given triangle (ABC).

* 10 I. Bisect AB, AC in D, E; * and from these points draw DF, EF, at

† 11 I. right angles to AB, AC. † Then DF, EF must meet one another, because they make with a line joining D, E, angles on the same side, together less than two

* Ax. 12. right angles. * Let them meet in F, and draw FA, then a circle described with centre F, and radius FA, will circumscribe the triangle ABC.

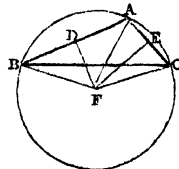
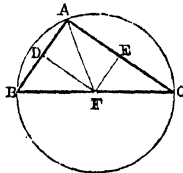
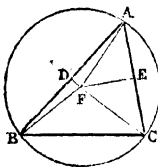

For if the point F be not in BC, draw BF, CF. Then, because AD = DB, and DF
 † 4 I. common, and at right angles to AB, AF = FB. † In like manner, it may be shown that CF = AF, ∴ FB = FC, ∴ FA, FB, FC are all equal; ∴ the circle described with centre F, and either of these lines for radius, will pass through the extremities of all, and be circumscribed about the triangle ABC. Which was to be done.

PROPOSITION VI.—PROBLEM.

To inscribe a square in a given circle (ABCD).

Draw any two diameters AC, BD at right angles to one another: draw AB, BC, CD, DA: the figure ABCD shall be the square required.

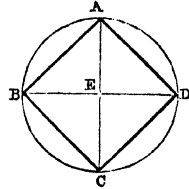

Because E is the centre, EB = ED; also EA is common,
 * 4 I. and at right angles to BD, ∴ AB = AD.* For
 a like reason CB, CD are respectively = AB, AD, ∴ the
 figure ABCD is equilateral. It is also rectangular; for BD
 being a diameter of the circle, BAD is a semicircle, ∴ BAD

+ 31 III. is a right angle.† For a like reason each of the angles ABC, BCD, CDA,
 is a right angle, ∴ the figure is rectangular, ∴ it is a square; and it is inscribed in the
 circle ABCD. Which was to be done.

PROPOSITION VII.—PROBLEM.

To describe a square about a given circle (ABCD).

Draw two diameters AC, BD, at right angles to one another, and through A, B, C, D,
 * 17 III. draw FG, GH, HK, KF, touching the circle;*

the figure GHKF shall be the square required. Because
 FG touches the circle, and EA is drawn from the centre to
 the point of contact A, the angles at A are right

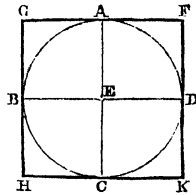

+ 18 III. angles.† For a like reason, the angles at
 B, C, D, are right angles. And because the angle AEB
 is a right angle, as likewise EBG, GH is parallel to

* 28 I. AC;* for a like reason AC is parallel to FK.
 In a similar manner may it be proved that GF, HK, are
 each parallel to BD, ∴ the figures GK, GC, AK, FB, BK,

+ 34 I. are parallelograms, ∴ GF = HK, and GH = FK;† and because
 AC = BD, and that AC = GH = FK; and BD = GF = HK, ∴ GH, FK, are each
 = GF or HK, ∴ the figure FGHK is equilateral. It is also rectangular; for GE being

* 34 I. a parallelogram, and AEB a right angle, G is a right angle;* and GK,
 † Cor. 46 I. being a parallelogram with a right angle at G, is rectangular,† ∴ it is a
 square; and it is described about the circle ABCD. Which was to be done.

PROPOSITION VIII.—PROBLEM.

To inscribe a circle in a given square (ABCD).

* 10 I. Bisect each of the sides AB, AD in F, E;* draw EH parallel to AB
 + 31 I. or DC, and FK parallel to AD or BC;† then, if with their point of
 intersection G, as centre, and GF, or GE, as radius, a circle be described, it will be
 that required.

Each of the figures AK, KB, AH, HD, AG, GC, BG, GD, being a parallelogram,

* 34 I. their opposite sides are equal: * and because $AD = AB$, and $AE = \text{half } AD$, and $AF = \text{half } AB$, $AE = AF$, \therefore the sides opposite to these are equal, viz., $FG = GE$. In like manner it may be demonstrated that $GH = GK$, and $GH = GF$, \therefore the four GE, GF, GH, GK are equal to one another; and the circle described from centre G , with any one of them for radius, will pass through the extremities of all, and will touch AB, BC, CD, DA , because
 † 16 III. Cor. the angles E, F, H, K are right angles; † the circle is \therefore inscribed in the square $ABCD$. Which was to be done.

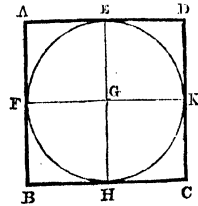

PROPOSITION IX.—PROBLEM.

To describe a circle about a given square (ABCD).

Draw AC, BD , intersecting in E : with E as centre, and EA as radius, describe a circle:—it will be that required.

Because $DA = AB$, and AC common to the triangles DAC, BAC , the two sides $DA, AC =$ the two BA, AC , each to each;

* 8 I. and $DC = BC$, \therefore the angle $DAC = BAC$; * that is, the angle DAB is bisected by AC . In like manner it may be proved that the angles ABC, BCD, CDA , are severally bisected by BD, CA . Again: the angle $DAB = ABC$, also $EAB = \text{half } DAB$, and $EBA = \text{half } ABC$, $\therefore EAB = EBA$, \therefore

† 6 I. $EA = EB$. † In like manner it may be demonstrated that $EC, ED = EB, EA$, each to each, \therefore the four EA, EB, EC, ED are equal to one another; and the circle whose centre is E , and radius EA , passes through the extremities of all, and is \therefore described about the square $ABCD$. Which was to be done.

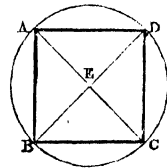

PROPOSITION X.—PROBLEM.

To describe an isosceles triangle having each of the angles at the base double of the third angle.

* 11 II. Take any straight line AB , and divide it in B , so that $AB \cdot BC = AC^2$, * and with centre A and radius AB , describe the circle BDE , in which place $BD =$
 † 1 IV. AC ; † and draw AD ; the triangle ABD shall be such that each of the angles ABD, ADB shall be double of BAD .

Draw DC ; and about the triangle ACD describe the
 * Const. circle ACD ; then because $AB \cdot BC = AC^2$, * and $AC = BD$, $\therefore AB \cdot BC = BD^2$, $\therefore BD$ touches the
 † 37 III. circle ACD in D , \therefore the angle $BDC =$
 * 32 III. DAC ; * to each of these add CDA , \therefore
 $BDA = DAC + CDA$; but the exterior angle $BCD =$
 † 32 I. $DAC + CDA$, † $\therefore BDA = BCD$; but $BDA = B$, because $AB = AD$, * $\therefore B = BCD$,

\therefore the three angles DBA, BDA, BCD , are equal to one another. Again, because the

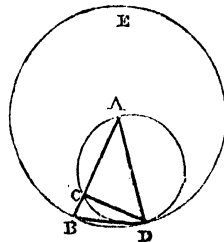

* 6 I. angle $DBC = DCB$, $DC = DB$; * but DB was made $= CA$, $\therefore CA =$
 + 5 I. CD , \therefore the angle $CDA = CAD$, † $\therefore CDA + CAD =$ twice CAD ; but
 * 32 I. $BCD = CDA + CAD$, * $\therefore BCD =$ twice CAD ; but $BCD = BDA$
 $= B$, as before proved, \therefore each of the angles BDA , DBA is double of BAD , \therefore an
isosceles triangle ABD has been described, having each of the angles at the base double of the
third angle. Which was to be done.

PROPOSITION XI.—PROBLEM.

To inscribe an equilateral and equiangular pentagon in a given circle (ABCD).

Describe an isosceles triangle FGH , having each of the angles G , H , double of
 * 10 IV. F ; * and in the circle inscribe a triangle ACD , equiangular to the
 + 2 IV. triangle FGH , so that the angle CAD may be $= F$; † then each of the
 angles ACD , ADC is double of CAD . Bisect ACD , ADC , by the straight lines CE ,

* 9 I. DB ; * and draw AB , BC , DE , EA .
 $ABCDE$ shall be the pentagon required. Because

each of the angles ACD , ADC is double of CAD ,
 and that they are bisected by CE , DB , \therefore the five
 angles DAC , ACE , ECD , CDB , BDA are equal to
 one another; \therefore the five arcs AB , BC , CD , DE , EA

+ 26 III. are equal to one another, † \therefore the
 the lines AB , BC , CD , DE , EA are equal to one
 * 29 III. another, * \therefore the pentagon $ABCDE$

is equilateral. It is also equiangular, for since the arc $AB =$ the arc DE , if to each
 BCD be added, the whole $ABCD = EDCB$; but these arcs subtend the angles AED ,

+ 27 III. BAE , $\therefore AED = BAE$. † For a like reason each of the angles ABC ,
 BCD , $CDE = BAE$ or AED ; \therefore the pentagon is equiangular, \therefore in the given circle an
 equilateral and equiangular pentagon has been described. Which was to be done.

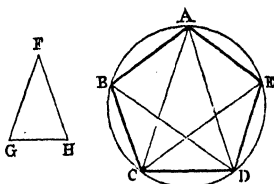

PROPOSITION XII.—PROBLEM.

To describe an equilateral and equiangular pentagon about a given circle (ABCD.)

Let the vertices of a pentagon, inscribed in the circle, by last proposition, be at
 A , B , C , D , E ; so that the arcs AB , BC , CD , DE , EA are equal; and through these
 * 17 III. points draw GH , HK , KL , LM , MG , touching the circle: * the figure
 $GHKLM$ shall be the pentagon required.

From the centre F draw FB , FK , FC , FL , FD . Then because KL touches the
 + 18 III. circle in C , FC is perpendicular to KL , † \therefore the angles at C are right
 angles: for a like reason the angles B , D are right angles. And because FCK is a right

* 47 I. angle, $FK^2 = FC^2 + CK^2$: * for a like reason $FK^2 = FB^2 + BK^2$, \therefore
 $FC^2 + CK^2 = FB^2 + BK^2$; but $FB^2 = FC^2$, $\therefore BK^2 = CK^2$, $\therefore BK = CK$. Again:
 because $FB = FC$, the two sides FB , $FK =$ the two FC , FK ; and $BK = CK$, as just
 + 8 I. proved, \therefore the angle $BFK = CFK$, † and $BKF = CKF$, $\therefore BFC =$ twice
 CFK , and $BKC =$ twice CKF . For a similar reason $CFD =$ twice CFL , and $CLD =$

* 27 III. twice CLF : and because the arc $BC =$ arc CD , the angle $BFC = CFD$: *
 and $BFC =$ twice CFK , and $CFD =$ twice CFL , $\therefore CFK = CFL$; \therefore in the two triangles
 FKC , FLC , there are two angles of the one equal to two of the other, each to each,

and the side FC, adjacent to equal angles in each, is common to both, $\therefore KC =$
 * 26 I. $= LC$,* and the angle $FKC = FLC$, and KL
 is twice KC. In a similar manner it may be shown that
 HK is twice BK, and consequently, since it was proved
 that $BK = KC$, and that $KL =$ twice KC, and $HK =$
 twice BK, $HK = KL$. In like manner it may be shown
 that GH, GM, ML are each $= HK$ or KL : \therefore the pen-
 tagon $GHKLM$ is *equilateral*. It is also *equiangular*; for,
 since the angle $FKC = FLC$, and $HKL =$ twice FKC ,
 and $KLM =$ twice FLC , as already proved, $\therefore HKL =$
 KLM . And in like manner it may be shown that each of
 the angles KHG, HGM, GML is $= HKL$ or KLM : \therefore
 the five angles GHK, HKL, KLM, IMG, MGH , being equal to one another, the pen-
 tagon is *equiangular*, and it is *described about the circle ABCD*. Which was to be done.

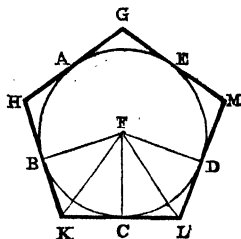

PROPOSITION XIII.—PROBLEM.

To inscribe a circle in a given equilateral and equiangular pentagon (ABCDE).

* 9 I. Bisect the angles BCD, CDE by the straight lines CF, DF;* and from
 the point F, in which they meet, draw FK perpendicular to one of the sides; then if
 with F as centre and FK as radius, a circle be described, it will touch every side of the
 pentagon.

+ Hyp. Draw FB, FA, FE; then since $BC = CD$,† and CF common to the
 triangles BCF, DCF, the two sides BC, CF $=$ DC, CF each to each; and the angle

* 4 I. $BCF = DCF$, $\therefore BF = FD$,* and the angle $CBF = CDF$. And because

+ Const. $CDE =$ twice CDF ,† and that $CDE = CBA$, and $CDF = CBF$, as just
 proved, $\therefore CBA =$ twice CBF , $\therefore ABF = CBF$, $\therefore ABC$ is bisected by BF. In a simi-
 lar manner it may be demonstrated that the angles BAE,
 AED are bisected by FA, FE. From F draw FG, FH,
 FL, FM perpendicular to AB, BC, DE, EA; then be-
 cause the angle $HCF = KCF$ and $FHC = FKC$, being
 right angles, \therefore in the triangles FHC, FKC, two angles
 of the one are equal to two of the other, each to each;
 and the side FC opposite to one of the equal angles in

* 26 I. each is common to both, $\therefore FH = FK$.*
 In like manner it may be proved that FL, FM, FG are
 each $= FK$, or FH, \therefore the five FG, FH, FK, FL, FM,
 are equal to one another, \therefore the circle described from centre F with either of them for
 radius, will pass through the extremities of all; it will moreover touch AB, BC, CD, DE,

+ 16 III. EA; since the angles at G, H, K, L, M, are right angles; \therefore the circle is
inscribed in the pentagon ABCDE. Which was to be done.

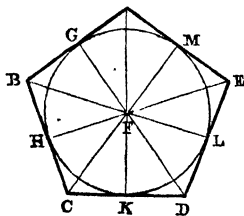

PROPOSITION XIV.—PROBLEM.

To describe a circle about a given equilateral and equiangular pentagon (ABCDE).

* 9 I. Bisect the angles BCD, CDE by the straight lines CF, DF;* and

with the point F, in which they meet, as centre, and either of them as radius, if a circle be described, it will be that required.

Draw FB, FA, FE. It may be demonstrated, as in the preceding proposition, that the angles CBA, BAE, AED are bisected by FB, FA, FE; and because the angle BCD = CDE, and that FCD is half BCD, and CDF half CDE, \therefore FCD = FDC, \therefore CF =

+ 6 I. FD.† In like manner it may be demonstrated that FB, FA, FE are each = FC or FD, \therefore the five FA, FB, FC, FD, FE are equal to one another; and \therefore the circle described from centre F, with either of them for radius, will pass through the extremities of all, and will \therefore be described about the pentagon ABCDE. Which was to be done.

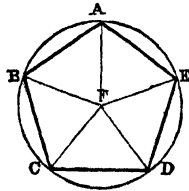

PROPOSITION XV.—PROBLEM.

To inscribe an equilateral and equiangular hexagon in a given circle (ACDF).

* 1 III. Find the centre G of the circle,* and draw the diameter AGD; from D as centre with radius DG, describe the circle EGCH; draw EG, CG, and prolong them to B, F; and draw AB, BC, CD, DE, EF, FA; ABCDEF shall be the equilateral and equiangular hexagon required. Because G is the centre of the circle ACDF, GE = GD; and because D is the centre of the circle EGCH, DE = DG, \therefore GE = ED, and the triangle EGD is equilateral, \therefore the angles EGD, GDE, DEG, are equal to one

+ 5 I. Cor. another;† and as they are together equal to two right angles,* \therefore EGD * 32 I. is the third part of two right angles. In a similar manner it may be demonstrated that DGC is the third part of two right angles; and because GC makes + 13 I. with EB the adjacent angles EGC, CGB, equal to two right angles,† the remaining angle CGB is also the third part of two right angles, \therefore EGD, DGC, CGB, are equal to one another; and to these are equal the vertical or opposite angles BGA,

* 15 I. AGF, FGE;* \therefore the six angles at G are equal to one another; consequently the six arcs which subtend + 26 III. them are equal,† and \therefore the six chords of these * 29 III. arcs,* \therefore the hexagon ABCDEF is equilateral. It is also equiangular; for since the arc AF = ED, add ABCD to each; \therefore the whole arc FABCD = EDCBA; and the angle FED stands upon FABCD, and AFE upon + 27 III. EDCBA, \therefore AFE = FED.† In a similar manner it may be demonstrated that the other angles of the hexagon are each of them = AFE, or FED; \therefore the hexagon is equiangular; and it is inscribed in the given circle ACDF. Which was to be done.

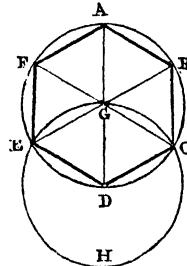

COR.—From this it is manifest that a side of the hexagon is equal to the radius of the circle. And if through A, B, C, D, E, F lines be drawn touching the circle, an equilateral and equiangular hexagon will be described about it, as may be demonstrated from what has been said of the pentagon: and likewise a circle may be inscribed in a given equilateral and equiangular hexagon, and circumscribed about it, by a method like to that used for the pentagon.

PROPOSITION XVI.—PROBLEM.

To inscribe an equilateral and equiangular quindecagon, or fifteen-sided figure, in a given circle (ABCD).

* 2 IV. Let AC be a side of an equilateral triangle inscribed in the circle,* and AB a side of an equilateral and equiangular pen-

+ 11 IV. tagon inscribed in the same: † then of such parts as the whole circumference contains *fifteen*, the arc ABC, being the third part of the circumference, contains *five*; and the arc AB, which is the fifth part of the circumference, contains *three*; ∴ BC, their difference, contains *two* of the same parts. Bi-

* 30 III. sect BC in E,* ∴ BE, EC are each the fifteenth part of the whole circumference; ∴ if the straight lines BE, EC, be drawn, and straight lines equal to them be placed round, in the whole circle, an *equilateral quindecagon* will be inscribed in it; and that it is *equiangular* is plain, because each angle stands upon an arc, equal to the whole circumference diminished by the two arcs which its sides subtend, and which arcs are by construction equal, ∴ *an equilateral and equiangular quindecagon is inscribed in the circle.* Which was to be done.

And in the same manner as was done in the pentagon, if through the points of division made by inscribing the quindecagon, straight lines be drawn touching the circle, an equilateral and equiangular quindecagon will be described about it. And likewise, as in the pentagon, a circle may be inscribed in a given equilateral and equiangular quindecagon, and circumscribed about it.

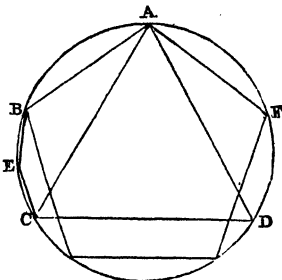

REMARKS ON BOOK IV.

The propositions in this fourth book are all *problems*, relating chiefly to the construction of regular polygons in and about a circle. From the fourth we learn this theoretical truth, namely, that the straight lines bisecting the three *angles* of a triangle all meet in a point—the centre of the inscribed circle; and from the fifth, that the straight lines bisecting the three *sides* of a triangle also meet in a point—the centre of the circumscribing circle.

As the second proposition shows that a triangle equiangular to any proposed triangle may be inscribed in a circle, we know that an equilateral triangle may be inscribed; and we thus infer that the circumference of a circle may be geometrically divided into *three* equal parts. By bisecting each of these three equal arcs (Proposition XXX., Book III.), we may divide the circumference into *six* equal parts, as otherwise shown in Proposition XV.; and by another series of bisections into *twelve* equal parts, and so on. The division of the *whole* circumference into *six* equal parts is obviously the division of the semi-circumference into *three*; the division of the whole into *twelve* equal parts is the division of the fourth of it—that is, of a *quadrant*, into *three* equal parts, and so on.

We thus see that an arc equal to fourth part, or to an eighth part, a sixteenth part, &c. of the entire circumference may be divided geometrically into *three* equal parts. But the general problem to divide *any* arc of a circle into three equal parts, or, which amounts to the same thing, to *trisect an angle*, is a problem that all the geometry in Euclid has been found hitherto inadequate to accomplish. It is one of the great outstanding problems of antiquity; and more thought and labour have been expended upon it, during the last two thousand years, than perhaps any other problem has ever called into exercise. If you now learn this fact for the first time, you will be surprised that a thing apparently so simple as to divide an angle or an arc of a circle into *three* equal parts, should have been found to be a matter of such surpassing difficulty as to have baffled the efforts of the greatest geometers from the time of Euclid to the present day. I draw attention to it here mainly for the purpose of discouraging any fresh attempts by students in geometry to trisect an angle. Novices are very apt to enter upon such attempts from a vague notion that a successful solution of the problem would, in some way or other, advance science. But geometricians know better, and by *them* the inquiry has long been abandoned, not only as a hopeless one, but also as a comparatively useless one. The theorist has no need of this solution, because he is never stopped in any mathematical investigation from the want of it; the practical man has no need of it, for he can avail himself of mechanical methods which effect the trisection of an angle that departs from strict geometrical accuracy, by an amount of error too minute to be detected by his senses, though aided by the most finished instruments of measurement; and these methods he would continue to employ even were the problem ever to be brought within the scope of elementary geometry. You see, therefore, that the inquiry is one of pure curiosity, and nothing more; since the successful issue of it could supply no want either in theory or in practice.

By aid of certain curves beyond the limits of Euclidean geometry, the trisection of an angle may be readily effected, as will be hereafter shown; but what geometricians have been in quest of is the accomplishment of this trisection by aid merely of the straight line and the circle—the only lines recognised by Euclid. Some have ventured to *say* that, with this limitation as to materials, the problem is impossible; but who can *prove* this? The third part of an angle of course *exists*; and there is therefore no just grounds for affirming that it cannot be found, except by the aid of machinery external to geometry. Till the beginning of the present century, there were the very same grounds for affirming that the circumference of a circle could not be divided into *seventeen* equal parts by common geometry; but in 1801, Gauss, a distinguished German mathematician, showed how this could be effected without going beyond the limits of elementary geometry. The discovery, though of no theoretical or practical value, made a good deal of noise at the time; the work containing this, and several analogous problems, was translated into French by Delisle, under the title of *Recherches Arithmétique*; but the division of the circumference into *seven* equal parts; or, which is the same thing, the problem to inscribe a regular *heptagon*, or seven-sided figure, in a circle, like the trisection of an arc, is not yet accomplished.

From what has now been said, you perceive that Euclid enables us (Proposition II.) to divide the circumference of a circle into 3, 6, 12, &c., equal parts; as also (Proposition VI.) into 4, 8, 16, &c., equal parts; and again (Proposition XI.) into 5, 10, 20, &c., equal parts; and finally (Proposition XVI.) into 15, 30, 60, &c., equal parts;—all these subdivisions of the circumference being obtained by the propositions here referred to, and the repeated application of Proposition XXX., Book III. As just observed, Gauss

has extended Euclid's instructions, and taught us how to divide the circumference into 17, 34, 68, &c., equal parts; as also into other parts, in like manner excluded from Euclid's divisions—namely, into 257, 65537, &c.; each part, by repeated bisections, giving rise to a new series of subdivisions as above. And by combining some of these with the subdivisions of Euclid—as Euclid himself has combined the divisions into three parts and into five parts, in Proposition XVI., to get the division into fifteen parts—other sections of the circumference may be obtained. But the actual constructions, even in the simplest of these additional cases—the division, namely, into 17 equal parts, are so very complicated as to be of no avail in actual practice; they are interesting merely as showing that this part of the Euclidean geometry is really susceptible of extension; and I have occupied your attention in this brief account of the speculations of geometers in reference to the division of the circumference, chiefly that you might see sufficient reason why so few of these divisions are accomplished by Euclid, and why he should pass at once from the six-sided polygon (Proposition XV.) to that of fifteen sides (Proposition XVI.), without anything being said as to the intermediate polygons of 7, 9, 11, 13, and 14 sides respectively. You now know that the omission arose from his inability to inscribe any of these polygons in a circle.

ON THE QUADRATURE OF THE CIRCLE.

Intimately connected with the researches just adverted to, is the problem of the quadrature of the circle, which, like that of the trisection of an angle, has for ages occasioned the fruitless expenditure of much valuable time and thought. I shall endeavour to give you here some notion of the meaning and object of this celebrated problem, not only because it is a matter of such historical interest, that you ought to know something about it; but because, moreover, in certain elementary writings on the subject, the thing is put before the student in an erroneous form; and, consequently, a wrong impression as to the real character of the problem is conveyed.

The problem of *squaring the circle*, as it is popularly called, has a twofold meaning—namely, the *geometrical* quadrature, and the *numerical* quadrature. In the first of these senses the problem is to construct a square that shall be equal in surface to a given circle; in the second, the problem is to express the numerical measure of the surface of a circle when the measure or length of its diameter is given in numbers. The former of these is the more ancient form of the problem; and all that can be fairly said of it is—as was said of the trisection of an angle—that the solution has never been effected; a square equal to a circle has never yet been constructed. We have no grounds for affirming that this construction is *impossible*, for the equivalent square *exists*. You may readily satisfy yourself of this by the following reflections:—The square on the *diameter* of the circle would be too great, and the square on the chord from an extremity of the diameter, to cut off a fourth part of the circumference, would be too small, since the former square would be circumscribed about the circle, and the latter inscribed in it; the circle therefore is in magnitude somewhere *between* the two. Conceive, now, the smaller of these two squares to expand continuously, still retaining its character as a square, till it arrives at the larger square in magnitude: then, as all intermediate magnitudes are thus reached and passed through, and as the circle is *one* of these intermediate magnitudes, it necessarily follows that our expanding square must, at a particular stage of its progress, have exactly attained the magnitude of the circle; so

that if its progress could be arrested at that stage, or—to drop this idea of progression— if the individual square could be isolated and exhibited, the problem of the geometrical quadrature of the circle would be solved. It is plain, therefore, that there is nothing visionary or absurd in the search after this square, as if it were a thing that had no existence; although some very able geometers have, strangely enough, condemned the inquiry on these grounds. The only sound reasons for abandoning the investigation are these two, namely—first, that the problem has been earnestly and laboriously attempted, by the profoundest geometers, for thousands of years, and *they* have been obliged to abandon it in despair; and secondly, that the successful solution of it would be of no theoretical or practical value if furnished. As far as *utility* is concerned, the other form of the problem of the quadrature of the circle is by far the more important; that is, to discover the numerical measure of the surface of a circle from the measured length of its diameter being given. But, under this aspect of it, the accurate solution of the problem is really impracticable; it can be *proved* to be so; and the proof will be given in a subsequent part of the present mathematical course. It is just as impracticable as it is to assign accurately the square root of 2; and, in fact, this square root does repeatedly enter into the approximative numerical process. You will require to know something of *Proportion*, in the sense in which the term is employed by Euclid, before that process can be fully explained to you. This subject, together with the sixth book of Euclid, forms the object of the treatise next following; and at the end of it you will find the principles upon which the approximative

	No. of sides.	Surface of pol.
mode of computation pointed out.	4	2
first the surface of the inscribed four-sided equilateral figure	8	2·8284271
or square; then the inscribed eight-sided figure	16	3·0614674
or square; then the inscribed sixteen-sided figure	32	3·1214461
and so on, till the inscribed polygon differs insensibly from the circle.	64	3·1365485
<i>How</i> the surfaces of these successive polygons are computed one after another, must be deferred till the end of the next treatise; but some of the results are exhibited in the margin, where the radius of the circle, whose surface is approximated to, is regarded as 1; that is, 1 inch, 1 foot, 1 yard, or <i>one</i> anything.	128	3·1403311
	256	3·1412772
	512	3·1415138
	1024	3·1415729
	2048	3·1415877
	4096	3·1415914
	8192	3·1415923
	16384	3·1415925
	32768	3·1415926

It appears from this table that the surface of an inscribed regular polygon of 32768 sides is 3 1415926, which is correct as far as the decimals extend; this number, therefore, may be taken for the numerical measure of the circle itself; for it is plain that a regular polygon of so many thousand sides would be undistinguishable from, and therefore *practically* identical with, the circle in which it is inscribed. But, by continuing to double the number of sides of the polygon, the approximation to the circle may be pushed to any extent. De Lagny computed the decimals true to 128 places; and eighty more have been recently added on by Dr. Rutherford. It is observed by Montucla that if we suppose a circle whose diameter is a thousand million times the distance of the sun from the earth, the *approximative* measure of the circumference, as computed by De Lagny, would differ from the *true* measure by a length less than the thousand millionth part of the thickness of a hair.

There is obviously no use, as far as practical purposes are concerned, in extending the approximation to anything like this extreme degree of nearness. The earlier computers were no doubt induced to carry on the decimals in the expectation that they

would at length terminate; but, as already observed, and as will be hereafter proved, the decimals would go on for ever. It is right to infer, therefore, that the *exact* numerical measure of the surface of a circle does not exist, though a geometrical square equal to it does exist. The exact numerical value of $\sqrt{2}$ does not exist; yet $\sqrt{2}$ represents the diagonal of a square whose side is 1, which diagonal is of course an existent geometrical line.

EXERCISES ON BOOKS I.—IV

1. Prove that if a pair of opposite angles of a quadrilateral be equal to two right angles, a circle may be described about it.—(Converse of Proposition XXII., Book III.)

2. If the diagonals of a quadrilateral divide one another, so that the rectangle contained by the parts of the one is equal to the rectangle contained by the parts of the other, then a circle may be described about the quadrilateral: required the proof.

3. If two opposite sides of a quadrilateral be prolonged to meet, and if it be found that the rectangle contained by one of the lines thus produced, and the part produced, are equal to the rectangle contained by the other line and the part produced, then a circle may be described about the quadrilateral. required the demonstration.

These two theorems are virtually the converses of Propositions XXXV. and XXXVI. of Book III.

4. If a circle be described about the square BE (see the Diagram to Proposition XLVII., Book I.), its circumference shall pass through the point where AD, FC intersect, and also through the point where AE, KB intersect: required the proof.

5. If an equilateral triangle be constructed on one side of a given line, and on the other side two equilateral triangles, one on each half of the line, then the two lines drawn from the vertex of the larger triangle to the vertices of the smaller triangles will trisect the given line: required the proof.

6. Divide a given triangle into three equal parts by lines drawn from the vertices of the triangle to a point within it.

7. Inscribe a circle in a rhombus.

8. Prove that the square circumscribing a circle is double of the square inscribed in the same.

9. If a circle be inscribed in a right-angled triangle, and another be circumscribed about it, prove that the sum of the sides containing the right angle will be equal to the sum of the diameters.

10. From a given point in the arc of a circle, to draw a tangent thereto without first finding the centre of the circle.

11. The straight line bisecting any angle of a triangle cuts the circumference of the circumscribing circle in a point which is equidistant from the extremities of the opposite side, and from the centre of the inscribed circle: required the proof.

12. If from any point within an equilateral and equiangular polygon perpendiculars be drawn to the several sides, the sum of these perpendiculars will always be the same, wherever the point from which they are drawn be taken.

13. Through a given point within a circle it is required to draw the shortest chord possible.

PROPORTION.

A TREATISE INTENDED AS A SUBSTITUTE FOR EUCLID'S BOOK V.

INTRODUCTORY.—In the foregoing portion of elementary geometry I have given you the “Elements of Euclid,” substantially, in all their integrity : the modifications I have introduced are for the most part merely of a verbal character ; but while condensing the language I have been careful to preserve the spirit and rigour of the original. In the few instances in which I have thought an improvement might be introduced, or a defect supplied, I have not hesitated to offer the suggestion, and to propose the emendation : what little is done in this way is sufficiently detailed in the Remarks appended to the several books. You will, of course, submit these to your own judgment,—always remembering that in matters connected with geometry, nothing is to be taken upon trust : mere opinion, unsupported by reasonings which elevate it into proof, must be regarded, *in this subject*, as of but little worth.

I am now going to depart altogether from Euclid's method of exposition, and to place before you a treatise on Proportion constructed on a different plan. I have come to this determination only after mature deliberation. It would, of course, be a much easier task for me to transfer Euclid's fifth book into these pages. I could find very little to remark upon in it, as the ancient Geometer has displayed so much sagacity and penetration in this, the most elaborate of all his writings, that he has left to the moderns little or no room for improvement : it must be studied just as it is (in Simson's restoration), or else be superseded in instruction by a treatise of equal generality, but of greater simplicity. You will understand, therefore, that I do not displace Euclid's fifth book because of its imperfections, or because of its inadequacy to completely accomplish its objects ; but solely because of its great *difficulty* to a beginner. I will endeavour to give you here some notion of the cause of this difficulty.

The subject of Euclid's fifth book is PROPORTION—*universal* proportion ; that is, not *numerical* proportion merely, but proportion in reference to all magnitudes and quantities whatever, whether numbers, lines, surfaces, solids, or concrete quantities of any kind. With proportion *in numbers* you are already familiar :—this will be a help. I hope, too, by this time you are also somewhat acquainted with proportion in *Algebra* : this will be a greater help ; for proportion in Geometry really accomplishes no more for things in general than the same doctrine in arithmetic and algebra accomplishes for what the notation of those sciences specially represents ; and if this kind of proportion would do for geometry, the fifth book of Euclid would become a very easy matter indeed. But the obstacle to this is, that geometrical magnitudes, when compared together, are in many cases found to be *incommensurable* ;—that is to say, two such magnitudes may be quite incapable of a common measurement—they may be of a nature not to admit of being *both* measured by one and the same unit of measurement, however minute the measuring unit be taken, and, consequently, *both* cannot be represented by *numbers*. I have already adverted to an instance of this kind (page 127) in the side and diagonal of a square, and to another in the diameter and circumference of a circle. You may divide the side of a square into as many equal parts as you please—from two parts to as many millions. In every case each part is, of course, a *measure* of the side, so that by applying such part, progressively, from one extremity of the side onwards towards the other extremity, that other extremity would at last be accurately reached.

But if the same measure, however small it be taken, be applied in like manner to the diagonal, the remote extremity of it ~~can never~~ be accurately reached: either an unmeasured *smaller* portion will still be left, or else the applied measure will overlap and project *beyond* that extremity. It is thus that these two lines are *incommensurable*. That they are so, could not have been found out by such practical or experimental tests as those here adverted to for illustration: they are proved to be so by geometrical reasoning (see page 143).

It may be as well to caution you here that you must not speak of a line or quantity, *by itself*, as being incommensurable; this would be absurd. The diagonal of a square is not itself incommensurable, since it has, of course, its third part, fourth part, hundredth part, &c., and is therefore *measurable* by each of those parts; but as none of them will *also* measure the *side*, the two, considered together, are incommensurable: there exists no measure common to *both*. In the same way in reference to the circle—the circumference itself is not incommensurable any more than the diameter; for each has its fourth part, sixth part, &c.; but it is incommensurable with its diameter: no length whatever can measure *both*. The circumference of a circle may be ten feet and some fraction of a foot; the diameter will necessarily be more than three feet; but the exact fraction of a foot, besides, it is not in the power of numbers to express.

Now although Euclid makes no mention of incommensurable quantities in his fifth book, he was well aware of their existence; and therefore, to render his theorems on proportion general, he had to take care that this class of quantities should be comprehended in his reasonings. But proportion limited to numbers, or to the symbols for numbers, would necessarily exclude incommensurables; he therefore had to proceed quite independently of arithmetic, and to secure to his propositions such a universality that each theorem should rigorously apply, whether the quantities or magnitudes spoken of be measurable, or beyond the powers of numerical representation. He has executed his difficult task with consummate ability; for, as Dr Barrow remarks, “there is nothing, in the whole body of the Elements, of a more subtle invention,—nothing more solidly established, and more accurately handled, than the doctrine of proportionals.”

It is on account of the subtilities here adverted to, and which are of too refined a character for the generality of young students to comprehend, that I have resolved to replace the fifth book by the following treatise. I cannot promise that you will find the study of it *easy*; but it will certainly be much *less difficult* than the corresponding portion of Euclid's work; and you will enter upon it with considerable advantage, if you postpone the attempt—as I here recommend—till you have read as far, at least, as page 220 of the Algebra. It will, indeed, facilitate your progress, and agreeably diversify your mathematical labours, if you commence the elementary algebra upon closing the fourth book of Euclid, and read the PRINCIPLES through, before you begin the following treatise.

DEFINITIONS.

I. Of two unequal magnitudes, of the same kind, the greater is said to contain the less as many times as there are parts in the greater equal to the less.

This definition is intended to convey the sense in which the word contains is to be understood in what follows. You will carefully observe that the term is not restricted by any condition as to whether or not the greater quantity leaves any remainder after taking the less from it as often as possible. Thus 8 is said to contain 2 as often as 9 contains it, though there is a remainder in the latter case and no remainder in the former.

II. One magnitude is said to be a *multiple* of another when it is equal to a certain number of times that other *exactly*. And the less of the two is in this case said to be a *sub-multiple* of the greater, or a *measure* of the greater.

Thus 8 is a multiple of 2, because 8 is equal to a certain number of times 2 *exactly*, namely, *four times* 2. And 2 is a submultiple of 8, or, as we should say in arithmetic, a *factor* of 8. Remember that a sub-multiple, or *measure* of any magnitude, is a smaller magnitude of the same kind which measures the former (the *multiple*) *exactly*, without leaving any remainder. 2 is not a submultiple or measure of 9, which is the same as saying that 9 is not a multiple of 2.

III. Magnitudes—two or more—which have a *common measure*, that is, which are multiples of some other magnitude, are said to be *commensurable*. But if it be *impossible* that any such common measure can exist, then the magnitudes are said to be *incommensurable*.

All sets of abstract numbers, and of concrete quantities, like in kind, that can be accurately denoted by numbers, are commensurable; that is, they have a common measure. The expression, common measure, as employed in arithmetic and algebra, is not synonymous with the geometrical meaning. In arithmetic we should say that the pairs of numbers 3, 7, 4, 11, 5, 12, &c., have no common measure, but even here a qualifying exception is always tacitly made: it is this, namely, *except unity*. All whole numbers contain $\frac{1}{2}$ an exact number of times, though it is agreed in arithmetic that 1 shall not be recognised as a common measure. Geometry makes no such exception whatever quantity is contained in another an exact number of times is a measure of that other. In like manner, $3\frac{1}{2}$, $7\frac{1}{2}$, would not be regarded as having a common measure in arithmetic, yet as the first number contains $\frac{1}{2}$ exactly 14 times, and the second contains $\frac{1}{2}$ exactly 29 times, $\frac{1}{2}$ is a common measure of the two numbers according to the above definition of the term. And whatever numbers be compared together, whether they be whole or fractional, it will be found that there always exists some smaller number—either whole or fractional—that will exactly measure both. Suppose, for instance, the proposed numbers, when brought to a common denominator, have (say) 12 for the common denominator, then each denotes so many *twelfths* that is, $\frac{1}{12}$ is a common measure of both. I do not say anything here about such expressions as $\sqrt{2}$, $\sqrt{6}$, $\sqrt{7}$, &c.; geometrical rigour forbids our calling what these symbols stand for, definite numbers, as they involve an endless series of fractions or decimals, and can only be valued *approximately*, yet they may be accurately represented by *lines*, as Euclid has himself shown in a Book not now read (Book X). We could not speak of any number being contained in $\sqrt{2}$ a certain number of times *exactly*, because $\sqrt{2}$ itself is not determinable exactly.

IV. *Equimultiples*, or *like multiples*, of two or more magnitudes, are those larger magnitudes which contain those of which they are multiples—each of each—the same number of times.

For instance, the numbers 8 and 12 are equimultiples of 2 and 3; for the former contain these, respectively, the same number of times, namely, *four times*. In like manner, $7\frac{1}{2}$ and 10 are equimultiples of $2\frac{1}{2}$ and $3\frac{1}{2}$; for the former numbers contain these, respectively, *three times*.

V. *Like submultiples* are those which are contained in their respective multiples the same number of times.

Thus, in the instances adduced above, 2 and 3 are like submultiples or like measures of 8 and 12; $2\frac{1}{2}$ and $3\frac{1}{2}$ are like submultiples or measures of $7\frac{1}{2}$ and 10.

VI. Four magnitudes are said to be *proportionals*, or to form a *proportion*, when the first cannot be contained in any multiple of the second oftener than the third is contained in a like multiple of the fourth, nor the third in any multiple of the fourth oftener than the first in a like multiple of the second.

The first and third of four such magnitudes are called *antecedents*, and the second and fourth their *consequents*. The definition affirms that an antecedent must be contained in each multiple of its consequent as often as the other antecedent is contained in a like multiple of its consequent, but not oftener.

VII. When four magnitudes are in proportion, the first antecedent is said to have the same *ratio* to its consequent that the second antecedent has to *its* consequent.

This term *ratio* has been the source of very considerable embarrassment to Geometers since the time of Euclid, and has been productive of much metaphysical disquisition and controversy. I think that on this subject, as well as in reference to the theory of parallel lines, mathematicians too often overlook the fact that the fundamental notions of geometry really exist in the mind anterior to and independently of the definitions of the science. These, for the most part, do not originate those notions, but only give to them the necessary degree of clearness and precision. If one pair of magnitudes be submitted to our contemplation, and then another pair be brought into comparison with them, as well as with each other, the mind is at once capable of forming a notion as to whether the *relative magnitudes* of the individuals of the first pair be the same or not as the relative magnitudes of those of the second pair: the *absolute* magnitudes of the individuals of one pair may be very different from the absolute magnitudes of those of the other pair; yet the former two may have the same *relation to one another*, as to magnitude, as the latter two; and the mind is quite capable of recognizing and understanding this sameness of relation, or of *ratio*, as it is called above, before any *name* is given to the conception. It is this *equality of ratios* of two magnitudes brought into comparison with other two, that renders the *four* proportionals.

That the foregoing definition of proportion (Def. VI.) includes numerical proportion, in Arithmetic, will be obvious upon a little consideration. Proportion limited to numbers may be defined thus:—

Four numbers are proportionals when the first is contained *exactly*, as often in some multiple (any *one* multiple being sufficient) of the second, as the third is contained in a *like* multiple of the fourth.

It is plain that if this condition have place, the four numbers must be proportionals according to the common arithmetical notion; for it follows of necessity that the quotient of the second by the first must then be the same as that of the fourth by the third, and consequently that the quotient of the first by the second must be the same as that of the third by the fourth.—(See Arithmetic, p. 31.)

Definition VI. above is, however, free from the restriction implied in the term *exactly*, which is introduced here into the particular case of it, applying exclusively to *numerical* proportion; since the general form of the definition admits of such restrictive qualification when numbers only are concerned; incommensurables being then excluded.

Four magnitudes not fulfilling the conditions of definition VI. would evidently violate even this arithmetical condition of proportion; there can be no such things as proportionals out of the restrictions of the former definition; so that all proportionals, whether among commensurables or incommensurables, must be included in the general definition VI.

VIII. The first and last of four proportionals are called the *extremes*, and the two intermediate ones the *means*.

IX. The magnitudes themselves are called the *terms* of the proportion; and those are called *homologous* or *like* terms which have the same *name*;—the *antecedents* forming one pair of homologous terms, and the *consequents* another pair.

X. Magnitudes, more than two, are said to form a *continued proportion* when each *consequent* in succession is taken for the *antecedent* of the term next following.

Thus, if A is to B, as B is to C, as C is to D, &c.; then A, B, C, &c., are in continued proportion.

XI. If the continued proportionals be but *three* in number, the middle one is called the *mean* term, and the others the *extremes*.

AXIOMS.

I. Equimultiples of the same magnitude, or of equal magnitudes, are equal to one another; so also are equi-submultiples.

II. A multiple of a greater magnitude exceeds a like multiple of a less; and a submultiple of a greater exceeds a like submultiple of a less.

III. The magnitude of which a multiple or submultiple is greater than a like multiple or submultiple of another, is greater than that other.

IV. Of any two magnitudes of the same kind, a multiple of one may be taken so great as to exceed the other.

—

Marks and Signs used for Abbreviation.

1. To express that four magnitudes, A, B, C, D, are proportionals, they are arranged thus: $A : B :: C : D$; and this expression is read, "as A is to B, so is C to D;" or, "A is to B, as C is to D."

2. And to express that magnitudes A, B, C, D, E, &c., form a series of continued proportionals, they are arranged thus: $A : B :: B : C :: C : D :: D : E$, &c., which is read, "as A is to B, so is B to C, and C to D, and D to E," &c.

3. Besides the marks $+$ and $-$ for addition and subtraction, the mark \smile is sometimes employed, to denote the *difference* of the two quantities between which it is placed; it is useful for this purpose when it is not stated *which* of the two quantities is the greater of the two; thus $A \smile B$ means simply the difference between A and B, or rather between the things denoted by these letters, without any assertion as to which is the greater. The double mark \pm between two quantities signifies "the sum or difference" of those quantities. Thus by 6 ± 2 we should understand "8 or 4."

4. The terms "greater than" and "less than" being of frequent use in what follows, convenient symbols for them are introduced: when \succ is placed between two quantities it implies that the first of them is *greater than* the second; and when \prec is placed between them, it denotes that the first of them is *less than* the second. Thus $A \succ B$ asserts that A is *greater than* B, or that A *exceeds* B; and $A \prec B$ affirms that A is *less than* B, or that B *exceeds* A.

5. In the following propositions, magnitudes (whether lines, surfaces, or solids), will be represented by the capital letters A, B, C, &c. They may, indeed, be taken to represent any quantities whatever, whether abstract or concrete; as the reasonings will be found to apply without restriction as to the nature of the things represented by the letters. But when *multiples* of these quantities are taken (that is, when they are multiplied by *numbers*), these numbers will be represented by the small letters; and, in general, by m, n, p, q .

PROPOSITION I.—THEOREM.

If any number of magnitudes be equimultiples of as many others, each of each, whatever multiple any one of the former is of the corresponding one of the latter, the *same multiple* is the sum of all the former of the sum of all the latter.

First, let there be but *two* magnitudes mA, mB , any equimultiples whatever of two others A, B; the *sum* of the former shall be *the same* multiple of the *sum* of the latter.

For the sum of the former is $mA + mB$; that is, $m(A + B)$; and the sum of the latter is $A + B$; and $m(A + B)$ is *the same multiple* of $A + B$, that mA is of A, or mB of B.

Next, let there be *three* magnitudes $m A, mB, m C$, equimultiples of the three A, B, C. The *sum* of the former three is $m A + m B + m C$; that is, $m(A + B + C)$, and

the sum of the latter three is $A + B + C$; and $m(A + B + C)$ is the same multiple of $A + B + C$, that mA is of A , or mB of B , or mC of C . And in the same manner is the proposition proved, when there are four magnitudes equimultiples of other four; when there are five magnitudes, six magnitudes, or any number of magnitudes, \therefore if any number of magnitudes, &c. Q. E. D.

PROPOSITION II.—THEOREM.

If, in any proportion, an antecedent and its consequent be respectively the same as an antecedent and its consequent in another proportion, the remaining antecedent and consequent in the former, together with the remaining antecedent and consequent in the latter, will form a proportion.

Let the two proportions be—

$$\begin{array}{l} A : B :: C : D \\ A : B :: E : F \end{array}, \text{ then } C : D :: E : F.$$

For (Def. VI.) m being any whole number whatever, C is contained in mD as often as A is contained in mB , but not oftener.

In like manner E is contained in mF as often as A is contained in mB , but not oftener.

Therefore C cannot be contained oftener in mD than E is contained in mF ; nor can E be contained oftener in mF , than C is contained in mD ; and m is any whole number whatever, \therefore (Def. VI.) the four magnitudes, C, D, E, F , are proportionals, \therefore if in any proportion, &c. Q. E. D.

PROPOSITION III.—THEOREM.

If, in any proportion, equimultiples of the antecedents and equimultiples of the consequents be taken; if the multiple of one of the antecedents be greater than that of its consequent, the multiple of the other antecedent will be greater than that of its consequent.

Let the proportion be—

$$A : B :: C : D.$$

If $mA > nB$, then $mC > nD$, and conversely; m and n being any whole numbers whatever.

For A is contained in mA exactly m times; but, by hypothesis, nB is less than mA , $\therefore A$ is contained in nB less than m times. But (Def. VI.) C is contained no oftener in nD , than A is contained in nB , $\therefore C$ is contained in nD , less than m times.

But C is contained in mC exactly m times, $\therefore C$ is contained in mC oftener than it is contained in nD , $\therefore mC > nD$.

In like manner, if the hypothesis be that $mC > nD$, may it be shown that $mA > nB$, \therefore if in a proportion, &c. Q. E. D.

Cor.—Since m and n may be any whole numbers whatever, let each be $= 1$: then it follows that:—

In a proportion if one antecedent be greater than its consequent, the other antecedent will be greater than its consequent.

PROPOSITION IV.—THEOREM.

In any proportion according as one antecedent is greater than, less than, or equal to its consequent, so will the other antecedent be greater than, less than, or equal to its consequent.

It has already been proved (Prop. III. Cor.) that if one antecedent be greater than its consequent, the other antecedent will be greater than its consequent. Let the proportion be.—

$$A : B :: C : D.$$

1st. If $A < B$, then $C < D$, and conversely. Let $B - A = P$; then a number m exists such that $mP > A$ (Ax. 4), $\therefore mB$ must contain A oftener than it contains B . But as D contains C as often as mB contains A (Def. VI.), $\therefore mD$ contains C oftener than mB contains B ; that is, oftener than m times, $\therefore C < D$. Consequently, if $A < B$ then $C < D$. And in like manner may it be shown that if $C < D$ then $A < B$.

2nd. If $A = B$ then $C = D$, and conversely.

For when $A = B$, if it were possible that $C > D$, or $C < D$, or, when $C = D$, if it were possible that $A > B$, or $A < B$, the foregoing conclusions would be contradicted, \therefore in any proportion, &c. Q. E. D.

PROPOSITION V.—THEOREM.

If four magnitudes be such, that whatever equimultiples of the antecedents, and whatever equimultiples of the consequents be taken, the multiple of one antecedent cannot be greater than that of its consequent, without the multiple of the other antecedent being greater also than that of its consequent, the four magnitudes are proportionals.

Let the four magnitudes be A, B, C, D . If they are not proportional, one of the antecedents, as A , must be contained in some multiple mB of its consequent oftener than C is contained in mD (Def. VI.) Therefore, p being any whole number, A must be contained oftener in pmB than C is contained in pmD .

Let nA be the greatest multiple of A that does not exceed pmB ; then nA is not $> pmB$, and A is contained in nA , and in pmB the same number of times, namely, n times. Therefore C is contained in pmD less than n times. But C is contained in nC exactly n times $\therefore nC > pmD$. Consequently of the four magnitudes, equimultiples of the antecedents, and equimultiples of the consequents, may be taken, as below:—

$$\begin{array}{cccc} A & B & C & D \\ nA & pmB & nC & pmD \end{array}$$

such that $nC > pmD$, and yet nA not $> pmB$: but, by hypothesis, this is impossible—therefore the magnitudes cannot be other than proportionals; \therefore if four magnitudes, &c. Q. E. D.

PROPOSITION VI.—THEOREM.

In any proportion, if like multiples of the antecedents, and like multiples of the consequents, be taken, the results will form a proportion.

Of the four proportionals, let equimultiples of antecedents and of consequents be taken as below, m, n, p , and q being any whole numbers.—

$$\begin{array}{cccc} A & B & C & D \\ mA & nB & mC & nD \\ pmA & qnB & pmC & qnD \end{array}$$

Then (Prop. III.) if $pmA > qnB$, it must follow that $pmC > qnD$; or if $pmC > qnD$, that $pmA > qnB$. But pmA , pmC , are any equimultiples of mA , mC ; and qnB , qnD , are any equimultiples of nB , nD . Consequently (Prop. V.),

$$mA : nB :: mC : nD.$$

Therefore, in any proposition, &c. Q. E. D.

NOTE.—Either m or n may of course be *unit*; as also in every case where the multiples are unrestricted.

In Proposition V. it was demonstrated that—"If four magnitudes be such that whatever equimultiples of the antecedents, and whatever equimultiples of the consequents be taken, the multiple of one antecedent cannot be greater than that of its consequent, without the multiple of the other antecedent being greater also than its consequent, the four magnitudes are proportionals." It is now proved that these multiples themselves are also proportionals. Consequently (Prop. IV.), according as the first multiple is greater than, less than, or equal to the second, so will the third multiple be greater than, less than, or equal to the fourth multiple. And this is the condition which constitutes Euclid's criterion of proportional magnitudes, as embodied in his celebrated *fifth* definition, which, in the version of Playfair, is expressed as follows:—

Euclid's Definition of Proportionals (Def. V.)

If there be four magnitudes, and if any equimultiples whatsoever be taken of the first and third, and any equimultiples whatsoever of the second and fourth, and if according as the multiple of the first is greater than the multiple of the second, equal to it, or less, the multiple of the third also is greater than the multiple of the fourth, equal to it, or less; then the four magnitudes are proportionals. This definition of Euclid is deduced here as a *theorem*; but in what follows it will be referred to as "Def. V. page 136."

PROPOSITION VII.—THEOREM.

The terms of any proportion form also a proportion when they are taken INVERSELY; that is, the second term is to the first as the fourth is to the third, or the second has the same ratio to the first that the fourth has to the third.

Let the proportion be $A : B :: C : D$; then also $B : A :: D : C$.

For (Prop. VI.) $mA : nB :: mC : nD$.

And (Prop. IV.) according as nB is greater than, less than, or equal to mA , so is nD greater than, less than, or equal to mC ; and m , n are any whole numbers whatever. But when this is the case in reference to four magnitudes B , A , D , C , they are proportionals. (Def. V., page 136).

$$\therefore B : A :: D : C.$$

Hence the terms of any proportion, &c. Q. E. D.

Cor.—Therefore a consequent is contained as often in a multiple of its antecedent, as the other consequent is contained in a like multiple of its antecedent, but not oftener. (Def. VI.)

PROPOSITION VIII.—THEOREM.

In any proportion, if equimultiples of the first two terms be taken, and also equimultiples of the last two, the results will form a proportion.

Let the proportion be $A : B :: C : D$; then also

$$mA : mB :: nC : nD$$

By Def. VI., $A : B :: mA : mB$; and $C : D :: nC : nD$

But $A : B :: C : D$; \therefore (Prop. II.) $C : D :: mA : mB$

and therefore, by the same prop., $mA : mB :: nC : nD$; \therefore in any proportion, &c. Q. E. D.

PROPOSITION IX.—THEOREM.

In a proportion consisting of *homogeneous* magnitudes—that is, magnitudes all of the same kind—if one antecedent be greater than the other, the consequent of the former will be greater than the consequent of the latter.

Let the magnitudes forming the proportion $A : B :: C : D$ be all of the same kind, and let $A > C$; then also $B > D$. For let $A - C = P$; then (Ax. 4) there exists some number m , such that $mP > D$, and consequently such that mA contains D oftener than mC contains D .

But by taking the terms of the proportion inversely (Prop. VII.)

$$B : A :: D : C$$

$$mB : mA :: mD : mC$$

$\therefore mA$ does not contain B oftener than mC contains D (Def. VI.), $\therefore mA$ contains D oftener than it contains B , therefore $B > D$; \therefore in a proportion, &c. Q. E. D.

COR. I.—In a proportion consisting of *homogeneous* magnitudes, if one consequent be greater than the other, the antecedent of the former will be greater than that of the latter.

This follows from the present proposition by *inversion*; and, consequently, in a proportion whose terms are all homogeneous, if one antecedent be greater than, less than, or equal to the other antecedent, the consequent of the former will be greater than, less than, or equal to the consequent of the latter, and conversely.

COR. II.—Therefore (Prop. II.) if two proportions have three corresponding terms in each equal, each to each, the fourth terms will be equal.

NOTE.—It must be carefully observed that Proposition IX., as also X. and XI. following, apply only when the magnitudes are all four of the same kind. There can be no such relation as that implied in the word *ratio* between things of different kinds. In the other propositions hitherto discussed, it is necessary only that the first and second of the magnitudes be of the same kind, and that the third and fourth be also of the same kind. The latter pair, however, may differ in kind from the former pair: one pair may be lines, or numbers, and the other pair surfaces, or solids: but no *ratio* can exist between *heterogeneous* quantities, or quantities unlike in kind.

PROPOSITION X.—THEOREM.

If any number of *homogeneous* magnitudes be proportionals, then as one antecedent is to its consequent, so is the sum of all the antecedents to the sum of all the consequents.

First, let there be four proportionals, and let any equimultiples of the antecedents and any equimultiples of the consequents be taken thus:—

$$A : B :: C : D$$

$$mA \quad nB \quad mC \quad nD$$

It is to be proved that

$$A : B :: A + C : B + D$$

By Prop. III. if $mA > nB$, then $mC > nD$; consequently, if $mA > nB$, then also $(mA + mC) > (nB + nD)$.

And conversely, if $(mA+mC) \nabla (nB+nD)$, then $mA \nabla nB$. For, from the first proportion, if this were not the case, neither could $mC \nabla nD$; and, consequently, neither could $(mA+mC) \nabla (nB+nD)$; \therefore if this latter condition have place, so, of necessity, must the condition $mA \nabla nB$.

\therefore (Prop. V.) $A : B :: A+C : B+D$.

Next let there be six proportionals,

$$A : B :: C : D :: E : F.$$

It has already been proved, in reference to the last four, that

$$C : D :: C+E : D+F$$

$$\text{But } C : D :: A : B.$$

\therefore , (Prop. II.) $A : B :: C+E : D+F$.

Consequently, by the first case above,

$$A : B :: A+C+E : B+D+F.$$

And in a similar way as the proof for six proportionals has been derived from that for four, so may the proof for eight be derived from that for six; and so on for any number of proportionals; \therefore if any number of homogeneous magnitudes, &c. Q. E. D.

PROPOSITION XI.—THEOREM.

If the terms of a proportion are all of the same kind, they also form a proportion when taken ALTERNATELY; that is, the first is to the third as the second is to the fourth. Let the homogeneous proportionals be

$$A : B :: C : D; \text{ then also } A : C :: B : D.$$

For let any equimultiples of A, B, and any equimultiples of C, D, be taken and arranged as below,

$$\begin{array}{cccc} A & : & B & :: & C & : & D; & & A & C & B & D \\ mA & mB & nC & nD; & mA & nC & mB & nD \end{array}$$

Then (Prop. VI.) $mA : mB :: nC : nD$; \therefore (Prop. IX.) if $mA \nabla nC$, then $mB \nabla nD$; and if $mB \nabla nD$, then $mA \nabla nC$.

\therefore (Prop. V.) $A : C :: B : D$.

Hence, if the terms of a proportion, &c. Q. E. D.

PROPOSITION XII.—THEOREM.

If in any proportion an antecedent be a multiple or submultiple of its consequent, the other antecedent will be a like multiple or submultiple of its consequent.

Let A, B, C, D be four proportionals, such that $A=mB$, then will $C=mD$. For since

$$A : B :: C : D$$

\therefore (Prop. VI.) $A : mB :: C : mD$; but $A=mB \therefore C=mD$ (Prop. IV.)

Again, let the proportionals be such that $B=mA$; then will $D=mC$.

For by inversion (Prop. VII.) $B : A :: D : C$

and (Prop. VI.) $B : mA :: D : mC$, but $B=mA \therefore D=mC$.

\therefore if in any proportion, &c. Q. E. D.

COR.—When the proportionals are homogeneous, if one antecedent be a multiple of the other, the consequent of the former will be a like multiple of the consequent of the latter.

PROPOSITION XIII.—THEOREM.

In any proportion, the sum of an antecedent and its consequent is to either term as the sum of the other antecedent and consequent is to the like term.

Let the proportion be $A : B :: C : D$

then $A+B : A :: C+D : C$

also $A+B : B :: C+D : D$

For A cannot be contained oftener in mB than C is contained in mD (Def. VI.), $\therefore A$ cannot be contained oftener in $m(A+B)$ than C is contained in $m(C+D)$. Nor can C be contained oftener in $m(C+D)$ than A is contained in $m(A+B)$; for if it could, C would be contained in mD oftener than A in mB , which is impossible (Def. VI.)
 $\therefore A : A+B :: C : C+D$.

Again, by inversion, $B : A :: D : C$; therefore, as just proved, $B : A+B :: D : C+D$; consequently, inverting the two proportions now deduced,

$A+B : A :: C+D : C$, and $A+B : B :: C+D : D$.

\therefore in any proportion, &c. Q. E. D.

Cor.—If the proportionals are homogeneous, then, by alternation (Prop. XI.),

$A+B : C+D :: A : C$; and $A+B : C+D :: B : D$.

PROPOSITION XIV.—THEOREM.

In any proportion, the difference between an antecedent and its consequent is to either term as the difference between the other antecedent and consequent is to the like term.

Let $A : B :: C : D$ be any proportion; then taking any antecedent and consequent, as A, B , suppose first that $B > A$, and consequently (Prop. IV.) that $D > C$.

Take any equimultiples of B, D , and the same of $B-A, D-C$; and arrange the terms as usual—

A	B	C	D
	mB		mD

A	$B-A$	C	$D-C$
	$mB-mA$		$mD-mC$

Then (Def. VI.) A cannot be contained oftener in mB than C is contained in mD ; but A is contained in mA just as often as C is contained in mC , namely, m times, without remainder. Therefore, A cannot be contained in $mB-mA$ oftener than C is contained in $mD-mC$.

In like manner may it be shown that C cannot be contained in $mD-mC$ oftener than A is contained in $mB-mA$; \therefore (Def. VI.)

$A : B-A :: C : D-C$; \therefore (Prop. XIII.) $B : B-A :: D : D-C$

And inverting these two proportions (Prop. VII.),

$B-A : A :: D-C : C$, and $B-A : B :: D-C : D$

which proves the theorem when $A > B$.

Next let $A > B$, and consequently (Prop. IV.) $C > D$.

By inversion, $B : A :: D : C$; \therefore as proved above,

$A-B : B :: C-D : D$, and $A-B : A :: C-D : C$,

which proves the theorem when $A > B$; $\therefore A \circ B : A :: C \circ D : C$; and $A \circ B : B :: C \circ D : C$ \therefore in any proportion, &c. Q. E. D.

PROPOSITION XV.—THEOREM.

If there be three magnitudes and other three, such that, whichever set be taken, the first in that set is to the second, as the second in the other set to the third; then, if the

first in one set be greater than the third, the first in the other set also will be greater than the third.

Let the two sets of magnitudes be—

$$\left. \begin{array}{l} A \ B \ C \\ D \ E \ F \end{array} \right\} \text{ such that } \left\{ \begin{array}{l} A : B :: E : F \\ D : E :: B : C. \end{array} \right.$$

If $A > C$ then must $D > F$; and if $D > F$, then $A > C$. Let $A > C$; and take mA , mC , such equimultiples of A , C that mA may contain B *oftener* than mC contains B (Ax. 4); take also mE , the same multiple of E . Then since by the second proportion mE contains D only as *often* as mC contains B , $\therefore mA$ contains B *oftener* than mE contains D .

But mE contains F as often as mA contains B (Prop. VII., Cor.), therefore mE contains F *oftener* than mE contains D , $\therefore D > F$. So that if $A > C$, then must $D > F$.

And in like manner may it be demonstrated that if $D > F$ then must $A > C$; \therefore if there be three magnitudes, &c. Q. E. D.

PROPOSITION XVI.—THEOREM.

If there be three magnitudes and other three such that whichever set be taken, the first in that set is to the second, as the second in the other set is to the third; then the first in the one set will be to the third, as the first in the other set is to the third.

Let the two sets of magnitudes be—

$$\left. \begin{array}{l} A \ B \ C \\ D \ E \ F \end{array} \right\} \text{ such that } \left\{ \begin{array}{l} A : B :: E : F \\ D : E :: B : C, \end{array} \right.$$

it is to be proved that $A : C :: D : F$.

Of A , B , D take any equimultiples, mA , mB , mD , and of C , E , F , any equimultiples, nC , nE , nF ; then (Prop. VIII.) $mA : mB :: nE : nF$, $\left. \begin{array}{l} mA \ mB \ nC \\ mD \ nE \ nF. \end{array} \right\}$ and (Prop. VI.) $mD : nE :: mB : nC$.

Hence the first of the three magnitudes, on the right, are related to the other three, as in Proposition XV.; \therefore if $mA > nC$, then $mD > nF$; or if $mD > nF$, then $mA > nC$. Consequently, (Prop. V.) $A : C :: D : F$; \therefore if there be three magnitudes, &c. Q. E. D.

Cor.—If to one of the above sets a *fourth* magnitude P be annexed, and to the other set, a *fourth* magnitude Q be prefixed, such as to furnish an additional proportion, $Q : D :: C : P$; then, from the hypotheses, and the foregoing conclusion, namely, that—

$$\left. \begin{array}{l} A \ B \ C \ P \\ Q \ D \ E \ F \end{array} \right\} \text{ are such that } \left\{ \begin{array}{l} A : C :: D : F \\ Q : D :: C : P, \end{array} \right.$$

it follows that A , C , P are related to Q , D , F , as in the proposition; and therefore that $A : P :: Q : F$. And in this way may the proposition be extended to any number of magnitudes.

PROPOSITION XVII.—THEOREM.

If there be two sets of magnitudes, the number being the same in each set, such that the first is to the second in the one set, as the first to the second in the other set, the second to the third in the former set, as the second to the third in the latter set, and so on: then as the first magnitude in the one set is to the last, so is the first magnitude in the other set to the last.

First, let there be three magnitudes in each set, namely—

$$\left. \begin{array}{l} A \ B \ C \\ D \ E \ F \end{array} \right\} \text{such that } \left\{ \begin{array}{l} A : B :: D : E \\ B : C :: E : F, \end{array} \right.$$

then it is to be proved that $A : C :: D : F$.

Take any equimultiples, mA , mD of A , D ; and any equimultiples nC , nF , of C , F ; then (Props. VI. and VII.),

$$\begin{array}{l} B : mA :: E : mD \\ \text{and } B : nC :: E : nF \end{array} \qquad \begin{array}{l} A \ C \ D \ F \\ mA \ nC \ mD \ nF. \end{array}$$

Let $mA \succ nC$, then (Ax. 4) a multiple pmA of mA , may be taken so great that pmA will contain B oftener than pnC will contain B . But pmD contains E as often as pmA contains B , (Def. V.); while pnF contains E only as often as pnC contains B , $\therefore pmD$ contains E oftener than pnF contains E , $\therefore mD \succ nF$; so that if $mA \succ nC$ then $mD \succ nF$. In like manner it may be proved, by interchanging A , C with D , F , and also interchanging B with E , that if $mD \succ nF$, then $mA \succ nC$; $\therefore A : C :: D : F$.

Next let there be *four* magnitudes in each set, namely—

$$\left. \begin{array}{l} A \ B \ C \ P \\ D \ E \ F \ Q \end{array} \right\} \text{such that } \left\{ \begin{array}{l} A : C :: D : F \\ C : P :: F : Q, \end{array} \right.$$

then it is to be proved that $A : P :: D : Q$. And this is done as in the first case, since the three magnitudes A , C , P are related, by the foregoing proportions, to the three D , F , Q , as that case supposes; $\therefore A : P :: D : Q$. And in like manner may the case for *five* magnitudes be deduced from this for *four*; and so on for any number of magnitudes in each set; \therefore if there be two sets of magnitudes, &c. Q. E. D.

COR.—If the consequents in one proportion be the antecedents in another, a third proportion may be formed, having the same antecedents as the first, and the same consequents as the second; thus if—

$$\begin{array}{l} A : B :: C : D \\ \text{and } B : K :: D : L \end{array}, \text{ then } A : K :: C : L.$$

NOTE.—It will be observed that, in the last three propositions, the magnitudes in each set are *all of the same kind*; but that those in one set, need not be of the same kind as those in the other set.

PROPOSITION XVIII.—THEOREM.

In any proportion the sum of the first two terms is to their difference as the sum of the other two is to their difference.

$$\text{Let } A : B :: C : D; \text{ then } A + B : A - B :: C + D : C - D.$$

$$\text{For (Prop. XIII.) } A + B : A :: C + D : C,$$

$$\text{and (inverting Prop. XIV.) } A : A - B :: C : C - D.$$

Consequently (Prop. XVII., Cor.) $A + B : A - B :: C + D : C - D$, \therefore in any proportion, &c. Q. E. D.

PROPOSITION XIX.—THEOREM.

If the antecedents in one proportion be the same as those in another, then the first antecedent is to the sum or difference of the first consequents as the second antecedent is to the sum or difference of the second consequents.

Let the proportions be $A : B :: C : D$; and $A : E :: C : F$; it is to be proved that $A : B + E :: C : D + F$.

Inverting the first of the given proportions (Prop. VII.)

$$\begin{array}{l} B : A :: D : C \\ \text{but } A : E :: C : F \end{array} \therefore \text{(Prop. XVII., Cor.) } B : E :: D : F.$$

Consequently (Props. XIII. XIV.) $B : B \pm E :: D : D \pm F$; and, comparing this with the first of the given proportions,

$$A : B + E :: C : D + F; \therefore \text{if the antecedents, \&c. Q. E. D.}$$

COR.—If the terms are all *homogeneous*, then by *alternation*, $A : C :: B + E : D + F$; and $B : D :: B + E : D + F$.

PROPOSITION XX.—THEOREM.

In a proportion whose terms are *homogeneous*, the sum of the greatest and least terms exceeds the sum of the other two.

Let $A : B :: C : D$; and first let an antecedent, A , be the greatest term; then will D be the least (Prop. IX.); and it is to be proved that $(A + D) > (B + C)$.

By Prop. XIV., and inversion, $A : A - B :: C : C - D$: but by hyp. $A > C$, \therefore (Prop. IV.) $(A - B) > (C - D)$. To each of these unequals add $B + D$, then $(A + D) > (B + C)$.

Next, let a consequent, B , be the greatest: then by inverting the proportion, $B : A :: D : C$; and since by hyp. B is the greatest of these, C is the least, and \therefore as just proved $(B + C) > (A + D)$; \therefore in a proportion, &c. Q. E. D.

COR.—If the proportion be $A : B :: B : C$, then $(A + C) > 2B$; that is the sum of the extremes, in three proportionals, exceeds twice the mean.

The three propositions following, though of no application in the Sixth Book of Euclid, will be found useful in the consideration of *incommensurable quantities*.

PROPOSITION XXI.—THEOREM.

If a magnitude measure each of two others, it will also measure their sum and difference.

Let A, B be any two magnitudes, and let C be a third magnitude which measures each; that is such that $A = mC$ and $B = nC$, m and n being whole numbers. Then $A + B = mC + nC = (m + n)C$; also $A \oslash B = mC \oslash nC = (m \oslash n)C$: but C is contained in the former $m + n$ times exactly, and in the latter $m \oslash n$ times exactly, $\therefore C$ measures both $A + B$, and $A \oslash B$; \therefore if a magnitude &c. Q. E. D.

COR.—If C measure B , and also $A + B$ and $A - B$, it must likewise measure A : for the sum of $A - B$ and B is A , and the difference of $A + B$ and B , is A ; and, as shown above, C measures both this sum and difference.

PROPOSITION XXII.—PROBLEM.

Two magnitudes of the same kind being given to find their greatest common measure.

Let the two given magnitudes be A, B : it is required to find the greatest magnitude that will measure both. Let A be the greater of the two magnitudes, and from it take the greatest possible multiple of B (viz. mB), leaving a remainder C , less, of course, than B . In like manner, take from B the greatest possible multiple of C (viz. nC), leaving a remainder D , less than C . In like manner take from C the greatest possible multiple of D (viz. pD), leaving a remainder E less than D ; and so on, as in the margin: the greatest common measure will be that remainder which exactly measures the preceding one: for instance, if E measures D so that $qE = D$, then E is the greatest common measure of A and B .

$$\begin{array}{r} B)A(M \\ \underline{mB} \\ C)B(n \\ \underline{nC} \\ D)C(p \\ \underline{pD} \\ E)E(q \\ \underline{qE} \\ \text{\&c.} \end{array}$$

For every common measure of A and B, as it measures B, will measure mB ; consequently, as it at the same time measures A, it will measure $A - mB$, by last proposition; that is, it will measure C. This being the case, it must also measure nC , and therefore, last proposition, it must measure $B - nC$; that is, it must measure D: for similar reasons it must measure E; and so on. Consequently every measure of A and B also measures each of the remainders C, D, E, &c.; and as these remainders become less and less, it follows that that must be the *greatest* common measure which is exactly equal to the last of these remainders, and at which the operation terminates. But if the operation never terminates, the diminishing series of remainders being continued without end, then, as there is no last remainder, there can be no common measure at all:—in other words, the magnitudes A, B will be *incommensurable*.

PROPOSITION XXIII.—THEOREM.

If one magnitude contain another, and leave a remainder, such that the greater of the two magnitudes is to the less, as the less is to that remainder, then the two magnitudes will be incommensurable. Let A, B be the two magnitudes, such that the greater A contains the less B, m times, leaving a remainder C; that is, such that $A - mB = C$; then if $A : B :: B : C$, the magnitudes A, B will be *incommensurable*.

For let C, D, E, &c., be the successive remainders in the operation for finding the common measure (Prop. XXII.). Then C cannot measure B, for then B would measure A, so that there would not be any remainder (Prop. XII.); but C is contained as often in B as B is contained in A (Def. VI.). Let mB be the greatest multiple of B which is contained in A, and take mC , an equimultiple of C: then (Prop. VIII.) $A : B :: mB : mC$, and (Props. XIV. and XI.) $A : B :: A - mB : B - mC$: but by hypothesis $A - mB = C$, and $B - mC = D$; therefore $A : B :: C : D$; and since $A : B :: B : C$, \therefore (Prop. II.) $B : C :: C : D$; hence D cannot measure C, inasmuch as C cannot measure B, (Prop. XII.).

Let now nC be the greatest multiple of C in B, and take nD , an equimultiple of D: then, from what is proved above, $C : D :: D : E$; hence E cannot measure D, inasmuch as D, as just proved, cannot measure C. And the reasoning is the same for every successive remainder; so that no remainder can ever measure the preceding remainder; and therefore the operation for the common measure can never terminate; that is, the two magnitudes A, B are *incommensurable*, \therefore if one magnitude &c. Q. E. D.

The operation explained in Prop. XXII. is that actually performed on a pair of numbers, when the object is to ascertain whether those numbers have a common measure, and to discover the *greatest* common measure.

In this *arithmetical* process, should a remainder ever become 1, we conclude that no common measure of the two numbers exists; because in *Arithmetic*, as remarked at page 131, 1 is not regarded as an arithmetical common measure. When the two numbers have no factor in common, a unit-remainder must always occur to apprise us of the fact, after a finite number of steps of the work; since the remainders—all whole numbers—go on continually *diminishing*. But in magnitudes not susceptible of numerical representation, the operation referred to could not be practically applied, as long as any remainder occurred, so long must the work be continued; and therefore, in the case of incommensurable magnitudes, it would be endless, even if we could practically carry forward the steps. But the proposition just established furnishes a geometrical test of incommensurability that may be readily appealed to, as will be seen in

the proposition respecting the side and diagonal of a square, at the end of the Sixth Book. It is also shown (page 157), by aid of the present theorem, that if a line be divided, as in Prop. XI., Book II., the two parts of that line will be incommensurable; and therefore that it would be quite impossible to express *both* by numerical values of their lengths.

ELEMENTS OF EUCLID.—BOOK VI.

DEFINITIONS.

I.

Similar rectilineal figures are those which have the several angles in one equal to those in the other, each to each, and the sides *about* the equal angles—that is, which *include* the equal angles, proportionals.



II.

Two sides of one figure are said to be *reciprocally proportional* to two sides of another, when one of the sides of the first is to one of the sides of the second as the remaining side of the second is to the remaining side of the first.

III.

A straight line is said to be cut in *extreme and mean ratio*, when the whole is to the greater segment as the greater segment is to the less.

IV.

The *altitude* of any figure is the straight line drawn from its vertex perpendicular to the base, or opposite side, and terminating in that side, or the side prolonged.

Thus the perpendicular A D, drawn from the vertex A to the base B C, is the altitude of the triangle A B C, at page 149.

PROPOSITION I.—THEOREM.

Triangles and parallelograms of the same altitude are to one another as their bases.

Let the triangles A B C, A D K, and the parallelograms E C, F D, have the same altitude: then as the base B C is to the base D K, so is the triangle A B C to the triangle A D K, and the parallelogram E C to the parallelogram F D.

Produce B K both ways to H and L, and make B G, G H, &c., any number of
 * § I. them, each equal to B C ; *
 and K I, &c., any number of them, each
 equal to D K ; and draw A G, A H, &c., and
 A I, &c. ; then the triangles A B C, A G B,
 + § I. A H G, &c., are all equal ; †

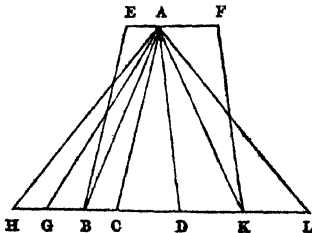

and if the base of the triangle which is the sum of all these be n times B C, the triangle
 * § I. itself will be n times the triangle A B C. * In like manner if D I be n
 times D K, the triangle A D I will be n times A D K.

base BC * base DK triangle ABC triangle ADK,
m. BC *n.* DK *m.* ABC *n.* ADK

Hence if *m.* BC = *n.* DK, then *m.* ABC = *n.* ADK; if *m.* BC > *n.* DK, then *m.* ABC > *n.* ADK; and if *m.* BC = *n.* DK, then *m.* ABC = *n.* ADK, and *m.*, *n.* are any whole numbers whatever, ∴ (Def. V., page 136.)

base B G * base D K ∴ triangle A B C : triangle A D K.

And because the parallelogram EC is double of the triangle ABC, and the parallelogram FD double of the triangle ADK, ∴ triangle ABC : triangle ADK :: + 8 V. parallelogram EC : parallelogram FD; † and, comparing this proportion with the last, base BC : base DK :: parallelogram EC : parallelogram * 2 V. FD, * ∴ triangles and parallelograms, &c. Q. E. D.

COR.—If triangles or parallelograms have equal altitudes they are to one another as their bases.

For if the figures be so placed as to have their bases in the same straight line, and perpendiculars be drawn from the vertices to the bases, the straight line joining the * 23 I. vertices will be parallel to that in which are the bases,* since the perpendiculars are both equal and parallel; † and ∴ if the above construction be made, the demonstration will be the same.

PROPOSITION II.—THEOREM.

If a straight line (DE) be drawn parallel to one of the sides (BC) of a triangle, it shall cut the other sides, or these produced, proportionally; and if the sides, or the sides produced, be cut proportionally, the straight line which joins the points of section shall be parallel to the remaining side of the triangle.

For draw BE, CD. Then the triangle BDE = CDE, because they are on the same base DE, and are between the same parallels DE, * 37 I. BC; * and ADE is another triangle, ∴ BDE : ADE :: CDE : ADE. But BDE : ADE :: BD : + 1 VI. DA. † For a

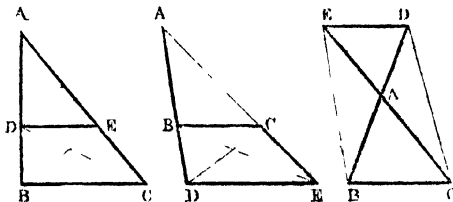

similar reason CDE : ADE ∴ CE : EA, * 2 V. ∴ BD : DA :: CE : EA.*

Again, let the sides AB, AC, or these produced, be cut proportionally in the points D, E; that is, so that BD : DA :: CE : EA; and draw DE; DE shall be parallel to BC. The same construction being made, because

BD : DA :: CE : EA, and BD : DA :: + 1 VI. BDE : ADE, † and CDE : ADE. } ∴ (2 V.) BDE : ADE :: CDE : ADE.
 * 1 VI. ADE :: CE : EA.*

† 9 V. Cor. 1. But as the consequents are equal the antecedents are equal, † ∴ triangle BDE = triangle CDE; and they are on the same base DE, and are between the same parallels, ∴ DE is parallel to BC; ∴ if a straight line, &c. Q. E. D.

PROPOSITION III.—THEOREM.

If an angle (BAC) of a triangle, be divided into two equal angles, by a straight line which cuts the opposite base, the segments of the base (BD , DC) shall be to each other as the remaining sides of the triangle; and if the segments of the base are to each other as the remaining sides of the triangle, the straight line drawn from the vertex to the point of section, shall divide the vertical angle into two equal angles.

* 31 I. Draw CE parallel to DA ; * and let BA produced meet CE in E . Because AC meets the parallels AD , EC , the angle $ACE =$

+ 29 I. CAD ; † but, by hypothesis, $CAD =$
 BAD ; $\therefore BAD = ACE$. Again, because BE meets the parallels AD , EC , the angle $BAD =$

* 29 I. AEC ; * but it was proved that $ACE =$
 BAD , $\therefore ACE = AEC$, and $\therefore AE = AC$; and since AD is parallel to EC , a side of the triangle

+ 2 VI. BCE ; $\therefore BD : DC :: BA : AE$; † but $AE = AC$,
 $\therefore BD : DC :: BA : AC$.

Next let $BD : DC :: BA : AC$; and draw AD ; the angle BAC shall be divided into two equal angles by AD .

* Const. The same construction being made, AD is parallel to EC ,* and because

+ 2 VI. $BD : DC :: BA : AC$, and } \therefore (2 V.) $BA \cdot AC = BA \cdot AE$, $\therefore AC$
 + 9 V. Cor. $BD : DC :: BA : AE$, † } $= AE$, *

+ 29 I. and consequently the angle $AEC = ACE$; but $AEC = BAD$, † and ACE

* 29 I. $= CAD$, * $\therefore BAD = CAD$; that is, the angle BAC is divided into two equal angles by AD ; \therefore if an angle, &c. Q. E. D.

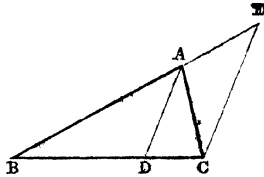

PROPOSITION A.—THEOREM.

If the outward angle (CAE) of a triangle (ABC) made by producing one of its sides, be divided in two equal angles, by a straight line (AD) which cuts the base produced, the segments (BD , DC) between the dividing line and the extremities of the base, are to each other as the remaining sides of the triangle; and if the segments of the base produced are to each other as the remaining sides of the triangle, the straight line drawn from the vertex to the point of section, divides the outward angle of the triangle into two equal angles.

* 31 I. Through C draw CF parallel to AD . *

Then because AC meets the parallels AD , FC , the

+ 29 I. angle $ACF = CAD$; † but (hyp.) $CAD =$
 DAE , $\therefore DAE = ACF$. Again, because FE meets the parallels AD , FC , the angle $DAE =$

* 29 I. CFA ; * but as just proved, $DAE = ACF$
 + 6 I. $\therefore CFA = ACF$; $\therefore AC = AF$. † And because AD is parallel to FC , a side of the triangle

BCF , $\therefore BD : DC :: BA : AF$; but $AC = AF$, \therefore
 $BD : DC :: BA : AC$.

Next, let $BD : DC :: BA : AC$; and draw AD ; the angle CAD shall be equal to DAE .

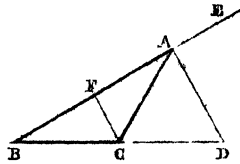

The same construction being made, because

BD : DC :: BA : AC, and BD : } ∴ (2 V.) BA : AC :: BA : AF, ∴ AC = AF,
 * 2 VI. DC :: BA : AF,* }
 † 5 I. ∴ the angle AFC = ACF; † but AFC = EAD, and ACF = CAD,* ∴
 * 29 I. EAD = CAD; ∴ if the outward angle, &c. Q. E. D.

PROPOSITION IV.—THEOREM.

The sides about the equal angles of equiangular triangles (ABC, DCE) are proportionals; and those which are opposite to the equal angles are homologous sides; that is, are the antecedents, or the consequents of the ratios.

Let the angle ABC = DCE; ACB = DEC; and consequently BAC = CDE; and let the triangle DCE be placed so that its side CE may be contiguous to BC, and in the same straight line with it; then the angle BCA =

† Hyp. CED. † Add to each the angle B; then BCA + B = CED + B; but the former two are less than

* 17 I. two right angles,* ∴ CED + B, are less than two right angles, ∴ BA, ED, if produced will

† Ax. 12. meet; † let them be produced and meet in F. Then because the angle B = DCE, BF is parallel to

* 28 I. CD;* and because ACB = DEC, AC is parallel † 34 I. to FE; ∴ FC is a parallelogram, † ∴ AF =

CD, and AC = FD; and because AC, CD are respectively parallel to FE, BF, sides of the triangle FBE, ∴ (1 VI.)

BC : CE :: BA : AF) or since AF = CD, (BC : CE :: BA : CD
 and BC : CE :: FD : DE) and FD = AC (BC : CE :: AC : DE

* 2 V. ∴ BA : CD :: AC : DE.* Alternating these three proportions,
 BC : BA :: CE : CD; BC : AC :: CE : DE; BA : AC :: CD : DE.

∴ the sides about the equal angles, &c. Q. E. D.

Cor.—In similar triangles (ABC, DEF), the bases (BC, EF) are to one another as the altitudes (AG, DH). For since the angles B, E are equal, as also the right angles G, H, the triangles ABG, DEH are equiangular, ∴ AB : AG :: DE : DH; but BC : AB :: EF :

* Def. I. VI. ED;* ∴ BC : AG :: EF :

† 15 V. Cor. DH; † hence, alternately, the bases are as the altitudes.

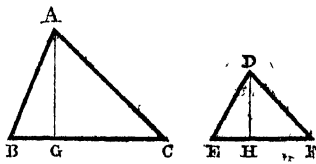
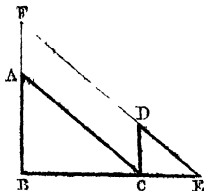

PROPOSITION V.—THEOREM.

If the sides of two triangles (ABC, DEF), about two angles (B, C) of one, and two angles (E, F) of the other, be proportionals, the triangles shall be equiangular; and the equal angles shall be those which are opposite to homologous sides.

At the points E, F, in the straight line EF, make the angle FEG = B, and EFC = C;

then the remaining angle $G=A$, and \therefore the triangles ABC, GEF , are equiangular,

* 4 VI. $\therefore AB : BC :: GE : EF$; * but (hyp.)

+ 2 VI. $AB : BC :: DE : EF$; $\therefore DE : EF :: GE : EF$; †

$\therefore DE=GE$. For a like reason $DF=GF$. And because in the triangles $DEF, GEF, DE=GE$, and EF common, the two sides DE, EF are equal to the two GE, EF , each to each, and $DF=GF$; \therefore the angle $DEF=$

* 8 I. GEF ,* and the angle $DFE=GFE$, and $EDF=EGF$. And because $DEF=GEF$, and $GEF=$

† Const. B , † $\therefore DEF=B$. For a like reason $DFE=C$, and $\therefore D=A$; \therefore the triangle DEF is equiangular to ABC ; \therefore if the sides, &c. Q. E. D.

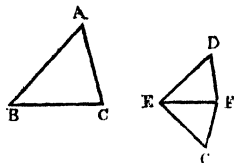

PROPOSITION VI.—THEOREM.

If two triangles (ABC, DEF) have an angle (A) of one equal to an angle (EDF) of the other, and the sides about them proportionals, the triangles shall be equiangular, and shall have those angles equal which are opposite to the homologous sides.

At the points D, F , in the straight line DF , make the angle FDG equal to either of the angles A , or EDF ; and the angle DFG equal to C ; then the remaining angle $G=B$, and \therefore the triangles ABC, DGF are equian-

* 4 VI. gular; $\therefore BA : AC :: GD : DF$; *

but (hyp.) $BA : AC :: ED : DF$; $\therefore ED : DF ::$

+ 2 V. $GD : DF$; † $\therefore ED=GD$; \therefore in the triangles EDF, GDF , the two sides $ED, DF=GD, DF$,

* Const. each to each, and the angle $EDF=GDF$; *

+ 4 I. $\therefore EF=FG$ †, and the angle $DFG=$

* 4 I. DFE , and $G=E$; * but $DFG=C$

(const.) $\therefore DFE=C$; but $EDF=A$ (const.), \therefore

$E=B$; \therefore the triangles ABC, DEF are equiangular; \therefore if two triangles, &c. Q. E. D.

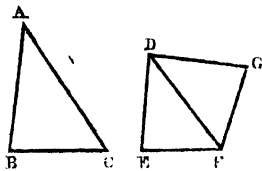

PROPOSITION VII.—THEOREM.

If two triangles (ABC, DEF) have an angle (A) of one equal to an angle (D) of the other, and the sides about two (ABC, DEF) proportionals; then if each of the remaining angles (C, F) be either less, or not less, than a right angle, the triangles shall be equiangular, and shall have those angles equal about which the sides are proportionals.

First let each of the angles C, F be less than a right angle: the angles ABC and F shall be equal, and \therefore the angle C to the angle F . For if ABC be not equal to E , one of them, as ABC , must be the greater. At the point B , in AB , make the angle $ABG=E$; then because $A=D$ (hyp.), the remaining angle AGB must be

* 32 I. $=F$; * \therefore the triangles $ABG,$

DEF are equiangular, $\therefore AB : BG :: DE : EF$.

But (hyp.) $AB : BC :: DE : EF$, $\therefore AB :$

+ 9 V. Cor. 1. $BC :: AB : BG$, $\therefore BC=BG$, †

and $\therefore BGC=BCG$; but (hyp.) BCG is less

than a right angle, $\therefore BGC$ is less than a

right angle; $\therefore AGB$ must be greater than a

right angle: but it was proved that $AGB=F$;

$\therefore F$ is greater than a right angle; but (hyp.) it is less than a right angle; which is

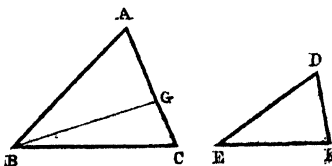

absurd; ∴ the angles ABC, E are not unequal, that is, they are equal; and, as A=D (hyp.) ∴ C=F; ∴ the triangles ABC, DEF are equiangular.

Next, let C, F be each not less than a right angle: the triangles shall also in this case be equiangular. For if it be denied, then, the same construction being made, it may be proved, as above, that BC=BG; and that ∴ the angle BGC=C: but (hyp.) C is not less than a right angle: ∴ BGC is not less than a right angle ∴ two angles of the triangle BGC are together not less than two right angles: which is impossible; ∴ the triangle ABC, as in the first case, is equiangular to DEF. ∴ if two triangles, &c. Q. E. D.

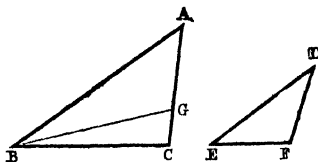

PROPOSITION VIII.—THEOREM.

In a right-angled triangle (ABC), if a perpendicular (AD) be drawn from the vertex of the right angle to the base, the triangles (ABD, ACD) on each side of it are similar to the whole triangle (ABC) and to one another.

Because the angle BAC = ADB, each being a right angle, and that B is common to the two triangles ABC, ABD, ∴ the
 * 32 I. angle ACB = BAD; * ∴ the triangles ABC,
 + 4 VI. ABD are equiangular, ∴ they are similar. †
 and Def. 1. like manner it may be demonstrated that the triangles ABC, ACD are similar; ∴ the triangles ABD, ACD being both similar to ABC, are similar to each other; ∴ in a right-angled triangle, &c. Q. E. D.

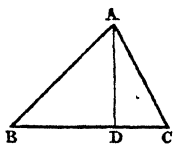

Cor. From this it is manifest that the perpendicular from the vertex of the right angle of a right-angled triangle to the base is a mean proportional between the segments of the base; and also that each side about the right angle is a mean proportional between the base, and the segment of it adjacent to that side: for in the triangles BDA,
 * 4 VI. CDA, BD : DA :: DA : DC; * in the triangles ABC, DBA, BC : BA :: BA : BD; and in the triangles ABC, ACD, BC : CA :: CA : CD.

PROPOSITION IX.—PROBLEM.

From a given straight line (AB) to cut off any part required.

From A draw a straight line AC, making any angle with AB; and in it take any point D; and take AC, the same multiple of AD, that AB is of the part to be cut off. Draw BC, and DE parallel to

* 31 I. it, * then AE shall be the part required to be cut off.
 Because ED is parallel to BC, a side of the triangle ABC, ∴
 + 13 V. CD : DA :: BE : EA; ∴ AC : AD :: AB : AE; † but
 * Const. AC is a multiple of AD, * ∴ AB is the same multiple of AE; that is, whatever part AD is of AC, the same part is AE of
 + 7 V. Cor. AB, † ∴ from AB, the part required, AE is cut off: which was to be done.

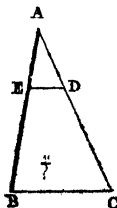

PROPOSITION X.—PROBLEM.

To divide a given straight line (AB) similarly to a given divided straight line (AC).
 Let AC, placed so as to make any angle with AB, be divided in the points D, E.
 Draw BC; and through the points D, E draw DF, EG parallels to it: AB shall be divided in F, G similarly to AC. Through D draw DHK, parallel to AB: then each of the figures FH
 * 31 I. HB is a parallelogram, \therefore DM = FG,* and HK = GB; and because HE is parallel to KC, a side of the triangle
 † 2 VI. angle DKC, \therefore CE : ED :: KH : HD; † but KH = BG, and HD = GF; \therefore CE : ED :: BG : GF. Again, because FD is parallel to GE, a side of the triangle AGE, \therefore ED : DA :: GF : FA: and it was before proved that CE : ED : BG : GF; \therefore the given straight line is divided similarly to AC, which was to be done.

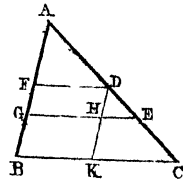

PROPOSITION XI.—PROBLEM.

To find a third proportional to two given straight lines (AB, AC).
 Let the lines be placed so as to make any angle A, and produce them to D, E. Make BD = AC, draw BC, and through D draw DE
 * 31 I. parallel to it: CE shall be a third proportional to AB, AC. Because BC is parallel to DE, \therefore AB : BD :: AC : CE; but BD + Const. = AC; † \therefore AB · AC :: AC · CE; \therefore to the two given straight lines AB, AC, a third proportional CE is found: which was to be done. Q. E. D.

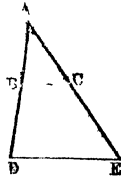

PROPOSITION XII.—PROBLEM.

To find a fourth proportional to three given straight lines (A, B, C).
 Take two straight lines DE, DF, making any angle D; and upon these take DG = A, GE = B, and DH = C. Draw GH, and EF parallel to it: FH shall be a fourth proportional to A, B, C. Because GH is parallel to EF, \therefore DG : GE :: DH : HF; but DG = A, GE = B, and DH = C. Const. = C, * \therefore A · B : C · HF, \therefore to the three given straight lines A, B, C, a fourth proportional HF is found: which was to be done.

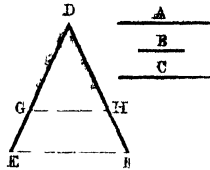

PROPOSITION XIII.—PROBLEM.

To find a mean proportional between two given straight lines.
 Let the parts AB, BC be equal to the two given straight lines: it is required to find a mean proportional between them. Upon AC describe the semicircle ADC, and from B draw BD perpendicular to
 * 11 I. AC; * BD shall be a mean proportional between AB, BC.
 Draw AD, CD. Then because the angle ADC, in a
 † 31 I. semicircle is a right angle, † and that in the right angled triangle ADC, DB is drawn from the vertex of the right angle perpendicular to the base, DB is a mean proportional between AB,

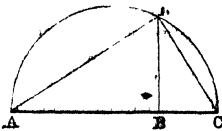

* 8 VI. Cor. BC, \therefore between AB, BC , a mean proportional DB , is found: which was to be done.

PROPOSITION XIV.—THEOREM.

Equal parallelograms (AB, BC) which have an angle (B) of the one equal to an angle of the other, have their sides about the equal angles reciprocally proportional: and parallelograms that have an angle of the one equal to an angle of the other, and the sides about those angles reciprocally proportional, are equal to one another.

Let the sides DB, BE , be placed in the same straight line; then because $FBD + FBE =$ two right angles, and that $FBD = GBE$ (hyp), $\therefore GBE + FBE =$ two right angles; $\therefore FB, BG$ are in one straight line. It is to be proved that $DB : BE :: GB : BF$. Complete the parallelogram FE . Then because $AB = BC, AB : FE :: BC : FE$;

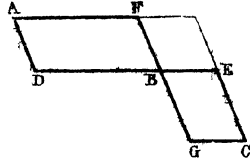

* 1 VI. but $AB : FE :: DB : BE, *$ and $BC : FE ::$
 + 2 V. $GB : BF, \therefore DB : BE :: GB : BF; \dagger \therefore$
the sides of the equal parallelograms AB, BC , about their equal angles are reciprocally proportional.

Next, let the sides about the equal angles be reciprocally proportional; namely: $DB : BE :: GB : BF$; then is $AB = BC$. Because $DB : BE :: GB : BF$, and $DB :$

* 1 VI. $BE :: AB : FE$, and $GB : BF :: BC : FE, *$ $\therefore AB : FE :: BC : FE, \dagger \therefore$
 + 2 V. $AB = BC, \therefore$ equal parallelograms, &c. Q. E. D.

PROPOSITION XV.—THEOREM.

Equal triangles (ABC, ADE), which have an angle (A) of the one equal to an angle of the other, have their sides about the equal angles reciprocally proportional; and triangles which have an angle of the one equal to an angle of the other, and their sides about those angles reciprocally proportional, are equal to one another.

Let the triangles be placed so that their sides, CA, AD may be in one straight line; then it may be proved, as in last proposition, that EA, AB are in one straight line. It is to be proved that $CA : AD :: EA : AB$.

Draw BD . Then because the triangles ABC, ADE are equal,
 \therefore triangle $ABC : \text{triangle } ABD :: \text{triangle } ADE : \text{triangle } ABD$;
 * 1 VI. but triangle $ABC : \text{triangle } ABD :: CA : AD, *$
 and triangle $ADE : \text{triangle } ABD :: EA : AB$, conse-
 + 2 V. quently $CA : AD :: EA : AB; \therefore$ the sides of the
equal triangles ABC, ADE , about the equal angles are reciprocally proportional.

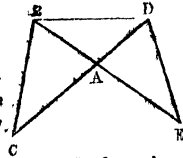

Next, let the sides of the triangles ABC, ADE , about the equal angles be reciprocally proportional, namely $CA : AD :: EA : AB$; then is triangle $ABC = \text{triangle } ADE$.

Draw BD as before. Then, because $CA : AD :: EA : AB$, and $CA : AD :: \text{triangle } ABC : \text{triangle } ABD, *$ and $EA : AB :: \text{triangle } ADE : \text{triangle } ABD$
 + 2 V. $\therefore \text{triangle } ABC : \text{triangle } ABD :: \text{triangle } ADE : \text{triangle } ABD; \dagger$

* 9 V. Cor. and the consequents being equal, the antecedents are equal, \therefore triangle $ABC = \text{triangle } ADE; \therefore$ equal triangles, &c. Q. E. D.

PROPOSITION XVI.—THEOREM.

If four straight lines (AB, CD, E, F) are proportionals, the rectangle contained by the extremes (AB, F) is equal to that contained by the means (CD, E) : and if the rectangle contained by the extremes is equal to that contained by the means, the four straight lines are proportionals.

* 11 I. From A, C draw AG, CH, perpendiculars to AB, CD; * make AG = F,
+ 31 I. and CH = E, and complete the parallelograms BG, DH.† It is to be proved that these rectangles are equal.

Because AB : CD :: CH : AG, ∴ the sides of the parallelograms about the equal angles A, C, are reciprocally proportional; they are therefore

* 14 VI. equal to one another; * and BG is the rectangle contained by AB, F, and DH the rectangle contained by CD, E; ∴ AB·F = CD·E. And if AB·F = CD·E, then shall AB : CD :: E : F. The same construction being made, the rectangle BG = DH; and as they are equiangular also,

+ 14 VI. ∴ AB : CD :: CH : AG; † that is AB : C D :: E : F; ∴ if four straight lines, &c. Q. E. D.

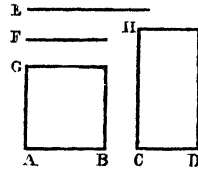

NOTE.—The next proposition is merely a corollary to this : it is that particular case of it in which the means are equal.

PROPOSITION XVII.—THEOREM.

If three straight lines be proportionals, the rectangles contained by the extremes is equal to the square of the mean; and if the rectangle contained by the extremes is equal to the square of the mean, the three straight lines are proportionals.

COR.—The first of the three proportionals (A, B, C) is to the third, as the square of the first to the square of the second.

* 1 VI. For * A : C :: rectangle A·A : rectangle A·C; but A·C = B², ∴ A : C :: A² : B².

PROPOSITION XVIII.—PROBLEM.

Upon a given straight line (AB) to describe a rectilinear figure similar, and similarly situated, to a given rectilinear figure.

First, let the given rectilinear figure, C D E F have four sides : it is required to describe on A B a figure similar, and similarly situated to C D E F.

Draw D F; and at the points A, B, in AB, make the angle A = C, and A B G = + 32 I. C D F; then A G B = C F D; † ∴ the triangles F C D, G A B, are equiangular. At the points G, B in G B, make the angle B G H = D F E, and G B H = * 32 I. F D E; then G H B = F E D; * ∴ the triangles F D E, G B H are equiangular.

Because the angle A G B = C F D, and B G H = D F E; ∴ A G H = C F E. For like reasons A B H = C D E, ∴ since A = C, and G H B = F E D, the figures A B H G, C D E F, are equiangular. Moreover these

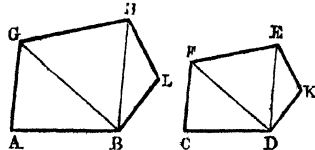

figures have their sides about the equal angles proportionals; for G A B, F C D, being

oquiangular triangles, $\therefore BA : AG :: DC : CF$; and $AG : GB :: CF : FD$;† also by reason of the equiangular triangles BGH, DFE, GBG : $GH :: FD : FE$; $\therefore AG : GH :: CF : FE$. In like manner it may be proved that $AB : BH :: CD : DE$, and $GH : HB :: FE : ED$; \therefore the equiangular figures $ABHG, CDEF$ have their sides about the equal angles proportionals, \therefore they are * Def. 1 VI. similar.*

Next, let the given rectilinear figure $CDKEF$ have five sides. Draw DE ; and upon AB describe the figure $ABHG$, similar and similarly situated, to the quadrilateral $CDEF$, by the former case: and at the points B, H , in BH , make the angle * 32 L. $HBL = EDK$, and $BHL = DEK$, then $L = K$.*

Because the figures $ABHG, CDEF$ are similar, the angle $GHB = FED$; and BHL was made $= DEK$; $\therefore GHL = FEK$. For like reasons $ABL = CDK$; \therefore the figures $ABHG, CDKEF$, are equiangular. And because the figures $ABHG, CDEF$ are similar, $\therefore GH : HB :: FE : ED$; but $HB : HL :: ED : EK$, $\therefore GH : HL :: FE : EK$. For like reasons $AB : BL :: CD : DK$, and $BL : LH :: DK : KE$; \therefore the equiangular figures $ABHG, CDKEF$ have their sides about the equal angles proportionals, \therefore they are similar. And in like manner may a rectilinear figure of six sides, similar to a given one, be described upon AB ; and so on. Which was to be done.

PROPOSITION XIX.—THEOREM.

Similar triangles (ABC, DEF) are to one another as the squares of their homologous sides.

The triangles being similar, having the angle $B = E$, and the side BC homologous * Def. 9 V. to EF ,* that is such that $AB : BC :: DE : EF$, it is to be proved that $\text{tri} ABC : \text{tri} DEF :: BC^2 : EF^2$.

† 11 VI. Take BG , a third proportional to BC, EF ;† so that $BC : EF :: EF : BG$; and draw GA .

* 11 V. Then because $AB : BC :: DE : EF$, alternately,* $AB : DE :: BC : EF$, but $BC : EF :: EF : BG$ (Const.), $\therefore AB : DE :: EF : BG$;† but triangles which have the sides about two equal

* 15 VI. angles reciprocally proportional are equal,*

$\therefore ABG = DEF$. And because $BC : EF :: EF : BG$:

† 17 VI. Cor. $BC : BG :: BC^2 : EF^2$;† but $BC :$

* 1 VI. $BG :: \text{triangle } ABC : \text{triangle } ABG$;

$\therefore \text{triangle } ABC : \text{triangle } ABG :: BC^2 : EF^2$, but

$ABG = DEF$, $\therefore \text{triangle } ABC : \text{triangle } DEF ::$

$BC^2 : EF^2$; \therefore similar triangles, &c. Q. E. D.

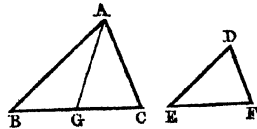

Cor.—If three straight lines be proportionals, then as the first is to the third, so is any triangle upon the first to a similar and similarly situated triangle upon the second.

PROPOSITION XX.—THEOREM.

Similar polygons may be divided into the same number of similar triangles, which are to one another as the polygons themselves: and the polygons are to one another as the squares of their homologous sides.

Let $ABCDE, FGHL$ be similar polygons, and let AB be the side homologous to FG .

From E, L draw the diagonals. Because the polygons are similar, the angle $\angle BAE = \angle GFL$, and $BA : AE :: GF : FL$; \therefore the triangles $\triangle ABE, \triangle FGL$ have an angle in one equal to an angle in the other, and the sides about those equal angles proportionals, \therefore

* 6 & 4. VI. the triangles are equiangular and similar, * \therefore the angle $\angle ABE = \angle FGL$; but since the polygons are similar, the whole angle $\angle ABC =$ the whole angle $\angle FGH$, \therefore the remaining angle $\angle ECB = \angle LGH$. Also $EB : BA :: LG : GF$, and from the similar polygons, $AB : BC :: FG : GH$; $\therefore EB : BC ::$

† 17 V. Cor. $LG : GH$, † that is the sides about the equal angles $\angle ECB, \angle LGH$ are proportionals; \therefore the triangles $\triangle ECB, \triangle LGH$ are similar;

* 6 VI. lar.* For like reasons the triangles $\triangle BCD, \triangle LHK$ are similar, \therefore the polygons are divided into the same number of similar triangles. It is now to be proved that these triangles are, each to each, as the polygons themselves, and that these are to each other as the squares of their like sides.

Because the triangles $\triangle ABE, \triangle FGL$ are similar, as also $\triangle BEC, \triangle GLH$, \therefore

* 19 VI. triangle $\triangle ABE$: triangle $\triangle FGL :: BE^2 : GL^2$ * } $\therefore ABE : FGL :: BEC :$
 † 2 V. triangle $\triangle BEC$: triangle $\triangle GLH :: BE^2 : GL^2$ } GLH . †

In like manner, because the similar triangles $\triangle BEC, \triangle GLH$, as also the similar triangles $\triangle ECD, \triangle LHK$, are as EC^2 to LH^2 . $\therefore BEC : GLH :: ECD : LHK$, $\therefore ABE : FGL ::$

† 10 V. $BEC : GLH :: ECD : LHK$. Consequently, * $ABE : FGL ::$ polygon

† 19 VI. $ABCDE$: polygon $FGHKL$; but $ABE : FGL :: AB^2 : FG^2$, † \therefore (2 V.) the polygons are to one another as the squares of their homologous sides AB, FG ; similar polygons, &c. Q. E. D.

COR. It follows from this and the corollary to Prop. xix., that if three straight lines be proportionals, the first is to the third as any rectilinear figure upon the first to a similar, and similarly described figure upon the second.

PROPOSITION XXI.—THEOREM.

Rectilinear figures (A, B) which are similar to the same rectilinear figure (C) are also similar to one another.

Because A is similar to C, they are equiangular, and have also their sides about the * Def. 1 VI. equal angles proportionals.*

Again, because B is similar to C, they also are equiangular, and have their sides about the equal angles proportionals, \therefore A, B are each of them equiangular to C, and have their sides about the equal angles of each of them and of C proportionals; \therefore A, C are equiangular, and have their sides about the equal angles propor-

† 2 V. tionals; † \therefore A, B are similar figures; * \therefore rectilinear figures, &c. Q. E. D.

PROPOSITION XXII.—THEOREM.

If four straight lines (AB, CD, EF, GH) are proportionals, the similar rectilinear figures, similarly described upon them, are also proportionals: and if the similar and similarly described rectilinear figures upon four straight lines are proportionals, the straight lines themselves also are proportionals.

Draw AK, CL , making any equal angles with AB, CD ; make also $AK = EF$, and $CL = GH$; draw KB, LD .

By hypothesis and construction $AB : AK :: CD : CL$; and the angles $\angle A, \angle C$ are

* 6 VI. equal; \therefore $\triangle KAB, \triangle LCD$ are equiangular; * \therefore

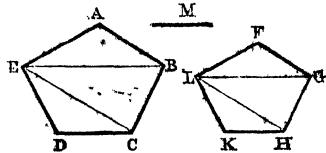

129 XL. $AB^2 : CD^2 :: \text{triangle } KAB : \text{triangle } LCD \dagger \} \therefore AB^2 : CD^2 :: AK^2 : CL^2$
 130 V. $AK^2 : CL^2 :: \text{triangle } KAB : \text{triangle } LCD \} \quad CL^2$ *

But a polygon on AB : similar polygon on CD :: $AB^2 : CD^2$; and polygon on AK : similar polygon on CL :: $AK^2 : CL^2$; \therefore polygon on AB : sim. polygon on CD :: polygon on EF : sim. polygon on GH.

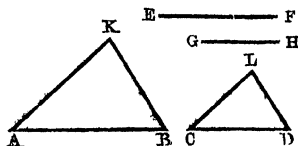

Again, let the last proportion have place, then $AB : CD :: EF : GH$.

Make equal angles at A and C, as before, as also $AK = EF$; and as AB is to CD, \dagger 12 VI. so make AK to CL; \dagger then the triangles KAB, LCD are equian-
 131 VI. gular;* and \therefore , as proved above, $AB^2 : CD^2 :: AK^2 : CL^2$; but $AK = EF$, $\therefore AB^2 : CD^2 :: EF^2 : CL^2$. But by hyp., the polygons on AB, CD, EF, GH are proportionals, and therefore, since similar polygons are as the squares of their like
 132 VI. sides $\dagger AB^2 : CD^2 :: EF^2 : GH^2$; $\therefore CL = GH$.* But by construction,
 133 V. Cor. 2. the four lines AB, CD, AK, CL, are proportionals; \therefore the four lines AB, CD, EF, GH are proportionals; \therefore if four straight lines, &c. Q. E. D.

PROPOSITION XXIII.—THEOREM.

Equiangular parallelograms (AC, DF) are to each other as the rectangles of their containing sides (AB·BC and DE·EF).

Draw AG, DH, perpendiculars to BC, EF. Then because parallelograms on the same base and between the same parallels are equal, $AC = AG \cdot BC$, and $DF = DH \cdot EF$.

Also the rectangles AG·BC, AB·BC having the same altitude BC, are to each other as their bases, AG, AB. In like manner, the rectangles DH·EF, DE·EF are to each other as their

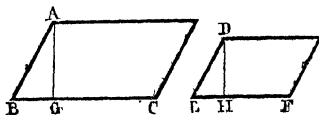

* 1 VI. bases DH, DE.* But the triangles ABG, DEH having the angles at B and G respectively equal to those at E and H, are equiangular; $\therefore AG : AB ::$

+ 4 VI. $DH : DE \dagger \therefore AG \cdot BC : AB \cdot BC :: DH \cdot EF : DE \cdot EF$, and alternately*

* 11 V. $AG \cdot BC : DH \cdot EF :: AB \cdot BC : DE \cdot EF$; that is, the parallelograms AC, DF are to each other as the rectangles AB·BC, DE·EF of their containing sides; \therefore equiangular parallelograms, &c. Q. E. D.

PROPOSITION XXIV.—THEOREM.

Parallelograms (EG, HK) about the diagonal (AC) of a parallelogram (DB) are similar to the whole, and to one another.

+ 29 I. Because DC, GF are parallels, the angle $ADC = AGF$; \dagger and because BC, EF are parallels, $ABC = AEF$; and each of the angles BCD, EFG is equal to the opposite angle DAB; $\therefore BCD = EFG$; \therefore the parallelograms BD, EG are equiangular. And because the angle $ABC = AEF$, and that BAC is common to the two triangles BAC, EAF, \therefore they are equiangular; $\therefore AB : BC ::$

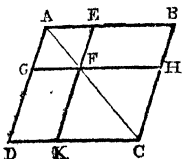

* 4 VI. $AE : EF$; * that is, the opposite sides of parallelograms being equal, $AB : AD :: AE : AG$; \therefore the sides of the $DC : CB :: GF : FE$ } equiangular paral-
 $CD : DA :: FG : GA$ } lelograms BD, EG, about the equal angles,

are proportionals: the parallelograms are therefore similar. For like reasons, the parallelograms BD, HK are similar; \therefore each of the parallelograms EG, HK is similar to
 * 21 VI. BD: they are therefore similar to each other; * \therefore parallelograms, &c. Q. E. D.

PROPOSITION XXV.—PROBLEM.

To describe a rectilinear figure which shall be similar to one (P) and equal to another given rectilinear figure (D).

+ 43 I. Cor. Upon BC, a side of the given figure, describe the parallelogram $BE = P$; † and upon CE describe the parallelogram $CM = D$, and having the angle $FCE = CBL$; then $LBC + ECB =$ two right angles, $\therefore FCE + ECB =$ two right angles, $\therefore BC, CF$ are in a straight
 * 14 I. line; * so also for like reasons are LE, EM . Between BC, CF find a mean
 + 13 VI. proportional GH ; † and upon it describe the rectilinear figure Q , similar and
 * 18 VI. similarly situated to the figure P , * Q shall be the figure required.

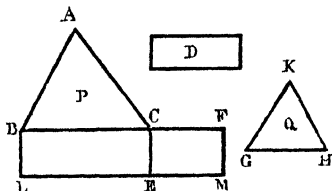

20 VI Cor. Because $BC : GH :: GH : CF$, $\therefore BC : CF :: P : Q$; † but $BC \cdot CF \therefore BE : EF$; $\therefore P \cdot Q :: BE \cdot EF$; and $P = BE$, $\therefore Q = EF$; but $EF = D$, $\therefore Q = D$, and it is similar to P : which was to be done.

PROPOSITION XXVI.—THEOREM.

If two similar parallelograms (BD, EG) have a common angle (at A) and be similarly situated, they are about the same diagonal.

For if not, let, if possible, the parallelogram BD have its diagonal AHC in a different straight line from AF, the diagonal of EG; and let GF, or GF prolonged, meet AHC in H, and draw HK parallel to DA, or CB. Then BD, KG being about the same diagonal are similar,

* Hyp. $\therefore DA : AB :: GA : AK$; but BD, EG are similar; * $\therefore DA : AB :: GA : AE$; $\therefore GA : AE :: GA : AK$; $\therefore AK = AE$, which is impossible; \therefore BD, KG are not about the same diagonal, that is the diagonal of BD cannot be in a different straight line from that of EG, \therefore the parallelograms are about the same diagonal; \therefore if two similar parallelograms, &c. Q. E. D.

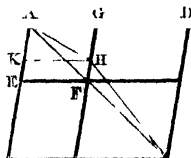

PROPOSITION XXVII.—THEOREM.

Of all the rectangles contained by the segments of a given straight line, the greatest is the rectangle of the two EQUAL parts of the line; that is, the square of half the line.

This is an obvious corollary from Proposition V., Book II., as already noticed at page 93. The corresponding Proposition of Euclid is long and complicated, and Propositions XXVIII., XXIX., are still more so. Playfair, in his edition of the Elements, has therefore replaced these three Propositions by others of a simpler character; and his example is followed here; but the demonstrations of the next two Propositions will be found still simpler than those of Playfair.

PROPOSITION

To divide a given straight line (AB), so that the rectangle contained by its segments may be equal to a given square (C^2), not greater than the square of half the line.

* 10 I. Bisect AB in D; * then must AD be either = C, or $>$ C. If AD = C, the thing required is done; but if AD $>$ C, draw DF perpendicular to

† 11 I. AB, † and make DE = C, as also DF = AD. With centre D and radius DF describe a circle; † the circumference must pass through the points A, B, because DA, DF, DB are (by Const.) equal. Draw EP, parallel to AB, meeting the circumference in P; and draw PG parallel to ED; then G will be the point of division required.

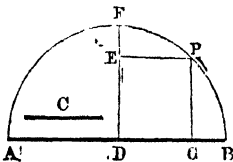

* 34 I. For (Const.) EG is a rectangle, \therefore PG = ED; * but ED = C (Const.)
 † 13 VI. \therefore PG = C: but AG·GB = PG², † \therefore AG·GB = C², \therefore AB is divided in G, so that AG·GB = C²; which was to be done.

PROPOSITION XXIX.—PROBLEM.

To prolong a given straight line (AB), so that the rectangle contained by the segments between the extremities of the given line, and the point to which it is prolonged, may be equal to a given square (C^2).

Bisect AB in D, draw BE perpendicular to it, and make BE = C; draw DE, and with centre D and radius DE, describe a circle meeting AB prolonged in G, F; then will AG·GB = C². Because D is the centre of the circle FEG, DF = DG; and (Const.) DA = DB, \therefore AF = BG. To each of these add AB, then

* 13 VI. FB = AG. But FB·BG = BE², * \therefore AG·GB = BE² = C², \therefore AB is prolonged to G, so that AG·GB = C²; which was to be done.

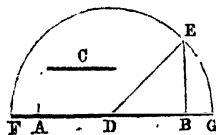

PROPOSITION XXX.—PROBLEM.

To cut a given straight line (AB) in extreme and mean ratio.

Divide AB in C, so that the rectangle AB·BC may be equal

† 11 II. to AC²; † then because AB·BC = AC², \therefore

* 17 VI. AB : AC :: AC : BC; * \therefore AB is cut in

† Def. 3, VI. extreme and mean ratio; † which was to be done.

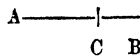

NOTE.—An example is here furnished of the way in which pairs of incommensurable lines may be found at pleasure. It was proved (Prop. XXIII., Book V.), that if two lines AB, AC, are such that AB : AC :: AC : BC (= AB - AC), then AB, AC, are incommensurable. It would be impossible, therefore, to express the two lines AB, AC, accurately by numbers; and it is thus that a theory of proportion, sufficiently comprehensive for the demands of geometry, could never be rigorously established by aid of numbers only: the bases of the proposed triangles in Proposition I. of this book, might, for aught we know to the contrary, be related as the lines AB, AC above; and therefore could not be numerically expressed.

PROPOSITION XXXI.—THEOREM.

In a right angled triangle (ABC) the rectilinear figure described upon the side (BC) opposite to the right angle, is equal to the similar and similarly situated figures described upon the sides (AB, AC) containing the right angle.

* 20 VI. For figure on AB : figure on AC :: $AB^2 : AC^2$; * therefore fig. on AB + fig.
 + 13 V. on AC : fig. on AC :: $AB^2 + AC^2 : AC^2$; †
 that is, fig. on AB + fig. on AC : fig. on AC ::
 $BC^2 : AC^2$. But fig. on BC : fig. on AC ::
 * 2 V. $BC^2 : AC^2$; consequently, * fig. on
 AB + fig. on AC : fig. on AC :: fig. on BC : fig. on
 AC, ∴ the consequents being equal, the ante-
 † 9 V. Cor. cedents are equal, † ∴ fig. on AB +
 fig. on AC = fig. on BC; ∴ in a right angle triangle,
 &c. Q. E. D.

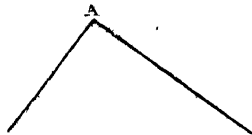

PROPOSITION XXXII.—T

If two triangles (ABC, DCE) which have two sides (BA, AC) of the one proportional to two sides (CD, DE) of the other be joined at an angle, so as to have their homologous sides (AB, DC, and AC, DE) parallel to one another, the remaining sides (BC, CE) shall be in a straight line.

Because AB is parallel to DC, and AC meets them, the angle $BAC = ACD$; for a

similar reason $CDE = ACD$; ∴ $BAC = CDE$. And because the triangles ABC, DCE have an angle $A = D$, and the sides about those angles proportionals, namely, $BA : AC :: CD :$

* Hyp. DE, * the triangles ABC, DCE, are equian-

+ 6 VI. gular; † ∴ angle $ABC = DCE$; and it was proved that $BAC = ACD$, ∴ $ACE = ABC + BAC$. Add ACB to each, ∴ $ACE + ACB = ABC + BAC + ACB =$ two right angles; that is, at the point C, in AC, the two straight lines CB, CE, on opposite sides of it, make the adjacent angles ACE, ACB, together equal to two right angles; ∴ CB, CE are in a straight line; ∴ if two triangles, &c. Q. E. D.

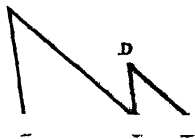

PROPOSITION XXXIII.—THEOREM.

In equal circles (ABL, DEN), angles (BGC, EHF) at the centres or (BAC, EDF) at the circumferences are to one another as the arcs (BC, EF) upon which they stand; and so also are the sectors (BGC, EHF).

NOTE.—In the following demonstration, by “the angle BGL” must be understood “the sum of the angles BGC, CGK, &c.,” and by “the angle EHN,” “the sum of the angles EHF, FHM, &c.”

Take any number of arcs, CK, KL, each equal to BC; and any number FM, MN, each equal to EF; and draw GK, GL; HM, HN; then the angles at G are all

* 27 III. equal, * ∴ whatever multiple BL is of BC, the same multiple is the angle BGL of BGC. For a similar reason, whatever multiple EN is of EF, the same multiple is the angle EHN of EHF; also if $BL = EN$, then $BGL = EHN$; if $BL > EN$, then $BGL > EHN$; and if $BL < EN$, then $BGL < EHN$. Consequently (Def. V. p. 136) $BC : EF :: BGC : EHF$; and since the angles A, D, are the halves of BGC, EHF, each of each,

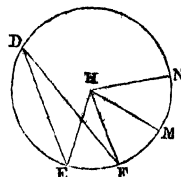
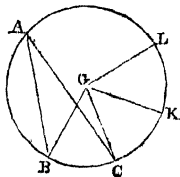

∴ $BC : EF :: A : D$; ∴ the angles are as the arcs on which they stand.

Again, the sectors BGC, CGK, EGL are equal; for it is manifest that, if applied to one another, they would coincide; in like manner the sectors EHF, FHM, HFF, are also equal; consequently, if in the preceding demonstration "sectors" are substituted for "angles," the conclusion will be that $BC : EF :: \text{sector BGC} \cdot \text{sector HFF}$.
 \therefore in equal circles, &c. Q. E. D.

I shall conclude this treatise with two supplementary propositions of interest.

1. The diagonal and side of a square are incommensurable.

Let B D be a square: the diagonal A C is incommensurable with its side A B:

With C as centre and C B as radius, describe the semicircle F B E: then A B C being a right angle, A B touches the circle (16 III.); \therefore (36 III.) $A E \cdot A F = A B^2$ \therefore (17 VI.) $A E : A B :: A B : A F$; \therefore (23 V.) the lines A E, A B are incommensurable, \therefore A C, A B, are also incommensurable for if these had a common measure, that measure would likewise measure A C \div A B, that is A E; so that A B, A E would have a common measure, which is shown to be impossible: \therefore the diagonal and side of a square are incommensurable.

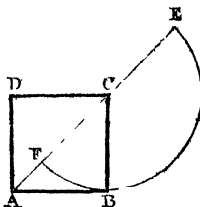

2. The surface of a regular inscribed polygon, and that of a similar circumscribed polygon being given, to find the surfaces of regular inscribed and circumscribed polygons of double the number of sides.

Let ab be a side of an inscribed polygon: the touching lines aA, bC will each be half a side of the similar circumscribed polygon, as is evident from what has been shown in reference to the inscribed and circumscribed pentagon in Propositions XI. and XII. of Book IV., and from what is said at the close of Prop. XVI. Let the surfaces of these two polygons be given. The chords aM, bM , drawn to the middle of the arc aMb , will be sides of an inscribed polygon of double the number of sides, and the touching line, BMC , will be a side of a similar circumscribing polygon, as is evident.

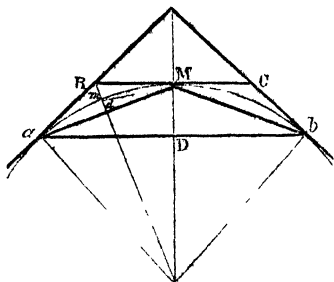

For brevity, let the surface of the inscribed polygon, whose side is ab , be represented by p , and that of the corresponding circumscribed polygon by P ; also let the inscribed and circumscribed polygons of double the number of sides: be denoted by p' and P' .

It is evident that the space OaD is the same part of p , that OaA is of P ,—that OaM is of p' ,—and that $OaBM$ is of P' ; for each of these spaces must be repeated exactly the same number of times to complete the polygon to which it belongs: consequently, since magnitudes are as their like multiples or submultiples, whatever proportions exist among these spaces, must also exist among the polygons of which they are
 Now the right angled triangles ODa, OaA , are similar, $\therefore OD : Oa :: Oa : OA$; that is, $OD : OM :: OM : OA$; and since triangles of the same altitude are to one another as their bases, and that the altitude aD is the same for the triangles ODa, OMa, OaA , it follows, from the proportion just deduced, that $ODa : OMa : OMa : OaA$; that is, the

numerical measure of the surface of the triangle OMa is a mean proportional between the measures of ODa , Oa ; consequently the surface of the polygon p' is a mean proportional between the surfaces of p and P .

Again, the right angled triangles ODa , BMA , are also similar, $\therefore OD : Oa :: BM : BA$; that is, $OD : OM :: aB : BA$; consequently, since the altitude aD is the same for the triangles ODa , OMa , and the altitude Oa , the same for the triangles OaB , OBA , and that triangles of the same altitude are to each other as their bases, it follows that $ODa : OMa :: OaB : OBA$; $\therefore (13 \text{ and } 6 \text{ V.}) ODa + OMa :: 2ODa :: OaB + OBA : 2OaB$;
 $\therefore p + p' : 2p :: P : P'$

The two conclusions now obtained are sufficient to enable us to compute the surfaces of inscribed and circumscribed regular polygons of 8, 16, 32, &c. sides, from having the surfaces of the inscribed and circumscribed squares already given. Thus, let the radius of the circle be numerically represented by 1, then if the given inscribed and circumscribed polygons (p , P) be squares, the side of the former will be $\sqrt{2}$, and that of the latter 2; and their surfaces will be 2 and 4 respectively; and, from what is proved above, the surface of the regular eight-sided inscribed polygon (p') will be a mean between the two squares p , P , $\therefore p' = \sqrt{8} = 2.8284271$. Again, for the surface of the eight-sided circumscribed polygon (P') the proportion $p + p' : 2p :: P : P'$, gives

$$P' = \frac{2p \cdot P}{p + p'} = \frac{16}{2 + \sqrt{8}} = \frac{16}{4.8284271} = 3.3137085$$

And from these numerical expressions for the surfaces of inscribed and circumscribed polygons of eight sides, we may evidently, by repeating the operation, and substituting the values just obtained for p and P , deduce the

numerical expressions for the surfaces of the No. of sides. Surf. of ins. pol. Surf. of circ. pol.
 sixteen-sided polygons, and so on to any
 extent: the results are as in the annexed
 table, which was in part given at page 127.

No. of sides.	Surf. of ins. pol.	Surf. of circ. pol.
4	2.0000000	4.0000000
8	2.8284271	3.3137085
16	3.0614674	3.1825979
32	3.1214451	3.1517249
64	3.1365485	3.1441184
128	3.1403311	3.1422236
256	3.1412772	3.1417504
512	3.1415138	3.1416321
1024	3.1415729	3.1416025
2048	3.1415877	3.1415951
4096	3.1415914	3.1415933
8192	3.1415923	3.1415928
16384	3.1415925	3.1415927
32768	3.1415926	3.1415926

From these numerical values for the surfaces of the inscribed and circumscribed polygons, it appears that when the number of the sides is so great as 32768, the two polygons differ so little from one another, that their numerical measures, as far as seven places of decimals, are absolutely the same. Now the circle, with which these polygons are connected, is manifestly *between the two*, as to amount of surface; being greater than the inscribed polygon, and less than the circumscribed one; consequently the surface of the circle must differ *less* from that of either polygon than the polygons differ from each other; and as the polygons themselves differ in numerical measure only, after the seventh decimal of the number 3.1415926, &c., it follows that this number, as far as the decimals extend, is the numerical expression for the surface of a circle whose radius is 1. By carrying on the foregoing process, the expression for the surface is found to be 3.141592653589793, &c. It will be proved hereafter that these decimals can never terminate.

ALGEBRA.

PRELIMINARY REMARKS.

ALTHOUGH in the present *elementary course of Mathematics* the Principles of Geometry have been placed before this treatise, yet there is no necessity to defer the study of Algebra till Geometry has been acquired. It would be advisable for a learner, after some acquaintance with a book or two of Euclid, to combine Geometry and Algebra together. The former subject, as it is independent of all previous knowledge of science, may be entered upon by any one who is familiar with ordinary language; he may be ignorant of even the multiplication table, and yet be able to master all the propositions in Euclid. But the study of Algebra requires a previous acquaintance with the principles of common Arithmetic; it is upon these principles that its operations are based, and the processes of Algebra are, for the most part, only the processes of Arithmetic, extended and rendered more comprehensive by the aid of a new set of symbols, taken in combination with the well-known symbols of Arithmetic. The symbols of Arithmetic are the *figures* of Arithmetic 1, 2, 3, &c.; and the new symbols introduced by Algebra are the letters of the alphabet, *a*, *b*, *c*, &c. As noticed at page 6, the peculiar marks or symbols employed in any science constitute the *notation* of that science; the notation of Algebra is therefore of a mixed character, consisting of the figures of Arithmetic and of the letters of the alphabet. The *letters* may be regarded as standing for *figures*, and the reason why figures alone will not enable us to do all that Algebra will, is that a *figure* always has a fixed and invariable signification: thus, a 3 or a 5, or a 7, conveys the same meaning to everybody—no one uses the mark or symbol 3 to denote anything but *three*. But a *letter*, as *a*, or *b*, may be used to denote *any figure whatever*: a 3, or a 4, or a 7, &c.; and it may therefore be made to stand even for a figure whose value may be unknown to us, and which value it may be the object of the inquiry to discover. This is one of the principal advantages of algebraical notation; that part of this notation, which is borrowed from Arithmetic, enables us to express the *known* figures in any mathematical investigation, by marks intelligible to all; while the other part, the letters, enables us to represent the figures or quantities, at the outset *unknown*, but which it is the object of the problem to determine.

But besides the marks or symbols of *quantity*—the figures and letters—other marks are introduced into the notation, as *signs of operation*. Some of these are used alike, both in Arithmetic and in Algebra—as the sign (+) for addition, the sign (−) for subtraction, and one or two others with which the reader of the Arithmetic must be already familiar. The signs of operation in most frequent request in Algebra we shall now explain, and shall give a few easy examples of their application before entering on the formal rules of the science. We wish the reader to understand, at the outset, that we are about to exhibit the first principles of Algebra to *mere beginners*, to persons who, as yet, know nothing at all of the subject. Some experience in elementary teaching has convinced us that, to succeed in an undertaking of this kind, the instructor must forego all self-importance, descend to the level of his pupil, and, as it were, sit familiarly down by his side, and address him in that simple and unadorned style that no intelligent schoolboy can fail to understand. We shall endeavour, therefore, to be very plain and simple in the language employed; and, the better to gain the learner's confidence and attention, shall, as in the Arithmetic, always give whatever explanations we have to offer in the first person.

DEFINITIONS AND EXPLANATIONS OF FIRST PRINCIPLES.

You already know, from arithmetic, that *numbers* are of two kinds:—*abstract numbers*, and *concrete numbers*. An abstract number is simply a *figure*, or number formed by two or more figures: thus, 3, 23, 147, &c., are abstract numbers; but 3 *oz.*, 23 *ft.*, £147, are *concrete numbers*. Abstract numbers merely denote how many *times* or *repetitions*; and accordingly whenever you use a *multiplier*, you use an abstract number. Concrete numbers denote how many *things*; and some mark or symbol, to tell us *what* the things are, must always be joined to the figure or figures which tell us the *number* of them. The mark or symbol *oz.*, as you know, means *ounces*; the symbol *ft.*, *feet*; and £ stands for *pounds*, in money. In algebra, *letters* are used to stand for numbers, whether they be abstract or concrete. Instead of writing down the abstract number, 23, a letter, *a*, for instance, may be put to represent 23; in like manner, instead of writing down the concrete number 23 *ft.*, a single letter may be made to stand for it. You see, therefore, that a *letter* serves for a number of *either* kind, while a *figure* must have a particular symbol joined to it when a *concrete* quantity is to be represented.

It is the business of a teacher of algebra to show how the operations carried on in arithmetic, by the help of figures *alone*, may be conducted with figures and letters *both*. The letters, as just noticed, representing numbers, whether abstract or concrete, are called *symbols of quantity*; and the marks or signs which *indicate* operations performed with the letters, are called *signs of operation*. I am now to explain to you some of these signs of operation: most of them, however, have been used in the Arithmetic.

The mark $+$ is the *sign of addition*: whenever you see it put before a number or letter, you are to understand that the *addition* of whatever that number or letter signifies is meant: thus, $7 + 3$, which is read *7 plus 3*, denotes that the 3 is to be *added* to the 7; in like manner, $a + b$, that is, *a plus b*, signifies that the *b* is to be added to the *a*: but you will ask—how can a *b* be added to an *a*? My reply to this is that *a* and *b* both stand for *numbers*, abstract or concrete; and although I say, according to custom, that “*b* is to be added to *a*,” what I really mean is that the *number* represented by *b* is to be added to the *number* represented by *a*. In the case of $7 + 3$, that is, of $7 + 3$, I can obey the direction of the sign of operation, and I know that 10 is the result; but in the case of $a + b$, I cannot obey the direction of the sign till I know the interpretation of *a* and *b*: I can only *indicate* the addition—I cannot *perform* it.

The sign $-$ is the sign of subtraction: whenever it is placed before a quantity, it indicates that that quantity is to be *subtracted*: thus, $7 - 3$, which is read *7 minus 3*, means that 3 is to be subtracted from 7; and, in like manner, $a - b$ means that *b* is to be subtracted from *a*. In the case of $7 - 3$, the result of the subtraction is 4; the result of $a - b$ cannot be given so long as the numbers, represented by *a* and *b*, remain concealed or unknown.

The sign \times placed between two quantities denotes the *multiplication* of those quantities together: it is called *the sign of multiplication*; thus, 7×3 means that 7 and 3 are to be multiplied together; and, in like manner, $a \times b$ means the *product* of *a* and *b*. In the case of 7×3 , the result or product is 21; in the case of $a \times b$, the result remains unknown till the number represented by the multiplier is stated. Every multiplier, as you are aware, must be an abstract number; if *a* stand for the abstract number 5, then $a \times b$ is $5 \times b$; that is, *5 times b*, whatever *b* may stand for. The sign just explained is *not always* used to indicate multiplication; instead of it a *dot*, placed between the two quantities, is often employed to mean the same operation:

thus, 7.3 and $a.b$ mean the same as 7×3 and $a \times b$; and, in the case of letters, even this sign is usually omitted, and the letters simply written side by side, without any intervening mark for multiplication at all; thus ab , $a.b$, and $a \times b$, all equally mean the product of a and b . When figures are to be multiplied, some sign for multiplication must be put between them, to prevent misunderstanding; if, when we meant 7×3 , or 7.3 , we put merely 73 , we should be thought to mean *seventy-three*, instead of *twenty-one*.

The sign \div , placed before a quantity, denotes *division by that quantity*: it is called the *sign of division*; thus, $12 \div 4$ means 12 divided by four, and $a \div b$ means a divided by b . Division is otherwise indicated by writing the dividend above, and the divisor below a short line, as in the notation for a fraction: thus, $12 \div 4$ and $\frac{12}{4}$ mean the same thing; as also do $a \div b$ and $\frac{a}{b}$. As in the former instances, so here, the operation can be only *indicated*, not actually *performed*, except in the case of numbers.

The sign $=$ stands for the words *equal to*; it is called the *sign of equality*: thus, $5 + 2 = 7$ is a brief way of saying that 5 plus 2 are equal to 7; and $5 - 2 = 3$ states, in like manner, that 5 minus 2 is equal to 3. Also $4x + 2x = 6x$, states that four times x plus twice x are equal to six times x ; and $4x - 2x = 2x$, expresses, in symbols, that four times x minus twice x is equal to twice x .

A figure, or number, prefixed to a letter, as a *multiplier*, is called the *coefficient* of that letter; thus, 4 is the coefficient of x in the quantity $4x$; and 6 is the coefficient of x in $6x$. In like manner, 8 is the coefficient of xy in the quantity $8xy$, and 23 is the coefficient of xyz in the quantity $23xyz$.

Every quantity which, like each of those just noticed, is *not separated into parts* by any plus or minus sign, is called a *simple quantity*, or a *simple expression*—or it is said to consist of but a single *term*. But when a quantity is made up of parts, linked together by plus or minus signs, the quantity is called a *compound quantity*, or a *compound expression*. The following are simple expressions: they each consist of but one term.

$$4ax, 7aby, 14xyz, \frac{2ab}{7}, \frac{3abx}{4y}, 37amnxz, \&c.$$

The following are compound expressions: the first consists of two terms, the second of three terms, and the third of four terms.

$$5a - 2b, 3ax + 5by - 4z, 16axy - \frac{4bcz}{3x} - 2dmx + 5en.$$

You thus see what in Algebra is meant by a *term* and an *expression*; the first row of quantities above is formed by six distinct *expressions*, each expression consisting of only one *term*: the second row is formed by three *expressions*, of which the first consists of two terms, the second of three terms, and the third of four terms. The first row is a row of *simple expressions*, the second a row of *compound expressions*.

I shall now give you a few easy exercises by which you may prove to yourself whether you fully understand the meaning of the signs already explained. You must not forget that whenever two or more quantities are placed side by side, without any sign of operation between them, the *multiplication* of those quantities, or rather of the *numbers* they represent, is always meant.

EXERCISES.

NOTE.—In these exercises $a = 4$, $b = 2$, $c = 3$, $d = 5$, $m = 8$, $n = 1$.

All that you have to do is to give these interpretations to the letters, thus translating the algebra into arithmetic, and then to put down the numerical value of each expression. In case I should be misunderstood, I will here show you how to deal with example 4; that is, with $21m - 9d$. As m is presumed to stand for 8, and d for 5, the translation of the expression is $21 \times 8 - 9 \times 5$; that is, $108 - 45 = 63$, which is the numerical value of the proposed expression, on the supposition that m and d stand for 8 and 5 respectively. And in a similar manner are all the other examples to be treated. Do not forget that when the multiplication of numbers is indicated, the multiplication sign must be interposed between them.

Find the values in numbers of the following expressions.—

- | | |
|---|--|
| <ol style="list-style-type: none"> 1. $3a + 4c$* 2. $5c - 2a$ 3. $13n + b$ 4. $21m - 9d$ 5. $7d + 4n - 2a$ 6. $3a + 4b - 5c$ 7. $6m - 5n - 3b$ 8. $14 - 3c + m$ 9. $11b + n - 13$ 10. $-4d + 5m - 2n$ | <ol style="list-style-type: none"> 11. $\frac{3m}{4} + 6 - \frac{m}{2}$ 12. $\frac{5a}{2} + \frac{4d}{5} - 2c$ 13. $\frac{2a + 3b}{7} + m - n$ 14. $\frac{3a - 4b + 6c - 2}{10}$ |
| <ol style="list-style-type: none"> 15. $3ab + dm - 5b + 6cn - 9 \times 2$ 16. $2abm - 3cdm + \frac{3dm}{8} + ad$ | <ol style="list-style-type: none"> 17. $\frac{5am - 2bc + n - 49}{140} - n$ 18. $\frac{24}{m} + \frac{5abc}{24} - \frac{60}{bcd} - \frac{m + n}{2b + d}$ |

The first ten of these exercises are free from fractions: the next four all contain algebraic fractions: the fourteenth is a single fraction; it is an algebraic expression consisting of but one term. The numerator of this expression is, however, a compound quantity, as it is made up of simple quantities, united together by the signs + and—. The leading term in each of the above expressions, with the exception of Exercise 10, has no sign prefixed to it. You must take notice that a term, without any prefixed sign, is always to be regarded as plus: the actual insertion of the +, before a leading term, is unnecessary; since, when it is minus, the sign — is always put before it. The plus quantities are all called positive quantities, and the minus quantities, negative quantities. There is another thing which you must also take note of. You know that the numerical multiplier prefixed to a letter, or to a group of letters, is called the coefficient of the letter or letters connected with it. Now, although no coefficient should appear before a letter, you are not to say that the coefficient is nothing, any more than you are to say, when the plus sign is absent, that the sign is nothing: the second term in Exercise 3, is + b , that is, plus once b , and the coefficient 1, although not actually written, is to be understood. If the question were asked, therefore, you should say that the coefficient of the b is 1: this 1 is omitted from before the b on the same principle that the + is omitted from before the 13; the insertion of either would add to the number of symbols, without adding any clearness to the meaning of the expression; for

* The Answers to all the Exercises and Questions in this Treatise will be found at the end of the purely algebraical portion of the volume.

$13n + b$ can never be mistaken for anything but $+13n + b$, that is *thirteen times n plus b*; or, as an algebraist would read it, *thirteen n plus b*; the word *times* being suppressed. Exercise 15 would be read thus: *three a, b; plus d, m; minus five b; plus six c, n; minus twice nine, or 9 times 2.*

I dare say, from your recollection of the terms employed in common arithmetic, that you know the meaning of the word *factor*: the numbers which, multiplied together, give a *product*, are called *factors* of that product: so here, in algebra, every *multiplier* is a *factor*: thus the factors of *bcxy* are *b, a, x, and y*: the factors of *beyz* are *b, e, y, and z*. A product, you know, is not altered by changing the order of its factors: the following different arrangements of the factors all imply the same product; *beyz, byez, cyzb, &c. &c.*; but it is usual, when *letters* are the factors, to write them one after another in the order in which they follow in the alphabet; so that the first of the above arrangements would be that generally adopted. In a similar way, since quantities connected together, some by the *additive* or *positive* sign, and others by the *subtractive* or *negative* sign, furnish the same *result*, in whatever order they succeed one another, the order fixed upon is mere matter of accident or choice: Exercise 10, above, is the same expression whether written

$$-4d + 5m - 2n, \text{ or } 5m - 4d - 2n, \text{ or } -2n - 4d + 5m;$$

but the *second* of these ways would be preferred simply because a *sign* is thus saved. The leading term there being *positive*, the leading sign $+$ is dispensed with.

I think, from the explanations that have now been given, and from the practice afforded to you by the exercises you have already worked, that you must perceive this fact—namely, that although the sign $+$ before an algebraic quantity is a direction for you to *add*, and the sign $-$ a direction to *subtract*, yet you cannot, in general, obey these directions till the algebra is converted into arithmetic, by a translation of the *letters* into *numbers*. But in many cases you can actually add and subtract, though you remain in utter ignorance as to the *meaning of the letters*; there is such a thing as addition of *algebra* as well as addition of common numbers; and subtraction of *algebra* as well as arithmetical subtraction. I am now going to introduce you to these operations; you will at once see how it happens that you can actually *perform* the operations indicated by $+$ and $-$, even upon quantities whose values are unknown, by my showing you a simple instance or two, as I shall now do, before proceeding to RULES. Suppose you have such an expression as $5ax + 3ax - 7ax + 2ax - ax$; you would surely not require to know what ax stands for, before you could *perform* the operations indicated by the signs; you would say to yourself—whatever thing ax may represent, 5 of them *plus* 3 of them must make 8 of those things: 8 of them *minus* 7 of them leaves *one*; this, with the two of them following, make 3 of them, which *diminished* by *one*, gives 2 of the things, whatever they be, as the amount of the whole row; you would thus be sure that the result is $2ax$; that is, you would state with confidence that

$$5ax + 3ax - 7ax + 2ax - ax = 2ax.$$

You have been able to reduce the *compound* expression on the left of the sign of equality to the *simple* expression on the right, solely because the several quantities in the compound expression are *like quantities*; that is, they differ in nothing except in *coefficient* and in *sign*; the *letters* are the same in all. It is only when the terms of a compound expression are *unlike quantities* that the operations indicated by $+$ and $-$ cannot be performed till the values of the letters are stated. You will no doubt be able of

7.	8.	9.
$8pqr + 3mx - n$	$4xyz - 2ab$	$- abz - 3x + a - 3$
$2pqr - 4mx + 2n$	$3xyz + 7ab - 6$	$- 2abz + x - 2a$
$- 3pqr - 2mx - 5n$	$- 2xyz - 3ab + 7$	$- 4abz - 7x + 2$
$- 6pqr - 5mx - 3n$	$5xyz - ab - 18$	$5abz - 18x + 4a$
$4pqr + 6mx + 4n$	$- 8xyz + 4ab + 9$	$11abz + 5a$
<hr/>		
10.	11.	12.
$9acx + 2bey - 4kg$	$8s + abc - 17mp$	$34ky - 3mz + 2bc$
$2acx - 7bey + 3kg$	$5abc + 4mp$	$- 16ky + 9mz - 8bc$
$- 4acx - 3bey - 2kg$	$7z - 2abc - 3mp$	$- 5xz - 5xz$
$acx + 8kg$	$5z + 9mp$	$4ky + 6mz - 3bc$
$7acx - 5bey$	$18abc - 2mp$	$- 5ky + 7abc$
$- 4bey - ky$	$- 4abc + mp$	$2ky - 11mz - abc$
<hr/>		

Add together the following quantities :—

13. $7abz - 3cey + 2mx, 3abz - 7mx, 4cey + mx, 9mx.$
14. $2gx + 6pqr - 13, 8pqr + 11, 7gx - 2, - 3gx - pqr, 17.$
15. $3axy, 7ab - c, 3axy + 2ab + 5c, - axy - 5ab - 2c.$
16. $5xyz - 2am + 3bn, 7am - 7bn, 6xyz - bn, 4am - 5bn.$
17. $6cx + 3ny, 7mz, - 8ny, 2bcx - ny, 5ny - 3mz, - 2mz.$
18. $9exz - 18, 7bcy + 4, 6exz - 4bcy + 1, 13bcy - 3, 4exz - bcy.$
19. $- 4mpy - 2ax + 3, - 5ax - 7, 3mpy - 2, mpy + 8ax + 6.$
20. $- cgx - 4, - 6ab + 2, 3cgy - ab - 5, 17, 4cgy + 7ab, - 13.$

CASE II.—When the quantities to be added are not all like quantities.

When rows of quantities are arranged one under another, so as to present a set of vertical columns, as in examples 1 to 12 above. if the vertical rows are not rows of like quantities, then you will have carefully to examine all the rows, and to pick out from among them the different sets of like quantities, and add them together as before; those quantities that have no like, must be merely connected with their signs to the sums thus found; for we cannot actually add or subtract when the quantities are unlike. The following is the rule.

RULE.—Add together the different sets of like quantities; and put down each separate result, exactly as in the last case; then, to the sum thus found, connect, by the signs belonging to them, the remaining unlike quantities.

Although it matters not in what order a row of algebraical terms is written, yet in addition, it is usual to commence with the quantity at the top of the left hand column and to select from among all the columns the several quantities like it; then passing to the quantity at the top of the next column to add together the quantities like it, and so on.

1.	2.
$3x - 7y + 2z$	$- 5ax + 2by - 7$
$4y + 6z - x$	$3by + 18 - 4z$
$- 3x - 2y + a$	$4ax - 9 - by$
$4x + 8z - y$	$2b + 3ax - 2by$
$6x - 6y + 8z + a$	$2ax + 2by + 2b - 4z$

$$\begin{array}{r}
 3. \\
 7xy - 4az + 2bc \\
 6az + 5mn - 3p \\
 2bc - 3xy + 8az \\
 -xy - bc - az \\
 -4az + 3xy - 4bc \\
 \hline
 6xy + 5az - bc + 5mn - 3p
 \end{array}$$

$$\begin{array}{r}
 4. \\
 -2yz - 3ab \\
 -5cx + 2yz + 5ab \\
 7ab - 3cx + yz \\
 4sk - 6yz - cx \\
 2cx + yz - 8 \\
 \hline
 -4yz + 9ab - 7cx + 4sk - 8
 \end{array}$$

EXAMPLES FOR EXERCISE.

$$\begin{array}{r}
 1. \\
 2ax + 3by + 4c \\
 5by + 8c - az \\
 7c + 4az - 2by \\
 3ez - 5ax + 12 \\
 \hline
 \hline
 \end{array}$$

$$\begin{array}{r}
 2. \\
 5xy - 8az + 7 \\
 6xy + 4bx - 3 \\
 4az - 2xy + c \\
 -19 + az - xy \\
 \hline
 \hline
 \end{array}$$

$$\begin{array}{r}
 3. \\
 9yz + 8ax - 3bc \\
 -2en - 4bc + 2yz \\
 xyz + 3ax - 4yz \\
 -2ax - yz + 3en \\
 \hline
 \hline
 \end{array}$$

$$\begin{array}{r}
 4. \\
 4ab - 3cd + 5ef \\
 -7e - 4ab \\
 6cd + ef - 6e \\
 2ef - 3cd + 14 \\
 3e + ab - cd \\
 \hline
 \hline
 \end{array}$$

$$\begin{array}{r}
 5. \\
 -7xy - 3bz + 4w \\
 -5bz + 4xy - 8cd \\
 2w - 6bz + 9xy \\
 -4xy + 3w - bz \\
 -16 + 5xy + w \\
 \hline
 \hline
 \end{array}$$

$$\begin{array}{r}
 6. \\
 2amz + 2nx - 3bv \\
 6cw - 8bv - amz \\
 5bv + 4amz + 6 \\
 -amz - 2bv - 7nx \\
 -8nx - 14 \\
 \hline
 \hline
 \end{array}$$

From comparing the examples in this second case of addition with those given in the first case, you will see that, although the placing of the several expressions to be added one under another was of considerable assistance *there*, because the *like* quantities all appeared in vertical rows, yet the arrangement is of no advantage *here*, since we have to pick out the *like* quantities after a careful search for them among the entire set of expressions. We could do this just as well if the expressions were all written side by side, as in the examples below, without taking the trouble of first arranging them one under another. If you think it easier, however, you may select first one set of like quantities out of the expressions in each of the following examples, and arrange them as in Case I.; then a second set, and so on. You may thus change this Case II. into Case I., taking care, however, that the *unlike* quantities be connected to the sum of the *like* quantities in the final result.

7. $2axy - 3bz + 4, 7bz - 6, 5 + 2bz - 3axy, 4bc - 3c + 2.$
8. $-6abc - 3de - 4f, 6f - 2abc + de, 4de - 8abc + 8, abc - f.$
9. $4\frac{1}{2}z + 2y - 7x + 9, 3x - \frac{1}{2}y + z, 8y - 5x + 2z, 2y - 3z.$
10. $8\frac{x}{y} + az - 5b, 6b - 4\frac{x}{y} - 8az, 2\frac{z}{x} - 3\frac{x}{y}, 4 - 7b.$
11. $-7xyz - 3\frac{z}{a} - 2bc, 5\frac{z}{a} - 4mn + p, 12bc + 8xyz, -xyz - 7\frac{z}{a}.$
12. $\frac{2}{3}ax - 5y + 7z - 8, -\frac{1}{2}y - 2z, 4z - 6ax + 2y, 3y - 9z + ax.$

SUBTRACTION.

Before giving you the rule for subtraction of algebra, I must explain to you the principle upon which the rule is founded, for whatever part of mathematics you study, you must never confide in a "Rule" till you are convinced of its correctness.

SUBTRACTION.

Now, let us take any two numbers at random, say 9 and 4; and let us endeavour to *subtract* the latter from the former, when the algebraic signs +, - are, the one or the other, prefixed to the 9 and the 4, and try to put down what we are certain must be the correct remainder. You know that to *subtract* means to *take away*; if, therefore, we can *actually* take away the 4 with its sign, from the 9 with its sign, we shall be sure of the remainder sought. In order to this, let us write 9 in this form, namely, $9 + 4 - 4$, which you see, although it takes up more room is only 9, for $4 - 4$ is *nothing*. From the 9 thus expressed, *take away* the + 4, that is, fancy it actually taken up in your fingers and removed, or which will answer as well, take it away by rubbing it out; what remains is evidently $9 - 4$ or 5.

Again, from the same expression for the 9, now take the - 4 away; that is rub it out: what remains is evidently $9 + 4$ or 13.

You thus see that if from a positive number, as 9, you have to subtract a positive number, as 4, the true remainder will be got by *changing the sign* of the number to be subtracted, and *then adding*, as in the margin. And that if, from a positive number, you have to subtract a *negative* number, the true remainder will be got, in like manner, by *changing the sign* of the number to be subtracted, and *then adding*; as in the margin.

Hitherto, the 9 has been supposed *positive*: let it be *negative*, and, in imitation of the plan above, let us write this - 9 in the form $-9 + 4 - 4$.

From the - 9, thus written, take away, or remove, the + 4; the remainder is $-9 - 4$, or - 13.

From the same expression for the - 9, take away the - 4; the remainder is $-9 + 4$, or - 5.

You see, therefore, that if from a negative number, as - 9, you have to subtract a positive number, as 4, the true remainder will be got by *changing the sign* of the number to be subtracted, and *then adding*, as in the margin. And that if from a negative number you have to subtract a *negative* number, the true remainder will, in like manner, be got by *changing the sign* of the number to be subtracted, and *then adding*, as in the margin.

This reasoning, which of course applies to any pair of numbers, as well as to 9 and 4, at once suggests the following rule for subtraction of algebra.

RULE.—Change the signs of all the terms in the quantity to be *subtracted*, or *conceive them to be changed*; then proceed as if it were *addition* instead of subtraction: the result will be the *remainder*.

1. From $9a + 6b - 5c$ or, which is the same thing, To Take $4a - 2b + 3c$ <hr style="width: 80%; margin-left: 0;"/> Rem. $5a + 8b - 8c$	To $9a + 6b - 5c$ Add $-4a + 2b - 3c$ <hr style="width: 80%; margin-left: 0;"/> $5a + 8b - 8c$
--	--

In the operation on the left, the signs of the subtractive terms are only *conceived* to be changed, and then *addition* performed. On the right the change is actually made, and the terms then added. I need scarcely say that the results of subtraction, like those of addition, are written from left to right.

2. From $4ax - 3by - 7cz$ Take $5ax + 4by - 9cz - 2$ <hr style="width: 80%; margin-left: 0;"/> Rem. $-ax - 7by + 2cs + 2$	3. From $8mx + 6x - 6ay - 2$ Take $-2mx - 3bx + 4ay - 8$ <hr style="width: 80%; margin-left: 0;"/> Rem. $10mx + 4bx - 10ay + 1$
---	---

As subtraction is thus converted into addition, all that has been said about addition applies of course here. Terms that have no like are to be brought down in the remainder, those that are in the subtractive row with *changed signs*.

EXAMPLES FOR EXERCISE.

$$\begin{array}{r} 1. \\ 5x - 6y + 3z \\ 2x + 4y - 5z \\ \hline \end{array}$$

$$\begin{array}{r} 2. \\ 2ax + 4by - 7cz \\ 3ax - 2by + 4cz \\ \hline \end{array}$$

$$\begin{array}{r} 3. \\ -4xy - 6ax + 7 \\ -5xy + 9ax - 4 \\ \hline \end{array}$$

$$\begin{array}{r} 4. \\ -28ay - 14bx + 6 \\ -18ay - 9bx \\ \hline \end{array}$$

$$\begin{array}{r} 5. \\ 11abc + 3de - 6fy \\ -9abc - 7de + 5 \\ \hline \end{array}$$

$$\begin{array}{r} 6. \\ 2bx - 3ax - m \\ -4bx + 2ax + en \\ \hline \end{array}$$

$$\begin{array}{r} 7. \\ 8 - 6 + 2 - 4 - 7 \\ 3 + 5 - 9 + 2 - 4 \\ \hline \end{array}$$

$$\begin{array}{r} 8. \\ 10dy - 11ax - 12fs - 3m \\ 9dy - 11ax + 12fs + 8m - 4 \\ \hline \end{array}$$

$$\begin{array}{r} 9. \\ -7ayz - 9bx + 6c - 2e \\ 4ayz + 8bx + 2c - 4d \\ \hline \end{array}$$

$$\begin{array}{r} 10. \\ 9cex - 7aby + 2dx + 11 \\ -3cex + aby - 2dx - 3z \\ \hline \end{array}$$

In the following examples the suitable *arrangement* of the terms, so as to bring like quantities under one another, is left for you to manage yourself.

11. From $5ax - 3by + 7cz$ take $2by - 3ax + 2cz$.
12. From $-4bz - 2cy - az$ take $3ax + 4cy - 8bz$.
13. From $7ay + 5bx - 16$ take $-3bx + 4ay + 3ax$.
14. From $4\frac{1}{2}x - 2y + 13z - 4$ take $5x + 6y - \frac{1}{2}x$.
15. From $-8\frac{1}{2}axy - 3\frac{1}{2}bz + 4m$ take $-6\frac{1}{2}bz - 4axy + 2n$.
16. From $6\frac{1}{2}yz - 5\frac{1}{2}ax - 2\frac{1}{2}$ take $4ay - 3\frac{1}{2}ax + 4yz + \frac{3}{2}$.

If you have correctly worked the examples now given, you will have acquired a pretty good knowledge of Algebraical Addition and Subtraction, and have become familiar with the meaning and use of the plus and minus signs. I shall now explain to you a few further particulars, and shall then give you a short specimen of the application of Algebra to what are called Simple Equations. These will throw some light upon the practical utility of the science; they will afford you an insight into the value of algebraic symbols in matters of calculation, and enable you to see the great advantage in such matters of combining *letters* with *figures*.

You already know that the sign *minus* prefixed to a quantity indicates the *subtraction* of that quantity. Hitherto the sign has been prefixed to *simple* quantities only; but it may be prefixed to a *compound* quantity, so as to indicate that all the simple terms of which it is composed are to be subtracted. In order to this it is only necessary to unite all the terms by some link, so as to imply that when a sign is put before the compound quantity, that sign is to affect the *whole quantity*, or every individual term of which it is composed: whatever be the link employed, it is called a *vinculum*. Suppose we have the compound quantity $4a - 2b + 3c$ to subtract from $9a + 6b - 5c$, as in Exercise 1, page 169. We might indicate the subtraction thus:—

$$9a + 6b - 5c - (4a - 2b + 3c); \text{ or } 9a + 6b - 5c - \{ 4a - 2b + 3c \}; \text{ or } 9a + 6b - 5c - [4a - 2b + 3c].$$

Such *vincula* as these are also called *brackets*. It is plain, from the rule of subtraction, that a *bracketed quantity* may be freed from the brackets, when a *minus sign* is prefixed to it, by simply *changing the signs* of all the terms which compose it. Thus the above expression, without brackets, is,

$$9a + 6b - 5c - 4a + 2b - 3c = 5a + 8b - 8c.$$

And the subtraction of a compound quantity may in general be performed in this way without taking the trouble of writing it under the quantity it is to be taken from. When the terms to be subtracted are all connected, with changed signs, as above, to the other quantity, we shall merely have a row of terms to be united, like with like, as in addition; just the same as in the example now given.

If the sign *plus* appear before a bracketed quantity, then, since *addition* implies no change of sign, the signs must remain undisturbed, though the brackets be removed: thus—

$$9a + 6b - 5c + (4a - 2b + 3c) = 9a + 6b - 5c + 4a - 2b + 3c = 13a + 4b - 2c.$$

Now, that you may never find yourself puzzled, as to signs, when you have to free an expression from brackets, always be careful to notice the *sign*, whether *+* or *-*, which precedes the bracket; fancy this sign rubbed out along with the brackets; if it be *+*, the terms thus set free present their proper signs, without any change being necessary. Of course the *leading* term within the brackets, if itself a *plus* term, as the *4a*, above, will not have its *sign* actually inserted; so that when the *+* before the bracket is rubbed out with the brackets themselves, there will be a gap as between the *5c* and the *4a* here; you need scarcely be told that in this gap the *+* belonging to the *4a* must be inserted, because *4a* is now not a leading quantity.

But if the sign before the bracket be *-*, then having rubbed out this sign, with the brackets, or having fancied it rubbed out, write all the terms, thus set free, with *changed signs*. For example—

$$\begin{aligned} 8ax + by + (-5ax - 3by) &= 8ax + by - 5ax - 3by = 3ax - 2by \\ 8ax + by - (-5ax - 3by) &= 8ax + by + 5ax + 3by = 13ax + 4by \end{aligned}$$

You see that in the first of these expressions you have only to fancy that, with the tip of your finger, you rub out the marks *+* (, between the *by* and the *-5ax*; and in the second expression that you, in like manner, rub out *-* (, between the *by* and the *-5ax*, and then that the signs of the terms thus set free are *changed*. By attending to these hints, you will not be likely "to stick" at bracketed expressions.

Coefficients are frequently found before bracketed quantities; you are aware that coefficients are *multipliers* or *factors*. When the brackets are removed, the factor is to be introduced into each simple term, as in the instances following:—

$$\begin{aligned} 3(4a - 2b + 3c) &= 12a - 6b + 9c; & 6(-5ax - 3by) &= -30ax - 18by \\ -4(-3x - 5ay + 2) &= 12x + 20ay - 8; & 2a(3xy - 2bz) &= 6axy - 4abz. \end{aligned}$$

As already stated, brackets are not the only kind of *vincula* used to bind a set of simple quantities into one compound whole; a *bar* or *line*, put over the row of quantities, is sometimes, though less frequently, employed; thus, $a + b + \overline{a - b}$, and $a + b - \overline{a - b}$, are the same as $a + b + (a - b)$, and $a + b - (a - b)$; but this kind of vinculum is getting out of use, though the bar or line, which separates the numerator from the denominator of a fraction, still performs the office of a vinculum when there are several terms in the numerator; thus, in the fraction— $\frac{ax - by + c}{m}$, the minus sign, before the

bar of separation, operates as it would do if the compound numerator were inclosed in brackets; thus, $\frac{-(ax - by + c)}{m}$, that is, the fraction is the same as $\frac{-ax + by - c}{m}$

I shall not detain you further with these explanations, except to remark that the two instances I have given above, to show the meaning of the *bar-vinculum*, suggest two arithmetical theorems, which, although very simple, you will do well to remember, as they are useful. The expressions referred to are—

$$a + b + (a - b) = 2a, \text{ and } a + b - (a - b) = 2b.$$

Now, as a and b may stand for any two numbers whatever, we learn from these results that—

1. *The sum ($a + b$) of any two numbers, increased by their difference ($a - b$), is twice the greater number; that is, $2a$.*

2. *The sum of any two numbers, diminished by their difference, is twice the less, viz. $2b$.*

Take, for instance, the two numbers 7 and 3; their sum 10, increased by their difference 4, is 14—double of the greater, 7. And the same sum, 10, diminished by their difference, 4, is 6—double of the less; and the same of any pair of numbers whatever.

SIMPLE EQUATIONS.

I am now going to show you a few applications of the principles laid down in the foregoing articles to the *solution of simple equations*. What I here propose to give, you must regard, however, as only an introduction to the complete consideration of the subject; it will be resumed hereafter.

An *equation* is merely a statement, in the characters of algebra or arithmetic, that two quantities are equal: thus, *that two and five are equal to seven*, is a statement of equality which, when expressed in figures and signs, thus, $2 + 5 = 7$, is an equation. In like manner all these are equations—namely, $6 + 2 - 3 = 5$, $7 - 4 = 6 - 3$, $2 + 8 - 1 = 9$, $3x - 2 = 10$, &c., &c. All but the last are purely arithmetical equations; the last is an *algebraical* equation, as it contains the algebraical character or symbol x . You see that an equation consists of two *members* or *sides*: one on the left of the sign of equality, and the other on the right. These members or sides, if equally increased, or equally diminished, equally multiplied, or equally divided, give results that most evidently be *new equations*, because *equal* quantities thus operated upon must give *equal* quantities for the results of the operations. This is a general axiom which you must pay attention to, as your success in solving the equations I am about to give will depend chiefly upon your skill in applying it. But I must tell you what I mean by *solving* an equation.

You are said to have *solved* a question in arithmetic when you have worked it out and arrived at the *answer*; till you have completed the calculation, the answer remains *unknown*. It is the same in algebra; *the solution of an equation* is the finding the value or interpretation of some letter or letters which at the outset is unknown. Unknown values are usually represented by letters towards the *end* of the alphabet as x , y , z , &c., while letters whose numerical value are already known, are chosen from the beginning, as a , b , c , &c. In the equation given above, namely, $3x - 2 = 10$, x represents a number, at present unknown, such that three times that number, diminished by 2, is equal to 10; the operation by which the number, or value of x , is discovered, is the solution of the equation. This solution is as follows:—

Add 2 to each *side*; the result is the new equation $3x = 12$; that is, 3 times x is equal to 12.

Divide each side of this by 3: the result is $x = 4$: so that x , at first an unknown value, turns out to be equal to 4; and you see that three times 4 diminished by 2 is equal to 10.

As here, so in the examples which follow, x will always be used to stand for the value at the outset unknown; so that the solution of the equation will be the *finding the value of x* ; the operations for this purpose will be very easy: they are called *Transposition* and *Clearing Fractions*.

Transposition.—The operation called transposition consists simply in taking quantities from one side of an equation, and putting them on the other side, still, however, taking care to preserve the *equality* of the two sides, for whatever operations we perform, we must never disturb the equality of the two sides; the *result* of each operation must still be an *equation*. Now, if you remove a quantity from one side of an equation, and place it on the other side, that is, if you rub it out, sign and all, from one side, and then write it down on the other, the change you thus make will not disturb the equality of the two sides, provided only the quantity rubbed out be written on the other side with *changed sign*. You will be convinced of this by an example or two. Let there be the equation $4x - 5 = 3x - 2$: then if we wish the 5 on the left to be removed to the right, all we have to do is to *add 5 to both sides* of the equation, the result is the equation $4x = 3x - 2 + 5$. Here you see that the 5 is *transposed*; it is taken from the left side and put on the right *with changed sign*. The new equation is therefore $4x = 3x + 3$. Again: if we now wish to remove the $3x$ from the right to the left, all we have to do is to *subtract $3x$ from both sides*; the result is the equation $4x - 3x = 3$. Here you see that the $3x$ is *transposed*: it is taken from the right and put on the left *with changed sign*. The new equation is therefore $x = 3$. We have thus actually *solved* the equation $4x - 5 = 3x - 2$; the x in this equation, at the outset unknown in value, is now found out to stand for 3. If you put this 3 for the x in the proposed equation, it becomes the numerical equation $12 - 5 = 9 - 2$; which you see is true, each side being 7.

Clearing fractions.—When a fraction occurs in an equation, we may *clear* the equation of the fraction by multiplying both sides of it by the denominator of the fraction. You know from common arithmetic, that if you multiply a fraction by its denominator, the result is simply the numerator: thus, $\frac{2}{3} \times 3 = 2$; $\frac{4}{5} \times 5 = 4$; $\frac{2}{7} \times 7 = 2$, and so on. In like manner, $\frac{x}{3} \times 3 = x$; $\frac{---}{5} \times 5 = 4x$; $\frac{---}{7} \times 7 = 2a$, &c. If, therefore, we

have such an equation as $2x + \frac{x}{3} + 2 = 22 - x$ it will become cleared of fractions by multiplying both sides by 3: the result of this multiplication is the new equation $6x + x + 6 = 66 - 3x$, which is free from fractions. To complete the solution of the equation, that is to find the value of x , we must, by transposition, bring *all* the unknown quantities to one side of the equation, and *all* the known quantities to the other: we shall thus have $6x + x + 3x = 66 - 6$; that is, $10x = 60$; consequently, dividing each side by 10, there results finally $x = 6$: and if this be put for x in the original equation, you will find the two sides of it to be numerically equal, for each side will be 16.

To solve a simple equation containing only one unknown quantity.

RULE I.—If there be a fraction in the equation, clear it away by multiplying both sides by the *denominator* of the fraction.

2. If known and unknown quantities are linked together, separate them by *transposition*; so that *all* the unknown quantities may appear on one side of the equation, and all the known quantities on the other.

3. Collect the terms on each side into one sum, so that there may be only a single unknown term on one side of the equation, and a single known term on the other.

4. Lastly, divide each side by the coefficient or multiplier of x , the unknown quantity, the result will be x *alone* on one side, and its value or interpretation on the other side of the sign of equality.

EXAMPLE 1.—Given the equation $5x - 8 = 3x + 2$ to find the value of x . As it is usual to choose the *left* hand side of the equation for the unknown quantities, and the other side for the known numbers, I shall *transpose* the known number 8, and thus get the equation $5x = 3x + 2 + 8$, then transposing the unknown quantity $3x$, I shall obtain the equation $5x - 3x = 2 + 8$, the *left* side of which is occupied wholly with unknown, and the *right* side wholly with known quantities. Reducing now each side to a single term, the equation is $2x = 10$; and dividing by 2, there results $x = 5$. The steps of the solution, as you would be expected to solve the equation, would stand as follows:—

Given equation,	$5x - 8 = 3x + 2$
By transposition,	$5x - 3x = 2 + 8$
Collecting the terms,	$2x = 10$
Dividing by 2,	$x = 5$

2. Given the equation $2x - 9 = 31 - 3x$ to find the value of x .

By transposing, $2x + 3x = 31 + 9$
Collecting, $5x = 40$
Dividing by 5, $x = 8$

3. Given the equation $\frac{2x}{3} + \frac{x}{4} - 22 = 0$ to find the value of x .

Multiplying by 3, to clear the first fraction,

$$2x + \frac{3x}{4} - 66 = 0$$

Multiplying by 4, to clear the remaining fraction,

$8x + 3x - 264 = 0$
Transposing, $8x + 3x = 264$
Collecting, $11x = 264$
Dividing by 11, $x = 24$

4. Given $\frac{x}{3} + \frac{x}{4} + \frac{x}{5} = 1$, to find the value of x .

Multiplying by 3,	$x + \frac{3x}{4} + \frac{3x}{5} = 3$
-------------------	---------------------------------------

,, by 4,	$4x + 3x + \frac{12x}{5} = 12$
----------	--------------------------------

,, by 5,	$20x + 15x + 12x = 60$
----------	------------------------

$$\therefore 47x = 60, \therefore x = \frac{60}{47} = 1\frac{13}{47}$$

NOTE.—The sign \therefore , as in the preceding treatises, stands for the word *therefore*; on account of its convenience it will be frequently used hereafter.

EXAMPLES FOR EXERCISE.

Find the value of x in each of the following equations :—

NOTE.—Since any quantity may be removed from one side of an equation to the other, provided its sign be changed, it follows that if all the signs on one side, and all the signs on the other be changed, the equality of the two sides will not be disturbed; for this changing of all the signs is merely the same as transposing the two sides.

- | | | |
|-------------------------------------|---|---|
| 1. $2x - 7 = x + 4$ | 13. $\frac{2x}{3} - \frac{x}{4} = 5$ | 20. $\frac{x}{2} + \frac{x}{3} - \frac{x}{4} - \frac{1}{2} = 0$ |
| 2. $5x - 3 = 3x + 5$ | 14. $\frac{x}{2} + \frac{x}{3} = 31 - \frac{x}{5}$ | 21. $11 - \frac{6x}{8} = \frac{x}{2} - \frac{2x}{3}$ |
| 3. $6x + 2 = 4x + 8$ | 15. $\frac{x}{3} + \frac{x}{4} + \frac{x}{6} = 1$ | 22. $4x - 2(8 - x) = \frac{x+3}{2}$ |
| 4. $3x - 1 = x + 7$ | 16. $2x - (48 - x) = x + 12$ | 23. $Cx - \frac{4 - 3x}{5} = \frac{29}{5}$ |
| 5. $8x - 13 = 4x - 1$ | 17. $\frac{5(3x + 2)}{2} = 85$ | 24. $\frac{x-6}{2} + \frac{x}{3} = 20 - \frac{x-2}{2}$ |
| 6. $2(x + 3) = 20$ | 18. $\frac{x+3}{5} - 1 = 2 - \frac{x}{7}$ | 25. $\frac{3x-13}{7} + \frac{11-4x}{3} = 0$ |
| 7. $3(x - 4) = 6$ | 19. $\frac{x}{2} + \frac{x}{3} - \frac{x}{5} - 1 = 0$ | 26. $\frac{6x-1}{2} - \frac{x-2}{8} = \frac{3-x}{4}$ |
| 8. $4(x - 1) = x + 5$ | | |
| 9. $5(x + 2) = 2(x + 8)$ | | |
| 10. $3(2x - 3) = 4(x - 2)$ | | |
| 11. $\frac{x}{3} + \frac{x}{4} = 7$ | | |
| 12. $\frac{x}{3} - \frac{x}{4} = 1$ | | |

QUESTIONS TO BE SOLVED BY SIMPLE EQUATIONS.

Every question, whether in arithmetic or algebra, has for its object the discovery of some unknown value by means of the conditions, stated in the question, which connect it with known values. In algebra, the first thing to be done is to express these conditions in the form of an equation, some letter, as x , being made to stand for the unknown quantity; the solution of the equation is the solution of the question. If there are several unknown quantities to be determined, as many distinct equations will in general be necessary; at present those questions only will be considered that furnish a single equation with one unknown quantity. The method of translating such questions into equations will be better learnt by the study of a few examples than by verbal directions. I shall therefore here give you some instances of the modes of proceeding.

1. There are two numbers of which the difference is 8 and the sum 38: what are the numbers?

Let x stand for the smaller of the two numbers: then $x + 8$ must represent the greater: and since by the question the sum of the two is 38, we have the equation,

$$x + x + 8 = 38.$$

Or transposing the 8, $2x = 30$, $\therefore x = 15$, the smaller number; and as $x + 8$ is the greater, $\therefore 15 + 8 = 23$, is the greater.

You see that these numbers satisfy the conditions of the question; for $23 - 15 = 8$, and $23 + 15 = 38$.

2. From two places, 160 miles apart, two persons, A and B, set out at the same time to meet each other. A travels 18 miles a-day, and B 22 miles: in how many days will they meet?

Suppose they meet in x days: then A will have travelled $18x$ miles, and B, $22x$ miles: the sum of these distances is, by the question, 160 miles: hence we have the equation,

$$18x + 22x = 160;$$

that is, $40x = 160$, $\therefore x = 4$, the number of days.

3. A father is three times as old as his son; but five years ago he was four times as old: what are their ages now?

Let the present age of the son be x years: then, by the question, that of the father is $3x$ years. Also five years ago the age of the son must have been $x - 5$, and that of the father $3x - 5$. The question tells us that this latter number is four times the former: that is,

$$3x - 5 = 4(x - 5);$$

or, removing the vinculum, $3x - 5 = 4x - 20$; \therefore transposing the 20 to the left, and the $3x$ to the right,

$$20 - 5 = 4x - 3x, \therefore 15 = x;$$

that is, the son's age is 15 years; and $3x$, the age of the father, is 45.

4. A vessel holding 120 gallons is partly filled by a spout which delivers 14 gallons in a minute: this is then turned off, and a second spout, delivering 9 gallons in a minute, completes the filling of the vessel. How long did *each* spout run, the time occupied by *both* being 10 minutes?

Suppose the first ran x minutes: then the second ran $10 - x$ minutes. As the first delivers 14 gallons a minute, the quantity delivered by this spout must be $14x$ gallons; and the quantity delivered by the other, at 9 gallons a minute, must be $9(10 - x)$ gallons; \therefore the *whole* number of gallons delivered is,

$$\begin{aligned} 14x + 9(10 - x) &= 120, \text{ by the question;} \\ \text{that is, removing vinculum, } 14x + 90 - 9x &= 120; \\ \therefore \text{transposing, } 14x - 9x &= 120 - 90; \\ \text{collecting, } 5x &= 30, \therefore x = 6. \end{aligned}$$

\therefore the first spout ran 6 minutes, and the second $10 - 6 = 4$ minutes.

5. What number is that of which the third part exceeds the fifth part by 48?

Let x be the number: then by the question

$$\frac{x}{3} - \frac{x}{5} = 48$$

$$\text{Multiplying by 3, } x - \frac{3x}{5} = 144$$

$$\text{" by 5, } 5x - 3x = 720;$$

that is, $2x = 720$, $\therefore x = 360$, the number required.

The third part of this is 120; the fifth part is 72; and the difference between these parts is 48.

6. A vessel can be filled from a tap in 3 hours, and from a second tap in 5 hours: in what time will it be filled if both taps run together?

Let the number of hours be x : then the part of the vessel filled in *one* hour will be the $\frac{1}{x}$ part. †

But the part filled by the first tap in 1 hour is the $\frac{1}{3}$ part, and by the second tap the $\frac{1}{5}$ part;

$$\therefore \frac{1}{3} + \frac{1}{5} = \frac{1}{x}; \text{ that is, } \frac{8}{15} = \frac{1}{x}$$

$$\text{Multiplying by 15, } 8 = \frac{15}{x}$$

$$\text{" by } x, \quad 8x = 15, \therefore x = \frac{15}{8} = 1\frac{7}{8}$$

\therefore the time is one hour and seven-eighths.

These specimens of the solution of questions by simple equations must suffice for the present. You will see, from an examination of them, that the only thing of any difficulty, in thus applying the first principles of Algebra, is the translation of the conditions of the question into algebraical language, under the form of an equation; the process by which this equation is to be solved, and the unknown quantity in it discovered, is in general sufficiently suggested by the appearance of the equation itself. As the aim is to isolate the x , so that it alone may occupy one side of the equation, while known numbers occupy the other, every step in the solution is made to contribute to this end. By transposition, clearing fractions, collecting like terms, &c., the equation is made to pass through one change after another, till at length a single unknown term appears on one side, and a known number, which is its interpretation, on the other. It then only remains to divide each side by the coefficient of x , if it have a coefficient other than unity, and x itself becomes known.

 QUESTIONS FOR EXERCISE.

1. There are two numbers of which the difference is 9, and the sum 43: what are the numbers?
2. From two places, 108 miles apart, two persons, A and B, set out at the same time to meet each other. A travels 17 miles a-day, and B travels 18: in how many days will they meet?
3. Find two numbers of which the difference is 13, and which are such that if 17 be added to their sum, the whole will amount to 62.
4. There are two numbers of which the difference is 15, and which are such that if 7 times the less be subtracted from 5 times the greater, the difference is 19: what are the numbers?
5. A person starts from a certain place, and travels at the rate of 4 miles an hour. After he has been gone 10 hours, a horseman, riding 9 miles an hour, is dispatched after him: how many hours must the horseman ride to overtake him?
6. A person has 264 coins,—sovereigns, and florins: he has $4\frac{1}{2}$ times as many florins as sovereigns: how many of each coin has he?
7. A person spends $\frac{1}{4}$ th of his yearly income in board and lodging, $\frac{1}{4}$ th in clothes and other expenses, and he lays by £85 a-year: what is his income?
8. What number is that whose *third* part exceeds its *fifth* part by 72?
9. I have a certain number in my thoughts. I multiply it by 7, add 3 to the product, and divide the sum by 2. I then find that if I subtract 4 from the quotient, I get 15: what number am I thinking of?
10. A man 40 years old has a son 9 years old: the father is therefore more than 4 times as old as his son; in how many years will the father be only twice as old as his son?
11. Two persons, A and B, 120 miles apart, set out at the same time to meet each other. A goes 3 miles an hour, and B, 5 miles: what distance will each have travelled when they meet?
12. Divide £250 among A, B, and C, so that B may have £23 more than A, and C £105 more than B.
13. A can execute a piece of work in 3 days which takes B 7 days to perform: in how many days can it be done if A and B work together?

14. A cistern can be filled by three pipes : by the first in 2 hours, by the second in 3, and by the third in 4 : in what time can it be filled by all the pipes running together ?

15. Solve the preceding question when the first pipe fills the cistern in 1 hour 20 minutes ; the second in 3 hours 20 minutes ; and the third in 5 hours.

16. After A has been working 4 days at a job which he can finish in 10 days, B is sent to help him ; they finish it together in 2 days : in what time could B alone have done the whole ?

17. Divide £143 among A, B, and C, so that A may receive twice as much as B, and B three times as much as C.

18. A person has 40 quarts of superior wine worth 7*s.* a quart ; he wishes, however, so to reduce its quality as that he may sell it at 4*s.* 6*d.* a quart : how much water must he add ?

19. Divide 90 into four parts, such, that if the first be increased by 2, the second diminished by 2, the third multiplied by 2, and the fourth divided by 2, the results may all be equal.

20. Divide 39 into four parts, such, that if the first be increased by 1, the second diminished by 2, the third multiplied by 3, and the fourth divided by 4, the results may all be equal.

The preceding examples may serve to show you how the first principles of algebra may be applied to inquiries of a practical nature. It is time that you now proceed to the other two rules—multiplication and division ; for, as in arithmetic, these four rules comprehend all the operations in the science. But two or three particulars must be previously defined.

You know that when factors are multiplied together, the result is called a *product* ; if the factors are all *equal*, the product is called a *power* of the factor whose repetition in the multiplication has produced it : thus, in the following instances, namely—

$$5 \times 5 = 25 ; 3 \times 3 \times 3 = 27 ; 2 \times 2 \times 2 \times 2 = 16, \&c.$$

25 is the *second power*, or the *square* of 5 ; 27 is the *third power*, or the *cube* of 3 ; 16 is the *fourth power* of 2 ; 32 is the *fifth power* of 2 ; 64 the *sixth power*, and so on. The fourth power of *a* is *aaaa* ; the fifth power of *x* is *xxxxx*, and so on. But as this repetition of the factors is tedious and cumbersome, it is agreed to represent a power by writing down the factor only *once*, and placing over the right hand upper corner the *number* which denotes the *repetitions* ; thus, the fourth power of *a* is written a^4 , the fifth power of *x* is written x^5 , and so on. Suppose, for example, that *x* stands for 3, then $x = 3$, $x^2 = 9$, $x^3 = 27$, $x^4 = 81$, $x^5 = 243$, $x^6 = 729$, $x^7 = 2187$, &c. The small figures, thus used in the notation for powers, are called *exponents* or *indices* ; the exponent or index for the *cube*, or *third power*, is 3, that for the fourth power 4, and so on.

The number or quantity, which thus produces a *power*, is called a *root* of that power ; thus, 3 is the *square root* of 9, the *cube root* of 27, the *fourth root* of 81, and so on. There is a convenient notation for *roots* as well as for *powers*.

The sign $\sqrt{\quad}$, for a root, is called the radical sign ; it is prefixed to the quantity whose root is meant, and a small figure, denoting *what* root is to be understood, is connected with it ; thus, $\sqrt[2]{4}$ means the *second*, or *square* root of 4, that is, 2 ; because the *second power*, or *square* of 2, is 4 ; in like manner, $\sqrt[3]{8}$ means the *third*, or *cube* root of 8, namely, 2 ; because the *third power*, or *cube* of 2, is 8 ; $\sqrt[4]{x}$ means the *fourth* root of *x*,

that is, it is a number such that the *fourth power* of that number is the number that *a* stands for. It must be observed, however, that in the case of the *second* or *square* root, the little 2 is always omitted; so that when there is no *index-figure* connected with the radical sign $\sqrt{\quad}$, the *square root* is always to be understood. You will now easily make out the following statements or equations:—

$$\sqrt{9} = 3, \sqrt[3]{125} = 5, \sqrt[4]{a^4} = a, \sqrt[5]{x^5} = x, \sqrt{x^2} = x.$$

But besides the radical sign, there is another contrivance for indicating roots—a contrivance like that for denoting powers, namely, the attaching an *exponent* to the quantity whose root is meant; thus, the equations above, expressed in this other form of notation, are as follow:—

$$9^{\frac{1}{2}} = 3, 125^{\frac{1}{3}} = 5, (a^4)^{\frac{1}{4}} = a, (x^5)^{\frac{1}{5}} = x, (x^2)^{\frac{1}{2}} = x.$$

In the case of a *power* of a quantity, the exponent is a whole number, which indicates *what power* is meant; in the case of a root, the exponent is a fraction, the denominator of which indicates, *what root* is meant. The *power* of a proposed quantity may be easily determined, as the *multiplication* may be actually executed with but little trouble; but to find a specified *root* of a proposed quantity—even of a common number—is often a difficult matter; some numbers, indeed, have no *exact* roots. But I shall have to speak about roots again.

MULTIPLICATION.

CASE I.—When the factors are simple quantities.

RULE 1. Observe whether the *signs* of the two factors are *like* or *unlike*; if they are *like*, that is, both + or both —, write + for the sign of the product; but if they are *unlike*, that is, one + and the other —, write — for the sign of the product.

2. After the sign, write the product of the *coefficients*.

3. After the product of the coefficients, write that of the *letters*: that is, put down the letters in both factors, one after the other, without any sign between them, and the complete product will be exhibited.

Thus, if we have to multiply together the two factors, $-4ax$ and $3by$, we first observe the signs; these being *unlike*, we know that the sign of the product is *minus*; after this *minus* we write 12, the product of the coefficients, and finally we place against the 12 the quantity $abxy$, this being the product of the letters when arranged in alphabetical order, \therefore the product is $-12abxy$. Again, if we have to multiply $-7bx$ by $-5acy$, then the signs being *like*, we write + for the sign of the product, 35 for the product of the coefficients, and $abcxy$ for the product of the letters; $\therefore -7bx \times -5acy = 35abcxy$, the *plus* sign being omitted, as unnecessary. In a similar way we have—

$$\begin{aligned} 3ma \times 6ay &= 18amxy, & 2by \times -4ax &= -8abxy. \\ -4a^2x \times 5a^2bx &= -20a^4bx^2, & -3bz^2 \times -8a^3bx &= 24a^3b^2z^3. \end{aligned}$$

You will observe that the *third* of these examples is the same as $-4ax \times 5aabx = -20aaaaabx$; and that this result, in the more brief notation for *powers*, is $-20a^6bx^2$. And you must perceive that, by always adopting this notation, the multiplication of *powers of the same quantity* is reduced simply to the *addition of the exponents* of the factors; thus, the factors in $x^2 \cdot x^3$, factors which are all powers of the

same quantity x , are x^2 , x^3 , x^5 ; the *sum* of the exponents is $2 + 3 + 5 = 10$; so that $x^2 \cdot x^3 \cdot x^5 = x^{10}$; nothing, therefore, can be more easy than the multiplication of powers of *the same* quantity. I need scarcely tell you that x is the same as x^1 , so that $x = x^1$, $x^2 = x^2$, &c.

The preceding direction, as to the *sign* of the product of two factors, is called the *Rule for the signs*. It is briefly expressed thus:—*Like signs give PLUS; unlike signs, MINUS.*

You may satisfy yourself that *the rule for the signs* is true as follows:—

Take any two factors whatever, say 7 and 3; then all the possible varieties, as to signs, will be these—namely,

$$7 \times 3, -7 \times 3, 7 \times -3, -7 \times -3.$$

The first is the case of common arithmetic, the product being 21; the second case requires no consideration; for -7 , repeated three times, is necessarily -21 . The third case is peculiar; but we may arrive at the true product thus: increase the multiplier -3 by 4; the product, whatever it be, will obviously be 4 times 7—that is, 28 *too great*; but the multiplier increased by 4 becomes 1; and *once* 7 is 7, and as this is 28 too great, the correct product must be $7 - 28$, that is -21 , $\therefore 7 \times -3 = -21$.

In like manner, in the fourth case, increase the multiplier -3 by 4; then, as before, the product will be four times -7 , that is, -28 too great; in other words, -28 must be *subtracted* from the erroneous product to make it correct; but the multiplier increased by 4, is 1, and *once* -7 is -7 ; \therefore the correct product is $-7 + 28$, that is 21; because the sign of the -28 must be *changed* when subtracted; $\therefore -7 \times -3 = 21$. You thus see that when the factors have *like* signs, the product is *plus*; and that when they have *unlike* signs, the product is *minus*; and, from the foregoing reasoning, it is plain that the same conclusion would have followed if any other two factors had been chosen; \therefore the *rule for the signs* in multiplication is general.

Ex. 1.	$\frac{7ax}{3by}$	2.	$\frac{-7ax^2}{3bx}$	3.	$\frac{-7x^2y^7}{-3ax^7}$	4.	$\frac{-8axy^2}{-7bxy}$
	$\frac{21aby}{21aby}$		$\frac{-21abx^3}{-21abx^3}$		$\frac{21ax^5y^7}{21ax^5y^7}$		$\frac{56abxy^2z^2}{56abxy^2z^2}$
6.	$\frac{13a^2b^3x}{-9ab^2x^4}$	7.	$\frac{16cy^3z^4}{-ab^2z^2}$	8.	$\frac{-\frac{1}{2}ax^4y^7}{-6ax^2y^7}$	9.	$\frac{-\frac{1}{2}x^4y^6z^2}{\frac{1}{2}ax^3y^2}$
	$\frac{-117a^3b^6x^5}{-117a^3b^6x^5}$		$\frac{-16ab^2cy^3z^6}{-16ab^2cy^3z^6}$		$\frac{3ax^6y^4}{3ax^6y^4}$		$\frac{-\frac{1}{2}ax^7y^6z^2}{-\frac{1}{2}ax^7y^6z^2}$
10.	$3a^4x^2z^3 \times 7a^2xy^3 = 21a^6x^3y^3z^3$			11.	$-4x^3yz^3 \times 5x^2y^4z^2 = -20x^5y^7z^5$		
12.	$-6b^2cx^2 \times -3b^4c^2x = 18b^6c^3x^3$			13.	$-\frac{5}{2}a^2z^3 \times \frac{3}{8}ax^2z^4 = -\frac{15}{16}a^3x^2z^7$		

EXAMPLES FOR EXERCISE.

[NOTE.—You will observe that the rule for the signs enables us to fix the sign of the product of *two* factors only; but it is unnecessary that it should do more than this; if there are *three* factors, the product of *two* becomes a *factor* to be combined with the *third*. It is plain that, however numerous the factors when the number of them preceded by the *minus* sign is *odd*, the sign of the product is *minus*; and that when the number of minus factors is *even*, the sign of the product is *plus*.]

- | | | | | | |
|-----|---|----|---|-----|---|
| 1. | $9a^2y^2 \times 4a^2y^3$ | 2. | $-7bx^2y^3 \times 8b^5y^5$ | 3. | $-4a^2x^3z^4 \times -6$ |
| 4. | $-5b^3c^2y^4 \times -3c^4y^7z$ | | | 5. | $11a^4xy^2z^3 \times -9a^3x^7y^6z^2$ |
| 6. | $-13a^2x^2y^4 \times 14a^4x^2y^3$ | 7. | $\frac{1}{2}b^4x^2y^2 \times -4b^2xy^3$ | 8. | $\frac{1}{2}ax^4z^2 \times \frac{1}{2}x^2yz^4$ |
| 9. | $2a^2y^4 \times -8a^2y^3 \times -4a^2z^4$ | | | 10. | $-3b^2yz \times -2y^2z^3 \times -4ab^2y$ |
| 11. | $\frac{1}{2}axy^3 \times \frac{3}{8}x^2y^4 \times -8a^2y^2$ | | | 12. | $\frac{3}{4}a^2z^2 \times -\frac{1}{2}xy^2 \times -\frac{3}{8}a^2y^2z$ |
| 13. | $-\frac{3}{4}a^2y^2 \times -3b^2z^2 \times -\frac{7}{8}abx^2yz$ | | | 14. | $\frac{1}{4}a^2x \times -\frac{3}{8}a^2y \times -2y^2z \times -10a^2xz^2$ |

CASE II.—When the multiplicand is a compound quantity, and the multiplier a simple quantity.

RULE.—Multiply each simple term in the multiplicand by the multiplier, beginning always at the left hand; connect the several products together by their proper signs, and the complete product will be exhibited.

$\begin{array}{r} 1. \quad 4a^2x^3 - 2by^2 \\ \quad \quad 3axy \\ \hline 12a^3x^4y - 6abxy^3 \end{array}$	$\begin{array}{r} 2. \quad -3axy^2 - 4bz + 2a^2 \\ \quad \quad 5axz^2 \\ \hline -15a^2x^2y^2z^2 - 20abxz^3 + 10a^3xz^2 \end{array}$
$\begin{array}{r} 3. \quad 6x^2yz - 2ay^2 - 3b^2y \\ \quad \quad -2xz^2 \\ \hline -12x^3yz^2 + 4axy^2z^2 + 6b^2xyz^2 \end{array}$	$\begin{array}{r} 4. \quad -5ax^3y - by^2z + \frac{1}{2}ab^3 \\ \quad \quad -6a^2by^3 \\ \hline 30a^3bx^3y^4 + 6a^2b^2y^5z - 3a^3b^4y^4 \end{array}$

EXAMPLES FOR EXERCISE.

$\begin{array}{r} 1. \quad 3ax^2 - 2bxy \\ \quad \quad 4a^2x \\ \hline \end{array}$	$\begin{array}{r} 2. \quad 5a^2y^2 - 4x^2y^3 \\ \quad \quad -3axy \\ \hline \end{array}$	$\begin{array}{r} 3. \quad -6b^2yz^3 + 4ab^3y^2 \\ \quad \quad -2ayz \\ \hline \end{array}$
$\begin{array}{r} 4. \quad 7a^3b^4x^6 - 3x^2y^4 + 5 \\ \quad \quad 4ax^3y \\ \hline \end{array}$	$\begin{array}{r} 5. \quad 9m^2nz^2 - 7a^2y^3 - 2b^3x^3y \\ \quad \quad -7an^3xz^2 \\ \hline \end{array}$	

In the following examples, the vinculum or brackets may be removed, and the simple factor (the multiplier), placed under the leading term of the compound one, as in the preceding instances; but in most cases, I dare say you will be able to write down the result of the multiplication at once, without resorting to this arrangement.

$6. \quad (2a^2bx^2 - 5xy^2) 8ax^2y$	$7. \quad (2axy^2 - 3x^2z + 2x) \times -4axy$
$8. \quad (mxy^3 + 3ny^2 - 2y^3z) \times -6m^2x^2y$	$9. \quad (4y^3z^2 - 3axz - 5by^2) \times -5ab^2y$
$10. \quad (5cx^2z^2 - y^2z^2 - 3z^4) 12c^2x^2yz^2$	$11. \quad (\frac{2}{3}ax^2 - \frac{1}{2}by^2 - 2cz^2) \times -12a^2bc^3$
$12. \quad \{4ay^2 - (2b^2z^2 - yz - 2)\} 3a^2yz^3$	$13. \quad \{2bx^2y^3 - (5cy^2z + 4yz^2 - 3z^3)\} \times -3x^2y$
$14. \quad \{5a^2x^2 - (3b^2yz + 2a^2xz - 4ay^2)\} \times -2a^2b^2xy$	

CASE III.—When multiplicand and multiplier are both compound quantities.

RULE 1.—Multiply all the terms of the multiplicand by each term of the multiplier, proceeding with each as in the last case.

2. Collect together the several products that are like, as in addition, and to the sums of these unite, by their proper signs, the other products; and the complete product will be obtained.

1. Multiply $x+y$ by $x-y$. 2. Multiply $x+y$ by $x+y$.

$\begin{array}{r} x + y \\ x - y \\ \hline x^2 + xy \\ \quad -xy - y^2 \\ \hline \end{array}$	$\begin{array}{r} x + y \\ x + y \\ \hline x^2 + xy \\ \quad xy + y^2 \\ \hline \end{array}$
$\therefore (x+y)(x-y) = x^2 - y^2$	$\therefore (x+y)^2 = x^2 + 2xy + y^2$

3. Multiply $x-y$ by $x-y$.

$$\begin{array}{r} x - y \\ x - y \\ \hline x^2 - xy \\ \quad -xy + y^2 \\ \hline \end{array}$$

$$\therefore (x-y)^2 = x^2 - 2xy + y^2$$

I have a remark to make in reference to these three examples : you will do well to keep it in remembrance ; it is this : since x and y stand for any two numbers whatever, we learn that

1. The sum of two numbers ($x + y$) multiplied by their difference ($x - y$) is the difference of the squares of those numbers ($x^2 - y^2$).

2. The square of the sum ($x + y$) of two numbers (x and y) is equal to the sum of their squares ($x^2 + y^2$), together with twice their product ($2xy$).

3. The square of the difference ($x - y$) of two numbers is equal to the sum of their squares ($x^2 + y^2$), diminished by twice their product ($2xy$).

EXAMPLE.—Let 7 be one number and 3 the other : then, 1st, their sum, 10, multiplied by their difference, 4, is 40 ; the squares of the numbers are 49 and 9 ; so that $7^2 - 3^2 = (7 + 3)(7 - 3) = 40$. 2nd. $(7 + 3)^2 = 10^2 = 100$, and $7^2 + 3^2 = 49 + 9 = 58$; also twice 7×3 , that is, $2 \times 7 \times 3 = 42$; and $58 + 42 = 100$. 3rd. $(7 - 3)^2 = 4^2 = 16$; and $58 - 42 = 16$.

4. Multiply $(x + y)^2$ by $x + y$, that is, multiply out or *develope* $(x + y)^3$.

$$\begin{aligned} (x + y)^2 &= x^2 + 2xy + y^2 \\ &\quad \begin{array}{r} x + y \\ \hline x^3 + 2x^2y + xy^2 \\ \hline x^2y + 2xy^2 + y^3 \\ \hline \end{array} \\ \therefore (x + y)^3 &= x^3 + 3x^2y + 3xy^2 + y^3 \end{aligned}$$

5. *Develope*, or multiply out $(x - 4)(x + 3)$; $(x + 5)(x - 7)$; $(2x + 3)(3x + 2)$ and $(a + a)(x + b)$.

$x - 4$	$x + 5$	$2x + 3$	$x + a$
$x + 3$	$x - 7$	$3x + 2$	$x + b$
$\hline x^2 - 4x$	$\hline x^2 + 5x$	$\hline 6x^2 + 9x$	$\hline x^2 + ax$
$\quad 3x - 12$	$\quad - 7x - 35$	$\quad 4x + 6$	$\quad bx + ab$
$\hline x^2 - x - 12$	$\hline x^2 - 2x - 35$	$\hline 6x^2 + 13x + 6$	$\hline x^2 + (a+b)x + ab$

In the third of these results the $13x$ is got by actually *adding* the coefficients 9 and 4 : in the fourth example, the corresponding coefficients of x , not being *numbers*, cannot be actually *added*; but the addition may nevertheless be *indicated*, as above; and where, in the *third* example, the middle term of the product was written $13x$, that is, $(9 + 4)x$, the corresponding term *here* is written $(a + b)x$; this is better than making *two* terms of the same quantity, and writing it thus $ax + bx$. *Here* the coefficients of x are a and b ; and, being *letters*, they are called *literal coefficients* : the coefficient of x , in the result above, is $(a + b)$. Whenever a common factor enters several of the terms of a compound expression, this common factor may always be written outside a vinculum, and whatever multiplies it, *within*; repetitions of the same factor are thus avoided; and in the answers to questions, or the final results of operations, this more compact form of expression should be adopted : thus, such a result as $abx + 4cx - 3mx$, would have an unfinished appearance; it should be changed into $(ab + 4c - 3m)x$. *This*, you will see, is more easily computed than the former, when the letters are replaced by the numbers they represent. Suppose, for instance, $a = 12$, $b = 6$, $c = 5$, and $m = 9$; and that $x = 28$; you will find that the numerical value of the expression is more readily obtained from the second form than from the first. And I may as well tell you here,

once for all, that algebraists always take care that their *results* are presented in a form that will give the *least* trouble to the arithmetical computer. This principle will in general be observed in what follows.

I shall now work an example which suggests a principle of some interest in arithmetic. (6.) Multiply $n + r$ by $n' + r'$.

$$\begin{array}{r} n + r \\ n' + r' \\ \hline nn' + n'r \\ + r'r \\ \hline nn' + n'r + n'r' + r'r' \end{array}$$

Now suppose a number to be divided by any other number, say 9, and to leave a remainder, which we may denote by r : then, if we express this number, *wanting the remainder*, by n , the entire number will be denoted by $n + r$. In like manner, a second number may be denoted by $n' + r'$, where n and n' represent numbers exactly divisible by 9; and r and r' numbers less than 9. You see by the above expression for the product of the two proposed numbers $n + r$ and $n' + r'$, that the whole of it is necessarily divisible by 9, except the part $r'r'$, because n or n' is a factor of every other term: you may, therefore, at once conclude that if you divide a *multiplicand* and its *multiplier* each by 9 (or indeed by any other number), and note the remainders (r, r'), and then divide the product of these remainders by 9 (or the other number), the remainder arising from this last division must be the very same as the remainder arising from dividing the *product* of multiplier and multiplicand by 9 (or the other number). And thus you have the principle of the *method of proving multiplication by casting out nines* (Arith. p. 12). The reason that 9 is chosen for divisor is, because that for the divisor 9, the remainder is the same whether the number itself, or only the sum of the figures composing it, be divided; and it is easier to sum up the figures, and reject the *nines*, than to perform the division on the number.

EXAMPLES FOR EXERCISE.

1. Multiply $2ax^2 - 3bx - 2$ by $3x^2 - 2x$
2. Multiply $4ay + 3bx - 4c$ by $3by + 2c$
3. Multiply out $(5x^3 - 4x^2 + 3x - 2)(2x^2 - x + 1)$
4. Multiply out $(x + 2)(x - 2)(x + 3)(x - 3)$ [See 1, page 182.]
5. Multiply out $(x + a)(x - a)(x^2 - a^2)$
6. Multiply out $(2x + 5a)(4x - 5a)(x + a)$
7. $(3ax - b)(4ac + c)(5ax - 3)$
8. $(4ax + 3by - 1)(2ax - by + 2)$
9. $(x - y)^2(x + y)$
10. $\{x^2 - (a + b)x + c\}(x - c)$
11. $3^3(x^2 - a^2)^2$
12. $(2x + 3)(2x - 8)(4x^2 + 9)$
13. $\{(x + 2)(x - 2)\}^2$
14. $(x^2 - \frac{1}{2}x + 1)(x^2 + 2x - 1)$

INVOLUTION.

Involution is nothing more than *multiplication*: it is a term employed to signify that the factors multiplied together are all *equal*, the product or result being a *power*. Example 4, for instance, page 182, is a case of involution; for $x + y$ is *raised*, as it is called, or *involved*, to the third power. Involution is thus the operation of raising a proposed quantity to a proposed power, and this operation you know is *multiplication*. The following are examples of the involution of *simple quantities*.

$$(2ax)^3 = 8a^3x^3, (2a^2x)^4 = 16a^4x^4, (-ax^2y^3)^5 = -a^5x^{10}y^{15}, \&c.$$

The Rule for obtaining the powers in such cases as these is pretty obvious.

To the power of the coefficient annex the letters, with their several exponents multiplied by the exponent of the power.

The rule of signs must of course be attended to. If the quantity to be raised or involved be negative, the sign of every even power must be positive—that of every odd power negative. The following examples cannot present any difficulty:—

$$\begin{array}{llll} 1. (8a^2x^2)^3 & 2. (7by^2)^4 & 3. (-4a^2b^2x^4)^2 & 4. (2x^4y^2z)^5 \\ 5. (-3a^2y^2z^2)^3 & 6. (-8b^2x^4y^2)^3 & 7. (5a^2b^2c^4)^4 & 8. (-2^2a^2x^2y)^3 \end{array}$$

When the quantity to be involved is a compound quantity, the proposed power of it is to be found by multiplying the quantity the requisite number of times by itself, as in the examples below:—

1. To find the cube of $a - 2x$. 2. To find the cube of $3ax - 4y$.

$$\begin{array}{r} a-2x \\ a-2x \\ \hline a^2-2ax \\ -2ax+4x^2 \\ \hline (a-2x)^2 = a^2-4ax+4x^2 \\ a-2x \\ \hline a^3-4a^2x+4ax^2 \\ -2a^2x+8ax^2-8x^3 \\ \hline (a-2x)^3 = a^3-6a^2x+12ax^2-8x^3 \end{array} \qquad \begin{array}{r} 3ax-4y \\ 3ax-4y \\ \hline 9a^2x^2-12axy \\ -12axy+16y^2 \\ \hline (3ax-4y)^2 = 9a^2x^2-24axy+16y^2 \\ 3ax-4y \\ \hline 27a^3x^3-72a^2x^2y+48axy^2 \\ -36a^2xy+96axy^2-64y^3 \\ \hline (3ax-4y)^3 = 27a^3x^3-108a^2x^2y+144axy^2-64y^3 \end{array}$$

EXAMPLES FOR EXERCISE.

1. $(a + 2x)^3$ 2. $(3ax - 4y)^3$ 3. $(a + b + c)^2$ 4. $(3x^2 + 2x + 5)^2$
 5. $(a - 2b + 3c)^2$ 6. $\{(a + x)(a - x)\}^2$ 7. $\{(x + 2)(x - 2)\}^4$
 8. $\{(2x - 3)(2x + 8)\}^4$ 9. $\{(x - a)^2 + 2ax\}^4$
 10. $\{(x + 1)(x - 1)(x^2 + 1)\}^2$ 11. $\{(x - 1)^2\}^3$

The following is a table of the powers of $(a + x)$ developed in order, from $(a + x)^1$ up to $(a + x)^8$: the result of the actual multiplication is called the *development*, and sometimes the *expansion* of a power. The table exhibits the developments of the powers of an expression, consisting of two simple terms, a and x . Every expression of two terms is called a *binomial*.

Table of the developments of the powers of a binomial.

$$\begin{array}{l} (a + x)^1 = a + x \\ (a + x)^2 = a^2 + 2ax + x^2 \\ (a + x)^3 = a^3 + 3a^2x + 3ax^2 + x^3 \\ (a + x)^4 = a^4 + 4a^3x + 6a^2x^2 + 4ax^3 + x^4 \\ (a + x)^5 = a^5 + 5a^4x + 10a^3x^2 + 10a^2x^3 + 5ax^4 + x^5 \\ (a + x)^6 = a^6 + 6a^5x + 15a^4x^2 + 20a^3x^3 + 15a^2x^4 + 6ax^5 + x^6 \\ (a + x)^7 = a^7 + 7a^6x + 21a^5x^2 + 35a^4x^3 + 35a^3x^4 + 21a^2x^5 + 7ax^6 + x^7 \\ (a + x)^8 = a^8 + 8a^7x + 28a^6x^2 + 56a^5x^3 + 70a^4x^4 + 56a^3x^5 + 28a^2x^6 + 8ax^7 + x^8 \end{array}$$

This table, which may be carried to any extent, shows that the coefficients of the terms in the development of a binomial follow one another according to a remarkable law, by observing which they may be derived, each from that which precedes, with very little

trouble, so that the actual involution of the binomial may always be dispensed with. By examining the several rows of coefficients, you will discover the law to be this, namely:—

If the coefficient of any term be multiplied by the exponent of a in that term, and the product be divided by the number which marks the *place* of the term, in the row (as the 2nd place, 3rd place, &c.) the quotient will be the coefficient of the *next* term. Thus, look at the development of $(a+x)^7$. The *first* term in that development we might know to be a^7 , without actual multiplication. The coefficient of this first term is

1; and $\frac{7 \times 1}{1} = 7$ is the next coefficient, the complete term being $7a^6x$. This is the second term: and $\frac{6 \times 7}{2} = 21$, is the next coefficient, the third term being $21a^5x^2$; and from this we get $\frac{5 \times 21}{3} = 35$, the next coefficient, the fourth term being $35a^4x^3$.

In like manner, from this we find $\frac{4 \times 35}{4} = 35$, the next coefficient; and in this way all the coefficients may be found, one after another, without involution. As to the *letters* connected with these coefficients, the writing of *them* involves no trouble at all. The *first* term is the first term of the binomial, with the exponent of the power over it; the *last* term is the other term of the binomial, with the same exponent over it; this is the highest exponent in the row of terms; in each intermediate term, *both* the letters occur in conjunction; and, in proceeding from term to term, the exponents of a regularly *descend* in value, and the exponents of x as regularly *ascend*; that is, the powers of a are—

$$\begin{array}{cccccccc} a^7 & a^6 & a^5 & a^4 & a^3 & a^2 & a^1 & \\ \text{and those of } x, & x^1 & x^2 & x^3 & x^4 & x^5 & x^6 & x^7 \end{array}$$

the *sum* of the exponents of *both* letters always making 7, in every term. And, generally, the sum of the exponents, in each term, is always equal to the exponent of the power.

There are one or two other things which it is important you should take note of in looking at the foregoing developments.

1. The number of terms is always *one more* than the number which marks the power of the binomial. Thus, when the exponent is 1, the number of terms is *two*; when the exponent is 2, the number of terms is *three*, and so on; \therefore when the exponent is *odd* the number of terms is *even*, and when the exponent is *even*, the number of terms is *odd*.

You cannot, therefore, with propriety, speak of a *middle term*, except when the exponent of the power is *even*; when it is *odd*, there are *two middle terms*; and you see that the *coefficients* of these middle terms are always *the same*—another remarkable circumstance.

2. But perhaps the most remarkable thing of all is, that when, in the case of an *even* power, you have reached the middle coefficient, as above directed, the remaining coefficients are got by simply writing those which precede the middle one *in reverse order*; so that these remaining coefficients require no *computing*. When in the case of an *odd* power you have reached the first of the two middle coefficients, you have only to repeat this coefficient, and then to write all the coefficients, before the middle ones, in reverse order, as in the other case; so that no coefficient beyond the middle *one*, or the middle *pair*, need ever be *computed*; they have only to be *copied*.

The present examination affords a good opportunity to bring another particular under your notice. The foregoing *table* presents us with a set of *equations*, but they differ from the equations solved at pages 174, 175 in a very marked manner; you must take notice of this. The equations at the pages referred to fix certain *conditions*, which the value of x must be such as to satisfy—no other values of x would do; but in the equations in the preceding *table*, no *conditions* are implied, both a and x in each may stand for anything whatever; for the second side, or member, is only the first side *developed*, or unfolded, or spread out; in other words, one side is nothing but the other side put in a different form; so that, write what we will for a and x , the two sides must of necessity remain equal. Equations such as these, in which one side is only the other in a changed form, are called *identical equations*, or simply *identities*. Now, as in identities you may put anything for the *letters*, you may in the table put $-y$ for x ; you will thus get the developments of the different powers of $a - y$, or, to be uniform, of $a - x$; all you have to do is to change x into $-x$ on both sides; you will see that the only change in the development is that the *second*, and every *alternate* term, becomes *minus*; thus—

$$(a - x)^3 = a^3 - 3a^2x + 3ax^2 - x^3$$

$$(a - x)^4 = a^4 - 4a^3x + 6a^2x^2 - 4ax^3 + x^4,$$

and so on. With these changes, therefore, in the alternate signs, the table exhibits the developments of the power both of $a + x$ and $a - x$.

What has now been said in reference to the powers of $a + x$, that is in reference to the powers of a plus or minus x , must be very carefully read over, and fully understood. I have been giving to you the leading particulars of the celebrated BINOMIAL THEOREM, and you must try to impress them on your mind. In order to this, I would recommend you to write out the developments of $(a - x)^5$, $(a - x)^6$, &c., and to try $(a + x)^9$, $(a - x)^9$, &c., finding the coefficients according to the short and easy method explained above; that is, deriving them, one after another, from the *law* shown to prevail, as far at least as to the eighth power. It prevails universally, but the *general* demonstration of the *Binomial Theorem* requires more advanced principles of algebra; you will do right to refuse assent to the law *at present*, for an exponent higher than 8, unless you like to put it to the test for 9, 10, &c. You will find the theorem in a more general form hereafter. As an application of the Binomial Theorem, let it be required to develop $(a - 3y)^5$, which is the same as $(a + x)^5$, when $-3y$ is put for x .

From what is shown above, it appears that the terms, without the coefficient, are—

$$a^5, a^4(3y), a^3(3y)^2, a^2(3y)^3, a(3y)^4, (3y)^5.$$

And from the law of the coefficients, these are—

$$1, 5, \frac{4 \times 5}{2} \text{ (or 10), } 10, 5, 1;$$

the last three, being those of the first three written in reverse order; therefore, remembering to write the terms alternately plus and minus,

$$(a - 3y)^5 = a^5 - 5a^4(3y) + 10a^3(3y)^2 - 10a^2(3y)^3 + 5a(3y)^4 - (3y)^5,$$

$$= a^5 - 15a^4y + 90a^3y^2 - 270a^2y^3 + 405ay^4 - 243.$$

Again, let example 2, page 184, be taken, namely $(3ax - 4y)^3$. The terms without the coefficients are—

therefore, introducing the coefficients, 1, 3, 3, 1, we have—

$$3ax(4y)^2 - (4y)^3,$$

EXAMPLES FOR EXERCISE.

1. $(a+y)^4$. 2. $(a-x)^6$. 3. $(a+2x)^3$. 4. $(1-x)^6$. 5. $(1+3x)^4$.
 6. $(x+2y^2)^3$. 7. $(x^2+3y^2)^2$. 8. $(2a-x)^6$. 9. $(x-2y^2)^7$.

NOTE.—The preceding process may be extended to expressions of *three* terms, *four* terms, &c., in the manner following:—

$$\begin{aligned} [a+b+c]^2 &= [(a+b)+c]^2 = (a+b)^2 + 2(a+b)c + c^2 \\ &= a^2 + 2ab + b^2 + 2(a+b)c + c^2 \\ &= a^2 + b^2 + c^2 + 2(ab+ac+bc) \end{aligned}$$

$$\begin{aligned} [a+b+c+d]^2 &= [(a+b)+(c+d)]^2 = (a+b)^2 + 2(a+b)(c+d) + (c+d)^2 \\ &= a^2 + 2ab + b^2 + 2(ac+ad+bc+bd) + c^2 + 2cd + d^2 \\ &= a^2 + b^2 + c^2 + d^2 + 2(ab+ac+ad+bc+bd+cd). \end{aligned}$$

So that the square of the sum of *three* quantities, or of the sum of *four* quantities, is equal to the squares of the quantities themselves, together with twice the sum of the products of every possible pair of them; and the same is true for *five*, and for any number of quantities.

DIVISION.

When one quantity (called the *dividend*) is to be divided by another (called the *divisor*), the object is to find a third quantity (called the *quotient*), such that, if the quotient and divisor be multiplied together, the product will be the dividend; and this is to be brought about whether the quantities concerned are the figures of arithmetic, or the symbols of algebra. The rule for division is thus suggested by that for multiplication: it is as follows:—

CASE I.—When *dividend* and *divisor* are both simple quantities.

RULE 1.—Determine the *sign* of the quotient, on the principle that if the signs of dividend and divisor be like, the quotient is *plus*: if unlike, *minus*.

2. Having found the sign, next find the coefficient by dividing the coefficient of the dividend by that of the divisor, as in common arithmetic.

3. To the coefficient, annex the *letters*, which must be such, that when they are united to the letters already in the divisor, they may exactly make up those in the dividend.

It is plain, that by following these precepts, you will get a quantity for quotient such that, when it and the divisor are multiplied together, the **resulting** sign will be that of the dividend, the resulting coefficient also that of the dividend, and finally the resulting letters, arising from combining those of divisor and quotient together, the same as the letters in the dividend.

If it should happen that there are letters in the divisor, that is to say *factors* in the divisor, which are not also in the dividend; then, like as in arithmetic, since actual division by these cannot be performed, they must be written as divisors in the quotient; the quotient will then appear as a *fraction* incapable of reduction to a simpler form—just as in division of numbers.

1. Divide $-12a^2x^2y$ by $3ax$. Here $\frac{-12a^2x^2y}{3ax} = -4a^2xy$; for the signs being unlike the sign of the quotient is *minus*; also 12 divided by 3 gives 4, so that -4 is the coefficient in the quotient; and since, from looking at the letters in dividend and

divisor, we see that two a 's, one x , and a y , must be united to the divisor to make up the letters in the dividend, these wanting letters are those which the quotient must supply; the complete quotient is therefore $-4a^2xy$. If the divisor had been $3axz$, then the foregoing quotient must have been further divided by z ; that is, $\frac{-12a^2x^2y}{3axz} = \frac{-4a^2xy}{z}$; for it is plain that to divide by $3axz$ is the same as first to divide by $3ax$ and afterwards by the other factor z . In like manner, to divide by $3axy^2$ is the same as first to divide by $3axy$, and then again to divide by the other factor y , $\therefore \frac{-12a^2x^2y}{3axy^2} = -\frac{4ax}{y}$. All this is the same as in arithmetic; thus, if we have to divide 48 by 36, we may proceed as follows; $\frac{48}{36} = \frac{12.4}{12.3} = \frac{4}{3}$; for $\frac{12.4}{12} = 4$, and this divided by the other factor 3, gives $\frac{4}{3}$.

$$2. \frac{14a^4x^2y^2}{2ax^2y^2} = 7a^3x^2$$

$$3. \frac{-8a^2x^2z}{4a^2x^2z^2} = \frac{-2a^2}{xz}$$

$$4. \frac{-12b^2y^2x^2}{-4b^4y^2x} = \frac{3y^2x}{b}$$

$$5. \frac{7ax^2y^2}{2ax^2y^4} = \frac{7xy}{2}$$

$$6. \frac{-3x^4y^2z^2}{-4ax^2y^2} = \frac{3x^2y^2z^2}{4a}$$

$$7. \frac{-9xy^2z^4}{-6a^2y^2z} = -\frac{3yz^3}{2a}$$

$$8. \frac{-16a^2x^3\sqrt{y}}{-4ax^2} = 4ax\sqrt{y}$$

$$9. \frac{-4xy\sqrt{z}}{6x^2y^2} = \frac{-2\sqrt{z}}{3x^2y} \text{ or } -\frac{2\sqrt{z}}{3x^2y}$$

NOTE.—When the numerator of a fraction is *minus*, and its denominator *plus*, it is matter of indifference whether we put the minus before the *numerator*, or before the entire fraction; because, from the rule of signs, a *minus* quantity is the result of the division indicated. Thus, in the last example it is indifferent whether we write $-\frac{2\sqrt{z}}{3x^2y}$ or $\frac{-2\sqrt{z}}{3x^2y}$. The same is true when the denominator is *minus*, and the numerator *plus*; for in division of one quantity by another, as in multiplication, whichever of the quantities be minus, provided only the other be plus, the result is minus. Thus, the following all express the same thing: $\frac{-a}{b} = \frac{a}{-b} = -\frac{a}{b}$. For you see that, in either case, when a and b are interpreted, and the division performed, the quotient is *minus*. For instance—

$$\frac{-6}{2} = -3, \frac{6}{-2} = -3, -\frac{6}{2} = -3, \&c.$$

Before proceeding to the following exercises, it will be well for you to look again at precept 3 of the Rule, from which you may yourself draw an inference of some importance in the general theory of exponents. The inference is, that when the *same* letter occurs in both dividend and divisor, and that the exponent of it in the former is greater than that in the latter; the *quotient*, as far as this letter is concerned, is got by simply subtracting the smaller exponent from the greater, and placing the difference over the letter; thus, in example 2, a^4 in the dividend, and a^1 in the divisor, give a^3 in

* The learner will perceive that, having indicated the division by a fraction, whether the fraction be algebraical or purely numerical, all we have to do is to cancel all the *factors* common to numerator and denominator: the result is the value of the fraction, reduced to its simplest form.

the quotient, and x^0 in the dividend, and x^3 in the divisor, give x^3 in the quotient; the y^2 in both is cancelled. You thus see that, when the same letter or quantity is concerned, division becomes the subtraction of exponents; multiplication, as you are aware, being the addition of exponents. You will no doubt think, when the exponent in the divisor is greater than that in the dividend, that this view of division must be abandoned; but it is not so, as you will shortly see.

EXAMPLES FOR EXERCISE.

1. Divide $8ax^2y^2$ by $4axy$
2. $-6bx^2y^2z$ by $2bx^2y$
3. $-12x^2y^4z^3$ by $-8x^2y^2z^2$
4. $16ax^2y^3$ by $-4a^2xy^2$
5. $7ax^2yz^3$ by $-5a^2x^2yz^2$
6. $-8b^2y^2z$ by $6b^2y^2z^2$
7. $24cy^3$ by $-21c^2yz^2$
8. $-36a^2x^2y^3$ by $2 \times 7a^2x^2y$
9. $5abx^2\sqrt{y}$ by $10ab^2x\sqrt{y}$
10. $-8a^2cx^4$ by $-12a^2cx^2\sqrt{z}$
11. $-2mx^4y^3$ by $8m^2x^4y^3$
12. $-13x^2y^2z^3$ by $-26y^4\sqrt{z}$ (see page 179).

CASE II.—When the dividend is a compound quantity, and the divisor a simple quantity.

RULE 1. Find the quotient of the divisor, and each term of the dividend by the former rule.

2. Connect the separate quotients together, by the signs which belong to them, and the complete quotient will be obtained.

1. $\frac{4x^2y^4 - 6x^2y^2 + 8xy^2}{2xy^2} = 2x^2y^2 - 3xy + 4$
2. $\frac{12ax^2z^2 - 8a^2xz^2 - 4xz}{4xz^2} = 3axz - 2a^2 - \frac{1}{z}$
3. $\frac{21a^2x^2 + 7a^2x^2 - (42a^4x - 28)}{7a^2x}$. Here the *compound* term in the numerator is to

be subtracted from what precedes, therefore the signs of the subtractive quantities are to be changed, and they are then to be added (see page 171). Hence the fraction is—

$$\frac{21a^2x^2 + 7a^2x^2 - 42a^4x + 28}{7a^2x} = 3ax + x - 6a^2 + \frac{4}{a^2x} = 3(a+1)x - 6a^2 + \frac{4}{a^2x}$$

EXAMPLES FOR EXERCISE.

1. $\frac{9a^2x^2 - 3a^2x^2 + 6a^4x}{3a^2x}$
2. $\frac{12x^2y^4 + 6x^2y^2z^2 - 3a^2y^2}{8x^2yz^2}$
3. $\frac{3ax(4xy - 8ay^2) + 12axy}{6axy}$
4. $\frac{8x^2y^4 - 4(4ax - 2y)x}{4x^2y}$
5. $\frac{8a^2x^2y^2 - 2(3ax^2y^2z^2 - 1)}{4axy}$
6. $\frac{16a^4b^2x^3 - (8 - 3a^2bx^4)}{4a^2bx^4}$

CASE III.—When both dividend and divisor are compound quantities.

RULE 1. Arrange the terms of dividend and divisor so that the exponents of the powers of some one letter in both of them may appear in decreasing or increasing order; that is if x , for instance, be the letter chosen to govern the arrangement, place

the terms in either of these two ways:—Let the term containing the highest power of x be put first; that containing the next higher power immediately after, and so on; or else let the term containing the lowest power of x be put first, that containing the next lower immediately after, and so on; but do not write the terms at random.

2. The dividend and divisor, thus arranged, being placed as dividend and divisor, are placed in arithmetic, divide the *first* term of the dividend by the *first* term of the divisor; the result is the first term of the quotient.

3. Then, as in arithmetic, multiply the *whole* divisor by the part of the quotient thus found, and subtract the product from the dividend.

4. To the remainder annex another term, brought down from the dividend, or annex more of the terms if more are seen, from the extent of the divisor, to be required; the row of terms thus got is a new dividend, with which, and the divisor, proceed as at first, and a second quotient term will be obtained. And in this way the operation is to proceed, like the corresponding operation in arithmetic, till all the terms of the dividend have been brought down. When the last term has been brought down, and annexed to the remainder—no term in the dividend having been overlooked or neglected—then the row of terms thus got is the *complete remainder*. Should it happen that the divisor will not go into this complete remainder, the operation is at an end, and you do just as you would in the similar case of arithmetic; you place this complete remainder, with the divisor underneath, in the quotient, as a fractional correction.

1. Divide $6x^2 - ax - a^2$ by $2x - a$. Here dividend and divisor are arranged according to the *descending* powers of x , the highest power of that letter occurring in the first term. If the arrangement be the reverse of this, the operation will be that of the second form below; *minus* the dividend is divided by *minus* the divisor for convenience.*

$$\begin{array}{r} 2x - a \) \ 6x^2 - ax - a^2 \\ \underline{6x^2 - 3ax} \\ 2ax - a^2 \\ \underline{2ax - a^2} \\ 0 \end{array}$$

$$\begin{array}{r} a - 2x \) \ a^2 + ax - 6x^2 \\ \underline{a^2 - 2ax} \\ 3ax - 6x^2 \\ \underline{3ax - 6x^2} \\ 0 \end{array}$$

$$\begin{array}{r} 2. \ x^2 + 2ax + a^2 \) \ x^5 + 5ax^4 + 10a^2x^3 + 10a^3x^2 + 5a^4x + a^5 \\ \underline{x^5 + 2ax^4 + a^2x^3} \\ 3ax^4 + 9a^2x^3 + 10a^3x^2 \\ \underline{3ax^4 + 6a^2x^3 + 3a^3x^2} \\ 3a^2x^3 + 7a^3x^2 + 5a^4x \\ \underline{3a^2x^3 + 6a^3x^2 + 3a^4x} \\ a^3x^2 + 2a^4x + a^5 \\ \underline{a^3x^2 + 2a^4x + a^5} \\ 0 \end{array}$$

$$\begin{array}{r} 3. \ x - 2 \) \ 2x^4 - 32x^3 + 4x^2 + 8x + 16 \\ \underline{2x^4 - 4x^3} \\ 4x^3 \\ \underline{4x^3 - 8x^2} \\ 8x^2 \\ \underline{8x^2 - 16x} \\ 16x - 32 \\ \underline{16x - 32} \\ 0 \end{array}$$

* Whether one quantity be divided by another, or *minus* the former by *minus* the latter, the result is the same; for $\frac{a}{b}$ is the same as $\frac{-a}{-b}$, whatever a and b may stand for; it is of course the same with multiplication: the factors a, b , give the same product as the factors $-a, -b$.

† This is evidently the same as $2x^4 + 0x^3 + 0x^2 + 0x - 32$; so that the -32 need not be brought down till we arrive at the concluding step of the work.

$$4. \quad \frac{4x^2 - 7x}{12x^2 - 21x^4} \frac{12x^3 - 13x^4 - 14x^3 + 8x^2 + 1(3x^3 + 2x^2 + 2 + \frac{14x + 1}{4x^2 - 7x})}{8x^4 - 14x^3}$$

$$\frac{8x^2 + 1}{8x^2 - 14x}$$

Remainder, $\frac{14x + 1}{4x^2 - 7x}$

EXAMPLES FOR EXERCISE.

- | | |
|---|--|
| 1. Divide $x^2 - 2x - 35$ by $x - 7$ | 2. Divide $x^2 - x - 12$ by $x + 3$ |
| 8. Divide $6x^2 + 13x + 6$ by $3x + 2$ | 4. Divide $12x^3 + 29x^2 + 14x$ by $3x^2 + 2x^*$ |
| 5. Divide $18x^3 - 33x^2 + 41x - 35$ by $3x^2 - 2x + 5$ | 6. Divide $x^4 - y^4$ by $x - y$ |
| 7. Divide $x^4 - ax^3 - 7ax^2 + 8a^2x - a^3$ by $x - a$. | 8. Divide $x^2 + (a + b)x + ab$ by $x + a$ |
| 9. Divide $8x^2y + 2x^3y - 2x^2 - 3x^2y + x$ by $4x^2y + 3xy - 1$ | |
| 10. Divide $x^6 - x^4 + x^2 - x^2 - 1$ by $x^2 + x - 1$ | |
| 11. Divide $3(2x^2 + 3)x^2 - 20x$ by $3(x - 1)x$ | 12. Divide $x^2 + px + q$ by $x - a$ |
| 13. Divide $x^4 + px^2 + qx + r$ by $x - a$ | |

[It is worthy of notice that in each of the last two examples, the final remainder is the very same as the dividend, when the x in it is removed and a is written instead.]

ON EXPONENTS, ROOTS, SURDS.

You have already been told (page 179) that there are two ways of indicating a root of a quantity: one way by means of the radical sign $\sqrt{\quad}$, placed before the quantity, and another by the introduction of a fraction, written in smaller character, over the right-hand corner of the quantity proposed—this corner fraction, you know, is called an *exponent* or *index*. The radical sign is used exclusively for roots; exponents are used alike for roots and for powers—thus, a^4 is the fourth power of a , and $\sqrt[4]{a}$ is the fourth root of a . But exponents or indices have a wider application still. As yet you have had to deal only with positive exponents; algebraists, however, have introduced negative exponents. I must give you some account of these—show you how they have arisen, and what meaning is attached to them.

Your attention has already been drawn to the fact (page 189) that when a quantity with an exponent denoting a power, is to be divided by the same quantity with a smaller exponent, the subtraction of the latter exponent from the former is all that is necessary; thus

$$\frac{a^5}{a^2} = a^{5-2} = a^3; \quad \frac{a^3}{a^2} = a^{3-2} = a^1 = a, \text{ \&c.}$$

Now, this mode of proceeding has suggested the extension of notation adverted to above, giving rise to such expressions as a^0 , a^{-1} , a^{-2} , &c.: thus, carrying out the foregoing principle, we have

$$\frac{a^1}{a^1} = a^{1-1} = a^0; \text{ but } \frac{a^1}{a^1} \text{ or } \frac{a}{a} = 1, \therefore a^0 = 1, \text{ a remarkable result.}$$

$$\text{In like manner, } \frac{a^0}{a^1} = a^{0-1} = a^{-1}; \text{ but } \frac{a^0}{a^1} = \frac{1}{a^1} \therefore a^{-1} = \frac{1}{a}$$

* In exercises in division, always expunge, before you begin the operation, whatever factor is obviously common to both dividend and divisor, as you would do if you had to deal with a fraction, the dividend being the numerator, and the divisor the denominator. In the example above, the factor x obviously enters all the terms of both dividend and divisor; it is therefore a useless encumbrance, and should be expunged; the division will then be $12x^2 + 29x + 14$ by $3x + 2$. Example 11 admits of a like simplification.

Similarly, $\frac{a^{-1}}{a^1} = a^{-1-1} = a^{-2}$; but $\frac{a^{-1}}{a} = \frac{1}{a^2}$, $\therefore a^{-2} = \frac{1}{a^2}$

And in the same way, $a^{-3} = \frac{1}{a^3}$, $a^{-4} = \frac{1}{a^4}$; and generally, $\frac{1}{a^n} = a^{-n}$; whatever whole number n may stand for. You thus see that without making any inquiry as to the particular values of m and n , you may always write $\frac{a^m}{a^n} = a^{m-n}$: if $m = 3$ and $n = 5$, then $\frac{a^3}{a^5} = a^{-2}$, which, as seen above, is only another way of writing $\frac{1}{a^2}$. I may here observe that *unity* or 1, divided by any quantity, is called the *reciprocal* of that quantity; thus, $\frac{1}{a^2}$ is the reciprocal of a^2 ; $\frac{1}{a}$ is the reciprocal of a ; and so on. And any quantity with a *negative exponent* stands for the reciprocal of that quantity with a *positive exponent*; thus, $a^{-\frac{1}{2}}$ means $\frac{1}{a^{\frac{1}{2}}}$, $a^{-\frac{1}{3}}$ means $\frac{1}{a^{\frac{1}{3}}}$, &c.; so that not only powers and roots, but also the reciprocals of powers and roots, are represented by exponents.

In the instances hitherto given of *fractional* exponents, the numerator of the fraction has always been *unit* or 1, the notation implying a *root* of the quantity to which the exponent is attached. When a *power* of this root is to be indicated, or the *root* of a power, the somewhat cumbersome form used at page 179—namely, $(a^4)^{\frac{1}{3}}$ for the third root of the fourth power of a , or $(a^{\frac{1}{3}})^4$ for the fourth power of the third root of a , is not the notation usually employed; a *single fraction* is made to serve; the *numerator* of the fraction denoting the *power*, and the *denominator* the *root*; thus $a^{\frac{4}{3}}$ would stand indifferently for the third root of the fourth power of a , or for the fourth power of the third root of a ; whether you regard the power to be taken first and then the root, or the root first and then the power, is of no moment; the *result* is the same. Thus suppose you have $8^{\frac{2}{3}}$; if you regard this as the second power (or square) of the cube or third root of 8, then since the cube root of 8 is 2 (seeing that $2^3 = 8$), you have $8^{\frac{2}{3}} = 2^2 = 4$; but if, on the contrary, you regard it as the cube root of the square of 8, then since the square of 8 is 64, you have $8^{\frac{2}{3}} = 64^{\frac{1}{3}} = 4$, as before (seeing that $4^3 = 64$). Or take the more general case noticed above, namely, $a^{\frac{4}{3}}$. If you regard this as $(a^4)^{\frac{1}{3}}$, you consider it the same as $(aaaa)^{\frac{1}{3}}$. And if you regard $a^{\frac{4}{3}}$ as $(a^{\frac{1}{3}})^4$, you consider it the same as $a^{\frac{1}{3}}a^{\frac{1}{3}}a^{\frac{1}{3}}a^{\frac{1}{3}}$. Now these two results differ only in appearance; for let $a^{\frac{1}{3}}$, that is, the cube root of a , whatever it be, be denoted by c ; then, of course, a is c^3 ; and it is plain that $(c^3c^3c^3c^3)^{\frac{1}{3}} = cccc$; the first side of this *identical equation* being the former of the above expressions, and the second side the latter. It is therefore matter of choice with you whether you call $a^{\frac{m}{n}}$ the n th root of a^m , or the m th power of $a^{\frac{1}{n}}$; and, in actual numbers, you may take whichever of these two views you find to be most convenient for the purposes of arithmetic.

Whenever an exponent in the form of a fraction is such that the numerator and denominator are *the same*, as in $a^{\frac{m}{m}}$, that exponent may be replaced by unit, or 1; because if the m th power of any quantity be taken, and then the m th root of the result, the original quantity (in this case a) is of course brought back again.

The second operation merely undoes what the first does; the two operations mutually destroy one another, and are \therefore of no effect, so that $a^m = a$. In consequence of this, such an expression as $a^{\frac{p}{q} \cdot \frac{m}{n}}$ is the same as $a^{\frac{p}{q}}$, since the former means the m th root of the m th power of *this*. You see, therefore, that when a fractional exponent has a factor common to both numerator and denominator, the common factor may be expunged. All that is said above applies as well to negative as to positive exponents, as each expression there considered may be equally regarded as the denominator of a fraction whose numerator is 1. The following is a view of the principal operations with exponents when they are attached to the same quantity:—

$$a^{\frac{pm}{qn}} = a^{\frac{p}{q}}; \text{ for example, } a^{\frac{8}{3}} = a^{\frac{4}{3} \cdot 2} = a^{\frac{4}{3}}; a^{\frac{4}{2}} = a^{2 \cdot \frac{2}{2}} = a^2; \text{ \&c.}$$

$$a^m \times a^n = a^{m+n}; \text{ for example, } a^3 \times a^2 = a^5; a^{\frac{1}{2}} \times a^{\frac{1}{2}} = a^{\frac{1}{2} + \frac{1}{2}} = a^1$$

$$a^m \div a^n = a^{m-n}; \text{ for example, } a^5 \div a^2 = a^3; a^{\frac{1}{2}} \div a^{\frac{1}{3}} = a^{\frac{1}{2} - \frac{1}{3}} = a^{\frac{1}{6}}$$

$$(a^m)^n = a^{mn}; \text{ for example, } (a^3)^2 = a^6; (a^{\frac{1}{2}})^3 = a^{\frac{3}{2}}; \text{ \&c.}$$

That is—

To MULTIPLY. *Add the exponents.*

To DIVIDE. *Subtract the exp. of divisor from exp. of dividend.*

To EXPRESS A POWER OR ROOT. *Multiply the exp. of the quantity by the exp. of the power or root of it which is proposed.*

In *evolution*, or the *extraction of roots*, there are some particulars respecting *signs* which require to be especially mentioned. In *involution*, or the raising of powers, you have seen that the sign of the result is always fixed by the rule of signs; it is not so in the reverse operation of extraction. For instance, the square of 4 is 16, the 16 being *plus*, whether the 4 be *plus* or *minus*; but the square root of 16 is *ambiguous* as to sign; the numerical value of the root is, of course, 4; but we have as much right to prefix a *minus* to this 4 as a *plus*; since $(-4)^2$ and 4^2 are equally 16. Hence $\sqrt{16} = \pm 4$; that is *plus* or *minus* 4. And there is a like ambiguity, as to sign, in every *even root* of a positive quantity; because the corresponding *even power* of that root would be the same whether a + or a - be prefixed to it: $\sqrt[4]{4}$ or $4^{\frac{1}{4}}$ is ± 2 ; $\sqrt[5]{16}$ or $16^{\frac{1}{5}}$ is ± 2 , and so on. As to an *even root* of a *negative* quantity, the thing is *impossible*. Such an expression as $\sqrt{-4}$ implies an impossible operation; for you know the *square root* of a quantity is that which, when squared, reproduces the quantity. Now a quantity squared, whether its sign be + or -, is always +; it is impossible \therefore that -4 can be the *square* of anything. Such expressions as $\sqrt{-4}$, $\sqrt{-9}$, $\sqrt{-1}$, &c., are \therefore called *imaginary* or *impossible* quantities; and they answer this purpose, namely, whenever they occur in the solution of a problem, you may take it as a sure indication that the problem implies some impossibility or contradiction. You thus see that the numbers of arithmetic, when introduced into algebra, divide themselves not only into *positive* and *negative*, but also into *real* and *imaginary*. Real numbers, too, are separated into two classes; namely, *rational* and *irrational*, or *surd*. The following are examples of *surds*; namely, $\sqrt{2}$, $\sqrt{3}$, $\sqrt{5}$, $\sqrt{7}$, $\sqrt{10}$, &c. *Surds*, you see, are *roots*; but roots of numbers that are not themselves the reverse *powers*: 3, 5, 7, 10, &c. are not *squares*; they have \therefore no *exact square roots*. Nevertheless, either of these numbers being proposed, we can

always find another number such that its square shall approach as near to the proposed number as we please; we can thus *approximate*, as it is called, to the square root of 3, or 5, or 7, &c., to any degree of nearness, as you know from your recollection of the operation for the square root in decimal arithmetic. There is thus a marked difference between $\sqrt{3}$ and $\sqrt{-3}$; the value of the former can be approximated to, to any degree of nearness: the value of the latter cannot be approached to at all—it has no existence. It may be noticed, however, that both *surds* and *imaginary quantities* may sometimes be a little simplified in appearance. Thus, $\sqrt{8} = \sqrt{4 \cdot 2} = 2\sqrt{2}$; $\sqrt{27} = \sqrt{9 \cdot 3} = 3\sqrt{3}$; $\sqrt{-8} = \sqrt{-2 \cdot 4} = 2\sqrt{-2}$; $\sqrt{-27} = \sqrt{-3 \cdot 9} = 3\sqrt{-3}$; $\sqrt{-4} = 2\sqrt{-1}$, &c. This can always be done when the number under $\sqrt{\quad}$ can be separated into two factors, one of which is a square; the operation implied in $\sqrt{\quad}$ being actually performed on this square, it becomes freed from the radical, which then applies only to the other factor. You should never leave under the radical, in any final result, a factor upon which the operation indicated by the radical can be actually performed. Thus, such an expression as $\sqrt{a^2b}$ should be reduced to the simpler form $a\sqrt{b}$. In like manner, $\sqrt[3]{a^3x^3y} = ax\sqrt[3]{y}$; $\sqrt{16ax^3} = \sqrt{8 \cdot 2ax^3} = 2x\sqrt{2a}$; and so on. It is customary to call such forms as \sqrt{b} , $\sqrt[3]{y}$, $\sqrt[3]{2a}$, &c., in which the operation under the radical cannot be performed, *algebraical surds*; although, if the letters were interpreted, it is quite possible that the algebraical surd might prove a *rational number*. Thus, if b were 4, then \sqrt{b} would be ± 2 ; which is rational, though ambiguous as to sign.

I shall now give you a few examples on the *evolution* of simple quantities, or quantities consisting of but *one term*. You have been told (p. 184) that quantities consisting of *two terms* are called *binomials*; you will be prepared to expect, therefore, that those of *one term* are often called *monomials*, those of *three terms* *trinomials*, those of *four quadrinomials*; a quantity consisting of more terms comes under the general name of *polynomial*, or *multinomial*.

To extract a proposed root of a simple or monomial quantity.

RULE I. Write the root of the coefficient with its proper sign, remembering that an *odd* root, like an *odd* power of any quantity, has the *same sign* as that quantity; but that an *even* root of a *positive* quantity takes the *double sign* \pm .

2. Divide the exponent of each letter by the exponent of the radical; or, which is the same thing, multiply by the fractional index, by which the radical may be replaced; and the proposed root will be obtained.

1. $\sqrt{16a^4x} = 4a^2\sqrt{x}$, or $4a^2x^{\frac{1}{2}}$. Here the square root of the coefficient 16 is 4; the letters with their exponents are a^4x^1 , the index or exp. of the radical is 2; \therefore dividing the exponents by this, the letters of the result are $a^{\frac{4}{2}}x^{\frac{1}{2}} = a^2x^{\frac{1}{2}}$. Or replacing the radical

nents within the vinculum, by the exp. without, we have $4(a^4x^1)^{\frac{1}{2}} = 4a^2x^{\frac{1}{2}} = 4a^2\sqrt{x}$. The double sign is not placed before the 4: the reason is, that the extraction is not completed; \sqrt{x} is a still-unperformed operation, and the double sign is regarded as implied in $\sqrt{\quad}$.

$$2. \sqrt{9a^2x^2} = 3a^1x^1 = \pm 3ax$$

$$3. \sqrt{2a^2x^2} = \sqrt{2a^2}ax = a^1\sqrt{2}a$$

$$4. \sqrt{\quad}$$

It is to be observed that when an irrational or surd quantity occurs among the factors of a term, the letters composing that term are not arranged in alphabetical order

except when the surd is expressed by a fractional exponent; when it is denoted by the sign $\sqrt{\quad}$, it is always placed *last*, to prevent all mistake as to the extent of influence of this sign. If the result in the last ex. had been written $3\sqrt[3]{ab^2x}$, it would evidently have conveyed a wrong meaning; it is true this might have been remedied by marking the extent to which $\sqrt[3]{\quad}$ reaches by a bar-vinculum, thus $3\sqrt[3]{\overline{ab^2x}}$; but superfluous marks and signs are always to be avoided, so that the form $3x\sqrt[3]{ab^2}$ is to be preferred; a bar over ab^2 is not required, when it is understood that $\sqrt{\quad}$ covers, or extends to, *all* the factors which follow it. I have indeed myself put a bar over similar expressions at page 194, but I did so for fear that you should limit the influence of the radical; it is best omitted when there is no danger of such mistake being made.

6. $\frac{1}{\sqrt{a^2b^4}} = \frac{1}{ab^2\sqrt{a}}$ or $= a^{-\frac{1}{2}}b^{-2}$, or $= a^{-1}a^{-\frac{1}{2}}b^{-2}$. The first of these forms,

namely $\frac{1}{ab^2\sqrt{a}}$, is that which would, in general, be employed; negative indices, though of much importance in certain general investigations, being seldom used in particular expressions. But I must tell you that algebraists do not like to leave surd quantities in the denominators of fractions; for as I said before (page 183), they wish their final results to be in a form the best suited for arithmetical computation. Now suppose you had to compute $\frac{1}{\sqrt{a}}$, a being interpreted to you;—say $a = 11$. You would have first to

find the square root of 11, to several places of decimals; suppose four places were considered sufficient, you would then have $\frac{1}{\sqrt{a}} = \frac{1}{\sqrt{11}} = \frac{1}{3.3166}$, and the division here indicated would have to be performed. But instead of taking this course, let numerator and denominator of $\frac{1}{\sqrt{a}}$ be multiplied by \sqrt{a} , which, from the first principles of arith-

metical fractions, you know to be allowable, $\frac{1}{\sqrt{a}}$, would thus be changed into $\frac{\sqrt{a}}{a}$;

and you would have to compute $\frac{\sqrt{a}}{a} = \frac{\sqrt{11}}{11} = \frac{3.3166}{11}$. You can now, in a moment, pronounce the final result to be .3015..., which of course, is the same as the result of $\frac{1}{3.3166}$, but it would have taken you much longer to discover it. Ex. 6 therefore should not be left in the state in which I have left it above; the steps should be —

$$\frac{1}{\sqrt{a^2b^4}} = \frac{1}{ab^2\sqrt{a}} = \frac{\sqrt{a}}{ab^2a} = \frac{\sqrt{a}}{a^2b^2}.$$

EXAMPLES FOR EXERCISE.

- | | | | |
|-----------------------------------|--------------------------------------|---------------------------------------|------------------------------------|
| 1. $\sqrt{a^2x^6y}$ | 2. $\sqrt[4]{2^4a^4b^8}$ | 3. $\sqrt[3]{8a^3x^6z}$ | 4. $\sqrt{-8a^4x^2y^2}$ |
| 5. $\sqrt{-2m^4y^2z^2}$ | 6. $\sqrt{8a^2y^4x}$ | 7. $(a^2b^3x^4)^{\frac{1}{2}}$ | 8. $\sqrt{x^2y^2z^2}$ |
| 9. $\sqrt{\frac{a^2}{bx^2}}$ | 10. $\sqrt{a^2x^{-4}}$ | 11. $\sqrt{a^{-3}x^{-4}y^5}$ | 12. $\sqrt{\frac{8a^2}{27x^2y^4}}$ |
| 13. $(-8a^2x^2y^6)^{\frac{1}{2}}$ | 14. $(9b^4x^2y^2)^{-\frac{1}{2}}$ | 15. $x^2(81a^6y^4z^2)^{-\frac{1}{2}}$ | |
| 16. $\sqrt[3]{-16a^2x^4y^{-9}}$ | 17. $(32a^{-4}x^2y^4)^{\frac{1}{2}}$ | 18. $(82a^{-4}x^2y^4)^{-\frac{1}{2}}$ | |

FRACTIONS.

Algebraic fractions are treated exactly the same as numerical fractions in common arithmetic; the only difference being in the symbols, not in the operations performed.

To reduce a mixed quantity to an improper fraction.

A quantity is called a mixed quantity when it is partly integral and partly fractional; such a quantity may always be changed into an equivalent one, wholly fractional in form; the result is called an *improper* fraction, as well in arithmetic as in algebra, because an integral quantity is really absorbed into it. The rule for reducing a quantity partly integral and partly fractional to a form wholly fractional, is as follows:

RULE.—Multiply the integral part by the denominator of the fractional part; connect the product with the numerator, by the sign of that numerator, and place the denominator underneath.

1. $a + \frac{x}{b} = \frac{av+x}{b}$. Here nothing more is done than replacing a by $\frac{av}{b}$, which is of course equivalent to it. The integral part a is converted into a fractional form, by multiplying it by the *given* denominator b , and dividing the result by the same letter, thus destroying the effect of the multiplication. And this is all that is done in operations of this kind.

$$2. a + b - \frac{c}{x} = \frac{(a+b)x-c}{x}$$

$$3. a - \frac{b}{x-y} = \frac{a(x-y)-b}{x-y}$$

$$4. a - \frac{x-y}{b} = \frac{ab-x+y}{b}$$

$$5. 2 + \frac{x^2+y^2}{xy} = \frac{2xy+x^2+y^2}{xy} = \frac{(x+y)^2}{xy} \text{ (see p. 182).}$$

$$6. \frac{(x+y)^2}{xy} - 2 = \frac{(x-y)^2}{xy}$$

$$7. a + b + \frac{b^2}{a-b} = \frac{a^2}{a-b}$$

$$8. \sqrt{x} - \frac{x-1}{\sqrt{x}} = \frac{1}{\sqrt{x}} = \frac{\sqrt{x}}{x} \text{ (see p. 195).}$$

To reduce an improper fraction to a mixed quantity.

RULE.—Divide the numerator by the denominator, as far as the division can be carried, and to the quotient annex the *remainder* with the denominator underneath. If there be no remainder, the quotient, which will then be wholly integral, will be the complete value; showing that the so-called improper fraction is an integral quantity disguised under a fractional form.

This operation, you see, is nothing but that of *division*: the examples at page 191 serve as well as any to illustrate the present rule; but a few others may be added here.

$$1. \frac{12a^2-4a+3b}{4a} = 3a - 1 + \frac{3b}{4a}$$

$$2. \frac{a^2-x^2+1}{a-x} = a + x + \frac{1}{a-x}$$

$$3. \frac{4x^3-25x^2+20x+25}{x^2-7x+10} = x - 5 + \frac{x-5}{4x+3}$$

$$4. \frac{x^4-8x+7}{x^2-3x+2} = x^2+3x+7 + \frac{7x-7}{x^2-3x+2}$$

EXAMPLES FOR EXERCISE IN THE TWO PRECEDING RULES.

Prove that the following are IDENTICAL EQUATIONS:—

$$\begin{array}{lll}
 1. \quad a+x+\frac{x^2}{a-x}=\frac{a^2}{a-x} & 2. \quad 3-y-\frac{2-y^2}{3+y}=\frac{7}{3+y} & 3. \quad \left(\frac{b+c}{b-c}\right)^2-1=\frac{4bc}{(b-c)^2} \\
 4. \quad \frac{a^2+x^2}{a-x}=\frac{a^2+ax+x^2+\frac{2x^2}{a-x}}{a-x} & 5. \quad \frac{a^2-x^2}{a^2+ax+x^2}=a-x & 6. \quad x^2-a^2+\frac{x^4+a^4}{x^2+a^2}=\frac{2x^4}{x^2+a^2} \\
 7. \quad \frac{(x+y+z)(x+y-z)}{2xy}-1=\frac{x^2+y^2-z^2}{2xy} & 8. \quad \frac{(x+y+z)(x+y-z)}{2xy}-2=\frac{(x-y)^2-z^2}{2xy} \\
 9. \quad \frac{x^2+y^2-z^2}{2xy}-1=\frac{(x-y-z)(x-y+z)}{2xy} & 10. \quad x^2-3x-\frac{3x(3-x)}{x-2}=\frac{x\{(x-1)^2-4\}}{x-2}
 \end{array}$$

To reduce fractions to a common denominator.

Before fractions can be either added or subtracted they must be reduced to a common denominator. No two quantities can be actually added together, or subtracted the one from the other, so long as the denominations of the quantities are different. You cannot add 4 shillings to 2 pounds; you can only connect them together as distinct quantities, till both are brought to the same denomination. It is only then that they can be actually incorporated in one sum; 40s. and 4s. make 44s.; the 2 and the 4 make 6; but these are neither pounds nor shillings, and have no meaning in reference to the things proposed. A fraction, like a concrete quantity, denotes a stated number of things of a stated denomination; the number is expressed by the numerator, the denomination by the denominator; and \therefore so long as the denominators are different, two fractions can no more be added or subtracted than pounds and shillings. You see, therefore, that before fractions can be fitted for addition or subtraction, they must be prepared for these operations by a previous reduction of them to common denominators. The rule for this reduction is given below; it is founded upon the obvious principle that a fraction is not altered in value, though the numerator be multiplied by any quantity whatever, provided only that the denominator be multiplied by the same thing; since the new factor in the denominator just counteracts the influence of the same factor in the numerator; a multiplication, and then a division by the same thing, leaves the quantity operated upon, whatever it may be, virtually untouched.

RULE 1.—Multiply each numerator by the product of all the denominators except its own; the results will be the numerators of the changed fractions.

2. The product of all the denominators will be the denominator common to all the changed fractions.

This rule will effect the reduction of fractions to a common denominator in all cases; but sometimes the desired change may be brought about in an easier way. The common denominator, found by the rule, is evidently such that each of the proposed denominators is always a factor of it. It is the object of the rule to make sure of such a number in every case; but it often happens that a smaller number exists, such that each denominator is a factor of it; and whenever such smaller number can be discovered with little trouble, it is of course better to use it, than a larger number. The smallest number possible is called the least common multiple of the denominators; and a little examination of the denominators will often enable us to arrive at it very readily, as will be seen in some of the following examples:—1. $\frac{a}{x} + \frac{b}{y} + \frac{c}{z} = \frac{ayz}{xyz} + \frac{bxz}{xyz} + \frac{cxy}{xyz}$.

Here the three fractions on the right of the sign of equality are respectively the same, in value, as those on the left; and the denominator xyz is common to all.

$$2. \quad \frac{x+a}{2} + \frac{b}{3} + \frac{1}{5} = \frac{15(x+a)}{30} + \frac{10b}{30} + \frac{6}{30} \quad 3. \quad \frac{2x+3}{x} - \frac{5x+1}{3} = \frac{6x+9}{3x} - \frac{5x^2+x}{3x}$$

4. $\frac{2x+1}{6a} + \frac{5x}{4}$. Here it is plain that 12 is a number, and the *least* number, such that 6 and 4 are each a factor of it, \therefore 12a is the least common multiple of 6a and 4, so that the common denominator need be no higher than 12a; this 12a is the first denominator above multiplied by 2, \therefore multiplying the numerator also by 2, the changed fraction is $\frac{2(2x+1)}{12a}$. Again, the same 12a is the second denominator multiplied by 3a, \therefore multiplying the numerator also by 3a, the second changed fraction is $\frac{15ax}{12a}$; so that $\frac{2x+1}{6a} + \frac{5x}{4} = \frac{2(2x+1)}{12a} + \frac{15ax}{12a}$. By the *rule* the common denominator would have been twice as great.

5. $\frac{2x}{x^2-a^2} + \frac{3}{x+a}$. Here, since we know that $(x+a)(x-a) = x^2 - a^2$, the second fraction will be converted into one with a denominator the same as the first, by merely multiplying numerator and denominator of the second by $x-a$, \therefore the fractions are $\frac{2x}{x^2-a^2} + \frac{3(x-a)}{x^2-a^2}$.

6. $\frac{2x}{3a^2b^3} + \frac{x}{2a^3b^2} + \frac{5}{6ab}$. Here the *coefficient* of the common denominator is 6, the least number divisible by the coefficients 3, 2, and 6; the letters are a^3b^3 , the least quantity divisible by a^3b^3 , a^3b^2 , and ab , \therefore the changed fractions are $\frac{4ax}{6a^3b^3} + \frac{3bx}{6a^3b^3} + \frac{5a^2b^2}{6a^3b^3}$; each fraction *here* differing from that which it replaces only in appearance,—it is the original fraction with numerator and denominator multiplied by the same thing.

It will not be necessary that I should give you any exercises expressly for practice in the preceding rule. The examples furnished to you in addition and subtraction,—the rule for which I am now about to give, will equally afford practice in the foregoing operation; for, as you have already seen, all fractions must have a common denominator before they can be either added or subtracted. I shall therefore at once proceed to

Addition and Subtraction of Fractions.

RULE—Addition.—Reduce the fractions to equivalent ones with a common denominator, which place under the *sum* of the changed numerators.

Subtraction.—Reduce the fractions to equivalent ones with a common denominator, which place under the *difference* of the changed numerators.

$$\begin{array}{ll}
 1. \quad \frac{x+a}{2} + \frac{b}{3} + \frac{1}{5} = \frac{15(x+a)+10b+6}{30} & 2. \quad \frac{2x+3}{x} - \frac{5x+1}{3} = \frac{9+5x-5x^2}{3x} = \frac{9+5x(1-x)}{3x} \\
 3. \quad \frac{a+b}{a-b} + \frac{a-b}{a+b} = \frac{(a+b)^2 + (a-b)^2}{a^2-b^2} = \frac{2(a^2+b^2)}{a^2-b^2} & 4. \quad \frac{a+b}{a-b} - \frac{a-b}{a+b} = \frac{(a+b)^2 - (a-b)^2}{a^2-b^2} = \frac{4ab}{a^2-b^2} \\
 5. \quad \frac{2x-3}{3x} - \frac{4x+2}{3} = \frac{2x-3-(4x+2)x}{3x} = \frac{4x^2+3}{3x} & 6. \quad \frac{1}{a^n} + \frac{1}{a^{n+1}} = \frac{a+1}{a^{n+1}} \\
 7. \quad 1 - \frac{x^2-y^2}{x^2+y^2} = \frac{x^2+y^2-(x^2-y^2)}{x^2+y^2} = \frac{2y^2}{x^2+y^2} & 8. \quad \frac{x^2+y^2}{xy} - 2 = \frac{x^2+y^2-2xy}{xy} = \frac{(x-y)^2}{xy}
 \end{array}$$

In this example, as well as in the preceding, an *integer* occurs in connection with a

fraction; and it may here be noticed, that an integer may always be put in the form of a fraction by simply giving to it 1 for denominator: thus, in the present example, the 2 may be regarded as $\frac{2}{1}$.

EXAMPLES FOR EXERCISE.

NOTE.—It sometimes happens that the sum or difference of fractions is a fraction such that numerator and denominator have a factor common to both. Such common factors should always be expunged from the final result, whenever they are seen to enter: they only serve to give to the fraction an appearance unnecessarily complicated. A fraction thus deprived of all common factors in numerator and denominator is said to be in its *lowest terms*, the numerator and denominator being called the *terms of the fraction*.

1. $\frac{2x-5}{3} + \frac{x-1}{2x}$
2. $\frac{x}{x-3} + \frac{x}{x+3}$
3. $\frac{10x-9}{8} - \frac{3x-6}{7}$
4. $\frac{2x-8}{7x} - \frac{x-5}{8x}$
5. $\frac{x-a}{x^2-ax+a^2} + \frac{1}{x+a}$
6. $1 - \frac{x-a}{x+a}$
7. $\frac{a^2x}{xy} - \frac{bx}{yz}$
8. $\frac{1}{x} + \frac{1}{x^2} - \frac{1}{x^3}$
9. $\frac{1}{2x-a} + \frac{1}{2x+a} - \frac{4x^2}{4x^2-a^2}$
10. $\frac{1+x}{1+x+x^2} - \frac{1-x}{1-x+x^2}$
11. $\frac{a^2+b^2}{a^2-b^2} + \frac{a+b}{a-b} - \frac{a-b}{a+b} + 2$
12. $\frac{y}{y-3} - \frac{y-3}{y} + \frac{y}{y+3} - \frac{y+3}{y}$
13. Show that $\frac{x}{x+y} + \frac{y}{x-y} = \frac{x}{x-y} - \frac{y}{x+y}$
14. $\frac{x}{x+z} - \frac{y}{y+z} = \frac{z}{y+z} - \frac{z}{x+z}$

MULTIPLICATION OF FRACTIONS.

If a fraction $\frac{a}{b}$ is to be multiplied by an integer c , we have to take a things, of denomination b , c times; the product is therefore $\frac{ac}{b}$; that is, ac of those things, just as if we had to multiply a pounds, or a ounces, by c , the product would be ac of those pounds or ounces. But, if instead of c , we are to multiply only by the d th part of c , then, of course, the product will be only the d th part of the former; that is, it will be $\frac{ac}{b} \div d$, or $\frac{ac}{bd}$. $\therefore \frac{a}{b} \times \frac{c}{d} = \frac{ac}{bd}$. This suggests the rule, which is as follows:

RULE 1.—Multiply the numerators together, the result will be the *numerator of the product*.

2. Multiply the denominators together; the result will be the *denominator of the product*.

NOTE.—Before performing the operation, see whether either of the fractions can be reduced to *lower terms*; if so, reduce the fraction. And after the operation, see whether a like reduction can be easily made in the result; if so, reduce accordingly. (See preceding NOTE.)

It is of importance in dealing with algebraic fractions, that you should always keep in remembrance the factors of such expressions as a^2-b^2 , a^4-b^4 , a^6-b^6 , &c.; as also of $a^2+2ab+b^2$, and $a^2-2ab+b^2$. You have seen at page 182, that the *difference* of the squares of two quantities is the *product of the sum and difference* of the quantities; so that $a^2-b^2=(a+b)(a-b)$; $a^4-b^4=(a^2+b^2)(a^2-b^2)$; $a^6-b^6=(a^3+b^3)(a^3-b^3)$; &c.; also that $a^2+2ab+b^2=(a+b)(a+b)$, or $(a+b)^2$; and that $a^2-2ab+b^2=(a-b)(a-b)$, or $(a-b)^2$. You will have very frequent occasion to apply these truths in operations with fractions: I repeat them here, that you may have full warning of what you will be expected to remember.

1. $\frac{3x}{x-1} \times \frac{2x}{x+1} = \frac{6x^2}{(x-1)(x+1)} = \frac{6x^2}{(x-1)^2}$. 2. $\frac{3x^2-x}{5} \times \frac{10}{2x^2-3x}$. Here it is easy to see that the factor x will enter into both numerator and denominator of the product: it is useless to allow it thus to enter, and afterwards to expunge it; we therefore silently suppress or *cancel* this common factor, and so preclude its appearance altogether. In like manner, the factor 5 , foreseen to enter numerator and denominator of the product, is, at the outset, *cancelled*; so that, before actually multiplying, we imagine the factors changed for $\frac{3x-1}{1} \times \frac{2}{2x-3} = \frac{2(3x-1)}{2x-3}$, the product in its lowest terms.

You are aware that all this is exactly what we should do in common arithmetic: you have, in fact, nothing to learn in the management of algebraic fractions that is not equally necessary in the fractions of pure arithmetic. Suppose the example here commented upon had been $\frac{3x^2-x}{5} \times \frac{10}{2x^2-4x}$; then, seeing that the second fraction has the factor 2 common to numerator and denominator, you would here, as in arithmetic, expunge or cancel that factor; and, to make each step perfectly plain, might write—

$$\frac{3x^2-x}{5} \times \frac{10}{2x^2-4x} = \frac{3x^2-x}{5} \times \frac{5}{x^2-2x} = \frac{3x-1}{1} \times \frac{1}{x-2} = \frac{3x-1}{x-2}.$$

EXAMPLES FOR EXERCISE.

1. $\frac{4x}{7} \times \frac{5}{9x}$
2. $\frac{4x+1}{3} \times \frac{6x}{7}$
3. $\frac{4x+2}{3} \times \frac{5x}{2x+1}$
4. $\frac{2x-1}{x+2} \times \frac{3x+1}{x-3}$
5. $\frac{a+b}{x} \times \frac{b^2x}{a^2-b^2}$
6. $\frac{x^2-a^2x}{a^2} \times \frac{x}{ax-a^2}$
7. $\frac{x^m}{y^m} \times \frac{x^m}{y^m}$
8. $\frac{x^n}{y^m} \times \frac{y^m}{x^m}$
9. $\frac{3\sqrt{x}}{y} \times \frac{2y^2}{5\sqrt{x}}$
10. $\frac{x^2-4a^2}{x-a} \times \frac{x^2-a^2}{x+2a}$
11. $\frac{2x}{7} \times \frac{4x}{9} \times \frac{7}{4x} \times \frac{9x}{5}$
12. $\frac{4x+2}{3} \times \frac{5x}{2x+1} \times \frac{9x-8}{x}$
13. $\frac{(x-y)^2}{x^2-y^2} \times \frac{x+y}{x-y}$
14. $\frac{(x-y)^2}{x^4-y^4} \times \frac{x+y}{x-y}$
15. $(a-\frac{b^2}{a}) (\frac{a}{b} + \frac{b}{a})$

DIVISION OF FRACTIONS.

If a fraction $\frac{a}{b}$ is to be divided by an integer c , the result is of course $\frac{a}{bc}$; but if it is to be divided, not by c , but by only the d th part of c , that is by $\frac{c}{d}$; then the quotient will be d times the former quotient, as is obvious; that is to say, the quotient will be $\frac{a}{bc} \times d$, or $\frac{ad}{bc}$. Hence division is converted into multiplication, as directed in the following rule:—

RULE.—Invert the terms of the *divisor*, or turn it upside down, and proceed as in multiplication.

1. $\frac{3x-2}{2x} \div \frac{5x+1}{7x} = \frac{3x-2}{2x} \times \frac{7x}{5x+1} = \frac{7(3x-2)}{2(5x+1)}$
2. $\frac{x^4-y^4}{(x-y)^2} \div \frac{x^2+xy}{x-y} = \frac{x^4-y^4}{(x-y)^2} \times \frac{x-y}{x(x+y)} = \frac{(x^2+y^2)(x^2-y^2)}{x-y} \times \frac{1}{x(x+y)} = \frac{(x^2+y^2)(x^2-y^2)}{x^2-y^2} \times \frac{1}{x(x+y)} = \frac{x^2+y^2}{x(x+y)}$
3. $(\frac{a^2}{x} - \frac{x^3}{a^3}) \div (\frac{a}{x} + \frac{x}{a}) = \frac{a^4-x^4}{a^3x} \times \frac{ax}{a^2+x^2} = \frac{a^2-x^2}{a}$

EXAMPLES FOR EXERCISE.

NOTE.—Before inverting the divisor, you may always expunge factors common to either both numerators, or to both denominators: thus, the x in the denominators of example 1, last page, might have been omitted, as also $x-y$ in each denominator of example 2.

1. $\frac{x}{x-2} \div \frac{x-1}{x^2+2}$

2. $\frac{a+1}{a} \div \frac{a^2-1}{a}$

3. $\frac{x^2-9}{6} \div \frac{x+3}{4}$

4. $\frac{6x^2-2x}{4-x^2} \div \frac{x^2}{2+x}$

5. $\frac{9x^2-4y^2}{x+y} \div \frac{3x-2y}{x^2-y^2}$

6. $\frac{x^2-y^2}{x^2-2xy+y^2} \div \frac{x^2+xy}{x-y}$

At page 174 a rule was given for the solution of a simple equation, and several examples were proposed to show its practical application. These examples, however, were selected with a view to your acquaintance with the operations of algebra at that stage of your progress. You are now, I think, qualified to attempt equations of a higher order of difficulty, and to understand and apply the following more general rule.

GENERAL RULE for the solution of a simple equation with one unknown quantity.

1. Clear the equation of fractions, if there be any. This may be done by multiplying each numerator by all the denominators except its own; or by taking a common multiple of the denominators and then multiplying each numerator by this multiple, after suppressing that factor in it which is equal to the denominator.

2. Clear the equation of radical signs, if there be any. This is done by causing the quantity under the radical we wish to remove to stand alone on one side of the equation, and then performing the operation the reverse of that indicated by the radical, on both sides of the equation. Thus, if the radical be $\sqrt{\quad}$, we must square both sides; if it be $\sqrt[3]{\quad}$, we must cube both sides; and so on. This reverse operation evidently disengages the quantity from the radical; if two radicals enter, the operation must be repeated in reference to the second radical. Transposing, collecting, &c., are sufficiently explained in the former rule. It need only be added here that the example itself must suggest the order in which the precepts given in either rule should follow one another.

1. $\frac{x}{5} + \frac{x}{4} = \frac{x}{2} - \frac{x}{3} + 17$. Here, if each numerator be multiplied by the product of the denominators of all the other fractions (regarding 17 as $\frac{17}{1}$), we shall have $24x + 30x = 60x - 40x + 2040$, $\therefore 24x + 30x + 40x - 60x = 2040$; that is, $34x = 2040$, $\therefore x = \frac{2040}{34} = 60$.

But if we take the least common multiple of 5, 4, 2, 3, which is easily seen to be 60, we shall have to multiply the first numerator by $\frac{60}{5}$ or 12, the second by $\frac{60}{4}$ or 15, the third by $\frac{60}{2}$ or 30, the fourth by $\frac{60}{3}$ or 20, and the last (17) by $\frac{60}{1}$ or 60. The equation cleared of fractions in this way will be—

$$12x + 15x = 30x - 20x + 1020, \therefore 12x + 15x + 20x - 30x = 1020.$$

$$\text{That is, } 17x = 1020, \therefore x = \frac{1020}{17} = 60.$$

It is plain that, whichever method be used, the equation free from fractions always arises from multiplying both sides of the original equation by the same quantity; thus,

in the first way, each side is multiplied by 120, the product of the denominators; in the second way, each side is multiplied by 60, the least common multiple of the denominators.

2. $x + \sqrt{6x+x^2} = 3$. Transposing the x , agreeably to precept 2, of the rule, $\sqrt{6x+x^2} = 3-x$; and squaring both sides, $6x+x^2 = 9-6x+x^2$

$$\therefore 6x = 9 - 6x, \therefore 12x = 9, \therefore x = \frac{9}{12} = \frac{3}{4}.$$

3. $\sqrt{x+7} - \sqrt{x} = 1$. Transposing, $\sqrt{x+7} = \sqrt{x} + 1$.

Squaring both sides, $x+7 = x+2\sqrt{x}+1$. Transposing again, to get the radical *alone* on one side,

$$x-x+7-1 = 2\sqrt{x}, \therefore 3 = \sqrt{x}, \therefore (\text{squaring}) 9 = x.$$

4. $\frac{1}{a^2-x^2} - a = \frac{ax}{a-x} + \frac{a}{a+x}$. Here it is evident that $(a-x)(a+x)$, or a^2-x^2 is the least common multiple of the denominators.

$$\therefore 1 - a(a^2-x^2) = ax(a+x) + a(a-x),$$

that is $1 - a^3 + ax^2 = a^2x + ax^2 + a^2 - ax$. Transposing the unknown terms to the left, $\therefore ax - a^2x = a^2 + a^2 - 1$, that is $(1-a)ax = a^2 + a^2 - 1$.

$$\therefore x = \frac{a^2 + a^2 - 1}{(1-a)a}, \text{ or } \frac{(a+1)a^2 - 1}{(1-a)a}.$$

As already remarked at page 190, we may if we please always *change the signs* of numerator and denominator of a fraction, so that it would be equally correct to write the preceding expression for x thus: $x = \frac{1 - (a+1)a^2}{(a-1)a}$.

5. $\sqrt{a+x} + \sqrt{x} + b = c$. Transposing, $\sqrt{a+x} = c - b - \sqrt{x}$.

$$\text{Squaring, } a+x = (c-b)^2 - 2(c-b)\sqrt{x} + x.$$

$$\text{Transposing, } 2(c-b)\sqrt{x} = (c-b)^2 - a.$$

$$\text{Squaring, } 4(c-b)^2x = \{(c-b)^2 - a\}^2.$$

$$\therefore x = \left\{ \frac{(c-b)^2 - a}{2(c-b)} \right\}^2.$$

This example is in appearance difficult, but in reality it is easy. If you look at the operations actually *performed*, you will see that they are very trifling; the work is for the most part merely *indicated*, not *executed*; and such, in general, is the case when we have to deal exclusively with *literal*, and not with *numerical* quantities. The work of an algebraical problem is usually the greater, as the merely numerical operations are greater; because these must be actually performed it is the *arithmetic*, not the algebra, that occasions the labour. An example purely algebraical, like that above, requires only a little address in the deduction of one step from another; a little caution in the management of signs, and some care in *indicating* processes, which arithmetic must *perform* when the symbols are interpreted by numbers. It is not easy, however, to embody in a *rule* all the expedients and artifices which may with advantage be resorted to in the solution of a simple equation; these must be acquired by *observation* and experience, by the exercise of your own ingenuity, and the suggestions of common sense. A little thought and reflection will often do more for you than the most elaborate *rule*. The following example will serve to illustrate these remarks:—

6. $\frac{\sqrt{a^2+x^2} + x}{\sqrt{a^2+x^2} - x} = \frac{b}{c}$. In this example the removal of the radicals is evidently

the first thing we should try to effect; and it is easy to see that if we were to attempt this by implicitly following the precepts in the rule, we should soon have to deal with complicated expressions. Let us try to evade these by a little ingenuity. You see that if we were at liberty to subtract the denominator of the first member from the numerator, the upper radical would be removed at once: this suggests the subtracting 1 from each side, we therefore make the following the first step, namely—

$$\frac{\sqrt{a^2 + x^2} + x}{\sqrt{a^2 + x^2} - x} - 1 = \frac{b}{c} - 1; \text{ that is, } \frac{2x}{\sqrt{b^2 + x^2} - x} = \frac{b-c}{c}$$

And as it is in general less inconvenient to have a radical in the numerator than in the denominator of a fraction, we shall take the reciprocals of these fractions, that is, shall simply turn them upside down, writing the equation thus—

$$\frac{\sqrt{a^2 + x^2} - x}{2x} = \frac{c}{b-c} \therefore \sqrt{a^2 + x^2} = \left(\frac{2c}{b-c} + 1\right)x = \frac{b+c}{b-c}x \dots [A]$$

$$\therefore \text{squaring each side, } a^2 + x^2 = \left(\frac{b+c}{b-c}\right)^2 x^2 \therefore \frac{a^2}{x^2} + 1 = \left(\frac{b+c}{b-c}\right)^2$$

$$\therefore \frac{a^2}{x^2} = \left(\frac{b+c}{b-c}\right)^2 - 1 = \frac{4bc}{(b-c)^2} \therefore \frac{x^2}{a^2} = \frac{(b-c)^2}{4bc} \therefore x = \frac{a(b-c)}{2\sqrt{bc}}, \text{ or } = \frac{a(b-c)\sqrt{bc}}{2bc}$$

The step marked [A] may be reached a little differently by help of a property of two equal fractions, which you will do well to remember, and apply in examples like that above. Let $\frac{p}{q}$, $\frac{b}{c}$ be two equal fractions ($\frac{p}{q}$ may stand for the first member of the given equation above); then subtracting 1 from each, we have—

$$\frac{p-q}{q} = \frac{b-c}{c}$$

Also, adding 1 to each, we have—

$$\frac{p+q}{q} = \frac{b+c}{c}$$

Now divide these results by the former, and we get—

$$\frac{p+q}{p-q} = \frac{b+c}{b-c}$$

By applying this property to the given equation, we get at once—

$$\frac{\sqrt{a^2 + x^2} - x}{x} = \frac{b+c}{b-c}, \text{ and thence } \sqrt{a^2 + x^2} = \frac{b+c}{b-c}x$$

EXAMPLES FOR EXERCISE.

NOTE.—Examples 8, 9, 10, 11, and 16, have been selected with a view to the application of the principle just explained. Remember, in ex. 15, that *sum*. \times *diff.* = *diff.* of squares.

1. $\frac{2x}{5} + \frac{x}{2} = 22 + \frac{x}{6}$

2. $\frac{x}{2} + \frac{x}{9} + \frac{x}{4} = 6\frac{1}{2}$

3. $\frac{x}{2} - \frac{x}{4} = \frac{x}{8} - \frac{x}{6} + 1$

4. $\frac{18+x}{x} = \frac{6}{x} + 5$

5. $21 + \frac{3x-11}{16} = \frac{5(x-1)}{8} + \frac{97-7x}{2}$

6. $\sqrt{x^2+7} + x = 7$

7. $\sqrt{x-a} - b = 0$

8. $\frac{\sqrt{x+2}}{\sqrt{x-2}} = \frac{3}{2}$

9. $\frac{\sqrt{x+28}}{\sqrt{x+4}} = \frac{\sqrt{x+36}}{\sqrt{x+6}}$

10. $\frac{\sqrt{x+2a}}{\sqrt{x+b}} = \frac{\sqrt{x+4a}}{\sqrt{x+3b}}$

11. $\frac{\sqrt{ax-a}}{\sqrt{ax+a}} = \frac{3\sqrt{ax-2a}}{3\sqrt{ax+5a}}$

12. $\sqrt{(x-24)} = \sqrt{x-2}$

13. $\sqrt{(4x+21)} = 2\sqrt{x+1}$

14. $\sqrt[3]{(2x+3)}=3$

15. $\frac{5x-9}{\sqrt{5x+3}} = \frac{\sqrt{6x-1}}{2}$

16. $\frac{\sqrt{x+1}-\sqrt{x-1}}{\sqrt{x+1}+\sqrt{x-1}} = \frac{1}{2}$

Simple equations with two unknown quantities.

There are *three* methods of solving a pair of simple equations containing two unknown quantities. I shall illustrate them by an example:—

1. Find the values of x and y in the equations, $\begin{cases} 2x + 5y = 23, \\ 3x - 2y = 6. \end{cases}$

From the first equa., by trans., $2x = 23 - 5y \therefore x = \frac{23 - 5y}{2}$.

From the second equa., by trans., $3x = 6 + 2y \therefore x = \frac{6 + 2y}{3}$.

Equating these two different expressions for x , we have $\frac{23 - 5y}{2} = \frac{6 + 2y}{3}$. (clearing)

$69 - 15y = 12 + 4y \therefore$ trans. $- 19y = - 57 \therefore y = 3$. Substituting this value for y in either of the expressions for x , the second, for instance, we have $x = \frac{6 + 6}{3} = 4 \therefore x = 4, y = 3$. This method, you see, consists in equating the expressions for the *same* unknown quantity, as deduced from the two equations.

2. Having found an expression for x from *one* of the equations, as, for instance, $x = \frac{6 + 2y}{3}$, substitute it for x in the *other* equation, and we get $\frac{2(6 + 2y)}{3} + 5y = 23; \therefore$ clearing and removing brackets,

$$12 + 4y + 15y = 69 \therefore 19y = 57 \therefore y = 3,$$

$$\text{so that } x \text{ or } \frac{6 + 2y}{3} = \frac{6 + 6}{3} = 4 \therefore x = 4, y = 3.$$

This is called the method of substitution.

3. In the third method the first object is to convert the proposed equations into forms such that one of the unknown quantities may have *the same coefficient* in each, thus:—multiplying the first equation by 3 and the second by 2, they become changed into

$$\begin{array}{r} 6x + 15y = 69 \\ 6x - 4y = 12 \end{array}$$

$$\text{By subtracting, } 19y = 57 \therefore y = 3$$

And this value put for y in one of the given equations, in the second for instance, there results, $3x - 6 = 6 \therefore x = \frac{12}{3} = 4$.

Or without, in this way, borrowing from the method of substitution, multiply the first equation by 2, and the second by 5: they then change into

$$\begin{array}{r} 4x + 10y = 46 \\ 15x - 10y = 30 \end{array}$$

$$\text{By adding, } 19x = 76 \therefore x = 4$$

This is the method of *equalizing the coefficients* of the same unknown quantity in the two equations. When this equality is brought about, then addition or subtraction,

according as the *signs* of the equal coefficients are unlike or like, will of course remove one of the unknown quantities altogether: when one of the unknown quantities is thus got rid of it is said to be *eliminated*.

The operations by the three methods may be stated in a rule as follows:—

RULE 1. *By equating two expressions for the same unknown.* Find an expression for one of the unknown quantities from the first equation. Find an expression for the same from the second equation. Equate these two expressions and you will then have but a single equation with one unknown quantity, the value of which may be found by the former rules. The value of the other unknown is got by substituting the value just found in one of the expressions for that other unknown.

2. By substitution. Find an expression for one of the unknowns from either equation, and substitute this expression in place of that unknown in the other equation: an equation with but one unknown will be the result.

3. By equalizing coefficients. Multiply the two equations by such numbers (or quantities), the smaller the better, as will cause the resulting coefficients of one of the unknowns to be the same in the two changed equations: then by addition or subtraction, according as the equal coefficients have unlike or like signs, an equation will arise having only one unknown quantity. Both unknowns may be *eliminated* one after the other in this way; or having eliminated one, and then found the value of the other from the resulting equation, the value of the former may then be got by substitution, as in the example above.

$$1. \text{ Find the values of } x \text{ and } y \text{ from the equations } \begin{cases} \frac{x}{6} + \frac{y}{4} = 6 \\ \frac{x}{4} + \frac{y}{6} = 5\frac{2}{3} \end{cases}$$

Multiplying the first equation by 2 and the second by 3,

$$\frac{x}{3} + \frac{y}{2} = 12$$

$$\frac{3x}{4} + \frac{y}{2} = 17$$

$$\text{Subtracting, } \frac{3x}{4} - \frac{x}{3} = 5 \therefore 9x - 4x = 60 \therefore 5x = 60 \therefore x = 12$$

$$\therefore (\text{equation 1}) 2 + \frac{y}{4} = 6 \therefore \frac{y}{4} = 4 \therefore y = 16.$$

$$2. \left. \begin{array}{l} \frac{x}{2} + \frac{y}{3} = 7 \\ \frac{x}{3} + \frac{y}{2} = 8 \end{array} \right\} \therefore \text{clearing, } \begin{array}{l} 3x + 2y = 42 \\ 2x + 3y = 48 \end{array} \left. \begin{array}{l} \dots [A] \\ \therefore x = 24 - \frac{3y}{2} \end{array} \right\}$$

$$\text{Substituting this in the equation above, } 72 - \frac{9y}{2} + 2y = 42$$

$$\therefore 144 - 9y + 4y = 84 \therefore 60 = 5y \therefore 12 = y$$

$$\text{And } x = 24 - \frac{3y}{2} = 24 - 18 = 6.$$

Or, subtracting the upper from the lower of [A],

$$-x + y = 6 \therefore y = 6 + x.$$

Substituting this in the former,

$$3x + 12 + 2x = 42 \therefore 5x = 30 \therefore x = 6 \therefore y = 6 + x = 12.$$

This latter is the easier mode of proceeding: such slight departures from *rules*, as in equations with one unknown, may often be adopted with advantage.

EXAMPLES FOR EXERCISE.

1. $\begin{cases} 2x+8y=23 \\ 5x-2y=10 \end{cases}$ 2. $\begin{cases} 5x+4y=58 \\ 3x+7y=67 \end{cases}$ 3. $\begin{cases} \frac{x}{8}+6y=194 \\ y+8x=131 \end{cases}$
4. $\begin{cases} \frac{x+y}{8}=5 \\ \frac{y-x}{7}=1 \end{cases}$ 5. $\begin{cases} \frac{3x-7y}{8}=\frac{2x+y+1}{6} \\ 2-\frac{x-y}{6}=0 \end{cases}$ 6. $\begin{cases} \frac{x+2}{3}+8y=31 \\ \frac{y+5}{4}+10x=192 \end{cases}$
7. $\begin{cases} ax+by=1 \\ a'x-b'y=1 \end{cases}$ 8. $\begin{cases} ax+by=c \\ a'x+b'y=c' \end{cases}$ 9. $\begin{cases} \frac{1}{x}-\frac{1}{y}=12 \\ \frac{3}{x}+\frac{5}{y}=24 \end{cases}$ } Here the unknowns had better be regarded as $\frac{1}{x}, \frac{1}{y}$; when these are found, the reciprocals can be taken.
10. $\begin{cases} \frac{x-2}{5}-\frac{10-x}{3}-\frac{y-10}{4}=0 \\ \frac{2(y+2)}{3}-\frac{2x+y}{8}-\frac{x+13}{4}=0 \end{cases}$ 11. $\begin{cases} \frac{x+6}{x+4}-\frac{y+2}{y-2} \\ \frac{x+8}{x+1}-\frac{y-7}{y-13} \end{cases}$ } (See p. 203.) 12. $\begin{cases} x+y=19 \\ x^2-y^2=95 \end{cases}$

Questions in Simple Equations with one or two Unknowns.

1. Find a number such that whether it be divided into two equal parts, or into three equal parts, the product of the parts shall be the same.

Let x be the number; then by the question

$$\frac{x}{2} \times \frac{x}{2} = \frac{x}{3} \times \frac{x}{3} \times \frac{x}{3}$$

$$\text{that is } \frac{x^2}{4} = \frac{x^3}{27} \therefore \frac{1}{4} = \frac{x}{27} \therefore 27 = 4x \therefore \frac{27}{4} = 6\frac{3}{4} = x.$$

When the question implies *parts* of the unknown quantity, fractions may generally be avoided in the solution by representing the unknown not by x , but a multiple of x , such that the proposed parts may be integral: thus, in the present case—

Let $6x$ be the number; then by the question

$$3x \times 3x = 2x \times 2x \times 2x$$

$$\text{that is } 9x^2 = 8x^3 \therefore 9 = 8x \therefore x = \frac{9}{8} \therefore 6x = \frac{27}{4} = 6\frac{3}{4}.$$

2. A person after spending one-fifth of his income and £10 more, found that he had £35 more than half his income left; what was his income?

Let $10x$ represent his income; then by the question the number of pounds he spent is $2x + 10$, so that he had $10x - (2x + 10)$ left; that is $8x - 10$; but by the question he had $5x + 35$ left,

$$\therefore 8x - 10 = 5x + 35 \therefore 3x = 45 \therefore x = 15 \therefore 10x = 150$$

so that his income was £150.

3. There is a fraction such that if 3 be added to the numerator, its value is $\frac{1}{3}$; and if 1 be subtracted from the denominator, its value is $\frac{1}{2}$: what is the fraction?

Let x be the numerator and y the denominator; then the fraction is $\frac{x}{y}$; and by the question

$$\left. \begin{aligned} \frac{x+3}{y} &= \frac{1}{3} \\ \frac{x}{y-1} &= \frac{1}{6} \end{aligned} \right\} \text{or, } \begin{cases} 3x+9=y \\ 5x=y-1, \text{ or } y=5x+1. \end{cases}$$

Hence, equating these two expressions for y , we have

$$5x+1=3x+9 \therefore 2x=8 \therefore x=4, \text{ the numerator.}$$

And $y=5x+1=21$, the denominator, $\therefore \frac{4}{21}$ is the fraction.

4. A man and his wife could drink a barrel of beer in 15 days; but after drinking together 6 days, the woman alone drank the remainder in 30 days. In what time could either alone drink the whole barrel?

Suppose the man could drink it in x days, and the woman in y days; then in *one day* the man's share is $\frac{1}{x}$ of the whole, and the woman's $\frac{1}{y}$; so that 15 times the sum of these shares is 1 whole barrel: that is—

$$\frac{15}{x} + \frac{15}{y} = 1.$$

But by the question

$$\frac{6}{x} + \frac{6}{y} + \frac{30}{y} = 1; \text{ that is, } \frac{6}{x} + \frac{36}{y} = 1.$$

So that dividing the first equation by 15, and this last by 6, we have

$$\frac{1}{x} + \frac{1}{y} = \frac{1}{15}.$$

$$\frac{1}{x} + \frac{6}{y} = \frac{1}{6}.$$

By subtracting

$$\frac{5}{y} = \frac{1}{6} - \frac{1}{15} = \frac{3}{30} = \frac{1}{10} \therefore y=50.$$

Also since, $\frac{5}{y} = \frac{1}{10} \therefore \frac{15}{y} = \frac{3}{10} \therefore \frac{15}{x} = 1 - \frac{15}{y} = 1 - \frac{3}{10} = \frac{7}{10} \therefore 7x = 150;$

$$\therefore x = \frac{150}{7} = 21\frac{3}{7}.$$

Consequently, the man alone could drink it in $21\frac{3}{7}$ days, and the woman in 50 days.

In this example $\frac{1}{x}$ and $\frac{1}{y}$ are regarded as the unknown quantities, as recommended at page 206, example 9.

1. Find a number such that if it be increased by one-half, one-third, and one-fourth of itself, the sum shall be 50.

2. There is a fraction such that if 4 be added to the denominator the value is $\frac{1}{4}$; and if 3 be added to the numerator, the value is $\frac{1}{3}$: required the fraction.

3. What number is that such that if it be increased by 7, the square root of the sum shall be equal to the square root of the number itself and 1 more?

4. Fifty labourers are engaged to remove an obstruction on a railway: some of them are by agreement to receive ninepence each, and the others fifteen pence. Just £2 are paid to them: but, no memorandum having been made, it is required to find how many worked for $9d.$, and how many for $15d.$

5. A person ordered a quantity of rum and brandy, for which he paid £19 $4s.$: the brandy was $9s.$ a quart, and the rum $6s.$ He has, however, forgotten the exact number of each he has to receive; but he remembers that if his brandy had been rum, and his rum brandy, his outlay would have been £1 $13s.$ less. How many quarts of each did he buy?

6. A person has spirits at $12s.$ a gallon, and at £1 a gallon; how much of each sort must he take to make a gallon worth $14s.$?

7. A merchant has spirits at a shillings a gallon, and at b shillings a gallon; how much of each must he take to make a mixture of d gallons worth c shillings a gallon?

8. In the composition of a certain quantity of gunpowder, two-thirds of the whole + 10lbs. was nitre; one-sixth of the whole - $4\frac{1}{2}$ lbs. was sulphur; and the charcoal was one-seventh of the nitre, all but 2lbs. How many lbs. of gunpowder were there?

9. A farmer wishes to mix 28 bushels of barley at $2s. 4d.$ a bushel with rye at $3s.$ a bushel, and wheat at $4s.$ a bushel, so that the whole may make 100 bushels worth $3s. 4d.$ a bushel; how much rye and wheat must he use?

10. Two persons, A and B, are engaged on a work which they can finish in 16 days; but after working together 4 days, A is called off; and B alone finishes it in 36 days more. In how many days could each do it separately?

11. A composition of copper and tin, containing 100 cubic inches, weighed 505 ounces; how many ounces of each metal did it contain, supposing a cubic inch of copper to weigh $5\frac{1}{2}$ oz., and a cubic inch of tin to weigh $4\frac{1}{2}$ oz.?

12. A cask is supplied by three spouts, which can fill it in a minutes, b minutes, and c minutes respectively; in what time will it be filled if all flow together?

Simple equations with three unknown quantities may be solved by imitating the operations in equations with two unknowns; that is, by first eliminating one of the unknowns from two of the equations, and then eliminating the same unknown from one of those two and the third; the results of the eliminations will be a pair of equations, with only two unknowns: for example,

A and B can perform a piece of work in 8 days; A and C in 9 days; and B and C in 10 days. In how many days can each alone perform it?

Suppose A, B, and C can do the x th part, the y th part, and the z th part respectively in one day: then by the question,

$$8x + 8y = 1 \text{ (the whole), } 9x + 9z = 1, 10y + 10z = 1.$$

To equalize the coefficients of y , multiply the first by 5, and the third by 4; and we have

$$40x + 40y = 5$$

$$40x + 40y = 4$$

∴ Subtracting, $40x - 40x = 1.$ Mult. this by 9, and the second equa. by 40:

$$360x - 360z = 9$$

$$360x + 360z = 40.$$

Adding and subtracting, $720x = 49$ and $720z = 31$, ∴ $x = \frac{49}{720}$, and $z = \frac{31}{720}$,

$$\therefore 10y + 10z = 10y + \frac{31}{72} = 1 \therefore 10y = \frac{41}{72} \therefore y = \frac{41}{720}$$

Hence A can do $\frac{49}{720}$ of the whole in 1 day; B can do $\frac{41}{720}$; and C, $\frac{31}{720}$.

\therefore A can do the whole in $\frac{720}{49}$ days, B in $\frac{720}{41}$ days, and C in $\frac{720}{31}$ days.

That is, in $14\frac{2}{7}$ days, $17\frac{2}{11}$ days, and $23\frac{2}{31}$ days, respectively.

Equations which, like those considered in the preceding pages, imply distinct conditions, all existing together, are called *simultaneous equations*; the conditions of the foregoing problem are implied in the three simultaneous equations at the commencement of the solution.

—————

Quadratic Equations with one Unknown Quantity.

A quadratic is an equation in which the *square* of the unknown quantity enters, and enters in such a way as to require a peculiar process for its removal. It is possible that even a simple equation may contain the square of the unknown; but then, in order that it may deserve the name of a *simple* equation, this square must be removable by transposition or division, or by some other of the operations common to simple equations in general; whereas a *quadratic*, properly so called, requires for its solution an additional principle: what this is, is now to be explained.

And first, you are to observe that the square of a quantity, consisting of but *one* term; that is, the square of a *monomial* is itself a monomial: thus the square of x is x^2 ; the square of ax is a^2x^2 , and so on. But the square of a *binomial* consists of *three* terms; that is, it is a *trinomial*: thus, $(x+a)^2 = x^2 + 2ax + a^2$, $(x-a)^2 = x^2 - 2ax + a^2$, and so on.

The next thing you are to observe is, that if only the first and second terms of the square of a binomial, $x+a$, or $x-a$, be given, the *third* term of it can always be found; for you see that *this third term is nothing more than the square of half the coefficient in the second term*. Thus, if the first and second terms, viz., $x^2 + 2ax$, or $x^2 - 2ax$, be written down, we can complete the square to which these two terms belong, by dividing the coefficient of x , namely $2a$ or $-2a$, by 2; and then *adding* the square of the result. Thus, half the coefficient of x , in $x^2 + 2ax$, is a ; the square of this is a^2 ; adding this \therefore to the two terms proposed, we have $x^2 + 2ax + a^2$, for the complete square of $x+a$. In like manner, knowing the two terms $x^2 - 2ax$, we have only to add to them the square of half $-2a$, that is, $(-a)^2$, or a^2 , to get $x^2 - 2ax + a^2$, the complete square of $(x-a)^2$. It follows from this, that whenever we have an expression of this form—namely, $x^2 + px$, whether p be positive or negative, we can always add to it a term, easily found, that will make the expression a complete square; this term being no other than the square of $\frac{1}{2}p$; that is, $\frac{1}{4}p^2$; and moreover, that the root of this square may at once be pronounced to be $x + \frac{1}{2}p$. In fact, common multiplication shows that $x^2 + px + \frac{1}{4}p^2 = (x + \frac{1}{2}p)^2$, whether p be $+$ or $-$.

I shall give you an example or two of *completing the square*, as it is called—

1. Having the two terms $x^2 + 6x$, complete the square to which these two terms belong, and express the root of that square. Here half the coefficient of x is 3, \therefore the wanting term is $3^2 = 9$, \therefore the square is $x^2 + 6x + 9$, and the root being x , with the half coefficient taken with its own sign added, we have $x^2 + 6x + 9 = (x+3)^2$.

2. Given $x^2 - 8x$ to complete the square. Here the half coefficient is -4 , of which

the square is 16, \therefore the complete square is $x^2 - 8x + 16$, the root of which being x , together with the half coefficient, we have $x^2 - 8x + 16 = (x - 4)^2$.

3. Given $x^2 - 3x$ to complete the square. Here the half coefficient is $-\frac{3}{2}$, \therefore its square is $\frac{9}{4}$, \therefore the complete square is $x^2 - 3x + \frac{9}{4} = (x - \frac{3}{2})^2$.

I think you can now find no difficulty in rendering an expression of the form $x^2 + px$, in which the coefficient of x^2 is unity, and that of x anything, a complete square. It is the accomplishment of this single matter that constitutes the whole mystery of quadratic equations, as you will now see.

To solve a Quadratic Equation.

RULE 1.—As in a simple equation dispose all the unknown terms on one side of the equation, and all the known on the other; the unknown side, when the terms are collected, will then consist of but two terms—the first containing x^2 , and the second x simply.

2. If x^2 , in the first term, have a coefficient other than unity, divide both sides by that coefficient; the equation will thus be reduced to the form $x^2 + px = a$, where a is the known side, and p a known coefficient.

3. Add the square of half this coefficient to both sides; the unknown side will then be a complete square, viz., the square of $x + \frac{1}{2}p$, the sign of p being the same as that in the above reduced form; and the known side will be $a + \frac{1}{4}p^2$.

4. Extract the square root of each side, and the result will be a simple equation, viz., $x + \frac{1}{2}p = \sqrt{a + \frac{1}{4}p^2}$.

You will observe that although I say *extract the square root of each side*, yet as far as the unknown side is concerned, there is, in reality, no actual extraction performed; you have nothing to do but to write down x together with half the coefficient of x , in the reduced form $x^2 + px$; but, as respects the known side, when this is a number, the square root is actually found by common arithmetic, unless it is seen to be a surd, when we may leave it under the sign $\sqrt{\quad}$, the extraction being merely indicated. You must remember, however, that when the square root of a number is actually determined, the sign to be prefixed to that root is ambiguous (see page 193); it may be either $+$ or $-$.

1. Find the values of x in the equation $x^2 + 6x + 9 = 55$.

Completing the square, $x^2 + 6x + 9 = 64$.

Extracting the square root, $x + 3 = \pm 8$.

$$\therefore x = -3 + 8 = 5, \text{ or } -11.$$

If 5 be put for x , the proposed equation is $25 + 30 = 55$.

If -11 be put for x , the equation is $121 - 66 = 55$.

2. $3x^2 + 2x - 9 = 76$. Transposing, and then dividing by 3, the coefficient of x^2 ,

$$x^2 + \frac{2}{3}x = \frac{85}{3}.$$

Completing the square, $x^2 + \frac{2}{3}x + \frac{4}{9} = \frac{85}{3} + \frac{4}{9} = \frac{256}{9}$.

Extracting the root, $x + \frac{1}{3} = \sqrt{\frac{256}{9}} = \pm \frac{16}{3}$.

$$\therefore x = -\frac{1}{3} + \frac{16}{3} = 5 \text{ or } -\frac{17}{3}.$$

3. $3x^2 - 9x - 4 = 80$. Transposing, and dividing by 3, $x^2 - 3x = 28$.

Completing the square, $x^2 - 3x + \frac{9}{4} = 28 + \frac{9}{4} = \frac{121}{4}$.

Extracting the root, $x - \frac{3}{2} = \sqrt{\frac{121}{4}} = \pm \frac{11}{2}$.

$$\therefore x = \frac{3}{2} + \frac{11}{2} = 7, \text{ or } -4.$$

4. $\frac{x}{5} + \frac{5}{x} = 5\frac{1}{2}$. Multiplying by $5x$, to clear fractions,

$$x^2 + 25 = 26x, \therefore x^2 - 26x = -25.$$

Completing the square, $x^2 - 26x + 13^2 = 169 - 25 = 144$.

Extracting the root, $x - 13 = \sqrt{144} = \pm 12$.

$$\therefore x = 13 \pm 12 = 25, \text{ or } 1.$$

5. $\frac{7}{x+1} + \frac{2}{x} = 5$. Clearing fractions,

$$7x + 2x + 2 = 5x^2 + 5x.$$

Transposing, $5x^2 - 4x = 2 \therefore x^2 - \frac{4}{5}x = \frac{2}{5}$.

Completing the square, $x^2 - \frac{4}{5}x + \frac{4}{25} = \frac{2}{5} + \frac{4}{25} = \frac{14}{25}$.

Extracting the root, $x - \frac{2}{5} = \sqrt{\frac{14}{25}} = \frac{1}{5}\sqrt{14}$.

$$\therefore x = \frac{2}{5} + \frac{1}{5}\sqrt{14}.$$

The square root of 14 is found, by arithmetic, to be 3.742; and $\frac{1}{5}$ of this is .748; also since $\frac{2}{5} = .4$, we have $x = .4 \pm .748 = 1.148$, or $-.348$.

6. $\frac{x+11}{x} + \frac{9+4x}{x^2} = 7$. Multiplying by x^2 , to clear fractions,

$$x^2 + 11x + 9 + 4x = 7x^2 \therefore 6x^2 - 15x = 9.$$

Or dividing by 3, $x^2 - \frac{5}{2}x = \frac{3}{2}$.

Completing the square, $x^2 - \frac{5}{2}x + \frac{25}{16} = \frac{3}{2} + \frac{25}{16} = \frac{49}{16}$.

Extracting the root, $x - \frac{5}{4} = \sqrt{\frac{49}{16}} = \pm \frac{7}{4}$.

$$\therefore x = \frac{5}{4} \pm \frac{7}{4} = 3, \text{ or } -\frac{1}{2}.$$

7. $\frac{2\sqrt{x+2}}{4+\sqrt{x}} = \frac{4-\sqrt{x}}{\sqrt{x}}$. Clearing fractions, and remembering that sum \times dif. = dif. sqs.

$$2x + 2\sqrt{x} = 16 - x \therefore 2\sqrt{x} = 16 - 3x.$$

Squaring, to remove the radical,

$$4x = 256 - 96x + 9x^2 \therefore 9x^2 - 100x = -256.$$

Dividing by 9, $x^2 - \frac{100}{9}x = -\frac{256}{9}$.

Completing the square, $x^2 - \frac{100}{9}x + \frac{2500}{81} = \frac{2500}{81} - \frac{256}{9} = \frac{196}{81}$

Extracting the root, $x - \frac{50}{9} = \sqrt{\frac{196}{81}} = \pm \frac{14}{9}$

$$\therefore x = \frac{50}{9} \pm \frac{14}{9} = \frac{64}{9}, \text{ or } 4.$$

We might have completed the solution without clearing the radical from the equation $2x + 2\sqrt{x} = 16 - x$, thus: by transposing,

$$3x + 2\sqrt{x} = 16 \quad \therefore x + \frac{2}{3}\sqrt{x} = \frac{16}{3}$$

Now, since x in the first term is the square of \sqrt{x} in the second, it is plain that we may treat this as a quadratic equation, regarding \sqrt{x} as the unknown quantity \therefore completing the square,

$$x + \frac{2}{3}\sqrt{x} + \frac{1}{9} = \frac{16}{3} + \frac{1}{9} = \frac{49}{9}$$

Extracting the root,

$$\sqrt{x + \frac{1}{9}} = \sqrt{\frac{49}{9}} = \frac{7}{3}$$

$$\therefore \sqrt{x} = \frac{7}{3} - \frac{1}{3} = 2, \text{ or } -\frac{8}{3}; \therefore x = 4, \text{ or } \frac{64}{9}$$

NOTE.—And in a similar way may any equation of the form, $x^{2n} + px^n = a$, in which the exponent of x in the first term is double that of x in the second, be solved as a quadratic; the equation just considered is $x + \frac{2}{3}x^{\frac{1}{2}} = \frac{16}{3}$, where the exp. 1 of x , in the first term, is double $\frac{1}{2}$, the exp. of x in the second.

EXAMPLES FOR EXERCISE.

1. $x^2 - 4x = 45$.
2. $x^2 + 8x = 33$.
3. $x^2 - 8x = 9$.
4. $3x^2 + 2x = 161$.
5. $7x^2 - 20x = 32$.
6. $x^2 - x - 170 = 40$.
7. $5x^2 + 4x = 273$.
8. $\frac{4x^2 - x}{3} = 11$.
9. $x + \frac{7x - 8}{x} = 9$.
10. $5x^2 + 3 = 4x + 159$.
11. $6x + \frac{35 - 3x}{x} - 44 = 0$.
12. $\frac{x - 2}{x + 2} + \frac{x + 2}{x - 2} = 14$.
13. $\frac{48}{x^2} + \frac{32}{x} = 11$ or $48x^{-2} + 32x^{-1} = 11$ (See p. 192).
14. $x^4 - 40x^2 + 39 = 0$.
15. $x^2 + ax + b = 0$.
16. $\frac{x + a}{x - a} + \frac{x - a}{x + a} = b$.
17. $\frac{x}{2} - \frac{1}{3}\sqrt{x} = 22\frac{1}{3}$.
- 18.* $(3x - 2)(1 - x) = 4$.
19. $15x^2 - 48x + 45 = 0$.
20. $\sqrt{\frac{x - 2}{x + 2}} + \sqrt{\frac{x + 2}{x - 2}} = 4$.

The preceding method of solving a quadratic equation is that which is usually employed for the purpose; in certain cases, however, it is attended with inconvenience; in those cases, namely, where the completion of the square introduces numerical fractions into the work. I am now going to show you an improvement upon the common rule, by adopting which, in your own practice, you will prevent the introduction of fractions.

The most general form of the quadratic equation, after the proper preliminary reductions, is $ax^2 + bx = c$. Let each side be multiplied by $4a$; the equation will then be $4a^2x^2 + 4abx = 4ac$, or, which is the same thing,

$$(2ax)^2 + 2b(2ax) = 4ac.$$

The first member of this, you will observe, consists of two terms:—namely, the square of $2ax$ and $2b$ times $2ax$; so that regarding $2ax$ as the unknown quantity, we

* The roots of this equation, and also those of equation 19, are *imaginary*; that is, the values of x in each will be found to involve the square root of a negative number; we may conclude, therefore, that it is not possible to satisfy either of these equations by any real value of x (see p. 193).

shall complete the square by adding b^2 ; and the root of that square will be $2ax + b$: we therefore proceed thus—

Completing the square, $(2ax)^2 + 2b(2ax) + b^2 = 4ac + b^2$.

Extracting the root, $2ax + b = \sqrt{4ac + b^2}$.

Hence any quadratic may be reduced to a simple equation, of which this is the general model, without the introduction of any fractions. The steps from the proposed quadratic $ax^2 + bx = c$, to the simple equation $2ax + b = \sqrt{4ac + b^2}$, need not be gone through in each particular example; the reduced equation may be derived at once as follows:—

Rule II.—Take twice the coefficient of x^2 in the proposed quadratic; this will be the coefficient of x in the derived simple equation.

To the first term thus found, connect with its own sign the coefficient of x in the proposed: and the first member of the derived simple equation will be obtained.

To form the second member, multiply the second member of the proposed by four times the coefficient of x^2 , add the square of the next coefficient (that of x) to the result, and cover the whole with the radical sign.

This is the rule for the solution of any quadratic; it is a mere translation in words of the formula for the solution; namely,

Proposed quadratic.

$$ax^2 + bx = c.$$

Derived simple equation.

$$2ax + b = \sqrt{4ac + b^2}.$$

You may either commit the rule to memory, or keep the formula before your mind's eye; remembering that, as a square is always plus, b^2 is to take the positive sign, whether b , in the quadratic, is + or -. Thus (see ex. 6, p. 211),

Quadratic.

$$6x^2 - 15x = 9$$

or

$$2x^2 - 5x = 3 \quad . \quad . \quad . \quad 4x - 5 = \sqrt{24 + 25} = \sqrt{49} = \pm 7.$$

Again, ex. 5, p. 211,

$$5x^2 - 4x = 2 \quad . \quad . \quad . \quad 10x - 4 = \sqrt{40 + 16} = \sqrt{56} = 2\sqrt{14}.$$

Also ex. 3, p. 210,

$$x^2 - 3x = 28 \quad . \quad . \quad . \quad 2x - 3 = \sqrt{112 + 9} = \sqrt{121} = \pm 11.$$

And from each of these simple equations you may deduce the value of x , at a single step: thus—

$$\text{ex. 3. } x = \frac{3 \pm 11}{2} = 7, \text{ or } -4; \quad \text{ex. 5. } x = \frac{4 \pm 2\sqrt{14}}{10} = \frac{2}{5} \pm \frac{1}{5}\sqrt{14};$$

$$\text{ex. 6. } x = \frac{5 \pm 7}{4} = 3, \text{ or } -\frac{1}{2},$$

as at the pages referred to. You will do well to return to all the examples you have worked by the common method, and re-solve them in this way, which you will find to be much the shorter and easier, whenever fractions are unavoidable by the former rule. I refrain from giving additional examples here, solely because I expect you to act upon this recommendation.

To solve a pair of equations, with two unknown quantities, when one is a simple equation and the other a quadratic.

The mode of proceeding in this case scarcely requires any formal directions. From the simple equation an expression for one of the unknowns may be easily found in terms

of the other and known quantities, as at page 204; and this expression substituted in the quadratic will, of course, give an equation with only one unknown quantity; the other being *eliminated* in consequence of the substitution. Thus—

1. $x + 2y = 7$ } From the first equation $x = 7 - 2y$. Substituting this
 $x^2 + 2xy - y^2 = 23$ } in the second, it becomes—
 $(7 - 2y)^2 + 3(7 - 2y)y - y^2 = 23$; that is, $49 - 28y + 4y^2 + 21y - 6y^2 - y^2 = 23$,
 or $3y^2 + 7y = 26$

\therefore Rule II., $6y + 7 = \sqrt{(312 + 49)} = \sqrt{361} = \pm 19$
 $\therefore y = \frac{-7 + 19}{6} = 2$, or $-\frac{13}{3}$. $\therefore x = 7 - 2y = 3$, or $15\frac{2}{3}$;

so that the two values of x and y which satisfy the proposed pair of simultaneous equations are either—

$$\begin{matrix} x = 3 \\ y = 2 \end{matrix} \text{ or } \begin{matrix} x = 15\frac{2}{3} \\ y = -4\frac{1}{3} \end{matrix}.$$

2. $2x - 3y = 1$ } From the first equation $x = \frac{1 + 3y}{2}$. Substituting this
 $2x^2 + xy - 5y^2 = 20$ } in the second, it becomes—

$2\left(\frac{1 + 3y}{2}\right)^2 + \frac{1 + 3y}{2}y - 5y^2 = 20$; that is, $\frac{1 + 6y + 9y^2}{2} + \frac{y + 3y^2}{2} - 5y^2 = 20$,
 or, multiplying by 2, and transposing, $2y^2 + 7y = 39$

\therefore Rule II., $4y + 7 = \sqrt{(312 + 49)} = \sqrt{361} = \pm 19$
 $\therefore y = \frac{-7 + 19}{4} = 3$, or $-\frac{13}{2}$. $\therefore x = \frac{1 + 3y}{2} = 5$, or $-9\frac{1}{2}$,

so that the values of x and y are either—

$$\begin{matrix} x = 5 \\ y = 3 \end{matrix} \text{ or } \begin{matrix} x = -9\frac{1}{2} \\ y = -6\frac{1}{2} \end{matrix}.$$

Sometimes pairs of equations, coming under the present head, may be most conveniently solved, independently of *rule*, by exercising a little ingenuity. Here is an example.—

3. $x + y = 12$ } By squaring the first equation, and then subtracting the second,
 $x^2 + y^2 = 74$ } $2xy = 70 \therefore 4xy = 140$.

From the sq. of the first, viz. $x^2 + 2xy + y^2 = 144$
 Subtract $4xy = 140$

$$\therefore x^2 - 2xy + y^2 = 4$$

Extracting the square root, $x - y = \pm 2$

But, $x + y = 12$

\therefore adding and subtracting, $2x = 12 \pm 2$, and $2y = 12 \mp 2$

$\therefore x = 7$, or 5 ; and $y = 5$, or 7

that is, the values of x and y are either—

$$\begin{matrix} x = 7 \\ y = 5 \end{matrix} \text{ or } \begin{matrix} x = 5 \\ y = 7 \end{matrix}.$$

4. In a similar way you may treat the equations $x - y = 6$, $x^2 + y^2 = 50$; and you will find that the values of x and y are either $x = 7$, $y = 1$; or $x = -1$, $y = -7$.

Questions requiring the solution of Quadratic Equations.

1. The fore-wheel of a carriage makes 6 revolutions more than the hind-wheel in going 120 yards; but it is found that if the circumference of each wheel be increased

1 yard, that it will make only 4 revolutions more than the hind-wheel in the same distance; required the circumference of each wheel.

Let x = No. of yards in circ. of larger wheel,
 y = smaller wheel,

then $\frac{120}{x}$ = No. of revolutions of the former, and $\frac{120}{y}$ = No. of revolutions of latter;

and by the question, $\frac{120}{x} = \frac{120}{y} - 6 \therefore 20y = 20x - xy \therefore xy = 20x - 20y$. . [A].

Also by the question, $\frac{120}{x+1} = \frac{120}{y+1} - 4 \therefore 30(y+1) = (x+1)(29-y)$,

that is, $30y + 30 = 29x + 29 - xy - y \therefore xy = 29x - 31y - 1$.

Substituting this expression for xy in the equation [A], we have—

$$29x - 31y - 1 = 20x - 20y \therefore 9x = 11y + 1 \dots [B]$$

This equation [B] is a simple equation, and [A] is a quadratic, or an equation of two dimensions, because of the term xy .

From [A] we have $x = \frac{11y+1}{9}$; this substituted in [B] gives—

$$\frac{11y^2 + y}{9} = \frac{220y + 20}{9} - 20y \therefore 11y^2 + y = 220y + 20 - 180y = 40y + 20$$

$$\therefore 11y^2 - 39y = 20$$

$$\therefore \text{Rule II.}, 22y - 39 = \sqrt{(880 + 39^2)} = \sqrt{2461} = \pm 49.$$

$$\therefore y = \frac{39 + 49}{22} = 4, \text{ or } -\frac{5}{11} \therefore x = \frac{11y + 1}{9} = 5, \text{ or } -\frac{1}{9}.$$

From the nature of the question, it is plain that the *negative* values of x and y are inadmissible; they fulfil the *algebraical* conditions [A] and [B], as well as the *positive* values, for there is nothing in those conditions to exclude them; and it will often be found that the algebraic translation is free from the particular restrictions embodied in the question itself. The algebra furnishes *all* the values of the symbols, whether positive or negative, real or imaginary; and those of them are afterwards to be rejected which the restrictions of the question necessarily exclude. In the present case the only answers to the question are $x = 5$, and $y = 4$.

2. A company at a tavern had £8 15s. to pay; but before the bill was settled, two of them left; in consequence of which, those who remained had each 10s. more to pay. How many persons were in company at first?

Let x represent the number: then $\frac{175}{x}$ is the share of each in shillings, and $\frac{175}{x-2}$

the portion each paid, after two had left. the difference is $\frac{175}{x-2} - \frac{175}{x} = 10$ by the question, \therefore clearing fractions,

$$175x - 175x + 350 = 10x(x-2);$$

or, dividing by 10, $35 = x^2 - 2x$, or $x^2 - 2x = 35$,

$$\therefore 2x - 2 = \sqrt{(140 + 4)} = \pm 12 \therefore x = \frac{2 \pm 12}{2} = 1 \pm 6 = 7, \text{ or } -5.$$

Consequently they were 7 persons at first.

3. What number is that which, being divided by the product of its two digits, the quotient is 2; and if 27 be added to it, the digits will be inverted or transposed.

Let x and y be the digits, then the number is $10x + y$; and when the digits are inverted or transposed, the number is $10y + x$.

By the question, $\frac{10x + y}{xy} = 2 \therefore 10x + y = 2xy \dots [A]$

and $10x + y + 27 = 10y + x \therefore 9x + 27 = 9y \therefore x + 3 = y$.

Substituting this value of y in [A], we have—

$$11x + 3 = 2x^2 + 6x \therefore 2x^2 - 5x = 3$$

$$\therefore 4x - 5 = \sqrt{(24 + 25)} = \sqrt{49} = \pm 7 \therefore x = \frac{5 \pm 7}{4} = 3, \text{ or } -\frac{1}{4}$$

$$\therefore y = x + 3 = 6, \text{ or } 2\frac{1}{4}.$$

The only admissible values are $x = 3$, and $y = 6$, \therefore the number is 36.

1. Divide the number 33 into two such parts, that their product may be 162.
2. Find two numbers whose difference is 9, and which are also such that their sum multiplied by the greater gives 266 for the product.
3. A company at a tavern had £7 4s. to pay; but two of them having left, the others had each 1s. more to pay than his fair share; how many persons were there at first?
4. A purse contains 24 coins of silver and copper; each copper coin is worth as many pence as there are silver coins, and each silver coin is worth as many pence as there are copper coins: and the whole is worth 18s. How many are there of each?
5. Two messengers, A and B, were dispatched to the same place, 90 miles distant, A, by riding one mile an hour more than B, arrives at his destination an hour before him. How many miles an hour did each travel?
6. A grocer sold 80lbs. of mace and 100lbs. of cloves for £65; but he sold 60lbs. more of cloves for £20 than he did of mace for £10. What was the price of 1lb. of each?
7. The product of two numbers is 240, and they are such, that if one of them be increased by 4, and the other diminished by 3, the product of the results is still 240. Find the numbers.
8. A and B set out at the same time for a place 150 miles distant. A travels 3 miles an hour faster than B, and arrives at the place $8\frac{1}{2}$ hours before him. How many miles did each travel per hour?
9. What number is that the sum of whose digits is 15, and if 31 be added to their product, the digits will be transposed?
10. There is a certain number consisting of two digits. The left-hand digit is equal to three times the right-hand one; and if 12 be subtracted from the number, the remainder will be equal to the square of the left-hand digit. What is the number?

A pair of simultaneous equations, with two unknown quantities, cannot in general be solved without the aid of higher equations, when the proposed ones are *both* quadratics. There are only two particular classes of such simultaneous equations to which general methods of solution, capable of being explained here, apply. These classes are called respectively *homogeneous equations*, and *symmetrical equations*. I shall very briefly consider them in the present article.

Homogeneous quadratics.—A pair of quadratics is said to be a pair of homogeneous equations when each unknown term in both is of *two dimensions*; that is, when no term occurs without either the *square* of one of the unknowns, or the *product* of both;

the presence of *two* unknown factors—whether equal or unequal—in a term, being the circumstance that renders that term of *two* dimensions. The following is a pair of

homogeneous quadratics, each unknown term being of two dimensions: $x^2 + xy = 77$
 $xy - y^2 = 12$

The following is the general way of solving such equations:—Put xy for x , and the equations become

$$x^2y^2 + xy^2 = 77, \text{ and } xy^2 - y^2 = 12.$$

From the first, $y^2 = \frac{77}{x^2 + x}$; from the second, $y^2 = \frac{12}{x-1}$ [A]

$$\therefore \frac{77}{x^2 + x} = \frac{12}{x-1} \therefore 12x^2 - 65x = -77$$

By means of this contrivance, viz. the putting x times one of the unknowns for the other, we easily obtain a quadratic equation involving x only: solving this, we have

$$24x - 65 = \sqrt{(-77 \times 48 + 65^2)} = \sqrt{529} = \pm 23$$

$$\therefore x = \frac{65 \pm 23}{24} = \frac{11}{3}, \text{ or } \frac{7}{4}.$$

Substituting each of these in equation [A], we have

$$y^2 = \frac{12}{24} \text{ or } \frac{12}{3}; \text{ that is, } y^2 = \frac{9}{2}, \text{ or } 16 \therefore y = \frac{3}{\sqrt{2}} = \frac{3}{2} \sqrt{2}, \text{ or } \pm 4$$

$$\therefore x = zy = \frac{11}{2} \sqrt{2}, \text{ or } \pm 7.$$

You see that each of the unknowns has *four* values; for $\sqrt{2}$ is either $+$ or $-$: such is usually the case when the proposed equations are each of *two* dimensions. From the first equation above $y = \frac{77 - x^2}{x}$; and if this be put for y in the second, the result, cleared of fractions, would evidently be an equation of the *fourth* degree; and it is proved, in the *Theory of Equations*, that an equation always has as many roots as there are units in the number which marks its degree: this is the reason that the values of x and y above are four in number.

Symmetrical Quadratics.—An equation is said to be symmetrical, in reference to the unknowns which enter it, when they so enter that they may be interchanged without producing any alteration in the equation: thus $x + y = a$; $x^2 + 3xy + y^2 = b$; $2x^2 - 3x^2y^2 + 2y^2 = c$, &c., are all symmetrical equations; because for every x you may put y , and for every y , x , without altering either of the equations. The following is a pair of symmetrical quadratics; namely,

$x^2 + y^2 - x - y = 18$ } The general method of dealing with such equations is as
 $xy + x + y = 19$ } follows:—Put $u + v$ for x , and $u - v$ for y , and the equations become

$$\begin{aligned} (u+v)^2 + (u-v)^2 - 2u = 18 \} \text{ or } \{ u^2 + v^2 - u = 9 \quad [A] \\ (u+v)(u-v) + 2u = 19 \} \end{aligned}$$

By adding, $2u^2 + u = 28 \therefore 4u + 1 = \sqrt{(224 + 1)} = \pm 15 \therefore u = \frac{-1 \pm 15}{4} = \frac{7}{2}, \text{ or } -4$

$$\therefore [A], \frac{49}{4} + v^2 - \frac{7}{2} = 9 \therefore v^2 = \frac{1}{4} \therefore v = \pm \frac{1}{2}$$

$$16 + v^2 + 4 = 9 \therefore v^2 = -11 \therefore v = \sqrt{-11}$$

$$\therefore x = u + v = \frac{7}{2} \pm \frac{1}{2}, \text{ or } -4 \pm \sqrt{-11}; \text{ that is, } x = 4, 3, \text{ or } -4 \pm \sqrt{-11}$$

$$y = u - v = \frac{7}{2} \pm \frac{1}{2}, \text{ or } -4 \mp \sqrt{-11}; \text{ that is } y = 3, 4, \text{ or } -4 \mp \sqrt{-11}$$

The two classes of equations here exemplified will always yield to the foregoing methods: but particular cases of these, as also of other kinds of simultaneous equations for the solution of which no general rules can be given, may often be solved more easily by the exercise of a little tact and ingenuity: for instance, you would not think of applying the first method to such a pair of equations as $x^2 + xy = 9$, $y^2 + xy = 16$; because the slightest inspection of them would suggest to you the better way of adding them together, which would give you $x^2 + 2xy + y^2 = 25$, whence $x + y = \pm 5$; and since the first is $(x + y)x = 9$, you would have at once $\pm 5x = 9$; and thence $x = \pm \frac{9}{5}$. $\therefore y = \pm 5$

$-x = \pm 5 \pm \frac{9}{5} = \frac{\pm 25 \mp 9}{5} = \pm \frac{16}{5}$. Or you may proceed thus: the two equations give

$x + y = \frac{9}{x}$, and $x + y = \frac{16}{y}$. $\therefore 9y = 16x \therefore y = \frac{16}{9}x$. \therefore by substitution in the given equations, you would have

$$\frac{25}{9}x^2 = 9, \text{ and } \frac{400}{81}x^2 = 16.$$

These equations give no different values for x , since the second is nothing but $\frac{16}{9}$ times the first: hence the only values of x are $x = \pm \frac{9}{5}$. $\therefore y = \frac{16}{9}x = \pm \frac{16}{5}$.

Ratio and Proportion.

The abstract number which arises from dividing one quantity by another of the same kind is called the *ratio* of the former to the latter. *Ratio*, therefore, is only another name for the *quotient* of one quantity by another of the same kind:—the first quantity (the dividend) is called the *antecedent* of the ratio, and the second (the divisor) the *consequent*: these are the *terms* of the ratio. Thus, of the two quantities a , b , the ratio is $\frac{a}{b}$; or, which is the same thing, $a \div b$; but the little mark between the two dots, in the symbol for division, is usually omitted in expressing a ratio; so that the ratio of a to b would be denoted by $a : b$. Thus, the ratio of 8 to 4, that is $8 : 4$ is $\frac{8}{4}$ or 2; this ratio is of course the same as the ratio $4 : 2$, or the ratio $2 : 1$.

When there are four quantities such that the ratio of the first to the second is equal to the ratio of the third to the fourth, the four quantities are said to be in proportion: thus, if the four quantities a , b , c , d , be such that $\frac{a}{b} = \frac{c}{d}$, or, which is the same thing, $a : b = c : d$, then a , b , c , d are in proportion; and we express this by saying that a is to b as c is to d ; or by writing $a : b :: c : d$. Of these four terms, the first and last (a and d) are called the *extremes*; and the intermediate terms (b and c) the *means*.

From what is here said you see that two equal fractions may always be converted into a proportion, and a proportion into two equal fractions. All the properties of proportional quantities may therefore be derived from those of equal fractions, the following are the most useful:—

1. In four proportional numbers, $a : b :: c : d$, the product of the extremes is equal to the product of the means: for since $\frac{a}{b} = \frac{c}{d}$. $\therefore ad = bc$.

Conversely, if the product of one pair of factors be equal to the product of another

pair, the four factors are in proportion: the factors of one product being the means and those of the other the extremes: thus, if $ad = bc$, then $a : b :: c : d$; because from $ad = bc$, we get, by dividing each side by db , $\frac{a}{b} = \frac{c}{d}$.

3. If four quantities are proportional they are proportional when taken *inversely*, that is, the second is to the first as the fourth to the third: thus, if $a : b :: c : d$, then $b : a :: d : c$; because from $\frac{a}{b} = \frac{c}{d}$ we get, by taking the reciprocals, $\frac{b}{a} = \frac{d}{c}$.

4. They are also proportional if taken alternately, provided the four quantities are all of the same kind; that is, the first is to the third, as the second to the fourth: thus, if $a : b :: c : d$ then $a : c :: b : d$ if the quantities are alike in kind; because from $\frac{a}{b} = \frac{c}{d}$ we get, by multiplying by $\frac{b}{c}$, $\frac{a}{c} = \frac{b}{d}$. If a and c were quantities of different kinds, as for instance, pounds and yards, they could of course have no ratio; *ratio* being always an abstract number expressing how many times the antecedent is contained in the consequent.

5. Three quantities a, b, c are in proportion when they supply the equality $\frac{a}{b} = \frac{b}{c}$; that is, when $a : b :: b : c$. It is plain that three such quantities must always be of the same kind; the first of them is to the third as the square of the first to the square of the second; that is, $a : c :: a^2 : b^2$; because from $\frac{a}{b} = \frac{b}{c}$, we get, by multiplying by $\frac{b}{c}$, $\frac{a}{c} = \frac{b^2}{c^2} = \frac{a^2}{b^2}$.

6. It is further obvious that you may multiply or divide the first and second terms of a proportion by any number, and the third and fourth by any number, without disturbing the proportion; for $\frac{a}{b} = \frac{c}{d}$ is the same as $\frac{ma}{mb} = \frac{nc}{nd}$. And that the first and third may be multiplied or divided by any number, as also the second and fourth; for from $\frac{a}{b} = \frac{c}{d}$ we get $\frac{ma}{nb} = \frac{mc}{nd}$. Moreover, since $\frac{a}{b} = \frac{c}{d}$ leads to $\frac{a^m}{b^m} = \frac{c^m}{d^m}$, whatever be m , it follows that the same powers or roots of four proportional numbers are also in proportion.

7. The terms of two proportions, when they are numbers, may also be multiplied together; that is if—

$$\begin{aligned} a : b &:: c : d \\ \text{and } e : f &:: g : h \\ \text{then } ae &:: bf :: eg : dh \end{aligned}$$

for this is only multiplying the equations $\frac{a}{b} = \frac{c}{d}$, $\frac{e}{f} = \frac{g}{h}$ together.

8. If $a : b :: c : d$ } then $a : e :: c : f$. This follows from multiplying together the
and $b : e :: d : f$ }

equations $\frac{a}{b} = \frac{c}{d}$, $\frac{b}{e} = \frac{d}{f}$, which give $\frac{ab}{be} = \frac{cd}{df}$, or $\frac{a}{e} = \frac{c}{f}$.

By thus deducing different equations from the equal fractions or ratios $\frac{a}{b} = \frac{c}{d}$ an end-

less variety of sets of proportionals may be obtained; but the most general of these deductions is derived from the following principle, namely:—

If two fractions, $\frac{a}{b}, \frac{c}{d}$ are equal, then we may replace the terms a, b of the first by any expressions involving a and b that are *homogeneous* in reference to these quantities, provided we also replace the terms c, d by expressions involving c and d in the same manner. For instance—

$2a^2 - 3ab + b^2$ is homogeneous as respects a and b : each term being of two dimensions; so also is $5ab + 4a^2 - 2b^2$, we may therefore substitute these for a and b , provided we put the similar expressions $2c^2 - 3cd + d^2$ and $5cd + 4c^2 - 2d^2$ for c and d ; that is, we may infer that because—

$$\frac{a}{b} = \frac{c}{d} \therefore$$

The reason of this is pretty obvious; two fractions cannot be *equal* unless one is convertible into the other by multiplying num. and den. of the former by some factor (m); so that in the above, c must be ma and $d = mb$. Now if in the *second* of the changed fractions above you put ma, mb for their equals c and d , you will see at once that that fraction will be nothing but the *first* fraction with its num. and den. multiplied by m^2 . If the homogeneous expressions chosen for the terms of the first fraction had been of *three* dimensions, then after the substitution of ma, mb , for c, d in the similar terms of the second fraction, the result would have differed from the first fraction only by the num. and den. being multiplied by m^3 , and so on, as is obvious. The particular case of this general theorem which is most frequently employed is this, namely:—

$$\frac{a}{b} = \frac{c}{d} \therefore \frac{a \pm mb}{a \mp nb} = \frac{c \pm md}{c \mp nd}$$

or, from $a : b :: c : d$

$$\therefore a \pm mb : a \mp nb :: c \pm md : c \mp nd$$

where the values of m and n are arbitrary. In most applications they are chosen each equal to 1, or one equal to 0, and the other equal to 1. I need scarcely mention, that when any of the conditions of a question are expressed by a *proportion*, the product of the extremes equated to the product of the means converts the proportion into an *equation*.

ARITHMETICAL AND GEOMETRICAL PROGRESSIONS.

Arithmetical Progression.

An arithmetical progression is a row, or *series* of quantities, such, that each quantity, after the first, is merely the *preceding* quantity with some invariable value added to it, or subtracted from it: thus, 1, 3, 5, 7, &c., and 1, — 1, — 3, — 5, &c., are arithmetical progressions; the terms after the first in the former are obtained, each from the preceding, by adding 2; and in the latter by subtracting 2. The constant quantity thus added or subtracted is called the common difference: it is usually denoted by d ; and as d may stand for a quantity either positive or negative, the following will be the *general way* of expressing an arithmetical progression—viz.:

$$a, a + d, a + 2d, a + 3d, a + 4d, \dots a + (n-1)d;$$

where n stands for the number of the terms: the last term being evidently derived from

the first by adding to it as many times d as there are terms *after* the first; that is, $n-1$ times d ; so that calling the last term l , we have $l = a + (n-1)d$. You thus see that the problem—Given the first term, the common difference and the number of terms, to find the last term, is one of very easy solution. I shall therefore proceed to the next, which is this—

Given the first term (a) the com. diff. (d), and the number of terms (n) to find the sum of the series (S).

$$S = a + (a + d) + (a + 2d) + (a + 3d) + \dots + l,$$

or writing the terms in reverse order,

$$S = l + (l - d) + (l - 2d) + (l - 3d) + \dots + a,$$

$$\therefore \text{adding, } 2S = (a + l) + (a + l) + (a + l) + (a + l) + \dots + a + l.$$

And as there are n terms in each series for S, there must be n equal terms in this last series; that is to say,

$$2S = n(a + l) \therefore S = \frac{1}{2}n(a + l); \text{ but } l = a + (n-1)d$$

$$\therefore S = \frac{1}{2}n \{2a + (n-1)d\}$$

The foregoing expressions for l and S will enable you to determine any two of the five quantities concerned when the other three are given; as shown in the following examples.

1. The first term of an arithmetical progression is 5, and the ninth term 37; what is the common difference of the terms?

For the particular numbers here given, the formula

$$l = a + (n-1)d$$

$$\text{is } 37 = 5 + 8d \therefore d = \frac{37-5}{8} = 4.$$

Therefore, the series is 5, 9, 13, 17, 21, 25, 29, 33, 37.

2. Required $1 + 3 + 5 + 7 + 9 + \&c.$, to twenty terms.

$$S = \frac{1}{2}n \{2a + (n-1)d\}$$

$$= 10 \{2 + 19 \times 2\} = 400.$$

3. How many terms of the series $\frac{1}{2} + \frac{1}{3} + \frac{1}{6} + \&c.$ (where $d = -\frac{1}{6}$) must be taken so that the sum may be *nothing*?

$$S = \frac{1}{2}n \{2a + (n-1)d\}$$

$$\therefore 0 = \frac{1}{2}n \left\{1 - \frac{1}{6}(n-1)\right\}$$

$$= \frac{1}{2}n \left(\frac{7}{6} - \frac{n}{6}\right) \therefore 0 = 7n - n^2 \therefore 0 = 7 - n$$

$$\therefore n = 7$$

therefore, the series is $\frac{1}{2} + \frac{1}{3} + \frac{1}{6} + 0 - \frac{1}{6} - \frac{1}{3} - \frac{1}{2}$.

4. Insert four *arithmetical means* between 2 and 17. Here 2 is the first, and 17 the *sixth* term of an arithmetical progression, and we have to find the common difference.

$$l = a + (n-1)d$$

$$17 = 2 + 5d \therefore d = \frac{15}{5} = 3$$

∴ the means are, 5, 8, 11, 14; which evidently fill up the gap between the first term and the sixth; the series being 2, 5, 8, 11, 14, 17.

5. How many terms of the series $9 + 7 + 5$, &c., will give 24?

$$S = \frac{1}{2}n \{ 2a + (n-1)d \}$$

$$\therefore 24 = \frac{1}{2}n \{ 18 - 2(n-1) \} = 10n - n^2$$

$$\therefore n^2 - 10n = -24 \therefore 2n - 10 = \sqrt{100 - 96} = \pm 2$$

$$\therefore n = 4 \text{ or } 6.$$

Consequently, whether we take *four* terms of the proposed series or *six*, the sum in either case will be 24; thus—

$$\text{four terms } 9 + 7 + 5 + 3 = 24.$$

$$\text{six terms } 9 + 7 + 5 + 3 + 1 - 1 = 24.$$

EXAMPLES FOR EXERCISE.

- Find the sum of sixteen terms of the series—
 $1 + 2 + 3 + 4 + \&c.$
- Find the sum of fourteen terms of the series—
 $4 + 3 + 2 + 1 + 0 - 1 - 2 - \&c.$
- Sum the series $\frac{1}{2} + 1\frac{1}{2} + 2\frac{1}{2} + \&c.$, to twenty terms.
- Insert three arithmetical means between 2 and 0.
- Insert five arithmetical means between $\frac{1}{2}$ and $-\frac{1}{2}$.
- The first term is 5, and the fifteenth 47: what is the common difference?
- How many terms of the series $12 + 11\frac{1}{2} + 11 + 10\frac{1}{2}$, &c., must be taken to make 55?
- The first term of an arithmetical progression is 7, the common difference $-\frac{3}{2}$: required the ninth term.
- The sum of eight terms of an arithmetical series is 2, and the common difference $-1\frac{1}{2}$: required the first term.
- The first term of an arithmetical series is $-3\frac{1}{2}$, the common difference $\frac{1}{2}$: required the sum of twenty-one terms.

Geometrical Progression.

In an arithmetical progression the several terms give equal *differences*; in a geometrical progression they give equal *quotients*; and this constant quotient, arising from dividing any term by that which immediately precedes it, is called the *common ratio*. The general form for a geometrical series, continued as far as n terms, is

$$a, ar, ar^2, ar^3, ar^4, \dots, ar^{n-1}$$

where a is the first term, and r the common ratio; the last, or n th term, being $l = ar^{n-1}$; which formula enables us readily to find any remote term (the n th term) when the first term and the common ratio are given.

By glancing at the above general form for a geometrical series, you will at once see that the product of any two terms is always equal to the product of any other two equidistant from them; and that if the number of terms be *odd*, the product of the

extreme terms is always equal to the square of the middle or mean term.

product of the first and fifth terms is equal to that of the second and fourth, as also to the square of the third: that is

$$ar^4 \times a = ar^3 \times ar = (ar^2)^2 = a^2r^4.$$

When the first term of a geometrical progression is given, it is plain that we only require to know the common ratio in order to write down the succeeding terms to any extent; and from this it follows that when the leading term and any remote term are given, we may always find the intervening terms, and thus fill up the gap: for instance, if a and ar^4 be given, to find the *three* intervening terms we should divide ar^4 by a ; and knowing—from the fact that there are *five* terms altogether—that the quotient would be the *fourth* power of the ratio, we should obtain the ratio itself by taking the fourth root of that quotient: by help of the ratio, the wanting terms may be easily supplied, as noticed above. These intervening terms are called *geometrical means* between the given extremes; if only *one* mean is to be inserted between two extremes, it is found by taking the square root of the product of the extremes. Suppose, for example, it were required to find a geometrical mean between 2 and 8: then, since the square root of 8×2 , or 16, is 4, we know the mean to be this number; the progression being 2, 4, 8: if the proposed extremes had been $-2, -8$, we should have taken the *minus* root of 16, and have written the progression thus, $-2, -4, -8$: nevertheless, whether the given extremes be both *plus* or both *minus*, the square root of their product with *either* sign may be truly regarded as a *mean*, for the following are geometrical progressions, as well as those above, 2, $-4, 8$; $-2, 4, -8$: the common ratio here being -2 ; in the sets above it was 2.

Again, suppose we had to insert *two* geometrical means between 3 and 81: then, as there are *four* terms altogether, the exponent $n - 1$ above, is here 3, $\therefore 81 \div 3 = 27 = r^3 \therefore r = 3$. Hence the progression is 3, 9, 27, 81; the required *means* being 9 and 27.

To find the sum (S) of n terms of a geometrical progression.

$$\text{Since } S = a + ar + ar^2 + ar^3 + ar^4 + \dots + ar^{n-2} + ar^{n-1}$$

$$\therefore Sr = ar + ar^2 + ar^3 + ar^4 + \dots + ar^{n-2} + ar^{n-1} + ar^n.$$

Subtracting the first expression from the second—

$$Sr - S + ar^n - a \therefore S = \frac{ar^n - a}{r - 1}, \text{ or } = a \frac{r^n - 1}{r - 1}.$$

We have seen above that the last term l is ar^{n-1} , so that $rl = ar^n$, \therefore the first expression for S may be written

$$S = \frac{rl - a}{r - 1} \dots (1),$$

and this formula, expressed in words, furnishes the following rule:—

RULE.—Multiply the last term by the ratio; from the product subtract the first term, and divide the remainder by the ratio minus 1.

This rule applies, of course, whether the ratio be whole or fractional, positive or negative. When it is a *proper fraction*, the series is a *decreasing* one; and if carried on to an unlimited extent, must supply terms approaching nearer and nearer to zero or nothing, the terms at length differing from 0 by quantities too small to be assigned. Although we cannot write down such an infinite number of terms, yet we may affirm, with confidence, that they are all comprehended between these extreme limits, namely, the first term a , and 0; with these limits included; for including the 0 in the series

cannot affect the value of the *sum*. In finding this sum we may therefore regard 0 as the *last* term of the infinite decreasing series; so that, for all such series, the formula above, l being 0, will be—

$$S = \frac{a}{1-r} \dots (2);$$

and from this you see—strange as the thing may at first appear—that it is *easier* to find the entire sum of an *infinite* geometrical decreasing series, than to find the sum of three or four of its leading terms; because the formula (1) involves more calculation than the formula (2). For distinction sake, it is usual to replace the symbol S , for the sum of a *finite* series, by Σ when the series is infinite; that is, to write the formulæ (1) and (2) thus:—

$$S = \frac{rl-a}{r-1}, \quad \Sigma = \frac{a}{1-r}.$$

1. Required the sixth term and the sum of six terms of the series $1+2+4+\dots$, in which $a=1$, $r=2$, and $n=6$, $l=ar^{n-1}=2^5=32$; $S=\frac{rl-a}{r-1}=2 \times 32-1=63$.

2. Required the sum of five terms of the series $1-4=16-64+\dots$, in which $r=-4$.

$$\text{Here } l=256; S=\frac{rl-a}{r-1}=\frac{-1024-1}{-5}=205.$$

3. Required the sum to seven terms, as also to infinity of each of the series, $1+\frac{1}{2}+\frac{1}{4}+\dots$, and $1-\frac{1}{2}+\frac{1}{4}-\dots$. In the first series $r=\frac{1}{2}$, $n=7 \therefore l=ar^{n-1}=(\frac{1}{2})^6=\frac{1}{64}$.

$$\therefore S = \frac{rl-a}{r-1} = \left(\frac{1}{128}-1\right) \div -\frac{1}{2} = \frac{127}{128} \times 2 = 1\frac{63}{64}.$$

This is the sum of seven terms. When the number of terms is infinite, that is when $n=\infty$,* the sum is—

$$\Sigma = \frac{a}{1-r} = 1 \div \frac{1}{2} = 2;$$

so that the sum of the *infinite* series is just double of the first term; and you see how much more easily the sum of an infinite number of terms is found than the sum of seven terms.

In the second series $r=-\frac{1}{2}$, \therefore for the seventh term we have $l=ar^{n-1}=\left(-\frac{1}{2}\right)^6=\frac{1}{64}$

$$\therefore S = \frac{rl-a}{r-1} = \left(\frac{1}{128}-1\right) \div -\frac{3}{2} = \frac{127}{128} \times \frac{2}{3} = \frac{127}{192}.$$

$$\text{And when } n = \infty, \Sigma = \frac{a}{1-r} = 1 \div \frac{3}{2} = 1 \times \frac{2}{3} = \frac{2}{3}.$$

4. Insert five geometrical means between 2 and $\frac{1}{32}$. Here, when the means are supplied, there will be *seven* terms $\therefore n=7$; also $a=2$, and $l=\frac{1}{32}$; but $l=ar^{n-1}=2r^6 \therefore 2r^6=\frac{1}{32} \therefore r^6=\frac{1}{64} \therefore r=\pm\frac{1}{2}$.

Consequently the five means are $\pm 1, \frac{1}{2}, \pm \frac{1}{2}, \frac{1}{4}, \pm \frac{1}{4}$, so that the complete seven terms are either $2+1+\frac{1}{2}+\frac{1}{4}+\frac{1}{8}+\frac{1}{16}+\frac{1}{32}$, or $2-1+\frac{1}{2}-\frac{1}{2}+\frac{1}{4}-\frac{1}{4}+\frac{1}{8}+\frac{1}{16}$.

* This symbol stands for the word *infinite*.

EXAMPLES FOR EXERCISE.

1. Required the sum of five terms of the series $1 + 2^2 + 2^4 + 2^6 + \&c.$
2. Eight terms of $1 - \frac{1}{2} + \frac{1}{4} - \frac{1}{8} + \&c.$
3. Ten terms of $1 + 2 + 4 + 8 + \&c.$
4. What is the geometrical mean between 6 and 54?
5. Insert two geometrical means between 2 and 54.
6. Sum the series $\frac{1}{10} + \frac{1}{10^2} + \frac{1}{10^3} + \&c.$, to infinity; that is, find the true fractional value of the recurring decimal $\cdot 1111 \dots$
7. The first term of a geometrical series is 3, the common ratio 5, and the last term 375: find the sum.
8. The first term of a geometrical series is $\frac{1}{2}$, and the common ratio $-\frac{1}{2}$: find the sum to infinity.
9. Insert three geometrical means between $\frac{1}{2}$ and $\frac{2}{9}$.
10. Required the sum of the infinite series,

$$1 + \frac{1}{x} + \frac{1}{x^2} + \frac{1}{x^3} + \&c.$$

and thence deduce the values of Σ in the particular cases of $x = 2$, and $x = -2$.

Besides the two classes of progressions just treated of, there is a third kind which may here be briefly adverted to, namely, *harmonic progression*. This name is given to every series of which the terms are the *reciprocals* of those of an arithmetical progression. Thus the reciprocals of the terms of the arithmetical series $1 + 2 + 3 + \dots + n$ give the harmonic series $1 + \frac{1}{2} + \frac{1}{3} + \dots + \frac{1}{n}$. It has been found that musical strings, of equal thickness and tension, when their lengths are as the numbers 1, $\frac{1}{2}$, $\frac{1}{3}$, &c., are in harmony when sounded together; and hence the term *harmonic progression*.

There is no general formula for the *sum* of an harmonic series, but any number of harmonic *means* may be inserted between two given extremes by help of the corresponding problem in arithmetical progression. Thus:—

Insert four harmonic means between 2 and 4.

First insert four arithmetical means between $\frac{1}{2}$ and $\frac{1}{4}$, from the formula $l = a + (n - 1)d$, where $a = \frac{1}{2}$, $n = 6$, and $l = \frac{1}{4}$: we thus get $\frac{1}{4} = \frac{1}{2} + 5d$; $\therefore d = (\frac{1}{4} - \frac{1}{2}) \div 5 = -\frac{1}{20}$. \therefore since $\frac{1}{4} = \frac{1}{2} + 5d$, by applying the constant difference $-\frac{1}{20}$, we have, for the four *arithmetical* means, the quantities $\frac{3}{10}$, $\frac{2}{5}$, $\frac{1}{5}$, $\frac{1}{10}$; that is $\frac{3}{10}$, $\frac{2}{5}$, $\frac{1}{5}$, $\frac{1}{10}$; and, taking the reciprocals of these, the required *harmonic* means are

$$2\frac{2}{3}, 2\frac{1}{2}, 2\frac{1}{3}, 3\frac{1}{2}.$$

And in this way you will find that two harmonic means, between 1 and 2, are $1\frac{1}{2}$ and $1\frac{1}{3}$; and that four, between 2 and 12, are $2\frac{2}{3}$, 3, 4 and 6.

Questions in which proportion and progression are concerned.

1. Divide 18 into two parts so that the squares of those parts may be the one to the other, as 25 to 16.

Let x be one part, then $18 - x$ is the other, and by the question,

$$x^2 : (18 - x)^2 :: 25 : 16$$

$$\therefore (\text{Theo. 6 p. 219}) x : 18 - x :: 5 : 4$$

$$\text{or (p. 220) } x : 18 :: 5 : 9$$

$$\therefore (\text{Theo. 6 p. 219}) x : 2 :: 5 : 1$$

$$\therefore (\text{Theo. 1 p. 218}) x = 10 \therefore \text{the parts are 10 and 8.}$$

2. A merchant sold some brandy for £39, and gained as much per cent. as the brandy cost him. What was the original price?

Let $\text{£}x =$ the cost price, then the gain was $\text{£}x$ per £100,

$$\therefore 100 : x :: x : \frac{x^2}{100} \text{ the number of pounds gained.}$$

But the number of pounds gained was also $39 - x \therefore \frac{x^2}{100} = 39 - x$.

$$\therefore x^2 + 100x = 3900 \therefore x^2 + 100x + 50^2 = 3900 + 2500 = 6400.$$

$$\therefore x + 50 = \pm 80 \therefore x = 30 \text{ or } -130.$$

\therefore the cost price was £30; the negative value of x , though satisfying the algebraical conditions, being excluded from the nature of the question.

3. The sum of three numbers in arithmetical progression is 9, and the sum of their cubes 153. What are the numbers?

Let $x - y, x, x + y$ represent the numbers; then

$$x - y + x + x + y = 3x = 9 \therefore x = 3$$

$$(x - y)^3 + x^3 + (x + y)^3 = 3x^3 + 6xy^2 = 153 \therefore y^2 = \frac{153 - 3x^3}{6x} = 4 \therefore y$$

$= \pm 2$, \therefore the numbers are either 1, 3, 5; or 5, 3, 1; being the same set, whether the common difference y be taken positively or negatively.

4. A person travels a distance of 198 miles as follows: namely 30 miles the first day, 28 the second, 26 the third, and so on: in how many days will he have finished the journey?

Here we have an arithmetical progression, in which $a = 30$, $d = -2$, and $S = 198$, to find n , the number of terms or days.

By the formula, p. 221, $S = \frac{1}{2}n \{2a + (n-1)d\}$, that is,

$$198 = \frac{1}{2}n \{60 - (n-1)2\} = 31n - n^2 \therefore n^2 - 31n = -198.$$

$$\therefore 2n - 31 = \sqrt{31^2 - 792} = \sqrt{169} = \pm 13.$$

$$\therefore n = \frac{31 \pm 13}{2} = 22 \text{ or } 9.$$

It would seem from this result, that he might arrive at his journey's end either in 9 days, or in 22 days. But you must always remember, in solving particular questions by algebra, that the equation which embodies the conditions of the question is not

necessarily restricted to those conditions. The solution will furnish all the values which can satisfy the equation; whereas, from the limited nature of the question, some of these may be inadmissible. You perceive, in a moment, that the question solved above is of wider meaning than that proposed: it includes the proposed and something more; for it is this—namely, The sum of an arithmetical series is 198, the first term is 30, and the common difference -2 . find the number of terms. The answer is perfectly general; for the series consists of either the nine terms $30 + 28 + 26 + 24 + 22 + 20 + 18 + 16 + 14 = 198$, or of the twenty-two terms furnished by extending the series to the thirteen additional terms $+ 12 + 10 + 8 + 6 + 4 + 2 + 0 - 2 - 4 - 6 - 8 - 10 - 12$, for you see that these additional terms amount to 0; and therefore that the sum of nine terms, or of twenty-two, equally amount to 198. It is plain, therefore, that the algebra would have been imperfect if $n = 22$ had not been contained in the result, though the limitation of the question excludes it. this limitation evidently is, that each day's travel adds to the distance from the starting point: the traveller is presumed not to go back, so that a subtractive day's journey is forbidden.

5. The sum of three numbers in geometrical progression is 13; and the product of the mean and sum of the extremes is 30; required the numbers.

Let the numbers be represented by $\frac{x}{y}$, x , and xy ; the condition that they are to form a geometrical progression being thus secured.

Then the other two conditions are as follow, namely—

$$\frac{x}{y} + x + xy = 13$$

$$\text{and } \left(\frac{x}{y} + xy\right) x = 30.$$

From the first of these equations $\frac{x}{y} + xy = 13 - x \dots (A)$.

From the second $\frac{x}{y} + xy = \frac{30}{x}$, $\therefore 13 - x = \frac{30}{x}$,

$$\therefore 13x - x^2 = 30, \text{ or } x^2 - 13x = -30,$$

Consequently, by Rule II. of quadratic equations, page 213,

$$2x - 13 = \sqrt{(-120 + 13^2)} = \sqrt{49} = \pm 7,$$

$$\therefore x = \frac{13 + 7}{2} = 10, \text{ or } 3.$$

Therefore, substituting 3 for x in equation (A), we have $\frac{3}{y} + 3y = 13 - 3 = 10$ $\therefore 3 + 3y^2 = 10y$, or $3y^2 - 10y = -3$;

$$\therefore 6y - 10 = \sqrt{(-36 + 100)} = \sqrt{64} = \pm 8$$

$$\therefore y = \frac{10 \pm 8}{6} = 3, \text{ or } \frac{1}{3}$$

Hence, putting 3 for x , and 3 for y , in $\frac{x}{y}$, x , xy , the numbers are 1, 3, 9; or putting 3 for x , and $\frac{1}{3}$ for y , the numbers are 9, 3, 1; forming the same geometrical progression written in reverse order. If, instead of $x = 3$, the other value $x = 10$ had been

taken, the corresponding values of y would have been imaginary, or impossible: thus, putting 10 for x in (A), the equation becomes

$$\frac{10}{y} + 10y = 13 - 10 = 3 \therefore 10 + 10y^2 = 3y, \text{ or } 10y^2 - 3y = -10,$$

$$\therefore 20y - 3 = \sqrt{(-400 + 9)} = \sqrt{-391}, \therefore y = \frac{3 \pm \sqrt{-391}}{20}$$

These two values of y are imaginary; so that the three numbers, 1, 3, 9, determined above, are the only *real* numbers that fulfil the conditions of the question.

1. Divide 49 into two parts such, that the greater increased by 6 may be to the less diminished by 11 as 9 to 2.

2. Two hundred stones are placed in a straight line at intervals of 2 feet, the first stone being 20 yards in advance of a basket: suppose a person starting from the basket collects the stones, and returns them one by one to the basket. How much ground does he go over?

3. The sum of four numbers in geometrical progression is equal to 1 added to the common ratio; and $\frac{1}{4}$ is the first term: required the numbers.

4. From two towns 165 miles apart, A and B set out to meet each other. A travels 1 mile the first day, 2 the second, 3 the third, and so on: B travels 20 miles the first day, 18 the second, 16 the third, and so on: in how many days will they meet?

5. The sum of the first and second of four numbers in geometrical progression is 15, and the sum of the third and fourth 60: what are the numbers?

6. The sum of three numbers in geometrical progression is 35; and the mean term is to the difference of the extremes as 2 to 3: what are the numbers?

MISCELLANEOUS INVESTIGATIONS.

A few particulars connected with that portion of algebra to which the present treatise is devoted, remains to be noticed. These might have been introduced earlier, and are so introduced in most books on the subject. I have thought it expedient, however, with a view to your own facility of progress, to postpone them to this place.

To extract the square root of a polynomial.

When we set about extracting the square root of a quantity, whether a number or an algebraical expression, we proceed on the supposition that the proposed quantity is really a *square*; that is, that it is capable of being produced from two *equal* factors. You know that, in *numbers*, this is not always the case; 2, 7, 8, 10, &c., are not *squares*, and therefore, in strictness, have no *square-roots*; by the aid of decimals, however, we can *approximate*, as it is called, to the square root of any of these numbers; that is, we can find a number such that the square of it shall differ from the number

proposed by as small a decimal as we please; so that, for all *practical* purposes, the root, thus determined, may be used for that of the proposed number; since it is the *exact* root of a number differing from the proposed one, only by a decimal too minute to be appreciated. The difference here spoken of would be actually exhibited by the *remainder* left at the close of the operation; for, by subtracting this remainder from the number proposed, we should convert that number into a complete square; we always take care, in such arithmetical operations, to push the approximative process sufficiently far to render the correctional remainder of no moment, in reference to the practical inquiry in hand.

It is much the same with algebraical expressions or *polynomials*; we proceed (by the rule presently to be given) on the supposition that the square root actually exists, carrying on the process, as in arithmetic, till the terms of the polynomial have all been used up; if a remainder be left, we conclude that the polynomial is not a square, and can assign the correction necessary to make it a square; for this correction, as in arithmetic, is the *remainder*. In algebra, it is usual to stop as soon as the proposed polynomial is exhausted; the object being, in general, more to ascertain whether the expression submitted to the process is a square or not, than to seek algebraical approximations to imperfect squares. Indeed, the term *algebraical* approximation would be meaningless, as I am sure you must see; for, in the absence of all *numerical* interpretation of our symbols, how could we speak of a set of symbolical expressions *approximating*, as to value, to any other such expression? When numerical values are given to the letters, we may with propriety speak of such approximations; but, even then, what are *approximations* for some numerical values, will be *departures* for others.

Let us now take a complete algebraic square, and try to discover by what process its root may be evolved. And first, let the square be that of a binomial, namely, the square of $a + b$, which is $a^2 + 2ab + b^2$.

Now write down this expression as in the margin, and mark off a place for the root, to the right. The square root of the first term is a , which we know to be the first term of the sought root; and subtracting a^2 from the given expression, we get $2ab + b^2$ for remainder. Consider this remainder as a *dividend*, and let us see whether, by help of the term a , already in the root, we cannot discover the leading term of a *divisor* for this dividend, suited to give b , the other term of the root. A glance at the dividend shows that the proper leading term is just double the partial root a , already obtained; we therefore write $2a$ for the first term of the divisor we are seeking to form; and as, in algebra, the *first term* of a divisor is all we want, to get a term of the quotient, we at once pronounce b to be the second term of the quotient or root; and, to *complete* the divisor, we put this b , not only in the quotient, but *also* in the divisor; and we find that b times the complete divisor, $2a + b$, equals the dividend; and thus the operation terminates, and the required root is discovered.

Guided by this easy process, let us now endeavour to evolve the root from the square of a trinomial; namely, from the square of $a + b + c$, which is $(a + b)^2 + 2(a + b)c + c^2$; this being evidently the square of $(a + b) + c$. Writing the polynomial in the usual way, it would be $a^2 + 2ab + b^2 + 2(a + b)c + c^2$; and the following operation, for discovering the terms a, b, c , of the root, one after another, is in exact imitation of the operation above.

$$\begin{array}{r}
 a^2 + 2ab + b^2(a + b \\
 a^2 \\
 \hline
 2a + b \quad] \quad \frac{2ab + b^2}{2ab + b^2}
 \end{array}$$

$$\begin{array}{r}
 x^2 + 2ab + b^2 + 2(a+b)c + c^2 \quad [x + b + c \\
 \underline{x^2} \\
 2a + b] \quad \underline{2ab + b^2} \\
 \quad \quad \quad \underline{2ab + b^2} \\
 2(a+b) + c] \quad \underline{2(a+b)c + c^2} \\
 \quad \quad \quad \quad \quad \underline{2(a+b)c + c^2}
 \end{array}$$

Here the first term a of the root is found as before: we then get the remainder or *dividend* $2ab + b^2$; the double of the known portion a of the root furnishes the *trial* or *incomplete* divisor $2a$, by help of which the second term b , of the root is found; after which the divisor is completed by joining this b to the incomplete form: we then get a second remainder or *dividend* $2(a+b)c + c^2$, and take the double of what is now in the root for the corresponding incomplete divisor: this gives for quotient c , the third term of the root; and the addition of this c completes the divisor, the multiplication of which by the quotient-term c , finishes the process, as no remainder is left.

In like manner by applying the same proceeding to the square of a quadrinomial $a + b + c + d$, we should obtain the several terms of the root, one after another; the polynomial whose root is sought being written in the form

$$a^2 + (2a + b)b + (2(a + b) + c)c + d^2,$$

as a mere contemplation of this form, in connection with the above process, makes sufficiently evident. And as the square of any polynomial $(a + b + c + d + \dots + l)^2$, may be written

$$a^2 + (2a + b)b + (2(a + b) + c)c + (2(a + b + c) + d)d + \dots + l^2,$$

the process is general: it is expressed in words as follows:—

RULE 1.—Arrange the terms of the proposed polynomial as if for division, marking off a place as for quotient.

2.—Find the square root of the leading term, put it in the quotient's place, and the square of it under the leading term, which will of course be equal to it. Draw a line, as if for subtraction, and bring down, under it, the next two terms of the polynomial. these will form a *dividend*, and a place, to the left of it, is now to be marked off, for a *divisor*.

3.—Put *twice* the root-term, just found, in the divisor's place: see how often this *incomplete* divisor is contained in the leading term of the dividend, and connect the quotient, with its proper sign, both to the root-term, and to the incomplete divisor: the divisor will thus be *completed*.

4.—Multiply the complete divisor by the root-term just found, subtract the product from the dividend, and to the remainder unite the two next terms of the polynomial; and a *second* dividend will be obtained.

Proceed with this as with the former, marking off a place for a new divisor, and putting in that place *twice* the root-quantity already found, for an *incomplete* divisor, by aid of which the third root-term may be found, which, added to the incomplete divisor, renders it *complete*. And this uniform process is to be continued till all the terms of the polynomial have been brought down, as in the following examples:—

$$\begin{array}{r}
 1. \quad 9x^4 - 12x^3 + 16x^2 - 8x + 4 \quad (3x^2 - 2x + 2 \\
 \quad \quad \quad \underline{9x^4} \\
 6x^3 - 2x] \quad \underline{12x^3 + 12x^2} \\
 \quad \quad \quad \quad \quad \underline{-12x^3 + 4x^2} \\
 6x^2 - 4x + 2] \quad \underline{12x^2 - 8x + 4} \\
 \quad \quad \quad \quad \quad \quad \quad \underline{12x^2 - 8x + 4}
 \end{array}$$

$$2. \begin{array}{r} 4x^6 - 24x^5 + 60x^4 - 80x^3 + 60x^2 - 24x + 4 (2x^3 - 6x^2 + 6x - 2 \\ \underline{4x^6} \\ 4x^3 - 6x^2 \end{array} \quad \begin{array}{r} - 24x^4 + 60x^4 \\ - 24x^5 + 36x^4 \end{array}$$

$$4x^2 - 12x^2 + 6x \quad \begin{array}{r} 24x^4 - 80x^3 + 60x^2 \\ \underline{24x^4 - 72x^3 + 36x^2} \\ - 8x^3 + 24x^2 - 24x + 4 \\ - 8x^3 + 24x^2 - 24x + 4. \end{array}$$

$$3. \begin{array}{r} a^{4m} - 4a^{3m} + n + 6a^{2m} + 2n - 4a^m + 2n + a^{4n} (a^{2m} - 2a^m + n + a^{2n} \\ \underline{a^{4m}} \\ 2a^{2m} - 2a^n + n \end{array} \quad \begin{array}{r} - 4a^{3m} + n + 6a^{2m} + 2n \\ - 4a^{3m} + n + 4a^{2m} + 2n \\ 2a^{2m} - 4a^n + n + a^{2n} \end{array}$$

$$4. \begin{array}{r} 4x^4 - 4x^3 - 8x^2 + 2x + 4 (2x^2 - x - 1 \\ \underline{4x^4} \\ 4x^2 - x \end{array} \quad \begin{array}{r} - 4x^3 - 3x^2 \\ - 4x^3 + x^2 \end{array}$$

$$4x^2 - 2x - 1 \quad \begin{array}{r} - 4x^2 + 2x + 4 \\ - 4x^2 + 2x + 1 \\ \hline 3 \end{array}$$

In this example there is a *remainder*, after all the terms of the proposed polynomial have been used: we infer therefore that the polynomial is not a complete square; but that it would be made one, by subtracting 3 (the remainder) from it: the expression $2x^2 - x - 1$ is the complete square root of $4x^4 - 4x^3 - 3x^2 + 2x + 1$: the polynomial proposed cannot be produced from two *equal* factors: it is the product of the unequal factors $(2x^2 - x - 1 + \sqrt{-3})(2x^2 - x - 1 - \sqrt{-3})$.

EXAMPLES FOR EXERCISE.

Extract the square root of each of the following expressions:—

- | | |
|--|-----------------------------------|
| 1. $x^2 + 4bx + 4b^2$. | Root, $x + 2b$. |
| 2. $9x^4 + 12x^3 + 10x^2 + 4x + 1$. | Root, $3x^2 + 2x + 1$. |
| 3. $9x^4 + 12x^3 + 34x^2 + 20x + 25$. | Root, $3x^2 + 2x + 5$. |
| 4. $x^6 + 4x^5 + 2x^4 + 9x^2 - 4x + 4$. | Root, $x^3 + 2x^2 - x + 2$. |
| 5. $x^6 - 4x^5 + 10x^4 - 4x^3 - 7x^2 + 24x + 16$. | Root, $x^3 - 2x^2 + 3x + 4$. |
| 6. $4x^4 + 6x^3 + \frac{89}{4}x^2 + 15x + 25$. | Root, $2x^2 + \frac{3}{2}x + 5$. |

In this last example you may, if you please, multiply the polynomial by 4, in order to get rid of the fraction: the square root of the result will, of course, be the square root of the given expression, multiplied by the square root of 4: that is, by 2; you must, therefore, remember to divide the root by 2.

The above general rule, for the square root of an algebraical expression, applies, of course, to *numbers*; and suggests the arithmetical operation given at page 40 of the *Arithmetic*. The first step in this operation, is to separate the figures of the number into periods, by marking off two figures, commencing at the units' place, then two to

the left of these, and so on. This enables us to determine the *local value* of the leading figure of the root, and thence the number of integer-places in the complete root. Thus, taking for example the number 76807696 we see, by help of the periods, that the first figure of the root must be in the place of *thousands*, the *square* of it being so many millions, like the 76 in the first period. The detailed operation, as suggested by the Algebra, is therefore as follows :—

$$\begin{array}{r}
 76,80,76,96(8000 + 700 + 60 + 4 = \\
 \underline{64\ 00\ 00\ 00} \quad 8700 + 60 + 4 = \\
 16000 + 700 = 16700)12\ 80\ 76\ 96 \quad 8760 + 4 = 8764 \\
 \underline{11\ 69\ 00\ 00} \\
 17400 + 60 = 17460) \quad 1\ 11\ 76\ 96 \\
 \underline{1\ 04\ 76\ 00} \\
 17520 + 4 = 17524) \quad 7\ 00\ 96 \\
 \underline{7\ 00\ 96}
 \end{array}$$

The above operation is the same, in principle, as that at page 40 of the Arithmetic ; by a reference to which you will see that the more compact form, which the work assumes in the place referred to, arises merely from the suppression of the useless *ciphers* or *noughts*, and the postponement of the successive periods till they are actually wanted in the several dividends.

—

To extract the square root of a binomial, one of whose terms is rational, and the other a quadratic surd.

It sometimes happens that expressions of the form $\sqrt{a + \sqrt{b}}$ occur in the results of algebraical problems : if they be left in this form, and then when a and b are interpreted, the operations of arithmetic be applied to them, you see that if b is irrational, we shall have to find the square root of b to a certain number of decimals, and then to extract the square root of $a + \sqrt{b}$, a quantity *necessarily* involving decimals. The square root of b , may be taken out of a table of square roots to several decimal places, when b consists of not more than four or five figures ; but the square root of a number consisting of three or four figures, followed by five or six decimals, cannot be found to any degree of nicety by existing tables ; so that, in such a case, the arithmetical operation must be executed. As I have told you before, algebraists seek such a form for their results as will give arithmeticians the least trouble in the numerical computation of them ; and this is one reason why they have sought to convert $\sqrt{a + \sqrt{b}}$, into the simpler form $\sqrt{a'} + \sqrt{b'}$.

In order to show you how this is done, a theorem or two respecting binomial surds must first be established.

1. The square root of a quantity cannot be *partly* rational and *partly* a quadratic surd : that is to say, the condition $\sqrt{p} = q + \sqrt{r}$ is impossible, provided p and r are not themselves squares.

For, assuming this equation to be possible, we should have, by squaring each side $p = q^2 + 2q\sqrt{r} + r$, so that $\sqrt{r} = \frac{p - q^2 - r}{2q}$, a rational quantity, which is contrary to the supposition, as it shows that r must be the *square* of the second member of this equation.

2. In every equation of the form $a + \sqrt{b} = x + \sqrt{y}$, where a , and x are *rational* quantities, and \sqrt{b} *irrational* or *surd*, a must be equal to x , and therefore b to y . For if a and x had any difference, then by transposing the a , we should have the square root of a quantity, not itself a square, expressed either by a rational quantity, which is absurd, or by a quantity partly rational and partly irrational, which has been shown above to be impossible. It follows that \sqrt{y} must be irrational as well as \sqrt{b} .

3. If $\sqrt{a + \sqrt{b}} = x + y$: then must $\sqrt{a - \sqrt{b}} = x - y$; where \sqrt{b} is a quadratic surd, and x, y one or both also quadratic surds.

For by squaring the first equation $a + \sqrt{b} = x^2 + 2xy + y^2$, where $x^2 + y^2$ is necessarily *rational*, and $\therefore 2xy$ irrational (by 2 above) being equal to \sqrt{b} : that is (by 2),

$$a = x^2 + y^2, \sqrt{b} = 2xy, \therefore a - \sqrt{b} = x^2 - 2xy + y^2, \therefore \sqrt{a - \sqrt{b}} = x - y.$$

By help of this latter principle, combined with theo. 2 above, the extraction of the square root of a binomial surd consisting of a rational term, and of a quadratic irrational term, may be effected, as in the following examples:—

1. Extract the square root of $7 + 2\sqrt{10}$.

$$\text{Put } \sqrt{7 + 2\sqrt{10}} = x + y, \therefore \sqrt{7 - 2\sqrt{10}} = x - y;$$

\therefore taking the product, $\sqrt{49 - 40} = x^2 - y^2, \therefore 3 = x^2 - y^2$.

$$\text{But } 7 + 2\sqrt{10} = x^2 + 2xy + y^2, \therefore 7 = x^2 + y^2, \therefore 10 = 2x^2, 4 = 2y^2$$

$$\therefore x = \sqrt{5}, y = \sqrt{2}, \therefore \sqrt{7 + 2\sqrt{10}} = \sqrt{5} + \sqrt{2}.$$

You will at once see that the change of $\sqrt{7 + 2\sqrt{10}}$ into $\sqrt{5} + \sqrt{2}$ facilitates the arithmetical computation: a table of square roots gives us $\sqrt{5} = 2.2360680$, and $\sqrt{2} = 1.4142136$;* so that the root sought is 3.6502816. If the unchanged form be used, we should have, from the table, $\sqrt{10} = 3.1622777$; twice this increased by 7 is 13.3245554, and the square root of this we should have to find by actual extraction, on account of the necessarily limited extent of the tables.

2. Find the square root of $10 - \sqrt{96}$.

$$\text{Put } \sqrt{10 + \sqrt{96}} = x + y, \therefore \sqrt{10 - \sqrt{96}} = x - y.$$

$$\therefore \sqrt{100 - 96} = x^2 - y^2 = 2. \quad \left. \begin{array}{l} \therefore \sqrt{100 - 96} = x^2 - y^2 = 2. \\ \therefore x^2 + y^2 = 10 \end{array} \right\} \therefore x^2 = 6, y^2 = 4,$$

$$\text{Also } x^2 + 2xy + y^2 = 10 + \sqrt{96}, \therefore x^2 + y^2 = 10 \quad \therefore x^2 = 6, y^2 = 4,$$

$$\therefore \sqrt{10 - \sqrt{96}} = \sqrt{6} - 2.$$

3. Find general expressions for the square roots of $a + \sqrt{b}$, and $a - \sqrt{b}$.

Putting $x + y$, and $x - y$, for the required roots, we have—

$$\left. \begin{array}{l} a + \sqrt{b} = x^2 + 2xy + y^2 \\ a - \sqrt{b} = x^2 - 2xy + y^2 \end{array} \right\} \therefore x^2 + y^2 = a$$

$$\text{Also } x^2 - y^2 = \sqrt{a^2 - b}$$

By adding and subtracting

$$x^2 = \frac{a + \sqrt{a^2 - b}}{2}, y^2 = \frac{a - \sqrt{a^2 - b}}{2}$$

* See Barlow's Tables, revised by Professor De Morgan, and published under the superintendence of the Society for the Diffusion of Useful Knowledge.

therefore $x + y, x - y$, that is $\sqrt{a + \sqrt{b}}$ and $\sqrt{a - \sqrt{b}}$ are respectively

$$\sqrt{a + \sqrt{b}} = \sqrt{\frac{a + \sqrt{a^2 - b}}{2}} + \sqrt{\frac{a - \sqrt{a^2 - b}}{2}}$$

$$\sqrt{a - \sqrt{b}} = \sqrt{\frac{a + \sqrt{a^2 - b}}{2}} - \sqrt{\frac{a - \sqrt{a^2 - b}}{2}}$$

These general expressions show that, whenever $a^2 - b$ is not a square, nothing is gained by changing $\sqrt{a \pm \sqrt{b}}$ into the new form, but in fact something lost in the way of simplification. The changed form is less complex than the original only when $a^2 - b$ is a square: it is prudent, therefore, to ascertain whether or not this be the case, before entering upon the proposed transformation; and to leave the form unchanged if $a^2 - b$ be not a square.

EXAMPLES FOR EXERCISE.

- | | |
|--|---|
| 1. $\sqrt{19 + 8\sqrt{3}} = 4 + \sqrt{3}$ | 2. $\sqrt{12 - 4\sqrt{10}} = \sqrt{7} - \sqrt{5}$ |
| 3. $\sqrt{7 - 2\sqrt{10}} = \sqrt{5} - \sqrt{2}$ | 4. $\sqrt{8 + \sqrt{39}} = \frac{1}{2}(\sqrt{26} + \sqrt{6})$ |
| 5. $\sqrt{76 - 32\sqrt{3}} = 8 - 2\sqrt{3}$ | 6. $\sqrt{31 + 12\sqrt{-5}} = 6 + \sqrt{-5}$ |

On Multipliers which render binomial surds rational.

It has already been noticed (page 195) that it is in general inconvenient to have the result of an algebraic operation in the form of a fraction with a surd denominator; and when the surd so occurring is *monomial*, the means of removing it have been explained. I am now to show you how, in like manner, a fraction having a binomial surd $\sqrt{a + \sqrt{b}}$ or $\sqrt{a - \sqrt{b}}$ for denominator, may be converted into an equivalent fraction with a rational denominator; in other words, I am to explain the method of *rationalizing* binomial surds of the above form. This is very easy, the rationalizing multiplier being at once suggested from the binomial surd itself: if it be $\sqrt{a + \sqrt{b}}$, the multiplier is obviously $\sqrt{a - \sqrt{b}}$; and if it be $\sqrt{a - \sqrt{b}}$, the multiplier is $\sqrt{a + \sqrt{b}}$; and you thus have a useful application of the principle that the *sum* multiplied by the *difference* of two quantities gives the difference of their squares. Suppose, for example, our fraction is $\frac{3}{\sqrt{5} + \sqrt{7}}$, a form which is inconvenient for computation, because after getting $\sqrt{5} + \sqrt{7}$ we should have the troublesome operation of dividing 3 by a number consisting of many figures. But by multiplying numerator and denominator by $\sqrt{5} - \sqrt{7}$, we change the fraction into $\frac{3(\sqrt{5} - \sqrt{7})}{5 - 7} = \frac{3}{2}(\sqrt{7} - \sqrt{5})$, by which change the long division spoken of is avoided.

As a second example, let $\frac{\sqrt{3} + 1}{5 - \sqrt{3}}$ be proposed. The rationalizing multiplier here is $5 + \sqrt{3}$, and the changed fraction is $\frac{(\sqrt{3} + 1)(5 + \sqrt{3})}{25 - 3} = \frac{4 + 3\sqrt{3}}{11}$.

Sometimes the binomial surd to be rationalized is of the form $\sqrt{a \pm \sqrt{b}}$: in this case the suitable multiplier will be *trinominal*: it will consist of the *squares* of both the

irrational terms, and of their product with changed sign, as actual multiplication will show; for

$$(\sqrt[3]{a} \pm \sqrt[3]{b})(\sqrt[3]{a^2} \mp \sqrt[3]{ab} + \sqrt[3]{b^2}) = a + b.$$

The rationalizing multiplier is therefore easily remembered: the following is an example of its application:—

Convert the fraction $\frac{5}{\sqrt[3]{5} - \sqrt[3]{2}}$ into an equivalent one with a rational denominator.

$$\frac{5}{\sqrt[3]{5} - \sqrt[3]{2}} = \frac{5(\sqrt[3]{25} + \sqrt[3]{10} + \sqrt[3]{4})}{5 - 2} = \frac{5}{3}(\sqrt[3]{25} + \sqrt[3]{10} + \sqrt[3]{4})$$

And this form, though involving *three* cube-roots, is of easier calculation than the original, if tables of cube-roots are used; because there is no long-division operation.

EXAMPLES FOR EXERCISE.

Prove that—

1. $\frac{3}{2\sqrt[3]{7} - 3\sqrt[3]{2}} = \frac{3}{10}(2\sqrt[3]{7} + 3\sqrt[3]{2}).$

2. $\frac{2 + \sqrt[3]{3}}{3 + \sqrt[3]{3}} = \frac{3 + \sqrt[3]{3}}{6}.$

3. $\frac{\sqrt[3]{6}}{\sqrt[3]{8} + \sqrt[3]{3}} = \frac{4\sqrt[3]{3} - 3\sqrt[3]{2}}{5}.$

4. $\frac{2}{\sqrt[3]{3} - \sqrt[3]{2}} = 2(\sqrt[3]{9} + \sqrt[3]{6} + \sqrt[3]{4}).$

5. $\frac{5}{\sqrt[3]{7} - \sqrt[3]{5}} = \frac{5}{2}(\sqrt[3]{49} + \sqrt[3]{35} + \sqrt[3]{25}).$

6. $\frac{\sqrt[3]{12} - \sqrt[3]{10}}{\sqrt[3]{6} + \sqrt[3]{5}} = 11\sqrt[3]{2} - 4\sqrt[3]{15}.$

To Extract the Cube Root of a Compound Quantity.

In order to discover the means of arriving at the cube root of a polynomial, we may proceed in imitation of the course adopted for the determination of the square root. Thus, to begin with the simplest case, let us take the cube of $a + b$; that is, the expression $a^3 + 3a^2b + 3ab^2 + b^3$; and, availing ourselves of our previous knowledge of the cube root of this expression, let us inquire by what steps it may be evolved.

We see that the first term a of the root is at once obtained from the leading term of the polynomial; we thus have the step

$$\begin{array}{r} a^3 + 3a^2b + 3ab^2 + b^3(a) \\ \underline{a^3} \\ 3a^2b + 3ab^2 + b^3 \end{array}$$

and regarding the remainder, here exhibited, as a dividend, it remains to find a divisor of it, such that the quotient may be b . It is plain that three times the square of the root term a , just found, taken as a *trial* or incomplete divisor, suffices to suggest the second term b of the root; and we see, moreover, that if three times the product of the *two* root terms, a and b , as also the square of b , be added to the trial divisor $3a^2$, that the complete divisor, corresponding to the quotient b , will be obtained; hence the finished process is as follows:

$$\begin{array}{r} a^3 + 3a^2b + 3ab^2 + b^3(a + b) \\ \underline{a^3} \\ 3a^2 + 3ab + b^2 \end{array} \begin{array}{r} a^3 + 3a^2b + 3ab^2 + b^3(a + b) \\ \underline{3a^2b + 3ab^2 + b^3} \\ 3a^2b + 3ab^2 + b^3 \end{array}$$

If the root consist of three terms $a + b + c$, that is, if the polynomial be $(a + b + c)^3$,

or $(a + b)^3 + 3(a + b)^2c + 3(a + b)c^2 + c^3$, then the portion $(a + b)^3$ of this polynomial may be exhausted, as above, and the first two terms $a + b$ of the root thus found. And, just as in the former case, b was derived from a , so here it is plain that c may be derived from $a + b$. From these considerations the following rule is suggested :

RULE.—Arrange the terms according to the powers of one of the letters, as in the operation for the square root. Put the cube root of the leading term in the quotient's place, subtract the cube of it from the polynomial, bringing down the next *three* terms for a dividend, to the left of which mark off a place for the divisor. In this place put *three times* the square of the root term just found ; this will be the *trial divisor*, and the quotient it suggests will be the second term of the root.

To *three times* the product of this new term and the preceding, add the square of the new term, and connect the result to the trial divisor ; the whole will be the *complete divisor*.

Multiply the complete divisor by the new term, subtract the product from the dividend, and annex three more terms of the polynomial to the remainder ; the whole will be the second dividend.

For the corresponding trial divisor put *three times* the square of the root-quantity now found, in the divisor's place ; and with this trial divisor find the third term of the root ; and then complete the divisor, by adding to what is already in the divisor's place *three times* the product of the new term and the preceding part of the root, and also the square of the new term ; proceed then as in division, adding three new terms of the polynomial to the remainder ; and so on, till all the terms of the polynomial have been brought down.

You will perceive that the principal part of the work consists in forming the successive divisors, each of which is made up of *three* portions—namely, thrice the square of the part of the root previously obtained, thrice the product of this part and the new term, and the square of that new term. The first of these portions is what I have called the *trial divisor* ; but you will not fail to notice, that, as in the operation for the square root, the *leading term* of the *first* divisor is always sufficient to make known any subsequent term of the root ; so that after the first divisor is obtained, every new term of the root may be discovered at once, without the aid of any special trial divisor ; and therefore every subsequent divisor may be inserted at once, in its proper place, and in its complete form.

The following is an example of the operation :—

$$\begin{array}{r}
 x^5 - 6x^4 + 15x^3 - 20x^2 + 15x - 6x + 1 \quad (x^3 - 2x + 1) \\
 \underline{x^5} \\
 3x^4 - 6x^3 + 4x^2 \\
 \underline{ - 6x^3 + 15x^2 - 20x^3} \\
 3x^4 - 12x^3 + 15x^2 - 6x + 1 \\
 \underline{ - 6x^3 + 12x^4 - 8x^3} \\
 3(x^3 - 2x)^2 + 3(x^3 - 2x) + 1
 \end{array}$$

As a second example, the following may be taken :—

$$\begin{array}{r}
 27x^5 - 54x^4 + 63x^3 - 44x^2 + 21x^2 - 6x + 1 \quad (3x^3 - 2x + 1) \\
 \underline{27x^5} \\
 27x^4 - 18x^2 + 4x^2 \\
 \underline{ - 54x^3 + 63x^4 - 44x^3} \\
 27x^4 - 36x^3 + 21x^2 - 6x + 1 \\
 \underline{ - 54x^3 + 36x^4 - 8x^3} \\
 3(3x^3 - 2x)^2 + 3(3x^3 - 2x) + 1
 \end{array}$$

The operation conducted as above is tolerably short; but there is some work, in finding the several divisors, which does not appear to the eye in looking at the finished form. I am going to show you another mode of proceeding, much more complicated in appearance, but very simple indeed in the performance. It presents to the eye three columns of work, as below; they are formed thus:—

Write down 0, 0, and the given polynomial, as the leading quantities of three vertical columns of work; and then proceed to fill up the column thus:—Put the first term of the root not only in the quotient's place, but also under the first 0; to which, for uniformity sake, you may consider it to be *added*; multiply the sum by the same root term, and add the product to the next 0; multiply the sum still by the same root term, and *subtract* the product from the polynomial, bringing down, however, only *three* terms for remainder.

Return to the first column, and add the same term anew, multiplying the sum and carrying the product to the second column as before, but not extending the work to the third column. Return *again* to the first column, repeating the former operation, and there stop. With the last result in the second column, taken as a trial divisor, find the second term of the root; and go over with *this* exactly the same process, extending the several columns, by successive additions, till the polynomial is exhausted. As an inspection of the operation will convey a clearer idea of the several steps than words will do, I here give the work of the last example in the form proposed.

$$\begin{array}{r}
 0 \qquad \qquad 0 \quad 27x^6 - 54x^5 + 63x^4 - 44x^3 + 21x^2 - 6x + 1 \quad (3x^2 - 2x + 1 \\
 \underline{3x^2} \qquad \qquad 9x^4 \quad 27x^6 \\
 3x^2 \qquad \qquad 9x^4 \qquad \qquad - 54x^5 + 63x^4 - 44x^3 \\
 \underline{3x^2} \qquad \qquad 18x^4 \qquad \qquad - 54x^5 + 36x^4 - 8x^3 \\
 6x^2 \qquad \qquad 27x^4 \qquad \qquad \qquad \qquad 27x^4 - 36x^3 + 21x^2 - 6x + 1 \\
 \underline{3x^2} \qquad \qquad \qquad \qquad - 18x^3 + 4x^2 \qquad \qquad 27x^4 - 36x^3 + 21x^2 - 6x + 1 \\
 9x^2 \qquad \qquad 27x^4 - 18x^3 + 4x^2 \\
 \underline{- 2x} \qquad \qquad \qquad \qquad - 18x^3 + 8x^2 \\
 9x^2 - 2x \qquad \qquad 27x^4 - 36x^3 + 12x^2 \\
 \underline{- 2x} \qquad \qquad \qquad \qquad \qquad \qquad 9x^2 - 6x + 1 \\
 9x^2 - 4x \qquad \qquad 27x^4 - 36x^3 + 21x^2 - 6x + 1 \\
 \underline{- 2x} \\
 9x^2 - 6x \\
 \underline{\qquad \qquad \qquad 1} \\
 9x^2 - 6x + 1
 \end{array}$$

NOTE.—It would be very easy to contrive means of abridging the work here exhibited in the fullest detail: but a learner will more clearly see the entire texture of the process by having every item of it thus put before him.

By the very same process the fifth root, the seventh root, and indeed any root whatever of a polynomial, may be extracted: we have only to form, as above, as many columns of work as are sufficient to mark the number of the root; that is, five columns for the fifth root, seven for the seventh root, and so on; to construct the first column by that number of additions of the first root-term, of the second root-term, and so on; and to carry on the formation of the other columns as above. Whether you adopt this

method of arranging the work of extracting the cube-root of a *polynomial* or *not*, it is the arrangement I would recommend you always to observe, in extracting the cube-root of a *number*; as it precludes the necessity of retaining in the memory a somewhat intricate rule: nothing can be more easy to remember than the very simple series of recurring operations of which the several steps of the following process are made up: the close of each of these steps I have marked by an Egyptian figure, in order that you may the more distinctly see where one step of the operation ends, and another begins. I call that a *step* which comprises the work between the determination of one root-figure and that of the immediately succeeding figure.

1. Required the cube root of 3 to five or six places of decimals

0	0	3(1.442249 . .
1	1	1
—	—	— 1
1	1	2
1	2	1.744
—	— 1	— 2
2	2	.256
1	1.36	.241984
— 1	—	— 3
3	4.36	14016
.4	1.52	1245888
—	— 2	— 4
3.4	5.88	1557,112
.4	.1696	1248
—	—	—
3.8	6.0496	309
4	.1712	249
— 2	— 3	—
4.2	6.2208	60
4	8644	56
—	—	—
4.24	6.229444	1
4	8648	
—	— 4	—
4.28	6, .2,3,8092	
4		
— 3		
4.32		
2		
—		
4.322		
2		
—		
4.324		
2		
— 4		
4.326		

[NOTE.—This example is placed first, instead of third, for the convenience of printing: the two examples next following may be examined before it, as they are somewhat more simple.]

2. Required the cube root of 188119224.

0	0	188,119,224(574
5	25	125
—	—	— 1
5	25	64119
5	50	60193
—	— 1	— 2
10	75	3026224
5	1009	3026224
— 1	—	—
15	8599	
7	1148	
—	— 2	
157	9747	
7	6856	
—	—	
164	981556	
7		
— 2		
171		
4		
—		
1714		

3. Required the cube-root of 469,640,998,917.

0	0	469,640,998,917(7773
7	49	343
—	—	— 1
7	49	126640
7	98	113533
—	— 1	— 2
14	147	13107998
7	1519	12564433
— 1	—	— 3
21	16219	543565917
7	1568	543565917
—	— 2	—
217	17787	
7	16219	
—	—	
224	1794919	
7	16268	
— 2	— 3	
231	1811187	
7	69939	
—	—	
2317	181188639	
7		
—		
2324		
7		
— 3		
2331		
3		
—		
23313		

It is easy to foresee that after the step marked 4 (Ex. 1) is reached, the work of the subsequent steps can have little or no influence upon the *three* leading figures 6·23 of the forthcoming *divisors*, so that regarding these three figures as constant, and recognising the others, 8092, only for the sake of what is *carried* from them, we may, as above, make sure of at least *three* true decimals of the root, beyond the three already found, by *common division*, provided we reject a figure of the constant divisor, 6·23, at each step, taking care to secure accuracy in the carryings from the rejected figures.

When you arrive at the *Theory of Equations*, you will find a systematic method of applying such contractions fully explained, as also a complete investigation of the principles on which the foregoing practical operations depend: what is here exhibited is only a small isolated portion of a department of modern Algebra of very comprehensive scope, and of as much theoretical interest as of practical utility.

Ex. 1. The cube-root of $x^6 + 9x^3 + 6x^4 - 99x^3 - 42x^2 + 441x - 343$ is $x^2 + 3x - 7$.

2. The cube-root of $x^6 + 6x^5 + 40x^3 - 96x - 64$, that is of $x^6 + 6x^5 + 0x^4 - 40x^3 + 0x^2 + 96x - 64$, is $x^2 + 2x - 4$.

3. The cube-root of 12994449551 is 2351.

4. The cube-root of 2 is 1·25992104989

5. The cube-root of 959 is 9·8614218.

6. The cube-root of $x^6 - 15x^3y + 69x^2y^2 - 138x^2y^4 - 60xy^5 - 8y^6$ is $x^2 - 5xy - 2y^2$

I here conclude the treatise on Elementary Algebra. The subject in its widest acceptation is one of very considerable extent—I might almost say of unlimited extent; as there are no definite bounds to its operations. In the preceding treatise, my object has been to unfold to you, fully and perspicuously, the leading principles of the science; and thus to lay a sufficiently secure basis for future researches. There is one department of the subject—the general theory of Logarithms and Series—which I have not touched upon here. It is a part of Algebra which is marked by peculiar features, and is occupied with investigations different in kind and in object from those necessary for the solution of an algebraical equation, or for the reduction of an algebraical expression; and is, moreover, of sufficient importance to merit distinct consideration.

J. R. YOUNG.

PLANES :

BEING THE FIRST TWENTY-ONE PROPOSITIONS OF THE ELEVENTH BOOK OF
EUCLID'S GEOMETRY.

[THE Elements of Euclid, given with considerable detail in a former treatise, were limited to the subject of *plane* Geometry, as this furnishes basis sufficient for *plane* Trigonometry. The Geometry of Planes and Solids was intended to have been postponed till our treatise on Spherical Geometry rendered its introduction necessary. But as the consideration of Mechanical Forces in Space, and the science of Crystallography will very shortly appear in another department of the "CIRCLE," we have thought it advisable to introduce Solid Geometry in this place. Moreover, several of the subjects included in this volume will be more simply treated, and more easily understood, if a knowledge of some of the elementary properties of planes and straight lines be previously acquired. For instance, the calculation of the solid contents of an earth-work will be best given in the Treatise on Mensuration; but this calculation, of course, depends on the relations of solid space. Again, we propose to present the reader with a short treatise on linear perspective—a subject which, if treated as a science, and not merely as an art, also involves a knowledge of the elementary relations of solid space: the subject of Spherical Trigonometry, likewise, is best given in the present volume; and this science, as its name denotes, treating of triangles which are described on the surface of a sphere, cannot be taught without reference both to the properties of planes and to the elementary propositions of Spherical Geometry.]

The treatise on planes contains the first twenty-one propositions of the Eleventh Book of Euclid's Geometry, with so many definitions as are requisite to enable the student fully to understand them; and the Author has himself explained the object he had in view in drawing up the Treatise on Spherical Geometry.—THE EDITOR.]

Introduction.—The figures, lines, angles, &c., the properties of which form the subject of the First Six Books of Euclid's Geometry, are supposed to lie in one plane, * *i. e.* of length and breadth. or to be in space of two dimensions.* The following treatise contains few elementary propositions on the relations between lines, angles, &c., which do not lie in one plane, but are in solid space,—or space of *three dimensions*.† The student will find the following propositions very easy, + *i. e.* of length, breadth, and thickness. *when once he has distinctly conceived the meaning of their enunciations.* The figures which are given to each proposition cannot represent the proposition to the eye so perfectly as in the former books, in consequence of their having to be drawn in perspective. It is hoped, however, that the shading introduced into the diagrams will aid the student in conceiving the proposition they belong to.

It is to be added, that, as in Plane Geometry, we are allowed to draw lines in any direction, and to produce them to any extent, so in solid Geometry we are allowed to draw planes in any direction, and to produce them to any extent. Moreover, two lines intersect in a point; in like manner it will be shown that two planes intersect in a line. Also, as we may suppose, a line to revolve round a point till it comes to a point on its plane, so we may suppose a plane to revolve round a given line until it comes to a given point situated anywhere in space.

DEFINITIONS.

I.

A straight line is perpendicular, or at right angles to a plane, when it makes right angles with every straight line in that plane which meets it.

Thus, if BD be a plane, PA a line perpendicular to it. Through A draw any lines AB , AC , AD . . . in that plane, then will PAB , PAC , PAD , &c., be right angles.

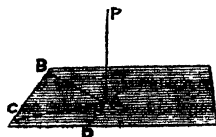

II.

A plane is perpendicular to a plane, when a straight line drawn in one plane perpendicular to the intersection of the planes is at right angles to the other plane.

Thus, let ABD , ABC , be two planes, let the former be perpendicular to the latter, and let AB be the line of intersection of the planes in the plane ABD , draw PN at right angles to AB . Then is PN at right angles to the plane ABC .

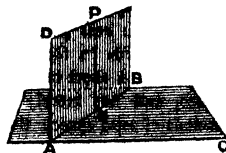

III.

The inclination of a straight line to a plane, is the acute angle contained by that straight line, and another drawn from the point in which the first line meets the plane, to the point in which a perpendicular to the plane drawn from any point of the first line above the plane meets the same plane.

Thus, let ANB be a plane, AP a line meeting the plane in A ; from P draw PN perpendicular to the plane, and meeting the plane in N . Join AN , then the angle PAN is the inclination of the line PA to the plane ANB .

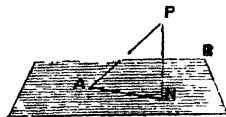

IV.

The inclination of a plane to a plane, is the acute angle contained by two straight lines drawn from any one point of their common section at right angles to it, one upon one plane, the other upon the other.

Let PAC , PBC be two planes intersecting in the line PC . From P in the former plane, draw PA at right angles to PC ; and from the same point P on the latter plane, draw PB at right angles to PC . Then, if BPA be an acute angle, this is the inclination of the planes to each other.

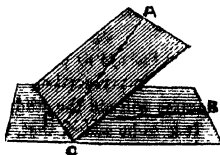

V.

Two planes have the same inclination to one another which two other planes have, when the said angles of inclination are equal to one another.

VI.

Parallel planes are such as do not intersect, though produced ever so far in all directions.

VII.

A solid angle is that which is made by the meeting of more than two plane angles, which are not in the same plane, in one point.

PROPOSITION I.—THEOREM.

One part (AB) of a straight line (ABC) cannot be in a plane, and another part (BC) be above it.

For let us suppose this possible, then since the straight line AB is in the plane, it can be produced in that plane: let it be produced to D. Now, suppose a plane to pass through the straight line AD, and let it be turned round that line, till it comes to the point C. Then because B and C are in the plane, the straight line BC is in it: * ∴ there



* 6 Def. I. are two straight lines ABC, ABD in the same plane, having a common
 † Cor. 11 I. segment AB, which is impossible. † Q. E. D.

PROPOSITION II.—THEOREM.

Two straight lines (AB, CD) which cut one another (in the point E) are in one plane. And three straight lines (BC, CE, EB) which meet one another, are in one plane.

Let any plane pass through EB, and let the plane be turned about EB produced if necessary, until it pass through the point C. Then because the

* 6 Def. I. points C and E are in this plane, the line CE is in it.*
 For the same reason the straight line BC is in the same plane, and by the hypothesis EB is in it; ∴ the three straight lines BC, CE, EB are in one plane. But AB is in the same plane as EB, and DC
 † 1 XI. as EC. † Also AB and DC are in the same plane.
 Q. E. D.

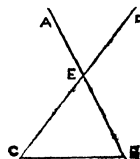

PROPOSITION III.—THEOREM.

If two planes (AB, BC) cut one another, their common section (DB) is a straight line.

For, if not, since D, B are points in the plane AB, draw the straight line DFB in that plane, and similarly draw the line DEB in the plane BC. Then because these two straight lines have the same extremities, they enclose a

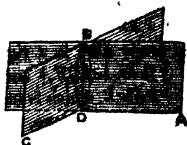

* 10 Ax. I. space, which is absurd; ∴ the common section BD cannot but be a straight line. Q. E. D.

PROPOSITION IV.—THEOREM.

If a straight line (EF) is at right angles to each of two straight lines (AB, CD) at their point of intersection (E), it shall also be at right angles to the plane (ADBC), which passes through them, i. e., to the plane in which they are.

Take the straight lines EA, EB, EC, ED equal to each other. Join AD and BC. In the plane AD BC draw through E, any line GEH, meeting AD and BC in G and H; we are to show that FE is perpendicular to GH. For join FA, FB, FC, FD, FG, FH. Now, because in the triangles AED, BEC, the sides AE, ED = the sides CE, EB, and the

* 15 I. angle AED = angle CEB,* \therefore AD = BC,

† 4 I. and angle DAE = angle ECB.† Again, in

* 15 I. triangles AGE, EBH we have the angle AEG = angle BEH;* and by what we have proved, angle GAE = EBH, and the side AE = side EB; \therefore GE = EH,

† 26 I. and AG = BH.† Again, since the sides AE, EF are equal to the sides

* Ax. 11 I. DE, EF each to each, and the right angle AEF = the right angle DEF;* † 4 I.

\therefore AF = DF.† Similarly AF = FB, and E = FC. Hence in the triangles

DAF, BCF we have the sides DA, AF = to the sides CB, BF, each to each, and the base

* 8 I. DF = the base FC; \therefore the angle DAF = the angle FBC.* Again, in the triangles GAF, HBF we have (by what we have already proved) the sides GA, AF = the sides HB, BF, each to each, and the angle GAF = angle HBF; \therefore base GF

† 4 I. = base FH.†

Hence (by what we have now proved), in the triangles GEF, HEF we have the sides GE, EF = the sides HE, EF, each to each, and the base FG = the base FH, \therefore

* 8 I. the angle GEF = the angle HEF,* which are therefore each right

† 8 Def. I. angles.† The same proof applies to any other line drawn through E, in the

* 1 Def. XI. plane ABC. Hence EF is perpendicular to the plane.* Q. E. D.

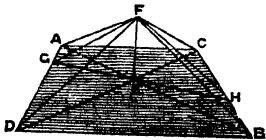

PROPOSITION V.—THEOREM.

If three straight lines (BC, BD, BF) meet all in one point (B), and a straight line (BA) stands at right angles to each of them at that point, these three straight lines are in one and the same plane.

For if not, suppose the plane which passes through BF and BD not to pass through BC, and suppose the plane passing through AB and BC to cut the former plane in BE, then the straight lines BF, BD, BE are in the same plane, viz., the one passing through BD, BF, and AB is at right angles to BD, BE,

* 4 XI. and \therefore is also at right angles to BE.* Now, the angle ABC is a right angle, \therefore angle ABC = angle

† 11 Ax. I. ABF,† and they are both in the same plane,

* 9 Ax. I. which is impossible.* \therefore BC, BD, BF must be in the same plane. Q. E. D.

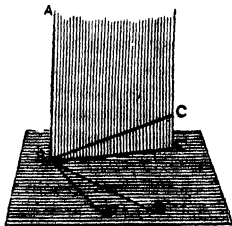

PROPOSITION VI.—THEOREM.

If two straight lines (AB, CD) are at right angles to the same plane (BDE), they shall be parallel to one another.

B, D are the points in which the lines meet the plane. Join BD, and at D draw DE in the plane perpendicular to BD. Make DE = AB. Join AD, BE, AE. Now, since AB is perpendicular to plane, ABD and ABE are right angles, then in triangles ABD, BDE the sides AB, BD = sides DE, DB, each to each, and angle ABD = angle BDE, each being a right

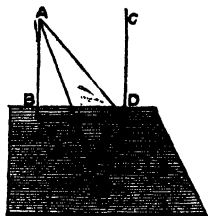

* 4 I. angle, $\therefore BE = AD$. * Then in triangles ADE, ABE, the sides AD, DE = the sides EB, BA, each to each, and the base AE common, \therefore angle ABE = angle

† 8 I. ADE. † But angle ABE is a right angle, \therefore ADE is a right angle. Now, because CD is perpendicular * 3 Def. XI. to the plane, CDE is a right angle; * so that ED is at right angles to the three lines BD, AD, CD, which are therefore † 5 XI. in the same plane; † but the plane which contains AD, DB contains * 2 XI. AB, \therefore AB, BD, DC are in the same plane; now, angles ABD and BDC are right angles, and are \therefore together equal to two right angles, \therefore AB is parallel to † 28 I. CD. † Q. E. D.

PROPOSITION VII.—THEOREM.

If two straight lines (AB, CD) are parallel, the straight line drawn from any point (E) in the one, to any point (F) in the other, is in the same plane with the parallels.

For if not, suppose EGF to be the straight line joining them, and suppose it does not fall in the plane. Since E and F are points in the plane, we can join them by a straight line, which lies wholly in the plane. Let this line be EHF. Then EHF and EGF are two straight lines, inclosing a space, which is impossible. Q. E. D.

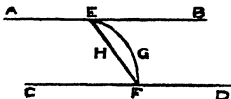

PROPOSITION VIII.—THEOREM.

If two straight lines (AB, CD) are parallel, and one of them (AB) is at right angles to a given plane (BDE), the other shall also be at right angles to the same plane.

Let the lines meet the plane in B and D. Join BD. Then AB, BD, DC are * 7 XI. in one plane. * Draw DE at right angles to BD, † 11 I. and in the plane BDE. † Take AB = DE. Join AD, AE, BE. Now, AB being perpendicular to the plane, is * Def. XI. perpendicular to BD and BE. * Now, BD meets the parallel lines AB, CD, \therefore the angles ABD, BDC are together equal to two right angles. † But ABD is a right angle, \therefore BDC is a right angle.

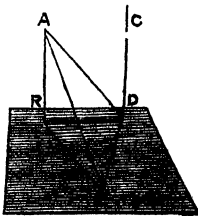

Again, in triangles ABD, BDE the sides AB, BD = the sides ED, DB, and the right angle ABD = the right angle * 4 I. BDE; $\therefore AD = BE$. * Hence in triangles ABE, ADE we have the sides AB, BE = the sides ED, DA, and the base AE is common, \therefore † 8 I. angle ABE = angle ADE. † But ABE is a right angle, \therefore ADE is a right angle; \therefore ED is at right angles to the lines BD and DA, and \therefore is

* 4 XI. the plane passing through them,* and \therefore since CD is in the same plane
 † Def. XI. with AD, BD, angle CDE is a right angle.† But we have already seen that
 BDC is a right angle, \therefore CD is at right angles to the plane passing through BD,
 * 4 XI. DE,* i. e., is at right angles to the plane BDE. Q. E. D.

PROPOSITION IX.—THEOREM.

If two straight lines (AC, CD) are each parallel to the same straight line (EF), but not both in the same plane with it, they are parallel to one another.

For, take any point G in EF, and from G in the plane AB, EF draw GH perpen-
 * 11 L dicular to EF; * and likewise from G in plane
 EF, CD, draw GK perpendicular to EF.

Then because GF is at right angles to GH and GK, it
 † 4 XI. is at right angles to the plane HGM; † and
 since GF is at right angles to the plane HGK, and
 HB is parallel to GF, \therefore HB is at right angles to

* 8 XI. HGK.* Similarly KD is at right angles to HGK, \therefore HB and KD are
 † 6 XI. parallel, † or AB and CD are parallel to each other. Q. E. D.

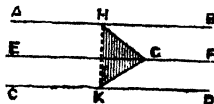

PROPOSITION X.—THEOREM.

If two straight lines (AB, BC) meeting one another be parallel to two others (DE, EF) also meeting one another, the latter two not being in the same plane with the former two, then the former two contain an angle (ABC) equal to the angle (DEF) contained by the latter two.

We suppose that AB is parallel to DE, and BC to EF. Take BA = BD, and
 BC = EF, and join BE, AD, CF, AC, DF.

Then because AB is equal and parallel to DE, and their ex-
 tremities are joined towards the same points BE and AD; \therefore

* 33 I. BE is equal and parallel to AD.* Similarly BE is

† 4 XI. equal and parallel to CF, and \therefore AD is equal †

* 9 XI. parallel* to CF. But the extremities of AD, CF
 are joined towards the same points by AC, and DF, and therefore

† 33 I. AC = DF. † Hence in triangles ABC, DEF we have
 the sides AB, BC = the side DE, EF, each to each, and the
 base AC = the base DF, \therefore the angle ABC = the angle

* 8 I. DEF.* Q. E. D.

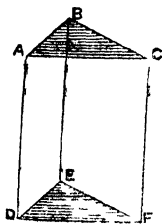

PROPOSITION XI.—PROBLEM.

From a given point (A) above a plane (BCH) to draw a line perpendicular to that plane.

* 12 I. In the plane draw any line BC. From A draw AD perpendicular to BC.*

In the given plane from D draw ED perpendicular to

† 11 I. BC. † From A draw AF perpendicular to

* 12 I. ED,* then AF is the line required.

† 31 I. From through F draw GH, parallel to BC. †

Now, since BC is perpendicular to ED and AD, it is

* 4 XI. perpendicular to the plane passing through

them,* \therefore GH is also perpendicular to the plane passing

† 8 XI. through ED and AD, † and \therefore is perpen-

* Def. XI. dicular to FA; * \therefore the angle AFG is a right angle. But, by construction,

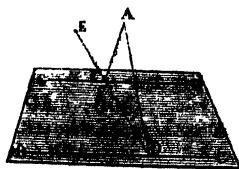

AFD is a right angle, then since AF is perpendicular to the lines FG, FD it is also
 † 4 XI. perpendicular to the plane passing through them, † i. e., is perpendicular to
 the plane BCIL. Which was to be done.

PROPOSITION XII.—PROBLEM.

From a given point (A) in a given plane (EF) to draw a line perpendicular to that plane.

Take any point B above the plane, and from B
 * 11 XI. draw BC perpendicular to the plane.*
 † 33 I. From A draw AD parallel to BC; †
 then because AD and BC are parallel, and BC is
 perpendicular to the plane, ∴ AD is also perpen-
 * 8 XI. dicular to the plane.* Which was to be
 done.

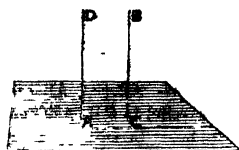

PROPOSITION XIII.—THEOREM.

From the same point (A) of a given plane, there cannot be two straight lines (AB, AC) at
 right angles to the plane, upon the same side of it; and there can be but one perpen-
 dicular drawn to a plane from a given point above it.

For if possible, suppose AB, AC to be at right angles to a given plane. Suppose
 the plane which contains AB and AC to intersect the
 given plane in DE. Then CA, BA, DA are in the
 same plane. Now CA is perpendicular to every line
 * Def. XI. in the plane,* and ∴ to AD, ∴ CAD is
 a right angle. For the same reason BAD is a right
 † Ax. 11 I. angle, ∴ CAD = BAD, † which is
 absurd. Also from the same point above a given plane,
 two perpendiculars cannot be drawn to it, for if they could they would be parallel to one
 * 6 XI. another,* which is absurd. Q. E. D.

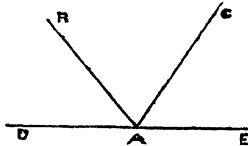

PROPOSITION XIV.—THEOREM.

Planes (DC, EF) to which the same straight line (AB) is
 perpendicular are parallel to each other.

For if not, the planes must intersect; let them intersect in
 the straight line HG, in which take any point K. Join
 KA, KB. Then KA is in the plane DC, ∴ KAB is a right
 * Def. XI. angle.* Similarly ABK is a right angle, ∴
 the two angles KAB, ABK of the triangle ABK, are equal
 † 17 I. to two right angles, which is absurd, † ∴
 the two planes cannot intersect, and therefore are
 * Def. XI. parallel.* Q. E. D.

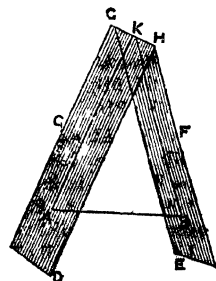

PROPOSITION XV.—THEOREM.

If two straight lines (AB, BC) meeting one another be parallel to two other straight lines (DE, EF) which meet one another but are not in the same plane with the former two, then the plane passing through the former two (AB, BC) is parallel to the plane passing through the latter two (DE, EF).

For, from B draw BG perpendicular to the plane * 11 XI. ABC,* meeting the plane DEF in G. In this plane and through G, draw GH, GK, parallel to DE, + 31 I. EF.† Then, since ED is parallel both to * 9 XI. AB and GH, ∴ AB is parallel to GH.* Similarly GK is parallel to BC. Again, because BG is perpendicular to the plane ABC, it is perpendicular to + Def. XI. AB,† ∴ ABG is a right angle; but because AB is parallel to GH, ABG and BGH are together equal * 29 I. to two right angles,* ∴ BGH is a right angle. Similarly BGK is a right angle, ∴ BG is at right angles to GH and GK, and † 4 XI. therefore is perpendicular to the plane passing through them; † i. e., is perpendicular to the plane DEF. Then, since BG is perpendicular to both the planes * 14 XI. ABC, DEF, these planes are parallel.* Q. E. D.

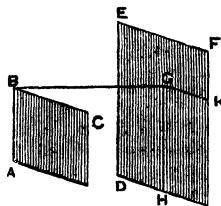

PROPOSITION XVI.—THEOREM.

If two parallel planes (AB, CD) are cut by a third plane (EH), their intersections with it (EF, GH) are parallel.

For if not, they will meet when produced either on the side EH or EG; let them be produced on the side FH, and meet in K. Then, since GH is in the plane

* 1 XI. CD, GH when produced is in that plane,* ∴ GHK is in the plane CD. Similarly EFK is in the plane AB, ∴ the plane AB meets the plane CD, for they have a common point K, and therefore is not parallel to it, which is contrary to the hypothesis, ∴ EF and GH do not meet when produced on the side FH. Similarly they do not meet when produced on the side EG. But lines which are in the same planes, and being produced either way do not meet, are parallel, ∴ EF and GH are parallel. Q. E. D.

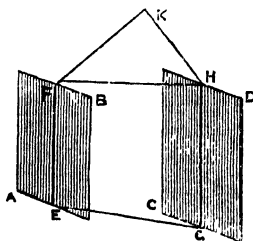

PROPOSITION XVII.—THEOREM.

If two straight lines (AB, CD) are cut by parallel planes (GH, KL, MN, in points AC, EF, BD), they are cut in the same ratio, (i. e. AE : EB :: CF : FD).

For, join AD meeting KL in X and join AC, EX, XF, and BD. Then, because the plane ABD cuts the parallel planes KL, MN in the lines EX and BD, those are paral-

* 16 XI. lels.* Similarly AC is parallel to XF; now because EX is parallel to BD, and AC to XF we have,

$$\dagger 2 \text{ VI. } \quad \text{AE} : \text{EB} :: \text{AX} : \text{XD} \dagger$$

$$\text{and } \text{AX} : \text{XD} :: \text{CF} : \text{FD}$$

$$\therefore \text{AE} : \text{EB} :: \text{CF} : \text{FD. } \quad \text{Q. E. D.}$$

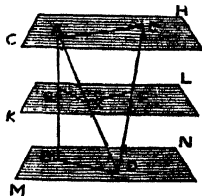

PROPOSITION XVIII.—THEOREM.

If a straight line (AB) is at right angles to a plane (CK), every plane that passes through the line is at right angles to the plane.

Let CH be any plane passing through AB, and let it intersect CK in the line CE. From any point F in CE, and in the plane CH, draw FG at right angles to
 * 11 I. CB.* Then, because AB is perpendicular to the plane, it is perpendicular to CE,† \therefore ABF is a right angle. But GFB is also a right angle, \therefore GFB and FBA are together equal to two right angles;
 * 28 I. \therefore GF is parallel to BA,* and AB is perpendicular to the plane
 + 8 XI. CK, \therefore GF is perpendicular to the plane CK,† similarly any other line in CH drawn perpendicular to CE is perpendicular to the plane CK, \therefore plane CH is perpendicular to plane CK. In like manner it can be proved that any other plane passing through AB is perpendicular to CK. Q. E. D.

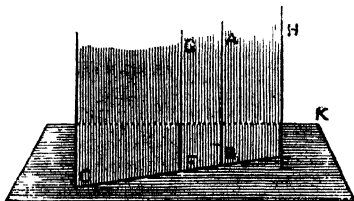

PROPOSITION XIX.—THEOREM.

If two planes (AB, BC) which cut one another (in the line BD) be each perpendicular to a third plane (ADC), the common section (BD) is also perpendicular to the same plane.

Let plane AB intersect plane ADC in AD, and let plane BC intersect plane ADC in DC. Then, if BD is not perpendicular to ADC, from point D in plane AB, draw DE perpendicular to
 * 11 I. AD,* and similarly in BC draw DF perpendicular to DC. Then, because plane AB is perpendicular to ADC, we have ED perpendicular to
 † Def. XI. ADC,† similarly FD is perpendicular to ADC: \therefore from the point AD in the plane ADC, two lines DE, DF are drawn perpendicular to that plane,
 * 13 XI. which is absurd:* \therefore BD is perpendicular to the third plane ADC. Q. E. D.

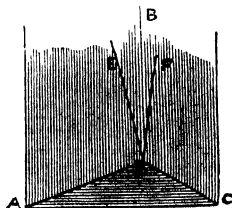

PROPOSITION XX.—THEOREM.

If a solid angle (at A) is contained by three plane angles (BAC, CAD, DAB), any two of them are greater than the third.

If the three plane angles are equal, any one of them is clearly less than the other two.

If the three angles are not equal, let BAC be that which is not less than either of the other two.

At A in BA, and in plane BAC, make the
 * 23 I. angle BAE = angle BAD,* make AE = AD, through E draw BEC, meeting AB and AC in B and C. Join DB, DC. Then in triangles BAD, BAE, the sides BA, AD = the sides BA, AE each to each, and the angle BAD

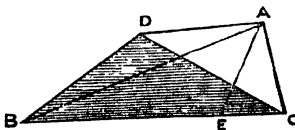

† 4 I. = the angle BAE \therefore the base BD = base BE.† Now, the sides BD,

- * 20 I. DC are together greater than BC; * *i. e.*, greater than BE, CE; + 5 Ax. I. taking away the equals BD, BE, we have left DC greater than EC. † Then in the triangles EAC, DAC, we have the sides DA, AC = the sides EA, AC, each to each. But the base DC is greater than the base EC, ∴ the angle DAC is greater * 25 I. than the angle EAC. * To each of these add the equals DAB, BAE. † 4 Ax. I. Then the two BAD, DAC are together greater than BAC. * Q. E. D.

PROPOSITION XXI.—THEOREM.

Every solid angle (A) is contained by plane angles, which, together, are less than four right angles.

First, let the angle (A) be contained by three plane angles BAC, CAD, DAB. Join BC, CD, DB. Now, since the angles of any triangle are together equal to two right

* 32 I. angles, * we have the angles of any three triangles together equal to six right angles, ∴ BAC + CAD + DAB + ABC + BCA + ACD + CDA + ADB + DBA = six right angles.

Now, because D is a solid angle, CDA + ADB + 20 XI. are greater than CDB. * Similarly DBA + ABC are greater than DBC, and BCA + ACD are greater than BCD.

∴ BAC + CAD + DAB + CDB + DBC + BCD are less than six right angles. Now, BCD is a triangle, and ∴ CDB + DBC + BCD = 2 right angles, ∴ BAC + CAD + DAB are together less than four right angles. But these contain the solid angle at A, ∴ when three angles contain a solid angle, they are together less than four right angles. Q. E. D.

Next, suppose the angle A to be contained by any number of plane angles. Then all these plane angles are together less than four right angles, for supposing the lines containing the angle to be cut by a plane, so that we obtain a polygon BCDEF instead of the triangle in the first case. As before, we can easily prove that the angles containing the solid angle, together with the angles of the polygon, are less than twice as many right angles as there are sides of the polygon; but twice as many right angles as there are sides of the polygon are equal to the

* Cor. 33 I. angles † of the polygon, together with four right angles; ∴ the plane angles forming solid angles at A, together with angles of polygon, are less than angles of polygon, together with four right angles, ∴ angles forming solid angles are together less than four right angles. Q. E. D.

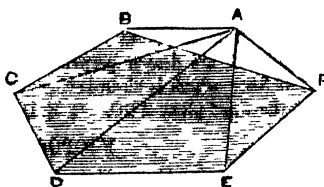
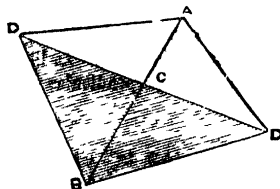

SPHERICAL GEOMETRY.

Introduction.—The following treatise, on Spherical Geometry, is intended to be strictly introductory to the cognate sciences of Spherical Trigonometry. To explain their relation, the following, for our present purposes, will suffice. The Science of Geometry, as given in the first six books of Euclid's Geometry, contains, along with others, a variety of propositions concerning the relations between the sides and angles of plane triangles. And these propositions may be *directly* applied to solve a variety of problems by *construction*—*e. g.*, if we are asked to construct an equilateral and equiangular pentagon on a given straight line, we can do this, with rule and compasses, by skillfully availing ourselves of certain properties of lines and angles which Euclid has proved. But if the question were asked,—given that one side of a triangle is so many feet long, and that the angles adjacent to that side are respectively certain parts of a right angle, how many feet long are the remaining sides? The question is one, not of *construction*, but of *calculation*, and we cannot solve it directly, but only by the intervention of a science which shall give algebraical expressions for the relations between the sides and angles of triangles. Such a science has been invented, and is called *plane trigonometry*. It clearly *presupposes* a knowledge of the relations which Euclid has established, and assumes them as its basis. Now, suppose the triangles to be described, not on a plane, but on the surface of a sphere, spherical trigonometry is the science which gives us the means of *calculating* from given data the sides and angles of such triangles. This science, therefore, stands to the *spherical* triangle in the same relation that plane trigonometry stands to the *plane* triangle. And as the latter science rests on that part of the science of Geometry which treats of plane triangles as its basis, so the former science must rest on another portion of the science of Geometry, which shall treat of triangles described on the surface of a sphere as its basis.

The need of such a science as Spherical Trigonometry will be apparent to any one who reflects on the circumstance that the surface of the globe is (very nearly) spherical; consequently, all the triangles calculated in the course of a survey on a large scale arc, when reduced to the surface of the earth, spherical triangles. Hence, surveying on a large scale (Geodesy) cannot be carried on without the investigations of spherical trigonometry. Again, in practical astronomy the positions of all the heavenly bodies are referred to the surface of the great sphere—that, namely, which has the centre of the earth, supposed to be fixed, for its centre; and thus the triangles recognised in practical astronomy are spherical triangles, and the requisite calculations cannot be carried on except by means of the science of spherical trigonometry.

Having thus explained that this so needful science demands as its basis the investigation of certain properties of the spherical triangle, we will proceed to investigate those properties. As already stated, we shall confine ourselves strictly to such propositions as we shall hereafter need in treating of spherical trigonometry.

We have already in general terms said that a spherical triangle is one described on the surface of a sphere; we must, however, define this and other points more accurately, which we shall do as we proceed.

It is to be observed that we suppose that we can draw any plane through any three given points; or, which is the same thing, through any straight line, and through a point not on that same straight line; also that we can cut any given solid, by a plane, in any direction whatever.

N.B. From Euclid VI., 33, it appears that in a given circle any angle at the centre is proportional to the arc on which it stands. The arc is therefore said to measure the angle.

DEFINITIONS.

I.

A *solid* is a space which has three dimensions—namely, length, breadth, and thickness.

II.

A *sphere* is a solid bounded by a surface, of which every point is equally distant from a point within it called the *centre*.

III.

The *radius* of a sphere is a straight line drawn from the centre to any point in the sphere.

IV.

A straight line drawn through the centre, and terminated both ways by the surface of the sphere, is called the *diameter*.

PROPOSITION I.

Every section of a sphere made by a plane is a circle.

Let ABCD be the sphere; draw OA any radius whatever; let BPEN be a plane cutting the sphere's surface in the line BPE. It is supposed that the plane of the paper passes through the centre of the sphere perpendicularly to this cutting plane, which also cuts the radius OA in the point N; and suppose OA to be perpendicular to the plane; take P, any point in the line BPE, join PN, PO, OE. Then because PN is in the plane BPE, and ON is perpendicular to the plane, \therefore PNO is a right angle. For the same reason ONE is a right angle, \therefore in the triangles PNO, ONE, we have $PN^2 + NO^2 = PO^2$ and $EN^2 + NO^2 = OE^2$. Now, $OP = OE$, because each are radii of the sphere, $\therefore PN^2 + NO^2 = EN^2 + NO^2 \therefore PN = EN$. Similarly of any other point in the line BPE, \therefore BPE is a circle, the centre of which is N.

If the plane passes through the centre of the sphere, as plane CQD, take Q any point in the line in which the plane cuts the surface of the sphere. Join OQ, OD. Then OQ, OD are radii of the sphere, $\therefore OQ = OD$. Similarly of any other point in the line CQD \therefore the section CQD is a circle. Hence every section of a sphere is a circle. Q. E. D.

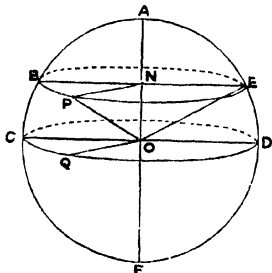

Fig. 1.

N.B. The figure, as thus drawn, will, it is hoped, be quite comprehensible; it may be observed, however, that the circle ACD is the section of the sphere made by the plane of the paper. The other sections of the sphere are made by planes which intersect the plane of the paper in straight lines—*e. g.*, in BE, and in CD, and these sections are seen in perspective, as CQD, BPE.

DEF. V.—The section of a sphere made by a plane which does not pass through the centre is called a *small circle*. Thus, in Fig. 1, BPE is a small circle.

DEF. VI.—The section of a sphere made by a plane which passes through the centre is called a *great circle*. Thus, in Fig. 1, CQD is a great circle.

PROPOSITION II.

A great circle may be drawn through any two points on the surface of a sphere, but in general not through more than two points.

For, taking any two points on the surface of the sphere, we can draw a plane through them, and this plane can be made to pass through any third point, *viz.*, through the centre of a sphere. The section of the sphere made by this plane is a great circle, and the two points clearly lie on it.

These three points determine the plane, and \therefore we cannot be sure of its passing through any other point, whether on the surface of the sphere or not. Q. E. D.

Cor.—It is plain that a small circle may be made to pass through any three points. For a plane being drawn through two points can be made to pass through a third; and if these three points are on the surface of a sphere, the plane cuts the sphere in a circle on which these three points lie.

N.B. We shall henceforth assume that we can draw arcs of great circles in any possible direction; for instance, through any two points. For this is merely equivalent to drawing a plane through the centre of the sphere, and those two points, which of course cuts the sphere in the required great circle.

PROPOSITION III.

Two great circles bisect one another.

For suppose ABCD, the section made by the plane of the paper, to be one circle, and BPC a section made by any other plane BPCQ to be the other, then these planes intersect in the straight line BC which passing through O, the centre of the sphere OC is a diameter of each of the circles, and \therefore bisects each of the circles, \therefore BPC = CQB, and BAC = CDB, or the two great circles bisect each other. Q. E. D.

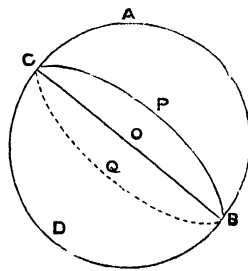

Fig. 2.

PROPOSITION IV.

The inclination of two great circles is the angle between the tangents drawn to those circles at their point of intersection.

Let one great circle be that made by the plane of the paper AQB. Let APB, the

other circle, be that made by any other plane, then the diameter AOB is the line in which the planes intersect; in plane of paper draw AS perpendicular to AB ; in the plane APB draw AR perpendicular to AB . Then (*Treat on Planes*, Def. 4.) RAS is the angle between the planes. But AR touches the circle APB at point A , and AS touches the circle AQB at point A (Euclid III., 16), \therefore the inclination of two great circles is the angle between their tangents at the point of intersection. Q. E. D.

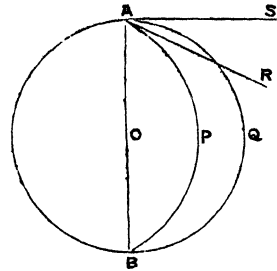

Fig. 3.

N.B. The angle RAS , between the tangents RA , SA , is generally supposed to be measured on the sphere, and is called the angle PAQ .

DEF. VII.—If from the centre of a sphere a line be drawn perpendicular to the plane of any circle, whether great or small, and be produced both ways to meet the surface of the sphere, the points in which that line meets the surface of the sphere, are called the *poles* of the circle.

Thus, in Fig. 1, let CQD be the plane of a great circle, O being the centre of the sphere. Through O draw OA perpendicular to the plane CQD , and produce it to meet the surface of the sphere in F and A . Then F and A are the *poles* of the great circle CQD .

Again, if BPE be the plane of a small circle BPE , from O draw ON perpendicular to that plane, produce ON both ways to meet the surface of the sphere in A and F . These are the poles of the small circle BPE . It is usual to call A (the pole nearest to the small circle), *the pole of the circle*.

From the demonstration of Proposition I., it is plain that N is the centre of the circle BPE .

PROPOSITION V.

If from the pole of a circle great circles be drawn to any two points of that circle, the intercepted arcs are equal.

(1). In the case of a small circle, let APB be the plane of the small circle XOY perpendicular to that plane, and meeting it in N , then XY are the poles of the circle, and N is its centre. Let XAY , the section made by the plane of the paper be one great circle, XPY , the section made by the plane passing through any other point P be the other great circle. We have to prove that the arc $XP =$ arc XA . For, since N is the centre of the circle APB , we have $AN = PN$; also, since O is the centre of the sphere $OA = OP$, \therefore in the triangle AON , PON , we have the sides $AO, ON, =$ the sides PO, ON , each to each, and the base $AN =$ the base PN , \therefore the angle $AON =$ angle PON . But in equal circles, equal angles stand on equal circumference, \therefore the arc $AX =$ arc PX .

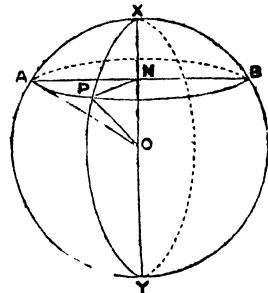

Fig. 4.

(2.) In the case of a great circle, let APB be the great circle, O its centre and the spheres XOY perpendicular to the plane APB . Then, XY are the poles of the circle. Let the section made by the plane of the paper XAY be one of the great circles and let XPY be the other; we have to show that arc $AX =$ arc PX —join OA, OP . Then, because XO is perpendicular to the plane XOA and XOP are right angles, and \therefore are equal to each other. Hence as before, arc $AX =$ arc PX . Q. E. D.

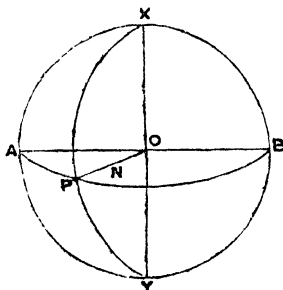

Fig. 5.

COR. 1.—Hence the pole of a circle is equally distant from every point of that circle. The distance being measured along a great circle.

COR. 2.—In the case of the pole of the great circle, it is plain, since AOX is a right angle, that AX is the fourth part (or of the great circle $AXBY$).

COR. 3.—Also any plane passing through the poles of a great circle is clearly perpendicular to the plane of that circle: since the line joining the poles XOY (Fig. 5) is perpendicular to the plane APB . (Tract on Planes, DEF. 2.)

COR. 3 (Fig. 5).—The inclination of the two great circles XAY, XPY is clearly measured by the arc AP . For PO , and AO are each perpendicular to XY , the line of intersection of the great circle, $\therefore POA$ is the inclination of the great circles, and POA is measured by the arc AP .

4.—We have already seen that the angle AXP , *i. e.*, the angle between the tangents to the circles at the point X , is the inclination between the planes, $\therefore AP$ measures the angle AXP .

DEF. VIII.—A spherical triangle is the portion of a surface of a sphere contained by the arcs of three great circles.

Thus, let AXB, CZD, EYF be three great circles which intersect in the points ZYX , then the space ZXY inclosed by the arcs ZY, YX, XZ is called a spherical triangle.

It will be observed, that the great circle in a spherical triangle is analogous to the straight line in the case of a plane triangle; but there is this difference to be observed, that two straight lines, when produced, never meet, whereas two great circles, when produced, always meet, *viz.*, in a point distanced from the other by a whole semicircle. To consider the result of this circumstance, we will suppose the section made by the plane of the paper ($ABa\delta$) to be one great circle, and the two others to be $ACae$ and $BCbc$, O the centre of the sphere, $AOa, BO\delta, COc$, are diameters. It will be seen that ABC is a spherical triangle, as in the case of figure 6. But the three circles, in addition

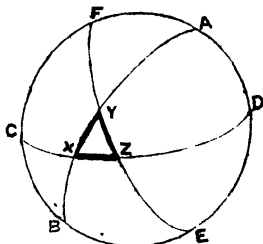

Fig. 6.

to ABC , make seven other spherical triangles, *viz.*, abC , BCa , bCA , on the one hemisphere, $ABCa$, and ABc , abc , bcA , Bca , on the hemisphere $Acba$.

Also, it is plain that the triangles on the one hemisphere are equal to those on the other, each to each; thus, the triangle ABC is equal to the triangle abc . For ACa , and Cac are each halves of the same circle, and \therefore are equal to each other; take away the common part Ca , and we have left $AC = ac$. Similarly $AB = ab$, and $BC = bc$. Again, the angle of the triangle acb , which is the angle between the planes, is equal to the angle ACB , which is also the angle between the planes; similarly the other angles are equal, and they are described on the surface of the same sphere; if, therefore, the triangles were superimposed, they would coincide, and are \therefore equal.

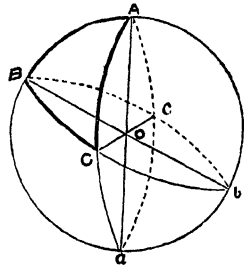

Fig. 7.

N.B. The student will do well to consider very carefully the above observations: he must also take notice of the assumption, that triangles taken off the surface of the same sphere will coincide, provided their sides and angles are equal. This is merely assuming that the curvature of the same sphere is the same at all parts; which is obviously true, as the following consideration will assure us:—Suppose we have two spheres of equal radii—suppose these centres to coincide—then, since every point in each sphere is equally distant from their common centre, their surfaces coincide, and will continue to coincide however we may move either of them, provided their centres continue to coincide.

It is plain that the side AB measures the angle AOB . Hence the side of a spherical triangle is spoken of as an angle, *viz.*, the plane angle it subtends at the centre of the sphere.

PROPOSITION VI.

Any two sides of a spherical triangle are together greater than the third, and the three sides of the triangle are together less than four right angles.

For (*Tract on Planes*, p. 20), if a solid angle is contained by three plane angles, any two are greater than a third; but (Fig. 7) the solid angle at O is contained by AOB , BOC , COA , \therefore any two of these are greater than a third; and hence any two of the three sides of ABC (which sides measure these angles respectively) must be greater than the third.

Again (*Tract on Planes*, Prop. 21), the three angles, AOB , BOC , COA , are together less than four right angles; and \therefore the three sides, AB , BC , CA , which measure these angles must be less than four right angles. Q. E. D.

DEF. IX.—A *lune* is the portion of the surface of a sphere inclosed by the arcs of two great circles.

Thus (Fig. 7), ABa is a lune.

DEF. X.—The angle of a *lune* is the angle between the two great circles which bound it.

Thus (Fig. 7), BAa is the angle of the lune.

PROPOSITION VII.

On equal spheres, if the angles of two lunes are equal, the lunes themselves are equal.

Let ACBD, AEBF, be two lunes described on equal and coincident spheres, having the angle CAD = angle EAF, these lines shall be equal; for suppose the one sphere to revolve till the circle AEB coincides with ACB, then because angle CAD = angle EAF, we must have AFB coinciding with ADB. The lunes, therefore, coincide and are equal.

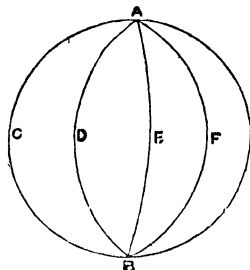

Fig. 8

N.B. In the above demonstration we have assumed that the lunes have the same extremities, AB: we are obviously entitled to do this, since by shifting the spheres these extremities can be brought to coincide. Also, the proposition is plainly true when the lunes are on the same sphere. Also, it is manifest that the greater lune has the greater angle, and vice versa.

PROPOSITION VIII.

In the same or equal spheres, lunes are to each other in the ratio of their angles.

For let l and m be two lunes, the angles of which are a and b ; let A be any multiple of a , and L the lune corresponding to A ; then it is plain that L is the same multiple of l that A is of a . Similarly let B be any multiple of b , and let M be the corresponding lune; then it is plain that M is the same multiple of m that B is of b . We have then four magnitudes, l, m, a, b ; and of the first and third we have taken any equimultiples, L and A ; and of the second and fourth we have taken any equimultiples, M and B . Now, by last proposition, if $L > M$, A is $>$ B ; if equal, equal; if less, less \therefore (Def. V., p. 136), $l : m :: a : b$. Q. E. D.

Cor.—It is plain that the area of half a hemisphere is a lune whose angle is a right angle, \therefore if X be the area of a sphere, and if A be any lune whose angle is B ,

$$A : \frac{X}{4} :: B : \text{one right angle,}$$

$$\therefore A : X :: B : \text{four right angles.}$$

Or area of lune : area of sphere :: angle of lune : four right angles.

DEF. XI.—The spherical excess of a spherical triangle is the excess of the sum of its three angles over two right angles.

It will be seen by the next proposition that the sum of the three angles of a spherical triangle are really greater than two right angles—the excess of the angles above

two right angles is clearly due to the *sphericity* of the triangle; hence the term "spherical excess."

PROPOSITION IX.

To prove that the angles of a spherical triangle are together greater than two right angles, and that the area of a spherical triangle has to the area of half the sphere on which it is described the same ratio that the spherical excess has to two right angles.

For (Fig. 7) let ABC be the triangle, then the lunes corresponding to each of the angles are BaA corresponding to A , BbA corresponding to B , Cac corresponding to C . For the sake of brevity, call these lunes respectively L_1, L_2, L_3 .

Then by Corol. to Prop. VIII,

$$L_1 : \text{area of sphere} :: A : 4 \text{ right angles.}$$

$$\text{or, } L_1 : \text{area hemisphere} :: A : 2 \text{ right angles.}$$

Similarly—

$$L_2 : \text{area hemisphere} :: B : 2 \text{ right angles.}$$

$$L_3 : \text{area hemisphere} :: C : 2 \text{ right angles.}$$

$\therefore L_1 + L_2 + L_3 : \text{area hemisphere} :: A + B + C : \text{two right angles.}$ Now, the three lunes clearly make up the hemisphere $BACa\delta$, together with the triangle abc . Hence the three lunes are in all cases greater than a hemisphere, and \therefore the three angles of the triangle are together greater than two right angles.

Again, triangle abc is equal to triangle ABC (Remarks on Def. VIII.), $\therefore L_1 + L_2 + L_3 = \text{area of hemisphere} + \text{area of triangle } ABC$. Also, $A + B + C = \text{two right angles} + \text{spherical excess}$; $\therefore \text{area hemisphere} + \text{triangle } ABC : \text{area hemisphere} :: \text{two right angles} + \text{spherical excess} : \text{two right angles}$, $\therefore \text{area triangle } ABC : \text{area hemisphere} :: \text{spherical excess} : \text{two right angles}$.
Q. E. D.

DEF. XII.—The triangle formed by the great circles which join the poles of the sides of a given triangle, is called the polar or supplemental triangle.

Thus, let ABC be a given triangle; then if a, b, c , be respectively the poles of the sides BC, CA and AB , abc is the polar triangle. And clearly, if aA is joined by the arc of a great circle, and this is produced to meet BC in D , then aD is a quadrant of a circle, and AD is perpendicular to BC , and similarly of the other poles.

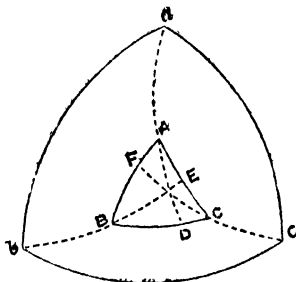

Fig. 9.

The relation between the given triangle and its polar triangle is very important, as will be seen when we come to employ its properties in Spherical Trigonometry; the properties on which its importance depends are proved in the following propositions.

PROPOSITION X.

If two great circles intersect, their points of intersection will be the poles of the great circle which passes through their poles.

For (in Fig. 5), take the plane of the paper for the plane of one circle, and YPX for any other, so that X and Y are the points of intersection of the two circles; through O draw a plane APB perpendicular to XY, and \therefore perpendicular to both the planes XAB, and XPY, and \therefore the plane APB will contain the lines drawn perpendicular to those planes, and therefore will contain the poles of the two given circles. Hence APB is the great circle joining the poles of the circles XAY and XPY; but YOX is perpendicular to the plane APB, \therefore X and Y are the poles of the circle APB; *i. e.*, are the poles of the great circle which joins the poles of the two given circles.

PROPOSITION XI.

If ABC is a given triangle, and A'B'C', is its polar triangle, then is ABC the polar triangle of A'B'C'.

For since C' is the pole of AB, and B' is the pole of AC, \therefore (by last Prop.) the point of intersection A of AB and AC is the pole of the great circle joining B'C', *i. e.*, A is the pole of B'C', similarly B is the pole of C'A', and C the pole of A'B'. Q. E. D.

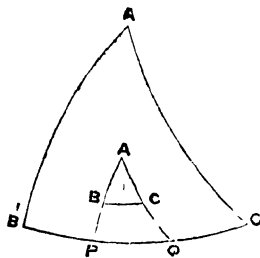

Fig. 10.

PROPOSITION XII.

If ABC is a triangle, and A'B'C' its polar triangle, then the arc on the sphere, which measures the angle A, together with the side B'C', equals the semi-circumference of a great circle.

For, produce AB, AC to meet B'C' in P and Q. Then because AP and AQ are quadrants, PQ is the arc that measures the angle A (Cor. 4, Prop. V.); now B'C' + PQ = B'P + C'Q + QP = B'Q + C'P. But since B' is the pole of AC, \therefore B'Q is a quadrant. Similarly C'P is a quadrant, and the two together are a semicircle, \therefore B'C', together with the arc on the great circle which measures A, equals the semi-circumference of a great circle.

Cor. 1.—If for these arcs we substitute the angles they measure, we may state the proposition as follows:—

$$A + B'C' = 2 \text{ right angles.}$$

Similarly—

$$B + C'A' = 2 \text{ right angles,}$$

$$C + A'B' = 2 \text{ right angles.}$$

Cor. 2.—And since ABC is the polar triangle of A'B'C', we have—

$$A + BC = 2 \text{ right angles.}$$

$$B' + CA = 2 \text{ right angles.}$$

$$C' + AB = 2 \text{ right angles.}$$

Cor. 3.—Hence, the sum of the angles of any triangle, together with the sides of

the polar triangle, = six right angles. But the sides of the polar triangle must have some magnitude, and must be less than four right angles (Prop. VII.) Hence the three angles of a triangle must be less than six, and greater than two right angles.

It is plain, since the three angles of a spherical triangle are greater than two right angles, and less than six right angles, that a spherical triangle may have one, two, or even three of its angles right angles.

DEF. XIII.—A right-angled spherical triangle is one which has *one or more* right angles.

DEF. XIV.—A quadrantal triangle is one which has at the least one side a right angle, *i. e.*, the quadrant of a great circle,

PROPOSITION XIII.

If ABC is a right-angled triangle, having a right angle C, and A'B'C' is its polar triangle, then A'B'C' is a quadrantal triangle, having the side A'B' a quadrant.

For by the last proposition (Cor. 1)—

$$C + A'B' = \text{two right angles.}$$

Now, C is a right angle, \therefore A'B' is a right angle, *i. e.*, is a quadrant. Q. E. D.

COR.—Hence, if all three angles, A'B'C, are right angles, the sides of the polar triangle are all right angles. For if two sides of a triangle are right angles, the third side measures the opposite angle; \therefore if the third side is also a right angle, all the angles are right angles. Hence in the polar triangle the sides and angles are *all* right angles. And since the angles of the polar triangle are each right angles, the sides of ABC will be right angles (last Prop., Cor. 2). Hence, if all the angles of any triangle are right angles, the sides are right angles (*i. e.*, quadrants) also.

SERIES AND LOGARITHMS.

ON SERIES.

1. *The Principle of the Permanence of Equivalent Forms.*

It was stated in page 161, that "the processes of Algebra are, for the most part, only processes of Arithmetic, extended and rendered more comprehensive by the aid of a new set of symbols, taken in combination with the well-known symbols of Arithmetic;" and in the explanations following, it is made to appear that Algebra is a generalization of Arithmetic—that whereas 2, 5 . . . represent certain special numbers, $a, b . . .$ represent *any* numbers. This is professedly an elementary view of the case; and, as an elementary view, is quite sufficient. But when the nature of the generalization is more closely considered, it appears that, in what is commonly called Algebra, there are really two distinct, though closely connected sciences, which may be called respectively Arithmetical Algebra, and Symbolical Algebra. In Arithmetical Algebra, "the symbols represent numbers, whether abstract or concrete, whole or fractional, and the operations to which they are subject are assumed to be identical, in meaning and extent, with the operations of the same name in common arithmetic. The only distinction between the two sciences consists in the substitution of general symbols for digital numbers."

Thus, in arithmetic, it is impossible to subtract 7 from 5: so that $5 - 7$ is impossible; and hence in arithmetical Algebra, when we write $a - b$, we do so with the tacit assumption that $a > b$. If we generalize a step farther than this, and allow ourselves to write $a - b$ for all values of a and b , then it is clear that the negative sign has a more extended meaning than that of mere subtraction; and it remains for us to ascertain what this more extended meaning is. The science which concerns itself with this second generalization is called *Symbolical Algebra*. Thus, then, we have, in all three sciences,—

(1). Arithmetic, in which the symbols employed are *particular in form*, and *particular in value*.

(2). Arithmetical Algebra, in which the symbols employed are *general in form*, but *particular in value*.

(3). Symbolical Algebra, in which the symbols employed are *general in form*, and also *general in value*.

Thus, as the second of these sciences is a generalization of the first, so the third is a generalization of the second. The principle in accordance with which this second generalization is conducted is called that of "The permanence of equivalent forms." The principle may be stated as follows:—

"Whatever algebraical forms are equivalent, when the symbols are general in form, but specific in value, will be equivalent likewise when the symbols are general in value, as well as in form."

For the full exposition of relations between these two sciences, the advanced reader is referred to a "Treatise on Algebra," by George Peacock, D.D., to whom is due the detection of the coexistence of these two sciences in that which is generally treated as one science—Algebra. We shall have several occasions to make use of the principles above enunciated in the course of the following pages. As an example of their application, we will reconsider the Theory of Indices already treated in pp. 191, 192, 193.

2. On the Theory of Indices.

We have already seen that a^m signifies $a \times a \times a \times a$, &c., to m factors, when, of course, m must be a whole number.

In like manner a^n signifies $a \times a \times a$, &c., to n factors. Hence—

$$a^m \times a^n = a \times a \times a \dots \text{to } (m + n) \text{ factors,}$$

$$\text{and therefore } a^m \times a^n = a^{m+n}.$$

This is a result in *Arithmetical Algebra*. It is perfectly *general in form*, but it is *particular in value*; for m and n are, by the definition of a^m , limited to being positive whole numbers. If we suppose m and n to have negative or fractional values, this involves a generalization of our original definition, and the question arises what

meaning we must assign to such expressions as a^{-n} . To answer it, we proceed in the following manner:—By assuming m and n general in value as well as in form, we enter the domains of Symbolical Algebra; hence, by the principle of the permanence of equivalent forms, under all circumstances—

$$a^m \times a^n = a^{m+n},$$

$$\therefore a^m \times a^n \times a^r = a^{m+n+r} \times a^r = a^{m+n+r};$$

and so on for any number of terms. Hence—

$$a^{\frac{p}{q}} \times a^{\frac{p}{q}} \times a^{\frac{p}{q}} \times \dots \text{to } q \text{ terms} = a^{\frac{p}{q} + \frac{p}{q} + \frac{p}{q} + \dots} \text{As } q \text{ fraction}$$

$$\therefore \left(a^{\frac{p}{q}}\right)^q = a^p.$$

$$\therefore a^{\frac{p}{q}} = \sqrt[q]{a^p}.$$

i. e., $a^{\frac{p}{q}}$ must (in accordance with our general principle) signify the q^{th} root of the p^{th} power of a .

$$\text{Again, } a^m \times a^n \times a^{-n} = a^{m+n-n} = a^m,$$

$$\therefore a^n \times a^{-n} = 1.$$

$$\therefore a^{-n} = \frac{1}{a^n}.$$

Hence, we see that in assigning the meaning \sqrt{a} to $a^{\frac{1}{2}}$, we are doing so not arbitrarily, but in accordance with a principle which lies at the foundation of Algebra.

3. On Impossible Expressions.

Again, we know that $\sqrt{a^2} = a$. In like manner if we were to have $-a^2$, this is $= a^2 \times (-1)$, and $\therefore \sqrt{-a^2} = a\sqrt{-1}$. The expression $\sqrt{-1}$ is frequently spoken of as an "impossible quantity," an "imaginary expression," and so on, since -1 cannot be produced by multiplying either $+1$ by $+1$, or -1 by -1 . In reality, however, $\sqrt{-1}$ is as possible or as impossible as -1 ; for in arithmetical Algebra a and \sqrt{a} are only admissible on the supposition that a is positive. In symbolical Algebra this restriction is removed, and therefore in that both $-a$ and $\sqrt{-a}$ are admissible. Hence in future investigations we shall make use of $\sqrt{-1}$ just as freely as \sqrt{a} , whenever it may suit our purpose, quite undeterred by the circumstance of its so-called impossibility. Of course there are many differences between the symbols -1 and $\sqrt{-1}$; for instance, the interpretation of the former is a much simpler matter than the interpretation of the latter, and in some cases $a - b$ belongs to arithmetical Algebra; but $a + b\sqrt{-1}$ never does. We cannot enter further into the matter now;

what we have said will be enough to explain that we are justified in introducing into our calculations expressions which are called "imaginary," or "impossible."

4. To prove that if $A_0 + A_1x + A_2x^2 + \dots + A_nx^n = a_0 + a_1x + a_2x^2 + \dots + a_nx^n$, for all values of x . Then $A_0 = a_0$, $A_1 = a_1$, $A_2 = a_2$, ... $A_n = a_n$.

For since $A_0 + A_1x + \dots + A_nx^n = a_0 + a_1x + \dots + a_nx^n$ are equivalent for ALL values of x ; they are equivalent when $x=0$. $\therefore A_0 = a_0$, and $\therefore A_1x + A_2x^2 + \dots + A_nx^n = a_1x + a_2x^2 + \dots + a_nx^n$; $\therefore A_1 + A_2x + \dots + A_nx^{n-1} = a_1 + a_2x + \dots + a_nx^{n-1}$ for all values of x ; and hence when $x=0$, $\therefore A_1 = a_1$, and and so on. Hence $A_2 = a_2$, ... and $A_n = a_n$.

This is called the principle of Indeterminate Coefficients.

It will be seen that in the case supposed, where the number of terms in each series is finite, the proof is quite rigid. If each series were infinite the proof would not then be conclusive; and, accordingly, we shall refrain from using this principle except in cases where no objection can be raised to its use. Such as the following:—

(1). To resolve $\frac{1-2x+3x^2}{(x-1)(x-2)(x-3)}$ into partial fractions.

Assume $\frac{1-2x+3x^2}{(x-1)(x-2)(x-3)} = \frac{A_1}{x-1} + \frac{A_2}{x-2} + \frac{A_3}{x-3}$.

$\therefore 3x^2 - 2x + 1 = A_1(x-2)(x-3) + A_2(x-3)(x-1) + A_3(x-1)(x-2) = x^2(A_1 + A_2 + A_3) - x(5A_1 + 4A_2 + 3A_3) + 6A_1 + 3A_2 + 2A_3$.

This being true for all values of x , we have

$$A_1 + A_2 + A_3 = 3.$$

$$5A_1 + 4A_2 + 3A_3 = 2$$

$$6A_1 + 3A_2 + 2A_3 = 1.$$

$$\therefore 2A_1 + A_2 = -7.$$

$$\frac{4A_1 + A_2 = -5}{2A_1 = 2.}$$

$$\therefore A_1 = 1.$$

$$\therefore A_2 = -9.$$

$$A_3 = 11.$$

$$\therefore \frac{3x^2 - 2x + 1}{(x-1)(x-2)(x-3)} = \frac{1}{x-1} - \frac{9}{x-2} + \frac{11}{x-3}.$$

N.B. A fraction written in the above form is said to be resolved into its partial fractions.

(2). Resolve $\frac{x-1}{(x+1)(x^2+3)}$ into its partial fractions.

Assume $\frac{x-1}{(x+1)(x^2+3)} = \frac{A}{x+1} + \frac{Mx+N}{x^2+3}$.

$$\therefore x-1 = x^2(A+M) + x(M+N) + 3A+N$$

$$\therefore A+M=0$$

$$M+N=1$$

$$3A+N=x-1$$

$$\therefore A-N=-1$$

$$\therefore 4A=-2$$

$$A = -\frac{1}{2}.$$

$$N = \frac{1}{2}$$

$$M = \frac{1}{2}$$

$$\therefore \frac{x-1}{(x+1)(x^2+3)} = -\frac{1}{2(x+1)} + \frac{x+1}{2(x^2+3)}.$$

The student can prove the following :—

$$(1). \frac{3x^2 + 4x - 1}{(x+1)(x-1)(x-2)} = \frac{1}{x+1} + \frac{1}{x-1} + \frac{1}{x-2}$$

$$(2). \frac{2x+3}{(x+2)(x-3)(x-5)} = -\frac{1}{35(x+2)} - \frac{11}{10(x-3)} + \frac{79}{70(x-5)}$$

$$(3). \frac{x}{(x-a)(x-b)} = \frac{a}{a-b} \cdot \frac{1}{x-a} - \frac{b}{a-b} \cdot \frac{1}{x-b}$$

$$(4). \frac{1}{(x-a)(x-b)(x-c)} = \frac{1}{(c-a)(b-a)} \cdot \frac{1}{x-a} + \frac{1}{(a-b)(c-b)} \cdot \frac{1}{x-b} + \frac{1}{(a-c)(b-c)} \cdot \frac{1}{x-c}$$

(5.) A series is a number of algebraical expressions, each of which is connected with those which precede it in some determinate manner.

For example :—In the treatise on Elementary Algebra, we have had examples of series in the arithmetical and geometrical progressions. In the former case, each term is derived from the one preceding it by adding a certain known number called the common difference. In the latter case, each term is derived from the one preceding it by multiplying that term by a certain known number called the common ratio. Hence,

$$a + (a+b) + (a+2b) + (a+3b) + \dots$$

$$a + ar + ar^2 + ar^3 + \dots$$

$$\text{and } 1 + r + r^2 + r^3 + \dots$$

are series.

Def. :—A series is called a finite series when it has an assignable last term. It is called an infinite series when, if we fix on any term whatever, there are terms beyond it.

Thus, $1 + r + r^2 + \dots + r^n$ is a finite series. But $1 + r + r^2 + \dots$ ad inf. is an infinite series, because if we take any term whatever—for instance, the 50th, or 500th, or 5000th—there are always terms beyond it.

6. To explain what is meant by a Convergent and a Divergent Series.

Def.—If the sum of the terms of a series has an arithmetical limit when the number of terms is infinite, that series is *convergent*; if otherwise, it is *divergent*.

If we divide 1 by $1-r$, we shall produce $1 + r + r^2 + \dots$ which series we can continue to produce to any number of terms whatever. Hence the fraction $\frac{1}{1-r}$, and the series $1 + r + r^2 + \dots$ ad inf. are equivalent to each other; or

$$\frac{1}{1-r} = 1 + r + r^2 + r^3 + \text{ad infinitum.}$$

Now, it has been already proved that if $r < 1$, by taking a sufficiently large number of terms, the numerical value of the series can be made to approach to the numerical value of $\frac{1}{1-r}$, to within any assignable limits. For instance, if $r = \frac{1}{2}$ then $\frac{1}{1-r} = 2$; and if we take four term the series equals 1.875. If we take five terms it equals 1.9375; if six terms it equals 1.96875; and hence in the extreme case, when we suppose the number of terms to be infinitely large, the series is actually equal to 2. And hence if r is less than 1,

$$\frac{1}{1-r} = 1 + r + r^2 + r^3 + \text{ad infinitum,}$$

where by the sign = we mean that the fraction $\frac{1}{1-r}$ is arithmetically equal to the series. But if r is greater than 1, for instance, if equal to 2, the fraction equals -1 ; whereas if we take four terms, the series 15; if five terms, 31; if six terms, 63; and so on where there is no trace of approximation towards arithmetical equality between the series and the fraction. In the former case the series is said to be *convergent*, in the latter *divergent*; and if we include both cases in the expression,

$$\frac{1}{1-r} = 1 + r + r^2 + \dots \text{ ad infinitum;}$$

it must be understood that the sign = signifies algebraically equivalent, not arithmetically equal. This explanation will be sufficient to enable the student to understand the meaning of the terms convergent and divergent, when applied to special series. The general questions that are suggested by series, and their convergency and divergency, belong to the higher parts of the science—and many of them are still doubtful.

7. A test for ascertaining the Convergency of a given Series.

We have already seen that—

$\frac{1}{1-r} = 1 + r + r^2 + r^3 + \dots$ is convergent when r is $\angle 1$. Hence, if we have a series

$$A + B + C + D + \dots$$

and can show that $B \angle rA$, $C \angle r^2A$, $D \angle r^3A$, &c. Then—

$$A + B + C + D + \dots \angle A(1 + r + r^2 + r^3 + \dots).$$

This latter is convergent if r is $\angle 1$. And if so, the former must plainly be convergent too. This gives us a test for ascertaining whether a given series is convergent, which we shall find useful hereafter. The student must remember that, though all series which submit to this test are convergent, many may be convergent which do not submit to it.

For instance, to ascertain whether the series

$$\theta + \frac{\theta^2}{1 \cdot 2 \cdot 3} + \frac{\theta^3}{1 \cdot 2 \cdot 3 \cdot 4 \cdot 5} + \text{&c.}, \text{ ad infinitum, is convergent when } \theta \angle 2.$$

The series may be written—

$$\theta \left\{ 1 + \frac{\theta^2}{2 \cdot 3} + \frac{\theta^4}{2 \cdot 3 \cdot 4 \cdot 5} + \dots \right\}$$

$$\frac{\theta^2}{2 \cdot 3} = \frac{\theta}{2} \times \frac{\theta}{3} \angle \frac{\theta}{2} \cdot \frac{\theta}{2} \text{ or is } \angle \left(\frac{\theta}{2}\right)^2$$

Similarly, $\frac{\theta^4}{2 \cdot 3 \cdot 4 \cdot 5} \angle \left(\frac{\theta}{2}\right)^4$ and so on for the other terms; hence the given series is less than

$$\theta \left\{ 1 + \left(\frac{\theta}{2}\right)^2 + \left(\frac{\theta}{2}\right)^4 + \dots \text{ ad infim.} \right\}$$

and this is convergent if $\left(\frac{\theta}{2}\right)^2 \angle 1$, or if $\theta \angle 2$; and hence the given series is convergent if $\theta \angle 2$.

N.B. $\frac{1}{1+r} = 1 - r + r^2 - r^3 + \dots$ Is true arithmetically when $r \angle 1$.

Hence, the above test of convergency holds good when the terms are alternately positive and negative.

In the following pages we shall confine our attention to three series—the *Binomial*, the *Exponential*, and the *Logarithmic*.

8. To state the Binomial Theorem.

If a, b, n are any numbers whatever, then—

$$(a + b)^n = a^n + n a^{n-1} b + \frac{n(n-1)}{1 \cdot 2} a^{n-2} b^2 + \frac{n(n-1)(n-2)}{1 \cdot 2 \cdot 3} a^{n-3} b^3 + \&c.$$

The reader will observe that the first term is a^n , that in each term the index of a diminishes by unity, while the power of b continually increases by unity, so that the sum of the indices of each term is n .

Again, the coefficient of each term has for its denominator the continued products $1.2.3 \dots$ up to the index of b inclusive; and for numerator, the continued product $n.(n-1)(n-2) \dots$ down to the index of a exclusive. Thus the coefficient of the term which involves $a^{n-r} b^r$ is

$$\frac{n.(n-1)(n-2) \dots (n-r+1)}{1 \cdot 2 \cdot 3 \cdot \dots \cdot r}$$

9. To prove the Binomial Theorem when n is a positive Integer.

(a) To show that $(a + b)^n = a^n + n a^{n-1} b + \dots$

By actual multiplication,

$$(a + b)^2 = a^2 + 2ab + \dots$$

$$(a + b)^3 = a^3 + 3a^2 b + \dots$$

$$(a + b)^4 = a^4 + 4a^3 b + \dots$$

These results plainly suggest the assumption

$$(a + b)^m = a^m + m a^{m-1} b + \dots$$

Multiply both sides by $a + b$, and we have

$$(a + b)^{m+1} = a^{m+1} + (m+1) a^m b + \dots$$

which is clearly of the same form as the assumption, *i. e.* this has $m+1$, wherever that has m . Hence, if the theorem is true for m , it must also be true for $m+1$. Now it is true for 4, \therefore it is true for 5, \therefore for 6, and so on; therefore it is always true for any positive whole number.

$$\therefore (a + b)^n = a^n + n a^{n-1} b + \dots \quad (a)$$

N.B.—If $a = 1$, and $b = x$, we of course have

$$(1 + x)^n = 1 + nx + \dots \quad (b)$$

(B). To show that—

$$(1 + x)^n = 1 + nx + \frac{n(n-1)}{1 \cdot 2} x^2 + \frac{n(n-1)(n-2)}{1 \cdot 2 \cdot 3} x^3 + \dots$$

For, suppose—

$$(1 + x)^n = 1 + nx + A_2 x^2 + A_3 x^3 + A_4 x^4 + \dots (c)$$

It is plain, since $(1 + x)^n$ means $(1 + x)$ multiplied into itself n times, that this series is finite, so that we may employ the principle of indeterminate coefficients.

In the series $A_2, A_3, A_4 \dots$ do not at all depend on x , and will therefore continue the same for all values of x , so that, for instance—

$$(1 + y)^n = 1 + ny + A_2 y^2 + A_3 y^3 + A_4 y^4 + \dots$$

In equation (a), write $x = y + z$. Then—

$$\begin{aligned} (1 + y + z)^n &= 1 + n(y + z) + A_2(y + z)^2 + A_3(y + z)^3 + \dots \\ &= 1 + ny + nz + A_2(y^2 + 2yz + z^2) + A_3(y^3 + 3y^2z + \dots) \\ &= 1 + ny + A_2y^2 + A_3y^3 + A_4y^4 + \dots \\ &\quad + z\{n + 2A_2y + 3A_3y^2 + 4A_4y^3 + \dots\} + \&c. \quad (d) \end{aligned}$$

which is true for all values of y and z .

Again, if in equation (a) we take $1 + y = a$ and $z = b$, we have—

$$(1 + y + z)^n = (1 + y)^n + n(1 + y)^{n-1}z + \dots \quad (E).$$

Now, (d) and (e) are the same for all values of z , \therefore the coefficient of z in each must be the same, \therefore

$$n(1 + y)^{n-1} = n + 2A_2y + 3A_3y^2 + 4A_4y^3 + \dots$$

for all values of y ; multiply both sides by $1 + y$,

$$\begin{aligned} \therefore n(1 + y)^n &= n + 2A_2y + 3A_3y^2 + 4A_4y^3 + \dots \\ &\quad + ny + 2A_2y^2 + 3A_3y^3 + \dots \end{aligned}$$

But by equation, (c) $n(1 + y)^n = n + n^2y + A_2n^2y^2 + A_3n^2y^3 + A_4n^2y^4 + \dots$

$$\begin{aligned} \therefore n + n^2y + nA_2y^2 + nA_3y^3 + nA_4y^4 + \dots \\ = n + (2A_2 + n)y + (3A_3 + 2A_2)y^2 + (4A_4 + 3A_3)y^3 + \dots \end{aligned}$$

These expressions are true for all values of y .

$$\begin{aligned} \text{Hence } 2A_2 + n &= n^2 \\ 3A_3 + 2A_2 &= nA_2 \\ 4A_4 + 3A_3 &= nA_3 \end{aligned}$$

$$\therefore 2A_2 = n^2 - n = n(n - 1), \therefore A_2 = \frac{n(n - 1)}{1 \cdot 2}$$

$$3A_3 = A_2(n - 2) \qquad A_3 = \frac{n(n - 1)(n - 2)}{1 \cdot 2 \cdot 3}$$

$$4A_4 = A_3(n - 3) \qquad A_4 = \frac{n(n - 1)(n - 2)(n - 3)}{1 \cdot 2 \cdot 3 \cdot 4}$$

Hence—

$$(1 + x)^n = 1 + nx + \frac{n(n - 1)}{1 \cdot 2} x^2 + \frac{n(n - 1)(n - 2)}{1 \cdot 2 \cdot 3} x^3 + \dots \quad (F)$$

The student will observe the manner in which each successive coefficient is derived from the one that goes before it. He will easily see that if we look in the $r - 1^{\text{th}}$ and r^{th} terms, viz., $A_{r-1}x^{r-1} + A_r x^r + \dots$ we should then have an equation—

$$\begin{aligned} rA_r - (r - 1)A_{r-1} &= nA_{r-1}, \\ \therefore rA_r &= A_{r-1}(n - r + 1). \end{aligned}$$

so that the general term of the expansion will be—

$$\frac{n(n - 1)(n - 2) \dots (n - r + 1)}{1 \cdot 2 \cdot 3 \cdot \dots \cdot r} x^r.$$

He will also observe that if n is a whole number when r is greater than n , there will be in the general term a factor $n - \overbrace{n+1}^r + 1 = 0$; or x^n is the last term of the series, also the coef. of $x^n = \frac{n \cdot n - 1 \cdot \dots \cdot 2 \cdot 1}{1 \cdot 2 \cdot \dots \cdot n} = 1$. Hence—

$$(1 + x)^n = 1 + nx + \frac{n(n - 1)}{1 \cdot 2} x^2 + \frac{n(n - 1)(n - 2)}{1 \cdot 2 \cdot 3} x^3 + \dots + x^n$$

(γ) To prove the series—

$$(a + b)^n = a^n + n a^{n-1} b + \frac{n(n-1)}{1 \cdot 2} a^{n-2} b^2 + \dots + b^n.$$

For in the last series write $x = \frac{b}{a}$. Then—

$$\left(1 + \frac{b}{a}\right)^n = 1 + n \frac{b}{a} + \frac{n(n-1)}{1 \cdot 2} \frac{b^2}{a^2} + \dots + \frac{b^n}{a^n}.$$

$$\text{Now, } a\left(1 + \frac{b}{a}\right) = a + b,$$

$$\therefore a^2 \left(1 + \frac{b}{a}\right)^n = (a + b)^n.$$

$$\text{But } a^n \left(1 + \frac{b}{a}\right)^n = a^n + n \frac{b}{a} \times a^n + \frac{n(n-1)}{1 \cdot 2} \frac{b^2}{a^2} \times a^n + \dots + \frac{b^n}{a^n} \times a^n$$

$$\therefore (a + b)^n = a^n + n a^{n-1} b + \frac{n(n-1)}{1 \cdot 2} a^{n-2} b^2 + \dots + b^n \dots \text{(II),}$$

which is the Binomial Theorem when n is a positive integer.

In page 184, a table of the developments of powers of a binomial is given. These may be immediately deduced from the series we have just proved. Thus, to develop, or expand $(a + x)^8$, we have—

$$(a + x)^n = a^n + n a^{n-1} x + \frac{n(n-1)}{1 \cdot 2} a^{n-2} x^2 + \dots$$

$$\therefore (a + x)^8 = a^8 + 8 a^7 x + \frac{8 \cdot 7}{1 \cdot 2} a^6 x^2 + \frac{8 \cdot 7 \cdot 6}{1 \cdot 2 \cdot 3} a^5 x^3 + \frac{8 \cdot 7 \cdot 6 \cdot 5}{1 \cdot 2 \cdot 3 \cdot 4} a^4 x^4,$$

$$+ \frac{8 \cdot 7 \cdot 6 \cdot 5 \cdot 4}{1 \cdot 2 \cdot 3 \cdot 4 \cdot 5} a^3 x^5 + \frac{8 \cdot 7 \cdot 6 \cdot 5 \cdot 4 \cdot 3}{1 \cdot 2 \cdot 3 \cdot 4 \cdot 5 \cdot 6} a^2 x^6 +$$

$$+ \frac{8 \cdot 7 \cdot 6 \cdot 5 \cdot 4 \cdot 3 \cdot 2}{1 \cdot 2 \cdot 3 \cdot 4 \cdot 5 \cdot 6 \cdot 7} a x^7 + \frac{8 \cdot 7 \cdot 6 \cdot 5 \cdot 4 \cdot 3 \cdot 2 \cdot 1}{1 \cdot 2 \cdot 3 \cdot 4 \cdot 5 \cdot 6 \cdot 7 \cdot 8} x^8$$

$$= a^8 + 8 a^7 x + \frac{8 \cdot 7}{1 \cdot 2} a^6 x^2 + \frac{8 \cdot 7 \cdot 6}{1 \cdot 2 \cdot 3} a^5 x^3 + \frac{8 \cdot 7 \cdot 6 \cdot 5}{1 \cdot 2 \cdot 3 \cdot 4} a^4 x^4 + \frac{8 \cdot 7 \cdot 6}{1 \cdot 2 \cdot 3} a^3 x^5 +$$

$$\frac{8 \cdot 7}{1 \cdot 2} a^2 x^6 + 8 a x^7 + x^8.$$

$$= a^8 + 8 a^7 x + 28 a^6 x^2 + 56 a^5 x^3 + 70 a^4 x^4 + 56 a^3 x^5 + 28 a^2 x^6 + 8 a x^7 + x^8.$$

The student will observe that the coefficients of $a^7 x$ and of $a x^7$ are the same, as also of $a^6 x^2$ and $a^2 x^6$ of $a^5 x^3$ and $a^3 x^5$.

And, in general, if we write the series, whether we begin from a or from x . we get the same coefficients. Thus—

$$x^8 + 8 x^7 a + 28 x^6 a^2 + 56 x^5 a^3 + 70 x^4 a^4 + 56 x^3 a^5 + 28 x^2 a^6 + 8 x a^7 + a^8$$

$$a^8 + 8 a^7 x + 28 a^6 x^2 + 56 a^5 x^3 + 70 a^4 x^4 + 56 a^3 x^5 + 28 a^2 x^6 + 8 a x^7 + x^8.$$

It can easily be seen that this must be the case, for the former of these two is $(x + a)^8$, and the latter $(a + x)^8$, which are clearly the same thing. This consideration greatly facilitates our expansion of a binomial. Thus—

$$(a + x)^{10} = a^{10} + 10 a^9 x + \frac{10 \cdot 9}{1 \cdot 2} a^8 x^2 + \frac{10 \cdot 9 \cdot 8}{1 \cdot 2 \cdot 3} a^7 x^3 + \frac{10 \cdot 9 \cdot 8 \cdot 7}{1 \cdot 2 \cdot 3 \cdot 4} a^6 x^4$$

$$+ \frac{10 \cdot 9 \cdot 8 \cdot 7 \cdot 6}{1 \cdot 2 \cdot 3 \cdot 4 \cdot 5} a^5 x^5 + \dots$$

$$= a^{10} + 10 a^9 x + 45 a^8 x^2 + 120 a^7 x^3 + 210 a^6 x^4 + 252 a^5 x^5$$

$$+ 210 a^4 x^6 + 120 a^3 x^7 + 45 a^2 x^8 + 10 a x^9 + x^{10}.$$

In like manner—

$$(a+x)^9 = a^9 + 9a^8x + 36a^7x^2 + 84a^6x^3 + 121a^5x^4 \\ + 121a^4x^5 + 84a^3x^6 + 36a^2x^7 + 9ax^8 + x^9.$$

It will also be observed that, in the case of $(a+x)^{10}$ there is a middle term, $252a^5x^5$; but in the case of $(a+x)^9$ there is no middle term. In fact, it is plain that the expansion of $(a+b)^n$ contains $n+1$ terms, for the expansion contains one term in which b does not appear, and also terms containing $b, b^2, b^3 \dots$ up to b^n . Hence, if n is even, $n+1$ is odd, and the expansion has a middle term; if n is odd, $n+1$ is even, and the expansion is without a middle term.

10. To prove the Binomial Theorem for any value of n .

Let us use the notation

$$f(n) = 1 + nx + \frac{n(n-1)}{1 \cdot 2} x^2 + \dots$$

for all values of n .

$$\therefore f(m) = 1 + mx + \frac{m(m-1)}{1 \cdot 2} x^2 + \dots$$

and $f(m+n) = 1 + (m+n)x + \frac{(m+n)(m+n-1)}{1 \cdot 2} x^2 + \dots$, &c.

Now, when m and n are positive integers, we obtain from equation (I.)

$$(1+x)^m = 1 + mx + \frac{m(m-1)}{1 \cdot 2} x^2 + \dots$$

$$(1+x)^n = 1 + nx + \frac{n(n-1)}{1 \cdot 2} x^2 + \dots$$

$$(1+x)^{m+n} = 1 + (m+n)x + \frac{(m+n)(m+n-1)}{1 \cdot 2} x^2 + \dots$$

$$\therefore (1 + mx + \frac{m(m-1)}{1 \cdot 2} x^2 + \dots) \times (1 + nx + \frac{n(n-1)}{1 \cdot 2} x^2 + \dots)$$

$$= (1+x)^m (1+x)^n = (1+x)^{m+n} = 1 + (m+n)x + \frac{(m+n)(m+n-1)}{1 \cdot 2} x^2 + \dots \&c.$$

Hence, when m and n are any positive integers whatever,

$$f(m)f(n) = f(m+n)$$

In accordance with the principle of the permanence of equivalent forms, we assume this to hold good, whatever m and n are, and then interpret the meaning we must assign to $f(m)$ consistently with this assumption.

It is plain that

$$f(m)f(n)f(p) = f(m+n)f(p) = f(m+n+p),$$

and so on for any number of terms.

Hence,

$$f\left(\frac{p}{q}\right) \times f\left(\frac{p}{q}\right) \times f\left(\frac{p}{q}\right) \text{ to } q \text{ factors} = f\left(\frac{p}{q} + \frac{p}{q} + \frac{p}{q} + \dots \text{ to } q \text{ fractions}\right)$$

$$\therefore \left\{f\left(\frac{p}{q}\right)\right\}^q = f(p).$$

Now p is a positive integer,

$$\therefore 1 + nx + \frac{n(n-1)}{1 \cdot 2} x^2 + \dots = (1+x)^n$$

$$\therefore f(n) = (1+x)^n$$

$$\therefore \left\{ f\left(\frac{n}{q}\right) \right\}^q = (1+x)^n$$

$$\therefore f\left(\frac{n}{q}\right) = (1+x)^{\frac{n}{q}}$$

$$\text{Let } \frac{n}{q} = n$$

$$\therefore (1+x)^n = f(n) = 1 + nx + \frac{n(n-1)}{1 \cdot 2} x^2 + \dots$$

when n is a fraction.

Again, if n is negative we have

$$f(n)f(m)f(-m) = f(n+m-m) = f(n)$$

$$\therefore f(m)f(-m) = 1$$

$$f(-m) = \frac{1}{f(m)}$$

Now, m is positive $\therefore f(m) = (1+x)^m$

$$\therefore \frac{1}{f(m)} = (1+x)^{-m}$$

$$\therefore (1+x)^{-m} = f(-m)$$

Let $n = -m$

$$\therefore (1+x)^n = f(n) = 1 + nx + \frac{n(n-1)}{1 \cdot 2} x^2 + \dots$$

when n is negative.

And therefore, for all values of n positive or negative, integral or fractional,

$$(1+x)^n = 1 + nx + \frac{n(n-1)}{1 \cdot 2} x^2 + \frac{n(n-1)(n-2)}{1 \cdot 2 \cdot 3} x^3 + \dots \quad (\text{III.})$$

$$\text{Let } x = \frac{b}{a}$$

$$\left(1 - \frac{b}{a}\right)^n = 1 + n \cdot \frac{b}{a} + \frac{n(n-1)}{1 \cdot 2} \cdot \frac{b^2}{a^2} + \dots$$

$$\text{Now, } a^n \left(1 + \frac{b}{a}\right)^n = (a+b)^n$$

$$\therefore (a+b)^n = a^n + na^{n-1}b + \frac{n(n-1)}{1 \cdot 2} a^{n-2}b^2 + \dots \quad (\text{IV.})$$

which is the Binomial Theorem, and we have proved it to hold good for all values of n : positive or negative, fractional or integral.

N.B.—The Binomial Theorem was discovered by Newton; it is very important, and is constantly used in almost every part of mathematics; it is therefore very necessary that the student be quite familiar with it. It will be well if he will carefully examine the following results.

(1.) To show that

$$(1-x)^n = 1 - nx + \frac{n(n-1)}{1 \cdot 2} x^2 - \frac{n(n-1)(n-2)}{1 \cdot 2 \cdot 3} x^3 + \&c.$$

We obtain this from equation (IV.) by writing $a = 1$, and $b = -x$.

(2). To show that

$$2^n = 1 + n + \frac{n(n-1)}{1 \cdot 2} + \frac{n(n-1)(n-2)}{1 \cdot 2 \cdot 3} + \dots$$

write in the series (IV.) $a=1$ and $b=1$, and we obtain this result.

(3). To show that

$$n + \frac{n(n-1)(n-2)}{1 \cdot 2 \cdot 3} + \&c. = 1 + \frac{n(n-1)}{1 \cdot 2} + \&c.$$

write in the series (IV.) $a=1$ and $b=-1$. Then

$$0 = 1 - n + \frac{n(n-1)}{1 \cdot 2} - \frac{n(n-1)(n-2)}{1 \cdot 2 \cdot 3} + \&c.$$

Whence the result.

(4). To show that

$$\frac{1}{\sqrt{1-x}} = 1 + \frac{1}{2}x + \frac{1 \cdot 3}{2 \cdot 4}x^2 + \frac{1 \cdot 3 \cdot 5}{2 \cdot 4 \cdot 6}x^3 + \&c.$$

$$\text{For } \frac{1}{\sqrt{1-x}} = (1-x)^{-\frac{1}{2}}$$

Hence, by the general formula (IV.), this equals

$$\begin{aligned} 1 + (-\frac{1}{2})(-x) + \frac{(-\frac{1}{2})(-\frac{1}{2}-1)}{1 \cdot 2}(-x)^2 + \frac{(-\frac{1}{2})(-\frac{1}{2}-1)(-\frac{1}{2}-2)}{1 \cdot 2 \cdot 3}(-x)^3 \\ = 1 + \frac{1}{2}x + \frac{1 \cdot 3}{1 \cdot 2}x^2 + \frac{1 \cdot 3 \cdot 5}{1 \cdot 2 \cdot 3}x^3 + \&c. \end{aligned}$$

Whence the result.

(5). To ascertain whether the series $1 + nx + \frac{n(n-1)}{1 \cdot 2}x^2 + \dots$ is convergent.

For the sake of brevity, let us write the series

$$1 + nx + \dots + A_r x^r + A_{r+1} x^{r+1} + A_{r+2} x^{r+2} + \dots$$

$$\text{where } A_r = \frac{n(n-1) \dots (n-r+1)}{1 \cdot 2 \dots r}$$

$$\therefore A_{r+1} = A_r \frac{n-r}{r+1}.$$

$$A_{r+2} = A_{r+1} \frac{n-r-1}{r+2}.$$

$$\text{Now } \frac{n-r}{r+1} = \frac{n+1}{r+1} - 1.$$

$$\frac{n-r-1}{r+2} = \frac{n+1}{r+2} - 1.$$

Now, r can be taken so large that $\frac{n+1}{r+2} < 1$; and therefore $\frac{n+1}{r+2} < 1$. So that if $\frac{n-r}{r+1} < 1$, $\frac{n-r-1}{r+2}$ is also < 1 .Also, these fractions are all negative, \therefore if A_r is positive, A_{r+1} is negative, A_{r+2} is positive, and so on. But if we neglect the consideration of the signs from what has been proved, it appears that $A_r > A_{r+1}, A_{r+1} > A_{r+2}, \&c.$ Hence, the part of the series beginning with $A_r x^r$; i. e.

$$A_r x^r + A_{r+1} x^{r+1} + A_{r+2} x^{r+2} + \dots$$

has its terms (if x be positive) alternately positive and negative, and is term by term less than

$$A_r x^r - A_r x^{r+1} + A_r x^{r+2} - \&c. \dots$$

provided $A_r < 1$.

But this latter series equals—

$$A_r x^r (1 - x + x^2 -) \&c.$$

which is convergent if $x < 1$.

Hence, provided $x < 1$, the series, at all events, after a certain number of terms, converges.

(6.) Hence, if $x < 1$.

$$(1+x)^n = 1 + nx + \frac{n(n-1)}{1 \cdot 2} x^2 + \dots$$

is true arithmetically. We may therefore apply this formula to extracting roots of numbers. Thus to extract the 5th root of 1.1. The fifth root of 1.1, is $(1 + \frac{1}{10})^{\frac{1}{5}}$.

Now,

$$\begin{aligned} (1+x)^{\frac{1}{5}} &= 1 + \frac{1}{5}x + \frac{1 \cdot 4}{5 \cdot 10}x^2 + \frac{1 \cdot 4 \cdot 9}{5 \cdot 10 \cdot 15}x^3 \\ &\quad - \frac{1 \cdot 4 \cdot 9 \cdot 14}{5 \cdot 10 \cdot 15 \cdot 20}x^4 + \frac{1 \cdot 4 \cdot 9 \cdot 14 \cdot 19}{5 \cdot 10 \cdot 15 \cdot 20 \cdot 25}x^5 - \&c. \\ 1 &= 1 & \frac{4}{5 \cdot 10} \cdot \frac{1}{10^2} = \cdot 0008 \\ \frac{1}{5} + \frac{1}{10} &= \cdot 02 & \cdot 0008 \\ \frac{1 \cdot 4 \cdot 9}{5 \cdot 10 \cdot 15} + \frac{1}{10^3} &= \cdot 000048 & \frac{1 \cdot 4 \cdot 9 \cdot 14}{5 \cdot 10 \cdot 15 \cdot 20} \cdot \frac{1}{10^4} = \cdot 00000336 \\ & \quad \cdot 00080336 \\ & \quad \hline & \quad 1 \cdot 019245 \end{aligned}$$

which is the 5th root of 1.1, true to 5 places of decimals.

11. To show that $a^x = 1 + Ax + \frac{A^2 x^2}{1 \cdot 2} + \frac{A^3 x^3}{1 \cdot 2 \cdot 3} + \dots$ ad infinitum,

$$\text{where } A = (a-1) - \frac{(a-1)^2}{2} + \frac{(a-1)^3}{3} - \&c.$$

This is called the Exponential Theorem or series.

By the Binomial Theorem.

$$\begin{aligned} a^x &= (1 + \overline{a-1})^x \\ &= 1 + x(a-1) + \frac{x(x-1)}{1 \cdot 2} (a-1)^2 + \frac{x(x-1)(x-2)}{1 \cdot 2 \cdot 3} (a-1)^3 + \dots (a) \end{aligned}$$

Now, it is plain that if we multiply the factors of the coefficients of $(a-1)^2$, $(a-1)^3$, $(a-1)^4$, ... together, we may re-arrange the series so that it shall become

$$a^x = 1 + Ax + Bx^2 + Cx^3 + Dx^4 + \dots \quad (b)$$

where A, B, C, D, ... contain $(a-1)$ and its powers in some determinate manner. For example, if we examine (a), we shall find that each term, after the first, contains the first power of x ; viz., the second term contains $x(a-1)$, the third contains

$-x \cdot \frac{(a-1)^2}{2}$, the fourth contains $x \cdot \frac{(a-1)^3}{3}$, the fifth $-x \cdot \frac{(a-1)^4}{4}$, and so on; hence the term involving the first power of x when (a) is re-arranged, must be

$$x \left\{ (a-1) - \frac{(a-1)^2}{2} + \frac{(a-1)^3}{3} - \frac{(a-1)^4}{4} + \dots \right\} \&c.$$

$$\therefore A = (a-1) - \frac{(a-1)^2}{2} + \frac{(a-1)^3}{3} - \frac{(a-1)^4}{4} + \dots \quad (c)$$

In like manner, we might find B. C. D. . . . in series (b). Instead of doing so, we proceed as follows: since (b) is true for all values of x , we must have—

$$a^y = 1 + Ay + By^2 + Cy^3 + Dy^4 \dots \quad (d)$$

Now, $a^x \times a^y = a^{x+y}$.

$$\text{But, } a^x \times a^y = 1 + Ax + Bx^2 + Cx^3 + Dx^4 + \dots$$

$$+ y \{ A + A^2x + ABx^2 + ACx^3 + \dots \}$$

$$+ y^2 \{ B + ABx + B^2x^2 + \dots$$

$$+ y^3 \{ C + ACx + \dots$$

$$+ y^4 \{ D + \dots$$

$$= 1 + Ax + Bx^2 + Cx^3 + Dx^4 + \dots$$

$$+ Ay + A^2xy + ABx^2y + ACx^3y + \dots$$

$$+ By^2 + ABxy^2 + B^2x^2y^2 + \dots$$

$$+ Cy^3 + ACxy^3 + \dots$$

$$+ Dy^4 + \dots$$

$$= 1 + A(x+y) + B(x+y)^2 + C(x+y)^3 + \dots$$

$$+ Ay + 2Bxy + 3Cx^2y + 4Dx^3y + \dots$$

$$+ By^2 + 3Cxy^2 + 6Dx^2y^2 + \dots$$

$$+ Cy^3 + 4Dxy^3 + \dots$$

$$+ Dy^4 + \dots$$

$$= 1 + A(x+y) + B(x+y)^2 + C(x+y)^3 + \dots$$

$$+ Ay + 2Bxy + 3Cx^2y + 4Dx^3y + \dots$$

$$+ By^2 + 3Cxy^2 + 6Dx^2y^2 + \dots$$

$$+ Cy^3 + 4Dxy^3 + \dots$$

$$+ Dy^4 + \dots$$

$$= 1 + A(x+y) + B(x+y)^2 + C(x+y)^3 + \dots$$

$$+ Ay + 2Bxy + 3Cx^2y + 4Dx^3y + \dots$$

$$+ By^2 + 3Cxy^2 + 6Dx^2y^2 + \dots$$

$$+ Cy^3 + 4Dxy^3 + \dots$$

$$+ Dy^4 + \dots$$

$$= 1 + A(x+y) + B(x+y)^2 + C(x+y)^3 + \dots$$

$$+ Ay + 2Bxy + 3Cx^2y + 4Dx^3y + \dots$$

$$+ By^2 + 3Cxy^2 + 6Dx^2y^2 + \dots$$

$$+ Cy^3 + 4Dxy^3 + \dots$$

$$+ Dy^4 + \dots$$

$$= 1 + A(x+y) + B(x+y)^2 + C(x+y)^3 + \dots$$

$$+ Ay + 2Bxy + 3Cx^2y + 4Dx^3y + \dots$$

$$+ By^2 + 3Cxy^2 + 6Dx^2y^2 + \dots$$

$$+ Cy^3 + 4Dxy^3 + \dots$$

$$+ Dy^4 + \dots$$

Now, from the early part of this article, it appears that there is *one definite expansion* of a^x , and \therefore of a^{x+y} . Hence (e) and (f), which are each the expansion of a^{x+y} , are not merely equal, but are actually identical; therefore they must be, term by term, the same.

$$\therefore A^2 = 2B \qquad \therefore B = \frac{A^2}{1 \cdot 2}$$

$$AB = 3C \qquad C = \frac{A^3}{1 \cdot 2 \cdot 3}$$

$$AC = 4D \qquad D = \frac{A^4}{1 \cdot 2 \cdot 3 \cdot 4}$$

$$\text{Hence, } a^x = 1 + Ax + \frac{A^2x^2}{1 \cdot 2} + \frac{A^3x^3}{1 \cdot 2 \cdot 3} + \frac{A^4x^4}{1 \cdot 2 \cdot 3 \cdot 4} + \dots \quad (V.)$$

$$\text{where } A = a - 1 - \frac{(a-1)^2}{2} + \frac{(a-1)^3}{3} - \frac{(a-1)^4}{4} + \dots \quad (VI.)$$

N.B. Suppose e to be such a number that—

$$1 = (e-1) - \frac{(e-1)^2}{2} + \frac{(e-1)^3}{3} - \frac{(e-1)^4}{4} + \dots$$

$$\text{Then } e^x = 1 + x + \frac{x^2}{1 \cdot 2} + \frac{x^3}{1 \cdot 2 \cdot 3} + \frac{x^4}{1 \cdot 2 \cdot 3 \cdot 4} + \dots$$

This number e is very important, and is called the base of the Naperian Logarithms, for reasons to be explained hereafter. We can easily ascertain its value in the following manner:—In the above series let $x = 1$. Then—

$$e = 1 + 1 + \frac{1}{1 \cdot 2} + \frac{1}{1 \cdot 2 \cdot 3} + \frac{1}{1 \cdot 2 \cdot 3 \cdot 4} + \dots$$

This series is convergent, since it is clearly—

$$< 1 + \left(1 + \frac{1}{2} + \frac{1}{2^2} + \frac{1}{2^3} + \dots\right)$$

The series, therefore, gives the numerical value of e . This value may be calculated as follows:—

2	1.000000000
3	.500000000
4	.166666666
5	.041666666
6	.008333333
7	.001388888
8	.000198412
9	.000024801
10	.000002755
11	.000000275
12	.000000025
13	.000000002
14	.000000000

These decimals are respectively $\frac{1}{1 \cdot 2}$, $\frac{1}{1 \cdot 2 \cdot 3}$, $\frac{1}{1 \cdot 2 \cdot 3 \cdot 4}$, $\frac{1}{1 \cdot 2 \cdot 3 \cdot 4 \cdot 5}$, &c. Their sum is .718281827; and hence $e = 2.7182818$, which is quite accurate, so far as it goes.

The student will observe, that the reasoning in the above article is founded upon the assumptions (1), that a^x can be expanded in a series of ascending powers of x ; (2), that it can be expanded in only one series of that kind. These assumptions, in the present case, may be considered as resting on the fact that the expansion of a^x is simply a transformation of the binomial theorem. The same remark applies to the following article:—If we make the assumption general, viz., that every function of x can be expanded in a single series of ascending powers of x , we enter upon a question which has given rise to many discussions, which cannot be further noticed here.

Definition.—If $a^y = x$, then y is called the logarithm of x to the base a , and is generally written $y = \log_a x$ where \log_a means “logarithm to base a .”

12. To show that $\Lambda \log_a (1 + x) = x - \frac{x^2}{2} + \frac{x^3}{3} - \frac{x^4}{4} + \&c$, where Λ has the same value as in the last article.

This is called the logarithmic series.

$$\text{Let } y = \log_a (1 + x).$$

$$\text{Then by definition } 1 + x = a^y.$$

$$\therefore (1 + x)^n = a^{ny}.$$

By the last article, if $k = x - \frac{x^2}{2} + \frac{x^3}{3} - \&c$.

$$(1 + x)^n = 1 + k \cdot n + \frac{k^2 n^2}{1 \cdot 2} + \&c.$$

$$\text{and } a^{ny} = 1 + Ay^n + \frac{A^2y^2n^2}{1 \cdot 2} + \&c.$$

Now, since $(1+x)^n$ is identically the same as a^{ny} , these two series must be identically the same.

$$\therefore Ay = k.$$

$$i. e. A \log_a (1+x) = x - \frac{x^2}{2} + \frac{x^3}{3} - \frac{x^4}{4} + \dots \text{ (VII.)}$$

$$\text{where } A = (a-1) - \frac{(a-1)^2}{2} + \frac{(a-1)^3}{3} - \&c.$$

$$\text{N.B.—Now } 1 = (e-1) - \frac{(e-1)^2}{2} + \frac{(e-1)^3}{3} - \&c.$$

$$\therefore \log_e (1+x) = x - \frac{x^2}{2} + \frac{x^3}{3} - \frac{x^4}{4} + \&c.$$

$$\therefore \log_e a = (a-1) - \frac{(a-1)^2}{2} + \frac{(a-1)^3}{3} - \&c.$$

$$\therefore A = \log_e a.$$

Hence, equation (VII.) may be written—

$$\log_e a \log_a (1+x) = x - \frac{x^2}{2} + \frac{x^3}{3} - \frac{x^4}{4} + \&c.$$

It will be observed that if x is $\angle 1$, the series

$$x - \frac{x^2}{2} + \frac{x^3}{3} - \&c.$$

is term by term less than $x - x^2 + x^3 - \&c.$

and is therefore convergent, provided x is $\angle 1$.

ON THE CALCULATION OF LOGARITHMS.

13. On the Calculation of the Arithmetical Values of Quantities expressed by Infinite Series.

In the Treatise on Elementary Algebra the method has been explained of obtaining in numbers the value of an algebraical expression, when definite values are assigned to the letters composing the expression. For instance, if $a = 2$ and $b = 5$, then $(2a + b)(b - a) = 27$. The student may ask, How can an infinite series be reduced? Although we have already given three instances of the manner of doing this, the question is well worth a distinct consideration. We have already seen that

$$\frac{1}{1-x} = 1 + x + x^2 + x^3 + x^4 + x^5 + \dots$$

Now, if $x = \frac{1}{2}$, the fraction is equal to 2, and we know that if we took the whole number of terms of the series we should get exactly 2. The first two terms are 1.5; the first three 1.75; the first four 1.875; the first five terms 1.9375; the first six 1.96875; each result being nearer to the truth than the one before. Thus, by taking a sufficiently large number of terms, we can get as near to the exact value as we like. The series, in fact, affords the means of *approximating* to the true value. Of course, in such a case as the above, we should not care for the approximation, since we can so readily get the real value. But in the large majority of cases we cannot get at the real value, or even the real value cannot be expressed by digits at all, *i. e.*, is not commensurable with unity; in such cases, the approximate value is the only one we can get,

and the series is the means by which we get it. For instance, we have called the base of the Napierian logarithm e . But what is e ? It is such a number that

$$1 = (e-1) - \frac{1}{2}(e-1)^2 + \frac{1}{3}(e-1)^3 - \&c.$$

This is an equation we have no method—no direct method—of solving. We have seen, however, that e is expressed by the series

$$e = 1 + 1 + \frac{1}{1 \cdot 2} + \frac{1}{1 \cdot 2 \cdot 3} + \frac{1}{1 \cdot 2 \cdot 3 \cdot 4} + \&c.$$

From this, as we have already seen, we can find that $e = 2.7182818$, &c. The student may think an approximation a very unsatisfactory result; but he must remember two things:—(1). That greater part of the quantities we have to deal with *cannot* be expressed in whole numbers, or in vulgar fractions, *e.g.*, so common and elementary an expression as $\sqrt{2}$ *cannot* be expressed as a vulgar fraction; and (2), that in practice no measurement is *accurate*, but is *known* to lie within certain limits. For instance, if a tailor measures a piece of cloth, he calls it a yard, though it may happen to be a quarter of an inch more or less. In like manner the most refined scientific measurements (the length of the second's pendulum, of an arc of the meridian, &c.,) are generally the *means* of several results, and are accurate to within certain very small limits. Now, in approximating to a result by means of a series, we can always get to within any given limits that may be assigned. And thus approximations by means of series are as accurate as any, the most refined, measurements can be.

In practice, if we know a number to be true for the first six or seven places of decimals, it is generally known with sufficient or even more than sufficient accuracy. Thus, if we are certain that x lies between 3.16754 and 3.16755, we may call it 3.16754; although if we calculated to a greater nicety we might obtain $x = 3.1675438295$, for the error we commit is $\angle \frac{1}{10000000}$, *e.g.*, an error less than $\frac{1}{4}$ of an inch in one mile.

It is to be observed that in calculating the value of a series we must calculate each term to one or two more places of decimals than the result we wish to obtain, so as to be quite sure that we *carry* the right number to the seventh place. Thus, in finding the value of e (Art. 11), we calculated each term to nine places of decimals, to ensure that our result should be true to seven places.

It is also to be observed that in cutting off the eight and subsequent decimal places, if the eighth place is 5, 6, 7, 8, or 9, we add 1 to the seventh place; but if 4, 3, 2, 1, or 0, we simply omit it. Thus we reckon $2.59716345827 = 2.5971635$

$$\text{But } 2.59716343254 = 2.5971634.$$

For it is plain that 2.59716345827 is nearer to 2.5971635 than to 2.5971634: whereas, as in the second instance, the contrary is the case.

We now proceed to consider the subject of logarithms in detail.

14. To explain the principle on which Logarithms may be used to facilitate calculations.

From the definition of a logarithm already given, it follows that if $M = a^x$ then x is the logarithm of M to the base a ; and if $N = a^y$ then y is the logarithm of N to the base a . Now observe $M \times N = a^{x+y}$, whence it is plain that the *multiplication* of one number by another corresponds to the *addition* of their logarithms. In like manner, $M \div N = a^{x-y}$ or the division of one number by another corresponds to the subtraction of the logarithm of the dividend from that of the divisor. Again, $M^m = a^{mx}$, or the raising of a number to a given power corresponds to the multiplication of the logarithm by that power. In like manner $M^{\frac{1}{n}} = a^{\frac{x}{n}}$ or the extraction of the root of a

given number corresponds to the division of the logarithm by that root. So that if we knew the logarithm which corresponds to any number whatever, and wished to find the product of two numbers, we should merely have to write down the logarithms of the numbers, add them, and then the number whose logarithm is that sum will be the product of the two given numbers; and similarly for the other rules.

Now, tables have been calculated which give us the logarithm corresponding to any number between 1 and 10,000,000. Hence, by using these tables properly, multiplication is performed by means of addition; and in like manner division by means of subtraction, involution by multiplication, and evolution by division.

In the following pages we shall first explain the method by which these tables are calculated, and then proceed to show how they are practically employed.

15. *The following results follow manifestly from what has been said.*

(1.) That if $P = Q$, then $\log_a P = \log_a Q$.

(2.) Since $a^1 = a$. $\therefore \log_a a = 1$.

(3.) Since $a^0 = 1$. $\therefore \log_a 1 = 0$.

(4.) If $M = a^x$, $N = a^y$, then $x = \log_a M$, $y = \log_a N$.

Now, $MN = a^x \times a^y = a^{x+y}$. $\therefore x + y = \log_a MN$.

$\therefore \log_a M + \log_a N = \log_a MN$.

(5.) Similarly, $a^x \div a^y = a^{x-y}$. $\therefore \frac{M}{N} = a^{x-y}$.

$\therefore x - y = \log_a \frac{M}{N}$.

$\therefore \log_a M - \log_a N = \log_a \frac{M}{N}$.

(6.) Again, if $a^x = M$. $\therefore \log_a M = x$.

Now, $M^m = a^x$. $\therefore \log_a M^m = mx$.

$\therefore m \log_a M = \log_a M^m$.

(7.) Similarly, $M^{\frac{1}{m}} = a^{\frac{x}{m}}$.

$\therefore \frac{1}{m} \log_a M = \log_a M^{\frac{1}{m}}$.

(8.) From (4) it is manifest that

$\log_a M + \log_a N + \log_a P + \dots = \log_a MNP \dots$

16. *To show that $\log_a b^x + \log_b x = \log_a x$.*

Now, suppose $x = a^m$, and $x = b^n$

$\therefore \log_a x = m$, and $\log_b x = n$.

But since $a^m = b^n$ we must have $a = b^{\frac{n}{m}}$.

$\therefore \log_a a = \log_a b^{\frac{n}{m}}$

$\therefore 1 = \frac{n}{m} \log_a b$.

$\therefore n \cdot \log_a b = m$

or $\log_a b^x \log_b x = \log_a x$.

From this it follows that if we know the logarithm of a given number to a given base, we can find its logarithm to another base, by dividing the first logarithm by the logarithm of the new base; for instance, suppose our tables give the logarithms of num-

bers to the base 10, and suppose we wished to find the logarithm of a given number (N) to the base 19, we have

$$\log_{19} 19 \log_{19} N = \log_{19} N.$$

Then $\log_{19} 19$ and $\log_{19} N$ are given by the tables, and therefore we know $\log_{19} N$ by division.

17. The practical advantage of Calculating Logarithms to the Base 10.

The Tables of Logarithms commonly printed, are logarithms to the base of 10. In all future articles, whenever we write $\log x$, we mean logarithm to the base 10.

We might calculate tables to the base e ; and the calculation is obviously rendered much easier when this base is employed by the circumstance that

$$\log_e x = x - \frac{x^2}{2} + \frac{x^3}{3} - \&c.$$

whereas, if we use the base 10, we have

$$\log_{10} x = x - \frac{x^2}{2} + \frac{x^3}{3} - \&c.$$

And, in point of fact, the inventor of logarithms, Napier, actually calculated logarithms to this base e , which is hence called the base of the Napierian logarithms.

For the purposes of numerical calculation, however, the base 10 possesses the following decisive advantage over any other.

$$\text{Suppose } 10^n = N$$

$$\text{Then } 10^{n+n} = N \times 10^n$$

Now, suppose n to be a whole number, then $N \times 10^n$ has the same digits as N in the same order, and only differs from it in having its decimal point shifted n places to the right; and again—

And when n is a whole number, $\frac{N}{10^n}$ only differs from N in having its decimal

shifted n places to the left. It follows, therefore, that the decimal part of the logarithm of a number is the same wherever the decimal point may be in the number, and that for every place that the decimal point in the number is shifted to the right, 1. is added to the logarithm; and for every place, it is shifted to the left, 1. is subtracted from the logarithm. Thus the table gives us

$$\begin{aligned} \log 7.5684 &= .8790041. \\ \therefore \log 75.684 &= 1.8790041. \\ \log 756.84 &= 2.8790041. \end{aligned}$$

So again—

$$\log .75684 = -1 + .8790041.$$

or, as it is more generally written—

$$\log .75684 = 1.8790041.$$

Similarly—

$$\log .00075684 = \bar{4}.8790041.$$

It is plain, then, that one calculation gives us the logarithm of the above five numbers, and in fact of as many numbers as can be made by shifting the decimal point to different positions in the combination 75684; but if we adopted any other base, we should require a separate calculation for each of them. This advantage, which the base

10 has over any other, was first seen and applied by Briggs, who was Professor at Oxford about the year 1670; the logarithms are, therefore, sometimes called the "Briggian Logarithms."

The student will perceive that the base 10 has this advantage, in consequence of our system of notation being decimal. If our system were duodecimal, our logarithms would then have to be calculated to the base 12, to be possessed of a like advantage, and so on for any other system.

N.B. The decimal part of a logarithm is called the *mantissa*,—the whole number is called the *characteristic*.

18. To show that every number has a Calculable Logarithm.

It will be observed that—

$$\log_e a = (a - 1) - \frac{(a - 1)^2}{2} + \frac{(a - 1)^3}{3} - , \&c.,$$

may not be (for aught we have yet shown) convergent, unless $a < 2$. Now, if a be any number, a root of it can always be found, say the n^{th} , which shall be less than 2. Now,

$$\log_e a^{\frac{1}{n}} = (a^{\frac{1}{n}} - 1) - \frac{(a^{\frac{1}{n}} - 1)^2}{2} + \frac{(a^{\frac{1}{n}} - 1)^3}{3} - , \&c.,$$

which, since $a^{\frac{1}{n}} - 1$ is less than 1, is convergent. Now, $\log_e a^{\frac{1}{n}} = \frac{1}{n} \log_e a$, \therefore

$$\log_e a = n \left\{ (a^{\frac{1}{n}} - 1) - \frac{1}{2} (a^{\frac{1}{n}} - 1)^2 + \frac{1}{3} (a^{\frac{1}{n}} - 1)^3 - \&c. \right\}$$

which series being convergent, if n is properly chosen, for every value of a , the value of $\log_e a$ might be found from it, for all values of a . To calculate a table from such a formula would be most laborious; but as the calculation of the common tables presupposes that we know $\log_e 10$, if we treat the subject in its logical order, it would be necessary to calculate $\log_e 10$ from this series, before going further. We shall find, if we do so, that—

$$\log_e 10 = 2.3025851.$$

Hence—

$$\frac{1}{\log_e 10} = .434294481.$$

In future pages we shall denote this number by μ . It is called the modulus of the tabular logarithm. Its actual calculation can be seen on p. 273, Vol. II., of Peacock's Algebra.

The logarithmic series to the base 10 we have already seen to be—

$$\log_e 10. \log (1 + x) = x - \frac{x^2}{2} + \frac{x^3}{3} - , \&c.$$

$$\therefore \log (1 + x) = \mu \left\{ x - \frac{x^2}{2} + \frac{x^3}{3} - \&c. \right\}.$$

19. To derive from the Logarithmic series, others from which the numerical values of Logarithms may be calculated.

We have seen that

$$\log (1 + x) = \mu \left\{ x - \frac{x^2}{2} + \frac{x^3}{3} - \&c. \right\}$$

$$\therefore \log (1 - x) = \mu \left\{ -x - \frac{x^2}{2} - \frac{x^3}{3} - \&c. \right\}$$

$$\text{Now } \log. (1+x) - \log. (1-x) = \log. \frac{1+x}{1-x}.$$

$$\therefore \log. \frac{1+x}{1-x} = 2\mu \left\{ x + \frac{1}{3}x^3 + \frac{1}{5}x^5 + \dots \right\}$$

$$\text{Now suppose } \frac{1+x}{1-x} = \frac{q}{p} \therefore x = \frac{q-p}{q+p}.$$

$$\therefore \log. \frac{q}{p} = 2\mu \left\{ \frac{q-p}{q+p} + \frac{1}{3} \left(\frac{q-p}{q+p} \right)^3 + \dots \right\}$$

Suppose $q = p + 1$.

$$\therefore \log. \frac{p+1}{p} = 2\mu \left\{ \frac{1}{2p+1} + \frac{1}{3} \cdot \frac{1}{(2p+1)^3} + \dots \right\}$$

$$\therefore \log. (p+1) = \log. p + 2\mu \left\{ \frac{1}{2p+1} + \frac{1}{3} \cdot \frac{1}{(2p+1)^3} + \dots \right\} \quad \text{VIII.}$$

From this we can calculate successively the values of $\log. 2, \log. 3, \log. 4 \dots$ as far as we please.

Thus, remembering that $\log. 1 = 0$, we have

$$\log. 2 = 2\mu \left\{ \frac{1}{3} + \frac{1}{3} \cdot \frac{1}{3^3} + \frac{1}{5} \cdot \frac{1}{3^5} + \dots \right\}$$

$$\log. 3 = \log. 2 + 2\mu \left\{ \frac{1}{5} + \frac{1}{3} \cdot \frac{1}{5^3} + \frac{1}{5} \cdot \frac{1}{5^5} + \dots \right\}$$

$$\log. 4 = \log. 3 + 2\mu \left\{ \frac{1}{7} + \frac{1}{3} \cdot \frac{1}{7^3} + \frac{1}{5} \cdot \frac{1}{7^5} + \dots \right\}$$

In the ordinary tables the logarithms are given calculated to 7 places of decimals. Hence, in making the calculation from the above series we must take in every term $\succ .0000001$; or, since each term is greater than the one that comes after it, we must reduce each term to decimals until we find one $\angle .0000001$, which we can omit together with all that come after it; all that go before it being reduced to decimals and added together, give the required logarithm. Thus, to find $\log. 11$:—here $p = 10 \therefore 2p + 1 = 21$.

$$\therefore \log. 11 = \log. 10 + 2\mu \left\{ \frac{1}{21} + \frac{1}{3} \cdot \frac{1}{21^3} + \frac{1}{5} \cdot \frac{1}{21^5} + \dots \right\}$$

Now,

$$\frac{1}{21} = .047619047$$

$$\frac{1}{3} \cdot \frac{1}{21^3} = .000035993.$$

$$\frac{1}{5} \cdot \frac{1}{21^5} = 000000049.$$

$$\frac{1}{7} \cdot \frac{1}{21^7} \angle .000000001$$

$$.047655089$$

$$\text{and } 2\mu = .868588962$$

$$\therefore 2\mu \times \left\{ \frac{1}{21} + \frac{1}{3} \cdot \frac{1}{21^3} + \frac{1}{5} \cdot \frac{1}{21^5} + \dots \right\} = \begin{array}{l} .047655029 \times .868588962 = \\ .041892674 \end{array}$$

But $\log. 10 = 1$.

$\therefore \log 11 = 1.0413927$. To seven places of decimals, which is the logarithm you will find registered in the table. From the formula

$$\log \frac{q}{p} = 2\mu \left\{ \frac{q-p}{q+p} + \frac{1}{3} \left(\frac{q-p^3}{q+p^3} \right) + \dots \right\}.$$

Another very convenient formula can be derived.

Thus let $\frac{q}{p} = \frac{x^2}{x^2-1}$. Then $\frac{q-p}{q+p} = \frac{1}{2x^2-1}$.

$$\therefore \log \frac{x^2}{x^2-1} = 2\mu \left\{ \frac{1}{2x^2-1} + \frac{1}{3} \cdot \frac{1}{(2x^2-1)^3} + \dots \right\}.$$

Now, $\log \frac{x^2}{x^2-1} = \log \frac{x^2}{(x-1)(x+1)} =$
 $2 \log x - \log(x-1) - \log(x+1).$

$$\therefore \log(x+1) = 2 \log x - \log(x-1) - 2\mu \left\{ \frac{1}{2x^2-1} + \&c. \right\}.$$

20. To explain the use of this last Series.

The use of this formula, which converges very rapidly, gives us any logarithm in terms of the two that precede it. It will be observed in this formula that $\frac{1}{3} \cdot \frac{1}{(2x^2-1)^3}$ and all the terms following it can be omitted, provided

$$\frac{1}{3} \cdot \frac{1}{(2x^2-1)^3} < .0000001$$

$$\text{and } \therefore \text{ if } \frac{1}{(2x^2-1)^3} < .00000027.$$

$$\text{and } \therefore \text{ if } \frac{1}{2x^2-1} < .003.$$

$$\text{Or if } 2x^2 - 1 > 334.$$

$$\therefore \text{ if } x^2 > 169.$$

$$\therefore \text{ if } x > 13.$$

Hence, if we employ this formula to calculate logarithms, we have, for all numbers greater than 13—

$$\log(x+1) = 2 \log x - \log(x-1) - \frac{2\mu}{2x^2-1}$$

Again, suppose $x > 10000$. Then

$$\frac{2\mu}{2x^2-1} = \frac{\mu}{x^2} \cdot \frac{1}{1-\frac{1}{2x^2}} = \frac{\mu}{x^2} \cdot \left\{ 1 + \frac{1}{2x^2} + \dots \right\}.$$

and

$$\frac{\mu}{2x^4} < .00000001.$$

Hence, the formula finally reduces itself to

$$\log(x+1) = 2 \log x - \log(x-1) - \frac{\mu}{x^2} \dots \text{(IX.)}$$

$$\text{Or } \log(x+1) - \log x = \log x - \log(x-1) - \frac{\mu}{x^2}.$$

$$\text{Now } \frac{\mu}{x^2} - \frac{\mu}{(x+n)^2} = \frac{\mu}{x^2} \cdot \left\{ \frac{2n}{x} - \frac{3n^2}{x^2} \&c. \right\}.$$

∴ if $x \geq 10000$, in which case $\frac{\mu}{a^2} \geq .00000001$.

Hence, if we only calculate to 7 places of decimals, n must be at least many hundreds for $\frac{\mu}{x^2}$ to differ sensibly from $\frac{\mu}{(x+n)^2}$. Now, the formula would give us

$$\log.(x+n+1) - \log.(x+n) = \log.(x+n) - \log.(x+n-1) - \frac{\mu}{(x+n)^2}$$

which, unless n is several hundreds, we have seen is practically the same as

$$\log.(x+n) - \log.(x+n-1) = \log.(x+n-1) - \log.(x+n-2) - \frac{\mu}{x}$$

So that $\log.(x+1) - \log.x = \log.x - \log.(x-1) - \frac{\mu}{x^2}$.

$$\log.(x+2) - \log.x = \log.(x+1) - \log.x - \frac{\mu}{x^2}$$

$$\log.(x+3) - \log.(x+2) = \log.(x+2) - \log.(x+1) - \frac{\mu}{x^2}$$

$$\log.(x+n) - \log.(x+n-1) = \log.(x+n-1) - \log.(x+n-2) - \frac{\mu}{x^2}$$

∴ adding together

$$\log.(x+n) - \log.x = \log.(x+n-1) - \log.(x-1) - n \frac{\mu}{x^2}$$

$$\therefore \log.(x+n) - \log.(x+n-1) = \log.x - \log.(x-1) - n \frac{\mu}{x^2}$$

Now, if n is sufficiently small for $\frac{n\mu}{x^2}$ to be $< .0000001$, it is clear that we may omit

$n \frac{\mu}{x^2}$ so long as this is the case, and hence the differences between the successive logarithms will continue the same within that limit.

For instance, we can show by formula (VIII.) that $\log.(10000) = 4.00000000$.

$$\log.(10001) = 4.0000432945.$$

$$\therefore \log.(10001) - \log.10000 = .000043294.$$

and $\frac{\mu}{(10000)^2} = .0000000042934$.

$$\text{Hence } n \frac{\mu}{(10000)^2} < .0000001.$$

until $n = 20$, so that the logarithms of 10001, 10002, 10003 . . . 10020. can be found the one from the one before it by merely adding .000043294.

We shall then have to calculate $\log.(10020)$ and $\log.(10021)$ from the original formula (VIII.) and find how far we can use the difference between these for deducing $\log.(10022)$ by $\log.(10023)$, &c. After some 20 or 30 logarithms are thus found by simple addition, a fresh calculation will become necessary: by proceeding in this manner, without any exorbitant labour, a table which gives the logarithm for every number from 10000 up to 99999 can be constructed; which is practically the same as from 1 up to 100000.

It is to be observed that with such a table, by means of a very simple subsidiary calculation, we can obtain the logarithm of any number from 1 to 1000000.

Thus, the tables give us $\log. 73894$, $\log. 73895$. *i.e.*, $\log. 7389400$, $\log. 7389500$, for these only differ from those in the characteristic.

The subsidiary calculation referred to enables us to fill up any one of the logarithms of 7389401, &c., up to 7389499.

21.—To explain the construction and use of the Table of Proportional Parts.

Suppose N to be a number such as that above referred to, $\succ 1000000$; and suppose its $\log.$ to be given in the table; then $\log. (N + 100)$ is also given in the tables. From these data we want to find $\log. (N + \delta)$ where δ lies between 0 and 100.

$$\begin{aligned} \text{Now } \log. (N + \delta) &= \log. N \left(1 + \frac{\delta}{N}\right) \\ &= \log. N + \log. \left(1 + \frac{\delta}{N}\right) = \log. N + \mu \left\{ \frac{\delta}{N} - \frac{1}{2} \left(\frac{\delta}{N}\right)^2 \text{ \&c.} \right\} \end{aligned}$$

$$\text{Now } \delta \angle 100 \prec 1000000$$

$$\therefore \left(\frac{\delta}{N}\right)^2 \angle \frac{1}{(10000)^2} \angle \cdot 00000001$$

which can be omitted, since we only take in the first seven places of logarithms.

$$\therefore \log. (N + \delta) = \log. N + \frac{\mu}{N} \cdot \delta$$

$$\therefore \log. (N + 100) = \log. N + \frac{\mu}{N} \cdot 100$$

Now, $\log. (N + 100) - \log. N = \Delta$ (suppose) is given by the tables, and we see that—

$$\Delta = \frac{\mu}{N} \cdot 100$$

$$\therefore \log. (N + \delta) = \log. N + \Delta \times \frac{\delta}{100}$$

which is true for every value of δ from 1 to 99.

If a and b are the digits of δ , so that $\delta = 10 \cdot a + b$. This formula can be written—

$$\log. (N + \delta) = \log. N + \frac{\Delta a}{10} + \frac{1}{10} \cdot \frac{\Delta b}{10}$$

We have already seen that the difference between two consecutive logarithms is the same for several logarithms together; accordingly, a small subsidiary table, giving $\frac{\Delta}{10} \cdot \frac{\Delta \times 2}{10} \cdot \frac{\Delta \times 3}{10} \dots \frac{\Delta \times 9}{10}$, is calculated for each different value of Δ , and is printed, as Δ occurs, in the margin of the table. For instance, Δ corresponding to $\log. 28568$, is $\cdot 0000152$; or, as it is written, 152, it being understood that the last figure, 2, falls under the seventh decimal of the logarithm. In this case the subsidiary table is the accompanying. It is called a Table of Proportional

Parts. Since a and b are digits, this table gives at once $\frac{\Delta a}{10}$ and $\frac{\Delta b}{10}$ and

therefore $\frac{1}{10} \cdot \frac{\Delta b}{10}$. Hence, by means of this table, we can determine $\log.$

$(N + \delta)$ from $\log. N$ by addition only.

Thus, $\log. 2856800 = 8 \cdot 4558798$,

1	15
2	30
3	46
4	61
5	76
6	91
7	106
8	122
9	137

Now, $\frac{\Delta \times 3}{10} = \cdot 0000046$, and $\frac{1}{10} \cdot \frac{\Delta \times 7}{10} = \cdot 00000106 = \cdot 0000011$, as we only take in seven places of decimals. Hence, $\log. 2856837 = 6\cdot4558798 + \cdot 0000046 + \cdot 0000011 = 6\cdot4558855$.

We have now given a full explanation of the principles on which Logarithmic Tables are calculated, so far as that explanation is possible in a purely elementary treatise, and have exemplified those principles in the case of the ordinary tables which (practically) give the logarithms of numbers from 1 up to 10,000,000, to seven places of decimals. The student may ask, what would be done if a case occur in which we have numbers exceeding 10,000,000? The answer to the question is the following:— If the number were, for instance, 97536982, and if the calculation demanded so much accuracy that we could not consider this as equal to 97536980, then a more refined set of tables would be necessary; in point of fact, however, for all ordinary calculations, the degree of accuracy which the common tables allow of is sufficient.

We now proceed to explain the practical method of using the tables:

THE USE OF A TABLE OF LOGARITHMS.

For the purpose of explanation, the following is printed from p. 78 of Hülse's edition of Vega's Logarithms.

N. 46000 * L. 662												
N	O	1	2	3	4	5	6	7	8	9	P	P
4600	662 7578	7673	7767	7862	7956	8050	8145	8239	8334	8428		
4601	8522	8617	8711	8805	8900	8994	9089	9183	9277	9372		95
4602	9466	9561	9655	9749	9844	9938	*0032	*0127	*0221	*0315	1	10
4603	663 0410	0504	0598	0693	0787	0881	0976	1070	1164	1259	2	19
4604	1353	1447	1542	1636	1730	1825	1919	2013	2108	2202	3	29
											4	38
											5	48
											6	57
											7	67
											8	76
											9	86

(1). To find the Logarithm, when the Number is given in the Tables.

(a) To find the mantissa.

Suppose we want to find the logarithm of 46017. The number N. 46000 at the top of the page will direct us to the page on which we shall find 46017; the number 4601, in the column marked N, will give us the line in which we shall find what we want. Pass your eye along the line 4601, until it comes to column 7, there we find 9183. You will observe that there is 662 written in column O; this is to be written before every one of the numbers under the other columns, and is only written once to render the tables more compact. Write this in front of 9183, which we before found, and we obtain 6629183. This is the mantissa of the logarithm of 46017; it is, therefore, a decimal, and must be written $\cdot 6629183$.

So again, to find mantissa of logarithm of 46035. look down col. N for 4603, look along the line 4603 till you come to col. 5, when you find 0881 before this prefix 663, and $\cdot 6630881$ is the mantissa of logarithm of 46035.

Again, to find the mantissa of logarithm of 46028, look for 4602 in col. N; along this line, in col. 8, you find *0221; the asterisk in front of this 0221 shows that we must add 1 to the 662, and thus we obtain for the mantissa of this logarithm .6630221.

(β) To find the characteristic.

We have already explained the principle of doing this — if we apply that principle, we shall obtain (Art. 17, p. 278)—

log. 4.6017	=	.6629182
log. 4601.7	=	3.6629182
log. 4601700.	=	6.6629182
log. .00046017	=	$\bar{4}$.6629182
log. .46017	=	$\bar{1}$.6629182

If you examine these cases, you will find that they suggest the following rule:—
“Place your pen between the first and second FIGURE (NOT CIPHER), and count one for each figure or cipher, until you come to the decimal point, the number this gives will be the characteristic; if you count to the right, the characteristic is positive, if to the left, the characteristic is negative. Thus, in finding log. 4.6017, if you place your pen between the first figure (4), and second (6), it falls on the decimal point, in this case, therefore, there is no characteristic. Next, in the case of log. 4601.7, place your pen between (4) and (6), and count $\begin{array}{l} 4, 601.7 \\ | 123 \end{array}$ the characteristic is 3; and as you count to the right, it is plus 3. Next, in the case log. 4601700, here the decimal point falls behind the last cipher. Hence, counting as before, we have $\begin{array}{l} 4 601700 \\ | 123456, \end{array}$ and the characteristic is plus 6. Again, in the case, log. .00046017; the first figure is, as before, 4. Hence counting, we have $\begin{array}{l} .0004, 6017, \\ 4.321 \end{array}$ but here we count to the left, so that the characteristic is negative or $\bar{4}$. Again, in the case, log. .4601, we have $\begin{array}{l} .4 6017, \\ 1 | \end{array}$ and the characteristic is $\bar{1}$.

Instead of writing log. .03046017 = $\bar{4}$.6629182, this is frequently written 6.6629182. To explain this, observe that $\bar{4}$.6629182 means $-4 + .6629182$, which clearly equals $6 + .6629182 - 10$, or $6.6629182 - 10$. It is usual to omit the -10 , and write 6.6629182, no experienced calculator would forget the -10 although it is not written down, but as this tract is intended for beginners, we shall never omit the -10 , but as it may suit our purpose write log. .00046017 = $\bar{4}$.6629182 or $6.6629182 - 10$.

To find log. 46. Since $46 = 46.000$ and the table gives mantissa log. 46000 = .6627576.

$$\therefore \log. 46 = 1.6627576.$$

Hence, to find the logarithm of any number given in the table, first find the mantissa, and then prefix to it the characteristic, in the manner above explained.

N.B.—The student must thoroughly master the above before proceeding further. He must get a table of logarithms — (of which there are many by Hutton, Callet, Babbage, &c., all as perfect as those of Vega's, to which reference has been made—there is one also published in Chambers's Educational Course, which is cheaper than most others)—and will work out many examples, such as the following:—Find the logarithms of—

72·043	7204·3	8·5972	6315·9
84658	6397200	64532	6·5973.
·057234	·000058	762	·035872
·35872	63500	635	6·35
20000	200	·02	·029

(2). To find the Logarithm of a Number not given in the Tables.

The rule for the characteristic is the same as given above. For finding the mantissa we proceed as follows:—The student will observe that each logarithm on p. 284 differs from the one before it by 94 or 95. Call this 95 and construct a table of proportional parts as before explained; this is printed in the column marked P P. We then proceed as follows:—To find log. ·0460267.

N.	L
46026	6630032
P.P 7	67
460267	·6630099

$$\therefore \log \cdot 0460267 = \bar{2} \cdot 6630099.$$

In practice this is arranged as follows:—

46026	·6530032
<u>7</u>	67
log. ·0460267	$\bar{2} \cdot 6630099$

Again, to find log. 460·3629.

46036	·6630976
2	19
<u>9</u>	8,6
log. 460·3629	= 2·6631004

To find log. 4604·508.

46045	·6631825
08	7.6
log. 4604·508	2·6631833

In like manner the student may find the logarithms of

75·84653	·0927543.	13·02528.
----------	-----------	-----------

(3). To find the Number corresponding to a given Logarithm.

It very rarely happens that the logarithm is exactly to be found in the tables. If it is, the only difficulty we have to contend with in such a case is that of fixing the decimal point. For instance, find the number corresponding to the logarithm 3·6629089. At the top of the page we have L 662; this will direct us to the page on which the logarithm will be found; then, looking in the other part of the table we find 9089, in the column 6 of the line marked 4601 of column N. \therefore the number corresponding to the mantissa ·6629089 is 46016. To fix upon the position of the decimal point, we must modify the rule previously given: place the pen between the first and second figure and count off as many figures as there are units in the characteristic,—to the right if the characteristic is positive, to the left if negative, and if there are not figures enough add or prefix as many ciphers as necessary; thus in the present case $\overset{4601 \cdot 6}{123} \therefore$ the number corresponding to logarithm 3·6629089 is 4601.6, similarly, that corresponding to $\bar{3} \cdot 6629089$ is 00 46016.

(4). To find the Number corresponding to a given Logarithm, which does not exactly occur in the Tables. We proceed as follows:—

Find the number corresponding to the logarithm 2·6629319.

The Logarithms 6629277 and 6629372 are in the table; the number, therefore, will be between 46018 and 46019. It will therefore be the former, with something added on. To find this “something” we proceed as follows:—

Logarithm next less 46018	6629319
	6629277
	42
Prop. part corresponding to	4 38
	4
	03 38

∴ logarithm of 4601843 is 6629319.

∴ logarithm of 460·1843 is 2·6629319.

(5). To find the Arithmetical complement of the Logarithm of a Number.

N.B. If x is any number whatever, then the ar. comp. of $x = 10 - x$.

Now $10 - 3\cdot7568274 = 6\cdot2431726$.

$10 - 2\cdot3907526 = 11\cdot6092474$.

$10 - \cdot9328243 = 9\cdot0671260$.

If you examine these, you will find that the subtraction is performed by subtracting the last figure (to the right hand) from 10, and each of the rest from 9; in fact, to take the first case, we should proceed as follows: 4 from 10 leaves 6, and carry 1. Then $1 + 7 = 8$; take 8 from 10, leaves 2, and carry 1; but taking 8 from 10 is of course the same thing as taking 7 from 9, and so on. The student may, perhaps, think this very obvious, but he will do well not to despise it.

Hence, to find the ar. comp. of the logarithm of a number, find the logarithm and subtract it from 10, in the manner above explained.

e. g. Find ar. comp. of log. 46·028.

log. 46·028 = 1·6630221.

ar. . comp. log. 46·028 = 8·3369778.

(6). To find the product of several numbers by means of a Table of Logarithms.

We have seen that if $N = xyz \dots$. Then

$\log. N = \log. x + \log. y + \log. z + \dots$

Hence, find the logarithm of each number, add them together — this gives the logarithm of the quotient — find the number corresponding to this logarithm, and we have the product itself.

Ex. Find the product of $52\cdot731 \times 6\cdot0032 \times \cdot0759$

log. 52·731 = 1·7220660

log. 6·0032 = ·7783828

log. ·0759 = 8·8802418 — 10.

	1·3806906
24026	·3806815
	91
6	91
24·0265	Ans.

N.B.—In any example of this kind, never use a negative characteristic, such as 2·8302418. but 8·8802418 — 10 as above; by doing so, there is nothing but straight forward addition to be performed until the end, when — 10 can be easily struck off the characteristic of the sum.

(7.) To divide one number by another by means of a Table of Logarithms.

We have seen that if $N = \frac{x}{y}$. $\therefore \log N = \log x - \log y$.

$$\therefore \log N = \log x + 10 - \log y - 10$$

$$\therefore \log N = \log x + \text{Ar. Comp. log } y - 10.$$

Hence, "To log numerator, add ar. comp. logarithm of denominator, and subtract 10 from the sum — this gives logarithm of quotient.—Find number corresponding to this logarithm, and the number is the quotient required."

Ex. Divide 37·052 by 6741·6.

$$\begin{array}{r} \log 37\cdot052 = 1\cdot5688117 \\ \text{Ar. : C. : } \log 6741\cdot6 - 10 = 6\cdot1712370 - 10 \end{array}$$

$$\begin{array}{r} 54960 \qquad \qquad \qquad 3\cdot7400487 \\ \qquad \qquad \qquad \qquad \qquad \cdot7400467 \\ \hline \qquad \qquad \qquad \qquad \qquad \qquad 20 \\ \qquad \qquad \qquad \qquad \qquad \qquad 16 \\ \hline \qquad \qquad \qquad \qquad \qquad \qquad 4 \\ \qquad \qquad \qquad \qquad \qquad \qquad 4,0 \\ \hline \qquad \qquad \qquad \qquad \qquad \qquad 5 \\ \hline \qquad \qquad \qquad \qquad \qquad \qquad \cdot005496025 \text{ Ans.} \end{array}$$

(8) Similarly, if $N = \frac{abc}{xyz}$. We have—

$$\begin{array}{l} \log N = \log a + \log b + \log c + \text{Ar. C. log } x - 10 \\ \qquad \qquad \qquad + \text{Ar. C. log } y - 10 + \text{Ar. C. log } z - 10. \end{array}$$

By this means log N is found by a single addition sum. Thus, find the

value of $\frac{3\cdot0972 \times 56\cdot035}{\cdot002 \times 8746\cdot5 \times 3\cdot124}$.

$$\begin{array}{r} \log 3\cdot0972 \qquad \qquad \qquad 4909693 \\ \log 56035 \qquad \qquad \qquad 1\cdot748594 \\ \text{Ar. C. log } \cdot002 - 10 \qquad \qquad 12\cdot6989700 - 10 \\ \text{Ar. C. log } 8746\cdot5 - 10 \qquad \qquad 6\cdot0581657 - 10 \\ \text{Ar. C. log } 3\cdot124 - 10 \qquad \qquad 9\cdot5052890 - 10 \end{array}$$

$$\begin{array}{r} 31758 \qquad \qquad \qquad \cdot5018534 \\ \qquad \qquad \qquad \qquad \qquad \cdot5018531 \\ \hline \qquad \qquad \qquad \qquad \qquad \qquad 3 \\ \qquad \qquad \qquad \qquad \qquad \qquad 2,7 \\ \hline \qquad \qquad \qquad \qquad \qquad \qquad 02 \\ \hline 3\cdot175802 \text{ Ans.} \end{array}$$

(9.) To find any power of a Number, we have seen that if $N = a^n$. $\log N = n \log a$.

Hence, if we multiply log. of the number by the index, we obtain the logarithm of the power of the given number; and finding the number corresponding, we obtain the power itself.

Thus, find the fifth power of 2·00573

		·3022660
20057		65
3	-----	
log. 2·00573	=	·3022725
Multiply by index		5

		1·5113625
32461		·5113619

04		6
		5,4
32·46104	Ans	-----

Again, find the third power of ·02751.

log. ·02751		8·4394906 — 10
		3

		25·3184718 — 30
		or, 5·3184718.

We may in practice write this as follows.—

log. ·02751		8·4394906 — 10
		3

		5·3184718
20810		·3184599

		119
5		104

		15
·7		14,6

·00002081957	Ans.	

10. To find the Root of any Number.

If $N = a^n$, then,

$$\log N = \frac{1}{n} \log a.$$

Hence, "Find the logarithm of the given number, divide it by the number indicating the root.—this is the logarithm of the required root—the corresponding number is the root itself."

Thus, extract the 5th root of 72·095.

log. 72·095		5)1·8979051

		·3795810
23965		·3795774

		36
		36
2		

2·39652	Ans.	

Again, extract the 7th root of ·00972.

$$\text{Log. } \cdot 00972 = \frac{1}{7} \cdot 9876663 = 7 \cdot 9876663 - 10.$$

All this has to be divided by 7. This will be effected most easily by adding and subtracting such a multiple of 10 as shall make the negative part 70.

i. e., take $\log. \cdot 00972 = 67\cdot 9876663 - 70$.

$$\begin{array}{r}
 7)67\cdot 9876663 - 70 \\
 \hline
 9\cdot 7125238 - 10. \\
 51585 \quad \quad \quad 7125234 \\
 \hline
 \quad \quad \quad \quad \quad \quad 4 \\
 \quad \quad \quad \quad \quad \quad 4,2 \\
 \hline
 5158505. \quad \text{Ans.}
 \end{array}$$

If we had to extract the 6th root of the above number, we must of course take $\log. \cdot 00972 = 57\cdot 9876663 - 60$. And again, to extract the cube root, we must take $\log. \cdot 00972 = 57\cdot 9876663 - 30$.

11. The student must exercise himself in working several examples, like each of those above given. When he has done so, he may then, for practice, work some more complicated examples, such as the following :—

Find the value of	$31^{\frac{2}{3}} \times (\cdot 05796)^3$
	$15\sqrt{2}$
(a) $\log. 31^{\frac{2}{3}}$	1·4913617
	<u>2</u>
	3)2·9827234
	<u>9942411</u>
(b) $\log. (\cdot 05796)^3$	8·7631284 — 10
	<u>3</u>
	6·2893852 — 10
(c) $\log. 15$	1·1760913.
(d) $\log. \sqrt{2}$	2)·3010300
	<u>1505160</u>
Hence $\log. 31^{\frac{2}{3}}$	9942411
$\log. (\cdot 05796)^3$	6·2893852 — 10
Ar. C. $\log. 15 - 10$.	8·8239087 — 10.
Ar. C. $\log. \sqrt{2} - 10$	9·8494850 — 10
	<u>5·9570200</u>
90577	9570179
	<u>21</u>
4	19
	<u>2</u>
4	

·0009057744 Ans.

N.B. To find the logarithm of a mixed number reduce it to an improper fraction
 To find the logarithm of a vulgar fraction use the formula. If $N = \frac{a}{b}$.

$$\log. N. = \log. a + \text{Ar. Com. log. } b - 10.$$

precisely as in division, excepting that there is no occasion to find N itself.

Thus, in example: Find log. of $\frac{37052}{67416}$

$$\begin{array}{r} \log. 37052 \qquad \qquad 4.5688117 \\ \text{Ar. C. log. } 67416 - 10 \qquad 5.1712370 - 10 \\ \hline \end{array}$$

$$9.7400487 - 10$$

$$\therefore \log. \frac{37052}{67416} = \bar{1}.7400487.$$

PLANE TRIGONOMETRY.

1. *On representing Lines and Angles by Numbers.*

If we have a line of any length, we can represent it numerically by the number of times it contains a given line, which we take to represent unity. Thus if we take a line a foot long to be the unit of length, a line seven feet long can be represented by 7. Of course, the same holds good of any other line. And so when we speak of a line 8, 5, or whatever the number may be, we mean that the line in question contains 8 or 5 of the given unit, as 8 feet, or 5 feet. And of course, if we can represent lines by numbers, we can generalize the numbers by letters, and thus we can represent lines by algebraical symbols: so that $a b c, x y z,$ &c. may be understood to represent lines. In the same manner as before, if we speak of a line a , we mean a line containing as many units of length (*e.g.* feet) as a contains units of number.

On the same principle we may express angles by numbers or by letters. This is done by dividing the right angle into 90 equal parts, each of which is called a degree, and dividing the degree into 60 equal parts, each called a minute, and the minute into 60 equal parts, each called a second. An angle is then expressed as being so many degrees, with odd minutes and seconds, *e.g.* 36 degrees, 57 minutes, 31 seconds, (which is usually written $36^{\circ} 57' 31''$), in the same manner as a line is expressed by so many yards, with odd feet and inches.

Of course, as we can thus represent angles by numbers, we may also represent them by letters, and may have angles ABC; where the angle A (for instance) means that the angle contains as many degrees and parts of a degree as A contains units and parts of a unit.*

In the same manner as we may measure lines either by feet or yards, or miles, so we might take, as the unit of angular measure, any other part of the right angle than the $\frac{1}{90}$ th; and in fact at the end of last century, when the decimal notation was introduced into France, it was proposed by certain French mathematicians, to make the degree the $\frac{1}{100}$ th part of the right angle. The proposition was at no time extensively accepted, and is now quite abandoned.

2. *Definition of the Science of Trigonometry.*

We are thus enabled to express lines and angles by numbers; and this is the first step towards making calculations in which lines and angles are the data. However, before these calculations can be performed, it is necessary that the relations which exist between straight lines and angles should be investigated. It is the object of the science of Trigonometry to make these investigations.

The object of the science will, perhaps, be more clearly stated, if we limit the definition so as to make it correspond more closely to its derivational meaning, by saying that *the science of Trigonometry has for its object the investigation of the relations*

* It is usual to denote angles either by Roman capital letters, ABC; or else by Greek small letters, $\alpha, \beta, \gamma \dots \theta, \phi, \psi \dots$ while generally the small Roman $a b c$ denote lines. This is, of course, only a conventional arrangement.

which exist between the sides and angles of triangles and the algebraical expression of those relations.

The immediate application of the science is to the calculation of certain parts of a

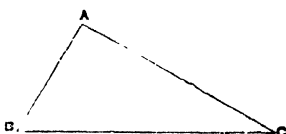

viz., the measurement of triangles.

triangle from certain given parts; *e. g.*, having given the sides BA, AC, and the angle BAC of the triangle ABC, we can calculate the magnitude of the side BC.

The science has, however, very many other uses besides the one from which its name is taken,

3. The Circular Measure of an Angle.

The measures above given enable us to compare arithmetically one straight line with another, and one angle with another. But it is to be observed, that an angle and a line are heterogeneous magnitudes; and therefore, if we would perform algebraical operations in which lines and angles enter, we must devise some plan of measuring angles that shall express them by means of lines, or of the ratios of lines.

In fact, when we speak of an angle (of 57° suppose) it tells us what the angle is, but does not at once give us the means of comparing that angle with given lines.

The measure of the angle adopted for the purpose of such calculations, is called the circular measure.

It is founded on the two well-known geometrical propositions.

(a) That in circles of the same radius the angle is proportional to the arc which subtends it.

(b) And that for the same angle, in circles of different radii, the arc varies as the radius.

If a = the arc BC,

θ = the angle BAC, subtended by the arc

BC,

r = the radius AC.

we may express these propositions by the two variations

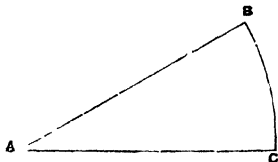

$$a \propto \theta \text{ when } r \text{ is constant.}$$

$$a \propto r \text{ when } \theta \text{ is constant.}$$

$$\therefore a \propto r\theta \text{ when both vary.}$$

$$\therefore \theta \propto \frac{a}{r}$$

or the angle is measured by the ratio of the arc to the radius.*

If we take the unit of angle to be the angle which is subtended by an arc of the same length as the radius, then

$$\theta = \frac{a}{r}$$

In this case, the angle being measured by the ratio of two lines, it can enter a calculation in which we are dealing with lines.

N.B.—We can easily find the number of degrees in the angle which is the unit of circular measure.

Let $x =$ the number of degrees required. Then x is subtended by an arc of the length of the radius $= r$.

Now an angle of 180° is subtended by a semicircle; i.e. by an arc $= \pi r$, where $\pi = 3.14159$.

$$\therefore \frac{x^\circ}{180^\circ} = \frac{r}{\pi r} = \frac{1}{\pi}$$

$$\therefore x = \frac{180^\circ}{3.14159} = 57.29577.$$

4. *The definitions of the trigonometrical lines and ratios.*

It is, however, generally more convenient, and for our present purposes necessary, to determine an angle not by an arc, or by the ratio of an arc to its radius, but by certain straight lines, or by the ratio of certain straight lines to each other. These lines, or, as they are now more commonly regarded, these ratios, are called respectively the sine, tangent, secant, cosine, cotangent, or cosecant of the angle. We proceed to define these terms.

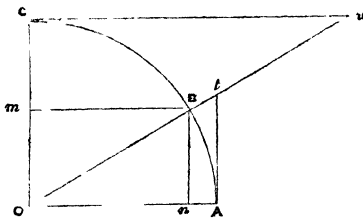

Let AOB be an angle A. Draw OC perpendicular to OA, and with the centre O and any radius OA describe an arc of a circle, meeting OC in C.

Draw Bn, Bm, perpendicular to OA, OC; at A and C draw At, Cu, perpendicular to OA, OC. Then Bn is defined to be the sine of the angle AOB, to the radius OA.

- At is defined as the tangent of AOB.
- Ol secant of AOB.
- An versed sine of AOB.

- Hence, also
- Bm (or On) is the sine of BOC.
 - Cu tangent of BOC.
 - Ou secant of BOC.

Now BOC is $90^\circ - A$.

And Bm, Cu, Ou, are defined as being the cosine, cotangent, cosecant respectively of AOB.

Hence—

$$\left. \begin{array}{l} Bn = \text{sine } A \\ Bm \text{ or } On = \text{cosine } A \\ At = \text{tan. } A \\ Cu = \text{cotan. } A \\ Ot = \text{sec. } A \\ Ou = \text{cosec. } A \end{array} \right\} \text{to the radius OA.}$$

To this method there is the obvious objection that the sines, &c., of a given angle have different values, according as they are referred to different radii, accordingly instead of defining the sines, &c., as lines, it is, as above stated, now more usual to define them as ratios; by which means all consideration of the radius to which the sines are referred is avoided. According to this method the definitions are given as follow:—

CA Any right angled triangle having the right angle at C.

Then The sine of A is $\frac{BC}{AB}$

The tangent of A is $\frac{BC}{AC}$

The secant of A is $\frac{AB}{AC}$

Hence— The sine of B is $\frac{AC}{AB}$

The tangent of B is $\frac{AC}{BC}$

The secant of B is $\frac{AB}{BC}$

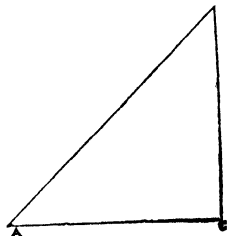

But because $A = 90 - B$

The sine of B is the cosine A.

The tangent of B, cotangent of A.

The secant of A is the cosecant of A.

Hence— Sine A = $\frac{BC}{AB}$ Cosine A = $\frac{AC}{AB}$

Sec. A = $\frac{AB}{AC}$ ----- A B

N.B.—The angle which with another makes up 90° is called the complement of that angle. Hence B is the complement of A; and the cosine, cotangent, and cosecant of an angle are evidently the sine, tangent, and secant of its complement.

It is plain (Euc. VI. 4) that the values of these ratios depend solely on the angle, and are quite independent of the magnitude of the sides of the triangles. If, then, we can by any means calculate the value of these ratios, which correspond to any angle, these values can be arranged in a table; and it is plain that, having such tables, if we have given any one of the ratios defined above, we know the angle; and *vice versa*, if we have the angle given, we know the ratio.

Such tables have been calculated on principles to be hereafter explained;—for our present purpose it is sufficient for us distinctly to understand, that if we have given the numerical value of any one of the ratios, we know the angle that corresponds to it, and *vice versa*.

5. On the relations between the Trigonometric Ratios of the same Angle.

Let $\triangle ABC$ be a right-angled triangle,
 A any given angle.
 C the right angle.

$$\text{Then} \quad AC^2 + BC^2 = AB^2 \quad (\text{Eucl. 47.})$$

$$\therefore \frac{AC^2}{AB^2} + \frac{BC^2}{AB^2} = 1.$$

$$\therefore \cos^2 A + \sin^2 A = 1 \dots (1.)$$

$$\text{Again} \quad \tan A = \frac{BC}{AC}$$

$$\text{cotan } A = \frac{AC}{BC}$$

$$\therefore \tan A, \text{ cotan } A = 1 \dots (2)$$

Again,

$$\tan A = \frac{BC}{AC} = \frac{AB}{AC} \cdot \frac{BC}{AB}$$

$$\therefore \tan A = \frac{\sin A}{\cos A} \dots (3)$$

$$\text{Again,} \quad \sec A = \frac{AB}{AC} = \frac{1}{\cos A}$$

$$\therefore \sec A = \frac{1}{\cos A} \dots (4)$$

In the same manner it may be easily proved that

$$\text{Cotan } A = \frac{\cos A}{\sin A} \dots (5)$$

$$\text{Cosec } A = \frac{1}{\sin A} \dots (6)$$

$$\frac{\sec A}{\text{Cosec } A} = \tan A \dots (7)$$

It is of very great importance that the student be familiar with the relations we have just established. He will therefore do well to perform the following exercises —

Show that

$$(1) \quad \sin A = \sqrt{1 - \cos^2 A}.$$

$$(2) \quad \tan A = \sqrt{\frac{1}{\cos^2 A} - 1}.$$

$$(3) \quad \tan A \text{ cosec } A = \sec A.$$

$$(4) \quad \tan A + \text{cotan } A = \frac{1}{\sin A \cos A}.$$

$$(5) \quad \text{cosec } A - \sin A = \cos A \text{ cotan } A.$$

$$(6) \quad \frac{1 + \cos A}{\sin^2 A} = \frac{1}{1 - \cos A}.$$

$$(7). \quad \frac{1}{\sin. ^2 A} = 1 + \cotan. ^2 A.$$

(8). Express each of the trigonometrical ratios of an angle A in terms of the sine of A.

There are two or three angles, the numerical values of the trigonometrical ratios of which can be easily determined. These angles are 45° , 60° , and 30° .

6. To find the Trigonometrical Ratios of an Angle of 45° .

ABC, a right angled triangle. C the right angle.

If $A = 45^\circ$, then $A = B$, and $AC = BC$.

Now, $AC^2 + BC^2 = AB^2$. (Eucl. I. 47).

$$\therefore 2 AC^2 = AB^2,$$

$$\text{or } 2 BC^2 = AB^2.$$

$$\sin. 45^\circ = \frac{BC}{AB} = \frac{1}{\sqrt{2}}.$$

$$\tan. 45^\circ = \frac{BC}{AC} = 1.$$

$$\sec. 45^\circ = \frac{AB}{AC} = \sqrt{2},$$

and $\cosin. 45^\circ = \sin. (90 - 45) = \sin. 45^\circ$.

$$\therefore \cos. 45^\circ = \frac{1}{\sqrt{2}}$$

Similarly, $\cot. 45^\circ = 1$.

$$\text{cosec. } 45^\circ = \sqrt{2}.$$



7. To find the Trigonometrical Ratios of an Angle of 60° .

ABC, an equilateral triangle. The angle ABC is one of 60° . Draw AD perpendicular to BC. Now $BD = \frac{1}{2} BC = \frac{1}{2} AB$ and $AD^2 = AB^2 - BD^2 = \frac{3}{4} AB^2$.

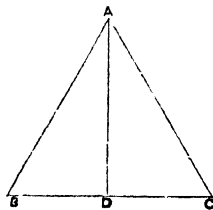

$$\therefore AD = \frac{\sqrt{3}}{2} AB.$$

$$\therefore \sin. 60^\circ = \frac{AD}{AB} = \frac{\sqrt{3}}{2}$$

$$\tan. 60^\circ = \frac{AD}{BD} = \frac{\frac{\sqrt{3}}{2} AB}{\frac{1}{2} AB} = \sqrt{3}.$$

$$\sec. 60^\circ = \frac{AB}{BD} = 2.$$

$$\cos. 60^\circ = \frac{BD}{AB} = \frac{1}{2}.$$

$$\cotan. 60^\circ = \frac{BD}{AD} = \frac{1}{\sqrt{3}}$$

$$\text{cosec. } 60^\circ = \frac{AB}{AD} = \frac{2}{\sqrt{3}}$$

Since $30^\circ = 90^\circ - 60^\circ$

we shall have $\sin. 30^\circ = \cos. 60^\circ = \frac{1}{2}$.

And similarly $\tan. 30^\circ = \frac{1}{\sqrt{3}}$ $\sec. 30^\circ = \frac{2}{\sqrt{3}}$

$\cos. 30^\circ = \frac{\sqrt{3}}{2}$. $\text{Cotan. } 30^\circ = \sqrt{3}$. $\text{Cosec. } 60^\circ = \frac{2}{\sqrt{3}}$.

8. Generalization and Extension of the Principles and Definitions previously laid down.

The definitions above given hold good for angles that are less than ninety degrees; the definition, both of an angle and of the ratios which determine it, admit of and require extension; the nature of which extension and the principle on which it is made we will now proceed to explain.

9. The use of the Negative Sign to denote position.

Let AB be a line, the length of which is a . Let $\overset{A}{\text{-----}} \overset{C}{\text{-----}} \overset{B}{\text{-----}}$ BC be a line, the length of which is b . Then it is plain that AC is $a - b$. This distance, AC, is arrived at by measuring a distance (a) to the right from A, and then measuring another distance (b) to the left from B, the $+a$ and the $-b$ being measured in opposite directions.

It appears then that when a stands for a line measured from a given point in one direction, $-a$ will stand for a line of the same length measured in the opposite direction. In other words, the magnitude of the line is determined by the number of units in a , while the direction is determined by its sign.

It is generally understood that $+a$ signifies a line measured to the right of a given point, as AB, and therefore that $-a$ signifies a line $\overset{B}{\text{-----}} \overset{A}{\text{-----}} \overset{B}{\text{-----}}$ measure to the left of the fixed point, as AB^l.

10. Extension of the Definition of an Angle.

We now proceed to extend the definition of an angle. An angle, as defined by Euclid,—i. e. as the inclination of one line to another,—must be less than two right angles. But if we regard an angle as the space swept out by a right line revolving in one plane, about a fixed point in a given straight line, we clearly remove the limit imposed by Euclid's definition on the magnitude of the angle.

Thus if A be the fixed point in the fixed line AB, AP the moveable line, let the angle BAP, according to Euclid's definition, be A .

Now it is plain that in one revolution AP passes through an angle equal to four right angles, or 360° . Moreover, AP will always come to its present position after one, two, or any number of revolutions; and therefore, according to our extended definition, BAP may be either A or $360^\circ + A$, or $2 \times 360^\circ + A$, or, generally, $360^\circ n + A$, where n is any integer.

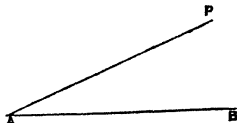

11. *Negative Angles.*

In the same manner as we have shown that $+a$ and $-a$ mean equal lines measured in a contrary direction, so $+A$ and $-A$ will mean angles measured in contrary directions. Thus, AB and AP have the same meaning as before. Let AP' be so placed that $P'AB = PAB$; then if $PAB = A$, $P'AB = -A$.

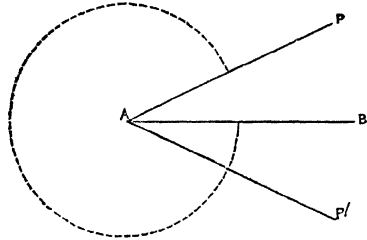

It is plain that if AP' comes into the position AP , it must revolve through an angular space of $-360^\circ + A$, as denoted by the portion of a dotted circle in figure, or through a certain number of total revolutions besides $-360^\circ + A$. Hence BAP may also be represented by $-360^\circ + A - 360^\circ \times 2 + A$, or generally by $-360^\circ \times n + A$, where n is any positive integer.

Hence we conclude that if A be any geometrical angle, its most general trigonometrical form will be.

$$n \times 360^\circ + A,$$

where n is any positive or negative integer whatever.

12. *Extension of Definitions of Trigonometrical Ratios.*

We now proceed to consider the trigonometrical ratios of angles greater than a right angle. We shall, in the first instance, confine our attention to the sines and cosines of angles, less than four right angles.

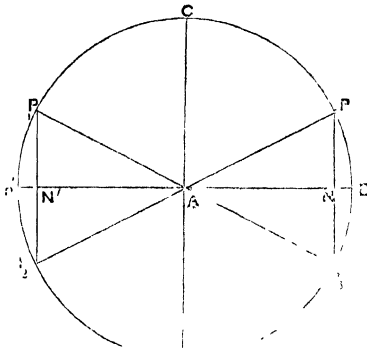

We have already explained that

$$\text{Sin. } BAP = \frac{PN}{AP}$$

$$\text{Cos. } BAP = \frac{AN}{AP}$$

Now as AN is measured along AB to the right, AN is positive. And if we reckon lines measured upward, from A towards C positive, it is plain that PN , being measured parallel to that direction, is positive.

The signs of the sine and cosine of an angle less than ninety degrees are then, by this way of reckoning the signs of the measurements, positive, as they should be.

Now if we consider an angle BAP_1 , it is clear that P_1N' stands in the same relation to BAP_1 that PN does to BAP .

Hence we define

$$\text{Sin. } BAP_1 = \frac{P_1N'}{AP_1}$$

$$\text{Cos. } BAP_1 = \frac{AN'}{AP_1}$$

It is plain that $P_1 N'$ is positive, and $A N'$ is negative. Hence

The sine of an angle $\sphericalangle 90^\circ \sphericalangle 180^\circ$ is positive, and the cosine of an angle $\sphericalangle 90^\circ \sphericalangle 180^\circ$ is negative.

In like manner, if $B A P_2$ be the angle subtended by the circumference $B P_1 P_2$,

$$\text{Sin. } B A P_2 = \frac{P_2 N'}{A P_2}$$

$$[\text{Cos. } B A P_2 = \frac{A N'}{A P_2}]$$

Now $P_2 N'$ is negative, and $A N'$ is negative. Hence the sine of an angle $\sphericalangle 180^\circ \sphericalangle 270^\circ$ is negative, and the cosine of an angle $\sphericalangle 180^\circ \sphericalangle 270^\circ$ is positive. In like manner if $P_3 A B$ signify the angle subtended by the circumference $B P_1 P_2 P_3$,

i. e. $\sphericalangle 270^\circ$ but $\sphericalangle 360^\circ$.

$$\text{Sin. } B A P_3 = \frac{P_3 N}{A P_3}$$

$$\text{Cos. } B A P_3 = \frac{A N}{A P_3}$$

And $P_3 N$ is negative, and $A N$ is positive. Hence, sine of an angle $\sphericalangle 270^\circ \sphericalangle 360^\circ$ is negative: and the cosine of an angle $\sphericalangle 270^\circ \sphericalangle 360^\circ$ is positive. These four angles which we have considered are said to be in the first, second, third, and fourth quadrants respectively.

By means of the above, if we have given the signs both of sine and cosine of an angle, we can tell in what quadrant it must lie.

Thus if $\text{sine } \theta = +m$ and $\text{cos. } \theta = -n$, θ must lie in the second quadrant; *i. e.* must be greater than 90° and less than 180° .

(13.) To express the Trigonometrical Ratios of any angle in terms of those of an angle less than 90° .

Again, the trigonometrical ratios of any angle can be expressed by means of the ratios of an angle less than 90° .

For if, in the same figure, $B A P$, $B' A P_1$, $B' A P_2$, $B A P_3$, are equal to one another, and therefore the lines $P N$, $P_1 N'$, $P_2 N'$, $P_3 N$, are equal in magnitude; as also are $A N$ and $A N'$.

If then we take account both of sign and magnitude,

$$\text{Sin. } B A P_1 = \frac{P_1 N'}{A P_1} = \frac{P N}{A P} = \text{sin. } B A P.$$

$$\therefore \text{sin. } (180^\circ - A) = \text{sin. } A.$$

$$\text{Sin. } B A P_2 = \frac{P_2 N'}{A P_2} = \frac{-P N}{A P} = -\text{sin. } B A P.$$

$$\therefore \text{sin. } (180^\circ + A) = -\text{sin. } A.$$

$$\text{Sin. } B A P_3 = \frac{P_3 N}{A P_3} = \frac{-P N}{A P} = -\text{sin. } B A P.$$

$$\text{Sin. } (360^\circ - A) = -\text{sin. } A.$$

In the same manner it is easy to show that

$$\text{Cos. } (180^\circ - A) = -\text{cos. } A.$$

$$\text{Cos. } (180^\circ + A) = -\text{cos. } A.$$

$$\text{Cos. } (360^\circ - A) = \text{cos. } A.$$

For example, we have seen that $\cos. 60^\circ = \frac{1}{2}$.

$$\cos. 120^\circ = \cos. (180^\circ - 60^\circ) = - \cos. 60^\circ = - \frac{1}{2}.$$

Similarly—

$$\sin. 315^\circ = \sin. (360^\circ - 45^\circ) = - \sin. 45^\circ = - \frac{1}{2}.$$

If consider the case of the tangent of an angle, $\angle A$ being an angle, $\angle 90^\circ$.

$$\tan. (180^\circ - A) = \frac{\sin. (180^\circ - A)}{\cos. (180^\circ - A)} = \frac{+ \sin. A}{- \cos. A} = - \tan. A.$$

$$\tan. (180^\circ + A) = \frac{\sin. (180^\circ + A)}{\cos. (180^\circ + A)} = \frac{- \sin. A}{- \cos. A} = \tan. A.$$

$$\tan. (360^\circ - A) = \frac{\sin. (360^\circ - A)}{\cos. (360^\circ - A)} = \frac{- \sin. A}{\cos. A} = - \tan. A.$$

In the same manner we may express the other trigonometrical ratios of angles greater than 90° by means of those angles less than 90° .

It is to be observed that if we suppose ΔP to make one complete revolution from ΔP , it returns to its present position. So that ΔN and ΔP are the same both in magnitude and direction for the angle $360^\circ + A$ as for A .

The same is true of any number of complete revolutions.

Hence, if f denote any trigonometrical ratio whatever,

$$f (n 360^\circ + A) = f (A),$$

where n is any positive integer whatever. Thus,

$$\sin. (n 360^\circ + A) = \sin. (A)$$

$$\cos. (n 360^\circ + A) = \cos. (A)$$

And so on.

There are a great variety of relation similar to those above deduced. The following are worth notice:—

We have before stated that if $\angle BAP = A$, then $\angle PAB = -A$.

$$\therefore \sin. (-A) = \sin. \angle BAP = \frac{PN}{AP}$$

$$= - \frac{PN}{AP} = - \sin. A.$$

$$\therefore \sin. (-A) = - \sin. A.$$

Similarly,

$$\cos. (-A) = \cos. A,$$

$$\text{and } \therefore \tan. (-A) = \tan. A,$$

$$\text{and } \cot. (-A) = - \cot. A.$$

This result can be arrived at by reference to formulas previously proved.

We have seen that under all circumstances

$$f(n.360^\circ + A) = f(A).$$

$$\therefore \sin. (360^\circ - A) = \sin. (-A).$$

But we have also seen that

$$\sin. (360^\circ - A) = - \sin. A;$$

$$\therefore \sin. (-A) = - \sin. A.$$

14. On the Magnitudes of the Trigonometrical Functions of Angles, 0° , 90° , 180° , 270° .

The definition of sine $\angle BAP$ tells us that

$$\sin. A = \frac{PN}{AP}.$$

Now if ΔP coincide with AB , $A = 0$ and $PN = 0$, $\therefore \sin. 0^\circ = 0$.

If ΔP revolve round A , PN increases until ΔP coincides with AC , when $A = 90^\circ$, and $PN = AP$.

$$\therefore \sin. 90^\circ = 1.$$

After which, as ΔP revolves towards AB' , PN decreases until at AB coincides with AB' , when $PN = 0$, $A = 180^\circ$, and therefore

$$\sin. 180^\circ = 0.$$

As ΔP revolves from AB' towards AC , PN increases negatively until ΔP coincides with AC , when $A = 270^\circ$ and $PN = -AP$.

$$\therefore \sin. 270^\circ = -1.$$

As ΔP revolves from AC' towards its original position AB , PN decreases negatively, until when ΔP coincides with AB , we have $A = 360^\circ$, and PN vanishes.

$$\therefore \sin. 360^\circ = 0.$$

In like manner, if we take the cosine we have

$$\cos. A = \frac{AN}{AP}$$

$$\text{Now when } A = 0 \quad AN = AP \quad \therefore \cos. 0^\circ = 1.$$

$$A = 90^\circ \quad AN = 0 \quad \therefore \cos. 90^\circ = 0.$$

$$A = 180^\circ \quad AN = -AP \quad \cos. 180^\circ = -1.$$

$$A = 270^\circ \quad AN = 0 \quad \cos. 270^\circ = 0.$$

$$A = 360^\circ \quad AN = AP \quad \cos. 360^\circ = 1.$$

$$\text{Now } \tan. A = \frac{\sin. A}{\cos. A}$$

$$\therefore \tan. 0^\circ = \frac{\sin. 0^\circ}{\cos. 0^\circ} = \frac{0}{1} = 0$$

$$\tan. 90^\circ = \frac{\sin. 90^\circ}{\cos. 90^\circ} = \frac{1}{0} = \infty$$

$$\tan. 180^\circ = \frac{\sin. 180^\circ}{\cos. 180^\circ} = \frac{0}{-1} = 0$$

$$\tan. 270^\circ = \frac{\sin. 270^\circ}{\cos. 270^\circ} = \frac{-1}{0} = \infty$$

$$\tan. 360^\circ = \frac{\sin. 360^\circ}{\cos. 360^\circ} = \frac{0}{1} = 0$$

If we apply similar reasoning to the various trigonometric functions to that employed in discussing the variations of the sine of A , we obtain results which may be arranged in a tabular form, as follows:—

Angle.	0°	$\angle 90^\circ$ $\nearrow 0$	90°	$\angle 180^\circ$ $\nearrow 90^\circ$	180°	$\angle 270^\circ$ $\nearrow 180^\circ$	270°	$\angle 360^\circ$ $\nearrow 278^\circ$	360°
Sine	0	+	1	+	0	-	-1	-	0
Cosine	1	+	0	-	-1	-	0	+	1
Tangent	0	+	∞	-	0	+	∞	-	0
Cotangent	∞	+	0	-	∞	+	0	-	∞
Secant	1	+	∞	-	-1	+	∞	+	1
Cosecant	∞	+	1	+	∞	-	-1	-	∞

The student will do well to verify carefully all the results given in this table; he will also observe that the trigonometrical ratios illustrate the principle that if a function of a variable changes its sign, it must pass through the values of either zero (0) or infinity (∞).

As the values of the ratios are continuous, the ratios increase gradually to their greatest value, and then decrease to their least. Thus, to take the case of the sine of an angle, which we call θ .

Sine θ increases from 0, when $\theta = 0^\circ$ up to 1, when $\theta = 90^\circ$. It then decreases to 0, when $\theta = 180^\circ$; after which it still further decreases till it equals -1, when $\theta = 270^\circ$, and finally increases up to 0, when $\theta = 360^\circ$.

15. To determine all the angles which have the same sine, or cosine, &c.

There is another class of questions presented to us by this extension of our definition of an angle, *viz.*, having given a trigonometrical ratio of an angle, to find all the angles corresponding to it.

For example, $\tan. \theta = p$.

Now, if we did not reckon any angles but those less than 180° , as is the case in geometry, we could only have one value of θ corresponding to a given value of $\tan. \theta$. Suppose this value = a .

Then, if we take the trigonometrical or generalized conception of an angle, we shall have another = $180^\circ + a$.

And since no trigonometrical ratio changes either its value or its sign when its angle is increased by any multiple of 360° , it is plain that in addition to a we shall have a series of values, $360^\circ + a, 2 \times 360^\circ + a, 3 \times 360^\circ + a + \dots, n 360^\circ + a$; and in addition to the value $180^\circ + a$, we shall have a series of values, $360^\circ + 180^\circ + a, 2 \times 360^\circ + 180^\circ + a, 3 \times 360^\circ + 180^\circ + a, \dots, n 360^\circ + 180^\circ + a$. Both these series may be included in one formula,

$$\theta = m 180^\circ + a,$$

where m is any integer number whatever.

In the same manner, if

$$\text{Cos. } \theta = q,$$

and a is the value of θ less than 180° , which has for its cosine q , then all the values of θ which have a cosine q are included in the formula,

$$\theta = m, 360^\circ \pm a,$$

where m is any integer.

And similarly if

$$\text{Sin. } \theta = g,$$

the value of θ is included in the formula:—

$$\theta = 2m 180^\circ + a,$$

$$\text{and } \theta = (2m + 1) 180^\circ - a,$$

m being any integer whatever.

These may be included in one formula, as follows:—

$$\theta = k. 180^\circ + (-1)^k a,$$

where k is any integer whatever; for when k is even, $(-1)^k$ is positive; and when k is uneven, $(-1)^k$ is negative.

As practice in the preceding articles, the student may verify the following results:—

$$1. \sin. 810^\circ = 0.$$

$$2. \sin. 135^\circ = \frac{1}{\sqrt{2}}.$$

$$3. \cos. 135^\circ = \frac{1}{\sqrt{2}} = \cos. 225^\circ.$$

$$4. \cos. 315^\circ = \frac{1}{\sqrt{2}} = \sin. 405^\circ.$$

$$5. \sin. 120^\circ = \frac{1}{2} = -\sin. 300^\circ.$$

$$6. \cos. 330^\circ = \frac{\sqrt{3}}{2} = -\cos. 150^\circ.$$

$$7. \sin. 150^\circ = \frac{\sqrt{3}}{2}.$$

$$8. \cos. 300^\circ = \frac{1}{2}.$$

Given that $\sin \theta = \frac{1}{2}$, show that the following are the values of θ which satisfy that equation, 30° , 150° , 390° , 510° , 750° , 870° , &c.

Given that $\cos. \theta = \frac{1}{\sqrt{2}}$, show that the following are the values of θ which satisfy this equation, 45° , 315° , 105° , 675° , 765° , &c.

Given that $\tan. \theta = 1$, show that the values of θ are 45° , 225° , 405° , 585° , 765° , &c.

THE RELATIONS BETWEEN THE TRIGONOMETRICAL FUNCTIONS OF DIFFERENT ANGLES.

The formulas we have already proved hold good of the ratios of the same angle; we now proceed to investigate the formulas which express the relations between two or more different angles. There is a very great variety of formulas of this kind, and they admit of an almost infinite number of combinations and modifications. They are, however, all derived mediately or immediately from the following four—

$$\sin. (A + B) = \sin. A, \cos. B + \sin. B, \cos. A. \dots (8).$$

$$\sin. (A - B) = \sin. A, \cos. B - \sin. B, \cos. A. \dots (9).$$

$$\cos. (A + B) = \cos. A, \cos. B - \sin. A, \sin. B. \dots (10).$$

$$\cos. (A - B) = \cos. A, \cos. B + \sin. A, \sin. B. \dots (11).$$

These four formulas can be easily remembered—and it is of great importance that they should be remembered—by observing that the sine of the sum of two angles is the sum of the product of the sine of the first angle and the cosine of the second, and of the product of the sine of the second angle and the cosine of the first; while the sine of the difference of the angles is the former product minus the latter. The cosine of the sum of two angles is the product of the cosines of those angles minus the product of their sines; and the cosine of the difference of two angles is the sum of the product of the cosines and of the product of the sines.

(16). To prove the Formula

$$\sin. (A + B) = \sin. A \cos. B + \sin. B \cos. A.$$

Let $\angle AOB$ be the angle A , $\angle BOC$ the angle B ; $\therefore \angle AOC$ is the angle $A + B$. In OC take any point P , and from P let fall PN , PM , perpendiculars on OA and OB , and from M let fall MQ and MR , perpendiculars on PN and OR .

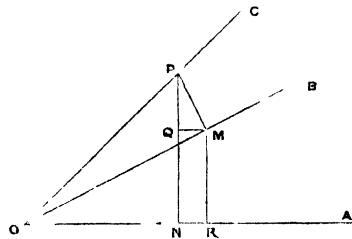

Then—

$$\begin{aligned} \sin. (A + B) &= \frac{PN}{OP} = \frac{QN + PQ}{OP} \\ &= \frac{QN}{OP} + \frac{PQ}{OP} = \frac{MR}{OP} + \frac{PQ}{OP} \\ &= \frac{MR}{OM} \frac{OM}{OP} + \frac{PQ}{PM} \frac{PM}{OP} \end{aligned}$$

Now $\frac{MR}{ON} = \sin. A$ $\frac{OM}{OP} = \cos B$

And since $\angle PMO$ is a right angle, $\angle QPM = \angle QMO = \angle MOR$,

$$\therefore \frac{PQ}{PM} = \frac{OR}{OM} = \cos. A \quad \frac{PM}{OP} = \sin. B;$$

$$\therefore \sin. (A + B) = \sin. A \cos. B + \sin. B \cos. A.$$

(17). To prove the Formula

$$\cos. (A + B) = \cos. A \cos. B - \sin. A \sin. B.$$

For as before,

$$\begin{aligned} \cos (A + B) &= \frac{ON}{OP} = \frac{OR - QM}{OP} = \frac{OR}{OP} - \frac{QM}{OP} \\ &= \frac{OR}{OM} \frac{OM}{OP} - \frac{QM}{PM} \frac{PM}{OP} \end{aligned}$$

Now $\frac{OR}{OM} = \cos. A$ $\frac{OM}{OP} = \cos. B$,

And $\frac{QM}{PM} = \frac{MR}{OM} = \sin. A$ $\frac{PM}{OP} = \sin. B$;

$$\therefore \cos. (A + B) = \cos. A \cos. B - \sin. A \sin. B.$$

18. To prove the Formula

$$\sin. (A - B) = \sin. A \cos. B - \sin. B \cos. A.$$

Let $\angle AOB = A$, $\angle BOC = B$. Take in OC any point P from P ; draw PM and PN perpendicular to OB and OA . Draw MR and MQ perpendicular to OA and PN produced. Then $\angle AOC = A - B$.

$$\begin{aligned} \therefore \sin. (A - B) &= \frac{PN}{OP} = \frac{QN - QP}{OP} \\ &= \frac{MR}{OP} - \frac{QP}{OP} = \frac{MR}{OM} \frac{OM}{OP} - \frac{QP}{PM} \frac{PM}{OP} \end{aligned}$$

Now $\frac{MR}{OM} = \sin. A$ $\frac{OM}{OP} = \cos. B$.

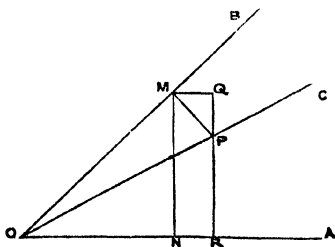

Again $\angle MPQ = QMB = BOA = A$.

$$\therefore \frac{PQ}{MP} = \frac{QR}{OM} = \cos. A \quad \frac{PM}{OP} = \sin. B.$$

$$\therefore \sin. (A - B) = \sin. A \cos. B - \sin. B \cos. A.$$

19. To prove the Formula

$$\cos. (A - B) = \cos. A \cos. B + \sin. A \sin. B.$$

$$\cos. (A - B) = \frac{ON}{OP} = \frac{OR}{OP} + \frac{MQ}{OP} = \frac{OR}{OM} \frac{OM}{OP} + \frac{MQ}{MP} \frac{MP}{OP}$$

$$\text{But } \frac{OR}{OM} = \cos. A \quad \frac{OM}{OP} = \cos. B. \quad \frac{MQ}{MP} = \sin. A \quad \text{and} \quad \frac{MP}{OP} = \sin. B.$$

$$\therefore \cos. (A - B) = \cos. A \cos. B + \sin. A \sin. B.$$

20. To extend the above proofs in special cases.

The proofs above given are clearly limited to the cases in which A , B , and $A + B$ or $A - B$, are each less than 90° . They admit of extension to any case whatever. Thus—

If A is $> 180^\circ$ $< 270^\circ$, $B > 90^\circ$ $< 180^\circ$, and $A - B > 90^\circ$ $< 180^\circ$.

To show that

$$\sin. (A - B) = \sin. A \cos. B - \sin. B \cos. A.$$

In this case the figure will be the following :

$\angle AOB$ is the angle A , measured as indicated by the dotted circle. $\angle BOC$ is the angle B . $\therefore \angle COA$ is the angle $A - B$.

From any point P in OC draw PN , PM perpendicular to OA and OB produced, and from M draw MQ , MR perpendicular PN and OA . Then

$$\sin. (A - B) = \frac{PN}{PO} = \frac{PQ}{PO} + \frac{QN}{PO} = \frac{PQ}{PO}$$

$$+ \frac{MR}{PO} = \frac{PQ}{PM} \frac{PM}{PO} + \frac{MR}{MO} \frac{POM}{PO}$$

$$\text{Now } \frac{PQ}{PM} \cos. MPQ = \cos. AOM = \cos. (A - 180^\circ) = \cos. (180^\circ - A) = -\cos. A.$$

$$\frac{PM}{PO} = \sin. POM = \sin. (180^\circ - B) = \sin. B.$$

$$\text{Similarly } \frac{MR}{MO} = \sin. MOA = -\sin. A$$

$$\frac{OM}{PM} = \cos. POM = -\cos. B;$$

$$\therefore \sin. (A - B) = \sin. A \cos. B - \sin. B \cos. A.$$

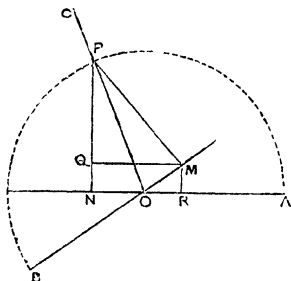

In the same case,

$$\begin{aligned} \cos. (A - B) &= -\frac{ON}{OP} = -\frac{ONR - OR}{OP} \\ &= -\frac{QM}{OP} + \frac{OR}{OP} = -\frac{MQ}{MP} \cdot \frac{MP}{OP} + \frac{OR}{OM} \cdot \frac{OM}{OP} \\ \text{Now } \frac{MQ}{MP} &= \sin. MPQ = \sin. MOA = -\sin. A. \\ \frac{MP}{OP} &= \sin. POM = \sin. POB = \sin. B. \\ \frac{OR}{OM} &= \cos. MOA = -\cos. A. \\ \frac{OM}{OP} &= \cos. POM = -\cos. B. \end{aligned}$$

$$\therefore \cos. (A - B) = \cos. A \cos. B + \sin. A \sin. B.$$

Again, to show that $\sin. (A + B) = \sin. A \cos. B + \sin. B \cos. A.$

When $A + B > 270^\circ < 360^\circ$ $A > 90^\circ < 180^\circ$ $B > 180^\circ < 270^\circ.$

Let AOB be the angle A ; BOC be the angle B . Then AOC is the angle $A + B$, BOC , and therefore AOC , being measured as indicated by the dotted circles. In C take any point P and draw PN, PM perpendiculars to OA and OB produced, and from M draw MR and MQ perpendiculars to OA and NP produced.

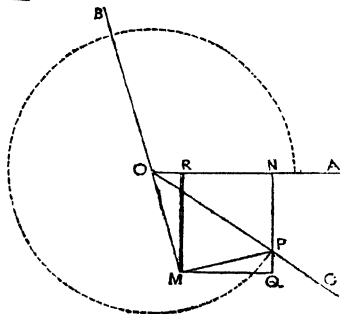

Then

$$\begin{aligned} \text{Sine } (A + B) &= -\frac{PN}{OP} = \frac{PQ - QN}{OP} \\ &= \frac{PQ}{OP} - \frac{QN}{OP} = \frac{PQ}{MP} \cdot \frac{MP}{OP} - \frac{RM}{OM} \cdot \frac{OM}{OP}. \end{aligned}$$

$$\text{Now } \frac{PQ}{OM} = \cos. MPQ = \cos. POA = -\cos. A.$$

$$\frac{MP}{OP} = \sin. POM = -\sin. B.$$

$$\frac{RM}{OM} = \sin. AOM = \sin. A.$$

$$\frac{OM}{OP} = \cos. POM = -\cos. B.$$

$$\therefore \sin. (A + B) = \sin. A \cos. B + \sin. B \cos. A.$$

The student may verify for practice the formulas in the following cases.—

Sin. $(A + B)$	$A > 90^\circ < 180^\circ$	$A + B > 180^\circ$	$B > 90^\circ$
Cos. $(A - B)$	$A > 90^\circ < 180^\circ$	$A + B < 90^\circ$	$B > 90^\circ$
Cos. $(A + B)$	$A > 180^\circ < 270^\circ$	$A + B > 360^\circ < 450^\circ$	$B > 90^\circ < 180^\circ.$

21. The principle on which the proof may be considered as established generally.

The above examples will be sufficient to satisfy the reader that the four formulas

above given hold good for all angles whatever. It is worth while to observe, however, that, independently of these examples, this follows from the circumstance that the extension given above to the definitions of angular magnitude, and of the trigonometric ratios, are made in strict accordance with the extension given to the meaning of the negative sign in algebra. Thus, $a - b$ primarily signifies that the number b is to be subtracted from the number a ; if therefore b be greater than a , $a - b$ is impossible, unless we generalise the definition of the negative sign. If we do this so as to render $a - b$ susceptible of meaning for all values of a and b , then whatever theorem we prove to be true of $a - b$, and its combinations with the restriction, will be equally true of $a - b$, and its combinations without the restriction.

In like manner, if we prove a trigonometrical formula to hold good for all geometrical angles, these will equally hold good of the angles when defined according to the trigonometrical conception of an angle explained above. The principle which we have to guide us in all these generalizations is called "The Principle of the Permanence of Equivalent Forms," and is that which lies at the root of all extensions of merely Arithmetical Algebra, as explained in the treatise on Logarithms and Series. The reader who wishes to see a full account of the application of this Principle to Trigonometry, will do well to consult Dr. Peacock's Algebra, vol. ii., p. 144, &c. 2nd edition.

22. Relation between the Four Fundamental Formulas.

It is to be observed that the last three of the four formulas given above can be derived from the first of them.

$$\text{Thus, } \sin. (A + B) = \sin. A \cos. B + \sin. B \cos. A.$$

$$\text{For } B \text{ write } -B. \text{ Now } \sin. (-B) = -\sin. B.$$

$$\text{And } \cos. (-B) = \cos. B.$$

$$\therefore \sin. (A - B) = \sin. A \cos. B - \sin. B \cos. A.$$

$$\text{Again } \cos. (A + B) = \sin. (90^\circ - A - B)$$

$$= \sin. (90^\circ - A) \cos. B - \sin. B \cos. (90^\circ - A)$$

$$= \cos. A \cos. B - \sin. A \sin. B.$$

Again

$$(\cos. (A - B) = \sin. (90^\circ - A + B)$$

$$= \sin. (90^\circ - A) \cos. B + \cos. (90^\circ - A)$$

$$= \cos. A \cos. B + \sin. A \sin. B.$$

23. Formulas derived from the Fundamental ones.

From these four the following formulas of frequent occurrence can easily be derived:—

$$\sin. A \cos. B + \sin. B \cos. A = \sin. (A + B)$$

$$\sin. A \cos. B - \sin. B \cos. A = \sin. (A - B).$$

\therefore adding $2 \sin. A \cos. B = \sin. (A + B) + \sin. (A - B)$;
and subtracting $2 \cos. A \sin. B = \sin. (A + B) - \sin. (A - B)$.

Similarly,

$$2 \sin. A \sin. B = \cos. (A - B) - \cos. (A + B) \dots (12)$$

$$2 \cos. A \cos. B = \cos. (A - B) + \cos. (A + B) \dots (13)$$

The same formulas are of frequent occurrence in a different form. Evidently

$$\theta = \frac{\theta + \phi}{2} + \frac{\theta - \phi}{2}$$

$$\phi = \frac{\theta + \phi}{2} - \frac{\theta - \phi}{2}$$

$$\therefore \sin. \theta = \sin. \frac{\theta + \phi}{2} \cos. \frac{\theta - \phi}{2} + \sin. \frac{\theta - \phi}{2} \cos. \frac{\theta + \phi}{2}$$

$$\sin. \phi = \sin. \frac{\theta + \phi}{2} \cos. \frac{\theta - \phi}{2} - \sin. \frac{\theta - \phi}{2} \cos. \frac{\theta + \phi}{2}$$

$$\therefore \sin. \theta + \sin. \phi = 2 \sin. \frac{\theta + \phi}{2} \cos. \frac{\theta - \phi}{2} \dots (14.)$$

$$\sin. \theta - \sin. \phi = 2 \cos. \frac{\theta + \phi}{2} \sin. \frac{\theta - \phi}{2} \dots (15.)$$

Similarly,

$$\cos. \theta + \cos. \phi = 2 \cos. \frac{\theta + \phi}{2} \cos. \frac{\theta - \phi}{2} \dots (16.)$$

$$\cos. \phi - \cos. \theta = 2 \sin. \frac{\theta + \phi}{2} \sin. \frac{\theta - \phi}{2} \dots (17.)$$

24. *Formula for the Tangent of the sum of two Angles.*

Again, we can easily derive from the formulas for the sines and cosines of $A + B$ and $A - B$, expressions for the tangents of $A + B$ and $A - B$. Thus,

$$\tan. (A + B) = \frac{\sin. (A + B)}{\cos. (A + B)} = \frac{\sin. A \cos. B + \sin. B \cos. A}{\cos. A \cos. B - \sin. A \sin. B}$$

Divide both numerator of this fraction by $\cos. A \cos. B$.

$$\begin{aligned} \therefore \tan. (A + B) &= \frac{\frac{\sin. A \cos. B}{\cos. A \cos. B} + \frac{\sin. B \cos. A}{\cos. B \cos. A}}{\frac{\cos. A \cos. B - \sin. A \sin. B}{\cos. A \cos. B}} \\ &= \frac{\frac{\sin. A}{\cos. A} + \frac{\sin. B}{\cos. B}}{1 - \frac{\sin. A \sin. B}{\cos. A \cos. B}} = \frac{\tan. A + \tan. B}{1 - \tan. A \tan. B} \dots (18.) \end{aligned}$$

Similarly,

$$\tan. (A - B) = \frac{\tan. A - \tan. B}{1 - \tan. A \tan. B} \dots (19.)$$

25. *Expressions in which the sum of three angles occur.*

We can easily derive from the above expressions for the sines, cosines . . . of the sum of three or more angles. Thus,

$$\begin{aligned} \sin. (A + B + C) &= \sin. (A + B) \cos. C + \cos. (A + B) \sin. C = (\sin. A \cos. B + \sin. B \cos. A) \cos. C + (\cos. A \cos. B - \sin. A \sin. B) \sin. C = \sin. A \cos. B \cos. C + \sin. B \cos. A \cos. C + \sin. C \cos. A \cos. B - \sin. A \sin. B \sin. C. \end{aligned}$$

In the same manner,

$$\begin{aligned} \cos. (A + B + C) &= \cos. A \cos. B \cos. C - \cos. A \sin. B \sin. C - \cos. B \sin. C \sin. A - \cos. C \sin. A \sin. B. \end{aligned}$$

And hence,

$$\tan. (A + B + C) = \frac{\tan. A + \tan. B + \tan. C - \tan. A \tan. B \tan. C}{1 - \tan. B \tan. C - \tan. C \tan. A - \tan. A \tan. B}.$$

26. Certain other Formulas.

Again, since—

$$\begin{aligned} \sin. \theta + \sin. \phi &= 2 \sin. \frac{\theta + \phi}{2} \cos. \frac{\theta - \phi}{2} \\ \sin. \theta - \sin. \phi &= 2 \cos. \frac{\theta + \phi}{2} \sin. \frac{\theta - \phi}{2} \\ \therefore \frac{\sin. \theta + \sin. \phi}{\sin. \theta - \sin. \phi} &= \frac{\sin. \frac{\theta + \phi}{2} \cos. \frac{\theta - \phi}{2}}{\cos. \frac{\theta + \phi}{2} \sin. \frac{\theta - \phi}{2}} \\ &= \tan. \frac{\theta + \phi}{2} \cotan. \frac{\theta - \phi}{2} \dots (20). \end{aligned}$$

In like manner,

$$\frac{\cos. \phi - \cos. \theta}{\cos. \phi + \cos. \theta} = \tan. \frac{\theta + \phi}{2} \tan. \frac{\theta - \phi}{2} \dots (21).$$

There are many similar combinations of the trigonometric ratios besides those above given. These are of very frequent occurrence, and the student who has thoroughly mastered the above will be at no loss in investigating other combinations that may occur in his subsequent reading.

27. The Sines, Cosines . . . of Multiples of given Angles.

We have already seen that

$$\sin. (A + B) = \sin. A \cos. B + \sin. B \cos. A.$$

This being true of all values of A and B is true when A = B, and \therefore when $A + B = 2A$.

$$\therefore \sin. 2A = 2 \sin. A \cos. A \dots (22).$$

Similarly, since

$$\cos. (A + B) = \cos. A \cos. B - \sin. A \sin. B.$$

$$\therefore \cos. 2A = \cos^2 A - \sin^2 A \dots (23).$$

$$\text{Now, } 1 = \cos^2 A + \sin^2 A.$$

Add this equation to (23), and we obtain

$$\cos. 2A = 2 \cos^2 A - 1.$$

$$\text{And } \cos. 2A = 1 - 2 \sin^2 A.$$

Similarly,

$$\tan. 2A = \frac{2 \tan. A}{1 - \tan^2 A} \dots (24).$$

Again,

$$\sin. 3A = \sin. (2A + A).$$

$$= \sin. 2A \cos. A + \cos. 2A \sin. A.$$

$$= 2 \sin. A \cos. A \cos. A + (\cos^2 A - \sin^2 A) \sin. A.$$

$$= 3 \sin. A \cos^2 A - \sin^3 A.$$

$$= 3 \sin. A - 4 \sin^3 A \dots (25).$$

Similarly,

$$\cos. 3A = 3 \cos. A - 4 \cos^3 A \dots (26),$$

and

$$\text{Tan. } 3A = \frac{3 \tan. A - \tan^3 A}{1 - 3 \tan^2 A} \dots \dots (27).$$

28. *Determination of Sine, &c., of an Angle in terms of the Sine, &c., of the Sub-multiples of that Angle.*

From these expressions we may derive others expressing the sines, &c., of an angle in terms of the sines, &c. of the submultiples of that angle. Thus, writing $\frac{\theta}{2}$ for A, we have

$$\text{From (22) Sin. } \theta = 2 \sin. \frac{\theta}{2} \cos. \frac{\theta}{2}.$$

$$\begin{aligned} \text{From (23) Cos. } \theta &= \cos^2 \frac{\theta}{2} - \sin^2 \frac{\theta}{2} \\ &= 1 - 2 \sin^2 \frac{\theta}{2} \\ &= 2 \cos^2 \frac{\theta}{2} - 1. \end{aligned}$$

$$\text{From (24) Tan. } \theta = \frac{2 \tan. \frac{\theta}{2}}{1 - \tan^2 \frac{\theta}{2}}.$$

And writing ϕ for $\frac{A}{3}$ we have

$$\text{From (25) Sin. } \phi = 3 \sin. \frac{\phi}{3} - 4 \sin^3 \frac{\phi}{3}.$$

$$\text{From (26) Cos. } \phi = -3 \cos. \frac{\phi}{3} + 4 \cos^3 \frac{\phi}{3}.$$

$$\text{From (27) Tan. } \phi = \frac{3 \tan. \frac{\phi}{3} - \tan^3 \frac{\phi}{3}}{1 - 3 \tan^2 \frac{\phi}{3}}.$$

29. *On the "Ambiguities" resulting from the use of the above Formulas.*

These formulas enable us to solve the following question:—Having given the sine . . . of an angle, we can find from it the sine . . . of double that angle; and conversely having given the sine . . . of an angle, we can find the sine . . . of half that angle.

(a.) Thus, having given sin. A = p, to find cos. 2A, we have

$$\text{Cos. } 2A = 1 - 2 \sin^2 A = 1 - 2p^2.$$

and so, having given sin. A = p to find sin. 2A.

$$\text{Since sin. } A = p \text{ cos. } A = \sqrt{1 - p^2} \therefore \text{sin. } 2A = \pm 2p \sqrt{1 - p^2}.$$

It will be seen, from the above formulas, that for one given value (p) of sin. A, there is one value of cos. 2A, while there are two of sine 2A equal in magnitude, but of different signs. This is sometimes spoken of as an ambiguity. It will be observed, however, that the ambiguity in the determination of sin. 2A arises necessarily from the data, since it appears by considering the values of A which satisfy the equation

$$\text{Sin. } A = p,$$

that there will be one value of cos. 2A and two values of sin. 2A resulting from the

data. Thus, if A^1 be one angle which satisfies the equation, then all the values of A are included in the two formulas

$$A = 2m180^\circ + A^1$$

$$\text{and } A = (2m + 1)180^\circ + A^1$$

m being any integer whatever;

$$\therefore \cos. 2A = \cos. (2m 360^\circ + 2A^1) = \cos. 2A^1,$$

$$\text{or } = \cos. (2m + 1)360^\circ - 2A^1) = \cos. 2A^1$$

Under all circumstances, therefore,

$$\cos. 2A = \cos. 2A^1,$$

and therefore has but one value. Whereas

$$\sin. 2A = \sin. (2m 360^\circ + 2A^1) = \sin. 2A^1.$$

$$\text{or } = \sin. (2m + 1)360^\circ - 2A^1) = -\sin. 2A^1.$$

$$\therefore \sin. 2A \text{ has the two values } + \sin. 2A^1 \text{ and } - \sin. 2A^1.$$

If, however, we know A , or even the limits between which A lies, as well as that $\sin. A = p$, then all indeterminateness vanishes from the expression for $\sin. 2A$. Thus, if A is less than 90° , then $2A$ is $\angle 180^\circ$ and $\sin^\circ 2A$ must be positive. And, again, if $A > 90^\circ \angle 180^\circ$, then $2A > 180^\circ \angle 360^\circ$, and the $\sin. 2A$ is negative in the former case; therefore,

$$\sin. 2A = 2p \sqrt{1-p^2}.$$

In the latter,

$$\sin. 2A = -2p \sqrt{-1-p^2}.$$

(b.) Again, we have

$$\cos. \theta = 1 - 2 \sin. \frac{\theta}{2} = 2 \cos. \frac{\theta}{2} - 1.$$

$$\therefore \sin. \frac{\theta}{2} = \sqrt{\frac{1 - \cos. \theta}{2}}$$

$$\cos. \frac{\theta}{2} = \sqrt{\frac{1 + \cos. \theta}{2}}$$

Hence it appears that for a given value of $\cos. \theta$ there are two values of $\sin. \frac{\theta}{2}$, and likewise two values of $\cos. \frac{\theta}{2}$ equal in magnitude, but with different signs. This is, as before, necessarily the case, if we only know the value of $\cos. \theta$. For if we have a given value p of $\cos. \theta$, so that

$$\cos. \theta = p,$$

and if θ^1 is a value of θ which satisfies this equation, then all the values of θ , which satisfy this equation, are expressed by,

$$\theta = m 360^\circ \pm \theta^1.$$

$$\therefore \sin. \frac{\theta}{2} = \sin. (m 180^\circ \pm \frac{\theta^1}{2})$$

$$\text{which } = \pm \sin. \frac{\theta^1}{2} \text{ if } m \text{ be even,}$$

$$\text{or, } \mp \sin. \frac{\theta^1}{2} \text{ if } m \text{ be odd,}$$

under any circumstances; therefore there must be two values of $\sin. \frac{\theta}{2}$ equal in magnitude, but with different signs; the same result as that we obtained from the equations for $\sin. \frac{\theta}{2}$ and $\cos. \frac{\theta}{2}$

(c) Again, I have given $\sin. \theta$ to find $\sin. \frac{\theta}{2}$ and $\cos. \frac{\theta}{2}$

We have—

$$\sin.^2 \frac{\theta}{2} + \cos.^2 \frac{\theta}{2} = 1$$

$$2 \sin. \frac{\theta}{2} \cos. \frac{\theta}{2} = \sin. \theta$$

Adding these equations, we obtain,

$$\sin.^2 \frac{\theta}{2} + 2 \sin. \frac{\theta}{2} \cos. \frac{\theta}{2} + \cos.^2 \frac{\theta}{2} = 1 + \sin. \theta$$

And, subtracting the second from the first,

$$\sin.^2 \frac{\theta}{2} - 2 \sin. \frac{\theta}{2} \cos. \frac{\theta}{2} + \cos.^2 \frac{\theta}{2} = 1 - \sin. \theta$$

Extracting the square root of each of these equations, and we have—

$$\sin. \frac{\theta}{2} + \cos. \frac{\theta}{2} = \sqrt{1 + \sin. \theta}$$

$$\sin. \frac{\theta}{2} - \cos. \frac{\theta}{2} = \sqrt{1 - \sin. \theta}$$

∴ Adding—

$$2 \sin. \frac{\theta}{2} = \sqrt{1 + \sin. \theta} - \sqrt{1 - \sin. \theta}$$

and subtracting—

$$2 \cos. \frac{\theta}{2} = \sqrt{1 + \sin. \theta} + \sqrt{1 - \sin. \theta}$$

$$\therefore \sin. \frac{\theta}{2} = \frac{1}{2} \left\{ \sqrt{1 + \sin. \theta} - \sqrt{1 - \sin. \theta} \right\}$$

$$\text{and } \cos. \frac{\theta}{2} = \frac{1}{2} \left\{ \sqrt{1 + \sin. \theta} + \sqrt{1 - \sin. \theta} \right\}$$

And since each square root has two sines, it follows that if we have given merely the value of $\sin. \theta$, i.e. $\sin. \theta = p$. we have *four* different values of $\sin. \frac{\theta}{2}$

$$\text{viz. } \frac{1}{2} (\sqrt{1+p} + \sqrt{1-p}), \frac{1}{2} (\sqrt{1+p} - \sqrt{1-p}),$$

$$\frac{1}{2} (-\sqrt{1+p} + \sqrt{1-p}), \text{ and } \frac{1}{2} (-\sqrt{1+p} - \sqrt{1-p}).$$

We may prove, as before, that this amount of undeterminateness is involved in the data: for if

$$\sin. \theta = p,$$

and if θ' be a value of θ . which satisfies this equation, then all the values of θ which satisfy the equation, are given by the formulas.

$$\theta = 2 m. 180^\circ + \theta$$

$$\text{and } \theta = (2 m. + 1) 180^\circ - \theta'$$

where m is any whole number whatever.

∴ $\sin. \frac{\theta}{2}$ may be either one of the two forms.

$\sin. (m. 180^\circ + \frac{\theta'}{2})$ or $\sin. (m. 180^\circ + 90 - \frac{\theta'}{2})$ or according as m is odd or even,

i.e. according as m is $2 n$ or $2 n + 1$.

One of the four—

$$\text{Sin. } (2n \cdot 180^\circ + \frac{\theta'}{2}) \text{ sin. } (\sqrt{2n+1} 180^\circ + \frac{\theta'}{2})$$

$$\text{Sin. } (2n \cdot 180^\circ + 90 - \frac{\theta'}{2}) \text{ or } \text{sin. } (\sqrt{2n+1} 180^\circ + 90^\circ - \frac{\theta'}{2})$$

And these are respectively equal to

$$\text{Sin. } \frac{\theta'}{2}, -\text{sin. } \frac{\theta'}{2}, \text{cos. } \frac{\theta'}{2}, \text{ and } \text{cos. } \frac{\theta'}{2}.$$

i. e. it may have one of the four different values—

$$\text{Sin. } \frac{\theta}{2}, -\text{sin. } \frac{\theta}{2}, \text{cos. } \frac{\theta}{2}, -\text{cos. } \frac{\theta}{2}.$$

If, however, we know the limits within which the value of θ lies, this indeterminateness vanishes. Thus, if $\theta > 90^\circ < 180^\circ$, then $\frac{\theta}{2} > 45^\circ < 90^\circ$, and therefore $\text{sin. } \frac{\theta}{2}$.

must be $> \frac{1}{\sqrt{2}} < 1$, and be positive. Hence, in this case,

$$\text{Sin. } \frac{\theta}{2} = \frac{1}{2} \{ +\sqrt{1 + \text{sin. } \theta} + \sqrt{1 - \text{sin. } \theta} \}.$$

$$\text{For when } \theta = 90 \text{ this gives } \text{sin. } \frac{\theta}{2} = \frac{1}{\sqrt{2}}.$$

$$\theta = 180 \text{ ———— } \text{sin. } \frac{\theta}{2} = 1.$$

and between these limits the value of the formula continually increases.

If, however, $\theta > 270^\circ < 360^\circ$, we have

$$\text{Sin. } \frac{\theta}{2} = \frac{1}{2} \{ -\sqrt{1 + \text{sin. } \theta} + \sqrt{1 - \text{sin. } \theta} \}.$$

The student will do well to verify this for himself.

The same kind of reasoning applies to the formula for $\text{cos. } \frac{\theta}{2}$.

(d). Again the formula

$$\text{Tan. } \theta = \frac{2 \text{ tan. } \frac{\theta}{2}}{1 - \text{tan}^2 \frac{\theta}{2}}$$

enables us to determine $\text{tan. } \frac{\theta}{2}$ when $\text{tan } \theta$ is given. For we can easily put the equation into the form

$$\text{Tan}^2 \frac{\theta}{2} + \frac{2}{\text{tan. } \theta} \text{ tan. } \frac{\theta}{2} = 1.$$

$$\therefore \text{tan. } \frac{\theta}{2} + \frac{1}{\text{tan. } \theta} = \pm \frac{\sqrt{1 + \text{tan}^2 \theta}}{\text{tan. } \theta} \text{ tan. } \frac{\theta}{2} = 1 + \frac{\sqrt{1 + \text{tan}^2 \theta}}{\text{tan. } \theta}$$

It will be observed that for one value of $\text{tan. } \theta$ we have two values of $\text{tan. } \frac{\theta}{2}$. The ambiguity is involved in the data in this case as in others. For if

$$\text{tan. } \theta = p.$$

then θ' being one value of θ , all the values of θ are included in the formula

$$\theta = m \cdot 180^\circ + \theta'.$$

\therefore according as m is odd or even, *i. e.* according as m is equal to $2n$, or $2n + 1$,

$$\frac{\theta}{2} = n \cdot 180^\circ + \frac{\theta'}{2}$$

$$\text{or } \frac{\theta}{2} = n \cdot 180^\circ + 90^\circ + \frac{\theta'}{2}$$

That is,

$$\text{Tan. } \frac{\theta}{2} = \text{tan. } n \cdot 180^\circ + \frac{\theta'}{2}$$

$$\text{or, } \text{tan. } (n \cdot 180^\circ + 90^\circ + \frac{\theta'}{2})$$

according as m is odd or even; and therefore

$$\text{or, tan. } \frac{\theta}{2} = \text{tan. } \frac{\theta'}{2} \text{ or tan. } (90^\circ + \frac{\theta'}{2})$$

$$= \text{tan. } \frac{\theta'}{2} \text{ or } -\text{cotan. } \frac{\theta'}{2}$$

Two different values, as also appeared from the formula.

30. *On the Numerical Value of the Sines, Cosines, &c., of the Angles 15°, 30°, 45°, 60°, 75°.*

We have already investigated the value of the trigonometrical ratios of 45°, 30° and 60°. By the aid of the above formulas we can investigate the values of many others. For example, of 15° and of 18°.

$$\text{Sin. } 15^\circ = \text{sin. } (45^\circ - 30^\circ) = \text{sin. } 45^\circ \cos. 30^\circ - \text{sin. } 30^\circ \cos. 45^\circ.$$

$$= \frac{1}{\sqrt{2}} \cdot \frac{\sqrt{3}}{2} - \frac{1}{2} \cdot \frac{1}{\sqrt{2}}$$

$$= \frac{\sqrt{3} - 1}{2\sqrt{2}}. \text{ which also equals } \cos. 75^\circ, \text{ since } 75^\circ = 90^\circ - 15^\circ.$$

$$\text{Cos. } 15^\circ = \cos. (45^\circ - 30^\circ) = \cos. 45^\circ \cos. 30^\circ + \text{sin. } 45^\circ \text{sin. } 30^\circ$$

$$= \frac{1}{\sqrt{2}} \cdot \frac{\sqrt{3}}{2} + \frac{1}{\sqrt{2}} \cdot \frac{1}{2} = \frac{\sqrt{3} + 1}{2\sqrt{2}} = \text{sin. } 75^\circ$$

Hence—

$$\text{Tan. } 15^\circ = \frac{\sqrt{3} - 1}{\sqrt{3} + 1} = \text{cotan. } 75^\circ$$

$$\text{Cotan. } 15^\circ = \frac{\sqrt{3} + 1}{\sqrt{3} - 1} = \text{tan. } 75^\circ$$

$$\text{Sec. } 15^\circ = \frac{2\sqrt{2}}{\sqrt{3} + 1} = \text{cosec. } 75^\circ$$

$$\text{Cosec. } 15^\circ = \frac{\sqrt{3} - 1}{2\sqrt{2}} = \text{sec. } 75^\circ$$

The student will observe that this investigation of the ratios of an angle of 15°, together with those previously investigated, gives the ratios of the series of angles 15°, 30°, 45°, 60°, 75°, 90°.

31. To investigate the Trigonometrical Ratios of an Angle of 18° , 36° , 54° , 72° .

Since $54^\circ = 90^\circ - 36^\circ$,
if we write θ for 18° , we have

$$3\theta = 90^\circ - 2\theta,$$

and therefore

$$\text{Cos. } 3\theta = \sin. 2\theta.$$

$$\therefore 4 \text{ Cos}^2\theta - 3 \cos. \theta = 2 \sin. \theta, \cos. \theta.$$

$$\therefore 4 \text{ Cos}^2\theta - 3 = 2 \sin. \theta.$$

$$\therefore 1 - 4 \sin.^2\theta = 2 \sin. \theta.$$

$$4 \text{ Sin.}^2\theta + 2 \sin. \theta = 1.$$

$$\therefore 4 \text{ Sin.}^2\theta + 2 \sin. \theta + \frac{1}{4} = \frac{5}{4}.$$

$$\therefore 2 \text{ Sin. } \theta = \frac{-1 + \sqrt{5}}{2}.$$

$$\text{Sin. } \theta = \frac{-1 + \sqrt{5}}{4}.$$

This is a case of ambiguity similar to those above explained, and if we only had the equation

$$4 \text{ Sin.}^2\theta + 2 \sin. \theta = 1,$$

we should have the two values of $\sin. \theta$ just given, viz., $\frac{-1 + \sqrt{5}}{4}$ and $\frac{-1 - \sqrt{5}}{4}$.

But as we not only have the equation, but also know that $\theta = 18^\circ$, this enables us to choose the only admissible value.

$$\text{Sin. } 18^\circ = \frac{-1 + \sqrt{5}}{4}.$$

For the other value of $\sin. \theta$ being negative cannot be the sine of 18° .

$$\text{Hence, } \cos^2 18^\circ = 1 - \sin.^2 18^\circ = 1 - \frac{3 - 1\sqrt{5}}{8} = \frac{5 + \sqrt{5}}{8}$$

$$\therefore \cos. 18^\circ = \frac{\sqrt{10 + 2\sqrt{5}}}{4}.$$

$$\text{Hence, } \sin. 36^\circ = \sin. 2 \times 18^\circ = \frac{(\sqrt{5} - 1)\sqrt{2}\sqrt{5} + 10}{8}$$

$$\text{and } \cos. 36^\circ = \frac{\sqrt{5} + 1}{4}.$$

$$\text{and } \sin. 36^\circ = \cos. 54^\circ, \text{ and } \sin. 18^\circ = \cos. 72^\circ.$$

Hence we evidently can obtain the trig. ratios of the angles 18° , 36° , 54° , 72° .

Again

$$\begin{aligned} \text{Sin. } 3^\circ &= (18^\circ - 15^\circ) \\ &= \sin. 18^\circ \cos. 15^\circ - \cos. 18^\circ \sin. 15^\circ. \\ &= \frac{\sqrt{5} - 1}{4} \times \frac{\sqrt{3} + 1}{2\sqrt{2}} - \frac{\sqrt{10 + 2\sqrt{5}}}{4} \frac{\sqrt{3} - 1}{2\sqrt{2}} \\ &= \frac{(1/15 - 1)(\sqrt{3} + 1) - (\sqrt{3} - 1)(\sqrt{10 + 2\sqrt{5}})}{8\sqrt{2}}. \end{aligned}$$

Hence we may clearly obtain numerical values for the trigonometrical ratios of the series of degrees, 3° , 6° , 9° , 12° , 15° , &c.

N.B.—In reading the preceding pages the student will have observed that in many instances, when a method of reasoning has been applied to one case, it has been merely indicated that the same method is applicable to a similar case. In all these instances he will do well to *write out at full length* the reasoning in these similar cases. By this means he will ensure a thorough comprehension of this part of the subject, and become familiar with the various combinations that trigonometric ratios can form. In regard to this very subject Dr. Peacock observes:—"It should be the first lesson of a student, in every branch of science, not to form his own estimate of the importance of elementary views and propositions, which are very frequently repulsive or uninteresting, and such as cannot be thoroughly mastered and remembered without a great sacrifice of time and labour." To assist in obtaining this familiarity he may perform the following exercises:—

$$(1.) \quad \frac{1}{2} + \cos. 2A = 2 \sin. (60^\circ - A) \sin. (60^\circ + A)$$

(Remember that $\cos. 120^\circ = -\frac{1}{2}$.)

$$(2.) \quad 4 \cos. m\theta \cos. n\theta \cos. r\theta = \cos. (m+n+r)\theta + \cos. (m+n-r)\theta + \cos. (m-n+r)\theta + \cos. (m-n-r)\theta$$

(Remember that $\cos. (A+B) + \cos. (A-B) = 2 \cos. A \cos. B$.)

$$(3.) \quad 4 \sin. ^2\theta \cos. \theta = \cos. \theta \cos. 3\theta.$$

$$(4.) \quad \tan. A + \tan. B = \frac{\sin. (A+B)}{\cos. A \cos. B}$$

(Remember that $\tan. A = \frac{\sin. A}{\cos. A}$.)

$$(5.) \quad \tan. ^2A - \tan. ^2B = \frac{\sin. (A+B) \sin. (A-B)}{\cos. ^2A \cos. ^2B}$$

(Remember that $\tan. ^2A - \tan. ^2B = (\tan. A + \tan. B)(\tan. A - \tan. B)$.)

$$(6.) \quad \text{If } \frac{m \sin. \beta}{n \sin. \alpha} = \frac{\cos. (B+x)}{\cos. (\alpha-x)} \text{ then}$$

$$\tan. x = \frac{n \cotan. \beta - m \cotan. \alpha}{n + m}.$$

$$(7.) \quad \text{If } \theta + \phi + \psi = 90^\circ \text{ show that}$$

$$(a) \quad \tan. \phi \tan. \psi + \tan. \psi \tan. \theta + \tan. \theta \tan. \phi = 1.$$

$$(b) \quad \tan. \theta + \tan. \phi + \tan. \psi = \tan. \theta + \tan. \phi \tan. \psi + \sec. \theta \sec. \phi \sec. \psi$$

(Remember that $\sin. (\theta + \phi + \psi) = 1$.

and $\cos. (\theta + \phi + \psi) = 0$.)

$$(8.) \quad \text{If } \frac{m \tan. (\alpha-x)}{\cos. ^2x} = \frac{n \tan. x}{\cos. ^2(\alpha-x)}$$

$$\text{Then, } \frac{\sin. (2\alpha - 2x)}{\sin. 2x} = \frac{n}{m}.$$

$$\text{and } \tan. (\alpha - 2x) = \frac{n-m}{n+m} \tan. \alpha.$$

(9.) If $\tan. A + 3 \cos. A = 4$, show that A has two series of values, one of which is $45^\circ, 225^\circ, 405^\circ, 585^\circ, \dots$ (i. e. $\tan. A = 1$).

(10.) If $\cos. nA + \cos. (n-2)A = \cos. A$, show that A must have the values

$$\frac{30^\circ}{n-1}, \frac{330^\circ}{n-1}, \frac{390^\circ}{n-1}, \frac{690^\circ}{n-1}, \frac{750^\circ}{n-1}, \dots$$

(11.) If $\sin. (x+\alpha) + \cos. (x+\alpha) = \sin. (x-\alpha) + \cos. (x-\alpha)$, then x must be $45^\circ, 225^\circ, 405^\circ, \dots$

(12.) If $\sin. A + \sin. (\theta - A) + \sin. (2\theta + A) = \sin. (\theta + A) + \sin. (2\theta - A)$.

(13.) If $2 \sin. (\theta - \phi) = 1$, and $\sin. (\theta' - \phi) = \cos. (\theta + \phi)$, then we shall have $\theta = 45^\circ$, $\phi = 15^\circ$.

(14.) If $\text{Tan. } \theta = \tan. \frac{2\phi}{3}$ and $\cos. 2\phi = \frac{m^2 - 1}{3}$.

Then $\frac{m^2 - 1}{3} = \left(\frac{\cos. \frac{2}{3}\theta - \sin. \frac{2}{3}\theta}{\cos. \frac{2}{3}\theta + \sin. \frac{2}{3}\theta} \right)^2$.

(15.) If $\sin. 2\theta - \sin. 2\theta = \frac{1}{4}$.

Show that $\sin. \theta = \pm \frac{1 + \sqrt{5}}{4}$, and show that the values of θ are given by the series.

18°	162°	378°	528°
54°	126°	416°	486°
198°	342°	558°	702°
234°	306°	594°	666°

(16.) Show that the series of angles in No. 9 can be expressed by the formula, $m. 180^\circ + 45^\circ$.

In No. 10, by the formula, $\frac{m. 360^\circ + 30^\circ}{n - 1}$.

In No. 11, by the formula, $m. 180^\circ + 45^\circ$.

In No. 15, by the formulas, $m. 180^\circ + 18^\circ$.

$m. 180^\circ + 54^\circ$.

31. On Inverse Trigonometrical Ratios Explanatory.

The following notation, which is part of a general system of notation originally proposed by Sir J. Herschel, is very generally adopted, and is very convenient.—

If $\tan. \theta = p$.

Then $\theta = \tan.^{-1} p$.

i. e. $\tan.^{-1} p$ means the angle whose tangent is p . In like manner $\sin.^{-1} p$ means the angle whose sine is p , and $\cos.^{-1} p$ the angle whose cosine is p .

The system of notation originally proposed was the following:—If $\sin. \theta = p$ and θ' an angle, the arc subtending which, divided by radius, is equal to p ; then, $\sin. \theta$ is the $\sin.$ of p , and therefore $\sin. \theta = \sin. (\sin. \theta)$, and Sir J. Herschel proposed to write

$$\text{Sin.} (\sin. \theta) = \sin. 2\theta,$$

reserving the notation $(\sin. A)^2$ for the squares of the $\sin.$ of θ . Upon this principle,

$$\text{Sin.} (\sin. (\sin. (\dots \sin. \theta))) = \sin^n \theta,$$

and evidently

$$\text{Sin}^n (\sin^m \theta) = \sin^{n \cdot m} \theta$$

or the notation follows the law of indices, and the interpretation that $\sin^{-1} p$ must obtain, is that it is the angle whose sine is p .

In like manner

$$\log (\log (\log. a)) \text{ is written } \log^3 a$$

and $\log^{-1} a$, signifies the number whose logarithm is a .

Of this system the only part that has obtained any extensive currency is that given above in the case of the inverse trigonometric ratios.

32. Formulas connecting inverse Trigonometric ratios.

There are some formulas in which these inverse ratios occur that are worthy of notice.

$$(a.) \quad \tan^{-1} m + \tan^{-1} n = \tan^{-1} \frac{m+n}{1-mn}$$

For if $\tan. \theta = m$ and $\tan. \phi = n$

$$\tan. (\theta + \phi) = \frac{\tan. \theta + \tan. \phi}{1 - \tan. \theta \tan. \phi} = \frac{m+n}{1-mn}$$

$$\text{Now } \theta = \tan^{-1} m \quad \phi = \tan^{-1} n.$$

$$\therefore \theta + \phi = \tan^{-1} m + \tan^{-1} n$$

$$\text{But } \theta + \phi = \tan^{-1} \frac{m+n}{1-mn}$$

$$\therefore \tan^{-1} m + \tan^{-1} n = \tan^{-1} \frac{m+n}{1-mn} \dots (28)$$

Hence,

$$2 \tan.^{-1} m = \tan.^{-1} \frac{2m}{1-m^2}$$

and

$$\tan.^{-1} m - \tan.^{-1} n = \tan.^{-1} \frac{m-n}{1-mn}$$

Again,

$$\sin.^{-1} m + \sin.^{-1} n = \sin.^{-1} \{m \sqrt{1-n^2} + n \sqrt{1-m^2}\}.$$

For let $\sin.^{-1} m = \theta$, $\sin.^{-1} n = \phi$.

$$\therefore m = \sin. \theta \quad n = \sin. \phi.$$

$$\sqrt{1-n^2} = \cos. \theta \quad \sqrt{1-m^2} = \cos. \phi.$$

Now $\sin. (\theta + \phi) = \sin. \theta \cos. \phi + \cos. \theta \sin. \phi$

$$= m \sqrt{1-n^2} + n \sqrt{1-m^2}$$

$$\theta + \phi = \sin.^{-1} \{m \sqrt{1-n^2} + n \sqrt{1-m^2}\}$$

Or,

$$\sin.^{-1} m + \sin.^{-1} n = \sin.^{-1} \{m \sqrt{1-n^2} + n \sqrt{1-m^2}\} \dots (29)$$

Similarly,

$$\cos.^{-1} m - \cos.^{-1} n = \cos.^{-1} \{mn - \sqrt{1-m^2} \sqrt{1-n^2}\}.$$

$$\cos.^{-1} m + \sin.^{-1} u = \sin.^{-1} mn + \sqrt{1-n^2} \sqrt{1-m^2}.$$

33. Examples.

Show that

$$\tan.^{-1} \frac{1}{2} + \tan.^{-1} \frac{1}{3} = 45^\circ$$

$$\text{For } \tan.^{-1} \frac{1}{2} + \tan.^{-1} \frac{1}{3} = \tan.^{-1} \frac{\frac{1}{2} + \frac{1}{3}}{1 - \frac{1}{2} \cdot \frac{1}{3}}$$

$$= \tan.^{-1} \frac{\frac{3+2}{6}}{\frac{1}{6}} = \tan.^{-1} 1 = 45^\circ$$

It is to be observed that when we say $\tan.^{-1} 1 = 45^\circ$ we mean that this is *one* value. All the values of $\tan.^{-1} 1$, arc, of course, given by the formula $m180^\circ + 55^\circ$.

Show that

$$(1.) \quad \sin.^{-1} \frac{2}{\sqrt{5}} + \tan.^{-1} \frac{1}{3} = 45^\circ$$

$$(2.) \quad \sin.^{-1} m = \tan.^{-1} \frac{m}{\sqrt{1-m^2}}$$

$$(3.) \quad \cos.^{-1} m + \tan.^{-1} m = \tan.^{-1} \frac{\sqrt{1-m^2} + m}{m - m \sqrt{1-m^2}}$$

$$(4.) \quad 4 \tan^{-1} \frac{1}{5} = \tan^{-1} \frac{120}{119}.$$

$$(5.) \quad 4 \tan^{-1} \frac{1}{5} - \tan^{-1} \frac{1}{239} = 45^\circ$$

$$(6.) \quad \tan^{-1} m + \tan^{-1} n = \sin^{-1} \left\{ \frac{m+n}{\sqrt{(1+m^2)(1+n^2)}} \right\}$$

$$(7.) \quad \text{If } \theta = \tan^{-1} \frac{1}{\sqrt{3}} \quad \phi = \tan^{-1} \frac{1}{\sqrt{15}}; \text{ then } \sin. (\theta + \phi) = \sin. 60 \cos. 36^\circ$$

ON THE USE OF SUBSIDIARY ANGLES.

34. *Explanatory.*

In making trigonometrical calculations it is nearly always necessary to conduct them by means of logarithms. For the purpose of preparing a formula for logarithmic calculation, it is often necessary or convenient to express the sum or difference of two or more magnitudes by means of a product: this can generally be performed by introducing the sine, tangent, or some other ratio of an angle chosen for that purpose, which is called a *subsidiary angle*. One or two examples will explain the means employed for this purpose.

35. *Examples.*

(a) Thus, let $x^2 = a^2 + b^2$ to find x

$$\text{we have } x^2 = a^2 \left(1 + \frac{b^2}{a^2} \right)$$

$$\text{Assume } \frac{b}{a} = \tan. \theta$$

$$\therefore a^2 (1 + \tan.^2 \theta) = \frac{a^2}{\cos.^2 \theta}.$$

$$\therefore x = \frac{a}{\cos. \theta}.$$

that if a and b are any two numbers whatever, we are entitled to assume that $\frac{a}{b} = \tan. \theta$, since $\tan. \theta$ may have any value whatever from 0. to ∞ , whether the value be positive or negative. But if we assume $\frac{a}{b} = \sin. \theta$, we must be sure that $a < b$, for otherwise $\frac{a}{b} > 1$, or $\sin. \theta > 1$, which is impossible.

(b) The following case is one that frequently occurs—

$$x = a \sin. A + b \cos. A.$$

$$\text{Assume } \frac{b}{a} = \tan. \theta$$

$$\text{then } x = a \left(\sin. A + \frac{b}{a} \cos. A \right)$$

$$= a \left(\sin. A + \tan. \theta \cos. A \right)$$

$$= a \frac{\sin. A \cos. \theta + \sin. \theta \cos. A}{\cos. \theta}$$

$$= a \frac{\sin. (A + \theta)}{\cos. \theta}$$

(c) Again, if we have

$$x = \frac{a^2 - b^2}{a^2 + b^2}$$

Assume $\frac{b}{a} = \tan. \theta$

$$\begin{aligned} \therefore x &= \frac{1 - \frac{b^2}{a^2}}{1 + \frac{b^2}{a^2}} \\ &= \frac{1 - \tan.^2 \theta}{1 + \tan.^2 \theta} \\ &= \frac{\cos.^2 \theta - \sin.^2 \theta}{\cos.^2 \theta + \sin.^2 \theta} \\ &= \cos.^2 \theta - \sin.^2 \theta = \cos. 2 \theta. \end{aligned}$$

N.B.—It will frequently happen in calculations that we have previously used certain logarithms, and when this is the case the calculation is very materially shortened. Thus, in the above example, suppose we already know $\log. a$ and $\log. b$. Then

$$L. \tan \theta = \log. b - \log. a + 10.$$

which immediately enables us to find $L. \cos. 2 \theta$; and therefore x , by only using the tables twice.

(d) $\text{Sin. A} = \cos. B \cos. C, \cos. a + \sin. B \sin. C.$

Assume $\frac{\cos. C \cos. a}{\sin. C} = \tan. \phi$

We obtain

$$\sin. A = \frac{\sin. C. \sin. (\phi + B.)}{\cos. \phi}$$

(e) If $x = \frac{p}{2} \left\{ 1 + \sqrt{1 - \frac{4q}{p^2}} \right\}$ where $p^2 > 4q$.

Assume $\frac{4q}{p^2} = \sin.^2 \theta$. Then

$$x = p. \sin.^2 \frac{\theta}{2}$$

(f) If $x = \frac{1 - \sqrt{1 - e^2}}{1 + \sqrt{1 - e^2}}$ $e < 1$.

Assume $e = \sin. \theta$. Then

$$x = \tan.^2 \frac{\theta}{2}.$$

(g) Such an example as the following frequently occurs in Astronomy :

If $x = m \cos. \theta + n \cos. (\theta + \alpha)$. Express x in the form $A. \cos. (\theta + B)$.

$$x = m \cos. \theta + n \cos. \alpha \cos. \theta - n \sin. \alpha \sin. \theta$$

$$= (m + n \cos. \alpha) \cos. \theta - n \sin. \alpha \sin. \theta$$

$$= (m + n \cos. \alpha) \left(\frac{\cos. \phi \cos. \theta - \sin. \phi \sin. \theta}{\cos. \phi} \right)$$

$$= \frac{m + n \cos. \alpha}{\cos. \phi} \cdot \cos. (\theta + \phi).$$

$$\text{where } \tan. \phi = \frac{n \sin. \alpha}{m + n \cos. \alpha}$$

It will be observed that the expression for $\tan. \phi$, is not expressed in products and quotients only; to effect this we must introduce another angle, ϕ' . Thus:—

$$\text{Assume } \tan \phi' = \frac{n}{m} \cos. \alpha$$

$$\text{Then } m + n \cos. \alpha = m (1 + \tan. \phi')$$

$$= \frac{m (\cos. \phi' + \sin. \phi')}{\cos. \phi'}$$

$$= \frac{m (\sin. \phi' \cos. 45^\circ + \cos. \phi' \sin. 45^\circ) \sqrt{2}}{\cos. \phi'}$$

$$= \frac{m \sin. (\phi' + 45^\circ) \sqrt{2}}{\cos. \phi'}$$

$$\therefore \tan. \phi = \frac{n \sin. \alpha \cos. \phi'}{m \sin. (\phi' + 45^\circ) \sqrt{2}}$$

$$\text{and } x = \frac{m \sqrt{2} \sin. (\phi' + 45^\circ) \cos. (\theta + \phi)}{n \sin. \alpha \cos. \phi \cos. \phi'}$$

Then x is in the form required.

THE RELATION BETWEEN THE SIDES AND ANGLES OF TRIANGLES.

In the following articles, abc represent the sides of a triangle, and ABC the angles which they subtend.

$$(36.) \text{ To show that in every triangle } \frac{a}{b} = \frac{\sin. A}{\sin. B}$$

Let ABC be the triangle, from C draw CN perpendicular to AB . Then whether A be acute or obtuse,

$$\sin. A = \frac{CN}{AC}, \text{ and } \sin. B = \frac{CN}{CB}$$

$$\therefore \frac{\sin. A}{\sin. B} = \frac{CN}{AC} \div \frac{CN}{CB} = \frac{CN}{AC} \times \frac{CB}{CN} = \frac{CB}{CA}$$

$$\therefore \frac{\sin. A}{\sin. B} = \frac{a}{b} \dots \dots (30)$$

$$\text{Similarly } \frac{\sin. B}{\sin. C} = \frac{b}{c}$$

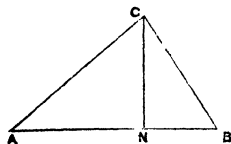

Fig. 16.

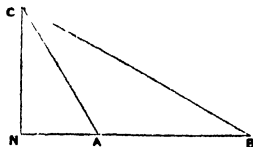

Fig. 17.

N.B. These relations manifestly can be written in the form

$$\frac{\sin. A}{a} = \frac{\sin. B}{b} = \frac{\sin. C}{c} \dots \dots (31)$$

(37.) To prove the formula.

$$a^2 = b^2 + c^2 - 2bc \cos. A.$$

If A be an acute angle. Let ABC be the triangle, draw CN perpendicular to the base of the triangle AB . Then (Euclid ii. 12);

$$BC^2 = AC^2 + AB^2 - 2 BA \cdot AN.$$

$$\text{Now, } AN = AC \cos. CAB = b \cos. A.$$

$$\therefore a^2 = b^2 + c^2 - 2bc \cos. A.$$

Again, if A be an obtuse angle. Then drawing CN perpendicular to AB produced, we have by Euclid, ii. 13,

$$BC^2 = AB^2 + AC^2 + 2 BA \cdot AN$$

$$\text{and } AN = CA \cos. CAN = b \cos. (180^\circ - A)$$

$$= -b \cos. A.$$

$$\therefore a^2 = b^2 + c^2 - 2ab \cos. A.$$

Hence whether A be acute or obtuse

$$a^2 = b^2 + c^2 - 2bc \cos. A. \dots (32).$$

Similarly

$$b^2 = c^2 + a^2 - 2ca \cos. B.$$

$$c^2 = a^2 + b^2 - 2ab \cos. C.$$

(38.) *To deduce the formulas of Articles 37 from those of 36.*

These formulas can be immediately deduced from the formula—

$$\frac{\sin. A}{a} = \frac{\sin. B}{b} = \frac{\sin. C}{c}$$

without reference to Euclid's demonstration. Thus, since the three angles of a triangle are together equal to two right angles, we have

$$A + B + C = 180^\circ.$$

$$\therefore \sin. (A + B) = \sin. (180^\circ - C) = \sin. C.$$

$$\therefore \sin. A \cos. B + \sin. B \cos. A = \sin. C.$$

$$\therefore \frac{\sin. A}{\sin. C} \cos. B + \frac{\sin. B}{\sin. C} \cos. A = 1; \text{ or } \frac{a}{c} \cos. B + \frac{b}{c} \cos. A = 1.$$

$$\therefore a \cos. B + b \cos. A = C.$$

$$\therefore a^2 \cos.^2 B + b^2 \cos.^2 C + 2ab \cos. A \cos. B = c^2.$$

$$\text{Now } \frac{a}{b} = \frac{\sin. A}{\sin. B}$$

$$\therefore a \sin. B - b \sin. A = 0$$

$$\therefore a^2 \sin.^2 B + b^2 \sin.^2 A - 2ab \sin. A \sin. B = 0$$

adding these two equations together, and remembering that $\sin.^2 A + \cos.^2 A = 1$, we have

$$a^2 + b^2 + 2ab (\cos. A \cos. B - \sin. A \sin. B) = c^2$$

$$\text{But } \cos. A \cos. B - \sin. A \sin. B = \cos. (A + B).$$

$$\text{Now, } \cos. (A + B) = \cos. (180^\circ - C) = -\cos. C.$$

$$\therefore a^2 + b^2 - 2ab \cos. C = c^2.$$

The other formulas can be derived in the same manner.

(39) *Certain Derived Formulas.*

(a) Again, since

$$a^2 = b^2 + c^2 - 2bc \cos. A.$$

$$\therefore \cos. A = \frac{b^2 + c^2 - a^2}{2bc}$$

$$\therefore 1 + \cos. A = 1 + \frac{b^2 + c^2 - a^2}{2bc}$$

$$\text{And } 1 - \cos. A = 1 - \frac{b^2 + c^2 - a^2}{2bc}$$

$$\therefore 1 + \cos. A = \frac{b^2 + 2bc + c^2 - a^2}{2bc}$$

$$1 - \cos. A = \frac{a^2 - b^2 + 2bc - c^2}{2bc}$$

$$\therefore 2 \cos^2 \frac{A}{2} = \frac{(b+c)^2 - a^2}{2bc}$$

$$2 \sin^2 \frac{A}{2} = \frac{a^2 - (b-c)^2}{2bc}$$

$$\therefore \cos^2 \frac{A}{2} = \frac{(b+c+a)(b+c-a)}{4bc}$$

$$\sin^2 \frac{A}{2} = \frac{(a-b+c)(a+b-c)}{4bc}$$

Now suppose $2s = a + b + c$

$$\therefore 2(s-a) = b + c - a$$

$$2(s-b) = a - b + c$$

$$2(s-c) = a + b - c$$

$$\therefore \cos. \frac{A}{2} = \sqrt{\frac{s(s-a)}{bc}} \dots \dots \dots (33)$$

$$\sin. \frac{A}{2} = \sqrt{\frac{(s-b)(s-c)}{bc}} \dots \dots \dots (34)$$

$$\text{Now, } \sin. A = 2 \sin. \frac{A}{2} \cos. \frac{A}{2}$$

$$\therefore \sin. A = \frac{2}{bc} \sqrt{s(s-a)(s-b)(s-c)} \dots \dots (35)$$

In regard to these formulas it will be observed that the angle and the denominators are always the three letters, *i. e.* if the angle is A the denominator is *bc*; if B, the denominator is *ca*, and so on. Again, in (33) it will be seen that the sides in the numerator correspond to the angle, and in (34) the sides in the numerator correspond to those in the denominator. Hence we can always adapt these formulas to any angle, thus :—

$$\sin. B = \frac{2}{ac} \sqrt{s(s-a)(s-b)(s-c)}$$

$$\cos. \frac{C}{2} = \sqrt{\frac{s(s-c)}{ab}}$$

(b) The following relations are important :—

$$\text{Since } \frac{a}{b} = \frac{\sin. A}{\sin. B}$$

$$\therefore \frac{a+b}{b} = \frac{\sin. A + \sin. B}{\sin. B}$$

$$\begin{aligned} \frac{a-b}{b} &= \frac{\sin. A - \sin. B}{\sin. B} \\ \therefore \frac{a-b}{a+b} &= \frac{\sin. A - \sin. B}{\sin. A + \sin. B} \\ &= \frac{2 \sin. \frac{A-B}{2} \cos. \frac{A+B}{2}}{2 \cos. \frac{A-B}{2} \sin. \frac{A+B}{2}} \\ &= \tan. \frac{A-B}{2} \cotan. \frac{A+B}{2}. \end{aligned}$$

Now

$$\begin{aligned} A + B &= 180^\circ - C. \\ \therefore \cotan. \frac{A+B}{2} &= \cotan. \left(90^\circ - \frac{C}{2} \right) = \tan. \frac{C}{2} \\ \therefore \tan. \frac{A-B}{2} \tan. \frac{C}{2} &= \frac{a-b}{a+b} \dots (36) \end{aligned}$$

(40.) To obtain Formula (32) in a form adapted for Logarithmic calculation.

The above formulas, expressing the relation between the sides and angles of a triangle, are in a form adapted for logarithmic computation, except

$$c^2 = a^2 + b^2 - 2ab \cos. C.$$

This can easily be written in such a form, by introducing a subsidiary angle. Thus,

$$\begin{aligned} c^2 &= a^2 + b^2 - 2ab \cos. C. \\ &= a^2 + b^2 + 2ab - 2ab - 2ab \cos. C. \\ &= a^2 + b^2 + 2ab - 2ab (1 + \cos. C) \\ &= (a+b)^2 - 4ab \cos.^2 \frac{C}{2} \\ &= (a+b)^2 \left\{ 1 - \frac{4ab \cos.^2 \frac{C}{2}}{(a+b)^2} \right\} \end{aligned}$$

$$\text{Now } a+b > \sqrt{2ab}. \quad \therefore \frac{2\sqrt{ab} \cos. \frac{C}{2}}{a+b} < 1.$$

We may therefore assume

$$\frac{2\sqrt{ab} \cos. \frac{C}{2}}{a+b} = \cos. \theta$$

$$\therefore c^2 = (a+b)^2 (1 - \cos.^2 \theta) = (a+b)^2 \sin.^2 \theta$$

$$\therefore c = (a+b) \sin. \theta \dots (37)$$

Or we may proceed as follows,

$$\text{Since } 1 = \cos.^2 \frac{C}{2} + \sin.^2 \frac{C}{2}$$

$$\text{And } \cos. C = \cos.^2 \frac{C}{2} - \sin.^2 \frac{C}{2}$$

$$\therefore c^2 = (a^2 + b^2) \left(\cos.^2 \frac{C}{2} + \sin.^2 \frac{C}{2} \right) - 2ab \left(\cos.^2 \frac{C}{2} - \sin.^2 \frac{C}{2} \right)$$

$$= (a^2 + 2ab + b^2) \sin^2 \frac{C}{2} + (a^2 - 2ab + b^2) \cos^2 \frac{C}{2}.$$

$$= (a+b)^2 \sin^2 \frac{C}{2} + (a-b)^2 \cos^2 \frac{C}{2}.$$

$$= (a+b)^2 \sin^2 \frac{C}{2} \left\{ 1 + \left(\frac{a-b}{a+b} \right)^2 \cotan^2 \frac{C}{2} \right\}.$$

$$\text{Assume } \tan. \theta = \frac{a-b}{a+b}. \quad \cotan. \frac{C}{2}.$$

$$\therefore c^2 = (a+b)^2 \sin^2 \frac{C}{2} (1 + \tan^2 \theta)$$

$$\text{or } c = \frac{(a+b) \sin. \frac{C}{2}}{\cos. \theta} \dots \dots (381.)$$

Also the calculation of $\tan. \frac{A-B}{2} = \frac{a-b}{a+b} \cotan. \frac{C}{2}$ can be simplified, if we have already $\log. a$ and $\log. b$; by introducing a subsidiary angle. Thus,

$$\frac{a-b}{a+b} = \frac{1 - \frac{b}{a}}{1 + \frac{b}{a}}$$

$$\text{Assume } \tan. \theta = \frac{b}{a}$$

$$\therefore \frac{a-b}{a+b} = \frac{1 - \tan. \theta}{1 + \tan. \theta} = \frac{\tan. 45^\circ - \tan. \theta}{1 + \tan. 45^\circ \tan. \theta}$$

for $\tan. 45^\circ = 1$.

$$\therefore \frac{a-b}{a+b} = \tan. (45^\circ - \theta)$$

$$\text{and } \tan. \frac{A-B}{2} = \tan. (45^\circ - \theta) \cotan. \frac{C}{2} \dots (39)$$

There are several Theorems which can be deduced by means of the relations proved above. The following are a few.

(41.) *To find the area of a triangle in terms of its sides.*

In figure (16) we evidently have

$$\text{Area triangle} = \frac{1}{2} \cdot \text{CN} \cdot \text{AB}.$$

$$\text{Now } \text{CN} = \text{AC} \sin. A = b \sin. A.$$

$$\therefore \text{area} = \frac{bc}{2} \sin. A$$

$$= \frac{bc}{2} \times \frac{2}{bc} \sqrt{s(s-a)(s-b)(s-c)} \dots (35).$$

$$= \sqrt{s(s-a)(s-b)(s-c)}$$

N.B.—If $a = b = c$, or triangle equilateral, then $s = \frac{3a}{2}$

$$\therefore \text{area} = \frac{a^2 \sqrt{3}}{4}$$

If $a = b$, or triangle isosceles

$$S = a + \frac{c}{2} \quad S - a = S - b = \frac{a}{2}$$

$$S - c = a - \frac{c}{2}$$

$$\therefore \text{area} = \frac{c}{2} \sqrt{a^2 - \frac{c^2}{4}}$$

(42.) To find the radius of Incribed Circle on terms of sides.

ABC the triangle.

O the centre of inscribed circle

Join OA, OB, OC.

Now area ABC = area BOC + area COA
+ area AOB.

Let r = required radius.

$$\text{Then, area BOC} = \frac{ra}{2}$$

$$\text{area COA} = \frac{rb}{2}$$

$$\text{area AOB} = \frac{rc}{2}$$

$$\therefore r \frac{a+b+c}{2} = \text{area.}$$

$$\therefore r = \frac{\sqrt{s(s-a)(s-b)(s-c)}}{s}$$

The circles which touch one side of a triangle, and the two other sides produced, are sometimes called the *suscribed* circles. Let r_a , r_b , r_c be the radii of those circles which touch the sides a , b , c respectively.

Then if O_1 be the centre of the circle which touches the side BC, join O_1A , O_1B , O_1C . We clearly have

$$\text{Area } BO_1C + \text{area } CO_1A + \text{area } AO_1B = \text{area } \triangle ABC.$$

$$\therefore \frac{r_a a}{2} + \frac{r_a b}{2} + \frac{r_a c}{2} = \text{area.}$$

$$\therefore r_a (s-a) = \sqrt{s(s-a)(s-b)(s-c)}$$

$$r_a = \frac{\sqrt{s(s-a)(s-b)(s-c)}}{(s-a)}$$

Similarly

$$r_b = \frac{\sqrt{s(s-a)(s-b)(s-c)}}{(s-b)}$$

$$r_c = \frac{\sqrt{s(s-a)(s-b)(s-c)}}{(s-c)}$$

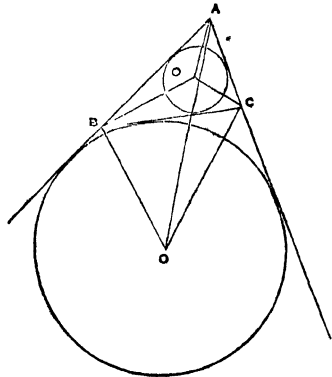

Fig 18.

(43.) To find the Area of the Circumscribed Circle.

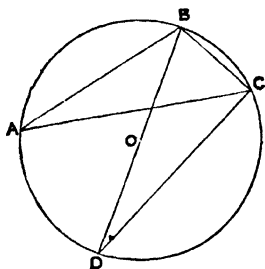

Fig. 19.

ABC the triangle. Circumscribe a circle about it, the centre of which is O. Join BO and produce it to meet the circumference in D. Join DC. Then (Euclid III.—21) $BDC = BAC$, and BCD is a right angle. (Euclid III.—31.)

Now $BD \sin. BDC = BC$.

\therefore If $R =$ radius of circumscribed circle,
 $2R \sin. A = a$.

$$\therefore \frac{R}{bc} \sqrt{s(s-a)(s-b)(s-c)} = a$$

$$R = \frac{abc}{\sqrt{s(s-a)(s-b)(s-c)}}$$

(44.) To find the Area of a quadrilateral inscribed in a Circle in terms of the sides.

ABCD a quadrilateral inscribable in a circle, let the four sides AB, BC, CD, DA, be respectively a, b, c, d . Join AC.

Now, if $\angle ABC = \theta$ $\angle ADC = 180^\circ - \theta$ (Euclid III.—22.)

Hence, $AC^2 = a^2 + b^2 - 2ab \cos. \theta$

and $AC^2 = c^2 + d^2 - 2cd \cos. (180^\circ - \theta)$

$\therefore a^2 + b^2 - 2ab \cos. \theta = c^2 + d^2 + 2cd \cos. \theta$

$$\therefore \cos. \theta = \frac{a^2 + b^2 - c^2 - d^2}{2ab + 2cd}$$

$$\text{Now, } 2 \cos. \frac{\theta}{2} = 1 + \cos. \theta$$

$$\begin{aligned} \therefore 2 \cos. \frac{\theta}{2} &= 1 + \frac{a^2 + b^2 - c^2 - d^2}{2ab + 2cd} \\ \frac{(a+b)^2 - (c-d)^2}{2ab + 2cd} &= \frac{(a+b+c-d)(a+b-c+d)}{2ab + 2cd} \\ \frac{2(s-d)(s-c)}{ab + cd} & \quad \text{if } 2s = a + b + c + d. \end{aligned}$$

Similarly,

$$\begin{aligned} 2 \sin. \frac{\theta}{2} &= 1 - \frac{a^2 + b^2 - c^2 - d^2}{2ab + 2cd} \\ &= \frac{2(s-b)(s-c)}{ab + cd} \\ \sin^2 \theta &= \frac{4(s-a)(s-b)(s-c)(s-d)}{(ab + cd)^2} \end{aligned}$$

But area of triangle ADC

$$\begin{aligned} &= \frac{AD, DC}{2} \sin. ADC = \frac{dc}{2} \sin. (180^\circ - \theta) \\ &= \frac{dc}{2} \sin. \theta \end{aligned}$$

$$\text{Area of triangle ABC} = \frac{AB, BC}{2} \sin. \theta$$

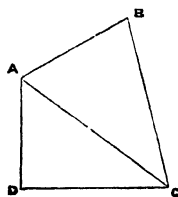

Fig. 20.

$$= \frac{ab}{2} \sin. \theta.$$

$$\therefore \text{The whole area} = \frac{\sin. \theta}{2} (ab + dc).$$

Hence area of quadrilateral

$$= \sqrt{(s-a)(s-b)(s-c)(s-d)}.$$

(45.) To find the area of a polygon of n sides inscribed in a given circle.

If AB is one side of the polygon, O the centre of the circle, let r be the radius, and n the number of sides. Then area of polygon $= n \times$ (area triangle OAB).

$$\text{Now angle } AOB = \frac{360^\circ}{n}.$$

Draw Op perpendicular to AB ,

$$\text{Then } \angle AOp = \frac{1}{2} \angle AOB \therefore \angle AOp = \frac{180^\circ}{n}.$$

$$\text{Then area of triangle} = \frac{AB \times Op}{2} = Ap \times Op.$$

$$Ap = r \sin. \frac{180^\circ}{n}, \quad Op = r \cos. \frac{180^\circ}{n}.$$

$$\therefore \text{Area triangle} = r^2 \sin. \frac{180^\circ}{n} \cos. \frac{180^\circ}{n}.$$

$$= \frac{1}{4} r^2 \sin. \frac{360^\circ}{n}.$$

If a is one side of the polygon,

$$\text{Then } \frac{a}{2} = r \sin. \frac{180^\circ}{n}.$$

$$\therefore r = \frac{a}{2 \sin. \frac{180^\circ}{n}}$$

$$\therefore \text{area of triangle} = \frac{a^2}{4 \sin^2 \frac{180^\circ}{n}} \times \sin. \frac{180^\circ}{n} \cos. \frac{180^\circ}{n}$$

$$= \frac{a^2}{4} \cotan. \frac{180^\circ}{n}.$$

$$\text{Hence area of polygon} = \frac{n}{2} r^2 \sin. \frac{360^\circ}{n} \text{ when radius is given,}$$

$$\text{And area of polygon} = \frac{na^2}{4} \cotan. \frac{180^\circ}{n} \text{ when side is given.}$$

The area of circumscribed polygon can in like manner be proved to equal

$$n r^2 \tan. \frac{180^\circ}{n}.$$

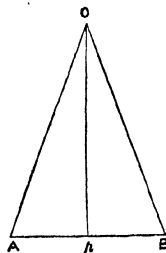

Fig. 21.

ON TRIGONOMETRICAL SERIES AND TABLES.

(46) *General Explanations.*

The preceding pages give the theory of plane trigonometry. To complete this branch of mathematical science it remains to explain the mode of deducing numerical results from the above theory, and to perform the actual calculations of the parts of triangles from which the science derives its name. We have already seen that the trigonometrical ratios of certain angles are known; for example, we know that $\sin. 45^\circ = \frac{1}{\sqrt{2}}$, $\sin. 60^\circ = \frac{\sqrt{3}}{2}$, and some others, and knowing these values we can determine $\log. \sin. 45^\circ$, $\log. \sin. 60^\circ$, and so on. Now instead of knowing only the trigonometrical functions of certain angles, we want to know the trigonometrical functions of every angle from 0° up to 90° . And as the calculations are for the most part carried on by means of logarithms, we require to know also the logarithms of these functions. These values have been calculated and arranged in tables in a similar manner to the tables of logarithms as before explained; we purpose in the following pages to explain the principles on which this calculation has been effected.

In our article on series and logarithms, we found it necessary to investigate certain algebraical series before proceeding to discuss the nature of logarithms; in like manner we shall find it now necessary to investigate certain trigonometrical series before explaining the construction of trigonometrical tables. In the following article on trigonometrical series we shall always keep this object strictly in view, a circumstance that will account for the absence of certain series that are often given in treatises of trigonometry. There is a very large number of such series; we treat the series here simply as the *means of arriving at the numerical results*, and on this principle make the following selection from that large number. The student will do well to observe, in studying any branch of mathematics, in which algebraical formulas occur, that unless he understands the method of obtaining arithmetical results from his formulas, he has not as yet mastered the subject.

The first article is an example of a limiting value. We would recommend the student to consider it very carefully. The proposition to be proved is that the limiting value of $\frac{\sin. \theta}{\theta} = 1$, where, of course θ is in circular measure. The following will sufficiently explain the meaning of the statement. When θ becomes very small, $\frac{\sin. \theta}{\theta}$ becomes very nearly equal to 1, and the smaller θ becomes the more nearly $\frac{\sin. \theta}{\theta}$ becomes equal to 1; but so long as θ has any value, however small, $\frac{\sin. \theta}{\theta}$ can never actually equal 1. Then the value which limits the value of $\frac{\sin. \theta}{\theta}$ is 1, while the value which limits the values of θ is 0, and we assume that if θ actually equals 0, $\frac{\sin. \theta}{\theta}$ actually equals 1. The assumption is in point of fact an

$$\text{Now} \quad \frac{\text{arc AP}}{\text{AT}} = \frac{\frac{\text{arc AP}}{\text{PO}}}{\frac{\text{AT}}{\text{PO}}} = \frac{\sin. \theta}{\theta}$$

Hence, in the limit when θ equals zero,

$$\frac{\sin. \theta}{\theta} = 1.$$

Q. E. D.

Cor. Under all circumstances—

$$\frac{\tan. \theta}{\theta} = \frac{\sin. \theta}{\theta} \times \frac{1}{\cos. \theta}$$

$$\text{Now when } \theta = 0 \quad \frac{\sin. \theta}{\theta} \times \frac{1}{\cos. \theta} = 1.$$

Hence, in the limiting case, when $\theta = 0$,

$$\frac{\tan. \theta}{\theta} = 1$$

(48). *De Moivre's Theorem.*

$$(a) \text{ To prove that } (\cos. \theta + \sqrt{-1} \sin. \theta) \times (\cos. \phi + \sqrt{-1} \sin. \phi) = \cos. (\theta + \phi) + \sqrt{-1} \sin. (\theta + \phi).$$

For by actual multiplication—

$$\begin{aligned} & (\cos. \theta + \sqrt{-1} \sin. \theta) (\cos. \phi + \sqrt{-1} \sin. \phi) = \\ & \cos. \theta \cos. \phi + \sqrt{-1} \sin. \theta \cos. \phi + \sqrt{-1} \cos. \theta \sin. \phi - \sin. \theta \sin. \phi \\ & = \cos. \theta \cos. \phi - \sin. \theta \sin. \phi + \sqrt{-1} \left\{ \sin. \theta \cos. \phi + \cos. \theta \sin. \phi \right\} \\ & = \cos. (\theta + \phi) + \sqrt{-1} \sin. (\theta + \phi). \end{aligned}$$

Hence—

$$\begin{aligned} & (\cos. \theta + \sqrt{-1} \sin. \theta) (\cos. \phi + \sqrt{-1} \sin. \phi) (\cos. \psi + \sqrt{-1} \sin. \psi) = \\ & \left\{ \cos. (\theta + \phi) + \sqrt{-1} \sin. (\theta + \phi) \right\} (\cos. \psi + \sqrt{-1} \sin. \psi) = \\ & \cos. (\theta + \phi + \psi) + \sqrt{-1} \sin. (\theta + \phi + \psi). \end{aligned}$$

And generally if we had n angles $\theta_1 \dots \theta_2 \dots \theta_n$, we should have—

$$\begin{aligned} & \left\{ \cos. \theta_1 + \sqrt{-1} \sin. \theta_1 \right\} \left\{ \cos. \theta_2 + \sqrt{-1} \sin. \theta_2 \right\} \dots \left\{ \cos. \theta_n + \sqrt{-1} \sin. \theta_n \right\} \\ & = \cos. (\theta_1 + \theta_2 + \dots + \theta_n) + \sqrt{-1} \sin. (\theta_1 + \theta_2 + \dots + \theta_n) \dots \dots (40). \end{aligned}$$

(b) To show that $(\cos. \theta + \sqrt{-1} \sin. \theta)^n = \cos. n\theta + \sqrt{-1} \sin. n\theta$ for all integral and positive values of n .

In equation (40), suppose $\theta_1 \theta_2 \dots \theta_n$ to be each equal to one another and to θ .
Then—
 $\theta_1 + \theta_2 + \dots + \theta_n = n\theta$.

And—

$$\begin{aligned} & (\cos. \theta_1 + \sqrt{-1} \sin. \theta_1) (\cos. \theta_2 + \sqrt{-1} \sin. \theta_2) \dots (\cos. \theta_n + \sqrt{-1} \sin. \theta_n) \\ & = (\cos. \theta + \sqrt{-1} \sin. \theta) (\cos. \theta + \sqrt{-1} \sin. \theta) \dots (\cos. \theta + \sqrt{-1} \sin. \theta) \\ & = (\cos. \theta + \sqrt{-1} \sin. \theta)^n. \end{aligned}$$

$$\text{And} \quad \cos. (\theta_1 + \theta_2 + \dots + \theta_n) + \sqrt{-1} \sin. (\theta_1 + \theta_2 + \dots + \theta_n)$$

$$= \cos. n \theta + \sqrt{-1} \sin. n \theta.$$

Hence $(\cos. \theta + \sqrt{-1} \sin. \theta)^n = \cos. n \theta + \sqrt{-1} \sin. n \theta.$

(c.) To prove the same theorem when n is a negative whole number.

For by multiplication, $(\cos. n \theta + \sqrt{-1} \sin. n \theta), (\cos. n \theta - \sqrt{-1} \sin. n \theta)$
 $= \cos.^2 n \theta + \sin.^2 n \theta = 1.$

$$\begin{aligned} \text{now } 1 &= \frac{(\cos. \theta + \sqrt{-1} \sin. \theta)^n}{(\cos. \theta + \sqrt{-1} \sin. \theta)^n} \\ &= (\cos. \theta + \sqrt{-1} \sin. \theta)^n (\cos. \theta + \sqrt{-1} \sin. \theta)^{-n} \\ &= (\cos. n \theta + \sqrt{-1} \sin. n \theta), (\cos. \theta + \sqrt{-1} \sin. \theta)^{-n} \\ \therefore (\cos. n \theta + \sqrt{-1} \sin. n \theta), (\cos. \theta + \sqrt{-1} \sin. \theta)^{-n} &= \\ (\cos. n \theta + \sqrt{-1} \sin. n \theta), (\cos. n \theta - \sqrt{-1} \sin. n \theta); & \\ \therefore (\cos. \theta + \sqrt{-1} \sin. \theta)^{-n} = \cos. n \theta - \sqrt{-1} \sin. n \theta & \\ &= \cos. (-n \theta) + \sqrt{-1} \sin. (-n \theta). \end{aligned}$$

Since $\cos. (-n \theta) = \cos. n \theta$
 $\sin. (-n \theta) = -\sin. n \theta.$

Hence the theorem is true when n is negative.

(d.) To prove the same theorem when n is fractional.

$$\text{Let } n = \frac{p}{q}$$

$$\begin{aligned} \text{Now } \left(\cos. \frac{p \theta}{q} + \sqrt{-1} \sin. \frac{p \theta}{q} \right)^q &= \cos. p \theta + \sqrt{-1} \sin. p \theta. \\ &= (\cos. \theta + \sqrt{-1} \sin. \theta)^p. \\ \therefore \cos. \frac{p \theta}{q} + \sqrt{-1} \sin. \frac{p \theta}{q} &= \sqrt[q]{(\cos. \theta + \sqrt{-1} \sin. \theta)^p} \\ &= (\cos. \theta + \sqrt{-1} \sin. \theta)^{\frac{p}{q}} \end{aligned}$$

and hence, in all cases—

$$(\cos. \theta + \sqrt{-1} \sin. \theta)^n = \cos. n \theta + \sqrt{-1} \sin. n \theta \dots \dots (41.)$$

Whether n be positive or negative, integral or fraction; which theorem is called De Moivre's theorem.

(49.) To express $\sin. m \theta$ and $\cos. m \theta$ in terms of powers of $\sin. \theta$ and $\cos. \theta.$

Since

$$\begin{aligned} (\cos. m \theta + \sqrt{-1} \sin. m \theta) &= (\cos. \theta + \sqrt{-1} \sin. \theta)^m \\ &= \cos.^m \theta - \frac{m \cdot m-1}{1 \cdot 2} \cos.^{m-2} \theta \sin.^2 \theta + \frac{m \cdot m-1 \cdot m-2 \cdot m-3}{1 \cdot 2 \cdot 3 \cdot 4} \times \\ &\quad \cos.^{m-4} \theta \sin.^4 \theta - \&c. \\ &+ \sqrt{-1} \left\{ m \cdot \cos.^{m-1} \theta \sin. \theta - \frac{m \cdot m-1 \cdot m-2}{1 \cdot 2 \cdot 3} \cos.^{m-3} \theta \sin.^3 \theta + \dots \right\} \end{aligned}$$

Hence equating possible and impossible quantities,

$$\begin{aligned} \cos. m \theta &= \cos.^m \theta - \frac{m \cdot m-1}{1 \cdot 2} \cos.^{m-2} \theta \sin.^2 \theta \\ &+ \frac{m \cdot m-1 \cdot m-2 \cdot m-3}{1 \cdot 2 \cdot 3 \cdot 4} \cos.^{m-4} \theta \sin.^4 \theta - \&c. \dots (42.) \end{aligned}$$

and

$$\sin. m \theta = m \cos.^{m-1} \theta \sin. \theta - \frac{m \cdot m-1 \cdot m-2}{1 \cdot 2 \cdot 3} \cos.^{m-3} \theta \sin.^3 \theta + \dots (43)^*$$

(50.) To express $\sin. \phi$, and $\cos. \phi$, in terms of ϕ .

$$\text{Let } m \theta = \phi, \text{ and } \therefore \theta = \frac{\phi}{m}.$$

Hence in the expression of the last article for $\cos. m \theta$, we have

$$\begin{aligned} \cos. \phi &= \left(\cos. \frac{\phi}{m} \right)^m - \frac{m \cdot (m-1)}{1 \cdot 2} \left(\cos. \frac{\phi}{m} \right)^{m-2} \sin.^2 \frac{\phi}{m} \\ &+ \frac{m \cdot (m-1) (m-2) (m-3)}{1 \cdot 2 \cdot 3 \cdot 4} \left(\cos. \frac{\phi}{m} \right)^{m-4} \sin.^4 \frac{\phi}{m} \&c. \\ &= \left(\cos. \frac{\phi}{m} \right)^m - \frac{\left(1 - \frac{1}{m} \right)}{1 \cdot 2} \left(\cos. \frac{\phi}{m} \right)^{m-2} \left(\sin. \frac{\phi}{m} \right)^2 \\ &+ \frac{\left(1 - \frac{1}{m} \right) \left(1 - \frac{2}{m} \right) \left(1 - \frac{3}{m} \right)}{1 \cdot 2 \cdot 3 \cdot 4} \left(\cos. \frac{\phi}{m} \right)^{m-4} \left(\sin. \frac{\phi}{m} \right)^4 \&c. \\ &- \left(\cos. \frac{\phi}{m} \right)^m - \frac{1 - \frac{1}{m}}{1 \cdot 2} \left(\cos. \frac{\phi}{m} \right)^{m-2} \left(\frac{\sin. \frac{\phi}{m}}{\frac{\phi}{m}} \right)^2 \phi \\ &+ \frac{\left(1 - \frac{1}{m} \right) \left(1 - \frac{2}{m} \right) \left(1 - \frac{3}{m} \right)}{1 \cdot 2 \cdot 3 \cdot 4} \left(\cos. \frac{\phi}{m} \right)^{m-4} \left(\frac{\sin. \frac{\phi}{m}}{\frac{\phi}{m}} \right)^4 \phi^4 \&c. \end{aligned}$$

This formula is true for every value of m , however large m may be; but if we suppose m to become very large, then in the limiting or extreme case when m is infinity $\frac{\phi}{m}$ is zero, and hence in this limiting case

* We assume in this article that if $a + \sqrt{-1} \cdot b = A + \sqrt{-1} B$, where a, b, A, B , are real. Then $a = A$ and $B = b$. To prove this, suppose A to be unequal to a and let $A = a + x$, and $B = b + y$.

$$\therefore a + b \sqrt{-1} = a + x + (b + y) \sqrt{-1}$$

$$\therefore 0 = x + y \sqrt{-1}$$

$$\therefore -x = y \sqrt{-1}$$

$$\therefore x^2 = -y^2$$

$$\therefore x^2 + y^2 = 0.$$

Now x^2 and y^2 must each be positive.

$$\therefore x = 0 \text{ and } y = 0$$

$$\therefore A = a, \text{ and } B = b.$$

$$\frac{\sin. \frac{\phi}{m}}{\frac{\phi}{n}} = 1.$$

Also $1 - \frac{1}{m} = 1.$ $1 - \frac{2}{m} = 1.$ &c.

Also $\left(\cos. \frac{\phi}{m} \right)^m = 1.$

And therefore

$$\cos. \phi = 1 - \frac{\phi^2}{1.2} + \frac{\phi^4}{1.2.3.4} - \&c. \dots (44.)$$

By reasoning in precisely the same way from the formula for $\sin. m \theta$ we shall obtain

$$\sin. \phi = \phi - \frac{\phi^3}{1.2.3} + \frac{\phi^5}{1.2.3.4.5} - \&c. \dots (45.)$$

COR. If ϕ be so small that we can omit ϕ^3 , we shall clearly have

$$\sin. \phi = \phi \text{ and } \cos. \phi = 1 - \frac{\phi^2}{2}$$

(51.) *To obtain sin. θ . cos. θ . and tan. θ in terms of Exponentials.*

Since

$$\sin. \theta = \theta - \frac{\theta^3}{1.2.3} + \frac{\theta^5}{1.2.3.4.5} - \&c.$$

$$\& \cos. \theta = 1 - \frac{\theta^2}{1.2} + \frac{\theta^4}{1.2.3.4} - \&c.$$

$$\therefore \sqrt{-1} \sin. \theta = \theta \sqrt{-1} - \frac{\theta^3 \sqrt{-1}}{1.2.3} + \frac{\theta^5 \sqrt{-1}}{1.2.3.4.5} - \&c.$$

$$\therefore \cos. \theta + \sqrt{-1} \sin. \theta = 1 + \theta \sqrt{-1} - \frac{\theta^2}{1.2} - \frac{\theta^3 \sqrt{-1}}{1.2.3} + \frac{\theta^4}{1.2.3.4} + \frac{\theta^5 \sqrt{-1}}{1.2.3.4.5}$$

$$\& \cos. \theta - \sqrt{-1} \sin. \theta = 1 - \theta \sqrt{-1} - \frac{\theta^2}{1.2} + \frac{\theta^3 \sqrt{-1}}{1.2.3} + \frac{\theta^4}{1.2.3.4} - \frac{\theta^5 \sqrt{-1}}{1.2.3.4.5}$$

Now

$$(\sqrt{-1})^2 = -1.$$

$$(\sqrt{-1})^3 = (\sqrt{-1})^2 \sqrt{-1} = -\sqrt{-1}.$$

$$(\sqrt{-1})^4 = (\sqrt{-1})^2 (\sqrt{-1})^2 = (-1) + (-1) = 1.$$

$$\therefore \cos. \theta + \sqrt{-1} \sin. \theta = 1 + \theta \sqrt{-1} + \frac{(\theta \sqrt{-1})^2}{1.2} + \frac{(\theta \sqrt{-1})^3}{1.2.3} + \dots$$

and

$$\cos. \theta - \sqrt{-1} \sin. \theta = 1 - \theta \sqrt{-1} + \frac{(\theta \sqrt{-1})^2}{1.2} - \frac{(\theta \sqrt{-1})^3}{1.2.3} + \dots$$

$$\theta \sqrt{-1}.$$

$$\therefore \cos. \theta + \sqrt{-1} \sin. \theta = e \dots (46.)$$

$$\text{And } \cos. \theta - \sqrt{-1} \sin. \theta = e^{-\theta \sqrt{-1}} \dots (47.)$$

by the exponential theorem (Art. on Series)

\therefore dividing the former by the latter

$$\frac{\cos. \theta + \sqrt{-1} \sin. \theta}{\cos. \theta - \sqrt{-1} \sin. \theta} = e^{\theta \sqrt{-1}} \div e^{-\theta \sqrt{-1}}.$$

$$\therefore \frac{1 + \sqrt{-1} \tan. \theta}{1 - \sqrt{-1} \tan. \theta} = e^{2\theta \sqrt{-1}} \dots (48.)$$

Also adding (46) and (47) we obtain

$$2 \cos. \theta = e^{\theta \sqrt{-1}} + e^{-\theta \sqrt{-1}} \dots (49)$$

and subtracting (47) from (46) we obtain

$$2 \sqrt{-1} \sin. \theta = e^{\theta \sqrt{-1}} - e^{-\theta \sqrt{-1}} \dots (50)$$

(52.) To obtain an expression for θ in terms of $\tan. \theta$ and its powers.

Since from equation (48)

$$\frac{2\theta \sqrt{-1}}{e} = \frac{1 + \sqrt{-1} \tan. \theta}{1 - \sqrt{-1} \tan. \theta}$$

Taking logarithms on both sides.

$$2\theta \sqrt{-1} = \log. (1 + \sqrt{-1} \tan. \theta) - \log. (1 - \sqrt{-1} \tan. \theta)$$

$$\frac{\sqrt{-1} \tan. \theta}{1} - \frac{(\sqrt{-1} \tan. \theta)^2}{2} + \frac{(\sqrt{-1} \tan. \theta)^3}{3} - \&c.$$

$$- \left\{ - \frac{\sqrt{-1} \tan. \theta}{1} - \frac{(\sqrt{-1} \tan. \theta)^2}{1 \cdot 2} - \frac{(\sqrt{-1} \tan. \theta)^3}{3} \dots \right\}$$

$$= 2 \left\{ \frac{\sqrt{-1} \tan. \theta}{1} + \frac{(\sqrt{-1} \tan. \theta)^3}{3} + \frac{(\sqrt{-1} \tan. \theta)^5}{5} + \dots \right\}$$

$$= 2 \sqrt{-1} \left\{ \tan. \theta - \frac{\tan. \theta^3}{3} + \frac{\tan. \theta^5}{5} - \&c \right\}$$

$$\therefore \theta = \tan. \theta - \frac{\tan. \theta^3}{3} + \frac{\tan. \theta^5}{5} - \&c.$$

or if, $\theta = \tan.^{-1} x$. Then

$$\tan.^{-1} x = x - \frac{x^3}{3} + \frac{x^5}{5} - \&c. \dots (51)$$

If x be positive, this value of $\tan.^{-1} x$ is, of course, that value which is less than $\frac{\pi}{2}$. Hence, if we wish to express all the values of $\tan.^{-1} x$ in terms of x , we ought to use the formula

$$\tan.^{-1} x = m \pi + \left\{ x - \frac{x^3}{3} + \frac{x^5}{5} - \&c. \right\}$$

Where m is any positive or negative integer.

(53.) To calculate the Value of π . i. e. the ratio which the Arc of a Semicircle bears to its Radius.

Let a be the arc to radius r subtending an angle of 45° . Then since the semicircle subtends an angle of 180° , $\frac{\pi}{4} = \frac{a}{r}$. Hence $\frac{\pi}{4}$ is the circular measure of an angle of 45° .

$$\therefore \tan. \frac{\pi}{4} = 1$$

$$\text{and} \quad \frac{\pi}{4} = \tan.^{-1} 1$$

Hence, from equation (51).

$$\frac{\pi}{4} = \tan.^{-1} 1 = 1 - \frac{1}{3} + \frac{1}{5} - \frac{1}{7} + \dots$$

and from this we might obtain the numerical value of π . But it is much more expeditiously determined in the following manner,

$$2 \tan.^{-1} \frac{1}{5} = \tan.^{-1} \frac{\frac{2}{5}}{1 - \frac{1}{25}} = \tan.^{-1} \frac{5}{12}$$

$$4 \tan.^{-1} \frac{1}{5} = 2 \tan.^{-1} \frac{5}{12} = \tan.^{-1} \frac{\frac{5}{6}}{1 - \frac{25}{144}} = \tan.^{-1} \frac{120}{119}$$

$$\tan.^{-1} \frac{120}{119} - \tan.^{-1} 1 = \tan.^{-1} \frac{\frac{120}{119} - 1}{1 + \frac{120}{119}} = \tan.^{-1} \frac{1}{239}$$

$$\therefore \tan.^{-1} 1 = \tan.^{-1} \frac{120}{119} - \tan.^{-1} \frac{1}{239} \\ = 4 \tan.^{-1} \frac{1}{5} - \tan.^{-1} \frac{1}{239}$$

$$\therefore \frac{\pi}{4} = 4 \tan.^{-1} \frac{1}{5} - \tan.^{-1} \frac{1}{239} \\ = 4 \left\{ \frac{1}{5} - \frac{1}{3} \cdot \frac{1}{5^3} + \frac{1}{5} \cdot \frac{1}{5^5} - \&c. \right\} \\ - \left\{ \frac{1}{239} - \frac{1}{3} \cdot \frac{1}{239^3} + \frac{1}{5} \cdot \frac{1}{239^5} - \&c. \right\}$$

The expression it will be observed consists of the difference between two series. Their values can be calculated separately, and the value of π . be found from thence in the following manner:

(1.) We obtain the value of $\frac{1}{5} - \frac{1}{3} \cdot \frac{1}{5^3} + \frac{1}{5} \cdot \frac{1}{5^5} - \&c.$
to the 12th place of decimals in the following manner.

$$\frac{1}{5} = \cdot 2 \\ \frac{1}{5^3} = \cdot 008$$

$$\frac{1}{5^4} = \cdot 00032$$

$$\frac{1}{5^7} = \cdot 0000128$$

$$\frac{1}{5^9} = \cdot 000000512$$

$$\frac{1}{5^{11}} = \cdot 00000002048$$

$$\frac{1}{5^{13}} = \cdot 000000000819$$

$$\frac{1}{5^{15}} = \cdot 000000000032$$

$$\frac{1}{5^{17}} = \cdot 000000000001.$$

From these we can easily obtain, first, the negative, and then the positive part of the expression; and subtracting we obtain the whole value required.

$$\frac{1}{3} \cdot \frac{1}{5^4} = \cdot 002666 \quad 666666$$

$$\frac{1}{7} \cdot \frac{1}{5^7} = \cdot 000001 \quad 828571$$

$$\frac{1}{11} \cdot \frac{1}{5^{11}} = \cdot 000000 \quad 001861$$

$$\frac{1}{15} \cdot \frac{1}{5^{15}} = \cdot 000000 \quad 000002$$

$$\cdot 002668 \quad 497100$$

Again

$$\frac{1}{5} = \cdot 2.$$

$$\frac{1}{5} \cdot \frac{1}{5^5} = \cdot 000064$$

$$\frac{1}{9} \cdot \frac{1}{5^9} = \cdot 000000 \quad 056888$$

$$\frac{1}{13} \cdot \frac{1}{5^{13}} = \cdot 000000 \quad 000063.$$

$$\cdot 200064 \quad 056951$$

$$\cdot 002668 \quad 497100$$

$$\cdot 197395 \quad 559851$$

$$\cdot 789582 \quad 299404$$

Which is the value of decimals $4 \left\{ \frac{1}{5} - \frac{1}{9} \cdot \frac{1}{5^3} + \&c. \right\}$ to 12 places.

(2.) To calculate the value of $\left\{ \frac{1}{239} - \frac{1}{3} \cdot \frac{1}{239^3} + \dots \right\}$

$$\frac{1}{239} = \cdot 004184 \quad 100418$$

$$\frac{1}{239^3} = \cdot 000000 \quad 073249$$

$$\frac{1}{239^2} = \cdot 000000 \quad 000001$$

$$\therefore \frac{1}{239} = \cdot 004184 \quad 100418$$

$$\frac{1}{3} \cdot \frac{1}{239^3} = \cdot 000000 \quad 024416$$

$$\frac{1}{3} \cdot \frac{1}{239^3} = \cdot 004184 \quad 076002$$

Which is the value of $\left\{ \frac{1}{239} - \frac{1}{3} \cdot \frac{1}{239^3} + \dots \right\}$ to 12 places of decimals.

If we subtract this from the result last found we shall obtain $\frac{\pi}{4}$, and \therefore multiplying that difference by 4, we shall obtain the value of π required. Thus,

$$\begin{array}{r} \cdot 789582 \quad 239404 \\ \cdot 004184 \quad 076002 \\ \hline \cdot 785398 \quad 163402 \\ \hline 4 \\ \hline 3 \cdot 141592 \quad 653608 \end{array}$$

The calculation is carried to 12 places of decimals, but is not trustworthy beyond the first 10.

Hence (to 10 places of decimals)

$$\pi = 3 \cdot 1415926536$$

If we had wanted to obtain the value of π to a larger number of places of decimals, we should have had to carry the calculations throughout to a correspondingly greater extent.

Thus, we can show that

$$\pi = 3 \cdot 141592653589794$$

We can very conveniently apply de Moivre's formula to the solution of Binomial Equations, *i.e.*, equations of the form $x^n + a = 0$

(54.) *To explain what we mean by the roots of a Binomial Equation.*

If we take the case $x^n + a = 0$, and if a be b^n , then the equation becomes $0^n + b^n = 0$, and if $x = by$. $x^n = b^n y^n$, and then the equation becomes

$$y^n + 1 = 0$$

where the 1 may be either positive or negative. It might seem at first sight that this has only one root, *viz.*, unity, but to conclude so would an error, as a little consideration will make quite plain; for take the case

$$x^2 - 1 = 0$$

Then x is either $+1$ or -1 ; *i.e.*, has two values. And if we take the case

$$x^3 - 1 = 0$$

Then because

$$x^3 - 1 = (x - 1)(x^2 + x + 1)$$

we shall have

$$(x - 1)(x^2 + x + 1) = 0$$

whence x will have values corresponding to

$$\begin{array}{l} x - 1 = \\ x^2 + x + 1 = 0 \end{array}$$

From the former of them we find that $x = 1$,
and from the second that

$$x^3 + x + \frac{1}{4} = -\frac{3}{4}$$

$$\therefore x = \frac{-1 \pm \sqrt{-3}}{2}$$

And hence x has the three values.

$$1. \quad \frac{-1 + \sqrt{-3}}{2} \text{ and } \frac{-1 - \sqrt{-3}}{2}$$

which are three roots of the binomial equation

$$x^3 - 1 = 0$$

And hence we manifestly have that the roots of

$$x^3 - a^3 = 0$$

are

$$a. \quad \frac{-1 + \sqrt{-3}}{2} a \text{ and } \frac{-1 - \sqrt{-3}}{2} a.$$

In like manner

$$x_n + 1 = 0$$

has n different roots, which indeed follows from the general principle, that every equation of the n^{th} degree has n different roots, real or imaginary.

(55.) To find the roots of the Equation, $x^n + 1 = 0$.

Since, $\cos. (2p + 1)\pi + \sqrt{-1} \sin. (2p + 1)\pi = -1$
whatever be the value of p , provided it be an integer. And since
 $x^n = -1$

we must have

$$x^n = \cos. (2p + 1)\pi + \sqrt{-1} \sin. (2p + 1)\pi.$$

$$\therefore a = (\cos. \frac{2p + 1}{n}\pi + \sqrt{-1} \sin. \frac{2p + 1}{n}\pi)^{\frac{1}{n}}$$

$$\text{or } x = \cos. \frac{2p + 1}{n}\pi + \sqrt{-1} \sin. \frac{2p + 1}{n}\pi.$$

Hence $\cos. \frac{2p + 1}{n}\pi + \sqrt{-1} \sin. \frac{2p + 1}{n}\pi$ is a root of the binomial equation whatever integral value we may give to p .

We shall prove that there are n different values of this formula, corresponding to the different values of p , viz.: 0, 1, 2, 3, . . . $n - 1$, and that there are no more than n values.

(a). Let p and q be two values, each $< n$; and if possible let

$$\cos. \frac{2p + 1}{n}\pi + \sqrt{-1} \sin. \frac{2p + 1}{n}\pi = \cos. \frac{2q + 1}{n}\pi + \sqrt{-1} \sin. \frac{2q + 1}{n}\pi.$$

Hence equating possible and impossible terms,

$$\cos. \frac{2p + 1}{n}\pi = \cos. \frac{2q + 1}{n}\pi.$$

$$\sin. \frac{2p + 1}{n}\pi = \sin. \frac{2q + 1}{n}\pi.$$

Hence the angles must differ by some multiple of 2π , say by $k \times 2\pi$.

$$\therefore \frac{2p+1}{n} \pi = \frac{2q+1}{n} \pi \pm 2k\pi.$$

$$\therefore p - q = kn. \text{ a multiple of } n,$$

and therefore either p or q must be greater than n . Hence all the values of x which correspond to the values of $p < n$, viz., 0, 1, 2, 3, . . . $n-1$, are different from each other.

(b) Again, if we give p a value r greater than n , then the corresponding value of x will be the same as one of those which is given by some value of p , that is less than n , as for instance q .

For suppose $p = kn + q$.

where k is a whole number, and q is less than n .

$$\text{Then, } \cos. \frac{2p+1}{n} \pi + \sqrt{-1} \sin. \frac{2p+1}{n} \pi =$$

$$\cos. \frac{2kn + 2q + 1}{n} \pi + \sqrt{-1} \sin. \frac{2kn + 2q + 1}{n} \pi =$$

$$\cos. \left(2k\pi + \frac{2q+1}{n} \pi \right) + \sqrt{-1} \sin. \left(2k\pi + \frac{2q+1}{n} \pi \right) =$$

$$\cos. \frac{2q+1}{n} \pi + \sqrt{-1} \sin. \frac{2q+1}{n} \pi.$$

Hence by giving to p , successively the values of 0.1.2.3 $n-1$, in the formula

$$x = \cos. \frac{2p+1}{n} \pi + \sqrt{-1} \sin. \frac{2p+1}{n} \pi.$$

we obtain all the roots of the Equation

$$x^n + 1 = 0.$$

Thus. To find the roots of the Equation

$$x^6 + 1 = 0.$$

the roots are given by the formula

$$x = \cos. \frac{2p+1}{6} \pi + \sqrt{-1} \sin. \frac{2p+1}{6} \pi.$$

and are therefore respectively

$$\cos. \frac{\pi}{6} + \sqrt{-1} \sin. \frac{\pi}{6} = \cos. 30^\circ + \sqrt{-1} \sin. 30^\circ = \frac{\sqrt{3} + \sqrt{-1}}{2}$$

$$\cos. \frac{3\pi}{6} + \sqrt{-1} \sin. \frac{3\pi}{6} = \cos. 90^\circ + \sqrt{-1} \sin. 90^\circ = \sqrt{-1}$$

$$\cos. \frac{5\pi}{6} + \sqrt{-1} \sin. \frac{5\pi}{6} = \cos. 150^\circ + \sqrt{-1} \sin. 150^\circ = \frac{-\sqrt{3} + \sqrt{-1}}{2}$$

$$\cos. \frac{7\pi}{6} + \sqrt{-1} \sin. \frac{7\pi}{6} = \cos. 210^\circ + \sqrt{-1} \sin. 210^\circ = \frac{-\sqrt{3} - \sqrt{-1}}{2}$$

$$\cos. \frac{9\pi}{6} + \sqrt{-1} \sin. \frac{9\pi}{6} = \cos. 270^\circ + \sqrt{-1} \sin. 270^\circ = -\sqrt{-1}$$

$$\cos. \frac{11\pi}{6} + \sqrt{-1} \sin. \frac{11\pi}{6} = \cos. 330^\circ + \sqrt{-1} \sin. 330^\circ = \frac{\sqrt{3} - \sqrt{-1}}{2}$$

Similarly if we have to find the roots of the Equation

$$x^n - 1 = 0.$$

$$\text{Since } \cos. 2p\pi + \sqrt{-1} \sin. 2p\pi = 1$$

we shall have all the roots given the formula

$$x = \cos. \frac{2p\pi}{n} + \sqrt{-1} \sin. \frac{2p\pi}{n}.$$

(56.) To resolve $x^{2n} - 1$ into factors.*

If $\alpha_0, \alpha_1, \alpha_2, \dots, \alpha_{2n-1}$ are the roots of the Equation $x^{2n} - 1 = 0$. Then

$$x^{2n} - 1 = (x - \alpha_0) (x - \alpha_1) (x - \alpha_2) \dots (x - \alpha_{2n-1}).$$

Now all the roots of the Equation are included in the expression

$$\cos. \frac{2p\pi}{2n} + \sqrt{-1} \sin. \frac{2p\pi}{2n}.$$

If then we suppose $p < n$, and α_p be the corresponding root

$$\alpha_p = \cos. \frac{p\pi}{n} + \sqrt{-1} \sin. \frac{p\pi}{n}.$$

Now observe that there will be another root α_{2n-p} , which will equal

$$\begin{aligned} & \cos. \frac{2n-p\pi}{n} + \sqrt{-1} \sin. \frac{2n-p\pi}{n} \\ &= \cos. \left(2\pi - \frac{p\pi}{n} \right) + \sqrt{-1} \sin. \left(2\pi - \frac{p\pi}{n} \right). \end{aligned}$$

Hence

$$\alpha_{2n-p} = \cos. \frac{p\pi}{n} - \sqrt{-1} \sin. \frac{p\pi}{n}.$$

where $p < n$, and so we have a pair of factors $x - \alpha_p$ and $x - \alpha_{2n-p}$, which are

$$\begin{aligned} & \text{equal to } \left(x - \cos. \frac{p\pi}{n} - \sqrt{-1} \sin. \frac{p\pi}{n} \right) \left(x - \cos. \frac{p\pi}{n} + \sqrt{-1} \sin. \frac{p\pi}{n} \right) \\ &= x^2 - 2x \cos. \frac{p\pi}{n} + 1, \text{ by multiplication.} \end{aligned}$$

Where p may take any value, $1 \cdot 2 \cdot 3 \dots n - 1$. It will be observed that

$$\begin{aligned} x - \alpha_0 &= x - 1. \\ x - \alpha_n &= x + 1. \end{aligned} \therefore (x - \alpha_0) (x - \alpha_n) = x^2 - 1.$$

and

$$\begin{aligned} \therefore x^{2n} - 1 &= (x^2 - 1) \left(x^2 - 2x \cos. \frac{\pi}{n} + 1 \right) \\ & \left(x^2 - 2x \cos. \frac{2\pi}{n} + 1 \right) \dots \left(x^2 - 2x \cos. \frac{(n-1)\pi}{n} + 1 \right) \end{aligned} \quad (52)$$

Corol. Hence,

$$x^{2n} - 1 = (x^2 - 1) \left(x^2 - 2ax \cos. \frac{\pi}{n} + a^2 \right) \dots$$

* If $\alpha_1, \alpha_2, \alpha_3 \dots \alpha_n$ are the roots of the equation, $x^n - 1 = 0$ Then

$$x^n - 1 = (x - \alpha_1) (x - \alpha_2) (x - \alpha_3) \dots (x - \alpha_n) \text{ for all values of } x.$$

For, if we actually divide $x^n - 1$ by $x - \alpha_1$, we shall obtain a remainder $\alpha_1^n - 1$; now, since α_1 is a root of the equation $x^n - 1 = 0$, we have $\alpha_1^n - 1 = 0$, i. e. $x^n - 1$ is divisible by $x - \alpha_1$, or $x - \alpha_1$ is a factor of $x^n - 1$. Similarly $x - \alpha_2, x - \alpha_3 \dots x - \alpha_n$ are each factors of $x^n - 1$, and since $x^n - 1$ cannot have more than n factors, it is plain that

$$x^n - 1 = (x - \alpha_1) (x - \alpha_2) \dots (x - \alpha_n).$$

$$+ \left(x - 2 a x \cos. \frac{n-1}{n} \pi + a^2 \right) \dots (53)$$

For since

$$y^{2n} - 1 = (y^2 - 1) \left(y^2 - 2 y \cos. \frac{\pi}{n} + 1 \right) \left(y^2 - 2 y \cos. \frac{2\pi}{n} + 1 \right) \dots \left(y^2 - 2 y \cos. \frac{n-1}{n} \pi + 1 \right)$$

Let $y = \frac{x}{a}$.

$$\therefore \frac{x^{2n}}{a^{2n}} - 1 = \left(\frac{x^{2n}}{a^{2n}} - 1 \right) \left(\frac{x^2}{a^2} - 2 \frac{x}{a} \cos. \frac{\pi}{n} + 1 \right) \dots \left(\frac{x^2}{a^2} - 2 \frac{x}{a} \cos. \frac{n-1}{n} \pi + 1 \right)$$

Now as there are n factors, if we clear the equation of fractions, multiplying the right-hand side by a^{2n} will be the same thing as multiplying each factor by a^2 . Hence:—

$$x^{2n} - a^{2n} = \left(x^2 - a^2 \right) \left(x^2 - 2 a x \cos. \frac{\pi}{n} + a^2 \right) \dots \left(x^2 - 2 a x \cos. \frac{n-1}{n} \pi + a^2 \right)$$

By a precisely similar process we shall be able to prove that

$$x^{2n} + 1 = \left(x^2 - 2 x \cos. \frac{\pi}{2n} + 1 \right) \left(x^2 - 2 x \cos. \frac{3\pi}{2n} + 1 \right) \dots \dots \left(x^2 - 2 x \cos. \frac{2n-1}{2n} \pi + 1 \right) \dots (54).$$

And hence

$$x^{2n} + a^{2n} = \left(x^2 - 2 a x \cos. \frac{\pi}{2n} + a^2 \right) \left(x^2 - 2 a x \cos. \frac{3\pi}{2n} + a^2 \right) \dots \dots \left(x^2 - 2 a x \cos. \frac{2n-1}{2n} \pi + a^2 \right) \dots (55).$$

(57.) To prove that $2^{2n-1} \sin^2 \frac{\pi}{2n} \sin^2 \frac{2\pi}{2n} \sin^2 \frac{3\pi}{2n} \dots \sin^2 \frac{n-1}{2n} \pi = 2n$.

We have by actual division—

$$\frac{x^{2n} - 1}{x - 1} = x^{2n-1} + x^{2n-2} + x^{2n-3} + \dots + x + 1.$$

Hence, when $x = 1$. The limiting value of $\frac{x^{2n} - 1}{x - 1}$ will equal $1 + 1 + 1 + \dots + 1 + 1$ to $2n$ terms $= 2n$.

Again by the last article—

$$\frac{x^{2n} - 1}{x - 1} = (x + 1) \left(x^2 - 2 x \cos. \frac{\pi}{n} + 1 \right) \left(x^2 - 2 x \cos. \frac{2\pi}{n} + 1 \right) \dots \dots \left(x^2 - 2 x \cos. \frac{n-1}{n} \pi + 1 \right)$$

and hence when $x = 1$. The limiting value of $\frac{x^{2n} - 1}{x - 1}$.

is $2 \left(2 - 2 \cos. \frac{\pi}{n} \right) \left(2 - 2 \cos. \frac{2\pi}{n} \right) \dots \left(2 - 2 \cos. \frac{n-1\pi}{n} \right)$

and therefore these two limiting values are equal, and

$$\begin{aligned} 2n &= 2^n \left(1 - \cos. \frac{\pi}{n} \right) \left(1 - \cos. \frac{2\pi}{n} \right) \dots \left(1 - \cos. \frac{n-1\pi}{n} \right) \\ &= 2^n \times 2 \sin. \frac{2\pi}{2n} 2 \sin.^2 \frac{2\pi}{2n} 2 \sin.^3 \frac{3\pi}{2n} \dots 2 \sin.^{n-1} \frac{n-1\pi}{2n} \\ &= 2^n \times 2^{n-1} \sin. \frac{2\pi}{2n} \cdot \sin.^2 \frac{2\pi}{2n} \cdot \sin.^3 \frac{3\pi}{2n} \dots \sin.^{n-1} \frac{n-1\pi}{2n} \\ &= 2^{2n-1} \sin.^2 \frac{\pi}{2n} \sin.^2 \frac{2\pi}{2n} \sin.^3 \frac{3\pi}{2n} \dots \sin.^{n-1} \frac{n-1\pi}{2n} \dots \quad (56) \end{aligned}$$

In the same manner we may prove that

$$2 = 2^{2n} \sin.^2 \frac{\pi}{4n} \sin.^2 \frac{3\pi}{4n} \sin.^2 \frac{5\pi}{4n} \dots \sin.^2 \frac{2n-1\pi}{4n} \dots \quad (57.)$$

For

$$\begin{aligned} x^{2n} + 1 &= \left(x^2 - 2x \cos. \frac{\pi}{2n} + 1 \right) \left(x^2 - 2x \cos. \frac{3\pi}{2n} + 1 \right) \dots \\ &\quad \left(x^2 - 2x \cos. \frac{2n-1\pi}{2n} + 1 \right) \end{aligned}$$

Let, $x = 1$, and then observing that

$$\begin{aligned} x^2 - 2x \cos. \frac{p\pi}{2n} + 1 &= 2 \left(1 - \cos. \frac{p\pi}{2n} \right) \\ &= 2^2 \sin.^2 \frac{p\pi}{4n}. \end{aligned}$$

We shall obtain the required formula.

(58). To express $\sin. x$ in a series of factors.

The above formula (53) for the factors of $x^{2n} - a^{2n}$ is true for all values of x and a .

Suppose $x = 1 + \frac{z}{2n}$ and $a = 1 - \frac{z}{2n}$.

$$\begin{aligned} \text{Then } x^2 - 2ax \cos. \frac{p\pi}{n} + a^2 &= 1 + \frac{z}{n} + \frac{z^2}{4n^2} - 2 \left(1 - \frac{z^2}{4n^2} \right) \cos. \frac{p\pi}{n} \\ &\quad + 1 - \frac{z}{n} + \frac{z^2}{4n^2} \\ &= 2 \left(1 + \frac{z^2}{4n^2} \right) - 2 \left(1 - \frac{z^2}{4n^2} \right) \cos. \frac{p\pi}{n} \\ &= 2 \left(1 - \cos. \frac{p\pi}{n} \right) + 2 \frac{z^2}{4n^2} \left(1 + \cos. \frac{p\pi}{n} \right) \\ &= 4 \sin.^2 \frac{p\pi}{2n} + 4 \frac{z^2}{4n^2} \cos.^2 \frac{p\pi}{2n} \\ &= 4 \sin.^2 \frac{p\pi}{2n} \cdot \left(1 + \frac{z^2}{4n^2} \cotan.^2 \frac{p\pi}{2n} \right) \end{aligned}$$

Hence the factors on the right-hand side of Equation (53) will be equal to

$$\begin{aligned} & \frac{2z}{n} \cdot 4 \sin^2 \frac{\pi}{2n} \left(1 + \frac{z^2}{4n^2} \cotan^2 \frac{\pi}{2n} \right) 4 \sin^2 \frac{2\pi}{2n} \times \\ & \left(1 + \frac{z^2}{4n^2} \cotan^2 \frac{\pi}{2n} \right) \dots 4 \sin^2 \frac{(n-1)\pi}{2n} \left(1 + \frac{z^2}{4n^2} \cotan^2 \frac{n-1\pi}{2n} \right) \\ & = \frac{2z}{n} \cdot 4 \sin^2 \frac{\pi}{2n} \cdot 4 \sin^2 \frac{2\pi}{2n} \cdot 4 \sin^2 \frac{3\pi}{2n} \dots \cdot 4 \sin^2 \frac{n-1\pi}{2n} \\ & \times \left(1 + \frac{z^2}{4n^2} \cotan^2 \frac{\pi}{2n} \right) \left(1 + \frac{z^2}{4n^2} \cotan^2 \frac{2\pi}{2n} \right) \dots \left(1 + \frac{z^2}{4n^2} \cotan^2 \frac{n-1\pi}{2n} \right) \\ & = \frac{z}{n} \cdot 2^{2n-1} \sin^2 \frac{\pi}{2n} \cdot \sin^2 \frac{2\pi}{2n} \dots \sin^2 \frac{n-1\pi}{2n} \times \\ & \left(1 + \frac{z^2}{4n^2} \cotan^2 \frac{\pi}{2n} \right) \left(1 + \frac{z^2}{4n^2} \cotan^2 \frac{2\pi}{2n} \right) \dots \left(1 + \frac{z^2}{4n^2} \cotan^2 \frac{n-1\pi}{2n} \right) \\ & = 2z \left(1 + \frac{z^2}{4n^2} \cotan^2 \frac{\pi}{2n} \right) \left(1 + \frac{z^2}{4n^2} \cotan^2 \frac{2\pi}{2n} \right) \dots \left(1 + \frac{z^2}{4n^2} \cotan^2 \frac{n-1\pi}{2n} \right) \dots (a). \end{aligned}$$

Since by the last article

$$2^{2n-1} \sin^2 \frac{\pi}{2n} \dots \sin^2 \frac{n-1\pi}{2n} = 2n.$$

Again

$$x^{2n} - a^{2n} = \left(1 + \frac{z}{2n} \right)^{2n} - \left(1 - \frac{z}{2n} \right)^{2n},$$

and expanding each by the Binomial Theorem.

$$\begin{aligned} x^{2n} - a^{2n} &= \left(1 + 2n \frac{z}{2n} + \frac{2n \cdot 2n-1}{1 \cdot 2} \cdot \frac{z^2}{4n^2} + \frac{2n \cdot 2n-1 \cdot 2n-2}{1 \cdot 2 \cdot 3} \right. \\ & \quad \left. \frac{z^3}{8n^3} + \dots \right) \\ & - \left(1 - 2n \frac{z}{2n} + \frac{2n \cdot 2n-1}{1 \cdot 2} \cdot \frac{z^2}{4n^2} - \frac{2n \cdot 2n-1 \cdot 2n-2}{1 \cdot 2 \cdot 3} \right. \\ & \quad \left. \frac{z^3}{8n^3} + \dots \right) \\ & = 2 \left\{ 2n \frac{z}{2n} + \frac{2n \cdot 2n-1 \cdot 2n-2}{1 \cdot 2 \cdot 3} \frac{z^3}{8n^3} + \dots \right\} \dots (b) \end{aligned}$$

Now (a) and (b) are equal under all circumstances, and therefore their limiting values when $2n$ becomes very large are equal, i.e. when $\frac{1}{2n} \frac{2}{2n} \dots \frac{p}{2n}$ are each equal to zero.

$$\text{Now since } \frac{z^2}{4n^2} \cotan^2 \frac{p\pi}{2n} = \frac{z^2}{4n^2} \cdot \frac{1}{\tan^2 \frac{p\pi}{2n}}$$

$$= \frac{z^2}{p^2 \pi^2} \cdot \frac{p^2 \pi^2}{4n^2} \cdot \frac{p\pi}{\tan^2 \frac{p\pi}{2n}} = \frac{z^2}{p^2 \pi^2} \cdot \left\{ \frac{p\pi}{\tan \frac{p\pi}{2n}} \right\}^2.$$

But in the limit when $2n$ is very large $\frac{p\pi}{2n} = 0$

And the limit of $\frac{\tan. \theta}{\theta}$ when $\theta = 0$ is unity.

Hence the limiting value of $\frac{\frac{p\pi}{2n}}{\tan. \frac{p\pi}{2n}} = 1$.

And therefore the limiting value of $\frac{z^2}{4n^2} \cotan.^2 \frac{p\pi}{2n} = \frac{z^2}{p^2 \pi^2}$

Hence the limiting value of the expression (a) is

$$2z \left\{ 1 + \frac{z^2}{\pi^2} \right\} \left\{ 1 + \frac{z^2}{4\pi^2} \right\} \left\{ 1 + \frac{z^2}{9\pi^2} \right\} \dots -$$

Again since (b) can be written

$$2z \left\{ 1 + \frac{\left(1 - \frac{1}{2n}\right) \left(1 - \frac{2}{2n}\right)}{1.2.3} z^2 + \frac{\left(1 - \frac{1}{2n}\right) \dots \left(1 - \frac{4}{2n}\right)}{1.2.3.4.5} z^4 \dots \right\}$$

The limiting value of (b) is

$$2z \left(1 + \frac{z^2}{1.2.3} + \frac{z^4}{1.2.3.4.5} + \dots \right)$$

Hence,

$$1 + \frac{z^2}{1.2.3} + \frac{z^4}{1.2.3.4.5} + \dots = \left(1 + \frac{z}{\pi}\right) \left(1 + \frac{z^2}{2^2 \pi^2}\right) \dots$$

or writing $-z^2$ for z^2 , we have—

$$1 - \frac{z^2}{1.2.3} + \frac{z^4}{1.2.3.4.5} = \left(1 - \frac{z^2}{\pi^2}\right) \left(1 - \frac{z^2}{2^2 \pi^2}\right) \left(1 - \frac{z^2}{3^2 \pi^2}\right) \dots$$

Multiply both sides by z , and we obtain

$$z - \frac{z^3}{1.2.3} + \frac{z^5}{1.2.3.4.5} - \dots = z \left(1 - \frac{z^2}{\pi^2}\right) \left(1 - \frac{z^2}{2^2 \pi^2}\right) \dots$$

But, $\sin. z = z - \frac{z^3}{1.2.3} + \frac{z^5}{1.2.3.4.5} - \dots$ &c.

$$\therefore \sin. z = z \left(1 - \frac{z^2}{\pi^2}\right) \left(1 - \frac{z^2}{2^2 \pi^2}\right) \left(1 - \frac{z^2}{3^2 \pi^2}\right) \dots \dots (58)$$

which is the expression required.

In the same manner, by taking $x^{2n} + a^{2n}$ and its factors from formula (55), we can obtain $\cos. x$ in factors. Thus,

$$\text{Let } x = 1 + \frac{z}{2n} \quad a = 1 - \frac{z}{2n}.$$

$$\therefore x^{2n} + a^{2n} = 2 \left\{ 1 + \frac{2n.2n-1}{1.2} \frac{z^2}{4n^2} + \frac{2n.2n-1}{1.2.3.4} \frac{z^4}{16n^4} + \dots \right\}$$

And as before the limiting value of

$$x^{2n} + a^{2n} \text{ is } 2 \left(1 + \frac{z}{1.2} + \frac{z^4}{1.2.3.4} + \dots \right). \quad (a)$$

Again, since

$$\begin{aligned} x^2 - 2ax \cos. \frac{2p+1}{2n} \pi + a^2 &= 2 \left(1 + \frac{z^2}{4n^2} \right) - 2 \left(1 - \frac{z^2}{4n^2} \right) \frac{\cos. 2p+1}{2n} \pi \\ &= 4 \sin.^2 \frac{2p+1}{4n} \pi \left\{ 1 + \frac{z^2}{4n^2} \cotan.^2 \frac{2p+1}{4n} \pi \right\} \end{aligned}$$

The factors of $x^{2n} + a^{2n}$ become

$$\begin{aligned} 2^{2n} \sin.^2 \frac{\pi}{4n} \sin.^2 \frac{3\pi}{4n} \sin.^2 \frac{5\pi}{4n} \dots \sin.^2 \frac{2n-1}{4n} \pi \times \\ \left(1 + \frac{z^2}{4n^2} \cotan.^2 \frac{\pi}{4n} \right) \left(1 + \frac{z^2}{4n^2} \cotan.^2 \frac{3\pi}{4n} \right) \left(1 + \frac{z^2}{4n^2} \cotan.^2 \frac{5\pi}{4n} \right) \dots \\ = 2 \left(1 + \frac{z^2}{4n^2} \cotan.^2 \frac{\pi}{4n} \right) \left(1 + \frac{z^2}{4n^2} \cotan.^2 \frac{3\pi}{4n} \right) \left(1 + \frac{z^2}{4n^2} \cotan.^2 \frac{5\pi}{4n} \right) \dots \end{aligned}$$

$$\text{Now, } \frac{z^2}{4n^2} \cotan.^2 \frac{2p+1}{4n} \pi = \frac{4z^2}{(2p+1)\pi^2} \left\{ \frac{\frac{2p+1}{4n} \pi}{\tan \frac{2p+1}{4n} \pi} \right\}^2$$

The limiting value of which is $\frac{4z^2}{2p+1}\pi^2$

Hence the limiting value of $x^{2n} + a^{2n}$ derived from the expression for its factors will be

$$2 \left(1 + \frac{4z^2}{\pi^2} \right) \left(1 + \frac{4z^2}{3^2 \pi^2} \right) \left(1 + \frac{4z^2}{5^2 \pi^2} \right) \dots \quad (b)$$

And the two limiting values (a) and (b) are equal. Hence

$$1 + \frac{z^2}{1.2} + \frac{z^4}{1.2.3.4} + \dots = \left(1 + \frac{4z^2}{\pi^2} \right) \left(1 + \frac{4z^2}{3^2 \pi^2} \right) \left(1 + \frac{4z^2}{5^2 \pi^2} \right) \dots$$

Write $-z^2$ for x^2 (as before) and we obtain

$$1 - \frac{z^2}{1.2} + \frac{z^4}{1.2.3.4} - \&c. = \left(1 - \frac{4z^2}{\pi^2} \right) \left(1 - \frac{4z^2}{3^2 \pi^2} \right) \left(1 - \frac{4z^2}{5^2 \pi^2} \right)$$

$$\therefore \cos. z = \left(1 - \frac{4z^2}{\pi^2} \right) \left(1 - \frac{4z^2}{3^2 \pi^2} \right) \left(1 - \frac{4z^2}{5^2 \pi^2} \right) \dots \quad (59)$$

The series given in the preceding articles are sufficient for our purpose. We now proceed to explain the method of calculating trigonometrical tables.

The Tables of the trigonometrical functions are of two kinds. (1.) Those which give the numerical values of the sines, cosines of the angles, &c. (2.) Those which give the values of the logarithms of the sines, cosines, &c., of the angles. The former are called Tables of natural sines, the latter, Tables of logarithmic sines.

We shall explain the method by which each of these tables is calculated.

(59.) To show that $\sin. \theta$ is less than θ and greater than $\theta - \frac{\theta^3}{4}$

$$\text{For } \sin. \theta = 2 \sin. \frac{\theta}{2} \cos. \frac{\theta}{2} = 2 \sin. \frac{\theta}{2} \left(1 - \sin.^2 \frac{\theta}{2} \right)$$

Now $1 - \sin.^2 \frac{\theta}{2}$ must be less than 1.

$$\therefore \sin. \theta < 2 \sin. \frac{\theta}{2}$$

$$\therefore \sin. \frac{\theta}{2} < 2 \sin. \frac{\theta}{2^2}$$

$$\therefore \sin. \frac{\theta}{2^2} < 2 \sin. \frac{\theta}{2^3}$$

$$\sin. \frac{\theta}{2^{n-1}} < 2 \sin. \frac{\theta}{2^n}$$

Hence $\sin. \theta < 2^n \sin. \frac{\theta}{2^n}$ whatever n may be.

$$\frac{\sin. \theta}{\theta} < \frac{\sin. \frac{\theta}{2^n}}{\frac{\theta}{2^n}} \text{ for all values of } n, \text{ however large } n \text{ may be; and there-}$$

fore, in the limiting case, when n is infinitely large, & $\therefore 2^n$ infinitely large, or when $\frac{\theta}{2^n} = 0$.

$$\text{But in this case } \frac{\sin. \frac{\theta}{2^n}}{\frac{\theta}{2^n}} = 1.$$

$$\therefore \frac{\sin. \theta}{\theta} < 1.$$

$$\text{or } \sin. \theta < \theta$$

In like manner we can easily prove that $\tan. \theta > \theta$

$$\text{For } \tan. \theta = \frac{2 \tan. \frac{\theta}{2}}{1 - \tan.^2 \frac{\theta}{2}}$$

$$\therefore \tan. \theta > 2 \tan. \frac{\theta}{2}$$

Hence by same reasoning as before, $\tan. \theta > 2^n \tan. \frac{\theta}{2^n}$

$$\therefore \frac{\tan. \theta}{\theta} > \frac{\tan. \frac{\theta}{2^n}}{\frac{\theta}{2^n}}$$

Now, when n is infinitely large $\frac{\theta}{2^n} = 0$

$$\text{and } \frac{\tan. \frac{\theta}{2^n}}{\frac{\theta}{2^n}} \text{ in this case} = 1.$$

$$\therefore \frac{\tan. \theta}{\theta} > 1$$

or $\tan. \theta > \theta$

(2.) To show that $\sin. \theta > \theta - \frac{\theta^3}{4}$.

$$\begin{aligned} \text{For } \sin. \theta &= 2 \sin. \frac{\theta}{2} \cdot \cos. \frac{\theta}{2} \\ &= 2 \tan. \frac{\theta}{2} \cos.^2 \frac{\theta}{2} \\ &= 2 \tan. \frac{\theta}{2} \left(1 - \sin.^2 \frac{\theta}{2} \right) \\ &= \theta \cdot \frac{\tan. \frac{\theta}{2}}{\frac{\theta}{2}} \left\{ 1 - \frac{\theta^2}{4} \cdot \left(\frac{\sin. \frac{\theta}{2}}{\frac{\theta}{2}} \right)^2 \right\} \end{aligned}$$

Now $\frac{\tan. \frac{\theta}{2}}{\frac{\theta}{2}}$ being > 1 and $\left\{ \frac{\sin. \frac{\theta}{2}}{\frac{\theta}{2}} \right\}^2$ being < 1 .

$$1 - \frac{\theta^2}{4} \text{ must be } < 1 - \frac{\theta^2}{4} \cdot \left(\frac{\sin. \frac{\theta}{2}}{\frac{\theta}{2}} \right)^2$$

$$\therefore \sin. \theta \text{ must be } > \theta \left(1 - \frac{\theta^2}{4} \right)$$

$$\therefore \sin. \theta > \theta - \frac{\theta^3}{4}$$

(60.) To calculate the value of $\sin. 1'$ and $\cos. 1'$.

Let θ be an angle of $1'$ measured by the circular measure. Then,—

$$\theta = \pi + \frac{1'}{180^\circ} = \frac{\pi}{180 \times 60}$$

\therefore Taking the value of π previously given,

$$\theta = .00029088820.$$

$$\frac{\theta^3}{4} = .000000000006$$

Hence, if we only take in the first ten decimal places,

$$\sin. 1' = .0002908882.$$

And since

$$\cos. 1' = \sqrt{1 - \sin.^2 1'} = 1 - \frac{1}{2} \sin.^2 1' - \frac{1}{8} \sin.^4 1' \dots$$

$$= .99999,99577.$$

COR.—Hence, it is plain that if our approximation do not extend beyond ten places of decimals,

Circular measure of angle of $1' = \sin. 1'$.

Similarly Circular measure of angle of $1'' = \sin. 1''$.

∴ Circular measure of angle of $n'' = n \sin. 1''$,
provided $n < 60$.

(61.) To calculate the Sines of $2' 3' 4' \dots$

$$\begin{aligned} \text{Since} \quad & \sin. (A + B) + \sin. (A - B) = 2 \cos. B, \sin. A, \\ \text{we have} \quad & \sin. (n + 1)' + \sin. (n - 1)' = 2 \cos. 1' \sin. n'. \\ \text{Now} \quad & \cos. 1' = 1 - .0000000423 = 1 - k. \\ & \therefore \sin. (n + 1)' + \sin. (n - 1)' = 2 \sin. n' - 2k \cdot \sin. n' \\ & \therefore \sin. (n + 1)' - \sin. n' = \sin. n' - \sin. (n - 1)' - 2k \sin. n'. \end{aligned}$$

This formula is very convenient for calculating the sines and cosines of successive angles. Thus,

$$\begin{aligned} \sin. 2' - \sin. 1' &= \sin. 1' - 2k \sin. 1'. \\ \sin. 3' - \sin. 2' &= \sin. 2' - \sin. 1' - 2k \sin. 2'. \\ \sin. 4' - \sin. 3' &= \sin. 3' - \sin. 2' - 2k \sin. 3'. \end{aligned}$$

and so on. It will be observed that the first member of the right-hand side of each equation is given by the former equation. So that the only term requiring multiplication is $2k \sin. 1'$, $2k \sin. 2'$, $2k \sin. 3'$ in each equation. This multiplication can be greatly facilitated by forming a table in which $2k$ is multiplied by each digit, thus:—

$2k =$	846
2	1692
3	2538
4	3384
5	4230
6	5076
7	5932
8	6778
9	7614

where the seven zeros in front of the significant digits of $2k$ are suppressed. By means of this table, which resembles that of the proportional parts in the table of logarithms, the multiplication can be performed by means of addition only. It will also be observed that in the case of the sines of the first few minutes the products of k will have more than ten zeros, and therefore can be omitted, and that under all circumstances they will have at the least seven, so that the multiplication is soon performed. Thus, suppose

$$\begin{aligned} \sin. p' &= .3759264827 \\ 2k \cdot \sin. p' &= .0000000253,8 \\ & \quad 59,3 \\ & \quad 4,2 \\ & \quad 7 \\ \hline & .0000000318 \end{aligned}$$

By this means we can successively obtain the sines of $1' 2' 3' 4'$ and so on for every minute up to $45'$.

(62.) *To obtain the Cosines of the Angles 2' 3' 4', &c.*

Since $\cos. (A + B) + \cos. (A - B) = 2 \cos. A \cos. B$.

$$\therefore \cos. (n+1)' + \cos. (n-1)' = 2 \cos. n \cos. n'.$$

Hence as before

$$\cos. (n+1)' - \cos. n' = \cos. n' - \overline{\cos. n - 1'} - 2k \cos. n'.$$

or, since the cosine continually decreases,

$$\cos. n' - \overline{\cos. n + 1'} = \overline{\cos. n - 1'} + \cos. n' + 2k \cos. n'.$$

Hence

$$\cos. 1' - \cos. 2' = 1 - \cos. 1' + 2k \cos. 1'.$$

$$\cos. 2' - \cos. 3' = \cos. 1' - \cos. 2' + 2k \cos. 2'.$$

$$\cos. 3' - \cos. 4' = \cos. 2' - \cos. 3' + 2k \cos. 3'.$$

The method of calculation is precisely similar to that of the sines. It will be further observed that since $\sin. (90 - A) = \cos. A$, that we need not to continue the calculations of the sines and *posines* of the angles beyond 45° . For example, if we know $\sin. 23^\circ 15'$ and $\cosin. 23^\circ 15'$, these are respectively $\cosin. 66^\circ 45'$ and $\sin. 66^\circ 45'$.

(63.) *Simplification of calculation in case of certain Angles.*

Again, the calculation of sines and cosines of angles greater than 30° can be very much simplified, for

$$\sin. (30^\circ + \theta) + \sin. (30^\circ - \theta) = 2 \sin. 30^\circ \cos. \theta = \cos. \theta$$

$$\text{Since } \sin. 30^\circ = \frac{1}{2}$$

$$\therefore \sin. (30^\circ + \theta) = \cos. \theta - \sin. (30^\circ - \theta);$$

now if $30^\circ + \theta$ is less than 60° , then θ , and $30^\circ - \theta$ are each less than 30° . Hence by our previous calculations we know both $\cos. \theta$ and $\sin. (30^\circ - \theta)$, and therefore obtain $\sin. (30^\circ + \theta)$ by subtraction.

$$\text{Thus } \sin. (41^\circ. 15') = \cos. (11^\circ. 15') - \sin. (18^\circ. 45').$$

It is plain that by this formula we can calculate the sines of angles from $30'$ to 60° .

And since $\cos. (60 - \theta) = \sin. (30^\circ + \theta)$ this calculation of the sines from 30° to 60° gives the sines from 30° to 45° and the cosines from 45° to 30° ; which is what we want to complete the tables from 0 to 45° . Thus if we calculate by the preceding formula, $\sin. (51^\circ. 33')$, this is the same thing as $\cos. (38^\circ. 27')$.

(64.) *Method of checking the calculation.*

It will be observed, that according to the method above given, the sine of a given number of degrees or minutes is inferred from the sine of the number preceding. Hence, if an error is made at any one point, say in $\sin. 8^\circ 15'$, it will be propagated into the sines of every succeeding angle; to arrest the progress of any such error, as well as to verify the correctness of the calculations, at different points of their progress, when no such errors exist, it is usual to interpose the values of any such terms as can be calculated by independent methods. Thus we have already seen that the sines, &c. of the angles $15^\circ. 30^\circ. 45^\circ \dots$ can be readily expressed, as well as those of $18^\circ. 36^\circ. 54^\circ \dots$ And that from hence we can obtain the sines, &c. of an

angle of 3° . These and others will act as *stops* in the series, and also serve to verify the accuracy of the calculation up to the point where they are inserted.

(65.) *The calculation of Tangents and Cotangents.*

By the methods now explained we can calculate the natural sines and cosines of all angles from 0° to 90° for every minute of a degree. The natural tangents of angles between 0° and 45° can be obtained by simple division, since $\tan. \theta = \frac{\sin. \theta}{\cos. \theta}$

From 45° up to 90° we can obtain the tangent by the formula,

$$\tan. (45^\circ + \theta) = 2 \tan. 2\theta + \tan. (45^\circ - \theta).$$

To prove this formula.

$$\begin{aligned} \tan. (45^\circ + \theta) - \tan. (45^\circ - \theta) &= \frac{\sin. (45^\circ + \theta)}{\cos. (45^\circ + \theta)} - \frac{\sin. (45^\circ - \theta)}{\cos. (45^\circ - \theta)} \\ &= \frac{\sin. (45^\circ + \theta) \cos. (45^\circ - \theta) - \sin. (45^\circ - \theta) \cos. (45^\circ + \theta)}{\cos. (45^\circ + \theta) \cos. (45^\circ - \theta)} \\ &= \frac{\sin. 2\theta}{\cos. (45^\circ - \theta) \cos. (90^\circ - 45^\circ - \theta)} \\ &= \frac{2 \sin. 2\theta}{2 \cos. (45^\circ - \theta) \sin. (45^\circ - \theta)} \\ &= \frac{2 \sin. 2\theta}{\cos. (90^\circ - 2\theta)} = \frac{2 \sin. 2\theta}{\cos. 2\theta} \\ &= 2 \tan. 2\theta \end{aligned}$$

$$\therefore \tan (45^\circ + \theta) = 2 \tan. 2\theta + \tan. (45^\circ - \theta)$$

Since θ is less than 45° , 2θ is less than $45^\circ + \theta$, and hence, whatever be the value of θ , we shall have already calculated $\tan. 2\theta$, before we need $\tan. 2\theta$, for the determination of $\tan. (45^\circ + \theta)$.

$$\text{Thus} \quad \tan. 81^\circ = 2 \tan. 72^\circ + \tan. 9^\circ$$

where before we calculate $\tan. 81^\circ$ we shall already have calculated $\tan. 72^\circ$.

It is plain that if we know the tangents of angles from 0° to 90° , we also know the cotangents of the angles from 90° to 0° .

(66.) *Formulas of verification.*

There are many formulas by which the accuracy of the tables, when calculated, can be tested. The following are some of them :

- (1.) $\cos. \theta = \sin. (30^\circ + \theta) + \sin. (30^\circ - \theta)$.
- (2.) $\sin. \theta + \sin. (72^\circ + \theta) - \sin. (72^\circ - \theta) = \sin. (36^\circ + \theta) - \sin. (36^\circ - \theta)$.
- (3.) $\cos. (90^\circ - \theta) + \cos. (18^\circ - \theta) - \cos. (18^\circ + \theta) = \cos. (54^\circ - \theta) - \cos. (54^\circ + \theta)$.

The student will readily verify these formulas if he remembers the numerical values found in previous articles for the sines, &c., of 18° .

(67.) *Another method of calculating Tables of natural Sines and Cosines.*

Besides the method already given for calculating the natural sines and cosines of angles, there is another more convenient than that. The following is an account of this second method.

We have $\text{Sin. } x = x - \frac{x^3}{1.2.3} + \frac{x^5}{1.2.3.4.5} - \&c. \dots$

Now suppose x to be an angle $= \frac{m}{n} \cdot \frac{\pi}{2}$. Then

$$\text{Sin. } \frac{m}{n} \cdot \frac{\pi}{2} = \frac{m}{n} \cdot \frac{\pi}{2} + \left(\frac{m}{n}\right) \left(\frac{\pi}{2}\right)^3 \times \frac{1}{120} + \left(\frac{m}{n}\right)^5 \left(\frac{\pi}{2}\right)^5 \times \frac{1}{862880} + \dots$$

$$- \left\{ \left(\frac{m}{n}\right)^3 \left(\frac{\pi}{2}\right)^3 \frac{1}{6} + \left(\frac{m}{n}\right)^7 \left(\frac{\pi}{2}\right)^7 \frac{1}{5040} + \dots \right\}$$

Now we have already seen that $\frac{\pi}{2} = 1.570796326794897$. Hence if we reduce the coefficients of $\frac{m}{n} \cdot \left(\frac{m}{n}\right)^3 \dots$ to numbers, we have

$$\text{Sin. } \frac{m}{n} \cdot 90^\circ = \frac{m}{n} \times 1.570796326794897 - \left(\frac{m}{n}\right)^3 \times 0.645964097506246$$

$$+ \left(\frac{m}{n}\right)^5 \times 0.079692626246167 - \left(\frac{m}{n}\right)^7 \times 0.004681754135319$$

$$+ \left(\frac{m}{n}\right)^9 \times 0.000160441184737 - \left(\frac{m}{n}\right)^{11} \times 0.000003598843235$$

$$+ \left(\frac{m}{n}\right)^{13} \times 0.000000056921729 - \left(\frac{m}{n}\right)^{15} \times 0.00000000668804$$

$$+ \left(\frac{m}{n}\right)^{17} \times 0.00000000006037 - \left(\frac{m}{n}\right)^{19} \times 0.00000000000044$$

$$+ \&c. \dots$$

A similar formula can be calculated for $\cos. \frac{m}{n} \cdot 90^\circ$. It will be observed that $\frac{m}{n}$ is always a fraction less than $\frac{1}{2}$, since we only require the sines and cosines of angles less than 45° . Hence these series converge very rapidly, and from them we can easily calculate the sines and cosines for each degree from 1° up to 45° . When these are known the sines and cosines of the angles for intervals of $1'$, or if necessary $10''$ or of $1''$, can be found by the "method of interpolations."

The method of interpolations involves mathematics of a higher order than is admissible in an elementary course. The advanced reader will find an account of the application of this method to the calculation of Tables of natural sines and cosines in Airy's "Treatise on Trigonometry," in the "Encyclopædia Metropolitana."

We now proceed to give an account of the method of constructing Tables of the logarithms of sines, cosines, &c. of angles.

N. B. The sines and cosines of angles are never greater than 1. Consequently their logarithms are negative. The numbers printed in the tables are always the logarithms of the sines, &c. with 10 added to them, thus if L denote the tabular logarithm, and \log the ordinary logarithm

$$L. \sin. \theta = \log. \sin. \theta + 10.$$

This notation will be observed throughout the following pages.

The tables may be constructed by calculating the logarithms of the natural sines and cosines. And then as we have already found the natural sines and cosines of angles for intervals of $1'$ from 0° to 45° , this table will give us the log. sines, and cosines for intervals of $1'$ from 0° to 45° .

They are, however, more generally calculated by an independent process of which the following is an account :

(68.) To obtain an expression for $\log. \sin. \frac{m}{n} \cdot 90^\circ$ in a form adapted for calculation.

We have already seen that

$$\sin. x = x \left(1 - \frac{x^2}{\pi^2}\right) \left(1 - \frac{x^2}{2^2 \pi^2}\right) \left(1 - \frac{x^2}{3^2 \pi^2}\right) \left(1 - \frac{x^2}{4^2 \pi^2}\right)$$

hence

$$\sin. \frac{m}{n} \cdot \frac{\pi}{2} = \frac{m}{n} \cdot \frac{\pi}{2} \left(1 - \frac{m^2}{4n^2}\right) \left(1 - \frac{m^2}{4^2 n^2}\right) \left(1 - \frac{m^2}{6^2 n^2}\right) \left(1 - \frac{m^2}{8^2 n^2}\right)$$

taking the logarithms on both sides,

$$\begin{aligned} \log. \sin. \frac{m}{n} \cdot \frac{\pi}{2} &= \log. \frac{m}{n} + \log. \frac{\pi}{2} + \log. \frac{4n^2 - m^2}{4n^2} + \log. \left(1 - \frac{1}{4^2} \cdot \frac{m^2}{n^2}\right) \\ &\quad + \log. \left(1 - \frac{1}{6^2} \cdot \frac{m^2}{n^2}\right) + \log. \left(1 - \frac{1}{8^2} \cdot \frac{m^2}{n^2}\right) + \dots \\ &= \log. m - \log. n + \log. \pi - \log. 2 + \log. (4m^2 - m^2) - \log. 4 n^2 \\ &\quad - M \left(\frac{1}{4^2} \cdot \frac{m^2}{n^2} + \frac{1}{2} \cdot \frac{1}{4^4} \cdot \frac{m^4}{n^4} + \frac{1}{3} \cdot \frac{1}{4^6} \cdot \frac{m^6}{n^6} + \dots\right) \\ &\quad - M \left(\frac{1}{6^2} \cdot \frac{m^2}{n^2} + \frac{1}{2} \cdot \frac{1}{6^4} \cdot \frac{m^4}{n^4} + \frac{1}{3} \cdot \frac{1}{6^6} \cdot \frac{m^6}{n^6} + \dots\right) \\ &\quad - M \left(\frac{1}{8^2} \cdot \frac{m^2}{n^2} + \frac{1}{2} \cdot \frac{1}{8^4} \cdot \frac{m^4}{n^4} + \frac{1}{3} \cdot \frac{1}{8^6} \cdot \frac{m^6}{n^6} + \dots\right) \\ &\quad - \&c. \end{aligned}$$

Where M is the modulus of the common logarithms.

$$\therefore \log. \sin. \frac{m}{n} \cdot \frac{\pi}{2} =$$

$$\log. m + \log. (2n - m) + \log. (2n + 3) - 3 \log. n + \log. \pi - \log. 8.$$

$$\begin{aligned} &- M \left(\frac{1}{4^2} + \frac{1}{6^2} + \frac{1}{8^2} + \frac{1}{10^2} + \dots\right) \frac{m^2}{n^2} \\ &- \frac{M}{2} \left(\frac{1}{4^4} + \frac{1}{6^4} + \frac{1}{8^4} + \frac{1}{10^4} + \dots\right) \frac{m^4}{n^4} \\ &- \frac{M}{8} \left(\frac{1}{4^6} + \frac{1}{6^6} + \frac{1}{8^6} + \frac{1}{10^6} + \dots\right) \frac{m^6}{n^6} - \&c. \end{aligned}$$

$$\text{Now } \log. \pi - \log. 8 = 9.594059885702190 - 10$$

$$\text{And } M = .434294481903252$$

Hence reducing the coefficients of $\frac{m^2}{n^2} \frac{m^4}{n^4} \dots$ to numbers (in the same manner as we calculated the value of π in article 53), and remembering that L.

$\sin. \frac{m}{n} \cdot 90^\circ = \log. \sin. \frac{m}{n} \cdot 90^\circ + 10$ we obtain

$$\begin{aligned} \text{L. } \sin. \frac{m}{n} \cdot 90^\circ &= \log. m + \log. (2n - m) + \log. (2n + 3) - 3 \log. n. \\ &\quad + 9.594059885702190. \end{aligned}$$

$$\begin{aligned}
 & - \frac{m^4}{n^2} \times 0.070022826605902 - \frac{m^7}{n^4} \times 0.001117266441682 \\
 & - \frac{m^6}{n^6} \times 0.000039229146454 - \frac{m^9}{n^8} \times 0.000001729270798 \\
 & - \frac{m^{10}}{n^{10}} \times 0.00000084362986 - \frac{m^{12}}{n^{12}} \times 0.00000004348716 \\
 & - \frac{m^{14}}{n^{14}} \times 0.00000000231931 - \frac{m^{16}}{n^{16}} \times 0.00000000012659 \\
 & - \frac{m^{18}}{n^{18}} \times 0.00000000000703 - \frac{m^{20}}{n^{20}} \times 0.00000000000040 \\
 & - \text{\&c.}
 \end{aligned}$$

It can be proved in the same manner, by means of the expression

$$\text{Cos. } x = \left(1 - \frac{4x^2}{\pi^2}\right) \left(1 - \frac{4x^2}{9\pi^2}\right) \dots \text{ that}$$

$$\text{L cos. } \frac{m}{n} 90^\circ = 10 + \log. (n - m) + \log. (n + m) - 2 \log. n. +$$

terms involving $\frac{m^3}{n^2}$ $\frac{m^4}{n^4}$ &c., similar to those in L. sin. $\frac{m}{n} 90^\circ$

By means of the former of these expressions we may calculate L. sines of angles from 45° to 90° , or by means of the latter L. cosines of angles from 0° to 45° , which clearly comes to the same thing. We can then calculate remaining logarithms by means of the formula

$$\text{L. sin. } A = \text{L. sin. } 2A - \text{L. cos. } A + 9.698970004336019$$

To prove this formula

$$\begin{aligned}
 & \text{Since} \quad \sin. 2A = 2 \sin. A \cos. A \\
 & \quad \log. \sin. 2A = \log. 2 + \log. \sin. A + \log. \cos. A \\
 \therefore & \text{L. sin. } 2A = \text{L. sin. } A + \text{L. cos. } A + \log. 2 - 10. \\
 & \text{And} \quad 10 - \log. 2 = 9.698970004336019.
 \end{aligned}$$

Hence the formula.

We may also employ the formula for L. sin. $\frac{m}{n} 90^\circ$ to calculate the L. sines for angles of large intervals, as for $1^\circ 2' 3'' \dots$ and then apply the method of interpolations referred to in article 67.

(69.) *Explanations.*

If we take a table of logarithms of numbers we shall observe that the numbers run quite regularly, viz., 10000, 10001, 10002, &c., and the corresponding logarithms are entered in the table. But if we take a table of logarithms of sines, &c., we shall find that the logarithms of the sines and tangents of small angles are given for much smaller divisions of the angle than of the larger angles. Thus, in Hülse's edition of Vega's Tables, the L. sines, cosines, tangents, and cotangents for every minute of a degree from $6^\circ 0'$ up to $45^\circ 0'$, while they are given for every $10''$ from $0^\circ 0' 0''$, up to $6^\circ 0' 0''$ and to this general table are prefixed two others, the former giving the L. sines and tangents for every tenth part of a second from $0^\circ 0' 0''$ up to $0^\circ 0' 59''.9$, the latter giving the L. sines and tangents for intervals of $1''$ from $0^\circ 0' 0''$ up to $1^\circ 29' 59''$, the need for these minute calculations appears from the following considerations:—

To show that

$$L. \sin. (\theta + n'') - L. \sin. \theta = M n \sin. 1'' \cotan. \theta \left(1 - \frac{n \sin. 1''}{\sin. 2 \theta} \right)$$

where n is a small number.

we have

$$\log. \sin. (\theta + \delta) - \log. \sin. \theta = \log. \frac{\sin. (\theta + \delta)}{\sin. \theta}$$

$$= \log. (\cos. \delta + \cotan. \theta \sin. \delta).$$

Now if δ be small, so that we may omit δ^3 *

$$\text{we have } \cos. \delta = 1 - \frac{\delta^2}{2} \text{ and } \sin. \delta = \delta.$$

$$\therefore \log. \sin. (\theta + \delta) - \log. \sin. \theta = \log. \left(1 + \cotan. \theta \cdot \delta - \frac{\delta^2}{2} \right)$$

$$\text{Now } \log. (1 + x) = M. \left(x - \frac{x^2}{2} + \frac{x^3}{3} - \&c. \right)$$

$$\therefore \log. \sin. (\theta + \delta) - \log. \sin. \theta.$$

$$M. \left\{ \left(\cotan. \theta \cdot \delta - \frac{\delta^2}{2} \right) - \frac{1}{2} \cdot \left(\delta \cotan. \theta - \frac{\delta^2}{2} \right)^2 \dots \right\}$$

$$= M. \left(\delta \cotan. \theta - \frac{1}{2 \sin.^2 \theta} \cdot \delta^2 \right) \text{ omitting } \delta^3. \dots$$

$$= M. \delta \cotan. \theta \left(1 - \frac{\delta}{\sin. 2 \theta} \right).$$

* Now if δ is an angle of n'' then δ the circular measure of this angle, equal $n \sin. 1''$.

$$\therefore L. \sin. (\theta + n'') - L. \sin. \theta = M n \sin. 1'' \cotan. \theta \left(1 - \frac{n \sin. 1''}{\sin. 2 \theta} \right) \quad (60.)$$

* In this and the following articles are several instances of approximation which must be carefully attended to. We say if δ be so small that we may omit δ^3 and all the higher powers of δ , then $\cos. \delta = 1 - \frac{\delta^2}{2}$ and $\sin. \delta = \delta$. For this, see cor. to article (50).

We then obtain

$$\log. \sin. (\theta + \delta) - \log. \sin. \theta = M \left\{ \left(\cotan. \theta \cdot \delta - \frac{1}{2} \delta^2 \right) - \frac{1}{2} \left(\cotan. \theta \delta - \frac{\delta^2}{2} \right)^2 \right\}$$

$$\text{which is of course } = M \left(\cotan. \theta \delta - \frac{\delta^2}{2} - \frac{1}{2} \delta^2 \cotan.^2 \theta + \frac{1}{2} \cotan. \theta \delta^3 - \frac{\delta^4}{8} + \&c. \right)$$

$$\text{which } = M \left\{ \cotan. \theta \delta - \frac{1}{2} \delta^2 (1 + \cotan.^2 \theta) \right\}$$

if we omit δ^3 , δ^4 , &c., and hence the result in the text.

So again in another article. If we omit θ^4 , and all higher power of θ , we have

$$\sin. \theta = \theta - \frac{\theta^3}{6} \quad \therefore \frac{\sin. \theta}{\theta} = 1 - \frac{\theta^2}{6}$$

$$\text{Now } \left(1 - \frac{\theta^2}{6} \right)^{\frac{1}{2}} = 1 - \frac{1}{3} \cdot \frac{\theta^2}{2} - \frac{1}{2} \cdot \left(\frac{\theta^2}{2} \right)^2 \&c.$$

$$= 1 - \frac{\theta^2}{6} - \frac{\theta^4}{36} \&c.$$

by the Binomial Theorem

$$\therefore \left(1 - \frac{\theta^2}{6} \right)^{\frac{1}{2}} = 1 - \frac{\theta^2}{6} \text{ if we omit } \theta^4 \&c. \therefore \frac{\sin. \theta}{\theta} = \left(1 - \frac{\theta^2}{6} \right)^{\frac{1}{2}} = (\cos. \theta)^{\frac{1}{2}}$$

In like manner we may prove that

$$L. \tan. (\theta + n'') - L. \tan. \theta = \frac{M n \sin. 1''}{\cos. \theta} (1 - n \sin. 1'' \tan. \theta).$$

Now suppose that our tables are calculated for angles that differ by so small an angle δ'' , that we can neglect the second term of Equation (60) so that

$$L. \sin. (\theta + \delta'') - L. \sin. \theta = M \delta \sin. 1'' \cotan. \theta.$$

Also, if $n < \delta$, *à fortiori*,

$$L. \sin. (\theta + n'') - L. \sin. \theta = M n \sin. 1'' \cotan. \theta.$$

Now, for any value of θ the Tables give us

$$L. \sin. (\theta + \delta'') - L. \sin. \theta \text{ call this } \Delta$$

$$\therefore \Delta = M \delta \sin. 1'' \cotan. \theta$$

$$\therefore L. \sin. (\theta + n'') - L. \sin. \theta = \frac{n}{\delta} \Delta.$$

i. e. when two angles are nearly equal, difference between log. sines is proportional to the difference of angles.

Now $\frac{\Delta}{\delta}$ is the difference corresponding to $1''$. This can easily be multiplied by n .

Also $L. \sin. \theta$ is given by the Tables, and hence we can find $L. \sin. (\theta + n'')$ and conversely having given $L. \sin. (\theta + n'')$, where only $L. \sin. \theta$ is given in tables, we can easily find the n seconds.

If the numerical values of formula (60) are taken for different angles, it will be found that in order to make the difference between two consecutive $L.$ sines, given in the Tables proportional to the number of seconds, we must have $\delta = 1''$ from 0° up to $1^\circ 30'$, and $\delta = 10''$ from $1^\circ 30'$ up to 5° , and $\delta = 60''$ from 5° upward:—the log. sines being calculated to 7 places of decimals.

The practical mode of employing the Tables will be readily understood from the following examples:—

Thus

(1). Find $L. \sin. (15^\circ 11' 16'' \cdot 5)$.

By tables	$L. \sin. 15^\circ 11'$	=	9·4181495
Do. diff. $1'' = 7755$	x	$10'' =$	775 5
		$6'' =$	465 3
		$\cdot 5 =$	38 7

$$L. \sin. (15^\circ 11' 16'' \cdot 5) = 9\cdot4182765$$

(2). Find $L. \sin. (3^\circ 19' 37'' \cdot 4)$.

By tables	$L. \sin. (3^\circ 19' 30'')$	=	8·7634252
Do. diff. $1'' = 362\cdot 3$	x	$7'' =$	2534 1
		$\cdot 4 =$	144 0

$$L. \sin. (3^\circ 19' 37'' \cdot 4) = 8\cdot7636931$$

(3). Find θ . If $L. \sin. \theta =$
 $L. \sin. \theta =$
 $L. \sin. (35^\circ 33') =$

=	9·7645827
=	9·7645827
=	9·7644849

Diff. $1'' =$	$29\cdot45 \times 80$	=	2356
		=	978
		=	898·5
		=	84·5
		=	58·9

25.6

.8

23.56

$$\therefore \theta = 35^{\circ}. 53'. 32''. 8.$$

We proceed in precisely the same manner with the logarithms of the other trigonometric functions, with this exception, that what is true of the L. sines and L. tangents of small angles, is true of the L. cosines and L. cotangents of angles which are nearly equal to 90° . For, since $\sin. \theta = \cos. (90^{\circ} - \theta)$ and $\tan. \theta = \cotan. (90^{\circ} - \theta)$, then if θ be small, $90^{\circ} - \theta$ is nearly equal to 90° .

(71.) *Another way of treating the L. sines of small angles.*

If the tables give the log. sines, &c. for intervals of 1' throughout, and not the refined tables for small angles before spoken of, we can find the accurate value of a small angle whose L. sine is given, and *vice versa*, by the following process.

If θ is small, so that we can omit θ^4 , θ^5 , &c. we have (Art. 50)

$$\sin. \theta = \theta - \frac{\theta^3}{6}.$$

$$\& \cos. \theta = 1 - \frac{\theta^2}{2}.$$

$$\text{Hence } \frac{\sin. \theta}{\theta} = 1 - \frac{\theta^2}{6} = \left(1 - \frac{\theta^2}{6}\right)^{\frac{1}{2}} = \cos. \frac{1}{2}\theta$$

Now suppose θ to contain n'' $\therefore \theta = n \sin. 1''$

$$\therefore \frac{\sin. \theta}{n \sin. 1''} = \cos. \frac{1}{2}\theta$$

$$\therefore \log. \sin. \theta - \log. n - \log. \sin. 1'' = \frac{1}{3} \log. \cos. \theta$$

$$\therefore \text{L. sin. } \theta - \log. n - \text{L. sin. } 1'' = \frac{1}{3} \cdot \text{L. cos. } \theta - \frac{10}{3}$$

$$\therefore \text{L. sin. } \theta = \log. n + \frac{1}{3} \cdot \text{L. cos. } \theta + \text{L. sin. } 1'' - \frac{10}{3}$$

$$\& \text{L. sin. } 1'' = 4.6855749.$$

$$\therefore \text{L. sin. } \theta = \log. n + \frac{1}{3} \cdot \text{L. cos. } \theta + 1.3522416$$

$$\text{and } \log. n = \text{L. sin. } \theta - \frac{1}{3} \cdot \text{L. cos. } \theta - 1.3522416.$$

It is to be observed that when θ is very small, $\cos. \theta$ changes very slowly. Hence in the term $\text{L. cos. } \theta$ we may use the number of minutes in θ , omitting the odd seconds, and then, the former formula gives us $\text{L. sin. } \theta$, when θ or n'' is given, and the latter gives us the n'' when $\text{L. sin. } \theta$ is given.

For instance,

Find θ , having given that $\text{L. sin. } \theta = 7.2777613$. On looking into Tables we find that θ is between $6'$ and $7'$, hence in this case $\cos. \theta = \cos. 6'$

$$\begin{aligned} \text{L. sin. } \theta &= 7.2777613 \\ - \frac{1}{3} \text{L. cos. } 6' &= 6.6666668 - 10. \\ - + 1.3522416 &= 8.6477584 - 10. \end{aligned}$$

 2.5921865

 .5921768

39100

8

6

 $391.0086 = n.$ If we find n'' by more refined tablesL. sin. $\theta = 7.2777618$ L. sin. $6'.31'' = 2.777514$

97

90

7.

 $\therefore \theta = 6'.31'' .0086$

99,00

75,21

23,790

22,563

1

3

 $\therefore \theta = 6'.31''.018.$ \therefore by this method $n = 391.018$

which does not differ materially from the result we obtained by the less refined table and the formula.

Find L. sin. θ when $\theta = 7'.31''.37.$ Here $n = 451.37$ L. cos. $\theta =$ L. cos. $7'$ L. sin. $\theta =$ log. $n = 2.6545327$ $+ \frac{1}{3}$ L. cos. $7' = 3.3333330$ $+ 1.3522416 = 1.3522416$

7.3401073

The more refined tables give us at once

L. sin. $7'.31'' = 7.3397511$ Diff. $1'' = 9619 \times .3 = 2885,7$

7 = 673,33

7.3401070

In like manner if we have θ so small an angle that $\theta^4 \theta^6 \dots$ may be omitted, and if θ be an angle of n seconds,

$$\tan \theta = \frac{\sin. \theta}{\cos. \theta} = \frac{\theta - \frac{\theta^3}{6}}{1 - \frac{\theta^2}{2}} = \left(\theta - \frac{\theta^3}{6} \right) \left(1 + \frac{\theta^2}{2} \right)$$

$$\therefore \frac{\tan. \theta}{\theta} = 1 + \frac{1}{3} \theta^2 = \left(1 - \frac{\theta^2}{2} \right)^{-\frac{2}{3}} = (\cos. \theta)^{-\frac{2}{3}}.$$

$$\therefore \log. \tan. \theta - \log. n \sin. 1'' = -\frac{2}{3} \cdot \log. \cos. \theta$$

$$\text{L. tan. } \theta = \log. n + \text{L. sin } 1'' + \frac{2}{3} \cdot (10 - \text{L. cos. } \theta).$$

$$\text{L. tan. } \theta = \log. n + 11.3522416 - \frac{2}{3} \text{L. cos. } \theta.$$

This formula can be used in the same manner as the one for L. sin. θ .

(72.) *Delambre's method for L. sines of small angles.*

There is another method of treating the L. sines of small angles, of which the following is an account.

$$\begin{aligned} \text{Sin. } \theta &= \theta - \frac{\theta^3}{6} + \frac{\theta^5}{120} - \&c. \\ \therefore \log. \frac{\text{sin. } \theta}{\theta} &= \log. \left\{ 1 - \left(\frac{\theta^2}{6} - \frac{\theta^4}{120} \right) \right\}. \text{ Omitting } \theta^5 \\ &= -M \left\{ \left(\frac{\theta^2}{6} - \frac{\theta^4}{120} \right) + \frac{1}{2} \left(\frac{\theta^2}{6} - \frac{\theta^4}{120} \right)^2 + \dots \right\} = \\ &= -M \left(\frac{\theta^2}{6} + \frac{\theta^4}{180} \cdot \right) \end{aligned}$$

From this a table for $\log. \frac{\text{sin. } \theta \cdot \text{sin. } 1''}{\theta}$ can easily be calculated. Now suppose θ to contain n''

Then

$$\begin{aligned} n \text{ sin. } 1'' &= \theta \\ \therefore \frac{\text{sin. } n''}{n} &= \frac{\text{sin. } \theta \cdot \text{sin. } 1''}{\theta} \\ \therefore \text{L. sin. } n'' &= \log. n + \text{L. } \frac{\text{sin. } \theta \cdot \text{sin. } 1''}{\theta} \end{aligned}$$

and since $\text{L. } \frac{\text{sin. } \theta \cdot \text{sin. } 1''}{\theta}$ is given by the Tables, if we know n we can at once find $\text{L. sin. } n''$. And conversely if we have given $\text{L. sin. } \theta$, we can find n ; for $\text{sin. } \theta = \theta = n \text{ sin. } 1''$ nearly. $\therefore \log. n = \text{L. sin. } \theta - \text{L. sin. } 1''$ nearly, whence we know n approximately. This will enable us to obtain the value of $\log. \frac{\text{sin. } \theta \cdot \text{sin. } 1''}{\theta}$ from the Tables with sufficient accuracy; which being known, we have $\log. n = \text{L. sin. } \theta - \log. \frac{\text{sin. } \theta \cdot \text{sin. } 1''}{\theta}$, which gives us n accurately.

It can easily be shown, that in calculating tables for $\log. \frac{\text{sin. } \theta}{\theta}$ from the formula,

$$\log. \frac{\text{sin. } \theta}{\theta} = -M \left(\frac{\theta^2}{6} + \frac{\theta^4}{180} \right).$$

that for tables of seven places of decimals up to 5° , θ^4 can be omitted.

For when θ is an angle of 5° , $\theta = \frac{5\pi}{180}$

$$\therefore M \frac{\theta^4}{180} = M \frac{5^4 \pi^4}{(180)^3} = .0000001,39927 \dots$$

Let us now look back and consider what we have done in the previous pages. (1.) We have investigated the various general relations existing between the trigonometrical functions. (2.) We have investigated the general relations existing between the sides and angles of triangles. (3.) We have fully discussed the mode of constructing trigonometrical tables, *i.e.* the means of obtaining numerical results from our trigonometrical formulas.

We now proceed to the actual numerical calculation of the sides and angles of

triangles, which we shall find will invariably consist in reducing formulas to numbers. For instance,

Given $\sin. (m + x) - \sin. (m - x) = \cos. (m - n) - \cos. (m + n)$
 Find x when $m = 12^\circ 13'$ and $n = 7^\circ 37'$.
 Since $\sin. (m + x) - \sin. (m - x) = 2 \sin. x \cos. m$
 and $\cos. (m - n) - \cos. (m + n) = 2 \sin. m \sin. n$
 $\therefore 2 \sin. x \cos. m = 2 \sin. m \sin. n$
 $\therefore \sin. x = \tan. m \sin. n$
 $\therefore \log. \sin. x = \log. \tan. m + \log. \sin. n$
 $\therefore \log. \sin. x + 10 = \log. \tan. m + 10 + \log. \sin. n + 10 - 10$
 and $\therefore L. \sin. x = L. \tan. m + L. \sin. n - 10$
 $L. \tan. m = 9.3354823$
 $L. \sin. n = 9.1223624 - 10$
 $\frac{8.4578447}{8.4578369}$
 $L. \sin. 1^\circ 33' 40''$
 $\text{diff. } 1'' = 732,8 \times .1 \quad \frac{78}{73.28}$
 Aus. $x = 1^\circ 38' 40'' . 1$

THE NUMERICAL SOLUTION OF RIGHT-ANGLED TRIANGLES.

The parts of a right-angled triangle are the three sides, two angles and the right angle, if any two of the former five, one of the two being a side, are given, we can calculate the remaining three. The following are the methods employed in the various cases, which are these.

- (1). Given the base and perpendicular.
- (2). Given the hypotenuse and another side.
- (3). Given the base or perpendicular and an angle.
- (4). Given the hypotenuse and an angle.

- (1). Given the base and perpendicular
 i.e. given a, b . find A, B, c .

$$\tan. A = \frac{a}{b} \text{ gives } A.$$

$$B = 90^\circ - A. \text{ Gives } B.$$

$$\cos. A = \frac{b}{c}.$$

$$\text{or } c = \frac{b}{\cos. A} \text{ Gives } c.$$

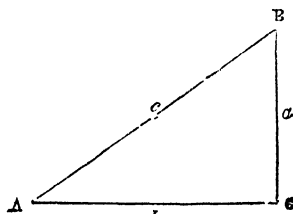

Fig. 23.

These can be put into forms adapted for logarithmic calculation, as follows :

$$\log. \tan. A = \log. a - \log. b.$$

$$\therefore 10 + \log. \tan. A = \log. a + 10 - \log. b.$$

$$\text{or, } L. \tan. A = \log. a + \text{ar : comp : } \log. b. \tag{a}$$

Similarly.

$$\begin{aligned} \log. c &= \log. b - \log. \cos. A \\ &= \log. b + 10 - (10 + \log. \cos. A) \\ &= \log. b + 10 - L. \cos. A. \end{aligned}$$

$\therefore \log. c = \log. b. + \text{ar} : \text{comp} : L. \cos. A.$ (b).
 (a). and (b). are the formulas actually used in calculation. Thus

Given $a = 7564 \cdot 5$ yds. $b = 3987 \cdot 4$ yds.

Find. A, B, and c.

To find A, from (a) we have.

$$\begin{aligned} \text{Log. tan. } A &= \log. a + \text{ar} : \text{comp} : \log. b. \\ &= \log. 7564 \cdot 5 &= & 3 \cdot 8787802 \\ &+ \text{ar} : \text{comp} : \log. 3987 \cdot 4 & & 6 \cdot 3993102 \end{aligned}$$

L. tan. $62^\circ 12'$

10·2780904

10·2779915

diff. for $1''$

$$= 51 \cdot 05) 989 \cdot 00 \text{ (} 19 \cdot 5105$$

47850

45945

$$\therefore A = 62^\circ 12' 19''$$

90

and $B = 27^\circ 47' 41''$

To find c we have.

$\text{Log. } c = \log. b + \text{ar} : \text{comp} : L. \cos. A$

$\log. b =$

3·6006398

$\text{ar} : \text{comp} : L. \cos. 62^\circ 12' 19'' = \text{ar} : \text{comp} : 9 \cdot 6686623 =$

·3313377

3·9320275

·9320271

85512

08 diff. =

4

$$\therefore c = 8551 \cdot 208$$

(2). Given the hypotenuse and another side.

e.g. given a c to find A B and b.

We have, $\sin. A = \frac{a}{c}.$

$\therefore \log. \sin. A = \log. a - \log. c.$

$\therefore L. \sin. A = \log. a + \text{ar} : \text{comp} : \log. c$ (a)

which gives A and $\therefore B$ which equals $90^\circ - A.$

Again $\cos. A = \frac{b}{c}.$

$\therefore b = c \cos. A.$

$\therefore \log. b = \log. c + L. \cos. A - 10.$ (b)

Ex: Given $a = 724 \cdot 5.$ $c = 1005 \cdot 4.$

We shall have $A = 46^\circ 6' 17''.$ $B = 43^\circ 53' 43''.$

$b = 697 \cdot 086.$

(3) *Given the Base or Perpendicular and an Angle.*

e. g. given a , A , find B , b , c .
 We have $B = 90^\circ - A$.
 Again $c = \frac{a}{\sin A}$
 $\therefore \log. c = \log. a - \log. \sin. A$
 $\therefore \log. c = \log. a + \text{ar} : \text{comp} : \text{L. sin. A.} \quad (a)$
 Again $c = \frac{b}{\cos. A}$.
 $\therefore \log. b = \log. c + \text{L. cos. A} - 10. \quad (b)$

In using formula (b). It must be remembered that in the calculation of formula (a) we have already found $\log. c$.

Example. Given $a = 7643.5$ $A = 37^\circ. 18'$.

We shall find $B = 52^\circ. 42'$
 $c = 12613.4$
 $b = 10033.53$

(4) *Given the Hypotenuse and an Angle.*

e. g. given c , A , find B , b , a .
 We have $B = 90^\circ - A$.
 $b = c \cos. A$.
 $\therefore \log. b = \log. c + \text{L. cos. A} - 10. \quad (a)$
 $a = c \sin. A$.
 $\therefore \log. a = \log. c + \text{L. sin. A} - 10. \quad (b)$
 Example. Given $c = 7234.5$ $A = 33^\circ. 19'$.
 We have $B = 56^\circ. 41'$.
 $b = 6045.493$.
 $a = 3973.665$.

The cases of oblique triangles are in like manner reducible to four, viz.—

- (1). Given three sides to find the angles.
- (2). Given two sides and the included angle.
- (3). Given two sides and the angle opposite to them.
- (4). Given one side and two angles.

(1). *Given three sides to find the angles,*
i. e., given a , b , c to find A , B , C .

We have $2s = a + b + c$.

$$\therefore \tan^2 \frac{A}{2} = \frac{(s-b)(s-c)}{s(s-a)}$$

$$\therefore 2 \log. \tan. \frac{A}{2} = \log. (s-b) + \log. (s-c) - \log. s - \log. (s-a)$$

$$\therefore 2 \log. \tan. \frac{A}{2} + 20 = \log. (s-b) + \log. (s-c) + 10 - \log. s + 10 - \log. (s-a)$$

$$\therefore 2 \text{L. tan.} \frac{A}{2} = \log. (s-b) + \log. (s-c) + \text{ar. : comp. : } \log. s + \text{ar. : comp. : } \log. (s-a)$$

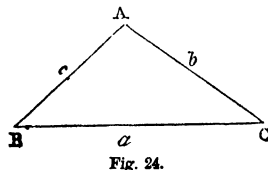

This formula gives us $\frac{A}{2}$. We shall have to find B from the formula

$$2 \text{ L. tan. } \frac{B}{2} = \log. (s-c) + \log. (s-a) + \text{ar : comp. : log. } s + \text{ar : comp. : log. } (s-b)$$

It will be observed that all the logarithms needed for finding B and C have been already used in finding A, whence, when A is known, B and C are found with very little trouble.

Instead of using the formula which gives us $\tan. \frac{A}{2}$, we may use those which give $\sin. \frac{A}{2}$ or $\cos. \frac{A}{2}$.

Example given, $a = 3756.3$ $b = 5923.7$ $c = 4652$, we shall find that—

$$A = 39^{\circ}. 18' 28''$$

$$B = 49^{\circ}. 0' 50''$$

$$C = 51^{\circ}. 40' 42''$$

$$\therefore A + B + C = 180^{\circ}. 0' 0''$$

which circumstance is a test of the accuracy of the calculation.

(2.) Given two sides and the included Angle.

e. g. given a b C , find A B c .

We have

$$\tan. \frac{A-B}{2} = \frac{a-b}{a+b} \tan. \frac{A+B}{2}$$

$$\begin{aligned} \therefore \text{L. tan. } \frac{A-B}{2} &= \log. (a-b) + \text{ar : comp. : log. } (a+b) \\ &+ \text{L. tan. } \frac{A+B}{2} - 10. \end{aligned} \quad (a)$$

It must be observed that $\frac{A+B}{2} = 90^{\circ} - \frac{C}{2}$ and is therefore known. Wherefore (a) gives us $\frac{A-B}{2} = \alpha$, a known angle. Then,

$$\frac{A+B}{2} = 90 - \frac{C}{2}$$

$$\frac{A-B}{2} = \alpha$$

$$\therefore A = 90^{\circ} + \alpha - \frac{C}{2}$$

$$\text{and } B = 90^{\circ} - \alpha - \frac{C}{2}$$

whence A and B are known.

To find c we have

$$c = a \frac{\sin. C}{\sin. A}. \quad (b)$$

$\therefore \log. c = \log. a + \text{L. sin. } C + \text{ar : comp. : L. sin. } A - 10$, which will give us c .
We may employ a subsidiary angle θ in the following manner (see Art. 40).

Assume $\tan. \theta = \frac{a - b}{a + b} \cdot \cotan. \frac{C}{2}$

$$\therefore c = \frac{(a + b) \sin. \frac{C}{2}}{\cos. \theta}$$

$$\log. \tan. \theta = \log. (a - b) + \text{ar} : \text{comp} : \log. (a + b) + \log. \cotan. \frac{C}{2} - 10 \quad (c)$$

$$\log. c = \log. (a + b) + \log. \sin. \frac{C}{2} + \text{ar} : \text{comp} : \log. \cos. \theta - 10 \quad (d)$$

By using (c) and (d) we can obtain *c* without first finding *A* and *B*.

If we solve by the former methods we require six logarithms, viz.: those of $(a - b)$ $(a + b)$ $\tan. \frac{A + B}{2}$ *a.* $\sin. C$ $\sin. A$.

If by the latter we require five logarithms $(a - b)$ $(a + b)$ $\cotan. \frac{C}{2}$ $\sin. \frac{C}{2}$ and $\cos. \theta$; the latter method possesses a slight advantage over the former.

The θ in formula (c) is evidently the same as $\frac{A - B}{2}$ in formula (a).

If $b > a$ the formulæ become

$$\tan. \frac{B - A}{2} = \frac{b - a}{b + a} \cdot \tan. \frac{A + B}{2}$$

and $\tan. \theta = \frac{b - a}{b + a} \cdot \cotan. \frac{C}{2}$.

Example:—Given $a = 562$. $b = 320$. $C = 123^\circ 4'$

We shall find

$$A = 33^\circ 34' 40''$$

$$B = 18^\circ 21' 20''$$

$$c = 800.008.$$

If we take the second method we shall find

$$\log. \tan. \theta = 9.1258960$$

$$\therefore \log. \cos. \theta = 9.9961568$$

And, as before we shall find,

$$c = 800.008.$$

(3.) *Given two sides, and an Angle opposite to one of them.*

e. g. given *B. b. c.* find *A. C. a.*

We have $\sin. C = \frac{c}{b} \cdot \sin. B$.

$\therefore \log. \sin. C = \log. c + \log. \sin. B + \text{ar} : \text{comp} : \log. b - 10$ (a)
which gives *C*. Then

$$A = 180^\circ - (B + C)$$

which gives *A*. Then

$$a = b \frac{\sin. A}{\sin. B}$$

or, $\log. a = \log. b + \log. \sin. A + \text{ar} : \text{comp} : \log. \sin. B - 10$ (b)
which gives *a*.

N.B.—This is sometimes called the ambiguous case of a triangle; for we have

$\sin. C$ given us, whence we know $C = \alpha$, where $\alpha < 90^\circ$. Now, $\sin. \alpha = \sin. (180 - \alpha)$
 $\therefore C$ may also equal $180 - \alpha$. Hence this equation may give us *two* triangles, one
 which has $C = \alpha$, the other having $C = 180^\circ - \alpha$. In many cases, however, this
 ambiguity does not exist.

- (1). $B =$ or $> 90^\circ$. Then $C = 180^\circ - \alpha$ is inadmissible, since C would then be
 $> 90^\circ$, and $B + C > 180^\circ$, which is impossible.
- (2). If $B < 90^\circ$. Then
 - (a). If $c \sin. B = b$ then $\sin. C = 1$ or $C = 90^\circ$, and the other value of $C = 180^\circ$
 $- 90^\circ = 90^\circ$, or in this case there is no ambiguity.
 - (β). If $c < b$. Then $C < B$, hence if $C = \alpha$. $\alpha < B$, and $180^\circ - \alpha + B >$
 180° . or in this case the angle $180^\circ - \alpha$ is inadmissible, and there is no
 ambiguity.
 - (γ). But if $c > b$. Then both $c = \alpha$, and $c = 180^\circ - \alpha$ are admissible, and
 there are two triangles determinable from the given values, b, c, B .

This can be illustrated geometrically as follows:—

$AB = c$

$ABc = B$.

with centre A and radius b
 describe a circle. Then,

- (a). If $b = c \sin. B$, the
 circle will touch Bc
 in c , and the triangle
 will be ABc .
- (β). If $c < b$ the circle
 will cut Bc , in two
 points C_2C_1 , on *dif-*
ferent sides B , and
 the triangle is ABC_1 .
- (γ). If $c > b$ the circle
 cuts Bc in two points c_1, c_2
 on the *same* side of B , and
 the triangle may be either ABc_2
 or ABc_1 ; which is the reason of
 this case being called
 ambiguous.

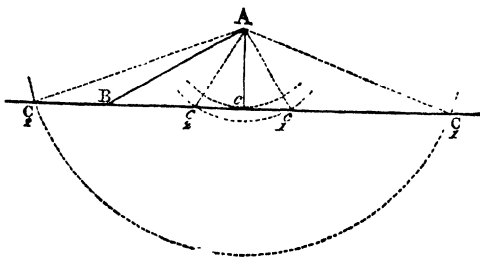

Fig. 25.

Example: Given $B = 45^\circ$ $b = 305$ $c = 219.5$

Then $C = 30^\circ. 36'. 22''$

$A = 104^\circ. 23' 38''$

$a = 416. 8344$.

- (4). Given, one side and two angles e. g. given, a B, C , to find A, c, b .

We have $A = 180^\circ - (B + C)$, which gives A .

Now,

$$\frac{b}{a} = \frac{\sin. B}{\sin. A} \quad \frac{c}{a} = \frac{\sin. C}{\sin. A}$$

$\therefore \log. b = \log. a + \log. \sin. B + \text{ar} : \text{comp} : \log. \sin. A - 10$. and $\log. c = \log. a +$
 $\log. \sin. C + \text{ar}, \text{comp} : \log. \sin. A - 10$. Whence we can immediately calculate $b, \&c$.

Example:

Given $B = 49^\circ$.

$c = 29^\circ. 19'$ and $a = 95.4$, we shall find

$A = 101^\circ. 41'$

$b = 73.52255$

$c = 47.69952$

Several practical applications of the science of Trigonometry will be found in the
 following short treatise on Mensuration.

MENSURATION.

THE object of the following short treatise is to show the practical application of the truths investigated in previous treatises of geometry and trigonometry, to solve a variety of questions about measurements such as may frequently occur in practical life. For instance, the determination of the area of a field, the distance between two inaccessible points, the solid content of a pyramid, and others. We shall endeavour in each instance to refer these questions to the principles on which they rest. By doing so, the attentive reader will be enabled to apply the same principles to cases that may occur practically, but which our limits forbid us to treat of. We shall take in order a variety of questions concerning the determination (1) of Heights and Distances, (2) of Areas of Surfaces, (3) of Contents of Solids.

(1.) ON HEIGHTS AND DISTANCES.

In the following articles we are supposed to have the means of measuring the angle subtended at the eye of the observer by the line joining two points. The instrument by which this can be done is called a sextant. For measuring the angle subtended by two objects on a horizontal plane, and for determining the vertical elevation of one point above another, an instrument called a Theodolite can be used.

1. To determine the height of a Tower standing on a Horizontal Plane, the base of which is accessible.

AP the tower. B any convenient place for the observer.
At B measure the angle ABP; also measure the line AB.
Then, if $AP = x$,

$$x = a \tan. B.$$

$$\therefore \log. x = \log. a + L \tan. B - 10.$$

which gives x .

N.B. If P is the top of a steeple, half the breadth of the tower must be added to the measurement, which is made to the outside of the tower. It will be observed, moreover, that B is the place of the observer's eye, and \therefore AP, or x , is the height of P, above the horizontal plane passing through the observer's eye. Hence, if h is the height of the eye above the ground, $x + h$ is the height of the summit of the tower above the ground.

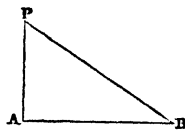

Fig. 1.

(2.) To determine the height of a Tower, the base of which is inaccessible.

Let ABN be the horizontal plane; PN the height required. At B measure angle PBN; move backward to another point, A, taking care that A and B are both on the same vertical plane passing through P, and measure AB, and the angle PAN.

$$\text{Let } PBN = \beta. \quad PAB = \alpha. \quad AB = a.$$

$$BP = x. \quad PN = y.$$

$$\text{Now angle } \quad APB = (\beta - \alpha)$$

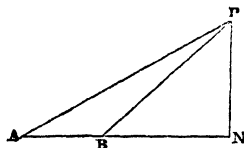

Fig. 2.

$$\therefore y = a \frac{\sin. \alpha}{\sin. (\beta - \alpha)}$$

and $x = y \sin. \beta.$

$$\therefore x = a \frac{\sin. \alpha \cdot \sin. \beta}{\sin. (\beta - \alpha)}$$

$$\therefore \log. x = \log. a + L. \sin. \alpha + L. \sin. \beta + \text{ar. comp. } L. \sin. (\beta - \alpha) - 20.$$

(3.) To determine the height of the Tower in the last article when the nature of the ground does not admit of the observer moving backward.

Let PN be the vertical height required, place pickets at two points, A and B, APN and BPN being two different vertical planes.

Measure AB = a. Let PN = x.

Measure angle PAN = α .

$$PAB = A \quad PBA = B.$$

Then $x = AP \sin. \alpha$

Now $\angle APB = 180^\circ - (A + B)$

$$\therefore AP = a \frac{\sin. B}{\sin. (A + B)}$$

$$\therefore x = a \frac{\sin. \alpha \sin. B}{\sin. (A + B)}$$

$$\therefore \log. x = \log. a + L. \sin. \alpha + L. \sin. B + \text{ar. comp. } L. \sin. (A + B) - 20.$$

In the above case such an angle as PAN being the vertical elevation of P above the horizon is measured by a theodolite. While the angle PAB, which is not in a horizontal plane, being the angle subtended by the distance between two objects, is measured by a sextant.

If the object is a long way off we may measure the angle subtended at the eye by the line joining that object and its image in still water, by a sextant; half that angle will be the vertical elevation of the object.

Example: We observe that the altitude of a hill is $3^\circ 15'$ on proceeding $1\frac{3}{4}$ miles towards it. Its altitude is $15^\circ 37'$. Find the height of that hill, neglecting the sphericity of the earth.

Here (fig. 2)

$$AB = 1\frac{3}{4} \text{ miles.}$$

$$PAB = 3^\circ 15'.$$

$$PBN = 15^\circ 37'.$$

$$\therefore PBN - PAB = 12^\circ 22'.$$

Then by the formula proved in Article (2)

$$PN = a \frac{\sin. PBN \sin. PAB}{\sin. (PBN - PAB)}$$

$$\therefore \log. PN = \log. a + L. \sin. PBN + L. \sin. PAB + \text{ar. comp. } L. \sin. (PBN - PAB) - 20.$$

log. 1.75	.243 0380
L. sin. $15^\circ 37'$	9.430 0750
L. sin. $3^\circ 15'$	8.753 5278
Ar. comp. L. sin. $12^\circ 22'$.689 2473 - 20

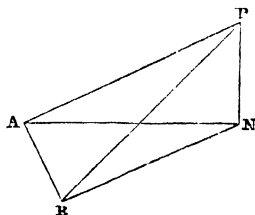

Fig. 3.

19764	1 2958881
G	2958748
197646 of a mile	133
or $\frac{1}{4}$ of a mile very nearly.	132

(Answer.)

(4.) To find the distance between two points, one of which is accessible and the other inaccessible.

Let P be the inaccessible point.

A the accessible.

Drive a picket in at A, and drive in another at any convenient point, B.

Measure the angles PAB and PBA, also measure the line AB.

Then by the fourth case of the solution of triangles

$$AP = AB \cdot \frac{\sin. APB}{\sin. ABP}$$

$$= AB \cdot \frac{\sin. (PAB + ABP)}{\sin. ABP}$$

\therefore calling AB = a. PAB = A. ABP = B.

we have

$$\log. AP = \log. a + L. \sin. (A + B) + \text{ar. comp. } L. \sin. B - 10.$$

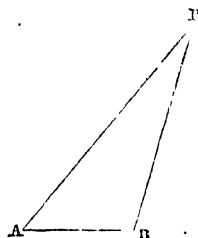

Fig. 4.

(5.) To find the distance between two points neither of which is accessible.

Let A, B, be the two points; place on the ground two pickets C, and D, such that the distance between C and D can be measured, and that from each of C and D, the two inaccessible points and the other picket may be visible.

Measure CD = p $\angle ACB = C$ $\angle BCD = C'$
 $\angle ADB = D$ $\angle ADC = D'$

Then in triangle ACD we know one side and two angles, and therefore can calculate AC.

In triangle BCD we know one side and two angles, and therefore can calculate BC.

And finally in triangle ACB we have already calculated AC, BC, and have measured the angle C, and therefore can determine AB.

Of course from the first two triangles we can also determine AD and BD, and then in triangle ABD we know two sides, and the included angle, and hence can determine AB, and can use these two calculations for checks upon each other.

The calculation is performed as follows :—

Call the sides and angles of ABC — a.b.c. A.B.C. and observe that $\angle CAD = 180^\circ - (C + C' + D')$ and $\angle CBD = 180^\circ - (C' + D + D')$. Then from triangle ACD

$$AC = CD \frac{\sin. CAD}{\sin. CDA}$$

$$\therefore \log. AC = \log. CD + L. \sin. CAD + \text{ar. comp. } \log. \sin. CDA - 10.$$

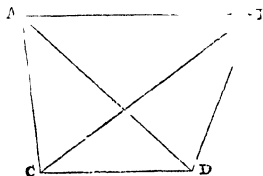

Fig. 5.

or

$$\log. b = \log. p + L. \sin. (C + C' + D') + \text{ar. comp.} : \log. \sin. D' - 10 \quad (1)$$

Similarly

$$\log. a = \log. p + L. \sin. (C' + D + D') + \text{ar. comp.} : \log. \sin. C' - 10 \quad (2)$$

From triangle ACB we have $\frac{A+B}{2} = 90^\circ - \frac{C}{2}$

$$\tan. \frac{A-B}{2} = \frac{a-b}{a+b} \cdot \tan. \frac{A+B}{2}$$

$$\text{assume } \tan. \phi = \frac{b}{a} \quad \therefore \frac{a-b}{a+b} = \frac{1 - \tan. \phi}{1 + \tan. \phi} = \tan. (45^\circ - \phi)$$

$$\therefore L. \tan. \phi = \log. b - \log. a + 10 \quad (8)$$

$$= \log. b + \text{ar. comp.} : \log. a$$

$$\text{and } L. \tan. \frac{A-B}{2} = L. \tan. (45^\circ - \phi) + L. \tan. \frac{A+B}{2} - 10 \quad (4)$$

whence we obtain $\frac{A-B}{2}$ and \therefore A and B since we know $\frac{A+B}{2}$

Finally from triangle ABC

$$c = a \frac{\sin. C}{\sin. A}$$

$$\therefore \log. c = \log. a + L. \sin. C + \text{ar. comp.} : L. \sin. A - 10 \quad (5)$$

It will be observed that in the above calculation we do not require a and b , but only $\log. a$ and $\log. b$, which are given by equations (1) and (2). (Compare Plane Trig., Art. 40.)

Example. Given $CD = 372.5$ yds. $C = 123^\circ.15'$. $C' = 13^\circ.42'$. $D = 129^\circ.11'$. $D' = 19^\circ.13'$.

$$(1) \quad \begin{array}{r} \text{Log. } b = \log. 372.5 \\ + L. \sin. 156^\circ.10' \\ + \text{ar. comp. } L. \sin. 19^\circ.13' - 10 \end{array} \quad \begin{array}{r} = 2.5711263 \\ 9.6064647 \\ .4826176 - 10. \\ \hline 2.6602086 \end{array}$$

$$(2) \quad \begin{array}{r} \text{Log. } a = \log. 372.5 \\ + L. \sin. 162^\circ.6' \\ + \text{ar. comp. } L. \sin. 13^\circ.42' - 10 \end{array} \quad \begin{array}{r} = 2.5711263 \\ 9.4876426 \\ .6255483 - 10. \\ \hline 2.6843172 \end{array}$$

$$(3) \quad \begin{array}{r} L. \tan. \phi = \log. b \\ + \text{ar. comp. } \log. a \end{array} \quad \begin{array}{r} = 2.6602086 \\ 7.3156828 \\ \hline 9.9758914 \\ 9.9757318 \\ \hline 4218159600(37.8 \\ 12654 \end{array}$$

$$\phi = 43^\circ 24' 37''.8 \quad \begin{array}{r} 33060 \\ 45 \\ \hline 29526 \end{array}$$

$$45 - \phi = 1^\circ 35' 22''.2 \quad \begin{array}{r} \hline 35340 \end{array}$$

$$(4) \quad L. \tan. \frac{A-B}{2} = L. \tan. (45^\circ - \phi) + L. \tan. \frac{A+B}{2} - 10.$$

(2). *To find the Area of a Triangle.*

Let ABC be the triangle; from A draw AN perpendicular to BC. Then, since the area of ABC is half that of a rectangle, whose base is BC and height AN, the area of triangle = $\frac{BC \times AN}{2}$

Cor.—(1). If we have given AB, BC and angle B.

$$\text{Area triangle} = \frac{BC \times AB \sin. B}{2} = \frac{ac \sin. B}{2}$$

Since AN = AB sin. B.

(2). If we have given BC and the angles of triangle,

$$\text{Then, since } \frac{c}{a} = \frac{\sin. C}{\sin. A}$$

$$\text{Area triangle} = \frac{a^2 \sin. B \sin. C}{2 \sin. A}$$

(3). If we have all the sides given (by Trigon : Art : 41)

$$\text{Area triangle} = \sqrt{s. (s - a) (s - b) (s - c)}$$

where $2s = a + b + c$.

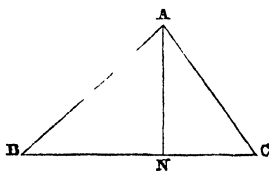

Fig. 7.

(3). *To find the Area of a Parallelogram.*

If a, b be the sides of the parallelogram, and A the angle contained by those sides, then by the last article the area of half the parallelogram

$$= \frac{ab \sin. A}{2}$$

\therefore Area of parallelogram = $ab \sin. A$,

Or, if p is the perpendicular distance between two parallel sides, each of which = a , then

$$\text{Area of parallelogram} = ap.$$

(4). *To find the Area of a Trapezoid.*

Fig. 8.

Let ABCD be the trapezoid of which the side AB is parallel to the side CD. Join BD, draw DM perpendicular to AB and BN perpendicular to DC, or DC produced, and let $a = AB$: $b = DC$ and $p = DM$ or BN . Then

$$\text{Area triangle ABD} = \frac{1}{2} ap$$

$$\text{Area triangle BCD} = \frac{1}{2} bp$$

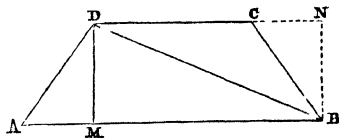
$$\therefore \text{Area ABCD} = \frac{1}{2} p (a + b)$$

Or the area of a trapezoid = $\frac{1}{2}$ sum of parallel sides + perpendicular distance between them.

(5.) To find the Area of Trapezium.

Let ABCD (Fig. 9), be the trapezium; join AC, from B and D let fall perpendiculars Bm, Dn, upon AC.

The area of triangle ABC = $\frac{1}{2}$ Bm. AC and area of triangle ADC = $\frac{1}{2}$ Dn. AC.

$$\therefore \text{Area of trapezium} = \frac{1}{2} AC (Bm + Dn.)$$

If instead of having the perpendiculars Bm and Dn given we have the sides AB. BC. CD. DA. and a diagonal, we must find the area of each triangle separately by the formula

$$\text{Area triangle} = \sqrt{s \cdot (s - a) (s - b) (s - c)}$$

Or, again, if we have the sides and one angle, as A, given, we can proceed as follows.—Let AB. = a. BC = b. CD = c. DA = d. Join BD (Fig. 10), then we can calculate BD from triangle ABD by second case of oblique-angled triangles, and having calculated BD we can determine the areas of the triangles as before.

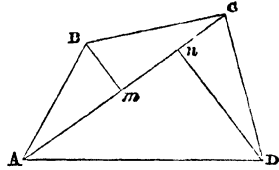

Fig. 9.

(6.) To determine the Area of an irregular Polygon.

Suppose ABCDEF to be an irregular polygon, its area can be determined by effecting the following measurements; join AD, the longest distance across the figure from BC EF, draw perpendiculars to AD, viz. Bm, Cn, Ep, Fq, respectively; measure Am, mn, nD, Cn, Bm, Aq, qp, pD, Ep, Fq.

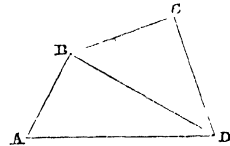

Fig. 10.

Then area of polygon = ABm + BmnC + CnD + DpE + EpqF + FqA.

$$= \frac{1}{2} Am \times Bm + \frac{1}{2} mn \times (Bm + Cn) + \frac{1}{2} Cn \times nD + \frac{1}{2} \cdot Dp + pE + \frac{1}{2} pq (Ep + Fq) + \frac{1}{2} Aq \times qF.$$

(7.) To determine the Area of a regular Polygon.

Various formulas have been already given for this in the "Treatise on Trigonometry" (Art. 45). It is there shown that if n be the number of sides of the polygon, and a the length of one of the sides,

$$\text{Area} = \frac{na^2}{4} \cotan. \frac{180^\circ}{n}.$$

Hence in case of pentagon,

$$\text{Area} = \frac{5a^2}{4} \cotan. 36^\circ = \frac{5(\sqrt{5} + 1) a^2}{4 \sqrt{10 - 2\sqrt{5}}}$$

In case of hexagon,

$$\text{Area} = \frac{3a^2}{2} \cotan. 30^\circ = \frac{3\sqrt{3} \cdot a^2}{2}$$

And so on in other cases.

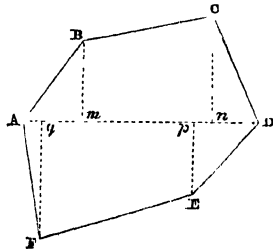

Fig. 11.

(8.) To determine the Area of a Circle.

If n is the number of sides of a regular polygon inscribed in a circle whose radius is r , then, as we have already seen (Trig: Art: 45),

$$\begin{aligned} \text{Area polygon} &= \frac{n^2}{2} \sin. \frac{2\pi}{n} \\ &= r^2 \pi \frac{\sin. \frac{2\pi}{n}}{\frac{2\pi}{n}} \end{aligned}$$

Now if we increase the number of sides of the polygon, it becomes more and more nearly equal to the circle, and in the limiting case when the number of sides is infinitely great, it becomes the circle; * but when $n = \infty \therefore \frac{2\pi}{n} = 0$ and (Trig:

Art: 47) in this case $\sin. \frac{2\pi}{n} = 1$

$$\therefore \text{Area of circle} = r^2 \pi.$$

Cor. Hence area of quadrant = $\frac{r^2 \pi}{4} = \frac{1}{2} r \frac{r \pi}{2}$.

Now $\frac{r \pi}{2}$ = the length of arc on which quadrant stands.

$$\therefore \text{Area of quadrant} = \frac{r}{2} \times \text{arc on which quadrant stands.}$$

(9.) To find Area of a Sector of a Circle.

Let AOB be any sector of a circle,

OA = r . AOB = θ (in circular measure),

$$\therefore \text{AB} = r\theta.$$

Now if AOB were a quadrant, AB would equal $\frac{r\pi}{2}$

and the area of the quadrant = $\frac{r^2 \pi}{4}$.

But in equal circles sectors are to each other as the arcs on which they stand.

$$\therefore \text{Area sector} : \text{area quadrant} :: r\theta : \frac{r\pi}{2}.$$

$$\therefore \text{Area sector} : \frac{r^2 \pi}{4} :: \theta : \frac{\pi}{2}.$$

$$\therefore \text{Area sector} = \frac{r^2 \theta}{2}.$$

$$= \frac{1}{2} r \times r\theta.$$

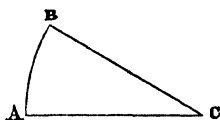

Fig. 12.

* Compare with the statement in the text what is said on page 160.

$$= \frac{1}{2} r \times (\text{arc on which sector stands}).$$

(10.) *To find the Area of a Segment of a Circle.*

Let OACB be a sector of a circle. Join AB. We are required to find the area of the segment ABC. Draw ONC perpendicular to AB. Let $\angle AOB = \theta$.
 OB = r .

$$\therefore ON = r \cos. \frac{\theta}{2} \quad AN = r \sin. \frac{\theta}{2}.$$

$$\therefore \text{area ABO} = r^2 \sin. \frac{\theta}{2} \cos. \frac{\theta}{2} = \frac{1}{2} \cdot r^2 \sin. \theta.$$

$$\text{Now area ACBO} = \frac{1}{2} r^2 \theta.$$

$$\therefore \text{area of segment} = \frac{r^2}{2} (\theta - \sin. \theta).$$

Cor.—From A draw An perpendicular to OB. Then $An = r \sin. \theta$, also arc ACB = $r \theta$.

Hence the area of segment

$$= \frac{r}{2} (r\theta - r \sin. \theta)$$

$$= \frac{r}{2} \times (ACB - An)$$

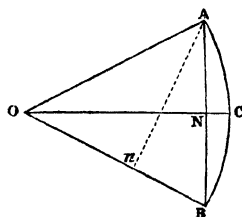

Fig. 13

(11.) *To find the space between two Concentric Circles, viz. ABCEDF.*

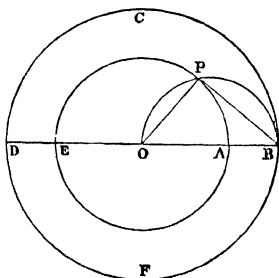

Fig. 14.

Let $OA = r$ $OB = r_1$.

Then area of interior circle = πr^2

and area of exterior circle = πr_1^2

$$\therefore \text{Area of the space between the circles} = \pi (r_1^2 - r^2)$$

On OB as a diameter, describe a circle OPB cutting the interior circle in P; join OP, PB, then OPB is a right angle,

$$BP^2 = OB^2 - OP^2 = r_1^2 - r^2$$

$$\therefore \pi BP^2 = \pi (r_1^2 - r^2)$$

also since OPB is a right angle, BP touches the circle, or the area of the space in question is equal to the area of a circle whose radius is the length of the line drawn from any point

in the exterior circle to touch the interior circle.

The above cases of areas of plane figures are the chief of those which belong to Elementary Mathematics. The determination of areas bounded by curved lines belongs, of right, to the Integral Calculus; the following propositions, however, are best given here, though the reasoning is not of a strictly elementary character.

(12.) To find the Area of an Ellipse.*

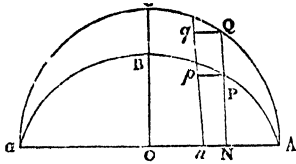

Fig. 16.

Now, by a property of the ellipse,

$$\begin{aligned} NQ &: NP :: a : b \\ \therefore nQ &: nP :: a : b \end{aligned}$$

and hence, if we suppose a series of parallelograms to be described in circle and ellipse, the same proportion will hold good between each of these, and therefore

Sum of parallelograms in semicircle : sum of parallelograms in semi-ellipse :: $a : b$. and this being true, however great the number may be, is true in the limit.

Now the semi-ellipse is the limit of the parallelograms inscribed in it, and the semicircle is the limit of parallelograms inscribed in it.

$$\begin{aligned} \therefore \text{semicircle} &: \text{semi-ellipse} :: a : b \\ \therefore \text{circle} &: \text{ellipse} :: \pi a^2 : \pi ab \end{aligned}$$

But area of circle = πa^2

\therefore area of ellipse = πab .

* Let APQ be an area included by two straight lines AB, AP, and the curve PQ; divide AQ into equal parts Aa, ab, bc, cd, dQ, and on these lines draw the rectangles Ap, ag, br, cs within the

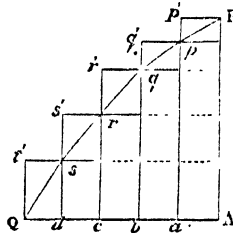

Fig. 15.

curved areas, and complete the parallelograms Ap', aq', br', cs', dt. Then it is plain that the difference between the interior parallelograms (Ap, ag, br, cs) and the exterior parallelograms (Ap', aq', br', cs', dt) will equal Ap'. Now, by making the number of parallelograms very large, Aa, and \therefore Ap' will become very small, and may be made less than any magnitude that may be assigned. Now the curvilinear area is clearly greater than the interior and less than the exterior parallelograms, and therefore differs from the interior parallelogram by a quantity less than Ap'; i. e., a quantity that can be made less than any that can be assigned: and therefore the curvilinear area is the limit to which the sum of the interior parallelograms continually approaches when their number is increased.

(13.) Let q PQ be portion of a Parabola. It is required to find its Area.

Bisect Qq in V , draw the diameter PV . Through P draw r PR parallel to QV q , and draw QR and qr parallel to PV . Then the area q PQ is two thirds of qr RQ.

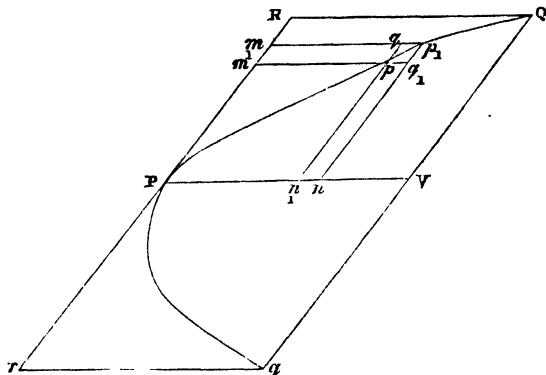

FIG. 17.

Take p and p_1 , two points in PQ , and through p , draw $p_1 m_1$, $p_1 n_1$ parallel to PV and QV , and through p draw pm pn also parallel to PV , QV , and produce them to meet $p_1 n_1$ in q_1 and $p_1 m_1$ in q respectively. Then

$$\begin{aligned} \text{Parallelogram } pm_1 & : \text{parallelogram } pn_1 :: p n \times n n_1 : p m \times m m_1. \\ & :: p n \times (Pn_1 - Pn) : Pn \times (p_1 n_1 - pn) \end{aligned}$$

Now, by a property of the parabola

$$\begin{aligned} Pn & : P_1 n_1 :: pn^2 : p_1 n_1^2 \\ \therefore Pn & : Pn_1 - Pn :: pn^2 : p_1 n_1^2 - pn^2 \\ \text{or } Pn & : Pn_1 - Pn :: pn^2 : (p_1 n_1 - pn) (p_1 n_1 + pn) \\ \therefore Pn \times (p_1 n_1 - pn) & : (Pn_1 - Pn) pn :: pn : p_1 n_1 + pn \\ \therefore \text{parallelogram } pm_1 & : \text{parallelogram } pn_1 :: pn : p_1 n_1 + pn. \end{aligned}$$

Now in the limit $p_1 n_1$ differs from pn by a quantity less than any that can be assigned.

$$\therefore \text{In the limit } pn : p_1 n_1 + pn :: 1 : 2$$

$$\therefore \text{In the limit parallelogram } pm_1 : \text{parallelogram } pn_1 :: 1 : 2$$

which proportion is true for each pair of parallelograms inscribed in PQR and PQV , and \therefore is true of all.

\therefore In the limit sum of parallelograms in PQR : sum of parallelograms in PQV :: 1 : 2

But the area PQR is the limit of the sum of the parallelograms inscribed in it; and PQV is the limit of the sum of the parallelograms inscribed in it.

$$\therefore PQR : PQV :: 1 : 2$$

$$\therefore PQVR : PQV :: 3 : 2$$

Now $PQVR$ is the half of qr QR, and PQV is the half of PQq .

$$\therefore PQq = \frac{2}{3} qr. \text{ QR.}$$

Q. E. D.

(14). To find approximately the Area of a Plane Figure bounded by a Curve.

Let $ABPQ$ be the figure; divide AB into equal parts, AN_1, N_1N_2, N_2N_3 , &c., and draw ordinates P_1N_1, P_2N_2, P_3N_3 , &c. parallel to AP or BQ , and perpendicular to AB .

(1). As a first approximation the curved area may be considered as identical with the polygonal area inclosed by $PABQ$ and the chords PP_1, P_1P_2, P_2P_3 , &c. In this case, the area required = $AN_1P_1P + N_1N_2P_2P_1 + N_2N_3P_3P_2$, &c.

$$= AN_1 \times \frac{AP + P_1N_1}{2} + N_1N_2 \times \frac{P_1N_1 + P_2N_2}{2} \\ + N_2N_3 \times \frac{P_2N_2 + P_3N_3}{2}, \text{ \&c.}$$

$$= AN_1 \left(\frac{AP}{2} + P_1N_1 + P_2N_2 + P_3 + \dots + \frac{QB}{2} \right)$$

Or the area = (the distance between any two consecutive ordinates) \times (half the sum of the extreme ordinates, together with the sum of all the intermediate ordinates)

Or if $AN_1 = \Delta$ $AP = a$ $QB = b$
 $P_1N_1 = y_1$ $P_2N_2 = y_2$ $P_3N_3 = y_3$ &c.

$$ABQP = \Delta \left(\frac{a+b}{2} + y_1 + y_2 + y_3 + \dots + y_n \right)$$

(2). The above is a good approximation, but a much better may be found in the following manner. Consider the portion of the curve between any three consecutive P_s , such as $P_2 P_3 P_4$, through P_3 draw a line $n P_3 m$ touching the curve, and let it meet $N_2 P_2, N_4 P_4$ produced in n and m . Draw $P_2 p$ perpendicular to P_4 , N_4 , join $P_2 P_4$ meeting $P_3 N_3$ in q . Now we may consider $P_2 P_3 P_4$ a portion of a parabola,* and

\therefore the curvilinear area $P_2 P_3 P_4 = \frac{2}{3}$ of $n P_2 P_4 m$.

$$= \frac{2}{3} m P_4 \times P_2 p.$$

$$= \frac{2}{3} P_3 q \times P_2 p.$$

Now $N_3 q = \frac{1}{2} (y_2 + y_4)$ and $P_2 p = N_2 N_4 = 2 \Delta$

$$\therefore P_3 q = P_3 N_3 - q N_3 = y_3 - \frac{1}{2} (y_2 + y_4)$$

$$\therefore P_2 P_3 P_4 = \frac{4}{3} \Delta \left\{ y_3 - \frac{1}{2} (y_2 + y_4) \right\}$$

Now the area $P_2 P_4 N_4 N_2 = \Delta (y_2 + y_4)$

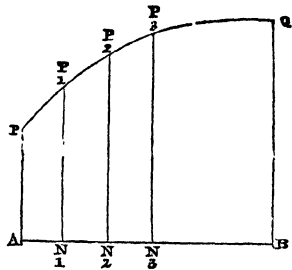

Fig. 8.

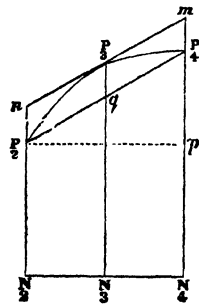

Fig. 10.

* It appears from Newton, (Lemma XI. Lect. 1.) that in any curve of finite curvature, $P_3 q$ is in the limit as the square of $q P_4$. Now it is the characteristic property of the parabola that $P_3 q$ is as the square of $q P_4$; hence every curve of finite curvature tends to a parabola as its limit, and so if we take a small arc $P_2 P_3 P_4$ we may consider it to be a parabolic arc, without making any appreciable error.

∴ the whole area $P_2 P_3 P_4 N_4 N_2 = \frac{\Delta}{3} (4y_3 + y_2 + y_4)$

Hence the area of the figure $P A B Q$ (fig. 18), which equals $P A N_2 P_2 + P_2 N P_4 N_4 + P_4 N_4 P_6 N_6 + \dots$

$$= \frac{\Delta}{3} \cdot (a + 4y_1 + y) + \frac{\Delta}{3} (y_2 + 4y_3 + y_4) + \frac{\Delta}{3} (y_4 + 4y_5 + y_6) + \dots + \frac{\Delta}{3} \cdot (y_{2n} + 4y_{2n-1} + b)$$

reckoning that there are $2n + 1$ (an odd number) ordinates drawn between the two extreme ones PA, QB .

$$\therefore PABQ = \frac{\Delta}{3} \cdot \left\{ a + b + 4(y_1 + y_3 + y_5 + \dots + y_{2n} + 1) + 2(y_2 + y_4 + y_6 + \dots + y_{2n}) \right\}$$

or the area

$$= \frac{\Delta}{3} \times (\text{sum of extreme sides} + 4 \text{ sum of odd ordinates} + 2 \text{ sum of even ordinates.})$$

Hence the Rule:—At equal distances along the base AB draw an odd number of ordinates parallel to the parallel sides of the figure; then take the sum of the parallel sides, of four times the odd ordinates, and twice the even ordinates, and multiply the third part of this sum by the common distance between the ordinates, and this product is the area of the figure.

Besides the above areas of plane surfaces, there are areas of certain solids which will be best given here, viz., the areas of a prism, a cylinder, a pyramid, a cone, and a sphere.

DEF. 1.—A prism is a solid bounded by two equal and similar rectilinear figures in parallel planes and by parallelograms.

Thus $ABCDE, abcde$, is a prism bounded by two equal and similar pentagons whose planes are parallel ($ABCDE$, and $abcde$), and by parallelograms $AaBb, BbCc$, &c. A prism is called a right prism when the planes of the parallelograms are perpendicular to the plane of the base (*i.e.* $abcde$ in the accompanying figure).

DEF. 2.—A pyramid is a solid bounded by any plane rectilinear figure, and by triangles having a common vertex, and for bases the sides of the rectilinear figure respectively.

Thus (Fig. 21) $PABCD$ is a pyramid, on a quadrilateral base, $ABCD$.

DEF. 3.—A cylinder is a solid whose surface is traced out by a straight line which always moves parallel to its first position and whose extremity is guided by a given curve.

Thus (Fig. 22) if acb is a circle, and Aa a straight line perpendicular to the plane of the circle, then $ABCabc$ is a cylinder which is traced out by a line Cc , that is always parallel and equal to Aa . This cylinder is strictly defined as a "right cylinder with a circular base" it is, however, in elementary treatises generally called "a cylinder."

DEF. 4.—A cone is a solid, the surface of which is traced out by a straight line,

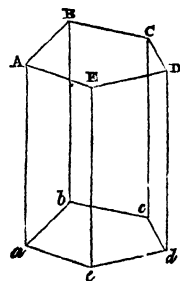

Fig. 20.

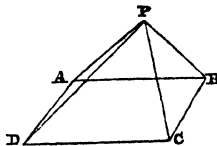

Fig. 21.

one end of which passes through a fixed point, and the other end through a given plane curve, called its base.

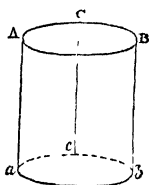

Fig. 22.

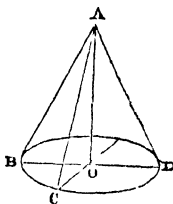

Fig. 23.

If BCD (Fig. 23) is a circle, and a a fixed point, the surface $ABCD$ is called a cone on a circular base. If O is the centre of the circle, join A ; then if straight lines, draw from A to different points in circumference of circle, make equal angles with AO ; or if (which is the same thing) AO is perpendicular to plane of circle, $ABCD$ is strictly defined as "a right cone with a circular base;" or as it is more generally called in elementary treatises, a "right cone."

N.B. It is manifest that if a regular polygon is inscribed in the circle BCD , and its angular points are joined with A , that the resulting solid will be a pyramid inscribed in the cone; and also, that if we increase the number of sides in the polygon, the inscribed pyramid will approach more nearly to the cone; and, since the circle is the limit of the inscribed polygon, the cone will be the limit of the inscribed pyramid.

Similarly, the cylinder will be the limit of the inscribed prism.

(15.) *To find the Area of a right Prism.*

In figure (20) $AEca$ is a rectangle. Since the planes Ab , Ac being perpendicular to the base, their cone of intersection Aa is also perpendicular to the base, and therefore angle Aac is a right angle. Hence the area of $AEca$ is $Aa \times AE$, similarly of all the other parallelograms. Hence the area of the parallelograms is $Aa (AE + ED + DC + \dots) = AE \times$ (the perimeter of the base.) Hence the whole area = height \times perimeter of base + areas of the two ends.

(16.) *To find the Area of the surface of a right Cylinder.*

Since the surface of the cylinder is the limit of the surface of the inscribed prism, and the area of the prism = height \times perimeter of base + $2 \times$ base, whatever be the number of sides to the base, this will be true in the limit when base is a circle.

\therefore Area of a cylinder = height \times perimeter of base + $2 \times$ base.

Hence, if h = height, and a = radius of base.

$$\text{Area of cylinder} = 2\pi ah + 2\pi a^2 = 2\pi a(a + h).$$

(17.) To find the Area of the curved surface of a right Cone.

Let PACDB be the cone, ACDB its circular base, O the centre of the circle, then PO is at right angles to plane of the circle. In the circle inscribe any regular polygon, ACD . . . and join PA, PC, PD . . . Bisect CD in n , join P n . Then P n is perpendicular to CD, and \therefore the area of triangle PCD = $\frac{1}{2}$ CD, P n . Now the line joining P with the bisection of any other side of the polygon is equal to P n .

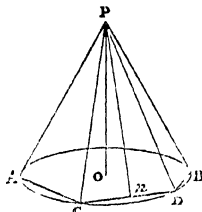

Fig. 24.

$$\begin{aligned} \text{Hence area of pyramid inscribed in cone} \\ &= \frac{1}{2} PN (AC + CD + DB + \dots) \\ &= \frac{1}{2} PN \times \text{perimeter of polygon.} \end{aligned}$$

Now, this is true whatever be the number of sides the polygon may have, and hence is true in the limit; when perimeter of polygon = circumference of circle, and P n is drawn to a point in circumference, or is = slant side of cone,

$$\therefore \text{Area of curved surface of cone} = \frac{1}{2} \text{slant side} \times \text{circumference of base.}$$

COR.—If we suppose that the surface of a cone is capable of being unwrapped, it is plain that its surface will be a sector of a circle whose radius is the slant side of cone, and base of the same length as the circumference. It is plain (Mensuration, Art. 9,) that the area of this sector is, as it should be, the same as that of the surface of cone.

DEF.—The frustum of a cone or pyramid is the portion cut off by a plane parallel to the base; thus, AB α is a frustum of the cone CAB.

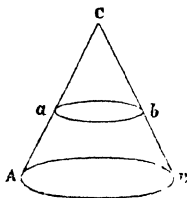

Fig. 25.

(18.) To find the Area of the Frustum of a Cone.

Suppose a sector, OPQ, (Fig. 26) of a circle is described with radius OP = CA (Fig. 25), and if its base PQ = circumference of AB, we have seen that the area of POQ is the same as that of the cone CAB. Take O q — Ca, and describe the arc O qp . Then as before, area of o pq = area of Cab, and \therefore the area of frustum = $qQPp$.

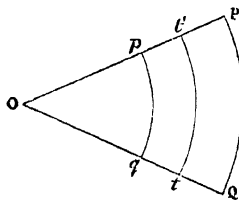

Fig. 26.

$$\begin{aligned} \text{Let angle POQ} &= \theta. \quad Oq = r' \quad OQ = r \\ \therefore \text{Area } Oqp &= \frac{1}{2} r'^2 \theta \\ \therefore \text{Area } OPQ &= \frac{1}{2} r^2 \theta \\ \therefore \text{Area } qOPp &= \frac{1}{2} \theta (r^2 - r'^2) \\ &= \theta \frac{r + r'}{2} \times (r - r'). \end{aligned}$$

Bisect qQ in t and draw arc $t't'$

$$\text{Then } \frac{r + r'}{2} \theta = t't' \text{ and } r - r' = qQ.$$

\therefore Area of frustum = rectangle between Qq and $t't'$ or between slant side of cone and circumference of mean section of frustum.

(19.) To find the Area of a portion of the surface of a Sphere.

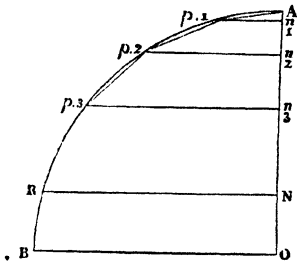

Fig. 27.

Let AB be a quadrant of a circle whose radius is AB or OB . If we suppose the quadrant to revolve round AO it will describe a hemisphere, and if we suppose a number of equal chords, $Ap_1, p_1'p_2, p_2, p_3, \&c.$ to be drawn from point to point of AB , these chords in the revolution will describe frustums of cones; now the arc AR is the limit of the chords $Ap_1 + p_1p_2 + p_2p_3 + \dots$ and hence the area of the portion of sphere described by AR will be the limit of the sum of the frustums of cones described by

$$Ap_1, p_1p_2, p_2p_3, \dots$$

Let PQ (Fig. 28) be one of these chords: draw PM, QN perpendicular to AO . Draw O

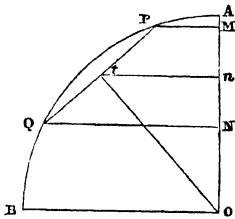

Fig. 28.

$$= 2\pi tn \times PQ$$

$$\text{Now } tn = Ot \sin. tOA.$$

$$\text{and } PQ \sin. PQN = NM.$$

$$\text{or since } PQN = tOA.$$

$$PQ \sin. tOA = NM$$

$$\therefore tn. PQ = Ot. NM.$$

$$\text{And area of frustum} = 2\pi Ot. NM.$$

In (fig. 27) draw p_1n_1, p_2n_2, p_3n_3 perpendicularly AO . Then, since Ap_1, p_1p_2, p_2p_3 are all equal, the perpendiculars on them are equal, and therefore the sum of areas of frustum of cone

$$= 2\pi Ot \times (An_1 + n_1n_2 + n_2n_3 + \dots)$$

$$= 2\pi Ot \times AN.$$

if we only consider the portion of sphere described by AR . This is true, however great the number of chords, and is therefore true in the limit; but in the limit $Ot =$ radius of sphere

$$\therefore \text{Area of portion of sphere, whose height is } AN \\ = 2\pi. OA. AN.$$

If we take the whole sphere. $AN = 2OA$

$$\therefore \text{Area of sphere} = 4\pi. (OA)^2.$$

Cor.—In the sphere $2\pi \times OA =$ circumference of a great circle.

\therefore Area of portion of a sphere $=$ height of portion \times circumference of a great circle.

If we imagine a right cylinder to be described about a sphere, its curved area $=$ circumference of a great circle \times diameter of sphere $=$ area of sphere.

Hence, "area of sphere $=$ area of circumscribing cylinder."

Exam : How many square miles of sea are visible from the top of a mast 80 feet above the surface?



Let O be the centre of earth, draw OA, OC , so that AC is perpendicular to OC . draw CN perpendicular to OA . Then, if $BN = x$. $OB = r$. The area visible from A will be the area of the part of the sphere whose depth is BN

i.e. will $= 2\pi r x$.

Now, let $AB = p$. Then, by similar triangles

$$r + p : r :: r : r - x.$$

$$\therefore r - x = \frac{r^2}{r + p}.$$

$$\therefore x = \frac{rp}{r + p}.$$

and visible area $= \frac{2\pi r^2 p}{r + p}$

$$= 2\pi r p \text{ very nearly.}$$

Now, $\pi = 3.14159$.

$r = 3958$ miles

$p = 80$ feet $= \frac{80}{5280} = \frac{1}{66}$

\therefore visible area $= 2 \times 3.14159 \times 3958 \times \frac{1}{66}$

$= 378$ nearly.

Fig. 29.

III. THE MENSURATION OF SOLIDS.

- (1.) *If two solid Angles are each contained by three Plane Angles, that are equal each to each, then the inclination of the Planes will be equal, each to each.*

Let O, o , be two solid angles contained by the plane angles AOB, BOC, COA , and

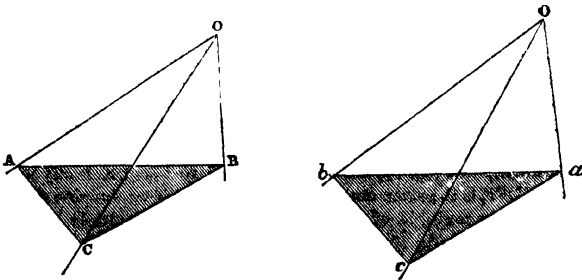

Fig. 30.

aob, boc, coa , respectively, Then the plane AOB is inclined to plane COA at the same angle that aob is inclined to aoc . For, take $OA = oa$ and let the plane CAB be

perpendicular to OA , and cab perpendicular to oa . Then angles CAO , BAO , cao , bao , are right angles; and CAB , cab , are the inclination of the planes in question.

Now in triangles AOB , aob , we have $OA = oa$ and angles BOA , $OAB =$ angles boa , oab , each to each, $\therefore OB = ob$ and $AB = ab$ (Euclid, I. 26); similarly in triangles COA , coa , we have $OC = oc$ and $AC = ac$.

Then in triangles BOC , boc , we have the sides BO , $OC =$ sides bo , oc , each to each, the included angle $BOC = boc$. \therefore (Euclid, I. 4) the base $CB =$ base cb .

Hence, finally, in triangle ABC , abc , we have the sides BA , $AC =$ the sides ba , ac each to each, and the base $BC =$ base bc . \therefore (Euclid, I. 8) $CAB = cab$. Q.E.D.

Cor. 1. Hence (fig. 30), if the solid angle O be superimposed on the solid angle o , so that AO coincides with Oa , and the plane AOB with plane aob , then, because angle $AOB =$ angle aob the line OB coincides with ob , and because inclination of plane COA to AOB equals that of coa to cob the plane COA will coincide with coa , and hence OC with oc .

Cor. 2. If $ABCDEF$ and $abcdef$ are two prisms, the edges of which are equal each to each, and the plane angles at B equal those at b , the prisms are equal in all respects.

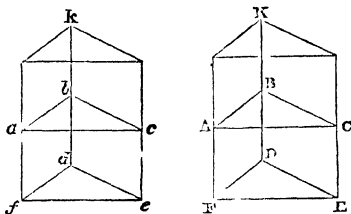

Fig. 31.

For, if the triangle ABC be applied to abc so that AB coincides with ab , and BC with bc , it is plain by the last corollary that BD coincides with bd . And hence the prisms will coincide throughout.

Cor. 3.—If $ABCD$ $abcd$ be a parallelepiped* (i.e. a prism on a parallelogram for a base) it can be divided into two equal prisms by a plane $ACca$ passing through the diagonals of its bases; for it is obvious that the edges of these prisms are equal, each to each, and also that the plane angles containing the solid angles at D and B are equal.

Cor. 4.—Again (in fig. 31) if we suppose the base DEF of the one prism to be in all respects equal to that of the other def , and if the angles at D are equal to the angles at d , each to each, then it is plain that if DB is $> ab$ the prism $BDFE$ is $>$ prism $bdfe$, and if $DB < ab$, the prism $BDFE <$ prism $bdfe$. Also if BD is double of bd , the prism $BDFE$ is double of the prism $bdfe$, and generally if BD is any multiple of bd , then $BDFE$ is the same multiple of $bdfe$.

Cor. 5.—If we suppose (fig. 31) BD produced to K so that DK is any multiple of DB , the prism $KDFE$ is the same multiple of $BDFE$; and if we suppose db produced to k so that kd is any multiple of bd , then $kdfc$ is the same multiple of $bdfe$. But if $KD > kd$, $KDFE > kdfc$; if equal, equal; if less, less. \therefore (Euclid, 5. p. 136).

$$BDFE : bdfc :: BD : bd.$$

Cor. 6. The results proved in Cors: 4 and 5 to be true of prisms, are manifestly true of paral^lps.

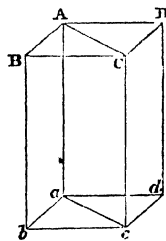

Fig. 32.

* We shall use throughout the abbreviation paral^lps for parallelepiped.

(2.) *Parallelepipeds on the same Base and of the same Altitude are equal to one another.*

If the Parallelepipeds are on the same base and of the same altitude, it is manifestly that the ends opposite the common base are in the same plane.

(a) Suppose two of the edges of the ends opposite to the base of each figure to be in the same straight line.

Let $DBEG$, $DBeg$, be the parallelepipeds on the same base BD , and of the same altitudes, and suppose that EH , eh , are in the same straight line, and also FG , fg , in the same straight line. Then it is obvious that $Ee = Hh$, $HC = ED$, and angle $hHC = \text{angle } eED$.

\therefore the base $eED = \text{base } hHC$, also $HG = FE$, and the plane angles that form the solid angles at H and E are equal each to each, \therefore the prism $hCHG = \text{the prism } eDEF$. Hence if we suppose the former prism taken from the whole figure $hCDEF$, and the latter to be taken from the same figure, the remainders will be equal $\therefore DBEG = DBeg$.

(b) Suppose that no two of the edges of the side opposite to the base are in the same straight line.

Let $DBEG$, $DBeg$, be the parallelepipeds on the same base BD , and being of the same altitude, their ends EG , eg , are in the same plane. Produce EH , FG , fe , gh , to meet, they will evidently form a parallelogram, let this parallelogram be $KLMN$, then LK , MN , and FE , $GH = AD$, BC , each to each, and KN , $LM = Eh$, $fg = DC$, AB , each to each, and angle $MLK = \text{angle } GFE = \text{angle } BAD$.

\therefore $LKMN$ is equal to $ABCD$. Join AL , BM , CN , DK . Then $DBMK$ is a parallelepiped—and by the first part of this proposition, $BDMK$ is equal to each of $BDGE$, and $BDge$. $\therefore BDGE = BDge$. Q. E. D.

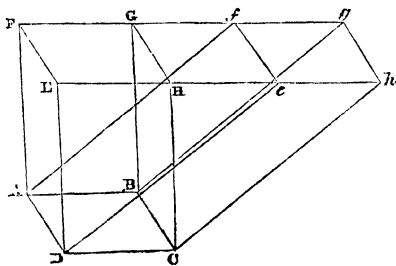

Fig. 33.

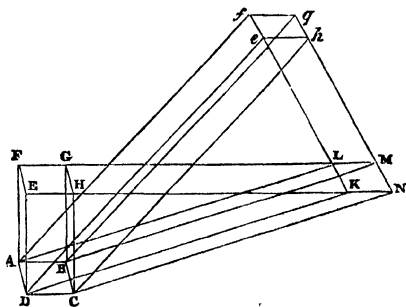

Fig. 34.

(3.) *Solid Parallelepipeds on equal Bases and of the same Altitudes, are equal to each other.*

(a.) Suppose the edges to be perpendicular to the bases. To avoid a complicated

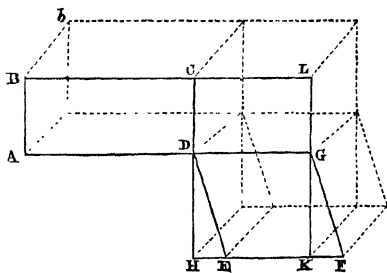

Fig. 35.

figure we will only letter the bases, and will call the edges of figure that are perpendicular to the bases by the letters at the angles of the base. Thus the edge B means the edge perpendicular to the base at the point B—i.e., Bb. Let AC, DF be the bases where we suppose the solids to be so placed as to have a common edge D, and the sides AD, DE in the same straight line, produce CD, and FE to meet in H, through G draw LGK parallel CD and produce BC to meet KG in L.

Now since $DH = GK$, and HE is evidently $= KF$ and the angle $DHE = GKF$ \therefore the base $DHE =$ base GKF ; and since edges H and K are perpendicular to base, the solid angle at H is contained by plane angles respectively equal to those containing the angle K ; and hence the prisms whose bases are DHE and GKF are equal. Add the solid on base $DEKG$ to both, \therefore $\text{paral}^{\text{ppd}}$ on $DK = \text{paral}^{\text{ppd}}$ DF .

Now $\text{paral}^{\text{ppd}}$ $BD : \text{paral}^{\text{ppd}}$ $DL :: AD : DG :: BD : DL$

and $\text{paral}^{\text{ppd}}$ $DL : \text{paral}^{\text{ppd}}$ $DK :: CD : DH :: DL : DK$

\therefore (Ex equali).

$\text{paral}^{\text{ppd}}$ $BD : \text{paral}^{\text{ppd}}$ $DK :: BD : DK$

But $BD = DK$, since (Eucl. I. 35) $DK = DF$

$\therefore \text{paral}^{\text{ppd}}$ $BD = \text{paral}^{\text{ppd}}$ $DK = \text{paral}^{\text{ppd}}$ DF .

(b.) If the edges are not perpendicular to the bases, call the $\text{paral}^{\text{ppd}}$ P and Q . If on P 's base a $\text{paral}^{\text{ppd}}$ p is described, whose edges are perpendicular to base and whose altitude is same as P , then $p = P$ by last Proposition, and if q be in like manner described on same base as Q , but having its edges perpendicular to the base, then (last Proposition) $q = Q$, and by the former part of this Proposition, $q = p$, $\therefore Q = P$.

Q.E.D.

COR. 1.—Hence if there be two $\text{paral}^{\text{ppd}}$'s of the same altitude, but the base of the one is double of the base of the other, the former is double of the latter, and generally if the base of the one is any multiple of the base of the other, the former $\text{paral}^{\text{ppd}}$ is the same multiple of the latter; and hence, by reasoning similar to that employed in Cor. 5. Prop. 1. of the present article, it appears that $\text{paral}^{\text{ppd}}$'s of equal altitudes are as their bases. And again, if they have equal bases, they are to one another as their altitudes.

COR. 2.—Let there be two $\text{paral}^{\text{ppd}}$'s P, P' , the base and height of one of which are A and h , and one of the other A' and h' , where $A/h = A'/h'$ are in numbers. And suppose S to be a third $\text{paral}^{\text{ppd}}$ on the base A' and the height h .

* Then $P : S :: A : A$
 $S : P' :: h : h'$
 $\therefore P : P' :: Ah : A'h'$

COR.-3.—If we suppose P' to be a cube which has one of its edges equal to unity, then $A' = 1$. and $h' = 1$.

$\therefore P : P' :: Ah : 1$.

hence if we consider P' to be the unit of solid measure (a cubic inch, or foot, for instance) then $P = Ah$.

Hence the volume of a paral^{ppd} is found by multiplying the area of one face by the distance between that face and the opposite one.

COR. 4.—We have seen that a prism on a triangular base is half of a paral^{ppd} of the same altitude and on a base which is double of the triangle. Hence if A is the area of the triangle, and h the height of the prism, the volume of this paral^{ppd} = $2A \times h$, and \therefore the volume of the prism = $A \times h$; or the volume of a prism on a triangular base is found by multiplying the area of the base by the altitude.

COR. 5.—It is plain that a prism on a polygonal base can be divided by planes passing through one edge of the prism into a number of prisms on triangular bases, each having the same altitude as the original prism.

Let $A_1 A_2 A_3 \dots$ be the areas of these triangles, and h the common altitude, the volumes of all these prisms

= $(A_1 + A_2 + A_3 + \dots) h$.

But the polygon is equal to all the triangles; hence if A is the area of the polygon,

$A = A_1 + A_2 + A_3 + \dots$

\therefore The volume of the prism on a polygonal base = Ah , or is equal to the base multiplied by the altitude.

COR. 6.—It is plain that Cor. 5 is true of a regular polygon of any number of sides, and therefore is true in limit; now when the number of sides of the polygon is increased, its limit is the circumscribing circle, and the limit of the corresponding prism is the circumscribing cylinder. Hence the volume of a cylinder = Ah , or base \times height.

N.B.—When we speak of the volume of a solid, a prism for instance, being equal to the base multiplied by the height, it is of course understood that all the measurements are referred to the same unit. Thus, if we were asked what is the volume of a prism whose base is 2 square feet, and height 18 inches, the answer is, not 2×18 , but $2 \times \frac{18}{12} = 3$, and the 3 is in CUBIT FEET. The cubit foot and the square foot being the unit of content and of area corresponding to the linear unit one foot.

(4.) If P, ABC is any pyramid on a triangular base, and if through the middle point (D) of one of the sides (AP) we draw planes (DGH and DEF) parallel to one of the faces (PBC) and to the base (ABC) of the pyramid, then if we suppose a plane to be drawn through DE and DH , cutting off a prism EFD, HKC , the figure $EDGHC$ is double of the prism EDF, HKC .

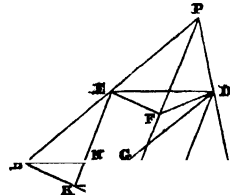

Since the plane EDF is parallel to ABC , ED is parallel to AB . Now AP is bisected in D . \therefore PB is bisected in E . Similarly AC is bisected in H . Also since plane DEF is parallel

to ABC. \therefore ED is parallel to KH, and \therefore KH is parallel to AB. Draw CN perpendicular to AB, meeting KH in M, then since CH : HA :: CM : MN (Euclid VI. — 2), and CH = HA \therefore CM = MN. Hence, if from N and C perpendiculars are drawn on the plane, DEKH, they are equal. Hence parallels on the base DEKH, with these perpendiculars respectively for altitudes, are equal. Now the prism BEKHDG is half the former, and the prism KCHDFE is half the latter. Hence the prisms are equal, and they are together double of one of them. But the two prisms make up the figure EDGHCB, which is, therefore, double of the prism EDFHKC.

(5.) *Pyramids on triangular Bases and of equal Altitudes are to one another as their Bases.*

Let P, ABC, p, abc be the two pyramids, and let them be divided by planes as in the last proposition.

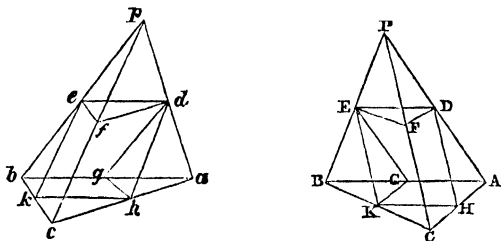

Fig. 37.

Now $efd : bca$ in the duplicate ratio of $fd : ca$; but $fd : ca :: 1 : 2 \therefore efd : bca :: 1 : 4$. Similarly $EFD : BCA :: 1 : 4 \therefore efd : bca :: EFD : BCA$ or $efd : EFD :: bca : BCA$. But the prism $efdkch$: prism $EFDKCH :: efd : EFD :: abc : ABC$. \therefore (by last proposition)

The double prism $edghcb$: $EDGHCB :: abc : ABC$.

Now if we suppose pd and PD , and also da and DA figures will be formed p,dfc , and P,DFE of the same kind as in p,abc and P,ABC , and also in d,agh and D,AGH , and these figures will have to each other the ratios $efd : EFD$ and $agh : AGH$ respectively; which ratios are each equal to the ratio $abc : ABC$. And the same will be true, however often we continue to bisect the bisections of the sides, and hence

All the double prisms in p,abc : all those in $P,ABC :: abc : ABC$.

And the number of successive bisections being as great as we please, this is true in the limit. Now the pyramids are the limits of the sum of these double prisms. Hence

p,abc : $P,ABC :: abc : ABC$.

Q. E. D.

Cor : Hence pyramids on equal bases and of the same altitude are equal.

(6.) *Every Prism on a triangular Base can be divided into three equal Pyramids.*

Let ABE, DFC be the prism; draw a plane through DE and E, cutting off the pyramid E, DFC, and through ED and B draw a plane dividing the remainder into two pyramids E, ABD and E, BCD. Now since these two latter have their vertices coincident at E, and since their bases ABD, BDE are manifestly equal being halves of the parallelogram AC, the two pyramids E, ABD and E, BDE are equal. Now the pyramid E, ABD is clearly the same as the pyramid D, ABE. But the base ABE = base DEF, and the perpendicular from E on DFE, is equal to that from D on ABE, since these planes are parallel; hence the pyramid D, ABE = pyramid E, DFE, and therefore the three pyramids are equal.

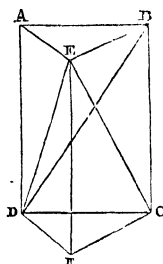

Fig. 38.

Cor. 1.—Hence if a pyramid and a prism have equal triangular bases and are of equal altitudes, the pyramid is one third part of the prism.

Cor. 2.—Let A = area of base, h = height of pyramid. Then the volume of the prism on base A and of height $h = Ah$. And \therefore the volume of pyramid = $\frac{Ah}{3}$.

Cor. 3.—If we have a pyramid on a polygonal base of which the area is A , it can be divided into triangles whose areas we will suppose to be A_1, A_2, A_3, \dots so that $A = A_1 + A_2 + A_3 + \dots$. Now if h be the height of the pyramid, then its volume being clearly the sum of the pyramids whose bases are A_1, A_2, A_3, \dots and height h , will equal

$$\frac{1}{3} h (A_1 + A_2 + A_3 + \dots) = \frac{1}{3} Ah.$$

Cor. 4.—This is true, however great the number of sides there are to the polygon, and hence is true in the limit. Now if we suppose the polygon to be regular, its limit is the circumscribing circle, and the limit of the pyramid is the circumscribing cone \therefore volume of cone = $\frac{Ah}{3}$ where A is the area of the circular base.

(7.) *To determine the Volume of the Frustum of a right Prism on a triangular Base.*

Let ABC, DEF be the frustum, where ABC is perpendicular to the edges. Let A = area of ABC, and let h_1, h_2, h_3 be the edges AF, BE, CD respectively, and V the required volume. Join FC and suppose plane to pass through FCE, cutting off the pyramid C, FED, and another through ECA cutting off the pyramids E, ABC, E, ACF, these three make up the volume V . Join FB, DB, and DA. Now volume of E, ABC = $A \frac{h_2}{3}$; volume of E, FAC = volume of B, FAC; since perpendiculars from E and B on the plane ACF are clearly equal, and B, FAC is the same pyramid as F, ABC, the volume of which is $A \frac{h_1}{3}$.

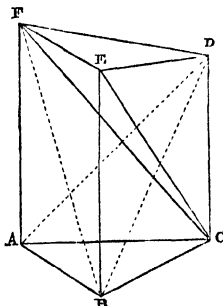

Fig. 39.

Again, since FA is parallel to DC, the triangle ACD

is = the triangle FCD, and we have already seen that the perpendiculars from E and B on the plane ACDF are equal, \therefore the pyramid E, CDF = the pyramid B, ACD, i. e. = D ABC, the volume of which is $A \frac{h_3}{3}$.

$$\therefore V = A \frac{h_1}{3} + A \frac{h_2}{3} + \frac{h_3}{3} = A \frac{h_1 + h_2 + h_3}{3}$$

Cor: If the prism be ABC FED, in which neither of the ends is perpendicular to the edges, take abc an area whose plane is perpendicular to the edges, and let A = area of abc .

$$\text{Let } AE = h_1 \quad BD = h_2 \quad CF = h_3$$

$$aE = x_1 \quad bD = x_2 \quad cF = x_3$$

$$aA = y_1 \quad bB = y_2 \quad cC = y_3$$

Then if V = volume required

$$V = abc \text{ DEF} + abc \text{ ABC} = A \frac{x_1 + x_2 + x_3}{3} +$$

$$A \frac{y_1 + y_2 + y_3}{3} = A \frac{x_1 + y_1 + x_2 + y_2 + x_3 + y_3}{3}$$

$$= A \frac{h_1 + h_2 + h_3}{3}$$

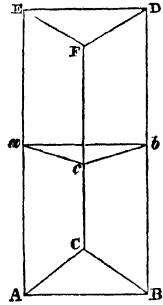

Fig. 40.

(8.) To determine the Volume of a Frustum of a Right Prism on a base which is a Parallelogram.

Let ABCDEFGH be the frustum in question; let h_1, h_2, h_3, h_4 be the edges at A, B, C, D, respectively; draw AC, and if a plane E pass through AC and E it divides AB . . . H into two frustums similar to that in the last proposition. Let V be the required volume, and A_1 the area ABC which is = area ADC (Euclid I-34). Now the volumes of the two triangular prisms are respectively

$$A_1 \frac{h_1 + h_2 + h_3}{3}, \text{ and } A_1 \frac{h_3 + h_4 + h_1}{3}$$

$$\therefore V = \frac{1}{3} A_1 (h_1 + h_2 + h_3) + \frac{1}{3} A_1 (h_3 + h_4 + h_1)$$

If we had divided the figure by a plane passing through BD, we should have had

$$V = \frac{1}{3} A_1 (h_2 + h_3 + h_4) + \frac{1}{3} A_1 (h_4 + h_1 + h_2)$$

Similarly if we had divided at C and D, we should have had respectively

$$V = \frac{1}{3} A_1 (h_3 + h_4 + h_1) + \frac{1}{3} A_1 (h_1 + h_2 + h_3)$$

$$V = \frac{1}{3} A_1 (h_4 + h_1 + h_2) + \frac{1}{3} A_1 (h_2 + h_3 + h_4)$$

Now let $S = h_1 + h_2 + h_3 + h_4$. Then adding the four values of V we have

$$\begin{aligned} 4V &= \frac{1}{3} A_1 (S + S + S) + \frac{1}{3} A_1 (S + S + S) \\ &= 2A_1 \cdot S \end{aligned}$$

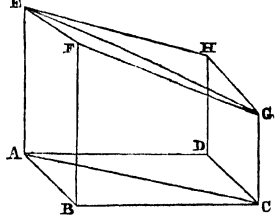

Fig. 41.

∴ If A is the whole area ABCD. Since $A = 2A_1$

$$V = A \frac{S}{4} = A \frac{h_1 + h_2 + h_3 + h_4}{4}$$

(9). To find the Volume of a Frustum of a right Prism on a regular Pentagonal Base.

Let $P_1 P_2 P_3 P_4 P_5$ be the base, and let h_1, h_2, h_3, h_4, h_5 be the edges corresponding to these angles. Join $P_1 P_3$ and $P_1 P_4$, and let the areas of $P_1 P_2 P_3$ and $P_1 P_4 P_5$, which are equal, be each A_1 , and the area of $P_1 P_3 P_4$ be A_2 . Let V be the required volume, then this volume consists of three portions of prisms of the same kind as in article (7) and hence

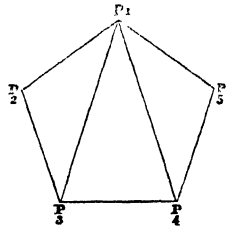

$$V = \frac{A_1}{3} (h_1 + h_2 + h_3) + \frac{A_2}{3} (h_1 + h_3 + h_4) + \frac{A_1}{3} (h_1 + h_4 + h_5)$$

Now divide the base by lines drawn through P_2 the areas will be the same as before, and hence

$$V = \frac{A_1}{3} (h_2 + h_3 + h_4) + \frac{A_2}{3} (h_2 + h_4 + h_5) + \frac{A_1}{3} (h_2 + h_5 + h_1)$$

and similarly by dividing the base by lines drawn successively through P_3, P_4 and P_5 we obtain

$$V = \frac{A_1}{3} (h_3 + h_4 + h_5) + \frac{A_2}{3} (h_3 + h_5 + h_1) + \frac{A_1}{3} (h_3 + h_1 + h_2)$$

$$V = \frac{A_1}{3} (h_4 + h_5 + h_1) + \frac{A_2}{3} (h_4 + h_1 + h_2) + \frac{A_1}{3} (h_4 + h_2 + h_3)$$

$$V = \frac{A_1}{3} (h_5 + h_1 + h_2) + \frac{A_2}{3} (h_5 + h_2 + h_3) + \frac{A_1}{3} (h_5 + h_3 + h_4)$$

Then adding these together and writing

$$h_1 + h_2 + h_3 + h_4 + h_5 = S$$

we have $5V = \frac{A_1}{3} (S + S + S) + \frac{A_2}{3} (S + S + S) + \frac{A_1}{3} (S + S + S)$

$$\therefore 5V = (2A_1 + A_2) S = A \cdot S.$$

If A = area of base.

$$\therefore V = A \frac{h_1 + h_2 + h_3 + h_4 + h_5}{5}$$

The student can easily prove that a similar formula is true in the case of a prism on a hexagonal base, or indeed on any base which is a regular polygon.

10. To find the Volume of a Prismoid.

DEF. A prismoid is a solid of the form represented in the accompanying figure. ABCD is a rectangle, and ABFE, DEHG, are planes perpendicular to the planes of the rectangle, ED and CF are planes inclined at given angles to the plane of the rectangle, the lines EF and GH being parallel to AB and CD.

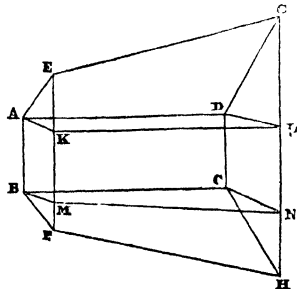

Through AD and BC draw planes ADLK and

Fig. 43.

BCNM perpendicular to the plane of the rectangle, these divide the given figure into three, viz. AEKDLG, BDN, and BMFCHN.

Let $AB = a$ $AD = h$ $AK = x$ $DL = x_1$ $EK = b$ $GL = b_1$ $MF = c$ $NH = c_1$

Then (a) the figure BDN is of the same kind as in article 8. Now the area $DB = ah$, if therefore V_1 is its volume,

$$V_1 = \frac{ah}{4} (x + x + x_1 + x_2) = \frac{ah}{2} (x + x_1)$$

(b) Let V_2 be the volume of the figure AEKDLG, draw planes through ED, K and GD, K, dividing the figure into three pyramids, DGL, K, AEK, D, and DEG, K.

The volume of GLD, K

$$= GLD \times \frac{KL}{3} = \frac{x_1 b_1}{2} \times \frac{h}{3} = \frac{h}{6} x_1 b_1.$$

Similarly volume of AEK, D = $\frac{h}{6} ab$.

Now the volume of GED, K is to that of ADE, K as GED is to ADE, or as AE to GD, or since triangles AEK, GDL are similar, these volumes are as AK to DL, or as EK to GL.

$$\begin{aligned} \therefore \text{Volume GED, K} &= \frac{h}{6} x b \times \frac{x_1}{x} \text{ or } = \frac{h}{6} \cdot x b \times \frac{b_1}{b} \\ &= \frac{h}{6} x_1 b \text{ or } = \frac{h}{6} \cdot x b_1 \\ &= \frac{h}{6} \cdot \frac{x_1 b + x b_1}{2} \\ \therefore V_2 &= \frac{h}{6} \left(c_1 b_1 + x b + \frac{x_1 b + x b_1}{2} \right). \end{aligned}$$

(c) Similarly, if V_3 is the volume of BMFCHN,

$$V_3 = \frac{h}{6} \left(x_1 c_1 + x c + \frac{x_1 c + x c_1}{2} \right)$$

Now if V be the required volume,

$$V = V_1 + V_2 + V_3.$$

$$\therefore V = \frac{h}{6} \left\{ 3a(x + x_1) + x_1(b_1 + c_1) + x(b + c) + x_1 \frac{b + c}{2} + x \frac{b_1 + c_1}{2} \right\}.$$

or re-arranging the right-hand side of the equation,

$$\begin{aligned} V &= \frac{h}{6} \left\{ x \left(a + \frac{b + c}{2} \right) + x_1 \left(a + \frac{b_1 + c_1}{2} \right) \right. \\ &\quad \left. + (x + x_1) \left(2a + \frac{b + c}{2} + \frac{b_1 + c_1}{2} \right) \right\} \end{aligned}$$

Now in this expression,

$$x \left(a + \frac{b + c}{2} \right) \text{ is the area of ABFE. (Fig. 43.)}$$

$$x_1 \left(a + \frac{b_1 + c_1}{2} \right) \text{ is the area of DCHG.}$$

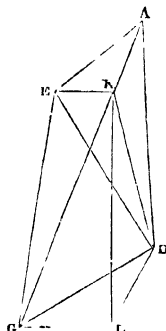

$$\text{and } (x + x_1) \left(2a + \frac{b+c}{2} + \frac{b_1+c_1}{2} \right), \text{ which equals}$$

$$4 \times \frac{x+x_1}{2} \left\{ \frac{1}{2} \left(a + \frac{b+c}{2} \right) + \frac{1}{2} \left(a + \frac{b_1+c_1}{2} \right) \right\}.$$

is clearly four times the area of a section made by a plane parallel to ABFE and DEHG, and half way between them.

Hence the solid content of a prismoid is found by the following rule: "To the areas of the ends add four times the area of the mean section, multiply this sum by $\frac{1}{6}$ th of the height of the figure; this product is the volume required."

In practical cases it will generally happen that $b = c$, and $b_1 = c_1$. This does not affect the enunciation of the rule, but simplifies the formula, which becomes

$$V = \frac{h}{6} \left\{ 3a(x + x_1) + x_1(2b_1 + b) + x(2b + b_1) \right\}.$$

(11.) To find the Solid Content of a Railway Cutting.

In the last article the figure is very nearly that of a portion of a railway cutting, in which ABCD is the road, AG and BH, the sloping sides of the embankment, and hence the solid content required can be found by means of the rule given in the last article. It is to be observed that the rule requires EG and FH to be straight lines, or, as an approximation, to be very nearly straight lines, or EH to be a plane, which is not true if the cutting is a long one. For this case we derive the following rule from the above formula.

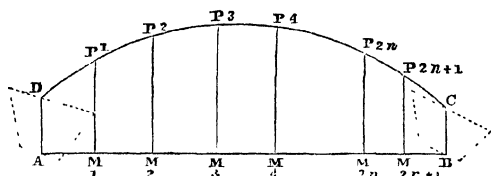

Fig. 45.

Let ABC represent a section made by a vertical plane of the hill to be cut through, AB the level of the road, and suppose sections of the cutting to be made by planes perpendicular to AB, at equal distances along that line, viz., at $M_1, M_2, M_3, \dots, M_{2n+1}$, let the terminal sections at A and B be a and b , and the sections at $P_1, M_1, P_2, M_2, \dots, P_{2n}, M_{2n}, P_{2n+1}, M_{2n+1}$, the number of sections being odd, and let the common distance between the sections be h . Now by last article the volume of portion

$$AM_1P_1D \text{ is } \frac{AM_1}{6} \cdot (\alpha + 4p_1 + p_2) \text{ or } \frac{h}{3} (\alpha + 4p_1 + p_2)$$

and the volume of the portion $P_2M_2M_3P_3$ is $\frac{h}{3} (p_2 + 4p_3 + p_4)$, and so on,

and the volume of $P_{2n}M_{2n}BC$ is $\frac{h}{3} (p_{2n} + 4p_{2n+1} + b)$.

Hence, by addition, the whole volume required is

$$\frac{h}{3} \cdot \left\{ (a + b + 4(p_1 + p_3 + \dots + p_{2m} + 1) + 2(p_2 + p_4 + \dots + p_{2m})) \right\}$$

which may be expressed as a rule as follows :—

Between the first and last sections make an odd number of sections at equal distances along the road, the planes of the section being perpendicular to the road; then one third part of the common distance multiplied by the sum of the first and last sections, with four times the sum of the odd sections, and twice the sum of the even sections, gives the volume between the first and last section.

The student will observe that this rule is the same as that for finding the area of a figure bounded by a curve, which has been already given (p. 379), excepting that the ordinates in the former rule are replaced by trapezoidal sections in the latter. The formula given in article 10 is called the Prismoidal formula. It will be observed that the material on each side of a cutting being generally the same, is the reason the inclination of the planes AG and BH to BD being generally the same as stated in the last article. Mr. Macneill, to whom the prismoidal formula is due, has constructed tables founded on that formula, by which the volume of a cutting is very readily calculated. The volume of an embankment is to be found by the same formula, since, as a question of mere figure, an embankment is only an inverted cutting. If the calculation is made directly from the formula it is very tedious; the value of the Tables above referred to is therefore very great, and is enhanced by the following circumstance :—In constructing a long line of railway, the earth taken out of the cutting should be sufficient to form the embankment, otherwise land must be purchased for the mere purpose of obtaining earth; to effect this end of making the volume of the embankments equal that of cuttings, the ascents and descents (gradients) of the line of road have to be properly chosen, and this can only be done by trial, so that the calculation may have to be performed two or three times before a right adjustment can be hit upon. It is worth adding that, as a general rule, a cutting is followed not by a long level, but by an embankment; if possible, these two are adjusted to each other to prevent the need of carrying earth from long distances.

12. To find the Solid Content of a Military Earth-work.

The form of a military earth-work will be understood from the following explanations :—

The form of a section of the work made by a vertical plane perpendicular to the face of the work is such as ABCDEF from B, C, D, E draw perpendiculars to AF, viz., Bm, Cn, Dp, Eq, then Am, mn, np, pq, qF, are of known magnitudes, as also are Bm, Cn, Dp, Eq. The plan of the work will be of the accompanying kind, viz., F'f

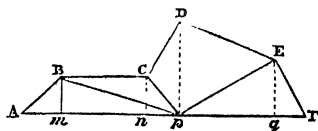

Fig. 46.

(Fig. 47) is the line corresponding to F (Fig. 46) E'e the line corresponding to E, and so on for the others; the lengths of all these lines are known; we will call them a, b, c, d, e, f , respectively.

In fig. 46 join pE, pC, pB, dividing the section of the work into triangles ApB, BpC, CpD, DpE, and EpF; call these areas respectively A_1, A_2, A_3, A_4, A_5 , then the contents of

the work are clearly equivalent to the frustums of five prisms (similar to that in the Corol. to article 7), which have the area of perpendicular section A_5 and edges f, e, d , section A_4 and edges e, d, d , section A_3 and edges d, d, c , section A_2 and edges c, d, b , and section A_1 and edges b, d, a , it being evident that the edge through $p = d$. Hence if the whole volume equals V , we have

$$V = \frac{A_5}{3} (f + c + d) + \frac{A_4}{3} (e + d + d) + \frac{A_3}{3} (d + d + c) + \frac{A_2}{3} (c + d + b) + \frac{A_1}{3} (b + d + a)$$

$$\therefore 3V = aA_1 + b(A_1 + A_2) + c(A_2 + A_3) + d(A_3 + A_4) + e(A_4 + A_5) + fA_5 + d(A_1 + A_2 + A_3 + A_4 + A_5)$$

In which formula it will be observed that each line in the plan is multiplied by the triangle, or by the sum of the triangles, which have an angular point in that line, and that the line dD' is also multiplied by the whole area of the section. Hence if these products are formed and added together, the required volume is one third of the sum.

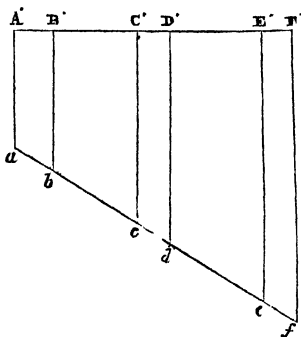

Fig. 47.

13. To find the Volume of the Frustum of a right Cone made by a Plane parallel to the Base.

Let ABCD be the frustum of the cone PCD. Join POO₁ where OO₁ are the centres of the ends of the frustums. Let AO = r CO₁ = r₁ OO₂ = h. PO = x.

$$\text{Then volume ABP} = \frac{\pi r^2 x}{3} \quad \text{volume PCD} = \frac{\pi r_1^2 (x + h)}{3}$$

$$\therefore \text{Volume of frustum} = \frac{\pi}{3} \cdot r_1^2 h + \frac{\pi (r_1^2 - r^2)}{3} x$$

$$\text{Now } x + h : r_1 :: x : r.$$

$$\therefore h : x :: r_1 - r : r.$$

$$\therefore \text{Volume of frustum} = \frac{\pi}{3} r_1^2 h + \frac{\pi (r_1^2 - r^2)}{3} \frac{hr}{r_1 - r}$$

$$= \frac{\pi h}{3} \cdot (r_1^2 + r_1 r + r^2)$$

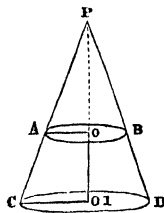

Fig. 48.

which is the same as the volume of three cones whose common height is h , and which have the radii of their bases respectively r , r_1 and a mean proportional between r and r_1 .

$$\begin{aligned} \therefore 3V_1 &= 3\pi r^2h - \pi h \left\{ r^2 + (r-h)r + (r-h)^2 \right\} \\ &= \pi h (3r^2 - h^2) \\ \therefore V_1 &= \frac{\pi h^2}{3} (3r - h). \end{aligned}$$

Hence if V = volume of the whole sphere, in which case $h = 2r$.

$$V = \frac{4\pi r^3}{3}$$

Now the volume of cylinder circumscribing sphere = $\pi r^2 \times 2r$.

$$\therefore V = \frac{2}{3} \cdot (\text{circumscribing cylinder}).$$

Cor. 1.—The above proposition may be demonstrated in the following manner. Suppose a solid having any number of plane faces to be described in the sphere, and let A_1, A_2, A_3 &c., be the areas of these faces, and p_1, p_2, p_3 &c., be the perpendicular distances of these faces from the centre of the sphere; now this inscribed solid may be conceived to be made up of pyramids, the bases of which are the faces of the solids, having the centre of the sphere for their common vertex. Hence, if the volume of the solid is V_1

$$V_1 = \frac{1}{3} A_1 p_1 + \frac{1}{3} A_2 p_2 + \frac{1}{3} A_3 p_3 + \dots$$

Now this is true, however great the number of faces may be, and \therefore is true in the limit, but in the limit $p_1, p_2, p_3 \dots$ become equal to one another and to r the radius of sphere. Hence,

$$\text{Limit of } A_1 p_1 + A_2 p_2 + A_3 p_3 + \dots = r \times (\text{limit of } A_1 + A_2 + A_3 \dots)$$

Now the limit of $A_1 + A_2 + A_3 + \dots$ = surface of sphere = $4\pi r^2$ (Mensuration of Areas, Art. 19). Also the limit of $V_1 = V$ the volume of sphere.

$$\therefore V = \frac{1}{3} r \times 4\pi r^2 = \frac{4\pi r^3}{3}.$$

Cor. 2.—To find the volume of the portion of the sphere corresponding to BPNO. Let the volume be called V , and let $h = ON$ which is = MN . Then

$$V = \text{cylinder BN} - \text{cone ONM}.$$

Now volume of cylinder $BN = \pi r^2 h$

$$\text{Volume of cone } MNO = \frac{1}{3} \pi h^3$$

$$\therefore V = \pi r^2 h - \frac{1}{3} \pi h^3 = \pi h \left(r^2 - \frac{1}{3} h^2 \right)$$

15. To find the Volume of a Spheroid.

DEF. A spheroid is a figure formed by the revolution of an ellipse about one of its axes; if about the major axis it is called a prolate spheroid, if about its minor axis it is called an oblate spheroid.

Let ABa be a semi-ellipse, OA its semi-major axis, OB its semi-minor axis. With centre O and radius OA describe a semi-circle ACa , draw QPN through any point in the ellipse parallel to OC ,

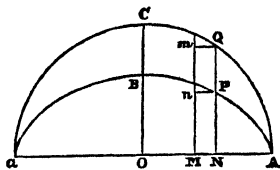

Fig. 50.

draw Mnm parallel to NPQ and complete the rectangles MP , MQ (Mensuration of Areas, Art. 12).

Now if the figure revolve round Aa the semi-ellipse will describe a prolate spheroid and the circle a sphere, also MP and MQ will describe cylinders with altitudes MN and having the radii of the bases NP and NQ respectively, and \therefore having volumes $\pi MN \times PN^2$ and $\pi \cdot MN \times NQ^2$. Now by a property of the ellipse,

$$QN : PN :: a : b$$

$$\therefore QN^2 : PN^2 :: a^2 : b^2$$

$$\text{But } \text{Cylind. } MQ : \text{cylind. } MP :: MQ^2 : MP^2$$

$$\therefore \text{cylind. } MQ : \text{cylind. } MP :: a^2 : b^2$$

and the same is true of any other cylinders described in like manner within the sphere and spheroid, and \therefore is true of their sum

$$\therefore \text{all cylinders within sphere} : \text{all within spheroid} :: a^2 : b^2$$

and this being true, however many cylinders there may be, *i. e.* however small we suppose MN to be, is true in the limit, but the sphere is the limit of its inscribed cylinders, and the spheroid the limit of its inscribed cylinder,

$$\therefore \text{Sphere} : \text{spheroid} :: a^2 : b^2 :: \frac{4\pi a^3}{3} : \frac{4\pi ab^2}{3}$$

$$\text{But volume of sphere} = \frac{4\pi a^3}{3}$$

$$\therefore \text{Volume of spheroid} = \frac{4\pi ab^2}{3}$$

Cor : In like manner the volume of an oblate spheroid is $\frac{4\pi a^2 b}{3}$

16. *To find the Volume of a portion of a Spheroid, cut off by a plane Perpendicular to the Axis of Revolution.*

In figure 50, suppose we wish to find the volume of the portion of the spheroid corresponding to the portion APN of the generating ellipse; then, as in Art. 15, we shall have

$$\text{Portion of Spheroid} : \text{portion of sphere} :: b^2 : a^2$$

Now (Mensuration of Solids, Art. 14.) if $AN = h$ the volume of the portion of the sphere is equal to $\frac{\pi h^2}{3}(3a-h)$. \therefore If V_1 is the volume required,

$$V_1 = \frac{\pi h^2 b^2}{3a^2} (3a-h)$$

Similarly if we wish to find the volume of the portion corresponding to $ONPR$, and if V_2 is this volume, and $h = ON$,

$$V_2 = \pi h b^2 \left(1 - \frac{1}{3} \cdot \frac{h^2}{a^2} \right)$$

as is evident from *scrol. 2. Art. 14. Mensuration of Solids.*

17. *To find the Volume of a Cask.*

We may consider a cask to be either the middle portion of a spheroid, or two frustums of equal cones joined together at their bases, though it will not coincide

with either of these forms exactly. It is to be observed that excise officers generally consider casks to be of the first form.

The measurements that are most easily made in practice are the diameters of the end, and of the middle section, and the distance between the ends; we will call those, d , D , and k , respectively, and investigate the rule in each of the above cases.

(a.) Suppose the cask to be a portion of a spheroid. Its volume V will be double that of V_s in the last article $\therefore V = 2\pi hb^2 \left(1 - \frac{1}{3} \frac{h^2}{a^2} \right)$

Also by a property of the ellipse, (See fig. 50.)

$$\frac{PN^2}{OB^2} + \frac{ON^2}{OA^2} = 1.$$

$$\therefore \frac{PN^2}{b^2} + \frac{h^2}{a^2} = 1.$$

$$\therefore \frac{1}{3} \cdot \frac{PN^2}{b^2} + \frac{1}{3} \cdot \frac{h^2}{a^2} = \frac{1}{3}.$$

$$\therefore \frac{2}{3} + \frac{1}{3} \cdot \frac{PN^2}{b^2} = 1 - \frac{1}{3} \frac{h^2}{a^2}$$

$$\therefore V = 2\pi hb^2 \left(\frac{2}{3} + \frac{1}{3} \frac{PN^2}{b^2} \right)$$

$$\therefore V = \frac{2\pi h}{12} (8b^2 + 4PN^2)$$

Now $2h = k$. $2b = D$ $2 \cdot PN = d$

$$\therefore V = \frac{\pi}{12} k (2 \cdot D^2 + d^2).$$

Also $\frac{\pi}{12} = .2618$ very nearly, hence the rule. "To twice the square of the middle diameter add the square of the end diameter, and multiply the sum by the length of the cask, this product multiplied by .2618 gives the content of the cask."

(b.) Suppose the cask to have the form of a double frustum of a cone.

If v is the volume required v is clearly double of the volume ABCD, fig. 48. And hence by Article 13, Mensuration of Solids,

$$v = \frac{2\pi h}{3} (r_1^2 + rr_1 + r^2)$$

Now $D = 2r_1$ $d = 2r$ and $k = 2h$

$$\therefore v = \frac{\pi}{12} \cdot k (D^2 + Dd + d^2).$$

Hence the rule "To the product of the diameters add the sum of their squares, multiply this by the length of the cask, then the whole product multiplied by .2618 gives the contents of the cask."

N.B. If the measurements are made in inches, the above rules give the required contents in cubic inches; to obtain the contents in gallons we must divide by 277.274, since 277.274 cubic inches go to one gallon.

Cor. It is evident that v , the value given by the second rule, is less than the true contents of the cask; it is to be observed, also, that V , the value given by the former rule, is generally greater than the true value; so that the true value will lie somewhere between these two results. Hence we can easily estimate the amount of

accuracy in each of the above determinations. Thus, $V-v$ is clearly greater than the difference between the true result, and either of those given by rule, and v is less than the true value of the contents, hence the error committed by either way of making the calculation cannot be so great as the $\left(\frac{V-v}{v}\right)^{\text{th}}$ of the whole. Now

$$\begin{aligned} V-v &= \frac{\pi k}{12} (2D^2 + d^2) - \frac{\pi k}{12} (D^2 + Dd + d^2) = \frac{\pi k}{12} (D^2 - Dd) \\ &= \frac{\pi k}{12} D (D-d). \end{aligned}$$

$$\therefore \frac{V-v}{v} = \frac{\frac{\pi k}{12} D (D-d)}{\frac{\pi k}{12} (D^2 + Dd + d^2)} = \frac{D (D-d)}{D^2 + Dd + d^2}.$$

If $D = d + n$. Then $Dd = D^2 - Dn$, and $d^2 = D^2 - 2Dn + n^2$.

$$\therefore \frac{V-v}{v} = \frac{Dn}{3D^2 - 3Dn + n^2} = \frac{\frac{n}{3D}}{1 - \frac{n}{D} + \frac{n^2}{3D^2}},$$

which is an expression for a limit of the part of the whole, by the approximate differs from the true value. *e.g.* Suppose the diameters to be 18 and 20 inches respectively, then $n = 2$ inches and $\frac{n}{D} = \frac{1}{10}$, and there the error committed by calculating

according to either rule cannot be so much as $\frac{1}{30}$ of the whole, or so much as $1 - \frac{1}{10} + \frac{1}{300}$

as $\frac{10}{271}$ th or $\frac{1}{27}$ th (very nearly) of the whole. If the cask in question had an interior length of two feet, then, by the first rule, its contents are 25.47 gallons, and, by the second, its contents are 24.56 gallons. So that the error committed by either way of gauging must be less than one gallon.

SPHERICAL TRIGONOMETRY.

BEFORE reading the following treatise, the student will do well to re-peruse the treatise of Spherical Geometry already given (p. 251, &c). He will there find the definitions enunciated and the chief properties of spherical triangles proved which are employed as the premises from which the formulas of the following treatise are deduced. It is stated in the introduction to that treatise that the chief applications of this science are found in practical astronomy and geodesy; also it is stated on p. 256, that the side of a spherical triangle measures the angle it subtends at the centre of the sphere, and hence is spoken of as an angle;—now it is to be observed that in practical astronomy, the measurements made by the various instruments are invariably the angles subtended at the eye of the observer by arcs of the great sphere, for instance, the altitude of a star is measured directly as an angle,—so that in these cases the radius of the sphere never enters into consideration; but in the case of measurements on the earth's surface, if we have a distance measured along a great circle in miles or yards, which is to enter into our calculations, we must determine the angle these yards or miles subtend at the earth's centre; thus if a is the length in question, r the radius of the earth, θ the angle, then $\theta = \frac{a}{r}$ where θ is

in circular measure. If θ contains n° , then $n^\circ = \frac{a 180^\circ}{\pi r}$. Further it will be

observed that in case the sides of a spherical triangle are small compared with the radius of the sphere, the triangle does not differ sensibly from a plane triangle: *e.g.* a triangle on the earth's surface the sides of which are each about a mile long will not differ sensibly from a plane triangle, unless the measurements are made with very refined instruments; hence it is manifest that the plane triangle is the limit of a spherical triangle, and accordingly we shall find that the formulas for the solution of spherical triangles are quite analogous to those that have been already deduced for the solution of plane triangles (pp. 322, 325), and we shall see that the latter can be deduced from the former by considering the plane triangle as the limit of the spherical triangle.

N.B. The following results already proved on p. 259 are very important. Let A, B, C, a, b, c , be the angles and sides of any spherical triangle, and A', B', C', a', b', c' , the angles and sides of the corresponding polar triangle. Then

$$A + a' = B + b' = C + c' = 180^\circ$$

And

$$A' + a = B' + b = C' + c = 180^\circ$$

We shall employ this notation for the angles and sides of a spherical triangle and of its polar triangle throughout the following treatise.

(1.) To show that the Sines of the Angles of a Spherical Triangle are proportional to the Sines of the opposite sides.

Let ABC be the triangle, O the centre of the sphere, join OA , OB , OC ; through A draw a plane ANP perpendicular to OB , cutting the plane AOB in AN and BOC in NP , these lines are perpendicular to OB , and the angle ANP measures the inclination of the planes, and is \therefore equal to the angle B of the triangle. Through A draw another plane AMP perpendicular to OC , cutting AOC in AM , COB in MP , and AMP in AP , then AM and MP are perpendicular to OC , the angle AMP is equal to the angle C of the triangle, and AP is perpendicular to the plane BOA , and \therefore APN and APM are each right angles. Hence

$$\sin. B = \frac{AP}{AN} \quad \text{and} \quad \sin. C = \frac{AP}{AM} \quad \therefore \frac{\sin. B}{\sin. C} = \frac{AM}{AN}$$

Also since c is the angle AOB and b the angle AOC

$$\sin. c = \frac{AN}{OA} \quad \text{and} \quad \sin. b = \frac{AM}{OA} \quad \therefore \frac{\sin. b}{\sin. c} = \frac{AM}{AN}$$

$$\therefore \frac{\sin. B}{\sin. c} = \frac{\sin. b}{\sin. c} \quad \text{or} \quad \frac{\sin. B}{\sin. b} = \frac{\sin. C}{\sin. c}$$

The same proof holds good of the other sides and angles.

$$\text{Hence} \quad \frac{\sin. A}{\sin. a} = \frac{\sin. B}{\sin. b} = \frac{\sin. C}{\sin. c} \dots (1)$$

Q.E.D.

COR. 1.—Suppose a, b, c , to be the lengths of the sides BC, CA, AB , then the angles denoted in formula (1) by α, β, γ , are $\frac{a}{r}, \frac{b}{r}, \frac{c}{r}$ in circular measure, r being the radius of sphere. Hence

$$\frac{\sin. B}{\sin. C} = \frac{\sin. \frac{b}{r}}{\sin. \frac{c}{r}} = \frac{\frac{b}{r} \cdot \frac{\sin. \frac{b}{r}}{\frac{b}{r}}}{\frac{c}{r} \cdot \frac{\sin. \frac{c}{r}}{\frac{c}{r}}} = \frac{b}{c} \cdot \frac{\frac{\sin. \frac{b}{r}}{\frac{b}{r}}}{\frac{\sin. \frac{c}{r}}{\frac{c}{r}}}$$

Now in the limiting case when r is infinite, $\frac{a}{r} = 0$ and $\frac{b}{r} = 0$

and \therefore (Plane Trig. Art. 47) $\frac{\sin. \frac{b}{r}}{\frac{b}{r}} = 1$, and $\frac{\sin. \frac{c}{r}}{\frac{c}{r}} = 1$, \therefore in the limit

$$\frac{\sin. B}{\sin. C} = \frac{b}{c} \quad \text{The formula for plane triangles (p. 322).}$$

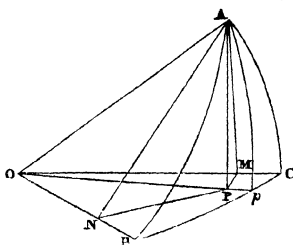

Fig. 1.

COR. 2.—If through O and AP a plane be drawn cutting the surface of the sphere in Ap, then Ap is perpendicular to BC, and $\frac{AP}{OA}$ equals the sine of AOP: i.e. is equal to the sine of Ap, which we will call p.

$$\text{Now } \sin. B \sin. c = \frac{AP}{AN} \times \frac{AN}{OA} = \frac{AP}{AO} = \sin. Ap.$$

$$\therefore \sin. B \sin. c = \sin. p. \dots (2).$$

(2.) To prove the Formula $\cos. A = \frac{\cos. a - \cos. b \cos. c}{\sin. b \sin. c}$

As before, let O be the centre of the sphere, and ABC the triangle, join OA. OB. OC, and produce the planes AOB, BOC, COA indefinitely; at A draw a plane Apq perpendicular to OA, cutting the planes AOB, BOC, COA in Ap, pq, qA respectively, then since pA is on the plane AOB, and perpendicular to OA, and qA is on the plane COA, and perpendicular to OA, pAq is the angle between the planes, and \therefore is equal to the angle A of the triangle, also the angle pOq is the angle subtended by BC: i.e. is the angle α .

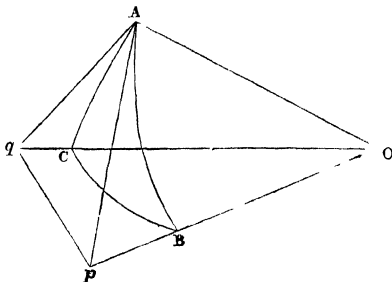

Fig. 2

Hence (Plane Trig. Art. 37)

$$Ap^2 + Aq^2 - 2 Ap. Aq \cos. A = pq^2 = Op^2 + Oq^2 - 2 Op. Oq \cos. \alpha.$$

Now $\frac{Ap}{OA} = \tan. c = \frac{\sin. c}{\cos. c}$ $\frac{Aq}{OA} = \tan. b = \frac{\sin. b}{\cos. b}$ $\frac{OP}{OA} = \sec. c = \frac{1}{\cos. c}$

$$\frac{Oq}{OA} = \sec. b = \frac{1}{\cos. b}$$

$$\therefore \frac{\sin.^2 c}{\cos.^2 c} + \frac{\sin.^2 b}{\cos.^2 b} - 2 \frac{\sin. c \sin. b}{\cos. c \cos. b} \cos. A = \frac{1}{\cos.^2 c} + \frac{1}{\cos.^2 b} - \frac{2 \cos. \alpha}{\cos. c \cos. b}$$

$$\therefore \frac{2 \sin. c \sin. b}{\cos. c \cos. b} \cos. A = \frac{2 \cos. \alpha}{\cos. c \cos. b} - \frac{1}{\cos.^2 c} + \frac{\sin.^2 c}{\cos.^2 c} - \frac{1}{\cos.^2 b} + \frac{\sin.^2 b}{\cos.^2 b}$$

and $\frac{1}{\cos.^2 c} - \frac{\sin.^2 c}{\cos.^2 c} = \frac{\cos.^2 c}{\cos.^2 c} = 1.$

Similarly $\frac{1}{\cos.^2 b} - \frac{\sin.^2 b}{\cos.^2 c} = 1.$

$$\therefore \frac{2 \sin. c \sin. b}{\cos. c \cos. b} \cos. A = \frac{2 \cos. \alpha}{\cos. c \cos. b} - 2$$

$$\therefore \sin. c \sin. b \cos. A = \cos. \alpha - \cos. c \cos. b$$

$$\therefore \cos. A = \frac{\cos. \alpha - \cos. b \cos. c}{\sin. b \sin. c} \dots (3) \quad \text{Q. E. D.}$$

COR. 1.—If $a.b.c.$ represent the lengths of the sides of the triangle, and r the radius,

Then $\frac{a}{r}$, $\frac{b}{r}$, $\frac{c}{r}$, are the angles of formula (3) in circular measure.

Hence, remembering that $\cos. \theta = 1 - \frac{\theta^2}{1.2} + \frac{\theta^4}{1.2.3.4} \dots$ and $\sin. \theta = \theta - \frac{\theta^3}{1.2.3} + \dots$ we have

$$\begin{aligned} \text{Cos. A} &= \frac{\left(1 - \frac{a^2}{2r^2} + \dots\right) - \left(1 - \frac{b^2}{2r^2} + \dots\right) \left(1 - \frac{c^2}{2r^2} + \dots\right)}{\left(\frac{b}{r} - \frac{b^3}{r^3} + \dots\right) \left(\frac{c}{r} - \frac{c^3}{r^3} + \dots\right)} \\ &= \frac{\left(1 - \frac{a^2}{2r^2}\right) - \left(1 - \frac{b^2}{2r^2} - \frac{c^2}{2r^2}\right) + \text{terms involving } \frac{1}{r^4} \dots}{\frac{bc}{r^2} + \dots \text{ terms involving } \frac{1}{r^3} + \dots} \\ &= \frac{b^2 + c^2 - a^2 + \text{terms involving } \frac{1}{r^2}, \frac{1}{r^4} + \dots}{2bc + \text{terms involving } \frac{1}{r}, \frac{1}{r^3} + \dots} \end{aligned}$$

Now in the limit when r is infinite, the terms involving $\frac{1}{r}, \frac{1}{r^2}, \dots$ will all disappear; hence in the limit,

$$\text{Cos. A} = \frac{b^2 + c^2 - a^2}{2bc}$$

or $a^2 = b^2 + c^2 - 2bc \cos. A$,
as in the case of the plane triangle.

Cor. 2.—In formula (3) substitute $180^\circ - a'$ for A , $180^\circ - A'$ for a , $180^\circ - B'$ for b , and $180^\circ - C'$ for c , and we shall have

$$\text{Cos. } a' = \frac{\cos. A' + \cos. B' \cos. C'}{\sin. B' \sin. C'}$$

This is true of the sides and angles of every polar triangle. Now it appears from Prop. xi., p. 259, that every triangle may be regarded as the polar triangle of some other; hence the above formula is perfectly general, and is true of every triangle, and we have

$$\text{Cos. } a = \frac{\cos. A + \cos. B \cos. C}{\sin. B \sin. C} \dots \quad (4)$$

Cor. 3.—Formulas similar to (3) and (4) are, of course, true of Cos. B and Cos. C, and of Cos. b and Cos. c .

(3.) To express the Formulas of the last Article in a Form adapted for Logarithmic Calculation.

$$\text{Since} \quad \text{Cos. A} = \frac{\cos. a - \cos. b \cos. c}{\sin. b \sin. c}$$

$$\therefore 1 + \cos. A = 1 + \frac{\cos. a - \cos. b \cos. c}{\sin. b \sin. c} = \frac{\cos. a - \cos. b \cos. c + \sin. b \sin. c}{\sin. b \sin. c}$$

$$\text{And } 1 - \cos. A = 1 - \frac{\cos. a - \cos. b \cos. c}{\sin. b \sin. c} = \frac{\cos. b \cos. c + \sin. b \sin. c - \cos. a}{\sin. b \sin. c}$$

$$\therefore 2 \cos.^2 \frac{A}{2} = \frac{\cos. a - (\cos. b \cos. c - \sin. b \sin. c)}{\sin. b \sin. c} = \frac{\cos. a - \cos. (b + c)}{\sin. b \sin. c}$$

$$\text{And } 2 \sin.^2 \frac{A}{2} = \frac{\cos. (b - c) - \cos. a}{\sin. b \sin. c}$$

$$\therefore 2 \cos.^2 \frac{A}{2} = \frac{2 \sin. \frac{1}{2} (a + b + c) \sin. \frac{1}{2} (b + c - a)}{\sin. b \sin. c}$$

$$\text{And } 2 \sin.^2 \frac{A}{2} = \frac{2 \sin. \frac{1}{2} (a - b + c) \sin. \frac{1}{2} (a + b - c)}{\sin. b \sin. c}$$

Now if $a + b + c = 2s$, then $b + c - a = 2(s - a)$ $a - b + c = 2(s - b)$, and $a + b - c = 2(s - c)$.

$$\therefore \cos.^2 \frac{A}{2} = \frac{\sin. s \sin. (s - a)}{\sin. b \sin. c} \tag{5}$$

$$\sin.^2 \frac{A}{2} = \frac{\sin. (s - b) \sin. (s - c)}{\sin. b \sin. c} \tag{6}$$

$$\therefore \tan.^2 \frac{A}{2} = \frac{\sin. (s - b) \sin. (s - c)}{\sin. s \sin. (s - a)} \tag{7}$$

And since,

$$\sin. A = 2 \sin. \frac{A}{2} \cos. \frac{A}{2}$$

$$\sin.^2 A = \frac{4}{\sin.^2 b \sin.^2 c} \sin. s \sin. (s - a) \sin. (s - b) \sin. (s - c) \tag{8}$$

these formulas are analogous to the formulas on p. 324 of plane trigonometry, which can be shown to be the limits of these in the same manner as in Cor. (1). Art. (1), and Cor. (1) Art. (2).

It is to be observed that, since any two sides of a triangle are greater than the third, $s - a, s - b, s - c$, are positive; and since all the sides of a triangle are less than four right-angles, s is less than two right-angles, and *a fortiori*, $s - a, s - b, s - c$, are each less than two right-angles: so that, $\sin. s, \sin. (s - a), \sin. (s - b), \sin. (s - c)$, are each positive, also b and c are each less than 180° ; so that $\sin. b$ and $\sin. c$ are always positive. Hence, (5), (6), (7), (8), are always positive, and \therefore the values of $\cos. \frac{A}{2}, \sin. \frac{A}{2}, \tan. \frac{A}{2}$ and $\sin. A$ derived from them are always real.

Cor : If we consider the case of the polar triangle $A = 180^\circ - a' \therefore \frac{A}{2} = 90^\circ - \frac{a'}{2}$
 $a = 180^\circ - A' \quad b = 180^\circ - B' \quad c = 180^\circ - C'$

$$\therefore s = 270^\circ - \frac{1}{2} (A' + B' + C') = 270^\circ - S' \text{ if } S' = \frac{1}{2} (A' + B' + C')$$

$$\therefore s - a = 90^\circ - (S' - A') \quad s - b = 90^\circ - (S' - B') \quad s - c = 90^\circ - (S' - C')$$

$$\text{Hence } \sin.^2 \frac{a'}{2} = \frac{-\cos. S' \cos. (S' - A')}{\sin. B' \sin. C'}$$

with similar expressions for $\cos.^2 \frac{a'}{2}, \cotan.^2 \frac{a'}{2}$, and $\sin.^2 a'$; and since these are true for all triangles we shall have

$$\sin.^2 \frac{a}{2} = -\frac{\cos. S \cos. (S - A)}{\sin. B \sin. C} \tag{9}$$

$$\text{Similarly } \cos^2 \frac{a}{2} = \frac{\cos. (S - B) \cos. (S - C)}{\sin. B \sin. C} \quad (10)$$

$$\therefore \tan^2 \frac{a}{2} = - \frac{\cos. S \cos. (S - A)}{\cos. (S - B) \cos. (S - C)} \quad (11)$$

$$\text{and } \sin^2 a = \frac{4}{\sin^2 B \sin^2 C} \left\{ - \cos. S \cos. (S - A) \cos. (S - B) \cos. (S - C) \right\} \quad (12)$$

where $2S = A + B + C$. It is to be observed that $A + B + C$ must be less than six right-angles, and greater than two right-angles; $\therefore S > 90^\circ < 270^\circ$. $\therefore \cos. S$ is always negative.

Also $S - A$ being equal to $\frac{1}{2} \cdot (B + C - A) = \frac{1}{2} \left\{ (180^\circ - (b' + c' - a')) \right\}$ must be $< 90^\circ$, since $b' + c' > a'$. $\therefore \cos. (S - A)$ is always positive, and similarly $\cos. (S - B)$ and $\cos. (S - C)$ are always positive, and \therefore (9) (10) (11) (12) though in appearance negative, are really always positive, and \therefore give us real values for $\sin. \frac{a}{2}$, $\cos. \frac{a}{2}$, $\tan. \frac{a}{2}$, and $\sin. a$.

Similar formulas, of course, exist for $\sin. \frac{b}{2}$, $\sin. \frac{c}{2}$ &c.

(4.) To prove the Formulas,

$$\text{Tan. } \frac{A+B}{2} = \frac{\cos. \frac{a-b}{2}}{\cos. \frac{a+b}{2}} \cotan. \frac{C}{2} \text{ and Tan. } \frac{A-B}{2} = \frac{\sin. \frac{a-b}{2}}{\sin. \frac{a+b}{2}} \cotan. \frac{C}{2} .$$

$$\text{Since } \tan^2 \frac{A}{2} = \frac{\sin. (s-b) \sin. (s-c)}{\sin. s \sin. (s-a)} \quad \tan^2 \frac{B}{2} = \frac{\sin. (s-c) \sin. (s-a)}{\sin. s \sin. (s-b)}$$

$$\tan^2 \frac{C}{2} = \frac{\sin. (s-a) \sin. (s-b)}{\sin. s \sin. (s-c)}$$

$$\therefore \tan^2 \frac{B}{2} \tan^2 \frac{C}{2} = \frac{\sin. (s-c) \sin. (s-a)}{\sin. s \sin. (s-b)} \times \frac{\sin. (s-a) \sin. (s-b)}{\sin. s \sin. (s-c)} = \frac{\sin^2 (s-a)}{\sin^2 s}$$

$$\therefore \tan. \frac{B}{2} \tan. \frac{C}{2} = \frac{\sin. (s-a)}{\sin. s}$$

$$\text{Similarly, } \tan. \frac{C}{2} \tan. \frac{A}{2} = \frac{\sin. (s-b)}{\sin. s} \text{ and } \tan. \frac{A}{2} \tan. \frac{B}{2} = \frac{\sin. (s-c)}{\sin. s}$$

$$\text{But } \tan. \frac{A+B}{2} \tan. \frac{C}{2} = \frac{\tan. \frac{B}{2} \tan. \frac{C}{2} + \tan. \frac{C}{2} \tan. \frac{A}{2}}{1 - \tan. \frac{A}{2} \tan. \frac{B}{2}} = \frac{\frac{\sin. (s-a)}{\sin. s} + \frac{\sin. (s-b)}{\sin. s}}{1 - \frac{\sin. (s-c)}{\sin. s}}$$

$$\therefore \tan. \frac{A+B}{2} \tan. \frac{C}{2} = \frac{\sin. (s-a) + \sin. (s-b)}{\sin. s - \sin. (s-c)} = \frac{2 \sin. \frac{1}{2} (2s-a-b) \cos. \frac{1}{2} (b-a)}{2 \sin. \frac{1}{2} c \cos. \frac{1}{2} (2s-c)}$$

$$= \frac{\sin. \frac{1}{2} c \cos. \frac{1}{2} (a-b)}{\sin. \frac{1}{2} c \cos. \frac{1}{2} (a+b)}$$

$$\therefore \tan. \frac{A+B}{2} = \frac{\cos. \frac{1}{2} (a-b)}{\cos. \frac{1}{2} (a+b)} \cotan. \frac{C}{2}. \quad (13)$$

Similarly

$$\tan. \frac{A-B}{2} \tan. \frac{C}{2} = \frac{\sin. (s-b) - \sin. (s-a)}{\sin. s + \sin. (s-c)} \frac{2 \sin. \frac{1}{2} (a-b) \cos. \frac{1}{2} (2s-a-b)}{2 \sin. \frac{1}{2} (s-c) \cos. \frac{1}{2} c}$$

$$\therefore \tan. \frac{A-B}{2} = \frac{\sin. \frac{1}{2} (a-b)}{\sin. \frac{1}{2} (a+b)} \cotan. \frac{C}{2} \quad (14)$$

These formulas are clearly analogous to (36) on p. 325 Plane Trigonometry.

Cor : If we take the polar triangle, since

$$\frac{A+B}{2} = 180^\circ - \frac{a'+b'}{2}, \quad \frac{A-B}{2} = \frac{b'-a'}{2}, \quad \frac{a+b}{2} = 180^\circ = \frac{A'+B'}{2};$$

$$\frac{a-b}{2} = \frac{B'-A'}{2}, \quad \text{and} \quad \frac{C}{2} = 90^\circ - \frac{c'}{2}.$$

We have from (13) and (14)

$$-\tan. \frac{a'+b'}{2} = \frac{\cos. \frac{B'-A'}{2}}{\cos. \frac{B'+A'}{2}} \tan. \frac{c'}{2}, \quad \text{and} \quad \tan. \frac{b'-a'}{2} = \frac{\sin. \frac{B'-A'}{2}}{\sin. \frac{A'+B'}{2}} \tan. \frac{c'}{2}$$

Hence, remembering that the formulas for the polar triangle are perfectly general, we have

$$\tan. \frac{a+b}{2} = \frac{\cos. \frac{A-B}{2}}{\cos. \frac{A+B}{2}} \tan. \frac{c}{2} \quad (15)$$

$$\tan. \frac{a-b}{2} = \frac{\sin. \frac{A-B}{2}}{\sin. \frac{A+B}{2}} \tan. \frac{c}{2} \quad (16)$$

(5.) To prove the Formula $\text{Cotan. } A \sin. C = \text{Cotan. } a \sin. b - \text{Cos. } C \cos. b$.

This formula is used in certain propositions : e.g. it is employed in the astronomical problem of finding the aberration in declination.

From formula (3) we have

$$\cos. A \sin. b \sin. c = \cos. a - \cos. b \cos. c.$$

And from formula (3) we have

$$\cos. c = \cos. a \cos. b + \sin. a \sin. b \cos. C.$$

$$\therefore \cos. A \sin. b \sin. c = \cos. a - \cos. a \cos.^2 b - \sin. a \sin. b \cos. b \cos. C.$$

$$\therefore \cos. A \sin. b \sin. c = \cos. a \sin.^2 b - \sin. a \sin. b \cos. b \cos. C.$$

$$\therefore \cos. a \sin. c = \cos. a \sin. b - \sin. a \cos. b \cos. C.$$

Also from formula (1) we have

$$\sin. c = \frac{\sin. C \sin. a}{\sin. A}$$

$$\therefore \cos. A \frac{\sin. C \sin. a}{\sin. A} = \cos. a \sin. b - \sin. a \cos. b \cos. C.$$

$$\therefore \cotan. A \sin. C \sin. a = \cos. a \sin. b - \sin. a \cos. b \cos. C.$$

$$\therefore \cotan. A \sin. C = \cotan. a \sin. b - \cos. C \cos. b.$$

Q.E.D.

THE SOLUTION OF RIGHT-ANGLED SPHERICAL TRIANGLES.

There are as many as six different cases of right-angled spherical triangles, as will appear from the following considerations:—

Let ABC be the triangle, having a right angle at C . Then using the ordinary notation, all possible cases are the following:

- (1.) Given the base and perpendicular, *i.e.*, given a and b .
- (2.) Given the hypotenuse and another side, *i.e.*, given c and a , or c and b .
- (3.) Given the base or perpendicular, and an adjacent angle, *i.e.*, given a and B , or b and A .
- (4.) Given the base or perpendicular and an opposite angle, *i.e.*, given a and A , or b and B .
- (5.) Given the hypotenuse and an angle, *i.e.*, given c and A , or c and B .
- (6.) Given the two angles, *i.e.*, A and B .

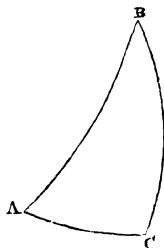

Fig. 2.

If these cases be compared with those on p. 361, for plane triangles, it will be seen that the third case of plane triangles diverges into two cases, *viz.*, the third and fourth of spherical triangles, while the sixth case is peculiar to spherical triangles. Both of these differences are due to the circumstance, that in the spherical triangle, $A + B + C$ is not known, whereas in the plane triangle $A + B + C = 180^\circ$

6. To investigate the Formulas on which the Solution of Right-angled Spherical Triangles depends.

$$\text{From the general formula } \frac{\sin. c}{\sin. C} = \frac{\sin. b}{\sin. B} = \frac{\sin. a}{\sin. A}$$

Since $C = 90^\circ$ and $\therefore \sin. C = 1$, we have

$$\sin. c = \frac{\sin. b}{\sin. B} = \frac{\sin. a}{\sin. A}$$

$$\therefore \sin. b = \sin. c \sin. B \quad (17)$$

$$\text{Similarly} \quad \sin. a = \sin. c \sin. A \quad (18)$$

$$\text{Again, since} \quad \cos. C = \frac{\cos. c - \cos. a \cos. b}{\sin. a \sin. b} \quad \text{and} \quad \cos. C = 0, \text{ we have}$$

$$\therefore \cos. c = \cos. a \cos. b \quad (19)$$

$$\text{Again, since} \quad \cos. C = \frac{\cos. C + \cos. A \cos. B}{\sin. A \sin. B} \quad \text{and} \quad \cos. C = 0$$

$$\therefore \cos. c = \cotan. A \cotan. B \quad (20)$$

$$\text{Again, since} \quad \cos. a = \frac{\cos. A + \cos. B \cos. C}{\sin. B \sin. C} \quad \text{and} \quad \cos. C = 0 \text{ and} \quad \sin. C = 1.$$

$$\therefore \cos. A = \cos. a \sin. B \quad (21)$$

$$\text{Similarly} \quad \cos. B = \cos. b \sin. A \quad (22)$$

$$\text{Again, since} \quad \cos. A = \cos. a \sin. B \quad \text{and} \quad \sin. B = \frac{\sin. b}{\sin. c}$$

$$\therefore \cos. A = \frac{\sin. b}{\sin. c} \cos. a \quad \text{and} \quad \cos. a = \frac{\cos. c}{\cos. b} \quad \text{by (2)} \quad \therefore \cos. A = \frac{\sin. b}{\sin. c} \cdot \frac{\cos. c}{\cos. b}$$

$$\therefore \cos. A = \tan. b \cotan. c \quad (23)$$

$$\text{Similarly} \quad \cos. B = \tan. a \cotan. c \quad (24)$$

$$\text{Again from (1)} \quad \sin. a = \sin. c \sin. A = \frac{\sin. b}{\sin. B} \cdot \sin. A \quad \text{from (2) and this} = \frac{\sin. b}{\cos. b}$$

$$\frac{\cos. B}{\sin. B} \times \frac{\sin. A \cos. b}{\cos. B}$$

$$\text{But by (4)} \quad \cos. B = \cos. b \sin. A.$$

$$\therefore \sin. a = \tan. b \cotan. B \quad (25)$$

$$\text{Similarly} \quad \sin. b = \tan. a \cotan. A \quad (26)$$

(7.) *Napier's Rule for the Solution of Right-Angled Spherical Triangles.*

The formulas given in the last article can be included in a single rule, which is very easily enunciated and remembered. It is generally called Napier's Rule, having been invented by Napier, who, as we have already stated, was the inventor of logarithms. Leaving out C, which is 90° , there are three sides and two angles in the triangle, *viz.*, *a. b. c.* A. B. we will call the base, the perpendicular, the complements of the hypotenuse and the angles circular parts; if we fix on any of these and call it the middle part, then of the remaining four two will be adjacent, and the other two opposite: then it will be found that all the formulas of the last article are included in the following rule. "The sine of the middle part equals the product of the tangents of the adjacent parts, and also equals the product of the cosines of the opposite parts;"

$$\text{Or,} \quad \text{Sin. mid.} = \tan. \text{ad.} = \cos. \text{op.}$$

Thus, if $90^\circ - A$ is the middle part, then $90^\circ - c$ and *b* are the adjacent, and $90^\circ - B$ and *a* are the opposite part.

$$\text{The rule gives us} \quad \sin. (90^\circ - A) = \tan. (90^\circ - c) \tan. b = \cos. (90^\circ - B) \cos. a$$

$$\text{Or} \quad \cos. A = \tan. b, \cotan. c = \cos. a, \sin. B \quad (a)$$

Similarly if $90^\circ - B$ is the middle part, then $90^\circ - c$ and a are the adjacent, and $90^\circ - A$ and b the opposite parts. The rule gives us

$$\text{Cos. } B = \tan. a, \cotan. c = \cos. b, \sin. A \quad (l)$$

If a is the middle part then $90^\circ - B$ and b are the adjacent, and $90^\circ - c$ and $90^\circ - A$ the opposite part, then the rule gives us

$$\text{Sin. } a = \tan. b \cotan. B = \sin. c \sin. A \quad (m)$$

If b is the middle part then $90^\circ - A$ and a are the adjacent parts, and $90^\circ - c$ and $90^\circ - A$ the opposite parts, then the rule gives us

$$\text{Sin. } b = \tan. a \cotan. A = \sin. c \sin. B \quad (n)$$

Finally, if $90^\circ - c$ is the middle part, then $90^\circ - A$ and $90^\circ - B$ are the adjacent, and a and b the opposite parts, then the rule gives us

$$\text{Cos. } c = \cotan. A \cotan. B = \cos. a \cos. b \quad (o)$$

If the five formulas of the present article be compared with the 10 of article (6) they will be found identical. Hence Napier's Rule, as was stated, comprises all the formulas of Art. 6. It is a question whether as a matter of practice Napier's Rule is really more convenient than the disconnected formulas of Article (6).

(8.) *To explain the Method of Solution in the cases of Right-Angled Spherical Triangles.*

All the formulas of Art. 6, to which we refer in the present article, are expressed as products, and consequently are adapted for logarithmic calculations. The cases, as we have already seen, are the following :—

- (1) Given a and b , find c , A and B
Cos. c is given by (19), then cos. A is given by (23), and cos. B by (24)
- (2) Given c and a , find b , A and B
Cos. b is given by (19), then cos. A is given by (23), and cos. B by (24)
- (3) Given a and b , find b , c , and A
Cos. A is given by (21), then cos. b is given by (22), and tan. c by (23).
- (4) Given a and A , find b , c , and B
Sin. B is given by (21), then cos. b is given by (22), and cos. c by (19)
- (5) Given c and A , find a , b , and B
Sin. b is given by (17), then cos. a is given by (19), and cos. B by (22)
- (6) Given A and B , find a , b , and c
Cos. c is given by (20), cos. a by (21), and cos. b by (22)

It will be observed that each of the above determinations is clearly unambiguous, except the determination of B in (4), and b in (5), for these are the only two determinations made by means of sines; for which reason if B' and b' are the values less than 90° which satisfy (4) and (5), then $180^\circ - B'$ and $180^\circ - b'$ also satisfy (4) and (5), and hence it would seem that in the former case there would in general be two values of b and two of c , corresponding to B' and $180^\circ - B'$ respectively; and in the latter case that there would be two values of a given by (3), and therefore two values of B given by (6). If more closely considered, however, it will appear that there is really no ambiguity in case (5). We will consider the cases separately.

In case (4) we have given A and a . Now AB and AC being produced meet at A' where ABA' and ACA' are each of arc 180° (See Spherical Geometry, pp. 255, 256) and the angle at A' is equal to the angle at A . Hence the angle A and the side a belong equally to triangle ABC and to $A'BC$. And if we take the value of B less than 90° to be ABC . Then CBA' is $180^\circ - B'$, the second value indicated by the solution.

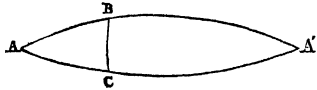

Fig. 4.

In case (5) — from (10) it appears that $\tan. a = \sin. b \tan A$.

Now $\sin. b$ is always positive, and hence the sign of $\tan. a$ must be the same as that of $\tan. A$. Hence if $A > 90^\circ$ a must be $> 90^\circ$ and if $a > 90^\circ$ A must be $< 90^\circ$, and A is given, hence only one of the two values of a is admissible. This also follows from geometrical considerations. Let C be the right-angle, then CA and CB when produced meet in C' , then since we have given AB (c) and BAC (A) we determine b , i.e. cA from the equation or $180^\circ - b$ i.e. AC' , but AC' belongs to a triangle on which the angle BAC' is not A but $180^\circ - A$, and \therefore the value AC' is inadmissible.

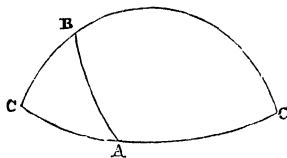

Fig. 5.

THE SOLUTION OF OBLIQUE-ANGLED TRIANGLES.

(9.) *To enumerate the Cases of Oblique-Angled Triangles.*

There are six cases of oblique-angled triangles, viz.,

- (1.) Given three sides, e.g. $a. b. c$
- (2.) Given two sides and the included angle, e.g. $a. b.$ and C
- (3.) Given two sides, an angle opposite to one of them, e.g. $a. b. A$
- (4.) Given one side and the two adjacent angles, e.g. $A. B. c$
- (5.) Given one side, the opposite angle and another angle, e.g. $A. C. c$
- (6.) Given the three angles, e.g. $A. B. C$

As in the case of right-angled triangles, these six cases are analogous to the four cases of plane oblique-angled triangles (p. 363.) But the fourth case of a plane triangle diverges on to the fourth and fifth of the spherical triangle, owing to the circumstance that $A + B + C$ is not known in the case of the spherical triangle, whereas in the plane triangle $A + B + C = 180^\circ$. For the same reason case (6) is peculiar to the spherical triangle.

(10.) *To solve the First Case of Oblique-Angled Triangles.*

We can obtain A from either of the formulas (5) (6) or (7), and then can obtain B and C from similar formulas. Of these formulas (7) which gives $\tan. \frac{A}{2}$ is the most convenient if we wish to find both of the other angles. Compare the analogous case of Plane Triangles, p. 363.

(11.) *To solve the Second Case of Oblique-Angled Triangles.*

In this case we will suppose that we have given a , b and C . Then from formulas (13) and (14) we can determine $\frac{A+B}{2}$ and $\frac{A-B}{2}$ and hence A and B ; and then, knowing A and B , we can determine c from formula (1).

If, however, we wish to determine c directly, *i.e.*, independently of A and B , we can effect our object by introducing a subsidiary angle in a manner analogous to the corresponding case of plane triangles. (See pp. 325, 365.) Thus, from formula (3) we have

$$\text{Cos. } C = \frac{\cos. c - \cos. a \cos. b}{\sin. a \sin. b}$$

$$\therefore \text{Cos. } c = \cos. a \cos. b + \sin. a \sin. b \cos. C$$

$$\begin{aligned} \therefore 1 - \text{Cos. } c &= 1 - \cos. a \cos. b - \sin. a \sin. b \cos. C \\ &= 1 - \cos. a \cos. b + \sin. a \sin. b - \sin. a \sin. b (1 + \cos. C) \\ &= 1 - (\cos. a \cos. b - \sin. a \sin. b) - \sin. a \sin. b (1 + \cos. C) \\ &= 1 - \cos. (a + b) - \sin. a \sin. b (1 + \cos. C) \end{aligned}$$

$$\text{Now } 1 - \cos. A = 2 \sin.^2 \frac{A}{2} \text{ and } 1 + \cos. A = 2 \cos.^2 \frac{A}{2}$$

$$\therefore \sin.^2 \frac{c}{2} = \sin.^2 \frac{a+b}{2} - \sin. a \sin. b \cos.^2 \frac{C}{2}$$

$$\text{Assume } \sin.^2 \theta = \sin. a \sin. b \cos.^2 \frac{C}{2}$$

$$\begin{aligned} \therefore \sin.^2 \frac{c}{2} &= \sin.^2 \frac{a+b}{2} - \sin.^2 \theta \\ &= \left(\sin. \frac{a+b}{2} - \sin. \theta \right) \left(\sin. \frac{a+b}{2} + \sin. \theta \right) \\ &= 2 \sin. \frac{1}{2} \left(\frac{a+b}{2} - \theta \right) \cos. \frac{1}{2} \left(\frac{a+b}{2} + \theta \right) \\ &\quad \times 2 \sin. \frac{1}{2} \left(\frac{a+b}{2} + \theta \right) \cos. \frac{1}{2} \left(\frac{a+b}{2} - \theta \right) \\ &= 2 \sin. \frac{1}{2} \left(\frac{a+b}{2} - \theta \right) \cos. \frac{1}{2} \left(\frac{a+b}{2} - \theta \right) \\ &\quad \times 2 \sin. \frac{1}{2} \left(\frac{a+b}{2} + \theta \right) \cos. \frac{1}{2} \left(\frac{a+b}{2} + \theta \right) \\ \therefore \sin.^2 \frac{c}{2} &= \sin. \left(\frac{a+b}{2} - \theta \right) \sin. \left(\frac{a+b}{2} + \theta \right) \end{aligned}$$

This latter method is very much easier than the former: for by this we only require five logarithms, whereas by that we require eight, for the determination of c .

(12.) *To solve the Third Case of Oblique-Angled Triangles.*

In this case we will suppose that we have given a , b , A . Then we obtain $\sin. B$ by formula (1); and knowing a , b , and A , B , we can determine C , by formula (13); and finally we can determine c by formula (1).

It will be observed that in this case, since the results depend on our determining B from a given value of $\sin. B$, they will be ambiguous, as in the analogous case of plane triangles (p. 366); for if B' is the value of $B < 90^\circ$, which we derive from formula (1): then $180^\circ - B'$ also satisfies formula (1).

This amount of ambiguity depends on the data. For let ABC be a triangle, having the angle $BAC = A$ $AC = b$ and $BC = c$. Produce AB and AC to meet in A' , draw $CB' = CB$. Then the given data belongs as much to the triangle ACB. as to ACB' . Moreover it is plain that $CBB' = CB'B$, and hence if $CB'A = B'$, we shall have $CBA = 180^\circ - B'$, the same conclusion that we derived from the formula.

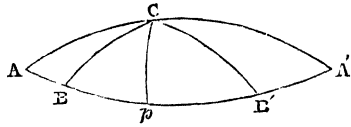

Fig. 6.

(13.) To solve the Fourth Case of Oblique-Angled Spherical Triangles.

In this we suppose that we have given A. B. and C. Then $\frac{a+b}{2}$ is given from formula (15), and $\frac{a-b}{2}$ from formula (16); hence we obtain a and b , and then we obtain C. by formula (1). If we wish to obtain C without the previous calculation of a and b , we must introduce a subsidiary angle θ and proceed as in article (11). From formula (4) we have

$$\text{Cos. } C = - \text{cos. } A \text{ cos. } B + \text{sin. } A \text{ sin. } B \text{ cos. } c.$$

Assume $\text{sin.}^2 \theta = \text{sin. } A \text{ sin. } B \text{ sin.}^2 \frac{c}{2}$

And we shall obtain

$$\text{Cos.}^2 \frac{C}{2} = \text{sin.} \left(\frac{A+B}{2} + \theta \right) \text{sin.} \left(\frac{A+B}{2} - \theta \right)$$

(14.) To solve the Fifth Case of Oblique-Angled Triangles.

In this case we will suppose that A. C. and c . are given. We shall obtain $\text{sin. } a$ from formula (1). Now, formula (13) gives us

$$\text{Tan.} \frac{A+C}{2} = \frac{\text{cos.} \frac{1}{2} (a-c)}{\text{cos.} \frac{1}{2} (a+c)} \text{cotan.} \frac{B}{2}$$

Whence we obtain B, and a similar modification of formula (15) will give us b : or, having B, we may obtain b from formula (1).

In this case a is determined from its sine, and therefore has two values, viz. a' and $180^\circ - a'$, and if both these values are admissible, the case is ambiguous.

In the triangle ABC let $AB = c$ $BAC = A$ and $BCA = C$, and suppose $BC = a'$, draw $BC' = a'$; then if a' is greater than c , it is plain that A falls between C and C' ; in this case produce $C'B$ and $C'C$ to meet in C'' . Then the angle $BCC' = BC'C = BC''C$. Hence the data belong equally to the triangle BAC. and BAC'' ; and the case is ambiguous, provided

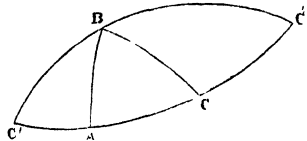

Fig. 7.

$c < a$; also it will be observed that $BC'' = 180^\circ - BC' = 180^\circ - BC = 180^\circ - a'$, as previously appeared from the calculation. If BC is less than BA , then C' would fall between B and A , and the above construction would be no longer possible. Hence if $c > a$, the case is not ambiguous.

(15.) *To solve the Sixth Case of Oblique-Angled Triangles.*

In this case we have given A, B, C . We shall find a from formula (11), and b and c from similar formulas. This case, however, never occurs in any of the practical applications of spherical trigonometry.

On the Solution of Quadrantal Triangles.

A quadrantal triangle (Spherical Geometry, def. xiv. p. 260) has one *side* of 90° , and \therefore the corresponding polar triangle is a right-angled triangle. From this consideration it would be easy to modify Napier's Rule to suit the case of the quadrantal triangle. In practice, however, it is better to treat them as oblique triangles—on doing so it will be found in practice that the circumstance of one side being equal to 90° will introduce important simplifications.

ON THE FORMULAS PECULIAR TO GEODETICAL OPERATIONS.

We have already stated in general terms that the science of spherical trigonometry finds one of its applications in Geodesy. It is to be observed that this application possesses some peculiarities in consequence of the sides of the triangles employed in a survey, on even the largest scale, being small compared with the radius of the earth, and consequently small when estimated in degrees or minutes; whereas, in astronomy, there is no limitation imposed on the magnitudes of the sides of the triangles employed in that science; our object in the present article is to explain concisely the results of this limitation, and to deduce certain formulas depending on it.

(16.) *To state the Object of a Trigonometrical Survey of a Country.*

The object of the survey is, (1) to fix accurately the relative positions of certain chief points in the country, so as to lay them down on a map; and (2), having fixed these chief points, then by means of subsidiary operations to lay down in detail all the minor features of the country, its roads, rivers, towns, hamlets, &c. The accompanying figure will be sufficient to illustrate this matter for our present purpose, which is from an actual survey. A , is a place called Ruckinge, B , High Nook, C , Allington, D , Lydd, E , Fairlight Down, and F , Tenterden. The line AB , is measured very accurately, and is called the *base line*; and then the angles CAB, ABC , are measured; from these data, AC , and CB , can be calculated; then CB being known, the angles DCB , and CBD , can be

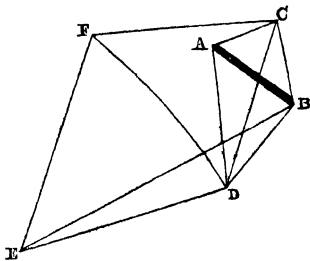

Fig 8.

measured, and thus CD, and DB, be determined; and this operation continued for any number of triangles whatever. It is usual in the larger triangles to measure all the three angles of any triangle, and not merely the two at the base; this is done with a view of keeping a check upon the various errors to which all observations are liable.

When the triangulating has been continued for some distance, it is necessary to compare the calculated length of a line that has been fixed upon, and then measure it; the coincidence of the two results is a verification of all previous measurements and calculations; hence such a line is called a *base of verification*. It is usual to choose stations that are from ten to twenty miles apart; also it is usual to choose for a *base line* a line of about four or five miles long. In late French surveys only two bases of verification have been used. The accuracy attainable in practice will be appreciated when the fact is stated that, in some English bases of verification, of four or five miles long, the computed and measured lengths have differed only by one or two inches. The operations of a trigonometrical survey are then two,—(1) the measurement of base lines, (2) the measurements of angles. We will proceed to consider each of these.

(17.) *The Measurement of a Base Line.*

A space of open ground which is nearly level must be chosen, the line to be measured being indicated by stations and stages erected, if necessary, to secure the horizontality of the base; the measure may be made by rods of glass, or steel, proper corrections being applied for temperature; a more convenient contrivance for securing accuracy in the measures has been devised of late for the Irish Survey, it is of the following kind:—

AB, CD, are rods of platina and iron riveted together at the middle point P, and are exactly the same length for a given temperature: Ap, Bq, are marks affixed to the ends of each. Now the metals have

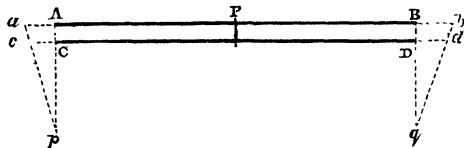

Fig. 9.

different expansions for the same temperature; suppose then that AB, for a change in temperature, becomes ab , while CD becomes cd , then Ap will assume the position

ap , and let $Aa = \delta a$ $Cc = \delta b$, then if Cp is taken so long that $\frac{Ap}{Cp} = \frac{\delta a}{\delta b}$ then p

will not be changed by the change of temperature; since within very large limits the

expansion of a metal is proportional to the increase of temperature, and $\therefore \frac{\delta a}{\delta b}$ is

constant; the same arrangement being made at the end, BD, the distance pq, will not be affected by change of temperature.

(18.) *To Correct for want of Straightness in the Base Line.*

The nature of the ground may be such as to render it impossible to measure a perfectly straight base line of sufficient length. This was the case in some of the French surveys, where the actual measurement was of *two straight lines* inclined to each other at an angle of very nearly 180° .

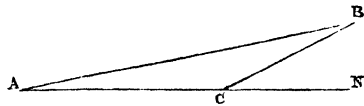

Fig. 10.

Let AB be the line the length of which is required, the measurements are $AC = b$, $CB = a$, and $BCN = \theta$ in circular measure $= n''$ suppose. Then it is plain that $AB < (a + b)$. Let us suppose $AB = a + b - x$; our object is to find x .

$$AB^2 = a^2 + b^2 - 2ab \cos. (\pi - \theta) = a^2 + b^2 + 2ab \cos. \theta$$

Now (Plane Trig. Art. 50, cor.) $\cos. \theta = 1 - \frac{\theta^2}{2}$, if we omit $\theta'' \dots$

$$\therefore AB^2 = a^2 + 2ab + b^2 - ab\theta^2 = (a + b)^2 \left\{ 1 - \frac{ab\theta^2}{(a + b)^2} \right\}$$

$$\therefore AB = (a + b) \left\{ 1 - \frac{ab\theta^2}{(a + b)^2} \right\}^{\frac{1}{2}} = (a + b) \left\{ 1 - 2 \frac{ab\theta^2}{(a + b)^2} \right\} \text{ if we omit } \theta' \dots$$

$$\therefore AB = a + b - \frac{ab\theta^2}{2(a + b)}$$

$$\therefore x = \frac{ab\theta^2}{2(a + b)}$$

$$\text{Now} \quad \frac{\theta}{n} = 180 \times \frac{\pi}{60 \times 60} = \cdot 000004848$$

$$\therefore x = \frac{ab}{a + b} \times \cdot 00000000001175$$

The correction to be applied to the sum of a and b , to obtain the true distance, AB .

(19.) *To measure the Angles of the Triangles of a Survey.*

Any two of the three angular points of one of these triangles is rarely in a horizontal plane passing through the third; the angle required is, of course, such a horizontal angle. Now the angles are measured either by a theodolite, or by a repeating circle—in the case of the former instrument, the vertical elevation of each object is observed, and the horizontal angle between them—that is to say, if ABC Fig. (D) are the stations, ANM the horizontal plane through A , BN and CM perpendiculars from B and C on AN , then by the theodolite we observe the angles BAN , CAM , and MAN ; the last is the horizontal angle required. The theodolite is the instrument that has been used in the English surveys. But if a repeating circle is employed, the angle BAC is the one observed; and it is necessary to deduce from this the horizontal angle MAN . The repeating circle is the instrument used in the French surveys.

(20). To determine the Correction for reducing an Angle to the Horizon.

Let ABCMN be the same as in last article; with centre A and any radius describe a sphere, which meets the lines AB AC, AN, AM in p, q, n, m , respectively. pn and mq , if

joined by great circles, clearly meet in Z vertically over A, since the circles must be perpendicular to the horizontal plane. Then mzn , or the angle mZn (Spherical Geometry, prop. v. cor. 4) is the angle required, and for its determination we have given

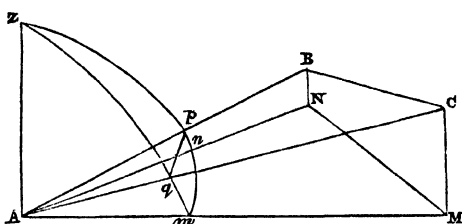

Fig. (11)

$pq = A$, $pn = h$, $qm = h'$. Suppose $mZn = A + \delta A$, then our object is to determine δA .

Now in triangle pZq we have by formula 3, $\cos. pZq = \frac{\cos. pq - \cos. pZ \cos. qZ}{\sin. pZ \cos. qZ}$

Now $pZ = 90^\circ - h$, and $qZ = 90^\circ - h'$

$$\therefore \cos. (A + \delta A) = \frac{\cos. A - \sin. h \sin. h}{\cos. h \cos. h'}$$

Now we will suppose δA so small that we can omit $\delta A^2 \dots$ and h and h' so small that we can omit every power and product higher than h^2, hh' , and h'^2 .

\therefore (Cor. Plane Trig. art. 50.) $\sin. \delta A = \delta A$, $\cos. \delta A = 1$, $\sin. h = h$, $\sin. h' = h'$, $\cos. h = 1 - \frac{h^2}{2}$, and $\cos. h' = 1 - \frac{h'^2}{2}$

$$\begin{aligned} \cos. (A + \delta A) &= \cos. A \cos. \delta A - \sin. A \sin. \delta A. \text{ Hence} \\ \cos. A - \delta A \sin. A &= \frac{\cos. A - hh'}{1 - \frac{1}{2}(h^2 + h'^2)} = \cos. A - hh' + \frac{h^2 + h'^2}{2} \cos. A \end{aligned}$$

$$\therefore \delta A \sin. A = hh' - \frac{h^2 + h'^2}{2} \cos. A$$

Now let $h + h' = p$, and $h - h' = q$. $\therefore 2h = p + q$, and $2h' = p - q$

$$\therefore 4hh' = p^2 - q^2, \text{ and } 2(h^2 + h'^2) = p^2 + q^2$$

$$\therefore 4 \delta A \sin. A = p^2 - q^2 - (p^2 + q^2) \cos. A = p^2 (1 - \cos. A) - q^2 (1 + \cos. A)$$

$$\therefore 4 \delta A 2 \sin. \frac{A}{2} \cos. \frac{A}{2} = p^2 \times 2 \sin.^2 \frac{A}{2} - q^2 \times 2 \cos.^2 \frac{A}{2}$$

$$\therefore 4 \delta A = p^2 \frac{\sin. \frac{A}{2}}{\cos. \frac{A}{2}} - q^2 \frac{\cos. \frac{A}{2}}{\sin. \frac{A}{2}}$$

$$\therefore \delta A = \frac{1}{4} \left\{ p^2 \tan. \frac{A}{2} - q^2 \cotan. \frac{A}{2} \right\}$$

Hence, whether we use the theodolite, or the repeating circle, we obtain the same end, namely, the determination of the horizontal angle. It is plain that the

horizontal angle being determined at each of the stations, these are the true angles, supposing the triangle spherical; and the triangle so determined is *spherical*.

We may proceed with the triangle thus obtained in either of the following ways:—

(21). *To Explain the Methods of Treating the Triangles thus Obtained.*

(a.) *Delambre's Method.*

It is supposed that we have tables of the kind described in Art. 72, Plane Trigonometry. Now we know a , the length of a side in feet, hence $\frac{a}{r}$ the angle subtended at the centre by a is known, and hence $\log. \frac{\sin. a}{a}$ is known; we will suppose the table to give us this for every value of a in feet. Then by simply adding $\log. a$ we obtain $\log. \sin. a$. Now from formula (1). $\frac{\sin. b}{\sin. a} = \frac{\sin. B}{\sin. A}$; hence $L \sin. b = L \sin. a + L \sin. B + ar : c : L \sin. A - 10$, from whence b can be obtained.

(b.) *By the Method of the Chordal Triangle.*

Let ABC be a given triangle, the sides of which are a, b, c , and angles A, B, C, join AB, BC, CD, by straight lines, then the plane triangle formed by these chords is called the chordal triangle. Let $C - \delta C$ be the angle of the chordal triangle corresponding to the angle C of the spherical triangle. Now, by Plane Trigon. art. 37,

$$2(\text{chord BC})(\text{chord CA}) \cos. (C - \delta C) = (\text{chord BC})^2 + (\text{chord CA})^2 - (\text{chord AB})^2$$

$$\therefore 2 \sin. \frac{a}{2} \sin. \frac{b}{2} \cos. (C - \delta C) = \sin.^2 \frac{a}{2} + \sin.^2 \frac{b}{2} - \sin.^2 \frac{c}{2}, \text{ since chord } \theta = 2 \sin. \frac{\theta}{2}$$

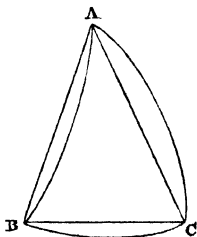

FIG. 12.

Again

$$\begin{aligned} \sin. a \sin. b \cos. C &= \cos. c - \cos. a \cos. b = \left(1 - 2 \sin.^2 \frac{c}{2}\right) \\ &- \left(1 - 2 \sin.^2 \frac{b}{2}\right) \left(1 - 2 \sin.^2 \frac{a}{2}\right) \\ \therefore 2 \sin. \frac{a}{2} \sin. \frac{b}{2} \cos. \frac{a}{2} \cos. \frac{b}{2} \cos. C & \\ = \sin.^2 \frac{a}{2} + \sin.^2 \frac{b}{2} - \sin.^2 \frac{c}{2} - 2 \sin.^2 \frac{a}{2} \sin.^2 \frac{b}{2} & \\ = 2 \sin. \frac{a}{2} \sin. \frac{b}{2} \cos. (C - \delta C) - 2 \sin.^2 \frac{a}{2} \sin.^2 \frac{b}{2} & \\ \therefore \cos. (C - \delta C) &= \cos. \frac{a}{2} \cos. \frac{b}{2} \cos. C + \sin. \frac{a}{2} \sin. \frac{b}{2} \end{aligned}$$

Now omitting $(\delta C)^2 \dots$ we have $\cos. C + \delta C \sin. C$.

$$\therefore \delta C \sin. C = \sin. \frac{a}{2} \sin. \frac{b}{2} - \left(1 - \cos. \frac{a}{2} \cos. \frac{b}{2}\right) \cos. C$$

Also $\sin. \frac{\alpha}{2} = \frac{a}{2}$ and $\cos. \frac{\alpha}{2} = 1 - \frac{a^2}{8}$, omitting $a^3 \dots$ (Plane Trig. Art. 50, Cor.)

$$\therefore \delta C \sin. C = \frac{ab}{4} - \frac{a^3 + b^3}{8} \cos. C.$$

Let $a + b = e$, and $a - b = f$: $4ab = e^2 - f^2$, and $2(a^2 + b^2) = e^2 + f^2$
 $\therefore 16 \delta C \sin. C = (e^2 - f^2) - (e^2 + f^2) \cos. C = e^2(1 - \cos. C) - f^2(1 + \cos. C)$

$$\therefore 32\delta C \sin. \frac{C}{2} \cos. \frac{C}{2} = 2e^2 \sin.^2 \frac{C}{2} - 2f^2 \cos.^2 \frac{C}{2}$$

$$\therefore \delta C = \frac{1}{16} \left\{ e^2 \tan. \frac{C}{2} - f^2 \cotan. \frac{C}{2} \right\}$$

In this we suppose the radius of the sphere to be unity; and so if, for instance, e is in feet and equals m feet, we must have $e = \frac{m}{r}$ where r is the earth's radius in feet. If we wish for δC in seconds, let $\delta C = n''$ then $\frac{\delta C}{n} = \frac{\pi}{180 \times 60 \times 60} =$
 0.000004848 , as we have already seen. $\therefore n = \frac{\delta C}{0.000004848}$

The above is the method used in the English surveys.

(c.) *By the method of Correcting the Angles, and Treating the Triangle as Plane.*

Let a, b, c , be the sides to radius r , then the circular measures of the sides are respectively $\frac{a}{r}, \frac{b}{r}, \frac{c}{r}$. Now

$$\cos. C = \frac{\cos. \frac{c}{r} - \cos. \frac{a}{r} \cos. \frac{b}{r}}{\sin. \frac{a}{r} \sin. \frac{b}{r}}$$

But if we suppose that we retain all terms up to the fourth order, i. e.

$$\left(\frac{a^1}{r} \right) \left(\frac{b^1}{r} \right) \frac{a^2 b^2}{r^4} \dots \text{Then}$$

$$\sin. \frac{a}{r} \sin. \frac{b}{r} = \frac{1}{\left(\frac{a}{r} - \frac{a^3}{6r^3} \right) \left(\frac{b}{r} - \frac{b^3}{6r^3} \right)} = \frac{1}{\frac{ab}{r^2} \left(1 - \frac{a^2 + b^2}{6r^2} \right)} = \frac{1}{\frac{ab}{r^2} \left(1 + \frac{a^2 + b^2}{6r^2} \right)}$$

and

$$\begin{aligned} \cos. \frac{c}{r} - \cos. \frac{a}{r} \cos. \frac{b}{r} &= 1 - \frac{c^2}{2r^2} + \frac{c^4}{24r^4} - \left(1 - \frac{a^2}{2r^2} + \frac{a^4}{24r^4} \right) \left(1 - \frac{b^2}{2r^2} + \frac{b^4}{24r^4} \right) \\ &= 1 - \frac{c^2}{2r^2} + \frac{c^4}{24r^4} - \left\{ 1 - \frac{a^2 + b^2}{2r^2} + \frac{a^4 + b^4 + 6a^2 b^2}{24r^4} \right\} \\ &= \frac{a^2 + b^2 - c^2}{2r^2} - \frac{a^4 + b^4 - c^4 + 6a^2 b^2}{24r^4} \end{aligned}$$

$$\therefore \cos. C = \frac{1}{2ab} \left(1 + \frac{a^2 + b^2}{6r^2} \right) \left(a^2 + b^2 - c^2 - \frac{a^4 + b^4 - c^4 + 6a^2 b^2}{12r^2} \right)$$

Taking in every term involving $\frac{1}{r}$.

$$\therefore \text{Cos. } C = \frac{1}{2ab} \left\{ a^2 + b^2 - c^2 + \frac{(a^2 + b^2)(a^2 + b^2 - c^2)}{6r^2} - \frac{a^4 + b^4 - c^4 + 6a^2b^2}{12r^2} \right\}$$

$$= \frac{a^2 + b^2 - c^2}{2ab} - \frac{1}{24abr^2} \left(2a^2b^2 + 2b^2c^2 + 2c^2a^2 - c^4 - b^4 - a^4 \right)$$

$$\text{Now } 2a^2b^2 + 2b^2c^2 + 2c^2a^2 - c^4 - b^4 - a^4 = 2b^2c^2 + 2c^2a^2 - c^4 - (b^2 - a^2)^2 =$$

$$4c^2b^2 - 2c^2(b^2 - a^2) - c^4 - (b^2 - a^2)^2 = 4c^2b^2 - (c^2 + b^2 - a^2)^2 =$$

$$(2cb + c^2 + b^2 - a^2)(2cb - c^2 - b^2 + a^2) =$$

$$\left\{ (b + c)^2 - a^2 \right\} \left\{ a^2 - (b - c)^2 \right\} = (b + c + a)(b + c - a)(a + b - c)(a - b + c)$$

$$= 16A^2, \text{ if } A \text{ is the area of a plane triangle whose sides are } a, b, c. \text{ (Plane Trigon. Art. 41.)}$$

$$\therefore \text{Cos. } C = \frac{a^2 + b^2 - c^2}{2ab} - \frac{16}{24} \cdot \frac{A^2}{abr^2}$$

Now if δC is the correction to be applied to the triangle, in order that we may be enabled to reckon the triangle plane, so that $C - \delta C$ is the angle of a plane triangle whose sides are a, b, c , then

$$\text{Cos. } (C - \delta C) = \frac{a^2 + b^2 - c^2}{2ab} \quad (\text{Plane Trigon., Art. 37.})$$

$$\text{And} \quad \text{Cos. } (C - \delta C) = \text{Cos. } C + \delta C \cdot \sin. C$$

$$\therefore \text{Cos. } C = \text{Cos. } C + \delta C \cdot \sin. C - \frac{2}{3} \cdot \frac{A^2}{ab r^2}$$

$$\therefore \delta C = \frac{2}{3} \cdot \frac{A^2}{ab \sin. C \cdot r^2} = \frac{1}{3} \cdot \frac{A}{r^2}$$

Since the area of the triangle is $\frac{1}{2} ab \sin. C = A$.

Now if E is the spherical excess, *i.e.* the excess of the sum of the three observed angles over two right angles, we have (Spherical Geometry, Prop. ix.)

$$A : \text{Area of hemisphere} :: E : 2\pi$$

E being in circular measure.

$$\therefore 2\pi A = E \times 2\pi r^2$$

$$\therefore E = \frac{A}{r^2}$$

$$\therefore \delta C = \frac{1}{3} E.$$

The same clearly holds good of either of the other angles; hence the rule determines the spherical excess into three equal parts, subtract one part from each of the angles, and the triangle can then be considered plane. If δC is equal to n'' then, as before,

$$n'' = \frac{A}{3r^2 \times .000004848}$$

It is to be observed that n is very small, *e.g.* rarely more than 5 or 6, hence a small error in the area will produce no appreciable error. Hence A can be found on the supposition that the original triangle is plane.

PRACTICAL GEOMETRY.

THE preceding portions of this treatise on "The Mathematical Sciences" having given, at the commencement of the several Books of Euclid, the general definitions of *a point, a line, &c.*, also the *Postulates* and *Axioms*, it is unnecessary again to repeat them, being sufficient for the student to refer to them when requisite, in order to give him a clear understanding or conception of the Problem he may at the time have under discussion. It is not here intended to give all the Problems contained in a complete treatise on Practical Geometry, but merely a selection of those which may be considered most useful in assisting the mechanical draughtsman, workman, or others who may be engaged in like pursuits.

Instruments.—For the purpose of performing the construction of the different Geometrical figures, the only instruments absolutely required are a pair of compasses, a ruler, a lead pencil, and a drawing pen.

COMPASSES.—The best form of compasses, or dividers (Fig. 1), are made of metal, such as brass or silver, from five to six inches in length, having steel points, and formed with one of the points or legs moveable, which at any time, as occasion may require, can be replaced by another containing a pencil leg (*a*), or a pen leg (*b*), the pen being constructed in the same manner as the drawing pen, afterwards described. The various uses to which the compasses may be applied are well known; the principal, however, being to measure or transfer distances, and when fitted with a pencil or pen to describe circles, the one with black-lead pencil, the other with ink.* The small figure (*c*) is an instrument used for tightening the joint of the compasses when the legs work too easily, or the reverse; the two points (*e e*) at the one end fitting into two small holes (*e e*) at the head of the compasses—the other end being used for screwing up the nails (*d d*) in the pencil or pen leg, so as to make the joint work easily.

RULER.—The ruler in general use is merely a bar of wood or metal, the edges being formed straight, and, for convenience, should be from six to twelve inches in length, about an inch in breadth, and is for the purpose of guiding the motion of the pencil or pen in a straight line or direction.

PENCIL.—It may perhaps be considered unnecessary to give a description of a common drawing pencil; but as there are few who, in commencing to draw mathematical figures, can form a proper point to their pencils, a few words may suffice to show the best method of doing it.

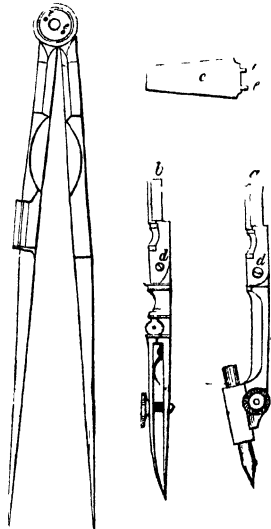

Fig. 1.

* The ink commonly used in drawing mathematical figures, &c., is that known as China Ink, which, being rubbed on a plate or palette, with a little water, runs more freely from the pen, and dries more quickly than common black writing ink; it also has the advantage of not running or blotting so much on the paper.

A pencil for drawing (Fig. 2) is generally prepared by sharpening the wood and lead, so as to form a fine point, similar to (No. 1) in the figure; but the point (No. 2), as shown in the figure, is the best form used for mechanical drawing, and is made by cutting two sides of the wood and lead flat, and leaving but a small flat edge on the other two sides, the one side showing a broad point, as at (a), the other a fine point, as at (b). In this way, the lead of the pencil may be kept close to the ruler, and at the

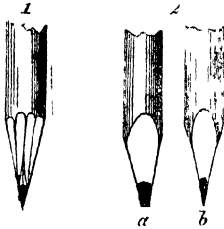

Fig. 2.

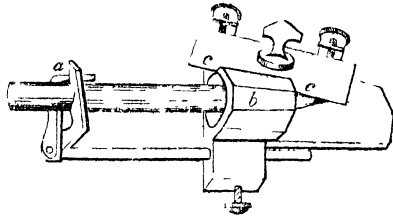

Fig. 3.

same time draw a fine line. A very simple and beautiful little instrument, not much known, called the "Pencil Cutter and Sharpener" (Fig. 3), has been invented, which forms the pencil point (No. 1), and is used by placing the pencil through the guides (a) into the hole or cone (b); and by turning it round with the hand against the knife edge (c), the point of the pencil is gradually formed.

DRAWING PEN—The drawing pen (Fig. 4), like a pencil, is used for drawing straight lines, guided along the edge of the ruler; it is usually made in two parts—*viz.*, the pen and the handle. The pen part consists of two blades, with steel points, so bent that the ends or points meet, but leaving a space or cavity for the ink; and in order to draw lines of different thickness, those blades can be opened more or less by a small screw. The best pens are also made with a joint to one of the blades, to admit of the pen being more easily cleaned by separating them. The other, or upper part, forming the handle of the pen, screws into the lower portion, having attached a short piece of steel with a very fine point, generally called the protracting pin, and is used for setting-off points in a line, or marking their intersections.

Having briefly described the few instruments requisite, it will be necessary to show their application, by performing the three following simple problems, generally given as Postulates (Euclid, Definitions, page 47), which however, by constructing, the student will the more readily become familiar with the instruments and their use.

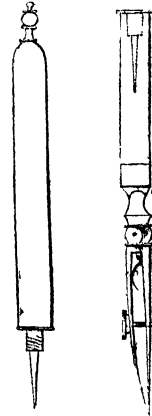
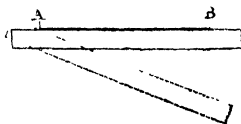

Fig. 4.

PROBLEM I.—To draw a straight line from any one point (A) to any other point (B).

Lay one edge of the ruler upon the point A, as shown in dotted lines in the figure,

and move the ruler round until it coincides with the point B; draw the point of the pencil or pen from A to B, keeping it always close to the edge of the ruler: the trace or mark left upon the surface of the paper is the straight line required.



PROBLEM II.—To prolong or produce the straight line (AB) to any length towards (C), in a straight line.

Place one edge of the ruler upon the point B at the extremity of the line AB; take any point in AB, such as *a*, so far from B that the distance may be less than the length of the ruler; make the ruler coincide with that point *a*, and draw as before with the pencil or pen from B towards C, which will leave the line produced as required. This operation may be repeated as often as wished, so as to prolong a line to any extent.

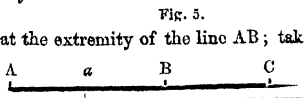

FIG. 5.

PROBLEM III.—To describe a circle from a centre (O), and at any distance (OA) from the centre (O).

Place the fixed leg or point of the compasses in the centre O, opening them until they take in the given distance OA or radius of the circle to be drawn; then move them round, describing the circumference of the required circle.

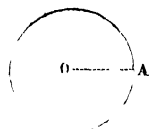

FIG. 7.

After performing the three preceding problems, it will be useful, in order to acquire a free use of the instruments in describing circles, drawing lines through points of intersection, and joining points by straight lines, to draw the accompanying figure several times, and thereafter to proceed to the construction of the following problems —

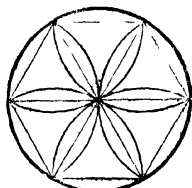

FIG. 8.

PROBLEM I.

To bisect or divide into two equal parts a given straight line (AB). (Euclid, Book I., Prop. X.)*

1ST METHOD.—When there is not sufficient space in the drawing on either side of the given line. By means of the compasses, place a leg at one of the extremities of the line, open them until the other leg is at any other point near the middle of the line; mark this point; transfer the leg of the compasses to the other extremity of the line, and mark the distance of the other leg from this point; if the two points so marked do not coincide, open the compasses to as near the middle of these two points as the eye will direct: proceed as before; the distance between the new points will be smaller than before, and a trial or two will enable us to bisect the line accurately.

2ND METHOD. †—When the given line (AB) occurs in or near the centre of the drawing,

* References are made to the propositions in Euclid, where several of the Problems are demonstrated, in order that the student, should he wish to investigate the Problems further, may do so by examining the methods of construction there adopted.

† This is the method most frequently used to bisect a line; but in practice it is not necessary to draw the whole arcs, but merely the intersections, and by means of the ruler placed on those points, to mark the centre point C. The line DC or DE, in this and the following Problem, when drawn, will also be found to be perpendicular to AB.

and there is sufficient room on both sides of the given line (AB). With the centre A (Fig. 9), and any radius greater than the half of AB, describe an arc; with the centre B, and the same radius, describe another arc, cutting the former in D and E; join the points of intersection D and E, cutting the line AB in C, which will bisect AB in the point C.

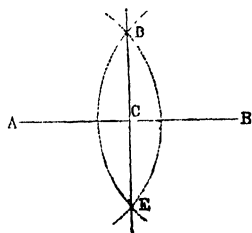

Fig. 9.

3RD METHOD.—When the given line (AB) occurs near the bottom of the drawing, and sufficient room is only left on one side of the given line (AB). With centres A and B (Fig. 10), and any equal radii greater than the half of AB (this radius should be as long as can be conveniently got), describe arcs cutting each other in the point D. With the same centres, and less equal radii, also greater than the half of AB, describe arcs cutting each other in the point E; join DE, and produce the line until it cuts AB in C, which will be the point of bisection of AB.

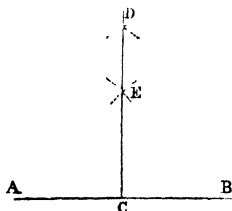

Fig. 10.

PROBLEM II.

To draw a perpendicular or a straight line at right angles to a given straight line (AB) from a given point (C). (Euclid, Book I., Prop. XI. and XII.)

1ST METHOD.—When the given point (C) is within or without the given line (AB) and near the middle of it. With the centre C (Fig. 11), and any radius, describe an arc cutting the line AB in the points E and F. With the centres EF, and the same, or any other equal radii, describe arcs cutting each other in the point D; join DC, then the line DC is perpendicular to the the line AB as required.

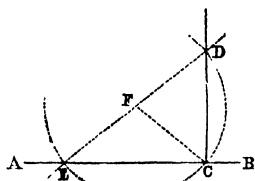
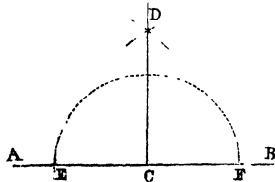

Fig. 12.

2ND METHOD.—When the given point (C) is within and at or near the extremity of the given line (AB). Take any point F (Fig. 12) above the line AB, and with the radius FC describe the arc ECD, cutting

AB in the point E; join EF, and produce it until it cuts the arc ECD in the point D, and join DC, which will be perpendicular to AB, as required.

3RD METHOD.—When the given point (C) is without and opposite the extremity of the given line (AB). In

the line AB (Fig. 13) take any two convenient points E, F. With the centre E, and radius

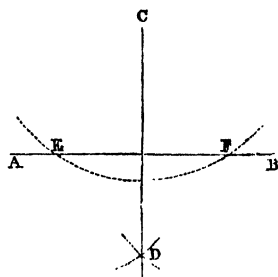

Fig. 11.

With the centre E, and radius

EC, describe the arc CGD, and with the centre F, and radius FC, describe an arc cutting the former arc CGD in the point C and D; join CD; the line CD will be perpendicular to the given line AB, as required.

A very simple method of setting off a perpendicular on the ground may be performed with a tape line in the following manner:—Suppose it was required to set out a straight line of road (CD) (Fig. 12) at right angles, or perpendicular to another straight line of road (AB) from any point (C) in AB. Put in a pin at the point C, and also one at E, along one side of the line of road AB, and three feet distant from C; put the end of the tape line at E, pass it round the pin at C, carrying it up in the direction of the line of new road, and bringing twelve feet on the line to the pin at E, and holding twelve feet and the end of the tape line fast at E, stretch the line tight, putting in another pin at seven feet on the line. When stretched, this will give the point D, and form a triangle, having sides three, four, and five feet respectively in length, of which DC will be perpendicular to EC, and form one side of the new road required.

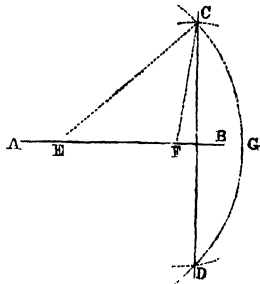
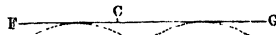

Fig. 13.

This method of setting off a perpendicular is taken from that beautiful theorem in Euclid (Book I., Prop. XLVII.), where in this case ED, the hypotenuse of the triangle, is equal to 5 feet, and the two sides EC and CD, 3 and 4 feet respectively; therefore $5^2 = 3^2 + 4^2$, or $25 = 9 + 16$. The sum of the three sides being 12, or the whole length of line used; but any numbers may be used (consistent with the length of the tape line), provided they fulfil the required value. It may be easily remembered that any multiple of the numbers used, viz., 3, 4, 5, will suffice.

PROBLEM III.

To draw a straight line parallel to a given straight line (AB), and through any given point (C). (Euclid, Book I., Prop. XXXI).



1ST METHOD.—Take any two points, D and E (Fig. 14), in the given line AB, the further apart from each other the better, with the centres D and E and radii equal to the distance between the point C and the line AB; * describe two arcs, and draw a straight line to touch or be a tangent to both arcs, then the line GH is parallel to AB.

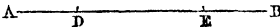

Fig. 14.

2ND METHOD.—From the point C (Fig. 15) draw the line CD perpendicular to AB; at another point anywhere in the line AB, but as far from D as convenient, draw EH perpendicular to AB. Make EH equal to CD, and draw through the points C and H the straight line FG, which will be parallel to AB.

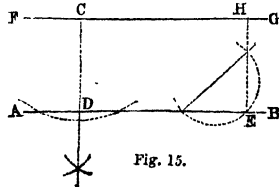

Fig. 15.

* The distance between C and the line AB is easily got by placing one point of the compasses at C, and opening them until the other point just touches, or describes an arc, AB. FG may be drawn parallel to AB at any distance apart, by merely using that distance as the radii of the arcs.

3RD METHOD.—Take any point D (Fig. 16), the further from C the better, in the line AB; join DC, and with the centre D, and radius DC (or any other convenient radius which will cut DC), describe an arc cutting AB in E; also with the centre C, and the same radius, describe an arc DII; again with the centre D, and a radius equal to the distance between C and E, describe an arc cutting the latter arc in H; draw the line FG passing through the points C and H; the line FG will be parallel to AB.

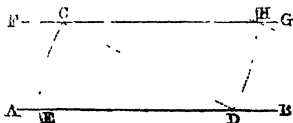

Fig. 16.

4TH METHOD.—Take any point D (Fig. 17) in the line AB; join DC and produce it, making CO equal to CD; with the centre O and radii OC and OD, describe two arcs, the latter cutting AB in E; join OE, cutting the lesser arc in the point H; draw the line FG passing through the points C and H, then FG will be parallel to AB.

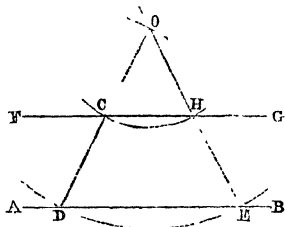

Fig. 17.

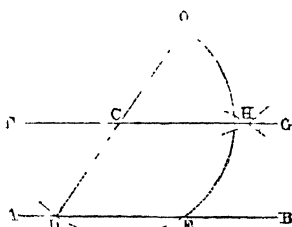

Fig. 18.

5TH METHOD.—Take any point D (Fig. 18) in the line AB; join DC and produce it; with the centre C, and radius CD, describe a circle, cutting AB in E, and DC produced in O; with the centres E and O, and the same radius, describe arcs intersecting in the point H; draw FG passing through the points C and H; then FG will be parallel to AB.

PROBLEM IV.

To divide a given straight line (AB) into any given number (say 6) of equal parts.

Through A (Fig. 19) draw a line AD at any angle with AB, and through B draw BC parallel to AD; from A set off six equal parts on the line AD (those equal parts should be as nearly the length of the required equal parts of AB as can be estimated), and from B on the line BC set off the same number (six) equal parts of the same length as before; join B and o, 1 and 1, 2 and 2, 3 and 3, 4 and 4, 5 and 5, A and 6; then the points where those lines cut AB, viz., in a, b, c, d, e, will divide the line AB into the required number (six) of equal parts.

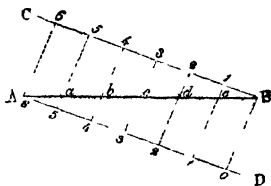

Fig. 19.

PROBLEM V.

To find a mean or mean proportional between two given lines (AB and BC).

Draw a straight line ABC (Fig. 20) equal in length to AB and BC together; bisect AC in O, and with the centre O and radius OA, or OC, describe a semicircle; from B draw a line perpendicular to AC, and meeting the semicircle in the point D, then BD is a mean or mean proportional between AB and BC.

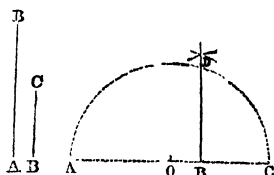

Fig. 20.

PROBLEM VI.

To describe a square on a given straight line (AB). (Euclid, Book I, Prop. XLVI.)

From the point A (Fig 21) draw AE perpendicular to AB (Problem II.), and from AE cut off AD equal to AB; draw DC and CB parallel to AB and AD respectively, intersecting at the point C; or, with B and D as centres, and radii equal to AB, describe arcs intersecting at the point C, and join DC and BC, then ABCD is the square required.*

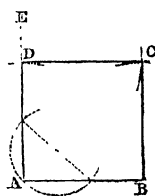

Fig. 21.

PROBLEM VII.

To describe a square which shall be equal to any number of given squares (1, 2, 3, 4, 5).

Draw any two lines, AB and AC (Fig. 22), at right angles to each other; in AB make AD equal to the side of the square 1, and in AC make AE equal to the side of the square 2, and join DE; then in AB make AF equal to DE, and in AC make AG equal to the side of the square 3, and join FG; again, in AB make AH equal to FG, and in AC AK equal to the side of the square 4, and join HK; lastly, in AB make AL equal to HK, and in AC make AM equal to the side of the square 5, and join LM; then the square LMNO, described on the line LM, is equal to the sum of the squares 1, 2, 3, 4, 5.

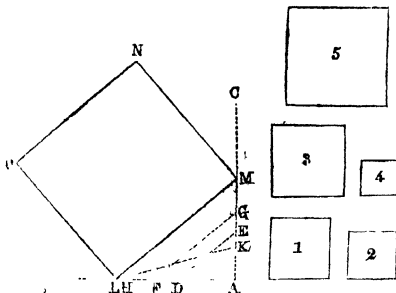

Fig. 22.

By proceeding in a similar manner till all the sides of any number of given squares are employed, a square may be constructed equal to the sum of the given number of squares; this, as well as the next problem, depending throughout their whole construction on (Euclid, Book I., Prop. XLVII.)

* Of course any rectangle whose length and breadth are given can be constructed in a similar manner, by making the perpendicular equal to the breadth, and either drawing parallels or using the length of the sides as radii.

PROBLEM VIII.

To describe a square which shall be equal to the difference of any two given squares (F and G).

Draw any two lines, AB and AC (Fig. 23), at right angles to each other; in AC make AD equal to the side of the less of the two given squares, F; with the centre D, and a radius equal to a side of the other given square G, describe an arc cutting AB in E; the square AEHK, described on the line AE, is the square equal to the difference of the two squares F and G.

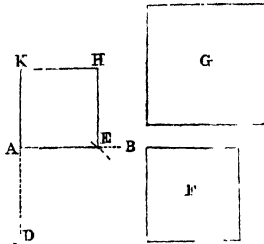

Fig. 23.

PROBLEM IX.

To describe a square which shall be equal to a given parallelogram (ABCD).

Draw any line GK, which shall be a mean proportional between the two sides, AB and BC of the given parallelogram (Problem V.), and upon the line GK describe the square HGKL, which will be equal to the given parallelogram, ABCD. (Fig. 24.)

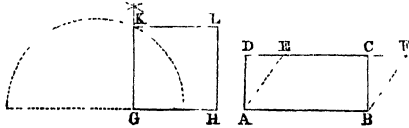

Fig. 24.

When the given parallelogram is not a rectangle, as AEFB, then draw a rectangle ABCD, standing on the same base, and between the same parallels (Euclid, Book I., Prop. XXXV.), equal to it, and proceed as before.

PROBLEM X.

To draw through a given point (F) a straight line, which shall tend to the intersection of two given straight lines (AB, CD), but whose point of intersection (O) falls beyond the limits of the drawing (LMN).

1ST METHOD.—Through the given point E, draw any line EC, meeting AB in A, and CD in C, draw any other line HK parallel to EC, meeting AB and CD in G and K; join CG, and through K draw KF parallel to it, meeting AB in F; join EG, and through F draw FH parallel to it, meeting KG produced in H; join EH, which, if produced, would pass through the point of intersection O.

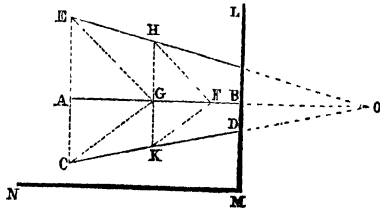
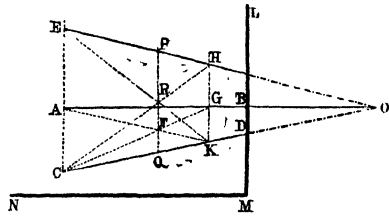

Fig. 25.

2ND METHOD.—Draw any two parallels EC and GK (Fig. 26), as before; join AK and CG, intersecting in F, and through F draw PQ parallel to EC or GK. Join EK, cutting PQ in R, and through the point R draw CH, meeting the line GK produced in H; join EH, which, if produced, would pass through the point of intersection O.



PROBLEM XI.

Fig. 26.

At a given point (E) in a given straight line (ED), to make an angle equal to a given angle (ABC). (Euclid, Book I., Prop. XXIII.)

With the centre B (Fig. 27) and any convenient radius, describe an arc, cutting AB in H, and BC in G; with the centre E and the same radius, describe an arc cutting ED in the point L; with the centre L and a radius equal to the distance HG, describe another arc, intersecting in the point K; join EK, and produce it if necessary; then the angle DEF will be equal to the angle ABC, as required.

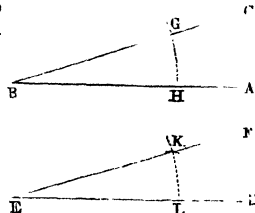

PROBLEM XII.

Fig. 27.

To bisect any given angle (ABC). (Euclid, Book I., Prop. IX.)

With the centre B (Fig. 28) and any convenient radius, describe an arc cutting BA in D, and BC in E, with D and E as centres, and any equal radii, describe arcs intersecting in the point F; join BF; then the angle ABC will be bisected by BF, or divided into two equal angles, ABF, and CBF.

By again bisecting the angles ABF, CBF, the angle ABC will be divided into four equal angles, and so on; by proceeding in a similar manner, the angle ABC may be divided into any even number of equal angles, continuing in geometrical progression—viz., 2, 4, 8, 16, 32 64, &c.

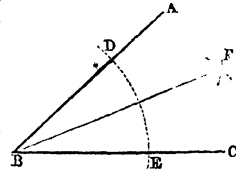

Fig. 28.

PROBLEM XIII.

To trisect or divide into three equal angles a given right angle (ABC).

With the centre B (Fig. 29) and any radius, describe an arc, cutting BA in D, and BC in E, from the points D and E as centres, and the same radius as before; describe arcs cutting the former arc in F and G; join B and the points of intersection F and G; then the angle ABC is divided in three equal angles, ABG, GBF, FBC.

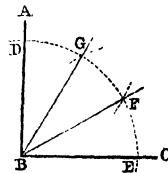

Fig. 29.

PROBLEM XIV.

To trisect or divide into three equal angles any given angle (ABC).

With the centre B (Fig. 30) and any radius, describe a circle cutting BA in D, and BC in E; bisect the angle ABC by the line BL (Problem XII.), and produce AB till it meets the circle in G; on the edge of the ruler mark off a distance (*bd*) equal to the length of the radius BD or BE, and lay the ruler at the point G, moving it until the point *b* cuts the circle, and the point *d* intersects the line BL, in H and F respectively; join BH, and set off HK equal to EH, leaving KD also equal to EH, and join BK; then the angle ABC will be divided into the three equal angles, ABK, KBH, and HBC.

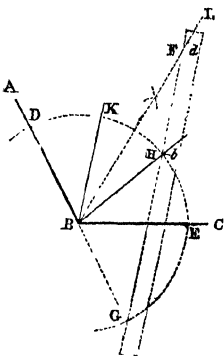

Fig. 30.

PROBLEM XV.

To describe an equilateral triangle upon a given straight line (AB). (Euclid, Book I., Prop. I.)

With the centres A and B (Fig. 31) and radii equal to AB, describe arcs intersecting in the point C; join AC and BC; the triangle ABC will be equilateral.

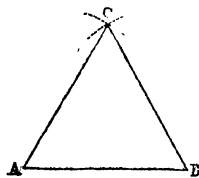

Fig. 31.

PROBLEM XVI.

To construct a triangle, whose side shall be respectively equal to three given straight lines (1, 2, 3), any two of which are greater than the third. (Euclid, Book I., Prop. XXII).

Draw any straight line, AB, (Fig. 32) equal to the given line 1, with the centre A and a radius equal to the given line 2 describe an arc, and with the centre B, and a radius equal to the given line 3, describe another arc, cutting the former at the point C; join AC and BC; then ABC will be the triangle required.

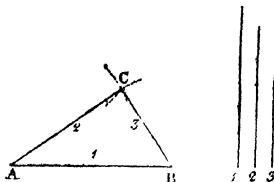

Fig. 32.

PROBLEM XVII.

To find the centre and radius of a given circle. (Euclid, Book III., Prop. I.)*

1st METHOD.—In the circumference of the given circle ABC (Fig. 33), take any

* This problem is performed in Euclid by drawing any chord, bisecting it by a perpendicular meeting the given circle at its two extremities, which gives the diameter of the circle, by bisecting which both the centre and radius of the circle are found.

point D, and from it as a centre, with any radius, describe a circle cutting the circumference of the given circle in the points E and F, with which as centres, and the same radius, describe arcs intersecting the circle EF in the points GH and KL. Draw lines passing through the points H and G, L and K, and produce them until they intersect each other in the point O, which is the centre of the circle, and OM or ON the radius.

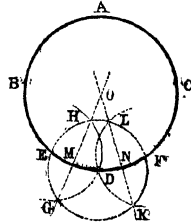

Fig. 32.

By this method the arcs DE and DF are bisected, and the problem may be performed by merely drawing any two chords, such as DE and DF, bisecting those chords by perpendiculars, which being produced, until they intersect each other, will give the centre.

2ND METHOD.—Take any five points, B, E, D, G, C (Fig. 34), in the circumference of the given circle ABC, equidistant from each other; draw lines passing through BE and GD, meeting in the point K; also through CG and ED, meeting in the point L; join EG, and draw BD and CD, cutting the line EG in M and N respectively; and through the points of intersection KM, and LN, draw lines, and produce them until they intersect each other in the point O, which is the centre of the given circle ABC.

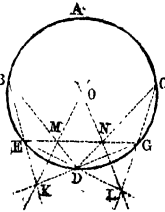

Fig. 34.

PROBLEM XVIII.

To describe a circle that shall pass through any three given points (ABC), which are not in a straight line.

From the point A (Fig. 35), as a centre, with any convenient radius greater than half the distance AB or AC, describe an arc, with B and C as centres, and the same radii, describe arcs cutting the former in the points D, F and E G; draw lines passing through those points intersecting each other in the point O, and with the centre O, and a radius equal to the distance OA, OB, or OC, describe a circle which will necessarily pass through the three given points A, B, and C.

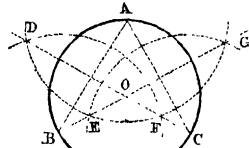

Fig. 35.

This problem will be found most applicable in the case of a circular arch, whose span (BC) and rise (AH) (Fig. 36), are given, and it is required to describe it; join AB and AC, bisect them by the perpendiculars DF and EG; then, as before, the point of intersection O is the centre with which to describe the circle.*

The joints of the stones or *voussoirs* forming the arch are drawn from the centre, and form continuations of the radii.

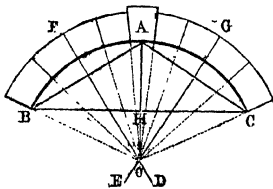

Fig. 36.

* See "Euclid," Book III., Prop. XXV.

PROBLEM XIX.

To find the point in a given straight line (AB), drawn from the one extremity of a given arc (AEC), through which the other extremity (C) of the given arc, if continued, would pass, and without using the centre.

From A (Fig. 37) draw any chord AD, and also any other chord AE, making the angle DAE equal to the angle BAD; with the centre D and radius DE describe an arc cutting AB in F; then F is the point in AB, through which the arc AEC, if continued, would pass.

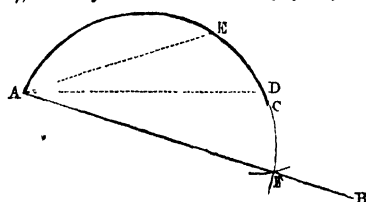

Fig. 37.

When the centre is either not known, or at too great a distance to be conveniently used (as very frequently occurs in practice), this problem will be found exceedingly useful.

PROBLEM XX.

To draw a tangent to a given circle (ABC) through a given point D in the circumference. (Euclid, Book III., Prop. XVII.)

1ST METHOD.—If the centre O of the given circle ABC (Fig. 38) is not given, find it by Problem XVII.; join OD, and through the given point D draw EF perpendicular to OD; then EF is the tangent required.

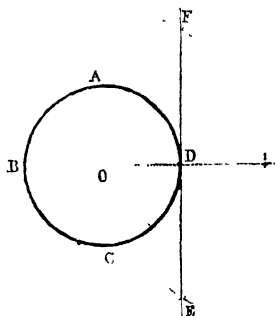

Fig. 38.

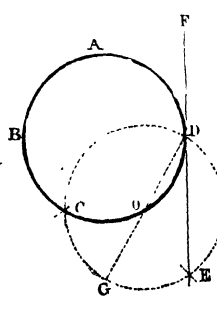

Fig. 39.

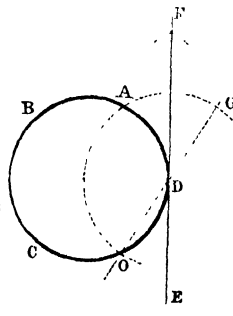

Fig. 40.

2ND METHOD.—Take any other point O (Fig. 39) in the circumference of the given circle ABC; join DO and produce it; with the centre O, and radius OD, describe a circle cutting the given circle in C, and DO produced in G; make the arc GE equal to the arc GC; join ED and produce it; then EF is the tangent required.

3RD METHOD.—Take any other point O (Fig. 40) in the circumference of the given circle ABC; join OD and produce it; with the centre D, and radius DO, describe a circle cutting the given circle in A and OD produced in G; with the centres A and G, and any equal radii, describe arcs intersecting each other in the point F; join FD and produce it; then EF is the tangent required,

PROBLEM XXI.

To draw a tangent to a given circle (ABC) through a given point (D) without the circumference. (Euclid, Book III., Prop. XVII.)

1ST METHOD.—Find the centre O (Fig. 41) of the given circle ABC; join OD, and bisect it in G; with the centre G, and radius GO or GD, describe a semicircle, cutting the given circle ABC in the point C, which is the point of contact; join DC and produce it; then ED is the tangent required, touching the circle at the point C, and drawn from the point D.

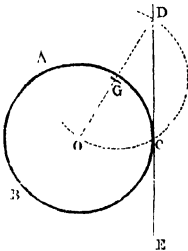

Fig. 41.

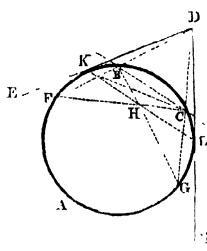

Fig. 42.

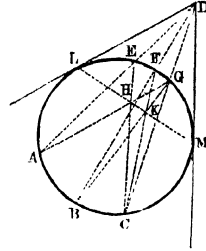

Fig. 43.

2ND METHOD.—With the given point D (Fig. 42) as a centre, and any radius, describe an arc cutting the given circle ABC in B and C; join DB, DC, and produce them till they meet the circumference of the given circle ABC in F and G; join BG and CF, cutting each other in the point H; join BC, and through H draw a line parallel to BC, and meeting the circle in the points KL; draw from the point D lines DE and DM, passing through K and L, which will be tangents to the circle ABC.

3RD METHOD.—From the given point D (Fig. 43) draw any three lines cutting the given circle in E, A in F, B and in G, C respectively; join GB, FC, intersecting in K, and GA, EC, intersecting in L; draw through H and K a line meeting the circle in the points L, M which will be the points of contact; and lines drawn from D through those points L, M will be tangents to the circle ABC.

PROBLEM XXII.

To describe a circle that shall touch two given straight lines^s (AB and CD) not in the same straight line, and touching at a given point (E) in one of them (AB).

Produce the given lines, AB and CD (Fig. 44), till they meet in the point G; make GF equal to GE; from E and F draw EO and FO perpendicular to AB and CD, respectively intersecting in the point O; and with the centre O, and radius OE or OF, describe the circle HEF, which will touch the given lines AB, CD, and also AB in the point E, as required.

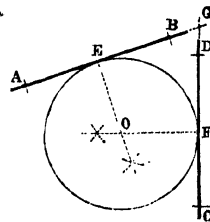

Fig. 44.

PROBLEM XXIII.

To describe a circle that shall touch a given straight line (AB) in a given point (E), and shall also pass through another given point (F) not in the same straight line (AB).

From the given point E (Fig. 45) draw EG perpendicular to AB; join EF, and bisect it by a perpendicular CD, cutting EG in the point O, with which as a centre, and the radius OE, describe the circle EDF, which will touch the line AB in the given point E, and also pass through the given point F.

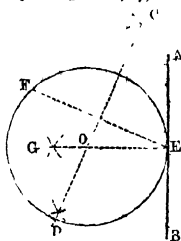

Fig. 45.

PROBLEM XXIV.

To describe a part of a circle that shall touch a given straight line (AB) in a given point (E), and shall also touch a given arc (DGH).

Draw EC (Fig. 46) perpendicular to AB; and through the centre K of the given arc DGH, draw KL parallel to EC, and meeting the arc DGH continued in the point L; join LE, and produce it to meet the given arc in the point D, and join DK, cutting EC in O; then with the centre O, and radius OE, describe a part of a circle which will touch the given line AB in the given point E, and also the given arc DGH in the point D.

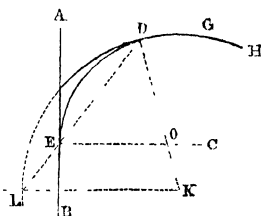

Fig. 46.

PROBLEM XXV.

To describe two arcs that shall meet each other in the line of their centres, and shall touch two given straight lines (AB, CD) at the given points (E, F) in those lines, the radius (EG) of the lesser arc being also given.

From the point E (Fig. 47) draw EG perpendicular to AB, and equal to the given radius, and from the point F draw FH perpendicular to CD, and make it equal to EG; join GH; bisect GH by a perpendicular KO, cutting FH produced in the point O; join OG, and produce it, then with O as a centre, and radius OF, describe an arc meeting OG produced in L. With the centre G, and radius GE or GL, describe an arc meeting the former arc in L; then the arcs FL and EL are those required, meeting each other at the point L in the line LO, passing through both their centres G and O, and also touching AB and CD in E and F.

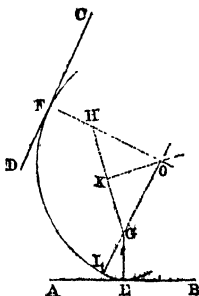

Fig. 47.

PROBLEM XXVI.

To find a straight line nearly equal to the length of a given arc (ABC).

Bisect the given arc in B (Fig. 48), and draw the lines AB, AC; with the centre A, and radius AB, describe an arc cutting AC in D; make DE in AC produced equal to AD, and divide CE into three equal parts, and make EF equal to one of the parts; then AF will be nearly equal to the arc ABC.

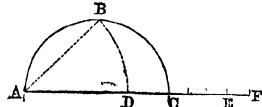

Fig. 48.

PROBLEM XXVII.

To draw a straight line nearly equal to the circumference of a given circle (ADBC).

Draw the diameters AB and CD (Fig. 49) at right angles to each other; produce CD until DE is equal to three-fourths of DO; through C draw FG parallel to AB; join EA, EB, and produce them until they meet FG in F and G; then FG will be nearly equal to the semi-circumference of the circle AD BC.

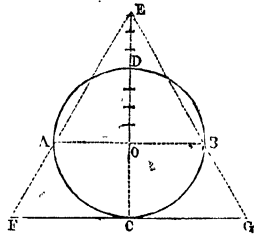

Fig. 49.

PROBLEM XXVIII.

To inscribe a circle in a given triangle (ABC) that shall touch all its sides. (Euclid, Book IV., Prop. IV.)

Produce AC (Fig. 50) both ways; with the centre A, and any radius, describe an arc cutting AC produced in D, and AB in E; also with the centre C, and the same radius, describe an arc cutting AC produced in F, and BC in G; join DE and FG, and draw through A and C lines parallel to DE and FG respectively, and cutting each other in the point O; then O is the centre of the required circle (the lines AO and OC will bisect the angles BAC and ACB, which might be done by Problem XII). From O draw OH perpendicular to AC; then with the centre O, and radius OH, describe a circle which will touch all the sides of the given triangle ABC.

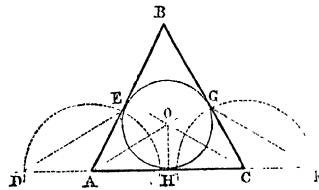

Fig. 50.

PROBLEM XXIX.

To describe a circle about a given triangle (ABC). (Euclid, Book IV., Prop. V.)

This Problem is simply to describe a circle passing through three given points, ABC, as given before in Problem XVIII.

PROBLEM XXX.

To draw a square within or about a given circle (ACBD). (Euclid, Book IV., Props. VI. and VII.)

Draw through the centre O (Fig. 51) any two diameters, AB and CD , at right angles to each other, meeting the circle in the points A, C, B, D . To inscribe a square in the circle, join those four points; then $ACBD$ is the square required; and to describe a square about the circle, draw tangents or lines parallel to the diameters at those four points, then $EFHG$ is the square required.

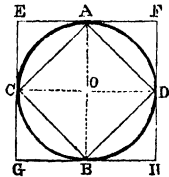

Fig. 51.

PROBLEM XXXI.

To circumscribe and inscribe circles to a given square (ABCD). (Euclid, Book IV., Props. VIII. and IX.)

Draw the diagonals, AC, BD (Fig. 52), intersecting in the point O , the centre of the required circles. With the centre O , and radius OA , describe a circle which will pass through A, B, C and D , and be circumscribed about the given square $ABCD$. From O , draw OE perpendicular to DC ; and again with the centre O , and radius OE , describe a circle which will touch all the four sides of the square, and be inscribed in the given square $ABCD$.

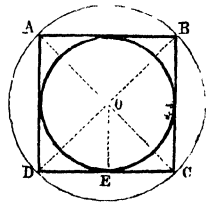

Fig. 52.

PROBLEM XXXII.

To describe a pentagon on a given straight line (AB). (Euclid, Book IV., Props. XI. and XII.)

1st METHOD.—Bisect AB in C (Fig. 53), and from B draw BD perpendicular to AB , and equal to AC or BC ; join AD and produce it; with the centre D and radius DB describe a circle cutting AD produced, in E ; with the centres A and B and radii, each equal to AE , describe arcs intersecting in F ; lastly, with the centres A and F , and radii, each equal to AB , describe arcs intersecting in G , and with B and F as centres, and the same radii, describe arcs intersecting in H ; join AG, FG, FH , and BH ; then $ABHFG$ is the pentagon required.

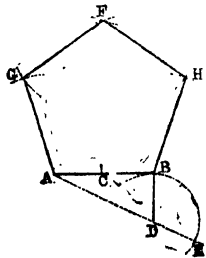

Fig. 53.

2ND METHOD.—Bisect AB in C (Fig. 54), and from B draw BD perpendicular to AB , and equal to AC or BC ; join AD and produce it; with the centre D , and radius DB , describe a circle cutting AD produced, in E ; join BE with the centres A and B and radii, each equal to BE , describe arcs intersecting in O , with which as a centre and radius OA or OB , describe a circle. With the centres A and B and radii, each equal to AB , describe arcs cutting the circle in G and H ; lastly, with the centre G or H , and the same radius, describe an arc cutting the circle in F , and join AG , GF , FH , HB ; then $AGFHB$ is the pentagon required.

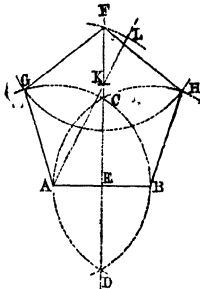

Fig. 54.

3RD METHOD.—With the centres A and B (Fig. 55), and radii, each equal to AB , describe circles intersecting in C and D ; join CD , cutting AB in E , and produce it. Make EK equal to AB ; join AK , and produce it, till KL is equal to AE or EB ; with the centre A , and radius AL , describe an arc cutting DC produced in F ; and with the centre F and radius AB describe a circle cutting the circles DAC and DBC in H and G respectively; join AG , FG , FH , and BH ; then $ABHFG$ is the pentagon required.

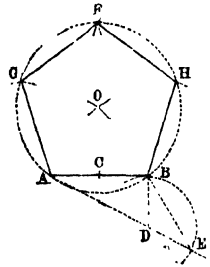

Fig. 55.

PROBLEM XXXIII.

To describe a regular hexagon upon a given straight line. (Euclid, Book IV., Prop. XV.)

With the centres A and B (Fig. 56), and radii, each equal to AB , describe circles intersecting in O ; with the centre O , and the same radius, describe another circle, cutting the two former in F and C respectively; join AO and BO , and produce them till they meet the latter circle in D and E respectively; join BC , CD , DE , EF , and FA ; then $ABCDEF$ is the hexagon required. From this it will be seen that the side of a hexagon is equal to the radius of the circumscribed circle; and by merely finding the centre O as above, and setting off the length of the given line six times round the circumference, the hexagon will be constructed.

PROBLEM XXXIII.

To describe a regular hexagon upon a given straight line. (Euclid, Book IV., Prop. XV.)

With the centres A and B (Fig. 56), and radii, each equal to AB , describe circles intersecting in O ; with the centre O , and the same radius, describe another circle, cutting the two former in F and C respectively; join AO and BO , and produce them till they meet the latter circle in D and E respectively; join BC , CD , DE , EF , and FA ; then $ABCDEF$ is the hexagon required. From this it will be seen that the side of a hexagon is equal to the radius of the circumscribed circle; and by merely finding the centre O as above, and setting off the length of the given line six times round the circumference, the hexagon will be constructed.

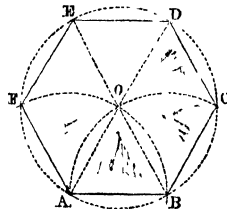

Fig. 56.

PROBLEM XXXIV.

To describe a regular octagon on a given straight line (AB).

With the centres A and B (Fig. 57), and radii equal to AB , describe circles intersecting in K ; with the centre K , and the same radius, describe a circle cutting the two former in L and M ; with the centres L and M , and still the same radius, describe arcs cutting the last circle in N and O ; join AN and BO , by lines cutting the two first circles in P and Q , and produce them; join AQ and BP , and produce them till PG and QD are each equal to AB ; and lastly, with the

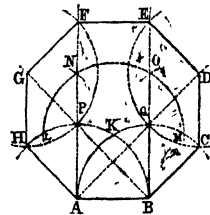

Fig. 57.

centres G and D , and the same radii, equal to AB , describe circles cutting the two first circles in H and C , and the lines AN and BO produced, in F and E . Join BC , CD , DE , EF , FG , GH and HA ; then $ABCDEFGH$ is the octagon required.

2ND METHOD.—With the centres A and B (Fig. 58), and radii, each equal to AB , describe circles cutting each other in K and L ; join KL , and through A and B draw AF and BE parallel to KL , cutting the circles in M and N ; join AN and BM , and parallel to them through A and B draw AH and BC , meeting the circles in H and C ; through H and C draw HG and CD parallel to KL , and meeting BM and AN produced in G and D ; and lastly, through G and D draw GF and DE parallel to AD and BG , cutting AM and BN produced in F and E ; join FE ; then $ABCDEFGH$ is the octagon required.

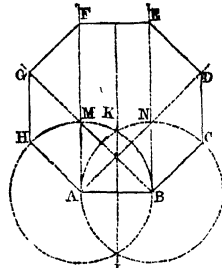

Fig. 58.

PROBLEM XXXV.

To describe a regular polygon (containing any number of given sides) upon a given straight line (AB).

With the centre B (Fig. 59), and radius AB , describe a semicircle, meeting AB produced in H ; divide the semicircle into as many equal parts as in the proposed polygon; join B and the second point of division C ; bisect each of the sides AB and BC by perpendiculars intersecting in O ; then with the centre O , and radius OA , OB , or OC , describe a circle, which will pass through the points A , B , and C ; this circle will be that described about the required polygon; and therefore, by setting off AB as many times as required round the circle thus formed, the polygon will be described. The example given in the figure is a nonagon, or nine-sided figure.

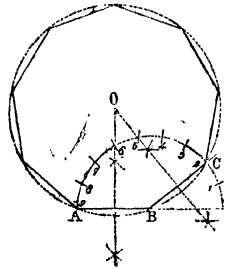

Fig. 59.

ON THE CONSTRUCTION OF THE CONIC SECTIONS.

The preceding propositions depend entirely on the properties of straight lines and circle, and therefore admit of construction by rule and compasses. Now, beside the circle there are several curves which are used more or less by draughtsmen; these are for the most part drawn, when required, by determining accurately several points in them which are then neatly joined by the hand. Of these curves the *ellipse* is the one oftenest needed, and is used, in fact, almost as much as the circle, in consequence of the perspective representation of a circle being an ellipse. Besides the *ellipse*, the *hyperbola* and *parabola* are often needed in the delineation of shadows. These three curves are generally called conic sections, and for this reason—if a right cone is cut by a plane, the curve which bounds the section is one of these three, except in the special cases when the elliptic section degenerates into a circle, and the hyperbolic into two

straight lines. The object of the few following pages is to prove such properties of those curves as shall enable us to give rules for their construction. The complete investigation of their properties, which forms a distinct and very interesting branch of mathematics, is not here intended.

DEFINITION 1.—Let dD (Fig. 60) be a given fixed straight line, called the directrix; S a given fixed point, called the focus; P a moveable point. Let Pd be perpendicular to the given straight line; then if P move in such a manner that SP bears a constant ratio to Pd , it traces out one of the curves called conic sections.

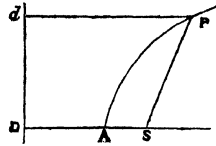

Fig. 60.

DEFINITION 2.—Suppose $SP : Pd :: e : 1$, then if $e < 1$, the curve is an ellipse; if $e = 1$, the curve is a parabola; if $e > 1$, the curve is a hyperbola.

THE ELLIPSE.

Let Dd, S and P (Fig. 61) be the same as in the foregoing definitions; through S draw DA perpendicular to Dd . Then if A and a are so taken that $SA : AD :: e : 1$, and $Sa : aD :: e : 1$, then A and a are points in the ellipse; also the line Aa is the transverse diameter or major axis; bisect Aa in C , then C is the centre of the ellipse; through C draw BCb perpendicular to Aa , then Bb is called to conjugate to the transverse diameter, or the minor axis; take H , so that $aH = AS$, or so that $CS = CH$, then H and S are called the foci (singular focus).

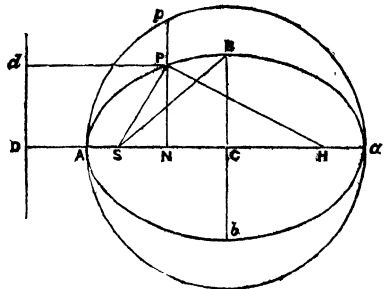

Fig. 61.

1. To show that in the ellipse $CS = e, AS$.

We have already seen that $AS = e. AD$, also that $Sa = e. aD \therefore aS - SA = e(aD - DA)$, and $aH = AS$. $\therefore SH = e. Aa$, or $SC = e. AC$. Q.E.D.

N.B. e is called the eccentricity of the ellipse.

(2.) To show that $SB = AC$.

Manifestly $SB = e. DC = e. AD + e. AC = AS + SC = AC$. Q. E. D.

COR.—Hence, $BC^2 = SB^2 - SC^2 = AC^2 - SC^2 = AC^2(1 - e^2)$.

(3.) To show that $SP = AC - e. CN$.

Manifestly, $SP = e. DN = e(DE - CN) = e(DA + AC) - e. CN$
 $= e. DA + e. AC - e. CN = AS + SC - e. CN$
 $= AC - e. CN$.

(4.) To show that $\frac{PN^2}{CB^2} + \frac{CN^2}{CA^2} = 1$.

For $SP^2 = SN^2 + PN^2$ (Eucl. I., 47). But $SP = AC - e. CN$ and $SN = SC - CN$
 $\therefore (AC - e. CN)^2 = (SC - CN)^2 + PN^2$ and $SC = e. AC$.

$$\therefore AC^2 - 2e AC, CN + e^2 CN^2 = e^2 AC^2 - 2e AC CN + CN^2 + PN^2.$$

$$\therefore AC^2 (1 - e^2) = CN^2 (1 - e^2) + PN^2.$$

$$\therefore 1 = \frac{CN^2 (1 - e^2)}{AC^2 (1 - e^2)} + \frac{PN^2}{AC^2 (1 - e^2)} \quad \text{Now } AC^2 (1 - e) = CB^2.$$

$$\therefore 1 = \frac{CN^2}{AC^2} + \frac{PN^2}{BC^2}.$$

$$\therefore \frac{PN^2}{BC^2} + \frac{CN^2}{AC^2} = 1. \quad \text{Q.E.D.}$$

COR.—With centre C and radius CA, describe a circle *Apa*; produce NP to meet the circumference in *p*; join Cp, which is plainly equal to AC.

$$\text{Now } pN^2 + CN^2 = Cp^2 = CA^2.$$

$$\therefore \frac{PN^2}{CA^2} + \frac{CN^2}{CA^2} = 1.$$

$$\therefore \frac{PN^2}{CB^2} = \frac{pN^2}{CA^2}.$$

$$\text{Or, } PN : pN :: CB : CA.$$

This result, and the previous one, we have already had occasion to use in the article on Mensuration. (See p. 376, &c.)

(5.) *To show that HP = AC + e CN.*

$$\text{For } HP^2 = PN^2 + NH^2 = PN^2 + (CN + CS)^2 = PN^2 + (CN + e CA)^2.$$

$$\text{Now from art. 4. } PN^2 = CB^2 - \frac{CB^2}{CA^2} CN^2 = (1 - e^2) CA^2 - (1 - e^2) CN^2.$$

$$\therefore HP^2 = CA^2 - e^2 CA^2 - CN^2 + e^2 CN^2 + CN^2 + 2e CA, CN + e^2 CA^2. \\ = CA^2 + 2e CA, CN + e^2 CA^2 = (CA + e CN)^2.$$

$$\therefore HP = CA + e CN.$$

COR.—Hence, SP + HP = CA - e CN + CA + e CN = 2 CA = *Aa*.

Or, SP + PH = the major axis of the Ellipse.

On this property of the Ellipse the first and third practical methods of construction depends.

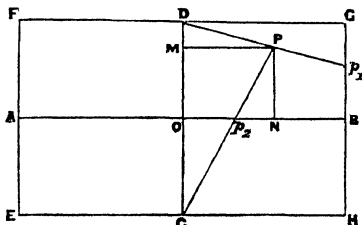

FIG. 62.

(6.) *If EFGH (Fig. 62) is a rectangular parallelogram, and DC and AB are the lines joining the bisections of the opposite sides, divide GB into *n*, equal parts, and also OB into *n*, equal parts. Let *Gp*₁ contain *p* of the parts into which GP is divided, and let *Op*₂ contain *p* of the equal parts into which OB is divided, join *Dp*₁ and *Cp*₂ and produce it to meet *Dp*₁ in P; then P is a point in the Ellipse, whose major and minor axes are AB and OD.*

For, drawn PN parallel to DO and \therefore perpendicular to AB.

$$\text{Now, } Op_2 = \frac{p}{n} OB. \text{ and } Gp_1 = \frac{p}{n} OD.$$

$$\text{Also, } \frac{OD - PN}{ON} = \frac{OD - p_1 B}{OB} = \frac{Gp_1}{OB} = \frac{p}{n} \cdot \frac{OD}{OB}.$$

Again, draw PM perpendicular DO. Then

$$\frac{Op^2}{OC} = \frac{MP}{MC'} \text{ or } \frac{ON}{OC + OM} = \frac{p}{n} \cdot \frac{OB}{OC}$$

$$\text{Now } OC = OD \therefore \frac{OD + PN}{ON} = \frac{n}{p} \cdot \frac{OD}{OB}$$

$$\text{But we have already seen that } \frac{OD - PN}{ON} = \frac{p}{n} \cdot \frac{OD}{OB}$$

$$\therefore \frac{OD^2 - PN^2}{ON^2} = \frac{OD^2}{OB^2}$$

$$\therefore \frac{PN^2}{OD^2} + \frac{ON^2}{OB^2} = 1.$$

Hence by article (4), P is a point in an ellipse, whose major and minor axes are OB and OD respectively.

On this principle the second practical method is founded.

(7). If AB, CD (Fig. 63) are two lines at right angles to each other, and bisecting each other in the point O, then if Pab is a straight line, so placed that Pb = OC and Pa = OA, then the point P is in an ellipse, whose axes are AB and CD.

For draw PN, PM at right angles to OC and OA.

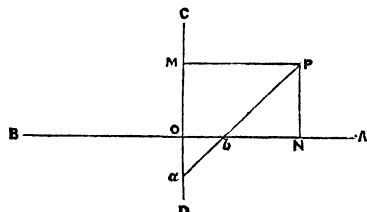

Fig. 63.

Now by similar triangles,

$$\frac{Ob}{ab} = \frac{PM}{Pa} = \frac{ON}{OA}$$

$$\text{and } \frac{Oa}{ab} = \frac{PN}{Pb} = \frac{PN}{OC}$$

$$\therefore \frac{PN^2}{OC^2} + \frac{ON^2}{OA^2} = \frac{Ob^2 + Oa^2}{ab^2} = \frac{ab^2}{ab^2} = 1. \text{ Since } bOa \text{ is a right angle.}$$

Hence (art. 4) P is a point in the specified ellipse. Q. E. D.

This is the principle of the Trammel described in the fourth practical method.

To describe an Ellipse, the transverse (AB) and conjugate (CD) diameters being given.

1st METHOD.—Draw AB and CD, bisecting each other at right angles, in the centre O (Fig. 64); with the centre D or C and radius OA or OB, describe arcs cutting AB in F and F', which points will be the foci of the ellipse; take any other point P in the transverse diameter AB, and with the centres F, F' and radii equal to AP and PB, respectively, describe arcs intersecting in the point E, which will be a point in the curve. By taking several points in the transverse diameter, and proceeding in a similar manner, as many points in the

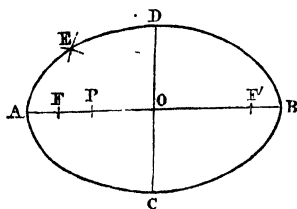

Fig. 64.

curve may be found as may be required, through which the ellipse may be drawn.

2ND METHOD.—Through the extremities of the given diameters draw the rectangle EFGH (Fig. 65); divide AE, AF and BH, BG into any number of equal parts (say 3); also divide AO and OB into the same number of equal parts; join D and the points of division in AF and BG, also C and those in AE, and BH. Again, from D draw lines through the points of division in AO and OB, intersecting the lines drawn from C to the points in AE and BH; and in the same manner from C draw lines through the points of division in AO and OB, intersecting the lines drawn from D to the points in AF and BG; the intersections thus derived are points in the curve through which the required ellipse may be drawn.

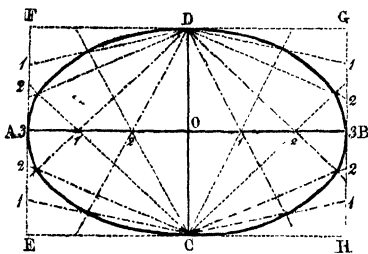

Fig. 65.

3RD METHOD.—An ellipse may easily be drawn by means of a thread, in the following manner:—

Find the foci F and F' (Fig. 66) as in the first method; take a piece of thread equal in length to the distance between the foci added to the transverse diameter, and fasten the two ends; having fixed two pins in the foci, pass the thread round them and stretch it, place a pencil in the angle made by the thread when stretched, and commencing at one end (D) of the conjugate diameter, the thread being in the position FDF' (as shown in dotted lines), move the pencil point round, keeping the thread always stretched until the point again meets at D; the ellipse will be drawn.

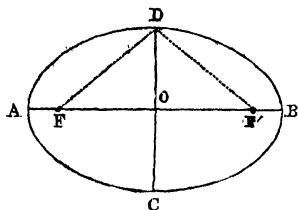

Fig. 66.

4TH METHOD.—An instrument called a *trammel* is sometimes used for describing an ellipse, and is generally formed of two pieces of wood fixed at right angles to each other, and having a groove running through the centre of each, the groove being made a little wider at the bottom than at the top, in order to keep the guides *b, c*, (Fig. 67) attached to the bar, *abc*, in the groove; the bar, *abc*, should have a pencil fixed at the end *a*, the two guides, *b* and *c*, being moveable or sliding along the bar, but when set ready for use, secured by small screws in the proper positions. The method of using the trammel is as follows:

1st. Set the grooved pieces of wood on the given diameters AB and CD of the ellipse (as in the figure); the centre, where the two pieces cross, being on the centre O of the ellipse.

2nd. Make the distance from the pencil at *a* to the first sliding guide at *b* equal to half the conjugate diameter, (or *ab* equal to OD or OC); and from the same point *a* to the second sliding guide at *c* equal to half the transverse diameter (or *ac* equal to OA or OB).

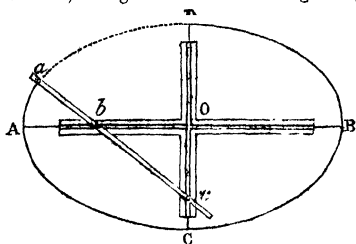

Fig. 67.

3rd. Move the end *a* round, commencing at the point D, allowing the guides to move freely in the grooves, and the pencil will be found to describe the ellipse required.

The OVAL although not an ellipse, so *nearly* resembles it, that very frequently, from the simplicity of drawing an *oval*, it is used in place of an *ellipse*, and is formed of parts of circles by the following methods:—

1ST METHOD.—Divide any line AB (Fig. 68) representing the transverse diameter into three equal parts in the points C and D. With the centres C and D and the equal radii CA and DB, describe two circles, at the points E and F, where they intersect, as centres, and the equal radii AD or BC, describe parts of other two circles joining the circumferences of the two first circles (the exact points of junction of the two circles may be got by joining the centres of both circles, as shown by the dotted lines), which will complete the oval required.

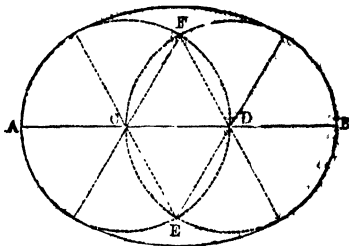

Fig. 68.

2ND METHOD.—It is often required to draw a *flat or long-shaped oval*, in which case divide the line AB (Fig. 69) into four equal parts in the points C, D, G, and with the centres C and G and radii equal to CA and GB, describe two circles; also with the same centres and radii equal to any two parts of the line AB, such as AD, describe arcs intersecting at E and F, with which, as centres and radii equal to three parts of AB, such as AG, describe portions of other two circles joining the circumferences of the first circles, which will complete the oval required.

3RD METHOD.—To draw an *egg-shaped oval*.

Bisect the diameter AB in the point D (Fig. 70), with which, as a centre, and DA or DB as a radius, describe a circle cutting the diameter EF in the point G: with the

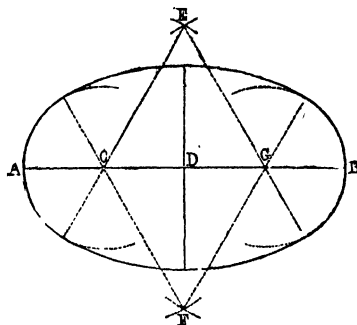

Fig. 69.

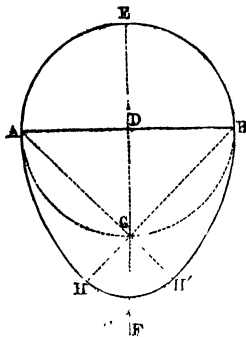

Fig. 70.

centres A and B and radii equal to AB describe two arcs, AH and BH'; join AG and BG, and produce them until they cut the arcs AH and BH' in the points H and H', and with the centre G and radius GH, describe a part of a circle touching the two latter drawn arcs, which will complete the oval.

THE PARABOLA.

(1). To show that $PN^2 = 4 AS, AN$.

Let Dd (Fig. 71) be the directrix, S the focus; draw DAN perpendicular to Dd through S ; this line is called the *axis* of the parabola. Draw PN perpendicular to DN , and Pd perpendicular to DN . Now $SP = Pd$. Hence if $AS = AD$, A is a point in the parabola, and is called its vertex.

Now $PS = Pd$ (by Def. 2) $= DN = DA + AN = AS + AN$.

$$\text{Also } PS^2 = PN^2 + SN^2 = PN^2 + (AN - AS)^2$$

$$\therefore (AS + AN)^2 = PN^2 + (AN - AS)^2.$$

$$\therefore PN^2 = 4 AS, AN.$$

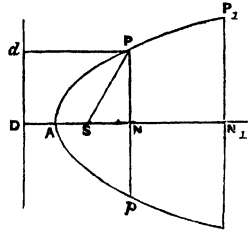

Fig. 71.

Cor. (1). Hence AS is a third proportional to AN , and the half of PN .

Cor. (2). Also if P_1 be any other point, and P_1N_1 is parallel to PN , we have

$$P_1N_1^2 : PN^2 :: 4 AS, AN_1 : 4 AS, AN :: AN_1 : AN.$$

(Compare p. 377).

N.B.—If P_1N_1 bounds the curve is sometimes called the *base*, and AN_1 the height of the curve. Also it is plain that if PN be produced, so that $pN = NP$, then $pN^2 = 4 AS, AN$, and therefore p is a point in the parabola; which is therefore *symmetrical* about AN_1 ; the line Pp is called a *double ordinate*.

(2.) If $ABCD$ (Fig. 72) be any rectangle, and if DC and CB are each divided into n equal parts, and let $Dp_1 = p$ of the equal parts into which CD is divided, and $Bp_2 = p$ of the parts into which CB is divided; join Ap_1 , meeting p_2q (parallel to AB) in P ; then P is a point in the parabola which has for its base CB and height BA .

For, draw PN perpendicular to AB , and p_1n_1 parallel to PN .

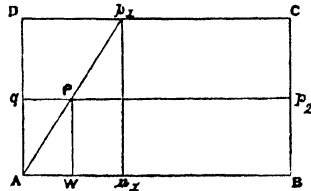

Fig. 72.

$$\text{Now, } Bp_2 = \frac{p}{n} \cdot CB, \quad An_1 = \frac{p}{n} \cdot AB \text{ and } PN = Bp_2.$$

$$\text{Also, } \frac{PN}{AN} = \frac{p_1n_1}{An_1} = \frac{CB}{AB} \cdot \frac{p}{p}$$

$$\text{And } PN = \frac{p}{n} \cdot CB.$$

$$\therefore \frac{PN^2}{AN^2} = \frac{CB^2}{AB^2}$$

$$\therefore PN^2 : CB^2 :: AN : AB.$$

$\therefore P$ is a point in the specified parabola by corollary to last article. The second of

the following practical methods is founded on the above principles. The first and third depend entirely on the definition of the parabola.

To describe a parabola, any absciss of the axis and the corresponding ordinate being given; or, the half width of the base (AD or DB), and the height of the curve (CD) being given.

1ST METHOD.—Bisect DB (Fig. 73) in the point E; join CE, and from E draw EF perpendicular to CE, and meeting CD produced in F; make CO in DC produced and CF each equal to DF, F will be the focus of the required parabola. Take any number of points, 1, 2, 3, 4 (&c.), in CD; through them draw double ordinates, or lines perpendicular to the axis CD; then with the centre F, and radii OF, O1, O2, O3, O4 (O &c.), describe arcs cutting the ordinates; the curve drawn through the points of intersection will be the parabola required.

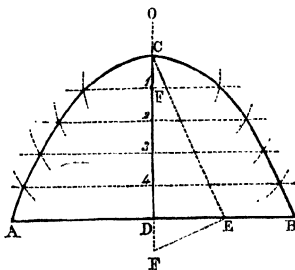

Fig. 73.

2ND METHOD.—AB (Fig. 74) being the width at the base, and CD the height of the curve, as before, construct the parallelogram ABEC, divide DA, DB and AF, BE respectively into the same number of equal parts in the points 1, 2, 3, 4; from the points of division in AF and BE draw lines to the point C, and from the points of division in DA and DB draw lines perpendicular to AB, or parallel to CD, cutting the former lines; then the curve drawn through the points of intersection will be the parabola required.

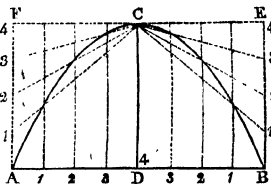

Fig. 74.

3RD METHOD.—Place a ruler GH (Fig. 75) at any convenient distance from C, parallel to the base AB, and take a piece of wood (called a square or set square), made in the form of a right-angled triangle IOK, placing the base IO against the ruler, and the other edge OK to coincide with the line CD; having found the focus F (as in the 1st method), fasten one end of a string at F, place a pencil at the point C, passing the string round it, and bringing the string back to K, fasten it to the end or point of the triangle; move the triangle or square along the ruler, keeping the pencil always against the edge of the square (as at E), and with the string stretched the pencil will describe one-half of the curve. By reversing the square and proceeding in a similar manner, the other half may be drawn, and the parabola required completed.

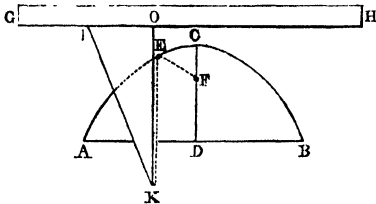

Fig. 75.

THE HYPERBOLA.

If the reasoning employed in the case of the ellipse be carefully gone over, attending only to the difference that will result from the circumstance that $e > 1$, the student will readily deduce the following expressions will be found to hold good of the hyperbola, which are entirely analogous to the corresponding expressions in the case of the ellipse.

- (1.) $SC = e AC.$
- (2.) BC must be so taken that $BC^2 = CS^2 - CA^2 = (e^2 - 1) CA^2.$
- (3.) $SP = e. CN - AC.$
- (4.) $\frac{PN^2}{CB^2} - \frac{CN^2}{CA^2} = -1.$
- (5.) $HP = e.CN + AC.$
- (6.) $HP - SP = 2 AC.$

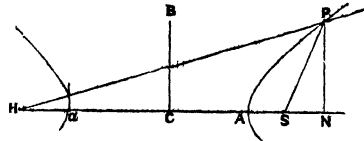

Fig. 76.

It is on this (6th) property that the following practical construction is founded.

The terms major axis, transverse axis, &c., in the hyperbola, are entirely analogous to the same terms in the ellipse.

To describe a hyperbola, the transverse (AB) and conjugate (CD) axes being given.

Through B (Fig. 77), at one end of the transverse axis AB, draw GH parallel to the conjugate axis CD, and make GH equal to CD; with the centre E and radius, equal to EH, describe a circle cutting AB, produced both ways, in the points F and f , which will be the foci of opposite hyperbolas; take any number of points, 1, 2, 3, 4 (&c.), in AB produced, and with the centres F and f , and radii B1, B2, B3, B4, (B &c.), and A1, A2, A3, A4 (A &c.), describe arcs cutting each other; the curve drawn through the points of intersection will be the hyperbola required.

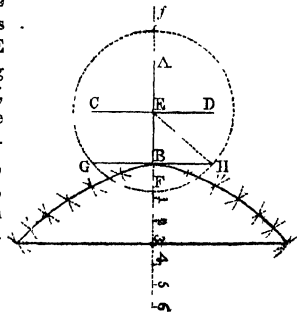

Fig. 77.

The following consideration materially simplifies the construction of a hyperbola.

Through A (Fig. 78) draw AD parallel and equal to BC, join CD and produce it indefinitely, take P any point in the curve, draw pPN, meeting CD produced in p. Then

$$\begin{aligned} \frac{DA}{CA} &= \frac{pN}{CN} \\ \therefore \frac{pN^2}{CB^2} - \frac{CN^2}{CA^2} &= 0. \\ \text{But } (\#)' \quad \frac{PN^2}{CB^2} - \frac{CN^2}{CA^2} &= -1. \\ \therefore \text{subtracting} \quad \frac{pN^2 - PN^2}{CB^2} &= 1 \end{aligned}$$

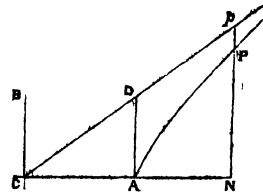

Fig. 78.

$$\therefore (pN - PN) (pN + PN) = CB^2$$

$$\therefore Pp = \frac{CB^2}{pN + PN}$$

Now it is plain that PN and pN increase as P is farther from A, or N from A, and therefore, the farther P is from the vertex the nearer it approaches CD produced. CD is called an asymptote—after a short distance the curve sensibly coincides with the asymptote. Hence, if in the practical construction above given EH be produced, it will serve as a guide to the curve, which can be drawn very accurately after a very few points have been determined by the construction.

THE CYCLOID.

Besides the conic sections, which we have briefly discussed above, there are several curves possessing curious or useful properties. Amongst the chief of these is the cycloid. The construction of this curve is sometimes useful to the artist. The following will suffice to explain the nature of the curve and the method of its construction.

The cycloid is a curve formed by a point in the circumference of a circle (called the generating circle), revolving on a straight or level line; it may be best described as the curve traced out by a point in the wheel of a carriage when in motion along a level road. When the generating circle revolves round another circle, the curve described by a point in the circle is then called an epicycloid, and is constructed in a similar manner to the cycloid.

To describe a cycloid, the diameter or width at the base (AB), and height (CD), of the curve being given.

The most common method of describing the cycloid is by placing a ruler along the line AB, and taking a circle, such as a shilling, &c., according to the size or height of the curve required, and having fixed a point in that circle, to move it slowly along the ruler, marking different points in the curve, or by keeping a pencil fixed at the point chosen, and thus describing the curve. This, however, is liable to error, as the circle used very often slips, and cannot then revolve accurately; by construction, however, the curve may be correctly formed thus:—

Let ACB (Fig. 79) represent the curve in question, AB its base, CD its height.

Bisect CD in O, and through O draw EF parallel to AB; with centre O and radius OC describe a circle, and divide the circumference into any number of equal parts, as $Cp_1, p_1 p_2, \dots$ join Dp_1, Dp_2, \dots Again, divide AD into the same number of equal parts, DN_1, DN_2, \dots and draw O_1N_1, O_2N_2, \dots parallel to CD; with centre O_2 and radius CD describe a circle, and

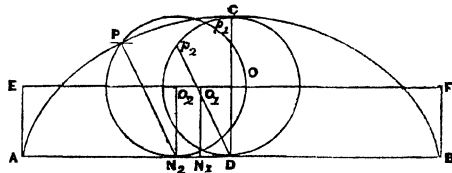

Fig. 79.

with centre N_2 and radius Dp_2 describe an arc cutting the circle in the point P_2 . This is a point in the curve, similarly with the centre O_1 and radius CD . Another circle may be described and intersected by the arc of a circle described with centre N_1 and radius Dp_1 , and thus another point be determined; and so on for any number of points, which being joined carefully will give the curve in question.

We thus conclude our Treatise upon Practical Geometry. It has been our endeavour to confine it in extent to that which it is absolutely necessary the scientific draughtsman should be familiar with; and in the foregoing pages will be found all that is required for practical purposes,—no really essential propositions being omitted.

ALEXANDER JARDINE.

I N D E X;

Glossarial, Explanatory, and Referential.

A

- Abbreviation, arithmetical marks and signs used for, 48.
- Addition, Simple, on the use and application of, 7.
- of Compound quantities, 21; of Fractions, 29.
- of Algebra, sign of, 162; illustrations of, 166; exercises in, 167, 168.
- of Fractions in Algebra, 198; exercises in, 199.
- ALGEBRA** (Arabic *al* the, and *gabron* reduction of fractions), general principles of, 161 et seq., signs of, 161; the study of, requires a previous knowledge of arithmetic, 161; definitions and explanations of, 162; exercises in, 164; operations in, 165.
- Addition of, with examples for exercise, 166 et passim.
- Subtraction of, 168.
- Simple Equations, 172 et seq.
- Transposition, 173; Clearing Fractions, *ib.*; questions for solution and exercise, 174, 175, 177.
- Multiplication of, 179; Involution, 183.
- Division of 187; Exponents, Roots, and Surds, 191; Evolution, or Extraction of Roots, 193; exercises in, 195.
- FRACTIONS, 196; exercises in, 197; Addition and Subtraction of Fractions, 198; exercises in, 199; Multiplication of Fractions, 199; Division of Fractions, 200; exercises in, 201.
- Solutions of Simple Equations, 201, 204, 206, 213; exercises in, 203, 206; Quadratic Equations, 209, 210, 213, 214; exercises in, 212, 215.
- Homogeneous and Symmetrical Quadratics, 217.
- Ratio and Proportion, 218.
- Arithmetical Progression, 220.
- Geometrical Progression, 222; exercises in, 225.
- Algebra, Proportion and Progression, 225.**
- Extraction of Roots,—of the Square Root of a Polynomial, 228; exercises in, 231, 234; of the Square Root of a Binomial, 232; of the cube root of a compound quantity, 235; exercises, 235 et seq.
- arithmetical and symbolical, 261, 262.
- “Ambiguities” arising from the use of formulas, 311.
- Angle, circular measure of an, 293; definition of, 298.
- Angles, ratios of, 295 et seq.; functions of, 301; of a corresponding character, 303; sines and cosines of, 315; the trigonometrical ratios of, 316; to obtain the cosines of, 351; methods of correcting, 417, 419.
- formulas for determining the relations, 304 et seq.
- sines and cosines of, 310, 311; logarithmic sines of, 357, 358; Delambre's method for solving, 360.
- spherical triangle, sines of the, 402.
- Apothecaries' weight (Gr. *apotheca* a repository), 18.
- Areas, on the mensuration of, 371.
- to find the area of a rectangle, 371; of a triangle, 372; of a parallelogram, 372; of a trapezoid, 372; of a trapezium, 373; of a polygon, 373; of an ellipse, 376; of a parabola, 377; of a plane figure bounded by a curve, 378; of a right prism, 380; of a right cylinder, 380; of the curved surface of a right cone, 381; of the frustum of a cone, 381; of a portion of the surface of a sphere, 382.
- ARITHMETIC** (Gr. *arithmos* number), introductory to geometry, 2; uses and objects of, 3, 4; the ten figures, 4; numeration table, and the reading of numbers, 5; decimal system of, 6; local value of figures, 6.
- Simple Addition, 7; Subtraction, 8; Multiplication, 10; and Division, 13.
- Tables of Money, Time, Weight, and Measures, 18.

Arithmetic, the Rule of Reduction, 19.
 — Compound Quantities,—Addition, 21 ;
 Subtraction, 22 ; Multiplication, 23 ; and Di-
 vision, 25.
 — FRACTIONS, 26 ; Addition and Subtrac-
 tion of, 29 ; Multiplication and Division of,
 30 ; Proportion, 31 ; Rule of Three, 33.
 — DECIMALS, 36 ; Addition and Subtrac-
 tion of, 37 ; Multiplication and Division of,
 38 ; Extraction of the Square Root, 38.
 — general principles of, 40 ; table of fac-
 tors, 41 ; symbols and signs of, introductory
 to Algebra, 161, 261. See ALGEBRA.
 Arithmetical Algebra, 261, 262.
 Arithmetical values of quantities, 276.
 Arithmetical progression in Algebra, 230.
 Avoirdupois weight (Fr. *avoir* to have, *du pois*
 some weight), 16.
 Axioms (Gr. *axioma* authority) of Euclid, 47.

B

Base line, its measurement in surveying, 415,
 416.
 Binomial (Lat. *bis* twice, and *nomen* a name),
 powers of a, 184 ; how to extract the square
 root of a, 232 ; multiplies which render bino-
 mial surds rational, 234.
 Binomial theorem, how to state the, 260 ; how
 to prove it, 266, 269.

C

Calculable logarithm, every number has a, 279.
 Calculations facilitated by logarithms, 276.
 Cask, to find the volume of a, 398.
 Circle, to find the radius of a, 327 ; to find the
 area of a quadrilateral inscribed in a, 328.
 — Quadrature of the, difficulty of solving
 the problem, 126.
 Circular measure of an angle, 293.
 Cloth, measures of, 18.
 Coefficient (Lat. *co* with, and *efficio* to work out),
 the multiplier in algebra so-called, 163 ; illus-
 trated, 164.
 Coins, gold and silver, 18.
 Compasses used in geometry, 421.
 Composite numbers (Lat. *compositus* compounded
 sited), factors of the, 41.
 Compound Quantities,—Addition of, 21 ; Sub-
 traction of, 22 ; Multiplication of, 23 ; Division
 of, 25.
 Compound quantity, cube root of a, 285.
 Cone (Gr. *konos*, a top or pine-apple), to find the
 volume of the frustum of a, 396.
 Conic Sections, on the construction of, 438 ; the
 ellipse, 439 ; the parabola, 444 ; the hyperbola,
 446.

Convergent series, meaning of a, 264.
 Cosines of angles (Lat. *sinuo* to diverge), nume-
 rical value of, 315 ; to obtain the, 351.
 Cotangents (Lat. *co* with, *tangens* touching),
 calculation of, 352.
 Cube root (Gr. *kubos* a six-sided die), of a com-
 pound quantity, 235.
 — of decimals, exercises for finding the,
 235.
 Cycloid (Gr. *kyklos* a circle), construction of
 the, 447.

D

DECIMALS (Lat. *decim* ten), beautiful contri-
 vance of, 6 ; principles and practice of, 86 ; re-
 ductions of fractions to, 37.
 — Addition and Subtraction of, 37 ; Mul-
 tiplication of, 38 ; Division of, 38.
 — exercises for finding the cube root of,
 238.
 Definitions of Euclid, 43, 85, 96, 116 ; of the prin-
 ciples of Algebra, 162, 103 ; of plane trigono-
 metry, 292, 291, 298, 299 ; of geometrical
 planes, 242 ; of spherical geometry, 252.
 Delambre's method of solving logarithmic sines
 of small angles, 360.
 Denominator of fractions, 197.
 Distances, the measurement of, 367.
 Divergent Series, meaning of a, 264.
 Dividend, the quantity so called, 187 ; when a
 compound quantity, 189 ; exercises in the
 working, 191.
 Division, Simple, on the use and application of,
 13 ; various problems in, 14-17.
 — of compound quantities, 25 ; of Fra-
 ctions, 30 ; of Decimals, 38.
 — of Algebra, the sign of, 163 ; the Divi-
 dend, the Divisor, and the Quotient, 187 ;
 operations in, 189.
 — of Fractions in Algebra, 200 ; exercises
 in, 201.
 Divisor, the quantity so called, 187 ; when a
 compound quantity, 189.
 Double Rule of Three, principles and practice of,
 34.
 Drawing-pens used in geometry, 421.
 Dry Goods, measures for, 19.

E

Ellipse (Gr. *elleipsis* deficiency), definition and
 illustration of the, 439.
 Equality, algebraic sign of, 163.
 Equation (Lat. *aequo* to equal), to find the roots
 of the, 340.

EQUATIONS, arithmetical and algebraical, 172 et seq.; on the solution of, 172; different modes of operating, 173; transposition, and clearing fractions, *ib.*; how to solve a simple equation containing only one unknown quantity, 174; questions for solution and exercises, 175—179; rules and operations for their solution with unknown quantities, 201, 202, 204, 206, 208; exercises in, 209, 210.

— Quadratic, solutions of, with unknown quantities, 209, 210, 213, 214; exercises in, 212.

Equivalent Forms, the permanence of, 261.

EUCLID, elements of, and definitions, 43; his postulates, 47; his marks of abbreviation, 48.

— Propositions of Book I., 48—67; comments on, 68—85; exercises on, 85.

— Definitions and Propositions of Book II., 86—92; remarks on, 93; exercises on Books I. and II., 95.

— ——— of Book III., 96—112; remarks on, 112; exercises on Books I., II., III., 115.

— ——— of Book IV., 116—124; remarks on, 124; exercises on the Four Books of, 128.

— his Plane Geometry, 241; his propositions on planes, Book XI., 243—250.

— his Spherical Geometry, 251; definitions and propositions, 252—260.

— Problems in practical geometry, 423—447.

EVOLUTIONS (Lat. *evolutio* the process of evolving), in algebra, 193; exercises, 195.

EXERCISES in the problems and theorems of Euclid, Book I., 85; Books I. and II., 95; Books I., II., and III., 115; on the four first Books, 128.

— in the rules of ALGEBRA, 164 et seq.; in addition of algebra, 163; in subtraction, 170; in equations, 175, 177, 203, 206; in multiplication of algebra, 180; in involution, 187; in division, 189; in extraction of roots, 193; in fractions, 196; in addition and subtraction of fractions, 198, 199; in multiplication of fractions, 199, 200; in division of fractions, 200, 201; in the solution of simple equations, 201, 203, 206; in quadratic equations, 212; in arithmetical and geometrical progressions, 222, 225; in extracting the square root of a polynomial, 231; of a binomial, 234, 235; in the cube root of decimals, 238.

Exponentials, to obtain sines, &c., in terms of, 336.

Exponents in algebra (Lat. *expono* to set forth), illustrations of, 191.

Expression, meaning of the term in algebra, 163.

Extraction of roots, 193; rules for, 194; exercises in, 195.

F

Factor (Lat. *factor* a working agent), meaning of the term, 165.

Factors, operations of, when they are simple quantities, 179; to express sin. x , in a series of, 344.

— of the Composite numbers, table of the, 41.

Figures of arithmetic, 4; local value of, 5, 6; use of in arithmetic and algebra, 161.

Formulas (Lat. *formula* a rule or maxim), for determining the relations of different angles, 304 et seq.; relations between the four fundamental ones, 308; various formulas and expressions, 309; "ambiguities" arising from the use of, 311; for demonstrating trigonometrical problems, 323; adapted for logarithmic calculation, 325.

— Fundamental, of spherical trigonometry, 403 et seq.

FRACTIONS (Lat. *fractio* a breaking into parts), principles and practice of, 26; addition and subtraction of, 29; multiplication and division of, 30; reduction of to Decimals, 37.

— in Algebra, operations of, 196; exercises in, 196; how to reduce them to a common denominator, 179.

— ——— Addition and Subtraction of, 198.

— ——— Multiplication of, 199; exercises in, 200.

— ——— Division of, 200; exercises in, 201.

FRUSTUM (Lat. *frustum* a fragment) of a right prism, to determine the volume of, 389.

G

Geodetical operations (Gr. *ge* land, and *daio* to divide), on the formulas peculiar to, 414 et seq. Geometrical progression in algebra, 222.

GEOMETRY (Gr. *ge* and *metron* land-measuring), arithmetical introductory to, 2; illustrations of, in the four first Books of Euclid, 43—128 (see EUCLID); general disquisition on, 68 et seq.; to be combined with algebra, 161.

— Plane, introduction to, 241; definitions of, 242; propositions in, 243—250.

— Spherical, introduction to, 251; definitions of, 252; propositions for solution, 253—260.

— Practical, general treatise on, 421 et seq.; the instruments in general use, 421; solutions of various problems, 423—447; construction of conic sections, 438; the ellipse, 439; the parabola, 444; the hyperbola, 446; the cycloid, 447.

H.

- Heights, the measurement of, 367.
 Homogeneous Quadratics (Gr. *homos* the same, and *genes* birth; Lat. *quadra* a square), definition and illustration of, 216.
 Hyperbola (Gr. *hyper* over, and *ballo* to throw), definition of the, 439; illustrations of the, 446.

Impossible Expressions, 262.

- Indices (Lat. *indico* to indicate), theory of, 262.
 Infinite series, arithmetical values of, 275.
 Instruments used in geometry — compasses, ruler, pencil, 421; drawing pen, 422.
 Involution (Lat. *involutio* the process of involving), of simple quantities, 183; exercises in, 184, 187; the powers of a binomial, 184.

L.

- Letters, use of in algebra, 161.
 Lines and ratios, trigonometrical, 294, 297.
 Liquids, measures for, 19.
 LOGARITHMS (Gr. *logos* and *arithmos* a discourse on numbers), treatise on, 261 et seq.; on the calculations of, 275; principle on which they may be used to facilitate calculations, 276; every number has a calculable logarithm, 279; numerical values of may be calculated, 279, 281; methods of finding any power of a number, 289.

M

- MATHEMATICS (Gr. *mathema* learning), introductory remarks on, 1 et seq.; different subjects connected with, 3; on the study of, as a science, 3; the general elements, problems, and axioms of, 43 et seq. passim. (See EUCLID, GEOMETRY, ALGEBRA, &c.)
 Measures, tables of, 18, 19.
 MENSURATION (Lat. *mensuro* to measure), treatise on, 367 et seq.; heights and distances, 367—370; the measure of arcs, 371—382; the measure of solids, 383—400
 Military Earthwork, to find the solid content of a, 394.
 Moivre's trigonometrical theorem, 332.
 Money, tables of, 18.
 Monomial quantity (Gr. *monos* one, and Lat. *nomen* a name), how to extract a proposed root of a, 194; exercises, 195.
 Multiplication, Simple, use and application of, 10; table of, ib.; various workings in, 11, 12.
 ——— of Compound Quantities, 23; of Fractions, 30; of Decimals, 38.

- Multiplication of Algebra, the sign of, 162, 163; the rule of, 179; when the factors are simple quantities, ib.; exercises in, 180, 183.
 ——— of Fractions in Algebra, 199; exercises in, 200.
 Multiplier, algebraically called the co-efficient, 163; in algebra a factor, 165.
 Multipliers, which render binomial surds rational, 234.

N

- Napier's analogies, 407.
 Negative and positive values in algebra, 215.
 Negative Angles, 299.
 Negative sign, use of, to denote position, 298.
 Number, methods of finding any power of a, 286 et seq.; use of a table of, 283, 284; method of finding the characteristic, 285.
 Numbers, reading of, 5.
 Numeration table (Lat. *numero* to number), 5.
 Numerator of fractions, 197.
 Numerical solution of right-angled triangles, 361 et seq.
 Numerical value of logarithms, 281; of sines and cosines of angles, 315.

P

- Parabola, definition of the, 432; illustrations of the, 444.
 Parallelepipeds, equality of, 385, 386.
 Pence table, 18.
 Pencils used in geometry, 421.
 Pens used in geometry, 422.
 Plane geometry and trigonometry, introduction to, 241 et seq.
 Plane trigonometry, treatise on, 292 et seq. (See TRIGONOMETRY).
 Planes, definitions of, 242; propositions in, 243—250.
 Polygon, to find the area of a, 329.
 Polynomial (Gr. *polus* many; Lat. *nomin* names), how to extract the square root of a, 228.
 Positive values in algebra, 215.
 Postulates of Euclid, 47; problems illustrative of, 422.
 Prismoid, to find the value of a, 391.
 Prisms, various measurements of, 389—391.
 Problems (Gr. *problema* a proposition requiring solution) of Euclid, 48 et seq.; 423—447; (see PROPOSITIONS).
 Progression, Arithmetical, 220; exercises in, 222; Geometrical, 222.
 Proportion in algebra, 218.
 Proportion and Progression, questions in which they are concerned, 225.
 Proportional Parts, use of a table of, 283.

Proportion, rule of, 30.
 Propositions of Euclid, 48—67; 87—92; 97—112; 117—124; 423—447.
 ——— in Plane Geometry, 243—250.
 ——— in Spherical Geometry, 253—260.
 ——— in Plane Trigonometry, 299, 305—307.
 Pyramids, mensuration of, 389.

Q

Quadratic Equations (Lat. *quadratus* fourfold), solutions of with unknown quantities, 209, 210, 213, 214; exercises in, 212.
 Quadratics, homogeneous and symmetrical, 216, 117.
 Quadrature of the Circle (Lat. *quadratura* the squaring of anything), problem of the, 126, 127.
 Quadrilateral (Lat. *quadratus* fourfold, and *latera* sides), to find its area inscribed in a circle, 328.
 Quantities, Simple, operation of the factors in, 179; in calculating the arithmetical values of, 275.
 ——— in Algebra, simple and compound, 163; illustrations of, 164.
 ——— Unknown, solution of simple equations with, 201, 204, 206, 208, 213; with quadratic equations, 209, 213, 214.
 Quantity, marks and symbols of, 161, 162.
 ——— Mixed, reduction of to an improper fraction, 196.
 Quotient (Lat. *quoties* so many times), the quantity so called, 187.

R

Radius of an inscribed circle, to find the, 327.
 Railway Cutting, to find the solid content of a, 300.
 Ratio and Proportion, in algebra, 218.
 Ratios of Angles, 295, 297, 299, 300.
 ——— Inverse Trigonometrical, explained, 318.
 Reduction, rule of, 19; its rise and application, 19—21.
 Roots in algebra, 191; extraction of, 193; rules for, 194; exercises in, 195.
 Rule of Three, principles and practice of, 33.
 ——— Double, illustrations of, 34.
 Rulers used in geometry, 421.

S

Science (Lat. *scientia* the knowledge of things), on the study of, 3.

Series, treatise on, 261 et seq.; what is meant by a Convergent and Divergent Series, 264. (See LOGARITHMS).
 Series and Tables of Trigonometry, 330 et seq.
 Signs of operation in Algebra, 161, 162, 163; practical illustrations of, 164.
 Sines of Angles, numerical value of, 315; how to calculate the value of, 349, 350.
 ——— Logarithmic, tables of, 355.
 ——— Natural, tables of, 353.
 Solids, mensuration of, 19, 383, 393 et seq.
 Sphere, to find the volume of the portion of a, 396.
 Spherical Geometry, 251 et seq. (See GEOMETRY).
 Spherical triangles, sines of the angles proportional, 402; solution of the, 408; Napier's rule for solving, 409.
 Spherical Trigonometry. (See TRIGONOMETRY).
 Spheroid, to find the volume of a portion of a, 398.
 Square Root, extraction of the, 38, 59.
 ——— of a polynomial, 228.
 ——— various algebraic exercises for extracting the, 231.
 ——— of a binomial, 232.
 Squaring the Circle, problem of the, 126.
 Subtraction, Simple, use and application of, 8; various workings in, 9.
 ——— of Compound Quantities, 22; of Fractions, 29; of Decimals, 37.
 ——— of Algebra, sign of, 162; illustrations of, 169; exercises in, 170.
 ——— of Fractions in Algebra, 198; exercises in, 199.
 Surds in Algebra (Lat. *surdus* undistinguishable), illustrations of, 191.
 Surface, measurement of, 19.
 Surveying a Country, operations of, 414, 116 et seq.
 Symbolical Algebra, 261.
 Symbols of Quantity in algebra, 162.
 Symmetrical Quadratics, 217.

T

Tangents, the calculation of, 332.
 Tables of money, time, weights, and measures, 18.
 Term, meaning of the word in algebra, 163.
 Theorems of Euclid (Gr. *theoremata* a proposition requiring demonstration), 49 et seq. (See PROPOSITIONS.)
 Time, tables of, 18.
 Tower, how to determine the height of a, 367 368.
 Triangles, relations between the sides and the angles, 322; methods of treating, 418, 419.

Triangles, Right-angled, numerical solution of, 361 et seq.; spherical solution of, 408, 409.
 ——— Oblique-angled, solution of, 411.

TRIGONOMETRY, PLANE, treatise on, 292 et seq.

- Science of defined, 292.
- Lines and Ratios of, 295 et seq.; ratios of angles, 297—302, 316.
- method of proving different formulas, 305; principles of proof, 307; the fundamental formulas of, 308; various formulas and expressions, 309; "ambiguities" arising from their use, 311.
- value of the sines, &c., of angles, 315.
- formulas connecting inverse ratios, 319.
- subsidiary angles, 320.
- sides and angles of triangles, 322.
- deduced and derived formulas, 323.
- tables of sines, &c., 353—360.

Trigonometry, various propositions, 327—329; series and tables of, 330—350; methods of checking the calculations, 361.

——— numerical solution of right-angled triangles, 361—366.

——— SPHERICAL, treatise on, 401 et seq.; fundamental formulas, 408; Napier's analogies, 407.

——— Right-angled spherical triangles, 408; oblique-angled triangles, 411.

——— geodetical operations, 414—420.

V

Verification, formulas of, 352.

W

Weights, tables of, 18.

SOLUTIONS

TO THE

EXERCISES IN THE TREATISE ON ALGEBRA.

AT page 164 of the ALGEBRA, a promise was given to furnish the ANSWERS to all the Examples proposed for exercise in that subject. The promise will be redeemed—and more than redeemed—in the present PART.

Considering for whom that elementary treatise was expressly written—for persons not merely unacquainted with the very alphabet of Algebraical Science, but also precluded from the advantages of academical instruction,—I have thought that I should render them more acceptable service by supplying sketches of the solutions themselves, rather than a mere register of the *results*. You will therefore regard what follows as furnishing a KEY to the unworked examples; showing briefly—but, I hope, clearly—the processes by which the answers are to be obtained.

In Addition and Subtraction, however, all that can here be done is to put down the results; for the result of an addition or subtraction example exhibits, in itself, the whole work.

EXERCISES. PAGE 164.

1. $3a + 4c = 3.4 + 4.3 = 12 + 12 = 24.$
2. $5c - 2a = 5.3 - 2.4 = 15 - 8 = 7.$
3. $13n + b = 13.1 + 2 = 13 + 2 = 15.$
4. $21m - 9d = 21.8 - 9.5 = 168 - 45 = 123.$
5. $7d + 4n - 2a = 7.5 + 4 - 2.4 = 35 + 4 - 8 = 31.$
6. $3a + 4b - 5c = 3.4 + 4.2 - 5.3 = 12 + 8 - 15 = 5.$
7. $6m - 5n - 3b = 6.8 - 5 - 3.2 = 48 - 5 - 6 = 37.$
8. $14 - 3c + m = 14 - 3.3 + 8 = 14 - 9 + 8 = 13.$
9. $11b + n - 13 = 11.2 + 1 - 13 = 10.$
10. $-4d + 5m - 2n = -4.5 + 5.8 - 2 = 18.$
11. $\frac{3m}{4} + 6 - \frac{m}{2} = \frac{3.8}{4} + 6 - \frac{8}{2} = 6 + 6 - 4 = 8.$
12. $\frac{5a}{2} + \frac{4d}{5} - 2c = \frac{5.4}{2} + \frac{4.5}{5} - 2.3 = 10 + 4 - 6 = 8.$
13. $\frac{2a + 3b}{7} + m - n = \frac{2.4 + 3.2}{7} + 8 - 1 = 2 + 8 - 1 = 9.$
14. $\frac{3a - 4b + 6c - 2}{10} = \frac{3.4 - 4.2 + 6.3 - 2}{10} = \frac{20}{10} = 2.$
15. $3ab + dm - 5b + 6cn - 18 = 3.4.2 + 5.8 - 5.2 + 6.3 - 18 = 54.$
16. $2abm - 3cdm + \frac{3dm}{8} + ad = 2.4.2.8 - 3.3.5.8 + \frac{3.5.8}{8} + 4.5 = -197.$
17. $\frac{5am - 2bc + n - 49}{140} - n = \frac{5.4.8 - 2.2.3 + 1 - 49}{140} - 1 = -\frac{1}{7}.$

ALGEBRAIC SOLUTIONS.

$$18. \frac{24}{m} + \frac{5abc}{24} - \frac{60}{bcd} - \frac{m+n}{2b+d} = \frac{24}{8} + \frac{5.4.2.3}{24} - \frac{60}{2.3.5} - \frac{8+1}{2.2+5} = 5.$$

Page 166. Ex. 1. $2xy - 4xy + 13xy + 3xy = 14xy.$

2. $-ax - 7ax + 11ax + ax = 4ax.$

3. $9mnx + 5mnx - 13mnx = mnx.$

4. $6\frac{a}{b} + 2\frac{a}{b} - 5\frac{a}{b} - 2\frac{a}{b} + \frac{a}{b} = 2\frac{a}{b}.$

ADDITION. CASE I. PAGE 166.

- | | | | | |
|---------------------------|----------------------------|------------------------|-------------|----------------|
| 1. $26b.$ | 2. $24ax.$ | 3. $7by.$ | 4. $-5axy.$ | 5. $16a - 6x.$ |
| 6. $9ax - 5bx.$ | 7. $5pqr - 2mx - 3n.$ | 8. $2xyz + 5ab - 3.$ | | |
| 9. $9abz - 22x + 8a - 1.$ | 10. $15acx - 17bey + 4kg.$ | | | |
| 11. $15x + 18abc - 8mp.$ | 12. $19ky - 4mz - 3abc.$ | | | |
| 13. $10abz + cxy + 5mx.$ | 14. $6gx + 13pqr + 13.$ | | | |
| 15. $5axy + 4ab + 2c.$ | 16. $11xyz + 9am - 10bn.$ | 17. $8bcx - ny + 2mz.$ | | |
| 18. $19exz + 15bcy - 11.$ | 19. $ax.$ | 20. $6qgx - 3.$ | | |

- Page 168. Case II.
- | | |
|---|--|
| 1. $6by + 3ex + 14c + 12.$ | 2. $8xy + 2ax + c - 15.$ |
| 3. $6yz + 9ax - 7bc + xyz + en.$ | 4. $ab - cd + 8ef - 10e + 14.$ |
| 5. $7xy - 15bz + 10w - 3cd - 16.$ | 6. $4amz - 13nx - 8bv + 6cw - 8.$ |
| 7. $-axy + 10bz - 3c + 5.$ | 8. $-10abc + 2de + f + 8.$ |
| 9. $-\frac{1}{2}z + 11\frac{1}{2}y - 4x + 9.$ | 10. $\frac{x}{y} - 2ax + 2\frac{z}{x} - 6b + 4.$ |
| 11. $-5xyz - 5\frac{z}{a} + 10bc - 4mn + p.$ | 12. $4\frac{1}{2}ax - \frac{1}{2}y - 8.$ |

SUBTRACTION. PAGE 170.

- | | | |
|------------------------------------|---|-----------------------------|
| 1. $3x - 10y + 8z.$ | 2. $-ax + 6by - 11cz.$ | 3. $xy - 15ax + 11.$ |
| 4. $-5ay - 5bx + 6.$ | 5. $20abc + 10de - 6fg - 5.$ | 6. $6bz - 5ax - m - en.$ |
| 7. $5 - 11 + 11 - 6 - 3 = -4.$ | 8. $dy - 24fx - 3m - 8n + 4.$ | |
| 9. $-11ayz - 17bx + 4c + 4d - 2e.$ | 10. $12cex - 8aby + 4dx + 3z + 11.$ | |
| 11. $8ax - 5by + 5cz.$ | 12. $4bx - 6cy - 4ax.$ | 13. $3ay + 8bx - 3cz - 16.$ |
| 14. $5x - 8y + 8z - 4.$ | 15. $-4\frac{1}{2}axy + 3bz + 4m - 2n.$ | |
| 16. $2\frac{1}{2}yz - 2ax - 3.$ | | |

SIMPLE EQUATIONS. EXAMPLES FOR EXERCISE. PAGE 175.

- | | |
|------------------------|--|
| 1. $2x - 7 = x + 4.$ | Transposing, $2x - x = 4 + 7$, that is, $x = 11.$ |
| 2. $5x - 3 = 3x + 5.$ | Transposing, $5x - 3x = 5 + 3$, $\therefore 2x = 8 \therefore x = 4.$ |
| 3. $6x + 2 = 4x + 8.$ | Transposing, $6x - 4x = 8 - 2$, $\therefore 2x = 6 \therefore x = 3.$ |
| 4. $3x - 1 = x + 7.$ | Transposing, $3x - x = 7 + 1$, $\therefore 2x = 8 \therefore x = 4.$ |
| 5. $8x - 13 = 4x - 1.$ | Transposing, $8x - 4x = 13 - 1$, $\therefore 4x = 12 \therefore x = 3.$ |

ALGEBRAIC SOLUTIONS.

6. $2(x + 3) = 20$, that is, $2x + 6 = 20$. Transposing, $2x = 20 - 6 = 14$,
 $\therefore x = 7$.

7. $3(x - 4) = 6$, that is, $3x - 12 = 6$. Transposing, $3x = 18$, $\therefore x = 6$.

8. $4(x - 1) = x + 5$, that is, $4x - 4 = x + 5$. Transposing, $3x = 9$,
 $\therefore x = 3$.

9. $5(x + 2) = 2(x + 8)$, that is, $5x + 10 = 2x + 16$. Transposing, $3x = 6$,
 $\therefore x = 2$.

10. $3(2x - 3) = 4(x - 2)$, that is, $6x - 9 = 4x - 8$. Transposing, $2x = 1$,
 $\therefore x = \frac{1}{2}$.

11. $\frac{x}{3} + \frac{x}{4} = 7$. Multiplying by 3, to clear the first fraction,

$$x + \frac{3x}{4} = 21.$$

Multiplying by 4, $4x + 3x = 84$, $\therefore 7x = 84$, $\therefore x = \frac{84}{7} = 12$.

12. $\frac{x}{3} - \frac{x}{4} = 1$. Multiplying by 3, $x - \frac{3x}{4} = 3$.

Multiplying by 4, $4x - 3x = 12$, $\therefore x = 12$.

13. $\frac{2x}{3} - \frac{x}{4} = 5$. Multiplying by 3, $2x - \frac{3x}{4} = 15$.

Multiplying by 4, $8x - 3x = 60$, $\therefore 5x = 60$, $\therefore x = 12$.

14. $\frac{x}{2} + \frac{x}{3} = 31 - \frac{x}{5}$. Multiplying by 2,

$$x + \frac{2x}{3} = 62 - \frac{2x}{5}.$$

Multiplying by 3, $3x + 2x = 186 - \frac{6x}{5}$.

„ $5, 15x + 10x = 930 - 6x$, $\therefore 15x + 10x + 6x = 930$.

That is, $31x = 930$, $\therefore x = \frac{930}{31} = 30$.

15. $\frac{x}{3} + \frac{x}{4} + \frac{x}{6} = 1$. Multiplying by 3,

$$x + \frac{3x}{4} + \frac{3x}{6} = 3.$$

Multiplying by 4, $4x + 3x + 2x = 12$, $\therefore 9x = 12$, $\therefore x = \frac{12}{9} = 1\frac{1}{3}$.

16. $2x - (48 - x) = x + 12$, that is, $2x - 48 + x = x + 12$, or transposing,
 $2x = 12 + 48 = 60$, $\therefore x = 30$.

17. $\frac{5(3x + 2)}{2} = 35$. Multiplying by 2, and removing vinculum,

$$15x + 10 = 70, \therefore 15x = 60, \therefore x = 4.$$

18. $\frac{x+3}{5} - 1 = 2 - \frac{x}{7}$, or $\frac{x+3}{5} = 3 - \frac{x}{7}$. Multiplying by 5,

$$x + 3 = 15 - \frac{5x}{7}, \text{ or } x = 12 - \frac{5x}{7}.$$

Multiplying by 7, $7x = 84 - 5x$, $\therefore 12x = 84$, $\therefore x = 7$.

ALGEBRAIC SOLUTIONS.

19. $\frac{x}{2} + \frac{x}{3} - \frac{x}{5} - 1 = 0$. Multiplying by 2,

$$x + \frac{2x}{3} - \frac{2x}{5} - 2 = 0.$$

Multiplying by 3, $3x + 2x - \frac{6x}{5} - 6 = 0$, or $5x - \frac{6x}{5} = 6$.

„ by 5, $25x - 6x = 30$, $\therefore 19x = 30$, $\therefore x = \frac{30}{19} = 1\frac{11}{19}$.

20. $\frac{x}{2} + \frac{x}{3} - \frac{x}{4} - \frac{1}{2} = 0$. Multiplying by 2,

$$x + \frac{2x}{3} - \frac{x}{2} - 1 = 0.$$

Multiplying by 3, $3x + 2x - \frac{3x}{2} - 3 = 0$, or $5x - \frac{3x}{2} - 3 = 0$.

„ by 2, $10x - 3x - 6 = 0$, $\therefore 7x = 6$, $\therefore x = \frac{6}{7}$.

21. $11 - \frac{5x}{8} = \frac{x}{2} - \frac{2x}{3}$. Multiplying by 8,

$$88 - 5x = 4x - \frac{16x}{3}.$$

Multiplying by 3, $264 - 15x = 12x - 16x$, $\therefore 264 = 11x$, $\therefore x = \frac{264}{11} = 24$.

22. $4x - 2(3 - x) = \frac{x+3}{2}$, that is, $4x - 6 + 2x = \frac{x+3}{2}$, or $6x - 6 = \frac{x+3}{2}$.

Multiplying by 2, $12x - 12 = x + 3$, $\therefore 11x = 15$, $\therefore x = \frac{15}{11} = 1\frac{4}{11}$.

23. $6x - \frac{4-3x}{5} = \frac{29}{5}$. Multiplying by 5,

$$30x - 4 + 3x = 29, \therefore 33x = 33, \therefore x = 1.$$

24. $\frac{x-6}{2} + \frac{x}{3} = 20 - \frac{x-2}{2}$, that is, $\frac{x}{2} - 3 + \frac{x}{3} = 20 - \frac{x}{2} + 1$, or by trans-

posing, $x + \frac{x}{3} = 24$, \therefore mult. by 3, $3x + x = 72$, $\therefore 4x = 72$, $\therefore x = 18$.

25. $\frac{3x-13}{7} + \frac{11-4x}{3} = 0$. Multiplying by 7,

$$3x - 13 + \frac{77 - 28x}{3} = 0.$$

Multiplying by 3, $9x - 39 + 77 - 28x = 0$.

Transposing, $38 = 19x$, $\therefore x = 2$.

26. $6 - \frac{x-1}{2} - \frac{x-2}{3} = \frac{3-x}{4}$. Multiplying by 4, in order that both the first

and last fractions may be cleared at the same time, we have

$$24 - 2x + 2 - \frac{4x-8}{3} = 3 - x,$$

Multiplying by 3, $72 - 6x + 6 - 4x + 8 = 9 - 3x$.

Transposing, $72 + 6 + 8 - 9 = 6x + 4x - 3x$.

Collecting, $77 = 7x$, $\therefore x = 11$.

ALGEBRAIC SOLUTIONS.

QUESTIONS TO BE SOLVED BY SIMPLE EQUATIONS. PAGE 177.

1. There are two numbers of which the difference is 9, and the sum 43. What are the numbers?

Let x represent the smaller of the two numbers, then by the question, the other must be $x + 9$, and their sum

$$x + x + 9 = 43, \text{ that is, } 2x = 43 - 9, \therefore x = \frac{34}{2} = 17,$$

the smaller number, and $\therefore 17 + 9 = 26$, the larger number.

2. From two places, 108 miles apart, two persons, A and B, set out at the same time, to meet each other. A travels 17 miles a day, and B travels 18; in how many days will they meet?

Suppose they meet in x days: then by the question, the first, A, will have travelled $17x$ miles, and the second, B, $18x$ miles; and since the sum of these distances is the distance between the two places, we have the equation

$$17x + 18x = 108, \therefore 35x = 108, \therefore x = 3\frac{4}{5} \text{ days.}$$

3. Find two numbers of which the difference is 13, and which are such that if 17 be added to their sum, the whole will amount to 62.

Let x be the greater number; then, by the question, $x - 13$ is the less; also $x + x - 13 + 17 = 62$, $\therefore 2x = 62 + 13 - 17 = 58$, $\therefore x = 29$, the greater number, and $\therefore 29 - 13 = 16$, the less number.

4. There are two numbers of which the difference is 15, and which are such that if 7 times the less be subtracted from 5 times the greater, the difference will be 19: what are the numbers?

Let x be the greater number; then, by the question, $x - 15$ is the less; also

$$5x - (7x - 105) = 19, \text{ that is, } -2x + 105 = 19, \therefore -2x = -86,$$

$$\therefore x = \frac{-86}{-2} = 43, \text{ the greater number, and } \therefore 43 - 15 = 28, \text{ the less number.}$$

5. A person starts from a certain place, and travels at the rate of 4 miles an hour. After he has gone 10 hours, a horseman, riding 9 miles an hour, is despatched after him: how many hours must the horseman ride to overtake him?

Suppose the horseman overtakes him after riding x hours; then, by the question, the pedestrian will have walked $40 + 4x$ miles, and the horseman will have ridden $9x$ miles; and since the distance travelled by each is the same, we have the equation

$$9x = 40 + 4x, \therefore 5x = 40, \therefore x = 8;$$

hence the horseman has ridden 8 hours, so that each person must have travelled $9 \times 8 = 72$ miles.

6. A person has 264 coins,—sovereigns and florins; he has $4\frac{1}{2}$ times as many florins as sovereigns: how many of each coin has he?

Suppose he had x sovereigns; then, by the question, he must have had $4\frac{1}{2}x$ florins; so that

$$x + 4\frac{1}{2}x = 264, \text{ that is } 5\frac{1}{2}x = 264, \text{ or } 11x = 528, \therefore x = 48.$$

Consequently he had 48 sovereigns, and $\therefore 48 \times 4\frac{1}{2} = 216$ florins.

7. A person spends $\frac{1}{4}$ th of his yearly income in board and lodging, $\frac{1}{4}$ th in clothes and other expenses, and he lays by £85 a-year: what is his income?

ALGEBRAIC SOLUTIONS.

To avoid fractions, suppose $28x$ to be the number of pounds he receives yearly, 28 being chosen because it is divisible by both 4 and 7: then, by the question, he spends in board and lodging $7x$ pounds, and in clothes, &c., 4*x* pounds. Consequently, since he lays by £85, we have the equation

$$7x + 4x + 85 = 28x, \text{ that is, } 11x + 85 = 28x.$$

$$\text{Transposing, } 85 = 17x, \therefore x = 5, \therefore 28x = 140.$$

Hence his yearly income was £140.

8. What number is that whose third part exceeds its fifth part by 72?

To avoid fractions, let $15x$ represent the number; then, by the question,

$$5x - 3x = 72, \therefore 2x = 72, \therefore x = 36, \therefore \text{the number required is } 36 \times 15 = 540.$$

9. I have a certain number in my thoughts. I multiply it by 7, add 3 to the product, and divide the sum by 2. I then find that if I subtract 4 from the quotient I get 15: what number am I thinking of?

Let x represent the number; then, by the question,

$$\frac{7x + 3}{2} - 4 = 15, \text{ or } \frac{7x + 3}{2} = 19.$$

Multiplying by 2, $7x + 3 = 38$, $\therefore 7x = 35$, $\therefore x = 5$, the number thought of.

10. A man 40 years old has a son 9 years old: the father is therefore more than four times as old as his son. In how many years will the father be only twice as old as his son?

Suppose in x years: the father will then be $40 + x$ years old, and the son $9 + x$ years: by the question, the former number is to be double of the latter: hence the equation

$$40 + x = 18 + 2x, \therefore 40 - 18 = x = 22.$$

Therefore the father will be twice as old as his son in 22 years; in which time the father will be 62 and the son 31.

11. Two persons, A and B, 120 miles apart, set out at the same time to meet each other. A goes 3 miles an hour, and B 5 miles: what distance will each have travelled when they meet?

Suppose that A has travelled x hours, then B also must have travelled x hours. A must therefore have gone $3x$ miles, and B $5x$ miles; and since together they must have travelled 120 miles, we have the equation

$$3x + 5x = 120, \text{ that is, } 8x = 120, \therefore x = 15.$$

The time occupied by each is therefore 15 hours; so that A must have travelled $15 \times 3 = 45$ miles, and B $15 \times 5 = 75$ miles.

Otherwise.—Suppose A goes x miles, then B goes $120 - x$ miles: the time occupied by A, at 3 miles an hour, is therefore $\frac{x}{3}$ hours; and the time occupied by B, at 5 miles an hour, is $\frac{120 - x}{5}$ hours; but the times are equal. Hence the equation

$$\frac{x}{3} = \frac{120 - x}{5} = 24 - \frac{x}{5}.$$

Multiplying by 3, $x = 72 - \frac{3x}{5}$.

“ by 5, $5x = 360 - 3x$, $\therefore 8x = 360$, $\therefore x = 45$, A's distance.
 $\therefore 120 - 45 = 75$, B's distance.

ALGEBRAIC SOLUTIONS.

12. Divide £250 among A, B, and C, so that B may have £23 more than A, and C £105 more than B.

Let A's share be x pounds, then B's is $x + 23$; and C's $x + 23 + 105$; and the sum of the shares is 250: hence the equation

$$x + x + 23 + x + 23 + 105 = 250.$$

Collecting, and transposing, $3x = 99$, $\therefore x = 33$: hence the shares are as follow:—
A's share £33; B's £56; C's £161; and their sum is £250.

13. A can execute a piece of work in 3 days, which takes B 7 days to perform: in how many days can it be done if A and B work together?

Suppose they can do it in x days; then since A can do one-third of it in 1 day, he can do $\frac{x}{3}$ in x days: in like manner B can do $\frac{x}{7}$ of the whole in x days: hence, when working together, they do $\frac{x}{3} + \frac{x}{7}$ in x days; but these parts make up the whole work since they do it *all* in x days;

$$\therefore \frac{x}{3} + \frac{x}{7} = 1 \text{ whole}$$

Multiply by 3, $x + \frac{3x}{7} = 3$

„ by 7, $7x + 3x = 21$, $\therefore 10x = 21$, $\therefore x = 1\frac{1}{10}$

Hence they complete the work in one day and one-tenth.

14. A cistern can be filled by three pipes; by the first in 2 hours, by the second in 3, and by the third in 4; in what time can it be filled by all the pipes running together?

Suppose it can be filled in x hours; then since the first can supply one-half in 1 hour, it can supply $\frac{x}{2}$ in x hours; in like manner the second can supply $\frac{x}{3}$ in x hours, and the third $\frac{x}{4}$; and by the question the sum of these parts is the *whole*.

$$\therefore \frac{x}{2} + \frac{x}{3} + \frac{x}{4} = 1.$$

Multiplying by 4, in order that the first and third fractions may be removed at the same time, we have

$$2x + \frac{4x}{3} + x = 4, \text{ that is, } 3x + \frac{4x}{3} = 4.$$

Multiplying by 3, $9x + 4x = 12$, $\therefore 13x = 12$, $\therefore x = \frac{12}{13}$; hence, when they

all run together, the pipes will fill the cistern in $\frac{12}{13}$ h. = 55 min. $23\frac{1}{13}$ sec.

15. Solve the preceding question, when the first pipe fills the cistern in 1 hour 20 minutes; the second in 3 hours 20 minutes, and the third in 5 hours.

Imitating the foregoing solution, x being the required number of hours as before, the part of the whole supplied by the first pipe is $\frac{x}{1\frac{20}{60}}$, the part supplied by the second is $\frac{x}{3\frac{20}{60}}$, and the part supplied by the third is $\frac{x}{5}$, in x hours; hence, since these parts make up the whole, we have

$$\frac{x}{1\frac{20}{60}} + \frac{x}{3\frac{20}{60}} + \frac{x}{5} = 1.$$

ALGEBRAIC SOLUTIONS.

Or, multiplying the terms of the first pair of fractions by 3, $\frac{3x}{4} + \frac{3x}{10} + \frac{x}{5} = 1$.

$$\text{Multiplying by 4, } 3x + \frac{6x}{5} + \frac{4x}{5} = 4, \text{ or } 3x + 2x = 4,$$

$$\text{that is, } 5x = 4, \therefore x = \frac{4}{5},$$

hence, the time is $\frac{4}{5}$ h. = 48 minutes.

16. After A has been working 4 days at a job, which he can finish in 10 days, B is sent to help him; they finish it together in 2 days: in what time could B alone have done the whole?

Suppose B can finish it in x days; then he can do $\frac{1}{x}$ of it in 1 day, so that in the 2 days he does $\frac{2}{x}$ of it. Now, as A does $\frac{1}{10}$ of it in a day, in the 4 days, working alone, he has done $\frac{4}{10}$ or $\frac{2}{5}$ of it; hence, when B commences there is only $\frac{3}{5}$ of it to be done, so that $\frac{2}{x} + \frac{2}{5} = \frac{3}{5}$, or $\frac{2}{x} + \frac{1}{5} = \frac{3}{5}$, $\therefore \frac{2}{x} = \frac{2}{5}$, $\therefore \frac{1}{x} = \frac{1}{5}$.

Multiplying by x , and then by 5, we have $5 = x$; hence, B can finish the work alone in 5 days.

17. Divide £143 among A, B, and C, so that A may receive twice as much as B, and B three times as much as C.

Suppose C's share to be x pounds
 then B's " $3x$ "
 and A's " $6x$ "

$$\therefore \text{the sum of the shares is } 10x = 143, \therefore x = \frac{143}{10} = \text{£}14 \text{ } 6\text{s.}$$

\therefore C's share = £14 6s.; B's, £42 18s.; A's, £85 16s.; and the sum of these is the whole, £143.

18. A person has 40 quarts of superior wine worth 7s. a quart; he wishes, however, so to reduce its quality as that he may sell it at 4s. 6d. a quart; how much water must he add?

Suppose the water to be x quarts, then the entire number of quarts in the mixture will be $40 + x$, and by the question the worth of the pure wine is 280s., and that of the reduced wine is $4\frac{1}{2}(40 + x)$ shillings. As the worth is to remain the same, we have the equation

$$4\frac{1}{2}(40 + x) = 280, \text{ or } 180 + 4\frac{1}{2}x = 280$$

$$\therefore 4\frac{1}{2}x = 100; \text{ and } \therefore x = \frac{100}{4\frac{1}{2}} = \frac{200}{9} = 22\frac{2}{9};$$

hence, the quantity of water to be added is $22\frac{2}{9}$ quarts; so that the mixture will make $62\frac{2}{9}$ quarts. The value of this at $4\frac{1}{2}$ s. a quart is found, as in the margin, to be 280s., which is the value of the unreduced 40 quarts.

19. Divide 90 into four parts, such, that if the first be increased by 2, the second diminished by 2, the third multiplied by 2, and the fourth divided by 2, the results may all be equal.

$$\begin{array}{r} 2)62\frac{2}{9} \\ \underline{4\frac{1}{2}} \\ 248\frac{4}{9} \\ \underline{31\frac{1}{3}} \\ 280\text{s.} \\ \hline \end{array}$$

ALGEBRAIC SOLUTIONS.

Let the first part be $x - 2$: this, increased by 2, is x .
 Then the second will be $x + 2$: „ diminished by 2, is x .
 „ third „ $\frac{x}{2}$: „ multiplied by 2, is x .
 „ fourth „ $2x$: „ divided by 2, is x .

The sum of these is $4x + \frac{x}{2} = 90$.

Multiplying by 2, $8x + x = 180$, $\therefore 9x = 180$, $\therefore x = 20$;
 hence, the required parts are 18, 22, 10, and 40, which together make 90.

20. Divide 39 into four parts, such, that if the first be increased by 1, the second diminished by 2, the third multiplied by 3, and the fourth divided by 4, the results may all be equal.

Let the first part be $x - 1$: this increased by 1 is x .
 Then the second will be $x + 2$: this diminished by 2 is x .
 „ third „ $\frac{x}{3}$: this multiplied by 3 is x .
 „ fourth „ $4x$: this divided by 4 is x .

The sum of these is $6x + \frac{x}{3} + 1 = 39$, $\therefore 6x + \frac{x}{3} = 38$.

Multiplying by 3, $18x + x = 114$, $\therefore 19x = 114$, $\therefore x = 6$;
 hence, the required parts are 5, 8, 2, and 24, the sum of which is 39.

From the last two examples you will perceive that although in general the unknown quantity sought is best represented by a single symbol x , yet the conditions of the question may be such as to suggest a more convenient form for the unknown: a judicious form of representation at the outset will often save several steps of work in the solution. When fractions are foreseen to enter the equation, when the symbol for the unknown is x , it will always be better to use instead of x , such a multiple of x as will preclude their entrance, as in examples 7 and 8 above.

MULTIPLICATION. CASE I. PAGE 180.

EXAMPLES FOR EXERCISE.

- | | | | |
|--|--|--|---|
| 1. $\begin{array}{r} 9a^3y^2 \\ 4a^2y^3 \\ \hline 36a^5y^5 \end{array}$ | 2. $\begin{array}{r} -7bx^2y^3 \\ 8b^4y^5 \\ \hline -56b^5x^2y^8 \end{array}$ | 3. $\begin{array}{r} -4a^2x^3z^4 \\ -6 \\ \hline -24a^2x^3z^4 \end{array}$ | 4. $\begin{array}{r} -5b^3c^2y \\ -3c^4y^2z \\ \hline 15b^3c^6y^4z \end{array}$ |
| 5. $\begin{array}{r} 11a^4xy^2z^3 \\ -9a^5x^7y^3z^2 \\ \hline -99a^9x^8y^7z^5 \end{array}$ | 6. $\begin{array}{r} -13a^2x^3y^4 \\ 14a^4x^2y^2 \\ \hline -182a^6x^5y^6 \end{array}$ | 7. $\begin{array}{r} \frac{1}{2}bx^3y^2 \\ -4b^2xy^6 \\ \hline -2b^6xy^7 \end{array}$ | 8. $\begin{array}{r} \frac{1}{4}ax^4z^2 \\ \frac{1}{3}x^3y^4z \\ \hline \frac{1}{4}ax^7y^8z \end{array}$ |
| 9. $\begin{array}{r} 2ax^2y \\ -3a^2y^3 \\ \hline -6a^3x^2y^4 \\ -4a^3x^4 \\ \hline 24a^6x^6y^4 \end{array}$ | 10. $\begin{array}{r} -3b^2yz \\ -2y^2z^2 \\ \hline 6b^2y^3z^3 \\ -4ab^3y \\ \hline -24ab^6y^4z^3 \end{array}$ | 11. $\begin{array}{r} \frac{1}{2}axy^3 \\ \frac{2}{3}x^2y \\ \hline \frac{1}{4}ax^3y^4 \\ -3a^2y^2 \\ \hline -a^3x^3y^4 \end{array}$ | 12. $\begin{array}{r} \frac{2}{3}a^2z^3 \\ -\frac{1}{2}x^2y^3 \\ \hline -\frac{1}{3}a^2x^2y^3z^3 \\ -\frac{2}{3}a^3y^3z \\ \hline \frac{1}{15}a^5x^2y^3z^4 \end{array}$ |

ALGEBRAIC SOLUTIONS.

$$\begin{array}{r}
 13. \quad -\frac{4}{3}a^2y^2 \\
 \quad -3b^2z^2 \\
 \hline
 \quad \frac{4}{3}a^2b^2y^2z^2 \\
 \quad -\frac{4}{3}abx^2yz \\
 \hline
 \quad -\frac{4}{3}a^3b^2x^2y^2z^2
 \end{array}$$

$$\begin{array}{r}
 14. \quad \frac{7}{3}a^2x \\
 \quad -\frac{4}{3}x^2y \\
 \hline
 \quad -\frac{7}{6}a^3x^2y \\
 \quad -2y^2z \\
 \hline
 \quad \frac{7}{6}a^3x^2y^2z \\
 \quad -10a^2xz^2 \\
 \hline
 \quad -14a^2x^4y^2z^3
 \end{array}$$

MULTIPLICATION. CASE II. PAGE 181.

$$\begin{array}{r}
 1. \quad 3ax^2 - 2bxy \\
 \quad 4a^2x \\
 \hline
 12a^3x^3 - 8a^2bx^2y
 \end{array}$$

$$\begin{array}{r}
 2. \quad 5a^2y^2 - 4x^2y^3 \\
 \quad -3axy \\
 \hline
 -15a^3xy^3 + 12ax^2y^4
 \end{array}$$

$$\begin{array}{r}
 3. \quad -6b^2yz^3 + 4ab^2y^2 \\
 \quad -2ayz \\
 \hline
 12ab^2y^2z^4 - 8a^2b^2y^3z
 \end{array}$$

$$\begin{array}{r}
 4. \quad 7a^7b^4x^4 - 3x^2y^4 + 5 \\
 \quad 4ax^3y \\
 \hline
 28a^4b^4x^6y - 12ax^5y^5 + 20ax^3y
 \end{array}$$

$$\begin{array}{r}
 5. \quad 9m^2n^2 - 7a^2y^3 - 2b^3x^3y \\
 \quad -7am^2x^2 \\
 \hline
 -63am^2n^3x^2z^2 + 49a^3n^2x^2y^3 + 14ab^3n^2x^3y
 \end{array}$$

6. $(2a^2bx^2 - 5xy^2) \times 3ax^2y = 6a^3bx^4y - 15ax^3y^3$.
7. $(2axy^2 - 3x^2z + 2x) \times -4axy = 8a^2x^2y^3 + 12ax^2yz - 8ax^2y$.
8. $(nxyz^3 + 3ny^2 - 2y^2z) \times -6m^2x^2y = -6m^2x^2y^4 - 18m^2nx^2y^3 + 12m^2x^2y^4z$.
9. $(4y^3z^2 - 3az^3 - 5by^3) \times -5ab^2y = -20ab^2y^4z^2 + 15a^2b^2yz^3 + 25ab^3y^4$.
10. $(5cx^2z^3 - y^4z^2 - 3z^4) 12c^2x^3yz^2 = 60c^3x^5yz^5 - 12c^2x^3y^4z^3 - 36c^2x^3yz^6$.
11. $(3ax^3 - 4by^2 - 2cz^2) \times -12a^2bc^3 = -8a^3bc^3x^3 + 3a^2b^2c^3y^2 + 24a^2bc^4z^2$.
12. $\{4ay^2 - (2b^2z^2 - yz - 2)\} 3a^2yz^3 = \{4ay^2 - 2b^2z^2 + yz + 2\} 3a^2yz^3 = 12a^3y^2z^3 - 6a^2b^2yz^5 + 3a^2y^2z^4 + 6a^2yz^5$.
13. $\{2bx^2y^3 - (5cy^2z + 4yz^2 - 3z^3)\} \times -3x^2y = \{2bx^2y^3 - 5cy^2z - 4yz^2 + 3z^3\} \times -3x^2y = -6bx^4y^4 + 15cx^2y^3z + 12x^2y^2z^3 - 9x^2yz^3$.
14. $\{5a^2x^2 - (3b^2y^2 + 2a^2x^2 - 4ay^3)\} \times -2a^2b^2xy = \{5a^2x^2 - 3b^2y^2 - 2a^2x^2 + 4ay^3\} \times -2a^2b^2xy = -10a^4b^2x^3y + 6a^2b^4xy^3 + 4a^4b^2x^2y - 8a^3b^2xy^4$.

ALGEBRAIC SOLUTIONS.

MULTIPLICATION. CASE III. PAGE 183.

$$1. \quad \begin{array}{r} 2ax^2 - 3bx - 2 \\ 3x^2 - 2x \\ \hline \end{array}$$

$$\begin{array}{r} 6ax^4 - 9bx^3 - 6x^2 \\ - 4ax^3 + 6bx^2 + 4x \\ \hline \end{array}$$

$$\underline{6ax^4 - (4a + 9b)x^3 + 6(b - 1)x^2 + 4x.}$$

$$2. \quad \begin{array}{r} 4ay + 3bx - 4c \\ 3by + 2c \\ \hline \end{array}$$

$$\begin{array}{r} 12aby^2 + 9b^2xy - 12bcy \\ 8acy + 6bcx - 8c^2 \\ \hline \end{array}$$

$$\underline{12aby^2 + (9b^2x + 8ac)y + 6bc(x - 2y) - 8c^2.}$$

$$3. \quad \begin{array}{r} 5x^3 - 4x^2 + 3x - 2 \\ 2x^2 - x + 1 \\ \hline \end{array}$$

$$\begin{array}{r} 10x^5 - 8x^4 + 6x^3 - 4x^2 \\ - 5x^4 + 4x^3 - 3x^2 + 2x \\ 5x^3 - 4x^2 + 3x - 2 \\ \hline \end{array}$$

$$\underline{10x^5 - 13x^4 + 15x^3 - 11x^2 + 5x - 2.}$$

$$4. \quad \begin{array}{r} (x + 2)(x - 2) = x^2 - 4; (x + 3)(x - 3) = x^2 - 9 \\ x^2 - 9 \\ \hline \end{array}$$

$$\begin{array}{r} x^4 - 4x^2 \\ - 9x^2 + 36 \\ \hline x^4 - 13x^2 + 36 \end{array}$$

(See ALGEBRA, page 182).

$$5. \quad (x + a)(x - a) = x^2 - a^2; (x^2 - a^2)(x^2 - a^2) = x^4 - 2a^2x^2 + a^4$$

$$6. \quad \begin{array}{r} 2x + 3a \\ 4x - 5a \\ \hline \end{array}$$

$$\begin{array}{r} 8x^2 + 12ax \\ - 10ax - 15a^3 \\ \hline \end{array}$$

$$\begin{array}{r} 8x^2 + 2ax - 15a^3 \\ x + a \\ \hline \end{array}$$

$$\begin{array}{r} 8x^3 + 2ax^2 - 15a^3x \\ 8ax^2 + 2a^2x - 15a^4 \\ \hline \end{array}$$

$$\underline{8x^3 + 10ax^2 + (2 - 15a)a^2x - 15a^4}$$

ALGEBRAIC SOLUTIONS.

$$7. \begin{array}{l} 3ax - b \\ 4ax + c \end{array}$$

$$\begin{array}{r} 12a^2x^2 - 4abx \\ \underline{3acx - bc} \end{array}$$

$$\begin{array}{r} 12a^2x^2 + (3c - 4b)ax - bc \\ \underline{5ax - 3} \end{array}$$

$$\begin{array}{r} 60a^3x^3 + 5(3c - 4b)a^2x^2 - 5abcx \\ \underline{-36a^2x^2 - 3(3c - 4b)ax + 3bc} \end{array}$$

$$\begin{array}{r} 60a^3x^3 + \{5(3c - 4b) - 36\}a^2x^2 - \{3(3c - 4b) + 5bc\}ax + 3bc \end{array}$$

$$8. \begin{array}{l} 4ax + 3by - 1 \\ 2ax - by + 2 \end{array}$$

$$\begin{array}{r} 8a^2x^2 + 6abxy - 2ax \\ \underline{-4abxy - 3b^2y^2 + by} \\ 8ax + 6by - 2 \end{array}$$

$$\begin{array}{r} 8a^2x^2 + 2abxy + 6ax - 3b^2y^2 + 7by - 2 \end{array}$$

$$9. (x - y)^2(x + y) = (x - y)^2(x - y)(x + y) = (x - y)^2(x^2 - y^2)$$

$$\begin{array}{r} x^2 - 2xy + y^2 \\ \underline{x^2 - y^2} \end{array}$$

$$\begin{array}{r} x^4 - 2x^2y + x^2y^2 \\ \underline{-x^2y^2 + 2xy^3 - y^4} \\ x^4 - 2x^2y + 2xy^3 - y^4 \end{array}$$

$$10. \begin{array}{l} x^2 - (a + b)x + c \\ x - c \end{array}$$

$$\begin{array}{r} x^3 - (a + b)x^2 + cx \\ \underline{-cx^2 + (a + b)cx - c^2} \end{array}$$

$$\begin{array}{r} x^3 - (a + b + c)x^2 + (a + b + 1)cx - c^2 \end{array}$$

$$11. 3^2(x^2 - a^2)^2 = 27(x^4 - 2a^2x^2 + a^4).$$

$$12. (2x + 3)(2x - 3)(4x^2 + 9) = (4x^2 - 9)(4x^2 + 9) = 16x^4 - 81.$$

$$13. \{(x + 2)(x - 2)\}^2 = (x^2 - 4)^2 = x^4 - 8x^2 + 16. \text{ (Page 182).}$$

$$14. \begin{array}{l} x^2 - \frac{1}{2}x + 1 \\ x^2 + 2x - 1 \end{array}$$

$$\begin{array}{r} x^4 - \frac{1}{2}x^3 + x^2 \\ \underline{2x^3 - x^2 + 2x} \\ -x^2 + \frac{1}{2}x - 1 \end{array}$$

$$\begin{array}{r} x^4 + 1\frac{1}{2}x^3 - x^2 + 2\frac{1}{2}x - 1 \end{array}$$

ALGEBRAIC SOLUTIONS.

INVOLUTION: PAGE 184.

- | | |
|--|--|
| 1. $(3a^2x^2)^2 = 9a^4x^4.$ | 2. $(7by^3)^4 = 2401b^4y^{12}.$ |
| 3. $(-4a^2b^3x^4)^3 = -64a^6b^9x^{12}.$ | 4. $(2x^4y^2z)^5 = 32x^{20}y^{10}z^5.$ |
| 5. $(-3a^3y^2z^2)^5 = -243a^{15}y^{10}z^{10}.$ | 6. $(-8b^2x^6y^3)^5 = -512b^{10}x^{30}y^{15}.$ |
| 7. $(5a^2b^3c^4)^4 = 625a^8b^{12}c^{16}.$ | 8. $(-2^2a^3x^2y)^3 = -64a^6x^6y^3.$ |

INVOLUTION. EXAMPLES FOR EXERCISE. PAGE 184.

1. $(a + 2x)^3 = (a + 2x)^2(a + 2x) = \begin{cases} a^2 + 4x + 4x^2. & \text{(See 2, p. 182).} \\ a + 2x \end{cases}$
- $$\begin{array}{r} a^3 + 4ax + 4ax^2 \\ 2a^2x + 8x^2 + 8x^3 \\ \hline a^3 + 2a(a + 2)x + 4(a + 2)x^2 + 8x^3 \end{array}$$
2. $(3ax - 4y)^3 = (3ax - 4y)^2(3ax - 4y) = \begin{cases} 9a^2x^2 - 24axy + 16y^2. & \text{(See 3,} \\ 3ax - 4y & \text{[p. 182].} \end{cases}$
- $$\begin{array}{r} 27a^3x^3 - 72a^2x^2y + 48axy^2 \\ - 36a^2x^2y + 96axy^2 - 64y^3 \\ \hline 27a^3x^3 - 108a^2x^2y + 144axy^2 - 64y^3 \end{array}$$
3. $a + b + c$ (See NOTE, p. 187).
- $$\begin{array}{r} a^2 + ab + ac \\ ab + b^2 + bc \\ ac + bc + c^2 \\ \hline a^2 + 2ab + 2ac + b^2 + 2bc + c^2 \end{array}$$
4. $3x^2 + 2x + 5$
- $$\begin{array}{r} 3x^2 + 2x + 5 \\ 9x^4 + 6x^3 + 15x^2 \\ 6x^3 + 4x^2 + 10x \\ 15x^2 + 10x + 25 \\ \hline 9x^4 + 12x^3 + 34x^2 + 20x + 25 \end{array}$$
5. $a - 2b + 3c$
- $$\begin{array}{r} a^2 - 2ab + 3ac \\ - 2ab + 4b^2 - 6bc \\ 3ac - 6bc + 9c^2 \\ \hline a^2 - 4ab + 6ac + 4b^2 - 12bc + 9c^2 \end{array}$$
6. $\{(a + x)(a - x)\}^3 = (a^2 - x^2)^3$
- $$\begin{array}{r} (a^2 - x^2)^3 = \begin{cases} a^4 - 2a^2x^2 + x^4 \\ a^2 - x^2 \end{cases} \\ a^6 - 2a^4x^2 + a^2x^4 \\ - a^4x^2 + 2a^2x^4 - x^6 \\ \hline a^6 - 3a^4x^2 + 3a^2x^4 - x^6 \end{array}$$

ALGEBRAIC SOLUTIONS.

$$7. \{(x+2)(x-2)\}^3 = (x^2-4)^3 = (x^2-4)^2(x^2-4) = \frac{\begin{array}{r} x^4 - 8x^2 + 16 \\ x^2 - 4 \\ \hline x^6 - 8x^4 + 16x^2 \\ - 4x^4 + 32x^2 - 64 \\ \hline x^6 - 12x^4 + 48x^2 - 64 \end{array}}$$

$$8. \{(2x+3)(2x+3)\}^4 = (4x^2-9)^4 = \frac{\begin{array}{r} (4x^2-9)^2(4x^2-9)^2 = \begin{cases} 16x^4 - 72x^2 + 81 \\ 16x^4 - 72x^2 + 81 \end{cases} \\ \hline 256x^8 - 1152x^6 + 1296x^4 \\ - 1152x^6 + 5184x^4 - 5832x^2 \\ \hline 1296x^4 - 5832x^2 + 6561 \\ \hline 256x^8 - 2304x^6 + 7776x^4 - 11664x^2 + 6561 \end{array}}$$

$$9. (x-a)^2 + 2ax = x^2 - 2ax + a^2 + 2ax = x^2 + a^2$$

And $(x^2 + a^2)^4 = \frac{\begin{array}{r} x^4 + 2a^2x^2 + a^4 \\ x^4 + 2a^2x^2 + a^4 \\ \hline x^8 + 2a^2x^6 + a^4x^4 \\ 2a^2x^6 + 4a^4x^4 + 2a^6x^2 \\ a^4x^4 + 2a^6x^2 + a^8 \\ \hline x^8 + 4a^2x^6 + 6a^4x^4 + 4a^6x^2 + x^8 \end{array}}$

$$10. (x+1)(x-1)(x^2+1) = (x^2-1)(x^2+1) = x^4-1, \text{ and } (x^4-1)^2 = x^8-2x^4+1$$

$$11. (x-1)^2 = x^2-2x+1 \quad \therefore \frac{x^2-2x+1}{x^2-2x+1}$$

$$\frac{\begin{array}{r} x^4 - 2x^3 + x^2 \\ - 2x^3 + 4x^2 - 2x \\ \hline x^2 - 2x + 1 \end{array}}{\begin{array}{r} x^4 - 4x^3 + 6x^2 - 4x + 1 \\ x^2 - 2x + 1 \\ \hline x^6 - 4x^5 + 6x^4 - 4x^3 + x^2 \\ - 2x^5 + 8x^4 - 12x^3 + 8x^2 - 2x \\ \hline x^4 - 4x^3 + 6x^2 - 4x + 1 \\ \hline x^6 - 6x^5 + 16x^4 - 20x^3 + 15x^2 - 6x + 1 \end{array}}$$

NOTE.—In working the foregoing examples, it will be seen that frequent application has been made of the principles marked 1, 2, 3, at page 182. They should always be used in like manner whenever opportunity occurs. The Binomial Theorem, in the next article, is, however, of still wider application, and you should make yourself well

ALGEBRAIC SOLUTIONS.

acquainted with its form: the eleventh example, here worked out in full, is solved in a moment by aid of the Binomial Theorem, as you will see by a reference to the table of developments at the bottom of page 184. The example in question is to find the sixth power of $x - 1$; for $\{(x - 1)^2\}^3$ is the same as $(x - 1)^6$. If you suppose a in the table to be -1 , you will see that the development of $(x - 1)^6$ is the same as that found above by actual multiplication: the directions at page 185 show how this development might have been written down at once.

BINOMIAL THEOREM. EXAMPLES FOR EXERCISE. PAGE 187.

1. To develop $(a + y)^4$. The terms without the coefficients are

$$a^4, a^3y, a^2y^2, ay^3, y^4.$$

The coefficients, as far as the third, are

$$1, 4, \frac{3 \times 4}{2} = 6$$

$$\therefore (a + y)^4 = a^4 + 4a^3y + 6a^2y^2 + 4ay^3 + y^4.$$

Instead of finding the terms without the coefficients, and then the coefficients in a separate step, it is just as easy to write down each term in succession in its complete form, attending to the directions at page 185.

2. $(a - x)^5 = a^5 - 5a^4x + 10a^3x^2 - 10a^2x^3 + 5ax^4 - x^5.$

3. $(a + 2x)^3 = a^3 + 3a^2(2x) + 3a(2x)^2 + (2x)^3$
 $= a^3 + 6a^2x + 12ax^2 + 8x^3.$

4. $(1 - x)^6 = 1 - 6x + 15x^2 - 20x^3 + 15x^4 - 6x^5 + x^6.$

In this example the powers of 1, the first term of the binomial $1 - x$, are, of course, suppressed; but the exponents of those powers are mentally employed, as in other cases, to form the coefficients.

5. $(1 + 3x)^4 = 1 + 4(3x) + 6(3x)^2 + 4(3x)^3 + (3x)^4$
 $= 1 + 12x + 54x^2 + 108x^3 + 81x^4.$

6. $(x + 2y^2)^5 = x^5 + 5x^4(2y^2) + 10x^3(2y^2)^2 + 10x^2(2y^2)^3 + 5x(2y^2)^4 + (2y^2)^5$
 $= x^5 + 10x^4y^2 + 40x^3y^4 + 80x^2y^6 + 80xy^8 + 32y^{10}.$

7. $(x^2 + 3y^2)^5 = (x^2)^5 + 5(x^2)^4(3y^2) + 10(x^2)^3(3y^2)^2 + 10(x^2)^2(3y^2)^3 + 5(x^2)(3y^2)^4 + (3y^2)^5$
 $= x^{10} + 15x^8y^2 + 90x^6y^4 + 270x^4y^6 + 405x^2y^8 + 243y^{10}.$

8. $(2a - x)^6 = (2a)^6 - 6(2a)^5x + 15(2a)^4x^2 - 20(2a)^3x^3 + 15(2a)^2x^4 - 6(2a)x^5 + x^6$
 $= 64a^6 - 192a^5x + 240a^4x^2 - 160a^3x^3 + 60a^2x^4 - 12ax^5 + x^6.$

9. $(x - 2y^2)^7 = x^7 - 7x^6(2y^2) + 21x^5(2y^2)^2 - 35x^4(2y^2)^3 + 35x^3(2y^2)^4 - 21x^2(2y^2)^5 + 7x(2y^2)^6 - (2y^2)^7$
 $= x^7 - 14x^6y^2 + 84x^5y^4 - 280x^4y^6 + 560x^3y^8 - 672x^2y^{10} + 448xy^{12} - 128y^{14}.$

DIVISION. CASE I. EXAMPLES FOR EXERCISE. PAGE 189.

1. $\frac{8ax^2y^2}{4axy} = 2xy.$

2. $\frac{-6bx^3y^2z}{2bx^3y} = -3yz.$

3. $\frac{-12x^3y^4z^5}{-3x^2y^3z^2} = 4xyz^3.$

4. $\frac{16ax^2y^3}{-4a^2xy^2} = -\frac{4xy}{a}.$

ALGEBRAIC SOLUTIONS.

- | | |
|--|--|
| 5. $\frac{7ax^2yz^2}{-5a^2x^2yz^2} = -\frac{7x^2}{5a}$ | 6. $\frac{-8b^2yz}{6b^2yz^2} = -\frac{4b^2}{3yz}$ |
| 7. $\frac{24xy^3}{-21c^2yz} = -\frac{8y}{7cz}$ | 8. $\frac{-36a^2x^2y^3}{2 \times 7a^2x^2y^3} = -\frac{18y^2}{7x^2}$ |
| 9. $\frac{5abx^2\sqrt{y}}{10ab^2x\sqrt{y}} = \frac{x}{2b}$ | 10. $\frac{-3a^2c^2x^4}{-12ac^2x^2\sqrt{x}} = \frac{ac}{4x\sqrt{x}}$ |
| 11. $\frac{-2mx^4y^7}{8m^2x^4y^8} = -\frac{1}{4my}$ | 12. $\frac{-13x^2yz^2}{-26y^4\sqrt{x}} = \frac{x^2y}{2}$ |

DIVISION. CASE II. PAGE 189.

- $\frac{9a^2x^2 - 3a^3x^3 + 6a^4x}{3a^2x} = 3x - ax^2 + 2a^2$
- $\frac{12x^2yz^4 + 6x^2y^3z^2 - 3x^2y^3}{3x^2yz^2} = 4xz^2 + 2y^2 - \frac{y}{z^2}$
- $\frac{3ax(4xy - 8ay^2) + 12axy}{6axy} = \frac{12ax^2y - 24a^2xy^3 + 12axy}{6axy} = 2x - 4ay + 2$
- $\frac{8x^2y^4 - 4(4ax - 2y)x}{4x^2y} = \frac{8x^2y^4 - 16ax^2 + 8y}{4x^2y} = 2xy^3 - \frac{4a}{y} + \frac{2}{x}$

The last two examples might have been treated somewhat more simply; thus, cancelling $3ax$ from dividend and divisor in example 3, we have

$$\frac{4xy - 8ay^2 + 4y}{2y} = 2x - 4ay + 2.$$

It is easy to see that instead of $3ax$, $6ax$ might have been cancelled. In like manner, in example 4, by cancelling $4x$, we have

$$\frac{2x^2y^4 - 4ax + 2y}{xy} = 2xy^3 - \frac{4a}{y} + \frac{2}{x}$$

5. Cancelling 2, from dividend and divisor, we have

$$\frac{4a^2x^2y^2 - 3ax^2y^2z^2 + 1}{2axy} = 2axy - \frac{3}{2}y^2z^2 + \frac{1}{2axy}$$

6. $\frac{16a^4b^2x^3 - 8 + 3a^2bx^4}{4a^2bx^3} = 4a^2bx + \frac{3x^2}{4} - \frac{2}{a^2bx^2}$

DIVISION. CASE III. PAGE 191.

- | | |
|---|--|
| 1. $\frac{x - 7x^2 - 2x - 35(x + 5)}{x^2 - 7x}$ | 2. $\frac{x + 3x^2 - x - 12(x - 4)}{x^2 + 3x}$ |
| $\frac{5x - 35}{5x - 35}$ | $\frac{-4x - 12}{-4x - 12}$ |
| 3. $\frac{3x + 2}{6x^2 + 4x}$ | 4. $\frac{3x + 2}{12x^2 + 8x}$ |
| $\frac{9x + 6}{9x + 6}$ | $\frac{21x + 14}{21x + 14}$ |

ALGEBRAIC SOLUTIONS.

$$\begin{array}{r}
 10. \quad x^2 + x - 1 \overline{) x^6 - x^4 + x^3 + x^2 - 1} (x^4 - x^3 + x^2 - x + 1 - \frac{2x}{x^2 + x - 1} \\
 \underline{x^6 + x^5 - x^4} \\
 -x^5 + x^3 - x^2 \\
 \underline{-x^5 - x^4 + x^3} \\
 x^4 - x^2 - 1 \\
 \underline{x^4 + x^3 - x^2} \\
 -x^3 - 1 \\
 \underline{-x^3 - x^2 + x} \\
 x^2 - x - 1 \\
 \underline{x^2 + x - 1} \\
 -2x \quad \text{Remainder.}
 \end{array}$$

11. Cancelling x , from dividend and divisor, and removing the vincula, the operation is as follows:

$$\begin{array}{r}
 3x - 3 \overline{) 6x^3 + 9x^2 - 20(2x^2 + 5x + 5 - \frac{4}{3x - 3}} \\
 \underline{6x^3 - 6x^2} \\
 15x^2 - 20 \\
 \underline{15x^2 - 15x} \\
 15x - 20 \\
 \underline{15x - 15} \\
 -4 \quad \text{Rem.}
 \end{array}$$

$$\begin{array}{r}
 12. \quad x - a \overline{) x^2 + px + q(x + a + p)} \\
 \underline{x^2 - ax} \\
 (a + p)x + q \\
 \underline{(a + p)x - a^2 - pa} \\
 a^2 + pa + q \quad \text{Rem.}
 \end{array}$$

$$\begin{array}{r}
 13. \quad x - a \overline{) x^3 + px^2 + qx + r(x^2 + (a + p)x + a^2 + pa + q)} \\
 \underline{x^3 - ax^2} \\
 (a + p)x^2 + qx \\
 \underline{(a + p)x^2 - (a^2 + pa)x} \\
 (a^2 + pa + q)x + r \\
 \underline{(a^2 + pa + q)x - a^3 - pa^2 - qa} \\
 a^3 + pa^2 + qa + r \quad \text{Rem.}
 \end{array}$$

The final remainder in example 12 is $a^2 + pa + q$, and that in example 13 is $a^3 + pa^2 + qa + r$; in each case the remainder is the very same expression as we should get

ALGEBRAIC SOLUTIONS.

by rubbing out the x in the dividend and putting a instead, as observed at page 191. The property is perfectly general: if any polynomial proceeding according to the powers of x be divided by $x - a$, the remainder will always be the same as the polynomial itself when the x is replaced by a . Hence, when a is any given number, you will be able to ascertain, without actual division, whether a proposed polynomial is divisible by $x - a$ or not: thus, suppose it were asked—Is $x^2 - 2x - 35$ divisible by $x - 7$? Putting 7 for x in $x^2 - 2x - 35$, we get $49 - 14 - 35 = 0$. Hence, the remainder is nothing, so that the expression is divisible by $x - 7$ (see ex. 1).

In like manner referring to ex. 2, and substituting -3 for x in $x^2 - x - 12$ it becomes $9 + 3 - 12 = 0$. Hence, $x^2 - x - 12$ is divisible by $x + 3$. And a glance will serve to show that the division may be performed without remainder in ex. 7.

SQUARE ROOT OF A SIMPLE QUANTITY. EXAMPLES FOR EXERCISE. PAGE 195.

1. $\sqrt{a^4x^6y} = a^2x^3\sqrt{y}$. 2. $\sqrt[4]{2^4a^4b^8} = \pm 2ab^2$. 3. $\sqrt[3]{8a^3x^3z} = 2ax^2\sqrt[3]{z}$.
4. $\sqrt[3]{-8a^4x^2y^2} = -2ax\sqrt[3]{ay^2}$ 5. $\sqrt{-2a^4y^6z^8} = a^2y^3z^4\sqrt{-2}$.
6. $\sqrt{3a^2y^4x} = a^2y^2\sqrt{3ax}$. 7. $(a^2b^3x^4)^{\frac{1}{2}} = abx^2b^{\frac{1}{2}}$. 8. $\sqrt{x^{\frac{1}{2}}y^2z^2} = yz\sqrt[4]{x}$.
9. $\sqrt{\frac{a^2}{bx^2}} = \frac{a}{x\sqrt{b}} = \frac{a\sqrt{b}}{bx}$.
10. $\sqrt{a^3x^{-4}} = ax^{-2}\sqrt{a}$. 11. $\sqrt{a^{-3}x^{-4}y^{-5}} = a^{-\frac{3}{2}}x^{-2}y^{-\frac{5}{2}}$.
12. $\sqrt{\frac{8a^3}{27x^2y^4}} = \sqrt{\frac{4 \cdot 2a^3}{9 \cdot 3x^2y^4}} = \frac{2a}{3xy^2} \sqrt{\frac{2a}{3x}} = \frac{2a}{3xy^2} \cdot \frac{\sqrt{6ax}}{3x}$.
13. $(-8a^3x^2y^6)^{\frac{1}{3}} = -2ay^2\sqrt[3]{x^2}$.
14. $(9b^4x^2y^3)^{-\frac{1}{2}} = \frac{1}{\sqrt{9b^4x^2y^3}} = \frac{1}{3b^2xy\sqrt{y}} = \frac{\sqrt{y}}{3b^2xy^2}$.
15. $x^2(81x^6y^7z^8)^{-\frac{1}{3}} = \frac{x^2}{\sqrt[3]{81x^6y^7z^8}} = \frac{x^2}{3x^2y^2z^{\frac{8}{3}}\sqrt[3]{y^2z^2}} = \frac{1}{3y^2z^{\frac{8}{3}}\sqrt[3]{3yz^2}} = \frac{(3y^2z^2)^{\frac{2}{3}}}{9y^2z^{\frac{8}{3}}} = \frac{\sqrt[3]{9y^2z^2}}{9y^2z^{\frac{8}{3}}}$.
16. $\sqrt[3]{-16a^5x^6y^{-9}} = -2ax^2y^{-3}\sqrt[3]{2a^2}$.
17. $(32a^{-\frac{1}{2}}x^2y^4)^{-\frac{1}{2}} = 32^{-\frac{1}{2}}a^{-\frac{1}{4}}x^{-1}y^{-2} = \frac{1}{4xy^2\sqrt{2}\sqrt[4]{a}} = \frac{\sqrt{2}\sqrt[4]{a^2}}{8ary^2}$.
18. $(32a^{-3}x^{-6}y^8)^{-\frac{1}{3}} = 32^{-\frac{1}{3}}ax^2y^{-1} = \frac{ax^2}{2y\sqrt[3]{4}} = \frac{ax^2\sqrt[3]{16}}{8y} = \frac{ax^2\sqrt[3]{2}}{4y}$.

REDUCTION OF FRACTIONS. EXAMPLES FOR EXERCISE. PAGE 197.

1. $a + x + \frac{x^2}{a-x} = \frac{a^2 - x^2 + x^2}{a-x} = \frac{a^2}{a-x}$.
2. $3 - y - \frac{2-y^2}{3+y} = \frac{9-y^2-2+y^2}{3+y} = \frac{7}{3+y}$.

ALGEBRAIC SOLUTIONS.

$$3. \frac{b+c}{b-c} - 1 = \frac{b^2 + 2bc + c^2 - (b^2 - 2bc + c^2)}{(b-c)^2} = \frac{4bc}{(b-c)^2}$$

$$4. \frac{a^3 + x^3}{a-x} =, \text{ by actual division, } a^2 + ax + x^2 + \frac{2x^3}{a-x}.$$

$$5. \text{ By actual division, } \frac{a^3 - x^3}{x^2 + ax + x^2} = a - x.$$

$$6. x^2 - a^2 + \frac{x^4 + a^4}{x^2 + a^2} = \frac{x^4 - a^4 + x^4 + a^4}{x^2 + a^2} = \frac{2x^4}{x^2 + a^2}.$$

$$7. \frac{(x+y+z)(x+y-z)}{2xy} - 1 = \frac{[(x+y)+z][(x+y)-z] - 2xy}{2xy} = \frac{(x+y)^2 - z^2 - 2xy}{2xy} = \frac{x^2 + y^2 - z^2}{2xy}.$$

$$8. \frac{[(x+y)+z][(x+y)-z]}{2xy} - 2 = \frac{(x+y)^2 - z^2 - 4xy}{2xy} = \frac{x^2 - 2xy + y^2 - z^2}{2xy} = \frac{(x-y)^2 - z^2}{2xy}.$$

$$9. \frac{x^2 + y^2 - z^2}{2xy} - 1 = \frac{x^2 - 2xy + y^2 - z^2}{2xy} = \frac{(x-y)^2 - z^2}{2xy} = \frac{(x-y-z)(x-y+z)}{2xy}.$$

$$10. x^2 - 3x - \frac{3x(3-x)}{x-2} = x \left\{ \frac{(x-3)(x-2) - 3(3-x)}{x-2} \right\} = \\ x \left\{ \frac{(x-3)(x-2) + 3(x-3)}{x-2} \right\} = \frac{x(x-3)(x-2+3)}{x-2} = \frac{x(x-3)(x+1)}{x-2} \\ = \frac{x(x^2 - 2x - 3)}{x-2} = \frac{x(x^2 - 2x + 1 - 4)}{x-2} = \frac{x \{ (x-1)^2 - 4 \}}{x-2}.$$

ADDITION AND SUBTRACTION OF FRACTIONS. EXAMPLES FOR EXERCISE. PAGE 199.

$$1. \frac{2x-5}{3} + \frac{x-1}{2x} = \frac{4x^2 - 10x + 3x - 3}{6x} = \frac{4x^2 - 7x - 3}{6x}.$$

$$2. \frac{x}{x-3} + \frac{x}{x+3} = \frac{x^2 + 3x + x^2 - 3x}{x^2 - 9} = \frac{2x^2}{x^2 - 9}.$$

$$3. \frac{10x-9}{8} - \frac{3x-5}{7} = \frac{70x - 63 - 24x + 40}{56} = \frac{46x - 23}{56}.$$

$$4. \frac{2x-3}{7x} - \frac{x-5}{8x} = \frac{16x^2 - 24x - 7x^2 + 35x}{56x^2} = \frac{9x^2 + 11x}{56x^2} = \frac{9x + 11}{56x}.$$

$$5. \frac{x-a}{x^2 - ax + a^2} + \frac{1}{x+a} = \frac{x^2 - a^2 + x^2 - ax + a^2}{x^3 + a^3} = \frac{2x^2 - ax}{x^3 + a^3}.$$

$$6. 1 - \frac{x-a}{x+a} = \frac{x+a-x+a}{x+a} = \frac{2a}{x+a}. \quad 7. \frac{a^2z}{xy} - \frac{b^2z}{yz} = \frac{a^2z^2 - b^2z^2}{xyz}$$

In this seventh example, the terms of the first fraction are multiplied by z , and those of the second by x ; the denominators thus become each equal to xyz .

ALGEBRAIC SOLUTIONS.

8. $\frac{1}{x} + \frac{1}{x^2} - \frac{1}{x^n}$. Multiplying the terms of the first fraction by x^{n-1} , and those of the second by x^{n-2} , we have $\frac{x^{n-1} + x^{n-2} - 1}{x^n}$.

9. $\frac{1}{2x-a} + \frac{1}{1+x+x^2}$

$$\frac{1}{2x+a} - \frac{4x^2}{4x^2-a^2} = \frac{2x+a+2x-a-4x^2}{4x^2-a^2} = \frac{4x-4x^2}{4x^2-a^2}$$

$$- \frac{1-x}{1-x+x^2} = \frac{(1+x)(1-x+x^2) - (1+x+x^2)(1-x)}{\{(1+x^2)+x\}\{(1+x^2)-x\}} = \frac{(1+x)x^2 - x^2(1-x)}{(1+x^2)^2 - x^2}$$

$$= \frac{2x^3}{1+x^2+x^4}$$

11. $\frac{a^2+b^2}{a^2-b^2} + \frac{a+b}{a-b} - \frac{a-b}{a+b} + 2 = \frac{a^2+b^2+a^2-b^2-(a^2-b^2)+2(a^2-b^2)}{a^2-b^2}$

$$= \frac{3a^2-b^2}{a^2-b^2}$$

12. $\frac{y}{y-3} - \frac{y-3}{y} + \frac{y}{y+3} - \frac{y+3}{y}$

The second and fourth fractions united give $-\frac{2y}{y} = -2$, the first and third make $\frac{y^2+3y+y^2-3y}{y^2-9} = \frac{2y^2}{y^2-9}$. Hence the sum of all is $\frac{2y^2}{y^2-9} - 2 = \frac{2y^2-2y^2+18}{y^2-9} = \frac{18}{y^2-9}$.

13. $\frac{x}{x+y} + \frac{y}{x-y} = \frac{x^2 - xy + xy + y^2}{(x+y)(x-y)} = \frac{x^2 + y^2}{x^2 - y^2}$

and $\frac{x}{x-y} - \frac{y}{x+y} = \frac{x^2 + xy - xy + y^2}{(x-y)(x+y)} = \frac{x^2 + y^2}{x^2 - y^2}$

14. $\frac{x}{x+z} - \frac{y}{y+z} = \frac{xy + xz - xy - yz}{(x+y)(x+z)} = \frac{(x+z)(y-z)}{(x+z)(y+z)}$

and $\frac{z}{y+z} - \frac{z}{x+z} = \frac{xz + z^2 - yz - z^2}{(y+z)(x+z)} = \frac{(x-z)(y+z)}{(x+z)(y+z)}$

MULTIPLICATION OF FRACTIONS. EXAMPLES FOR EXERCISE. PAGE 200.

1. $\frac{4x}{7} \times \frac{5}{9x} = \frac{4}{7} \times \frac{5}{9} = \frac{20}{63}$ 3. $\frac{4x+2}{3} \times \frac{5x}{2x+1} = \frac{2}{3} \times 5x = \frac{10x}{3}$

2. $\frac{4x+1}{3} \times \frac{6x}{7} = (4x+1) \frac{2x}{7} = \frac{8x^2+2x}{7}$ 4. $\frac{2x-1}{x+2} \times \frac{3x+1}{x-3} = \frac{6x^2-x-1}{x^2-x-6}$

5. $\frac{a+b}{b} \times \frac{b^2x}{a^2-b^2} = 1 \times \frac{bx}{a-b} = \frac{bx}{a-b}$

6. $\frac{x^3-x^2x}{a^2} \times \frac{x}{ax-a^2} = \frac{x^4-a^2x^2}{a^3x-a^3}$ 7. $\frac{x^m}{y^m} \times \frac{x^n}{y^n} = \frac{x^{m+n}}{y^{m+n}}$

8. $\frac{x^m}{y^m} \times \frac{y^n}{x^n} = \frac{x^{m-n}}{y^{m-n}}$ 9. $\frac{3\sqrt{x}}{y} \times \frac{2y^2}{5\sqrt{x}} = \frac{6y}{5}$

10. $\frac{x^2-4a^2}{x-a} \times \frac{x^3-a^3}{x+2a} = (x-2a)(x^2+ax+a^2) = x^3-ax^2-a^2x-2a^3$

In this tenth example it is seen at once that the numerator of the second fraction is divisible by the denominator of the first, because if a be put for x in $x^3 - a^3$, the result is 0. (See p. 19, Key).

ALGEBRAIC SOLUTIONS.

11. $\frac{2x}{7} \times \frac{4x}{9} \times \frac{7}{4x} \times \frac{9x}{5} = 2x \times 1 \times \frac{x}{5} = \frac{2x^2}{5}$.
12. $\frac{4x+2}{3} \times \frac{5x}{2x+1} \times \frac{9x-3}{x} = 2 \times 5 \times (3x-1) = 30x-10$.
13. $\frac{(x-y)^2}{x^2-y^2} \times \frac{x+y}{x-y} = \frac{x-y}{x-y} = 1$.
14. $\frac{(x-y)^2}{x^2-y^2} \times \frac{x+y}{x-y} = \frac{x-y}{(x^2-y^2)(x^2+y^2)} \times (x+y) = \frac{x-y}{(x-y)(x^2+y^2)} = \frac{1}{x^2+y^2}$
15. $(a - \frac{b^2}{a})(\frac{a}{b} + \frac{b}{a}) = \frac{a^2 - b^2}{a} \cdot \frac{a^2 + b^2}{ab} = \frac{a^4 - b^4}{a^2 b}$; Otherwise,
 $(a - \frac{b^2}{a})(\frac{a}{b} + \frac{b}{a}) = b(\frac{a}{b} - \frac{b}{a})(\frac{a}{b} + \frac{b}{a}) = b(\frac{a^2 - b^2}{b^2 - a^2}) = b \frac{a^4 - b^4}{a^2 b} = \frac{a^4 - b^4}{a^2 b}$

DIVISION OF FRACTIONS. EXAMPLES FOR EXERCISE. PAGE 201.

1. $\frac{x}{x-2} \times \frac{x^2+2}{x-1} = \frac{x^3+2x}{x^2-3x+2}$. 2. $\frac{a+1}{a} \times \frac{a}{a-1} = \frac{1}{a-1}$
3. $\frac{x^2-9}{5} \div \frac{x+3}{4} = \frac{x-3}{5} \div \frac{1}{4} = \frac{x-3}{5} \times 4 = \frac{4x-12}{5}$.
4. $\frac{6x^2-2x}{1-x} \div \frac{x^2}{2+x} = \frac{6x-2}{2-x} \div x = \frac{6x-2}{2x-x^2}$.
5. $\frac{9x^2-4y^2}{x+y} \div \frac{3x-2y}{x-y} = \frac{3x+2y}{1} \div \frac{1}{x-y} = (3x+2y)(x-y) = 3x^2 - xy - 2y^2$
6. $\frac{x^2-y^2}{x-2xy+y} \div \frac{x^2+xy}{x-y} = \frac{x+y}{x-y} \div \frac{x(x+y)}{x-y} = 1 \div x = \frac{1}{x}$.

SIMPLE EQUATIONS IN GENERAL. EXAMPLES IN EQUATIONS WITH ONLY ONE UNKNOWN QUANTITY. PAGE 203.

1. $\frac{2x}{5} + \frac{x}{2} = 22 + \frac{x}{6}$. Multiplying the terms of the second fraction by 3,

$$\frac{2x}{5} + \frac{3x}{6} = 22 + \frac{x}{6}$$

Transposing, $\frac{2x}{5} + \frac{x}{3} = 22$,

Clearing, $6x + 5x = 330$, that is $11x = 330 \therefore x = 30$.

This might also have been readily solved by multiplying each side of the proposed equation by 30, the least number divisible by all the denominators; the equation thus cleared of fractions would have been

$$12x + 15x = 660 + 5x$$

$$\therefore 27x - 5x = 660, \therefore 22x = 660, \therefore x = 30.$$

2. $\frac{x}{2} + \frac{x}{3} + \frac{x}{4} = 6\frac{1}{2}$. Multiplying by 12, the least common multiple of the denominators, we have—

$$6x + 4x + 3x = 78$$

that is, $13x = 78, \therefore x = 6$.

ALGEBRAIC SOLUTIONS.

3. $\frac{x}{2} - \frac{x}{4} = \frac{x}{3} - \frac{x}{6} + 1$, or $\frac{2x}{4} - \frac{x}{4} = \frac{2x}{6} - \frac{x}{6} + 1$; that is,

$$\frac{x}{4} = \frac{x}{6} + 1.$$

Multiplying by 12, $3x = 2x + 12$, $\therefore x = 12$.

4. $\frac{18+x}{x} = \frac{6}{x} + 5$, that is, $\frac{18}{x} + 1 = \frac{6}{x} + 5$, $\therefore \frac{12}{x} = 4 \therefore 12 = 4x \therefore x = 3$.

5. $21 + \frac{3x-11}{16} = \frac{5(x-1)}{8} + \frac{97-7x}{2}$. Multiplying by 16,

$$336 + 3x - 11 = 10x - 10 + 776 - 56x.$$

Transposing, $56x + 3x - 10x = 776 + 11 - 10 - 336$

$$\therefore 49x = 441, \therefore x = 9.$$

6. $\sqrt{x^2 + 7} + x = 7$, $\therefore \sqrt{x^2 + 7} = 7 - x$.

Squaring, $x^2 + 7 = 49 - 14x + x^2$, $\therefore 14x = 42$, $\therefore x = 3$.

7. $\sqrt{x-a} - b = 0$, $\therefore \sqrt{x-a} = b$, $\therefore x-a = b^2$, $\therefore x = a + b^2$.

8. $\frac{\sqrt{x+2}}{\sqrt{x-2}} = \frac{3}{2}$. Applying the principle explained at page 203, we have $\frac{\sqrt{x}}{2} =$

$\frac{5}{1}$, $\therefore \sqrt{x} = 10$, $\therefore x = 100$.

9. $\frac{\sqrt{x+28}}{\sqrt{x+4}} = \frac{\sqrt{x+38}}{\sqrt{x+6}}$. Applying the principle referred to in the last example,

we have

$$\frac{\sqrt{x+16}}{12} = \frac{\sqrt{x+22}}{16}. \text{ Multiplying by 3.4.4,}$$

$$4\sqrt{x+64} = 3\sqrt{x+66}, \therefore \sqrt{x} = 2, \therefore x = 4.$$

10. $\frac{\sqrt{x+2a}}{\sqrt{x+b}} = \frac{\sqrt{x+4a}}{\sqrt{x+3b}}$. By the principle at page 203,

$$\frac{2\sqrt{x+2a+b}}{2a-b} = \frac{2\sqrt{x+4a+3b}}{4a-3b}; \text{ that is,}$$

$$\frac{2\sqrt{x+2a+b}}{2a-b} + \frac{2a+b}{2a-b} = \frac{2\sqrt{x+4a+3b}}{4a-3b} + \frac{4a+3b}{4a-3b}$$

Transposing, $\frac{2\sqrt{x}}{2a-b} - \frac{2\sqrt{x}}{4a-3b} = \frac{4a+3b}{4a-3b} - \frac{2a+b}{2a-b}$.

Multiplying by $(2a-b)(4a-3b)$,

$$3a\sqrt{x} - 6b\sqrt{x} - 4a\sqrt{x} + 2b\sqrt{x} = (2a-b)(4a+3b) - (2a+b)(4a-3b)$$

$$\therefore (4a-4b)\sqrt{x} = -8ab + 12ab = 4ab,$$

$$\therefore \sqrt{x} = \frac{ab}{a-b}, \therefore x = \left(\frac{ab}{a-b}\right)^2.$$

11. $\frac{\sqrt{ax-a}}{\sqrt{ax+a}} = \frac{3\sqrt{ax-2a}}{3\sqrt{ax+5a}}$. Applying the foregoing principle, $\frac{\sqrt{ax}}{a} = \frac{6\sqrt{ax+3a}}{7a}$,

Clearing, $7\sqrt{ax} = 6\sqrt{ax+3a}$, $\therefore \sqrt{ax} = -3a$

$$\therefore ax = 9a^2, \therefore x = 9a.$$

12. $\sqrt{x-24} = \sqrt{x-2}$. Squaring each side,

$$x-24 = x-4\sqrt{x}+4.$$

Transposing, $4\sqrt{x} = 28$, $\therefore \sqrt{x} = 7$, $\therefore x = 49$.

13. $\sqrt{4x+21} = 2\sqrt{x}+1$. Squaring each side,

$$4x+21 = 4x+4\sqrt{x}+1.$$

Transposing, $20 = 4\sqrt{x}$, $\therefore \sqrt{x} = 5$, $\therefore x = 25$.

ALGEBRAIC SOLUTIONS.

14. $\sqrt[3]{(2x + 3)} = 3$. Cubing each side,
 $2x + 3 = 27$, $\therefore 2x = 24$, $\therefore x = 12$.

15. $\frac{5x - 9}{\sqrt{5x + 3}} = \frac{\sqrt{5x - 1}}{2}$. The numerator of the first fraction is the difference of the squares of the two quantities in the denominator; therefore, the numerator is actually divisible by the denominator, so that the equation is the same as

$$\sqrt{5x - 3} = \frac{\sqrt{5x - 1}}{2}, \therefore 2\sqrt{5x - 6} = \sqrt{5x - 1},$$

$$\therefore \sqrt{5x} = 5, \therefore 5x = 25, \therefore x = 5.$$

16. $\frac{\sqrt{(x + 1)} - \sqrt{(x - 1)}}{\sqrt{(x + 1)} + \sqrt{(x - 1)}} = \frac{1}{2}$. By the principle at page 203,
 $\frac{\sqrt{(x + 1)}}{\sqrt{(x - 1)}} = \frac{3}{1}$, $\therefore \frac{x + 1}{x - 1} = 9$
 $\therefore x + 1 = 9x - 9$, $\therefore 10 = 8x$, $\therefore x = \frac{10}{8} = 1\frac{1}{4}$.

SIMPLE EQUATIONS WITH TWO UNKNOWN QUANTITIES.

EXAMPLES FOR EXERCISE. PAGE 206.

1. $\begin{cases} 2x + 3y = 23 \\ 5x - 2y = 10 \end{cases}$ 1st. Proceeding by Rule I, we have from the first equation
 $x = \frac{23 - 3y}{2}$, and from the second $x = \frac{10 + 2y}{5}$; hence equating these two expressions for x ,

$$\frac{23 - 3y}{2} = \frac{10 + 2y}{5}$$

Clearing fractions, $115 - 15y = 20 + 4y$,

Transposing, $95 = 19y$, $\therefore y = 5$,

$$\therefore x = \frac{10 + 2y}{5} = \frac{10 + 10}{5} = \frac{20}{5} = 4.$$

2nd. Proceeding by Rule II, we have from the second equation $x = \frac{10 + 2y}{5} = 2 + \frac{2y}{5}$.
 Substituting this in the first we get

$$4 + \frac{4y}{5} + 3y = 23, \therefore \frac{4y}{5} + 3y = 19$$

Clearing, $4y + 15y = 95$, $\therefore 19y = 95$, $\therefore y = 5$

$$\text{And since } x = \frac{10 + 2y}{5}, \therefore x = \frac{20}{5} = 4.$$

3rd. Proceeding by the third method, multiplying the first equation by 2, the second by 3, and then adding the results, we have

$$19x = 76, \therefore x = 4.$$

Again, multiplying the first equation by 5, the second by 2, and subtracting the results, we get

$$19y = 95, \therefore y = 5.$$

ALGEBRAIC SOLUTIONS.

2. $5x + 4y = 58$, Multiplying the first equation by 3, and the second by 5,
 $3x + 7y = 67$ } there results

$$15x + 12y = 174$$

$$15x + 35y = 335$$

Subtracting, $23y = 161, \therefore y = \frac{161}{23} = 7.$

And since from the first equation $x = \frac{58 - 4y}{5}, \therefore x = \frac{58 - 28}{5} = 6.$

Otherwise, thus: multiplying the first equation by 2, we have

$$10x + 8y = 116$$

$$3x + 7y = 67$$

Subtracting, $7x + y = 49, \therefore y = 49 - 7x$

Multiplying by 3, $21x + 3y = 147$

First equa. $5x + 4y = 58$

Subtracting, $-16x + y = -89, \therefore y = 16x - 89$

$\therefore 16x - 89 = 49 - 7x, \therefore 23x = 138, \therefore x = 6,$

$\therefore y = 49 - 7x = 49 - 42 = 7.$

3. $\left. \begin{array}{l} \frac{x}{8} + 8y = 194 \\ y + 8x = 131 \end{array} \right\}$ Clearing fractions, these equations become

$$x + 64y = 1552$$

$$y + 64x = 1048$$

By adding these, $65x + 65y = 2600, \therefore y + x = \frac{2600}{65} = 40$

And by subtracting, $63y - 63x = 504, \therefore y - x = \frac{504}{63} = 8$

\therefore adding and subtracting, $2y = 48$, and $2x = 32$,

$\therefore y = 24$, and $x = 16.$

NOTE.—The rule has been departed from in the preceding solution; and you perceive that considerable advantage on the score of neatness and simplicity has been gained in consequence. By the rule we should have proceeded thus:

From the first equation $x = 1552 - 64y$

Substituting in the second, $y + 64(1552 - 64y) = 1048$;

That is, $64 \times 1552 - 1048 = (64^2 - 1)y$

$$\therefore y = \frac{64 \times 1552 - 1048}{64^2 - 1} = \frac{64 \times 1552 - 1048}{65 \times 63}$$

$$= \frac{98280}{5.9.7.13} = 24$$

And $x = 1552 - 64y = 1552 - 64 \times 24 = 16.$

4. $\left. \begin{array}{l} \frac{x+y}{3} = 5 \\ \frac{y-x}{7} = 1 \end{array} \right\}$ Clearing, these equations become

$$x + y = 15$$

$$y - x = 7$$

Adding and subtracting, we get

$2y = 22$, and $2x = 8, \therefore y = 11, x = 4.$

ALGEBRAIC SOLUTIONS.

$$5. \left. \begin{array}{l} \frac{3x-7y}{3} = \frac{2x+y+1}{5} \\ 2 - \frac{x-y}{5} = 0 \end{array} \right\} \begin{array}{l} \text{Clearing fractions, we have} \\ 15x - 35y = 6x + 3y + 3 \\ 10 - x + y = 0 \end{array}$$

Or, transposing, $9x - 38y = 3 \dots (1)$

$x - y = 10 \dots (2)$

$\therefore 9x - 9y = 90 \dots (3)$

Subtracting (1) from (3), $29y = 87, \therefore y = 3$

$\therefore x = 10 + y = 13$

$$6. \left. \begin{array}{l} \frac{x+2}{3} + 8y = 31 \\ \frac{y+5}{4} + 10x = 192 \end{array} \right\} \begin{array}{l} \text{Clearing the fractions, we have} \\ x + 2 + 24y = 93 \\ y + 5 + 40x = 768 \end{array}$$

Or, $x + 24y = 91$

$40x + y = 763.$

Multiplying the first by 40,

$40x + 960y = 3640$

Subtracting, $959y = 2877, \therefore y = \frac{2877}{959} = 3$

$\therefore x = \frac{763 - y}{40} = \frac{760}{40} = 19.$

$$7. \left. \begin{array}{l} ax + by = 1 \\ a'x + b'y = 1 \end{array} \right\} \text{Equalizing the coefficients of } x, \text{ we have}$$

$aa'x + a'by = a'$

$aa'x + ab'y = a$

Subtracting, $(a'b - a'b')y = a - a'$

$\therefore y = \frac{a - a'}{a'b - a'b'}$

In like manner equalizing the coefficients of y ,

$ab'x + b'by = b'$

$a'bx + b'by = b$

Subtracting, $(a'b - ab')x = b - b'$

$\therefore x = \frac{b - b'}{a'b - ab'}$

$$8. \left. \begin{array}{l} ax + by = c \\ a'x + b'y = c' \end{array} \right\} \text{Equalizing the coefficients of } x, \text{ we have}$$

$aa'x + a'by = a'c$

$aa'x + ab'y = ac$

Subtracting, $(a'b - a'b')y = a'c - ac$

$\therefore y = \frac{a'c - ac}{a'b - a'b'}$

In like manner equalizing the coefficients of y , we have

$ab'x + b'by = b'c$

$a'bx + b'by = bc'$

Subtracting, $(a'b - ab')x = b'c - bc'$

$\therefore x = \frac{b'c - bc'}{a'b - ab'}$

ALGEBRAIC SOLUTIONS.

$$9. \left. \begin{array}{l} \frac{1}{x} - \frac{1}{y} = 12 \\ \frac{3}{x} + \frac{5}{y} = 24 \end{array} \right\} \text{Multiplying the first equation by 3, and then subtracting the second, we have,}$$

$$-\frac{8}{y} = 36 - 24 = 33\frac{1}{2}.$$

$$\text{Multiplying by } 7y, -56 = 233y, \therefore y = -\frac{56}{233}.$$

$$\text{Also, } \frac{1}{x} = 12 + \frac{1}{y} = 12 - \frac{233}{56} = \frac{439}{56}, \therefore x = \frac{56}{439}.$$

$$10. \left. \begin{array}{l} \frac{x+2}{5} - \frac{10-x}{3} - \frac{y-10}{4} = 0 \\ \frac{2(y+2)}{3} - \frac{2x+y}{8} - \frac{x+13}{4} = 0 \end{array} \right\} \text{Clearing fractions, these equations become,}$$

$$12x - 24 - 200 + 20x - 15y + 150 = 0$$

$$16y + 32 - 6x - 3y - 6x - 78 = 0.$$

$$\text{Transposing, } 32x - 15y = 74$$

$$-12x + 13y = 46.$$

Multiplying the first by 3, and the second by 8, we have,

$$96x - 45y = 222$$

$$-96x + 104y = 368$$

$$\text{Adding, } 59y = 590, \therefore y = 10$$

$$\text{and since } 13y - 46 = 12x, \therefore 130 - 46 = 12x, \therefore x = \frac{84}{12} = 7.$$

$$11. \left. \begin{array}{l} \frac{x+6}{x+4} = \frac{y+2}{y-2} \\ \frac{x+3}{x+1} = \frac{y-7}{y-13} \end{array} \right\} \text{Applying to these fractions the general principle at page 103, we have}$$

$$\frac{x+5}{1} = \frac{y}{2}, \therefore 2x + 10 = y$$

$$\frac{x+3}{1} = \frac{y-10}{3}, \therefore 3x + 9 = y - 10.$$

Equating the two expressions for y , we have

$$3x + 19 = 2x + 10, \therefore x = -9$$

$$\therefore y - 2x + 10 = -18 + 10 = -8.$$

$$12. \left. \begin{array}{l} x + y = 19 \\ x^2 - y^2 = 95 \end{array} \right\} \text{Dividing the second equation by the first, we have}$$

$$x - y = 5$$

$$\text{Also, } x + y = 19$$

$$\therefore \text{adding and subtracting, } 2x = 24, \text{ and } 2y = 14$$

$$\therefore x = 12, \text{ and } y = 7.$$

QUESTIONS IN SIMPLE EQUATIONS. PAGE 207.

1. Find a number such that if it be increased by one-half, one-third, and one-fourth of itself, the sum shall be 50.

ALGEBRAIC SOLUTIONS.

Let x be the number; then by the question,

$$x + \frac{x}{2} + \frac{x}{3} + \frac{x}{4} = 60.$$

Multiplying by 12, to clear the fractions,

$$12x + 6x + 4x + 3x = 600$$

$$\text{that is, } 25x = 600, \therefore x = 24.$$

Otherwise.—To avoid fractions, put $12x$ for the number; then by the question,

$$12x + 6x + 4x + 3x = 50,$$

$$\text{that is, } 25x = 50, \therefore x = 2, \therefore 12x = 24.$$

2. There is a fraction such that if 4 be added to the denominator, the value is $\frac{1}{4}$; and if 3 be added to the numerator the value is $\frac{3}{4}$: required the fraction.

Let the fraction be $\frac{x}{y}$; then by the question, $\frac{x}{y+4} = \frac{1}{4}$, and $\frac{x+3}{y} = \frac{3}{4}$

therefore clearing the fractions, $4x = y + 4$

$$4x + 12 = 3y$$

$$\text{Subtracting} \quad 12 = 2y - 4, \therefore 2y = 16, \therefore y = 8$$

$$\text{Also } x = \frac{y}{4} + 1 = 3, \therefore \text{the fraction is } \frac{3}{8}.$$

3. What number is that, such, that if it be increased by 7, the square root of the sum shall be equal to the square root of the number itself and 1 more?

Let x be the number, then the condition is that

$$\sqrt{x+7} = \sqrt{x} + 1$$

$$\text{Squaring,} \quad x + 7 = x + 2\sqrt{x} + 1$$

$$\text{Transposing,} \quad 6 = 2\sqrt{x}, \therefore 3 = \sqrt{x}, \therefore 9 = x; \text{ hence the number is 9.}$$

4. Fifty labourers are engaged to remove an obstruction on a railway; some of them are, by agreement, to receive ninepence each, and the others fifteen pence. Just £2 are paid to them; but, no memorandum having been made, it is required to find how many worked for 9d., and how many for 15d.

Suppose there are x workmen at 9d., and y at 15d., then the number of pence received by the former is $9x$, and the number received by the latter $15y$; and since by the question the number of pence paid altogether is $2 \times 20 \times 12 = 480$, we must have the equation

$$9x + 15y = 480$$

$$\text{Moreover,} \quad x + y = 50 \text{ by the question}$$

$$\therefore 9x + 9y = 450$$

$$\text{Subtracting,} \quad 6y = 30, \therefore y = 5, \therefore x = 45$$

Consequently, 5 of the labourers received 15d., and 45 received 9d.

Otherwise.—Let x be the number of labourers at 9d., then by the question $50 - x$ was the number at 15d.; consequently the former received $9x$ pence, and the latter $15(50 - x)$ pence; hence, as they received together 480 pence, we must have the equation

$$15(50 - x) + 9x = 480$$

$$\text{That is,} \quad 750 - 15x + 9x = 480$$

$$\text{Transposing,} \quad 270 = 6x, \therefore x = 45, \text{ and } 50 - x = 5$$

Consequently 45 received 9d. each, and 5 received 15d.

5. A person ordered a quantity of rum and brandy, for which he paid £19 4s.;

ALGEBRAIC SOLUTIONS.

the brandy was 9s. a quart and the rum 6s. He has, however, forgotten the exact number of each which he has to receive; but he remembers that if his brandy had been rum, and his rum brandy, his outlay would have been £1 13s. less. How many quarts of each did he buy?

Suppose he bought x quarts of rum and y quarts of brandy; then by the question the number of shillings paid for the two was $6x + 9y$; but if the brandy had been 6s. a quart and the rum 9s., the number of shillings paid would have been $9x + 6y$. The actual price paid was 384s.; the sum that would have been paid in the latter case, we are told, is 33s. less than this, that is 351s.; hence we have these two equations—*viz.*,

$$\begin{array}{r} 6x + 9y = 384 \\ 9x + 6y = 351 \end{array} \quad \begin{array}{r} 2x + 3y = 128 \\ 3x + 2y = 117 \end{array}$$

By adding these two equations, we have

$$5x + 5y = 245 \quad \therefore y + x = 49$$

By subtracting,

$$\frac{y - x = 11}{}$$

Therefore adding and subtracting,

$$2y = 60, \quad 2x = 38,$$

$\therefore x = 19$, and $y = 30$; so that he had 19 quarts of rum and 30 quarts of brandy.

Otherwise.—Suppose he had x quarts of rum; for this he paid $6x$ shillings by the question; therefore $384 - 6x$ is the number of shillings paid for the brandy; and as 1 quart of brandy cost 9s., the number of quarts must have been $\frac{384 - 6x}{9}$, or $\frac{128 - 2x}{3}$.

Now, by the question, if these quarts had cost 6s. each, and the x quarts 9s. each, the number of shillings paid would have been only 351. hence we have the equation

$$\frac{128 - 2x}{3} \times 6 + 9x = 351,$$

$$\text{or,} \quad 256 - 4x + 9x = 351,$$

$$\therefore 5x = 95, \quad \therefore x = 19, \text{ quarts of rum,}$$

$$\text{and} \quad \frac{128 - 2x}{3} = \frac{128 - 38}{3} = 30, \text{ quarts of brandy.}$$

It is plain that the former is the easier mode of solution; and it will usually be found that both thought and work are diminished when as many unknown symbols are employed in the solution of a question as there are distinct conditions embodied in that question. It is a mistake to suppose that it is always easier to solve a question with only one unknown quantity than with two, when two are implied in the conditions; the contrary is more frequently true. Some of the present examples will sufficiently show this.

6. A person has spirits at 12s. a gallon, and at £1 a gallon; how much of each must he take to make a gallon worth 14s.? Let the fractional part of a gallon at 12s be represented by x , and that of a gallon at 20s. by y ; then

$$x + y = 1,$$

and the price of the mixture = $12x + 20y = 14$, by the question.

Multiplying the first of these equations by 12, and subtracting

$$8y = 2. \quad y = \frac{1}{4}; \text{ and } x = 1 - y = \frac{3}{4}.$$

Consequently the mixture must consist of $\frac{3}{4}$ gallon at 20s., and $\frac{1}{4}$ gallon at 12s.

Otherwise.—Suppose he takes x gal. at 12s.; then he must take $1 - x$ at 20s.; the

ALGEBRAIC SOLUTIONS.

price of the former is $12x$ shillings, and that of the latter $20(1-x)$ shillings; therefore the price of the whole gallon of the mixture is

$$12x + 20 - 20x = 14, \text{ by the question.}$$

$$\text{Transposing, } 6 = 8x, \therefore \frac{3}{4} = x; \therefore y = 1 - x = \frac{1}{4},$$

so that there must be $\frac{3}{4}$ gal. at $12s.$, and $\frac{1}{4}$ gal. at $20s.$

7. A merchant has spirits at a shillings a gallon, and at b shillings a gallon; how much of each must he take to make a mixture of d gallons worth c shillings a gallon? Suppose he takes x gallons at a shillings, and y at b shillings; then the worth of the mixture of $x + y$ gallons—that is, of d gallons—is

$$ax + by = cd, \text{ by the question;}$$

$$\text{also } x + y = d.$$

$$\text{Mult. by } a, \quad \underline{ax + ay = ad}$$

$$\text{Subtract, } (a - b)y = (a - c)d, \therefore y = \frac{(a - c)d}{a - b}.$$

In like manner, multiplying by b , and subtracting,

$$(a - b)x = (c - b)d, \therefore x = \frac{(c - b)d}{a - b}.$$

Otherwise.—Suppose he take x gallons at a shillings, then by the question he must take $d - x$ gallons at b shillings: the price of the mixture is,

$$ax + b(d - x) = cd, \text{ by the question;}$$

$$\text{that is, } (a - b)x = (c - b)d, \therefore x = \frac{(c - b)d}{a - b}, \text{ gals. at } a \text{ shillings,}$$

$$\text{and } d - x = d - \frac{(c - b)d}{a - b} = \frac{(a - c)d}{a - b}, \text{ gals. at } b \text{ shillings.}$$

8. In a composition of a certain quantity of gunpowder, two-thirds of the whole + 10lbs. was nitre; one-sixth of the whole — $4\frac{1}{2}$ lbs. was sulphur; and the charcoal was one-seventh of the nitre, all but 2 lbs. How many lbs. of gunpowder were there?

Suppose there were x of gunpowder.

$$\text{then there were } \frac{2x}{3} + 10 \text{ of nitre}$$

$$\text{,, } \frac{x}{6} - 4\frac{1}{2} \text{ of sulphur}$$

$$\text{,, } \frac{1}{7}\left(\frac{2x}{3} + 10\right) - 2 \text{ of charcoal;}$$

consequently, adding the ingredients, we have

$$\frac{8}{7}\left(\frac{2x}{3} + 10\right) + \frac{x}{6} + 6\frac{1}{2} = x$$

or, multiplying by 6,

$$\frac{8}{7}(4x + 60) + x + 39 = 6x$$

$$\therefore \frac{8}{7}(4x + 60) - 39 = 5x.$$

Multiplying by 7,

$$32x + 480 + 273 = 35x$$

$$\therefore 207 = 3x, \therefore x = 69.$$

Consequently there were 69 lbs. of gunpowder.

ALGEBRAIC SOLUTIONS.

9. A farmer wishes to mix 28 bushels of barley, at 2s. 4d. a bushel, with rye at 3s. a bushel, and wheat at 4s. a bushel, so that the whole may make 100 bushels worth 3s. 4d. a bushel: how much rye and wheat must he use?

Suppose x bushels of rye, and y of wheat; then $x + y + 28$ must make 100.

Now the price of x bushels of rye is $36x$ pence

" y " wheat is $48y$ "

" 28 " barley is 28×28 pence

\therefore the price of the $x + y + 28$ bushels is $36x + 48y + 28 \times 28$ pence; which by the question is equal to 100×40 : hence we have

$$x + y + 28 = 100 \dots (1)$$

$$36x + 48y + 28 \times 28 = 100 \times 40$$

or, dividing the latter equation by 4,

$$9x + 12y + 28 \times 7 = 100 \times 10$$

that is, $9x + 12y + 196 = 1000 \dots (2)$.

Multiplying (1) by 9, $9x + 9y + 252 = 900$

Subtracting, $3y - 56 = 100$

$$\therefore y = \frac{156}{3} = 52$$

$$\therefore (1), x = 100 - 28 - y = 72 - 52 = 20.$$

Hence there must be 20 bushels of rye, and 52 bushels of wheat.

Otherwise.—Suppose there were x bushels of rye; then there must have been $100 - 28 - x$ bushels of wheat. The worth of the x bushels of rye is $36x$ pence, and the worth of the $72 - x$ bushels of wheat is $48(72 - x)$ pence; also the worth of the 28 bushels of barley is 28×28 pence. Hence, because the 100 bushels is worth 4000 pence, by the question, we have

$$36x + 48(72 - x) + 28 \times 28 = 4000$$

Dividing by 4, $9x + 12(72 - x) + 28 \times 7 = 1000$

that is, $-3x + 864 + 196 = 1000$

$$\therefore -3x = 1000 - 1060 = -60, \therefore x = 20, \text{ bushels of rye}$$

$$\therefore 100 - 28 - x = 72 - 20 = 52, \text{ bushels of wheat.}$$

This latter solution is perhaps somewhat easier than the former: you may vary both by employing shillings throughout instead of pence; representing the 2s. 4d. and the 3s. 4d. by $2\frac{1}{2}$ s., and $3\frac{1}{3}$ s. respectively.

10. Two persons, A and B, are engaged on a work which they can finish in 16 days; but after working together 4 days, A is called off; and B alone finishes it in 36 days more. In how many days could each do it separately? Suppose A can do it in x days, and B in y days: then in one day they can do the $\frac{1}{x}$ and the $\frac{1}{y}$ part respectively, and consequently in 16 days they can do $\frac{16}{x} + \frac{16}{y}$, which by the question, is the whole.

$$\therefore \frac{16}{x} + \frac{16}{y} = 1.$$

Also in 4 days they do the $\frac{4}{x} + \frac{4}{y}$ part, that is, the $\frac{1}{3}$ part; so that after that time the

ALGEBRAIC SOLUTIONS.

$\frac{1}{2}$ part remains to be done by B. Now in 1 day B does the $\frac{1}{48}$ part of this; that is the $\frac{1}{12}$ part of the whole; but he does the $\frac{1}{y}$ of the whole in 1 day; hence

$$\frac{1}{y} = \frac{1}{48}, \therefore y = 48$$

Substituting this value of y in the former equation, we have

$$\frac{16}{x} + \frac{16}{48} = 1$$

$$\therefore \frac{16}{x} = 1 - \frac{1}{3} = \frac{2}{3}, \therefore 2x = 48, \therefore x = 24.$$

Hence A can finish the work in 24 days, and B in 48 days.

Otherwise, without Algebra.—Since A and B have worked together 4 days, they can complete what is left in 12 days; and, therefore $\frac{1}{12}$ of it in 1 day, while B alone can do only the $\frac{1}{48}$ in 1 day; so that the part of it done by A in 1 day is

$$\frac{1}{12} - \frac{1}{48} = \frac{1}{18}$$

hence A is twice as good a workman as B, so that A and B together are as good as 3 B's; and, therefore, since 3 B's would do the whole in 16 days, one B would take 3 times as long, or 48 days; and, consequently, A would take 24 days—half the time.

Again, with one unknown quantity.—By the question A and B have done $\frac{1}{2}$ of the work before they separate, hence $\frac{1}{2}$ of it remains to be done. Suppose A can do the whole in x days, then in 1 day he can do $\frac{1}{x}$ of it; but A and B together do $\frac{1}{12}$ in a day; hence B's part in a day is $\frac{1}{12} - \frac{1}{x}$; but B's part is also $\frac{1}{48}$ of $\frac{1}{2}$; hence

$$\frac{1}{12} - \frac{1}{x} = \frac{1}{48}$$

$$\therefore \frac{1}{x} = \frac{1}{16} - \frac{1}{48} = \frac{1}{24}, \therefore x = 24, \text{ A's days.}$$

And since B does the $\frac{1}{48}$ part in 1 day, he can do the whole in 48 days.

11. A composition of copper and tin containing 100 cubic inches, weighed 505 ounces; how many ounces of each metal did it contain, supposing a cubic inch of copper to weigh $5\frac{1}{4}$ oz., and a cubic inch of tin to weigh $4\frac{1}{4}$ oz.?

Suppose there were x ounces of copper and y ounces of tin: then $x + y = 505$. Also by the question,

$$5\frac{1}{4}x + 4\frac{1}{4}y = 100, \therefore \frac{x}{21} + \frac{y}{17} = 25$$

$$\therefore 17x + 21y = 8925$$

Mult. 1st equa. by 17, $17x + 17y = 8585$

$$\text{Subtracting, } 4y = 340, \therefore y = 85$$

$$\therefore x = 505 - y = 505 - 85 = 420$$

Hence there were 420oz. of copper and 85oz. of tin.

This is solved with only one unknown quantity, by putting x for the number of ounces of copper, and $505 - x$ for the number of ounces of tin.

ALGEBRAIC SOLUTIONS.

12. A cask is supplied by three spouts, which can fill it in a minutes, b minutes, and c minutes, respectively; in what time will it be filled if all flow together?

Let x be the number of minutes, then the part of the whole supplied in 1 minute is

$$\frac{1}{x} = \frac{1}{a} + \frac{1}{b} + \frac{1}{c}, \text{ by the question,}$$

Clearing, $abc = (ab + ac + bc)x$

$$\therefore x = \frac{abc}{ab + ac + bc}$$

Questions of this kind may be treated rather differently, thus: since the first spout can fill the cask in a minutes, it can fill bc such casks in abc minutes. In like manner the second spout can fill ac such casks in abc minutes, and the third ab such casks in the same time; so that when all flow together, they can fill $ab + ac + bc$ casks in abc minutes, and, consequently, *one* cask in

$$\frac{abc}{ab + ac + bc} \text{ minutes.}$$

QUADRATIC EQUATIONS. EXAMPLES FOR EXERCISE. PAGE 212.

1. $x^2 - 4x = 45$. Completing the square,

$$x^2 - 4x + 4 = 49.$$

Extracting the root,

$$x - 2 = \pm 7,$$

$$\therefore x = 2 + 7 = 9 \text{ or } -5.$$

2. $x^2 + 8x = 33$. Completing the square,

$$x^2 + 8x + 16 = 49$$

Extracting the root,

$$x + 4 = \pm 7,$$

$$\therefore x = -4 \pm 7 = 3 \text{ or } -11.$$

3. $x^2 - 8x = 9$. Completing the square,

$$x^2 - 8x + 16 = 25.$$

Extracting the root,

$$x - 4 = \pm 5,$$

$$\therefore x = 4 \pm 5 = 9 \text{ or } -1.$$

4. $3x^2 + 2x = 161$. Dividing by 3, $x^2 + \frac{2}{3}x = \frac{161}{3}$.

Completing the square, $x^2 + \frac{2}{3}x + \frac{1}{9} = \frac{161}{3} + \frac{1}{9} = \frac{484}{9}$.

Extracting the root, $x + \frac{1}{3} = \pm \frac{22}{3}$,

$$\therefore x = -\frac{1}{3} \pm \frac{22}{3} = 7 \text{ or } -\frac{23}{3}.$$

Or, by Rule II., page 213,

$$3x^2 + 2x = 161, \therefore 6x + 2 = \sqrt{(1932 + 4)} = \sqrt{1936} = \pm 44,$$

$$\therefore x = \frac{-2 \pm 44}{6} = 7 \text{ or } -\frac{23}{3}.$$

ALGEBRAIC SOLUTIONS.

5 $7x^2 - 20x = 32$. Dividing by 7, $x^2 - \frac{20}{7}x = \frac{32}{7}$.

Completing the square, $x^2 - \frac{20}{7}x + \frac{100}{49} = \frac{32}{7} + \frac{100}{49} = \frac{324}{49}$

Extracting the root, $x - \frac{10}{7} = \sqrt{\frac{324}{49}} = \pm \frac{18}{7}$.

$\therefore x = \frac{10}{7} + \frac{18}{7} = 4$ or $-1\frac{1}{7}$.

Or, by Rule II., page 213,

$7x^2 - 20x = 32$, $\therefore 14x - 20 = \sqrt{(32 \times 28 + 400)} = + 36$,

$\therefore x = \frac{20 + 36}{14} = 4$, or $-1\frac{1}{7}$.

6 $x^2 - x - 170 = 40$, or $x^2 - x = 210$. Completing the square,

$x^2 - x + \frac{1}{4} = 210 + \frac{1}{4} = \frac{841}{4}$.

Extracting the root, $x - \frac{1}{2} = \sqrt{\frac{841}{4}} = + \frac{29}{2}$,

$\therefore x = \frac{1}{2} + \frac{29}{2} = 15$, or -14 .

Or, by Rule II., page 213,

$x^2 - x = 210$, $\therefore 2x - 1 = \sqrt{(840 + 1)} = + 29$,

$\therefore x = \frac{1 + 29}{2} = 15$, or -14 .

7 $5x^2 + 4x = 273$ Dividing by 5, $x^2 + \frac{4}{5}x = \frac{273}{5}$

Completing the square, $x^2 + \frac{4}{5}x + \frac{4}{25} = \frac{273}{5} + \frac{4}{25} = \frac{1369}{25}$.

Extracting the root, $x + \frac{2}{5} = \sqrt{\frac{1369}{25}} = + \frac{37}{5}$

$\therefore x = -\frac{2}{5} + \frac{37}{5} = 7$, or $-7\frac{1}{5}$

Or, by Rule II., page 213,

$5x^2 + 4x = 273$, $\therefore 10x + 4 = \sqrt{(273 \times 20 + 16)} = \sqrt{5476} = + 74$

$\therefore x = -\frac{4 + 74}{10} = 7$, or $-7\frac{1}{5}$

8 $4x^2 - x = 11$. Multiplying by 3, $4x^2 - x = 33$

Dividing by 4, $x^2 - \frac{1}{4}x = \frac{33}{4}$

Completing the square $x^2 - \frac{1}{4}x + \frac{1}{64} = \frac{33}{4} + \frac{1}{64} = \frac{529}{64}$

Extracting the root, $x - \frac{1}{8} = \sqrt{\frac{529}{64}} = + \frac{23}{8}$

$\therefore x = \frac{1}{8} + \frac{23}{8} = 3$, or $-2\frac{1}{4}$.

Or, by Rule II., page 213,

$4x^2 - x = 33$, $\therefore 8x - 1 = \sqrt{(33 \times 16 + 1)} = \sqrt{529} = + 23$,

ALGEBRAIC SOLUTIONS.

$$\therefore x = \frac{1 \pm 23}{8} = 3, \text{ or } -2\frac{1}{2}.$$

9. $x + \frac{7x-8}{x} = 9$. Multiplying by x , $x^2 + 7x - 8 = 9x$, $\therefore x^2 - 2x = 8$.

Completing the square, $x^2 - 2x + 1 = 9$.

Extracting the root, $x - 1 = \pm 3$, $\therefore x = 4$, or -2 .

10. $5x^2 + 3 = 4x + 159$, $\therefore 5x^2 - 4x = 156$. Dividing by 5,

$$x^2 - \frac{4}{5}x = \frac{156}{5}.$$

Completing the square,

$$x^2 - \frac{4}{5}x + \frac{4}{25} = \frac{156}{5} + \frac{4}{25} = \frac{784}{25}.$$

Extracting the root, $x - \frac{2}{5} = \sqrt{\frac{784}{25}} = \pm \frac{28}{5}$

$$\therefore x = \frac{2}{5} + \frac{28}{5} = 6, \text{ or } -5\frac{1}{5}.$$

Or, by Rule II., page 213,

$$5x^2 - 4x = 156, \therefore 10x - 1 = \sqrt{(156 \times 20 + 16)} = \sqrt{3136} = +56.$$

$$\therefore x = \frac{4 + 56}{10} = 6, \text{ or } -5\frac{1}{5}.$$

11. $6x + \frac{35-3x}{x} - 11 = 0$, or $6x + \frac{35}{x} - 3 - 44 = 0$; that is,

$$6x + \frac{35}{x} - 47 = 0. \text{ Multiplying by } x, 6x^2 + 35 - 47x = 0.$$

$$\therefore 6x^2 - 47x = -35. \text{ Dividing by } 6,$$

$$x^2 - \frac{47}{6}x = -\frac{35}{6}.$$

Completing the square,

$$x^2 - \frac{47}{6}x + \left(\frac{47}{12}\right)^2 = \frac{2209}{144} - \frac{35}{6} = \frac{1369}{144}.$$

Extracting the root,

$$x - \frac{47}{12} = \sqrt{\frac{1369}{144}} = \pm \frac{37}{12}$$

$$\therefore x = \frac{47}{12} \pm \frac{37}{12} = 7, \text{ or } \frac{5}{6}.$$

Or, by Rule II., page 213,

$$6x^2 - 47x = -35, \therefore 12x - 47 = \sqrt{(-35 \times 24 + 47^2)} = \sqrt{1369} = +37,$$

$$\therefore x = \frac{47 \pm 37}{12} = 7, \text{ or } \frac{5}{6}.$$

12. $\frac{x-2}{x+2} + \frac{x+2}{x-2} = 11$. Clearing the fractions,

$$x^2 - 4x + 4 + x^2 + 4x + 4 = 14(x^2 - 4).$$

Collecting and transposing, $64 = 12x^2$, $\therefore x = \sqrt{\frac{64}{12}} = \frac{4}{\sqrt{3}} = \frac{4}{3} \sqrt{3}$.

ALGEBRAIC SOLUTIONS.

13. $48x^{-2} + 32x^{-1} = 11$. Dividing by 48, $x^{-2} + \frac{2}{3}x^{-1} = \frac{11}{48}$.

Completing the square, $x^{-2} + \frac{2}{3}x^{-1} + \frac{1}{9} = \frac{11}{48} + \frac{1}{9} = \frac{49}{144}$.

Extracting the root, $x^{-1} + \frac{1}{3} = \pm \frac{7}{12}$.

$\therefore x^{-1}$, that is $\frac{1}{x} = -\frac{1}{3} \pm \frac{7}{12} = \frac{1}{4}$, or $-\frac{11}{12}$.

$\therefore x = 4$, or $-1\frac{1}{2}$.

Or, by Rule II., page 213,

$48x^{-2} + 32x^{-1} = 11$, $\therefore 96x^{-1} + 32 = \sqrt{(48 \times 44 + 32^2)} = \sqrt{3136} = \pm 56$,

$\therefore x^{-1} = \frac{1}{x} = \frac{-32 \pm 56}{96} = \frac{1}{4}$, or $-\frac{11}{12}$, $\therefore x = 4$, or $-1\frac{1}{2}$.

14. $x^4 - 40x^2 + 39 = 0$, or $(x^2)^2 - 40(x^2) = -39$.

Completing the square, $(x^2)^2 - 40(x^2) + 400 = 361$.

Extracting the root, $x^2 - 20 = \sqrt{361} = \pm 19$,

$\therefore x^2 = 20 + 19 = 1$ or 39 , $\therefore x = \pm 1$, or $\pm \sqrt{39}$.

15. $x^2 + ax + b = 0$, $\therefore x^2 + ax = -b$.

Completing the square, $x^2 + ax + \frac{1}{4}a^2 = \frac{1}{4}a^2 - b = \frac{a^2 - 4b}{4}$,

Extracting the root, $x + \frac{1}{2}a = \frac{\sqrt{(a^2 - 4b)}}{2}$

$\therefore x = \frac{-a \pm \sqrt{(a^2 - 4b)}}{2}$

This may be regarded as a general formula for the solution of any quadratic equation whatever; for by putting particular values for a and b in this result, we shall have the proper values of x in the quadratic to which those particular values of the coefficients belong. We further learn from this formula a few general principles well worthy of notice: thus,

1. In every quadratic, put into the form $x^2 + ax + b = 0$, if $a^2 = 4b$, the two roots, must be equal; since, in this case, the general form for the roots is $x = \frac{-a \pm 0}{2}$; so that each root is half the coefficient of x , taken with changed sign.

2. If a^2 is greater than $4b$, the two roots are unequal and real; for $a^2 - 4b$, under the radical, is in this case positive.

3. If a^2 is less than $4b$, the two roots must be imaginary; for then $a^2 - 4b$, under the radical, is negative.

Hence, by examining the coefficients of a quadratic, we may ascertain the character of its roots without actually solving the equation.

16. $\frac{x+a}{x-a} + \frac{x-a}{x+a} = b$. Clearing fractions,

$(x+a)^2 + (x-a)^2 = b(x^2 - a^2)$

It is, $2x^2 + 2a^2 = bx^2 - a^2b$

Transposing, $(b-2)x^2 = a^2(2+b)$,

$\therefore x^2 = \frac{a^2(b+2)}{b-2}$, $\therefore x = \pm a \sqrt{\frac{b+2}{b-2}}$.

ALGEBRAIC SOLUTIONS.

17. Put y for \sqrt{x} , then multiplying by 6, we have

$$3y^2 - 2y = 133,$$

$$\text{Dividing by 3, } y^2 - \frac{2}{3}y = \frac{133}{3}.$$

$$\text{Completing the square, } y^2 - \frac{2}{3}y + \frac{1}{9} = \frac{133}{3} + \frac{1}{9} = \frac{400}{9},$$

$$\text{Extracting the root, } y - \frac{1}{3} = \sqrt{\frac{400}{9}} = \pm \frac{20}{3}.$$

$$\therefore y = \frac{1}{3} \pm \frac{20}{3} = 7, \text{ or } -\frac{19}{3} = -6\frac{1}{3},$$

$$\therefore y^2 = x = 49, \text{ or } 40\frac{1}{9}.$$

Or, by Rule II., page 213,

$$\checkmark 3y^2 - 2y = 133, \therefore 6y - 2 = \sqrt{(1596 + 4)} = \sqrt{1600} = \pm 40,$$

$$\therefore y = \frac{2 \pm 40}{6} = 7, \text{ or } -6\frac{1}{3},$$

$$\therefore y^2 = x = 49, \text{ or } 40\frac{1}{9}.$$

18. $(3x - 2)(1 - x) = 4$; that is, $-3x^2 + x - 2 = 4$, $\therefore 3x^2 - x = -2$.

$$\text{Dividing by 3, } x^2 - \frac{1}{3}x = -\frac{2}{3},$$

$$\text{Completing the square, } x^2 - \frac{1}{3}x + \frac{1}{36} = \frac{1}{36} - \frac{2}{3} = -\frac{23}{36}$$

$$\text{Extracting the root, } x - \frac{1}{6} = \pm \frac{1}{6} \sqrt{-23},$$

$$\therefore x = \frac{1 \pm \sqrt{-23}}{6}.$$

19. $15x^2 - 48x + 45 = 0$, or $15x^2 - 48x = -45$. Dividing by 15,

$$x^2 - \frac{16}{5}x = -3.$$

$$\text{Completing the square, } x^2 - \frac{16}{5}x + \frac{64}{25} = \frac{64}{25} - 3 = -\frac{11}{25}.$$

$$\text{Extracting the root, } x - \frac{8}{5} = \frac{1}{5} \sqrt{-11}, \therefore x = \frac{8 \pm \sqrt{-11}}{5}.$$

We might have known, without actually solving either of the two equations in Examples 18 and 19, that the roots were imaginary, for these equations being $3x^2 - x + 2 = 0$, and $15x^2 - 48x + 45 = 0$, we see at once that four times the product of the extreme terms exceeds the square of the middle term. (See the principle 3, page 36.)

20. $\sqrt{\frac{x-2}{x+2}} + \sqrt{\frac{x+2}{x-2}} = 4$. Squaring, $\frac{x-2}{x+2} + 2 + \frac{x+2}{x-2} = 16$,

$$\therefore \frac{x-2}{x+2} + \frac{x+2}{x-2} = 14,$$

and this equation has already been solved in Example 12.

ALGEBRAIC SOLUTIONS.

QUESTIONS REQUIRING QUADRATIC EQUATIONS. PAGE 216.

1. Divide the number 33 into two such parts, that their product may be 162.
Let x be one part, then $33 - x$ is the other; and by the question,

$$33x - x^2 = 162; \text{ or } x^2 - 33x = -162,$$

$$\therefore \text{Rule II., } 2x - 33 = \sqrt{(1089 - 648)} = \sqrt{441} = +21,$$

$$\therefore x = \frac{33 + 21}{2} = 27, \text{ or } 6.$$

$$\therefore 33 - x = 6, \text{ or } 27.$$

Hence the parts are 6, and 27.

Otherwise.—Let the two parts be x and y ; then by the question

$$x + y = 33, \text{ and } xy = 162$$

$$\therefore x^2 + 2xy + y^2 = 1089$$

$$\text{And } 4xy = 648$$

$$\text{Subtracting, } x^2 - 2xy + y^2 = 441$$

$$\text{That is, } (x - y)^2 = 441, \therefore x - y = +21$$

$$\text{And since } x + y = 33$$

$$\therefore \text{adding and subtracting, } 2x = 33 + 21, \therefore x = 27 \text{ or } 6$$

$$2y = 33 + 21, \therefore y = 6 \text{ or } 27$$

2. Find two numbers whose difference is 9, and which are also such that their sum multiplied by the greater gives 266 for the product.

Let x be the greater number, then $x - 9$ is the less, and by the question, $(2x - 9)x = 266$; that is,

$$2x^2 - 9x = 266$$

$$\therefore \text{Rule II., } 4x - 9 = \sqrt{(2128 + 81)} = \sqrt{2209} = +47$$

$$\therefore x = \frac{9 + 47}{4} = 14, \text{ or } -\frac{19}{2} = -9\frac{1}{2}$$

$$\therefore x - 9 = 5, \text{ or } -18\frac{1}{2};$$

hence the numbers are either 5 and 14, or $-9\frac{1}{2}$ and $-18\frac{1}{2}$.

Otherwise.—Let x and y be the numbers; then by the question, $x - y = 9$, and $(x + y)x = 266$.

From the first of these equations, $x = y + 9$, \therefore by substitution in the second, $(2y + 9)(y + 9) = 266$; or

$$2y^2 + 27y + 81 = 266, \therefore 2y^2 + 27y = 185$$

$$\therefore \text{Rule II., } 4y + 27 = \sqrt{(1480 + 729)} = \sqrt{2209} = +47$$

$$\therefore y = \frac{-27 + 47}{4} = 5 \text{ or } -18\frac{1}{2}$$

$$\therefore x = y + 9 = 14, \text{ or } -9\frac{1}{2}$$

Or thus:

$$x - y = 9$$

$$x + y = \frac{266}{x}$$

Adding,

$$2x = 9 + \frac{266}{x}, \therefore 2x^2 - 9x = 266,$$

and the remaining steps as in the first solution.

ALGEBRAIC SOLUTIONS.

3. A company at a tavern had £7 4s. to pay; but two of them having left, the others had each 1s. more to pay than his fair share: how many persons were there at first?

Suppose there were x persons, then the fair share of each was $\frac{144}{x}$ shillings; but after two had left, the share to be paid by each of the others was $\frac{144}{x-2}$; and by the question,

$$\frac{144}{x-2} = \frac{144}{x} + 1$$

Clearing fractions, $144x = 144x - 288 + x^2 - 2x$

$\therefore x^2 - 2x = 288$, \therefore completing the square

$x^2 - 2x + 1 = 289$, \therefore extracting, $x - 1 = +17$, $\therefore x = 18$, or -16 .

Consequently there were 18 persons at first. The share of each was therefore 8s.; but when two had left, the share of each of the remaining 16 was 9s.

4. A purse contains 24 coins of silver and copper; each copper coin is worth as many pence as there are silver coins, and each silver coin is worth as many pence as there are copper coins; and the whole is worth 18s. how many are there of each?

Suppose there were x of one sort, and therefore $24 - x$ of the other: then the worth of the whole in pence is

$$(24 - x)x + (24 - x)x = 216, \text{ or } 2(24 - x)x = 216$$

$$\therefore 2x^2 - 48x = -216, \therefore x^2 - 24x = -108.$$

Completing the square, $x^2 - 24x + 144 = 36$, $\therefore x - 12 = +6$, $\therefore x = 18$, or -6 , $\therefore 24 - x = 6$ hence there were 18 silver coins and 6 copper coins, or 6 silver and 18 copper.

Otherwise.—Let the number of coins be x and y : then

$$x + y = 24, \text{ and } 2xy = 216$$

$$\therefore (x + y)^2 = 576, \text{ and } 4xy = 432.$$

Hence by subtraction, $(x - y)^2 = 144$, $\therefore x - y = \pm 12$.

\therefore by adding to and subtracting from the first equation, we have $2x = 36$, $2y = 12$; $\therefore x = 18$, $y = 6$.

The *negative* values are suppressed, because they are inadmissible, from the nature of the question.

5. Two messengers, A and B, were despatched to the same place, 90 miles distant. A, by riding one mile an hour more than B, arrives at his destination an hour before him. How many miles did each travel?

Suppose A travels x miles an hour, then he reaches his destination in $\frac{90}{x}$ hours; and B, by travelling 1 mile an hour more—that is, $x + 1$ miles an hour—reaches it in $\frac{90}{x+1}$ hours. And, by the question,

$$\frac{90}{x} = \frac{90}{x+1} + 1 \text{ or } \frac{90}{x} = \frac{91+x}{x+1}$$

Clearing fractions,

$$90x + 90 = 91x + x^2$$

Transposing,

$$x^2 + x = 90$$

ALGEBRAIC SOLUTIONS.

$$\therefore \text{Rule II., } 2x + 1 = \sqrt{(360 + 1)} = \sqrt{361} = \pm 19,$$

$$\therefore x = \frac{-1 \pm 19}{2} = 9, \therefore x + 1 = 10.$$

Hence A travels 9 miles an hour, and B 10 miles an hour. The negative value of x is suppressed, as it is excluded by the conditions of the question. You will observe that algebra gives *all* the values of the unknown quantity that can satisfy the *equation*: if there are any restrictions in the *question* embodied in that equation, the final results must, of course, conform to those restrictions.

6. A grocer sold 80 lbs. of mace and 100 lbs. of cloves for £65; but he sold 60 lbs. more of cloves for £20, than he did of mace for £10. What was the price of 1 lb. of each?

Suppose the price of the mace per lb. was x pounds, and that of the cloves y pounds; then by the question, $80x + 100y = 65$. Also, the number of lbs. of cloves for £20 is $\frac{20}{y}$, and of mace for £10 is $\frac{10}{x}$; and by the question, $\frac{20}{y} = \frac{10}{x} + 60$: hence, the two equations are

$$80x + 100y = 65, \therefore 16x + 20y = 13 \dots (1)$$

$$\text{and } \frac{20}{y} = \frac{10}{x} + 60, \therefore \frac{2}{y} - \frac{1}{x} = 6 \dots (2)$$

$$\text{Clearing the last of fractions, } \therefore 2x - y = 6xy \dots (3)$$

Substituting in (3) the expression for x given by (1)—viz., $x = \frac{13 - 20y}{16}$, it becomes

$$\therefore \frac{13 - 20y}{8} - y = \frac{39y - 60y^2}{8}$$

$$\text{Multiplying by 8, } \therefore 13 - 20y - 8y = 39y - 60y^2$$

$$\text{Transposing, } 60y^2 - 67y = -13$$

$$\therefore \text{Rule II., } 120y - 67 = \sqrt{(-13 \times 240 + 67^2)} = \sqrt{1369} = \pm 37$$

$$\therefore y = \frac{67 \pm 37}{120} = \frac{1}{4}, \text{ or } \frac{13}{15}$$

$\therefore x = \frac{13 - 20y}{16} = \frac{13 - 5}{16} = \frac{1}{2}$; the other value of x is negative: hence the price of 1 lb. of mace was £ $\frac{1}{2}$, or 10s., and of 1 lb. of cloves £ $\frac{1}{4}$, or 5s.

Otherwise. Multiply (1) and (2) together; we then have

$$32\frac{x}{y} - 20\frac{y}{x} - 16 + 40 = 78, \therefore 32\frac{x}{y} - 20\frac{y}{x} = 54,$$

$$\therefore 16\frac{x}{y} - 10\frac{y}{x} = 27.$$

$$\text{Multiplying (2) by } 8x, \quad 16\frac{x}{y} - 8 = 48x$$

$$\text{Subtracting, } \quad 10\frac{y}{x} - 8 = 48x - 27$$

$$\text{Dividing (1) by } 2x, \quad 8 + 10\frac{y}{x} = \frac{13}{2x}, \therefore 10\frac{y}{x} = \frac{13}{2x} - 8.$$

Hence, by substitution in the preceding equation,

$$\frac{13}{2x} - 16 = 48x - 27, \text{ or } \frac{13}{2x} = 48x - 11.$$

ALGEBRAIC SOLUTIONS.

Clearing the fraction,

$$96x^2 - 22x = 13, \therefore \text{Rule II., } 192x - 22 = \sqrt{(96 \times 52 + 22^2)} = + 74$$

$$\therefore x = \frac{22 + 74}{192} = \frac{1}{2}, \text{ or } -\frac{13}{48}$$

and, rejecting the negative value of x , we have from (1)

$$y = \frac{13 - 16x}{20} = \frac{13 - 8}{20} = \frac{1}{4}$$

Therefore, the price of 1 lb. of mace was £ $\frac{1}{2}$, or 10s.; and of 1 lb. of cloves £ $\frac{1}{4}$, or 5s., as before.

7. The product of two numbers is 240, and they are such that if one of them be increased by 4, and the other diminished by 3, the product of the results is still 240. Find the numbers.

Let x and y represent the numbers; then by the question,

$$xy = 240, \text{ and } (x + 4)(y - 3) = 240$$

$$\text{That is, } xy - 3x + 4y - 12 = 240$$

Subtracting this from the first equation, $3x - 4y + 12 = 0$, $\therefore x = \frac{4y - 12}{3}$

$$\therefore xy = \frac{4y^2 - 12y}{3} = 240, \therefore 4y^2 - 12y = 720$$

$$\therefore y^2 - 3y = 180, \therefore \text{Rule II., } 2y - 3 = \sqrt{(720 + 9)} = \pm 27$$

$$\therefore y = \frac{3 + 27}{2} = 15, \text{ or } -12$$

$$\therefore x = \frac{240}{y} = 16, \text{ or } -20.$$

Hence the numbers are either 16 and 15, or -20 and -12 .

8. A and B set out at the same time for a place 150 miles distant. A travels 3 miles an hour faster than B, and arrives at the place $8\frac{1}{3}$ hours before him. How many miles did each travel per hour?

Suppose A travels x miles per hour, then B travels $x - 3$ miles an hour; and the number of hours occupied by A is $\frac{150}{x}$, the number occupied by B is $\frac{150}{x - 3}$; but by the question, this latter number exceeds the former by $8\frac{1}{3}$,

$$\therefore \frac{150}{x} + 8\frac{1}{3} = \frac{150}{x - 3}$$

$$\text{Clearing fractions, } 450x - 1350 + 25x^2 - 75x = 450x$$

$$\text{Transposing, } 25x^2 - 75x = 1350, \therefore x^2 - 3x = 54,$$

$$\therefore \text{Rule II., } 2x - 3 = \sqrt{(216 + 9)} = \sqrt{225} = \pm 15$$

$$\therefore x = \frac{3 \pm 15}{2} = 9, \text{ or } -6,$$

$$\therefore x - 3 = 6.$$

Hence, A travels at the rate of 9 miles an hour, and B at the rate of 6 miles an hour.

9. What number is that the sum of whose digits is 15, and if 31 be added to their product, the digits will be transposed?

Let x and y denote the two digits; then the number is $10x + y$; and by the question

$$x + y = 15, \text{ and } xy + 31 = 10y + x.$$

From the first, $x = 15 - y$, $\therefore (15 - y)y + 31 = 10y + 15 - y$,

ALGEBRAIC SOLUTIONS.

That is, $15y - y^2 + 31 = 9y + 15$, $\therefore y^2 - 6y = 16$.

Completing the square,

$$y^2 - 6y + 9 = 25, \therefore y - 3 = \pm 5, \therefore y = 3 \pm 5 = 8, \text{ or } -2$$

$$\therefore x = 15 - y = 7.$$

Hence the number is 78.

10. There is a certain number consisting of two digits. The left-hand digit is equal to three times the right-hand one; and if 12 be subtracted from the number, the remainder will be equal to the square of the left-hand digit. What is the number?

Let x and y represent the two digits; then the number is $10x + y$. And by the question,

$$x = 3y, \text{ and } 10x + y - 12 = x^2$$

$$\therefore \text{by substitution, } 30y + y - 12 = 9y^2$$

$$\text{Transposing, } 9y^2 - 31y = -12$$

$$\therefore \text{Rule II, } 18y - 31 = \sqrt{(-36 \times 12 + 31^2)} = \sqrt{529} = +23$$

$$\therefore y = \frac{31 + 23}{18} = 3, \text{ or } \frac{4}{9}.$$

The fractional value must be rejected, $\therefore x = 3y = 9$; hence the number is 93.

Otherwise.—As above, $10x + y - 12 = x^2$, and $x = 3y = 0$.

$$\text{Multiplying the first by 3, } 30x + 3y - 36 = 3x^2$$

$$\text{Adding the second, } x - 3y = 0$$

$$\therefore 31x - 36 = 3x^2$$

Transposing, $3x^2 - 31x = -36$, \therefore Rule II, $6x - 31 = \sqrt{(-36 \times 12 + 31^2)} = +23$

$$\therefore x = \frac{31 + 23}{6} = 9, \therefore y = \frac{x}{3} = 3;$$

hence the number is 93.

ARITHMETICAL PROGRESSION. EXAMPLES FOR EXERCISE. PAGE 222.

1. Find the sum of sixteen terms of the series $1 + 2 + 3 + 4 + \&c.$

By the formula, $S = \frac{1}{2}n\{2a + (n-1)d\}$, where $a = 1$, $d = 1$, and $n = 16$.

Consequently $S = 8\{2 + 15\} = 136$, the sum required.

2. Find the sum of fourteen terms of the series $4 + 3 + 2 + 1 + 0 - 1 - 2 - \&c.$
Here $a = 4$, $d = -1$, and $n = 14$: hence

$$S = \frac{1}{2}n\{2a + (n-1)d\}$$

$$= 7\{8 - 13\} = -35, \text{ the sum.}$$

3. Sum the series $\frac{1}{2} + 1\frac{1}{2} + 2\frac{1}{2} + \&c.$ to twenty terms,

Here $a = \frac{1}{2}$, $d = 1$, and $n = 20$: therefore

$$S = \frac{1}{2}n\{2a + (n-1)d\}$$

$$= 10\{1 + 19\} = 200, \text{ the sum.}$$

4. Insert three arithmetical means between 2 and 0.

By the formula, $l = a + (n-1)d$, where $a = 2$, $n = 5$, $l = 0$.

$$\therefore 0 = 2 + 4d, \therefore d = -\frac{2}{4} = -\frac{1}{2}.$$

Hence, when the means are inserted, the series is

$$2, 1\frac{1}{2}, 1, \frac{1}{2}, 0.$$

ALGEBRAIC SOLUTIONS.

5. Insert five arithmetical means between $\frac{1}{3}$ and $-\frac{1}{3}$.

$$l = a + (n-1)d,$$

$$\therefore -\frac{1}{3} = \frac{1}{3} + 6d, \therefore d = -\frac{1}{9}.$$

Hence, when the means are inserted, the series is

$$\frac{1}{3}, \frac{2}{9}, \frac{1}{3}, 0, -\frac{1}{9}, -\frac{2}{9}, -\frac{1}{3}.$$

6. The first term is 5, and the fifteenth 47: what is the common difference?

$$l = a + (n-1)d,$$

$$\therefore 47 = 5 + 14d, \therefore d = \frac{42}{14} = 3.$$

7. How many terms of the series $12 + 11\frac{1}{2} + 11 + 10\frac{1}{2} + \&c.$, must be taken to make 55?

$$S = \frac{1}{2}n\{2a + (n-1)d\}$$

$$\therefore 55 = \frac{1}{2}n\{24 - (n-1)\frac{1}{2}\} = 12n - \frac{n^2}{4} = \frac{n}{4}$$

$$\therefore 220 = 49n - n^2, \therefore n^2 - 49n = -220$$

$$\therefore \text{Rule II., p. 213, } 2n - 49 = \sqrt{(49^2 - 880)} = \sqrt{1521} = +39,$$

$$\therefore n = \frac{49 + 39}{2} = 5, \text{ or } 44.$$

Hence, whether five terms or forty-four terms of the series be taken, the sum will be 55.

8. The first term of an arithmetical progression is 7, and the common difference $-\frac{3}{2}$: required the ninth term.

$$l = a + (n-1)d,$$

$$\therefore l = 7 - 8 \times \frac{3}{2} = 7 - 12 = -5, \text{ the ninth term.}$$

9. The sum of eight terms of an arithmetical series is 2, and the common difference $-1\frac{1}{2}$: required the first term.

$$S = \frac{1}{2}n\{2a + (n-1)d\}$$

$$\therefore 2 = 4\{2a - 7 \times 1\frac{1}{2}\}, \therefore 1 = 4a - 21,$$

$$\therefore 4a = 22, \therefore a = 5\frac{1}{2}, \text{ the first term.}$$

10. The first term of an arithmetical series is $-3\frac{1}{2}$, and the common difference $\frac{1}{2}$: required the sum of twenty-one terms.

$$S = \frac{1}{2}n\{2a + (n-1)d\}$$

$$\therefore S = \frac{21}{2}\{-6\frac{1}{2} + \frac{20}{2}\} = 21\{-3\frac{1}{2} + 2\}$$

$$= -70 + 42 = -28, \text{ the sum.}$$

GEOMETRICAL PROGRESSION. EXAMPLES FOR EXERCISE. PAGE 225.

1. Required the sum of five terms of the series,

$$1 + 2^2 + 2^4 + 2^8 + \&c.$$

$$l = ar^n - 1, S = \frac{rl - a}{r - 1}, \text{ where } a = 1, r = 4, n = 5,$$

$$\therefore l = 256, \therefore S = \frac{1024 - 1}{3} = 341, \text{ the sum.}$$

ALGEBRAIC SOLUTIONS.

2. Required the sum of eight terms of $1 - \frac{1}{2} + \frac{1}{4} - \frac{1}{8} + \&c.$

$$l = ar^{n-1}, S = \frac{r^l - a}{r-1}, \text{ where } a = 1, r = -\frac{1}{2}, n = 8,$$

$$\therefore l = -\frac{1}{128}, \therefore S = \frac{1 - \frac{1}{128}}{-\frac{1}{2}} = \frac{255}{128} \times \frac{2}{3} = \frac{85}{128} \text{ the sum.}$$

3. Required the sum of ten terms of $1 + 2 + 4 + 8 + \&c.$

$$l = ar^{n-1}, S = \frac{r^l - a}{r-1}, \text{ where } a = 1, r = 2, n = 10,$$

$$\therefore l = 512, \therefore S = \frac{1024 - 1}{1} = 1023, \text{ the sum.}$$

4. What is the geometrical mean between 6 and 54?

$$54 \times 6 = 324, \text{ and } \sqrt{324} = \pm 18, \text{ mean.}$$

Hence when the mean is inserted, the progression is either

$$6, 18, 54 \text{ or } 6, -18, 54,$$

the ratio in the former case being 3, and in the latter - 3.

5. Insert two geometrical means between 2 and 54. When the two means are inserted, there will be four terms, therefore $n = 4$; also $a = 2$, and $l = 54$; and we have to find r . By the formula, $l = ar^{n-1}$, $\therefore 54 = 2r^3$,

$$\therefore r^3 = 27, \therefore r = \sqrt[3]{27} = 3.$$

Hence, supplying the means, the progression is 2, 6, 18, 54.

6. Sum the series $\frac{1}{10} + \frac{1}{10^2} + \frac{1}{10^3} + \&c.$ to infinity.

$$\text{By the formula, } \Sigma = \frac{a}{1-r}, \therefore \Sigma = \frac{1}{10} \div \frac{9}{10} = \frac{1}{9}, \therefore .111 \dots = \frac{1}{9}.$$

7. The first term of a geometrical series is 3, the common ratio 5, and the last term 375: find the sum.

$$S = \frac{rl - a}{r-1}, \therefore S = \frac{1875 - 3}{4} = 468, \text{ the sum.}$$

8. The first term of a geometrical series is $\frac{5}{2}$, and the common ratio $-\frac{1}{5}$: find the sum to infinity.

$$\text{By the formula, } \Sigma = \frac{a}{1-r}, \therefore \Sigma = \frac{5}{2} \div \frac{6}{5} = 2\frac{1}{12}, \text{ the sum.}$$

9. Insert three geometrical means between $\frac{1}{2}$ and $\frac{2}{9}$. When the means are inserted there will be five terms, therefore $n = 5$; also $a = \frac{1}{2}$ and $l = \frac{2}{9}$; and we have to find r .

$$\text{By the formula, } l = ar^{n-1}, \therefore \frac{2}{9} = \frac{1}{2}r^4,$$

$$\therefore r^4 = \frac{4}{9}, \therefore r^2 = \pm \frac{2}{3}, \therefore r = \sqrt{\pm \frac{2}{3}}$$

Hence the progression is $\frac{1}{2}, \frac{1}{2} \sqrt{\pm \frac{2}{3}}, \frac{1}{3}, \pm \frac{1}{3} \sqrt{\pm \frac{2}{3}}, \frac{2}{9}$.

ALGEBRAIC SOLUTIONS.

10. Required the sum of the infinite series

$$1 + \frac{1}{x} + \frac{1}{x^2} + \frac{1}{x^3} + \&c.,$$

and then deduce Σ for $x = 2$, and $x = -2$,

$$\Sigma = \frac{a}{1-r}, \therefore \Sigma = 1 \div \left(1 - \frac{1}{x}\right) = \frac{x}{x-1}. \text{ When } x = 2, \Sigma = 2;$$

$$\text{when } x = -2, \Sigma = \frac{2}{3}.$$

QUESTIONS IN WHICH PROPORTION AND PROGRESSION ARE CONCERNED. PAGE 228.

1. Divide 49 into two parts, such, that the greater increased by 6, may be to the less diminished by 11, as 9 to 2.

Let x be the greater, then $49 - x$ is the less, and by the question

$$x + 6 : 38 - x :: 9 : 2.$$

Multiplying extremes and means, we have

$$2x + 12 = 342 - 9x, \therefore 11x = 330, \therefore x = 30,$$

$$\therefore 49 - x = 19 : \text{hence the two parts are 30 and 19.}$$

2. Two hundred stones are placed in a straight line, at intervals of 2 feet, the first stone being 20 yards in advance of a basket. Suppose a person, starting from the basket, collects the stones, and returns them, one by one, to the basket. How much ground does he go over?

Upon returning the first stone, he will have gone 40 yards; upon returning the second, 40 yards and 4 feet; upon returning the third, 40 yards and 8 feet, and so on; hence we have to find the sum of the arithmetical progression, following, each term being feet.

$$120 + 124 + 128 + 132 + \&c., \text{ to 200 terms.}$$

$$\text{By the formula, } S = \frac{1}{2}n\{2a + (n-1)d\}$$

$$\therefore S = 100\{240 + 199 \times 4\} = 103,600 \text{ feet,}$$

$$\text{and } 103,600 \text{ feet} = 34,533\frac{1}{3} \text{ yards} = 19\frac{1}{3} \text{ miles } 213\frac{1}{3} \text{ yards.}$$

3. The sum of four numbers in geometrical progression is equal to 1 added to the common ratio; and $\frac{1}{17}$ is the first term: required the numbers.

Let r be the common ratio, then since

$$S = a \frac{r^n - 1}{r - 1}, \therefore r + 1 = \frac{r^4 - 1}{17(r - 1)} = \frac{(r^2 - 1)(r^2 + 1)}{17(r - 1)}$$

$$\text{That is, } r + 1 = \frac{(r + 1)(r^2 + 1)}{17}, \therefore 17 = r^2 + 1, \therefore r^2 = 16, \therefore r = \pm 4;$$

Hence the progression is $\frac{1}{17}, \pm \frac{4}{17}, \frac{16}{17}, \pm \frac{64}{17}$; that is to say, either of the two progressions, following, will fulfil the conditions, namely,

$$\frac{1}{17}, \frac{4}{17}, \frac{16}{17}, \frac{64}{17},$$

$$\text{or, } \frac{1}{17}, -\frac{4}{17}, \frac{16}{17}, -\frac{64}{17}.$$

ALGEBRAIC SOLUTIONS.

4. From two towns, 165 miles apart, A and B set out to meet each other. A travels 1 mile the first day, 2 the second, 3 the third, and so on; B travels 20 miles the first day, 18 the second, 16 the third, and so on: in how many days will they meet?

Suppose they meet in n days, then

$$1 + 2 + 3 + \&c., \text{ to } n \text{ terms} = \frac{1}{2}n\{2 + (n - 1)\} = \text{A's distance}$$

$$\text{and } 20 + 18 + 16 + \&c., \text{ to } n \text{ terms} = \frac{1}{2}n\{40 - 2(n - 1)\} = \text{B's } ,,$$

$$\therefore \text{the sum of the distances} = \frac{1}{2}n\{42 - n + 1\} = 165$$

$$\therefore 42n - n^2 + n = 330, \therefore n^2 - 43n = -330,$$

$$\therefore \text{Rule II., page 213, } 2n - 43 = \sqrt{(43^2 - 1320)} = \sqrt{529} = \pm 23$$

$$\therefore n = \frac{13 \pm 23}{2} = 10, \text{ or } 33.$$

Hence they meet in 10 days. If it were a condition that B is to continue travelling after he meets and passes A, diminishing his distance by two miles daily, he will on the eleventh day travel 0 miles, and therefore on the twelfth day - 2 miles; that is, he will return back 2 miles, on the thirteenth day 4 miles, and so on. The second value of n above, shows that in 33 days B will in this way again come up with A, by overtaking him. In these 33 days A will have proceeded directly onwards to a distance of 561 miles, while B will have been following him for a distance of 396 miles, for B's whole distance is expressed by - 396; and $561 - 396 = 165$: so that the algebraic sum of the two distances still makes 165 miles; and the only condition implied in the algebraical statement of the question is, that the sum of the two distances shall be 165 miles.

5. The sum of the first and second of four numbers in geometrical progression is 15, and the sum of the third and fourth 60; what are the numbers?

Let the geometrical progression be

$$y^2, y^x, x, xy,$$

then, by the question, the conditions are

$$\frac{x}{y} + \frac{x}{y} = 15 \quad \dots (1),$$

$$\text{and } x + xy = 60 \quad \dots (2),$$

and since 4 times the first is equal to the second, we have, after dividing each by x ,

$$\frac{4}{y^2} + \frac{4}{y} = 1 + y, \therefore \frac{4}{y^2} - 1 = y - \frac{4}{y},$$

$$\text{or, which is the same thing, } \frac{4}{y^2} - 1 = -y\left(\frac{4}{y^2} - 1\right),$$

$$\text{that is, transposing, } (y + 1)\left(\frac{4}{y^2} - 1\right) = 0 \quad \dots (3).$$

Now a product is 0, whichever of the factors is 0; hence we must have either

$$y + 1 = 0, \text{ or } \frac{4}{y^2} - 1 = 0.$$

The first of these conditions cannot be admitted, because it is plain that, for $y = -1$, the equation (2), becoming $0 = 60$, is impossible: hence the condition which is to satisfy (3) is

$$\frac{4}{y^2} - 1 = 0, \therefore 4 - y^2 = 0, \therefore y^2 = 4, \therefore y = \pm 2,$$

ALGEBRAIC SOLUTIONS.

$$\therefore (2), x = \frac{60}{1+y} = \frac{60}{1+2} = 20, \text{ or } -60.$$

Hence the progression is either

$$5, 10, 20, 60, \text{ or } -15, 30, -60, 120.$$

6. The sum of three numbers in geometrical progression is 35; and the mean term is to the difference of the extremes as 2 to 3; what are the numbers?

Let the three numbers be $\frac{x}{y}$, x , and xy ; then by the question

$$\frac{x}{y} + x + xy = 35 \quad \dots (1),$$

$$\text{and } x : xy = \frac{x}{y} : 2 \cdot 3, \therefore 3x = 2(xy - \frac{x}{y}), \therefore 3 = 2y - \frac{2}{y} \quad \dots (2),$$

$$\therefore 3y = 2y^2 - 2, \therefore 2y^2 - 3y = 2,$$

$$\therefore \text{Rule II., page 213, } 4y - 3 = \sqrt{(16 + 9)} = \sqrt{25} = +5,$$

$$\therefore y = \frac{3+5}{4} = 2, \text{ or } -\frac{1}{2}.$$

Hence, (1) becomes

$$\frac{x}{2} + x + 2x = 35, \text{ or } -2x + x - \frac{x}{2} = 35,$$

$$\text{that is, } 3\frac{1}{2}x = 35, \text{ or } -1\frac{1}{2}x = 35,$$

$$\therefore x = 10, \text{ or } -23\frac{1}{2}.$$

Hence the numbers are either

$$5, 10, \text{ and } 20; \text{ or } 46\frac{2}{3}, -23\frac{1}{3}, \text{ and } 11\frac{2}{3},$$

both of which sets satisfy the conditions of the question.

EXTRACTION OF THE SQUARE ROOT. EXAMPLES FOR EXERCISE. PAGE 231.

1. $x^2 + 4bx + 4b^2 (\text{or } + 2b$

$$\begin{array}{r} x^2 \\ \underline{+} \\ 2x + 2b \end{array} \quad \begin{array}{r} 4bx + 4b^2 \\ \underline{4bx + 4b^2} \end{array}$$

2. $9x^4 + 12x^3 + 10x^2 + 4x + 1 (3x^2 + 2x + 1$

$$\begin{array}{r} 9x^4 \\ \underline{9x^4} \\ 12x^3 + 10x^2 \\ \underline{12x^3} \quad \quad \quad \underline{+ 4x^2} \\ 6x^2 + 4x + 1 \end{array} \quad \begin{array}{r} 12x^3 + 10x^2 \\ \underline{12x^3} \quad \quad \quad \underline{+ 4x^2} \\ 6x^2 + 4x + 1 \\ \underline{6x^2 + 4x + 1} \end{array}$$

3. $9x^4 + 12x^3 + 34x^2 + 20x + 25 (3x^2 + 2x + 5$

$$\begin{array}{r} 9x^4 \\ \underline{9x^4} \\ 12x^3 + 34x^2 \\ \underline{12x^3} \quad \quad \quad \underline{+ 4x^2} \\ 6x^2 + 4x + 5 \end{array} \quad \begin{array}{r} 12x^3 + 34x^2 \\ \underline{12x^3} \quad \quad \quad \underline{+ 4x^2} \\ 6x^2 + 4x + 5 \\ \underline{30x^2 + 20x + 25} \\ 30x^2 + 20x + 25 \end{array}$$

ALGEBRAIC SOLUTIONS.

$$4. \quad \begin{array}{r} x^6 + 4x^5 + 2x^4 + 0x^3 + 9x^2 - 4x + 4 \\ \underline{x^6} \end{array} + 2x^2 - x + 2$$

$$2x^3 + 2x^2) \quad \begin{array}{r} 4x^5 + 2x^4 \\ \underline{4x^5 + 4x^4} \end{array}$$

$$2x^3 + 4x^2 - x) \quad \begin{array}{r} -2x^4 + 0x^3 + 9x^2 \\ \underline{-2x^4 - 4x^3 + x^2} \end{array}$$

$$2x^3 + 4x^2 - 2x + 2) \quad \begin{array}{r} 4x^3 + 8x^2 - 4x + 4 \\ \underline{4x^3 + 8x^2 - 4x + 4} \end{array}$$

$$5. \quad \begin{array}{r} x^6 - 4x^5 + 10x^4 - 4x^3 - 7x^2 + 24x + 16 \\ \underline{x^6} \end{array} (x^2 - 2x + 3x + 4$$

$$2x^3 - 2x^2) \quad \begin{array}{r} -4x^5 + 10x^4 \\ \underline{-4x^5 + 4x^4} \end{array}$$

$$2x^3 - 4x^2 + 3x) \quad \begin{array}{r} 6x^4 - 4x^3 - 7x^2 \\ \underline{6x^4 - 12x^3 + 9x^2} \end{array}$$

$$2x^3 - 4x^2 + 6x + 4) \quad \begin{array}{r} 8x^3 - 16x^2 + 24x + 16 \\ \underline{8x^3 - 16x^2 + 24x + 16} \end{array}$$

$$6. \quad \begin{array}{r} 4x^4 + 6x^3 + \frac{89}{4}x^2 + 15x + 25 \\ \underline{4x^4} \end{array} (2x^2 + \frac{3}{2}x + 5$$

$$4x^2 + \frac{3}{2}x) \quad \begin{array}{r} 6x^3 + \frac{89}{4}x^2 \\ \underline{6x^3 + \frac{9}{4}x^2} \end{array}$$

$$4x^2 + 3x + 5) \quad \begin{array}{r} 80x^2 + 15x + 25 \\ \underline{80x^2 + 15x + 25} \end{array}$$

Otherwise. $-16x^4 + 24x^3 + 89x^2 + 60x + 100(4x^2 + 3x + 10$
 $16x^4 \quad \dots \text{Root} = 2x^2 + \frac{3}{2}x + 5$

$$8x^2 + 3x) \quad \begin{array}{r} 24x^3 + 89x^2 \\ \underline{24x^3 + 9x^2} \end{array}$$

$$8x^2 + 6x + 10) \quad \begin{array}{r} 80x^2 + 60x + 100 \\ \underline{80x^2 + 60x + 100} \end{array}$$

SQUARE ROOT OF A BINOMIAL SURD. EXAMPLES FOR EXERCISE. PAGE 234.

1. Put $\sqrt{19 + 8\sqrt{3}} = x + y$, $\therefore \sqrt{19 - 8\sqrt{3}} = x - y$. Taking the product,

$$\begin{aligned} \sqrt{(361 - 192)} &= x^2 - y^2; \text{ that is, } 13 = x^2 - y^2. \text{ Also,} \\ 19 + 8\sqrt{3} &= x^2 + 2xy + y^2, \quad \therefore 19 = x^2 + y^2 \\ &\therefore 32 = 2x^2, 6 = 2y^2 \\ \therefore x^2 &= 16, \therefore x = 4; y^2 = 3, \therefore y = \sqrt{3} \\ \therefore \sqrt{19 + 8\sqrt{3}} &= 4 + \sqrt{3}. \end{aligned}$$

2. $\sqrt{12 - \sqrt{140}} = x - y$, $\therefore \sqrt{12 + \sqrt{140}} = x + y$. Taking the product,

$$\begin{aligned} \sqrt{(144 - 140)} &= x^2 - y^2; \text{ that is, } 2 = x^2 - y^2. \\ \text{Also, } 12 - \sqrt{140} &= x^2 - 2xy + y^2, \therefore 12 = x^2 + y^2 \\ &\therefore 14 = 2x^2, 10 = 2y^2 \\ \therefore x^2 &= 7, \therefore x = \sqrt{7}; y^2 = 5, \therefore y = \sqrt{5} \\ \therefore \sqrt{12 - \sqrt{140}} &= \sqrt{7} - \sqrt{5}. \end{aligned}$$

3. $\sqrt{7 - 2\sqrt{10}} = x - y$, $\therefore \sqrt{7 + 2\sqrt{10}} = x + y$. Taking the product,

$$\begin{aligned} \sqrt{(49 - 40)} &= x^2 - y^2; \text{ that is, } 3 = x^2 - y^2 \\ \text{Also, } 7 - 2\sqrt{10} &= x^2 - 2xy + y^2, \therefore 7 = x^2 + y^2 \\ &\therefore 10 = 2x^2, 4 = 2y^2 \\ \therefore x^2 &= 5, \therefore x = \sqrt{5}; y^2 = 2, \therefore y = \sqrt{2} \\ \therefore \sqrt{7 - 2\sqrt{10}} &= \sqrt{5} - \sqrt{2}. \end{aligned}$$

4. $\sqrt{8 + \sqrt{39}} = x + y$, $\therefore \sqrt{8 - \sqrt{39}} = x - y$. Taking the product,

$$\begin{aligned} \sqrt{(64 - 39)} &= x^2 - y^2; \text{ that is, } 5 = x^2 - y^2 \\ \text{Also, } 8 + \sqrt{39} &= x^2 + 2xy + y^2, \therefore 8 = x^2 + y^2 \\ &\therefore 13 = 2x^2, 3 = 2y^2 \\ \therefore x^2 &= \frac{13}{2}, \therefore x = \frac{1}{2}\sqrt{26}; y^2 = \frac{3}{2}, \therefore y = \frac{1}{2}\sqrt{6} \\ \therefore \sqrt{8 + \sqrt{39}} &= \frac{1}{2}(\sqrt{26} + \sqrt{6}). \end{aligned}$$

5. $\sqrt{76 - 32\sqrt{3}} = x - y$, $\therefore \sqrt{76 + 32\sqrt{3}} = x + y$. Taking the product,

$$\begin{aligned} \sqrt{(5776 - 3072)} &= x^2 - y^2; \text{ that is, } 52 = x^2 - y^2. \\ \text{Also } 76 - 32\sqrt{3} &= x^2 - 2xy + y^2, \therefore 76 = x^2 + y^2 \\ &\therefore 128 = 2x^2, 24 = 2y^2; \\ \therefore x^2 &= 64, \therefore x = 8; y^2 = 12, \therefore y = 2\sqrt{3}, \\ \therefore \sqrt{76 - 32\sqrt{3}} &= 8 - 2\sqrt{3}. \end{aligned}$$

6. $\sqrt{31 + 12\sqrt{-5}} = x + y$, $\therefore \sqrt{31 - 12\sqrt{-5}} = x - y$. Taking the product,

$$\begin{aligned} \sqrt{(961 + 720)} &= x^2 - y^2; \text{ that is, } 41 = x^2 - y^2. \\ \text{Also } 31 + 12\sqrt{-5} &= x^2 + 2xy + y^2, \therefore 31 = x^2 + y^2 \\ &\therefore 72 = 2x^2, 10 = -2y^2; \\ \therefore x^2 &= 36, \therefore x = 6; y^2 = -5, \therefore y = \sqrt{-5}, \\ \therefore \sqrt{31 + 12\sqrt{-5}} &= 6 + \sqrt{-5}. \end{aligned}$$

ALGEBRAIC SOLUTIONS.

TO RATIONALIZE BINOMIAL SURDS. EXAMPLES FOR EXERCISE. PAGE 235.

1. Prove that $\frac{3}{2\sqrt{7}-3\sqrt{2}} = \frac{3}{10}(2\sqrt{7}+3\sqrt{2})$.

Multiplying numerator and denominator by $2\sqrt{7}+3\sqrt{2}$,

$$\frac{3}{2\sqrt{7}-3\sqrt{2}} = \frac{3(2\sqrt{7}+3\sqrt{2})}{28-18} = \frac{3}{10}(2\sqrt{7}+3\sqrt{2}).$$

2. Prove that $\frac{2+\sqrt{3}}{3+\sqrt{3}} = \frac{3+\sqrt{3}}{6}$. Multiplying the terms by $3-\sqrt{3}$,

$$\frac{2+\sqrt{3}}{3+\sqrt{3}} = \frac{(2+\sqrt{3})(3-\sqrt{3})}{6} = \frac{3+\sqrt{3}}{6}.$$

3. Prove that $\frac{\sqrt{6}}{\sqrt{8}+\sqrt{3}} = \frac{4\sqrt{3}-3\sqrt{2}}{5}$

$$\frac{\sqrt{6}}{\sqrt{8}+\sqrt{3}} = \frac{\sqrt{6} \times (\sqrt{8}-\sqrt{3})}{(\sqrt{8}+\sqrt{3})(\sqrt{8}-\sqrt{3})} = \frac{\sqrt{48}-\sqrt{18}}{5} = \frac{4\sqrt{3}-3\sqrt{2}}{5}.$$

4. Prove that $\frac{2}{\sqrt[3]{3}-\sqrt[3]{2}} = 2(\sqrt[3]{9}+\sqrt[3]{6}+\sqrt[3]{4})$.

$$\begin{aligned} \frac{2}{\sqrt[3]{3}-\sqrt[3]{2}} &= \frac{2(\sqrt[3]{9}+\sqrt[3]{6}+\sqrt[3]{4})}{(\sqrt[3]{3}-\sqrt[3]{2})(\sqrt[3]{9}+\sqrt[3]{6}+\sqrt[3]{4})} = \frac{2(\sqrt[3]{9}+\sqrt[3]{6}+\sqrt[3]{4})}{3-2} \\ &= 2(\sqrt[3]{9}+\sqrt[3]{6}+\sqrt[3]{4}). \end{aligned}$$

5. Prove that $\frac{5}{\sqrt[3]{7}-\sqrt[3]{5}} = \frac{5}{2}(\sqrt[3]{49}+\sqrt[3]{35}+\sqrt[3]{25})$.

Multiplying numerator and denominator by $\sqrt[3]{49}+\sqrt[3]{35}+\sqrt[3]{25}$, we have

$$\frac{5}{\sqrt[3]{7}-\sqrt[3]{5}} = \frac{5(\sqrt[3]{49}+\sqrt[3]{35}+\sqrt[3]{25})}{7-5} = \frac{5}{2}(\sqrt[3]{49}+\sqrt[3]{35}+\sqrt[3]{25}).$$

6. Prove that $\frac{\sqrt{12}-\sqrt{10}}{\sqrt{6}+\sqrt{5}} = 11\sqrt{2}-4\sqrt{15}$. Multiplying numerator and denominator by $\sqrt{6}-\sqrt{5}$,

$$\begin{aligned} \frac{\sqrt{12}-\sqrt{10}}{\sqrt{6}+\sqrt{5}} &= \frac{(\sqrt{12}-\sqrt{10})(\sqrt{6}-\sqrt{5})}{6-5} = \sqrt{72}-2\sqrt{60}+\sqrt{50} \\ &= 6\sqrt{2}-4\sqrt{15}+5\sqrt{2} = 11\sqrt{2}-4\sqrt{15}. \end{aligned}$$

ALGEBRAIC SOLUTIONS.

EXTRACTION OF THE CUBE ROOT. PAGE 240.

1.	0	0	$x^6 + 9x^5 + 6x^4 - 99x^3 - 42x^2 + 441x - 343(x^2 + 3x - 7)$	
	x^2	x^4	x^6	
	<hr/>	<hr/>	<hr/>	
	x^2	x^4	$9x^5 + 6x^4 - 99x^3$	
	x^3	$2x^4$	$9x^5 + 27x^4 + 27x^3$	
	<hr/>	<hr/>	<hr/>	
	$2x^2$	$3x^4$	$-21x^4 - 126x^3 - 42x^2 + 441x - 343$	
	x^2	$9x^3 + 9x^2$	$-21x^4 - 126x^3 - 42x^2 + 441x - 343$	
	<hr/>	<hr/>	<hr/>	
	$3x^2$	$3x^4 + 9x^3 + 9x^2$		
	$3x$	$9x^3 + 18x^2$		
	<hr/>	<hr/>		
	$3x^2 + 3x$	$3x^4 + 18x^3 + 27x^2$		
	$3x$	$-21x^4 - 63x + 49$		
	<hr/>	<hr/>		
	$5x^2 + 6x$	$3x^4 + 18x^3 + 6x^2 - 63x + 49$		
	$3x$			
	<hr/>			
	$3x^2 + 9x$			
	<hr/>			
	-7			
	<hr/>			
	$3x^2 + 9x - 7$			
	<hr/>			

(See the NOTE appended to the last example in this Key).

Hence the cube-root of the proposed polynomial is $x^2 + 3x - 7$.

2.	0	0	$x^6 + 6x^5 + 0x^4 - 40x^3 + 0x^2 + 96x - 64(x^2 + 2x - 4)$	
	x^2	x^4	x^6	
	<hr/>	<hr/>	<hr/>	
	x^2	x^4	$6x^5 + 0x^4 - 40x^3$	
	x^2	$2x^4$	$6x^5 + 12x^4 + 8x^3$	
	<hr/>	<hr/>	<hr/>	
	$2x^2$	$3x^4$	$-12x^4 - 48x^3 + 0x^2 + 96x - 64$	
	x^2	$6x^3 + 4x^2$	$-12x^4 - 48x^3 + 0x^2 + 96x - 64$	
	<hr/>	<hr/>	<hr/>	
	$3x^2$	$3x^4 + 6x^3 + 4x^2$		
	$2x$	$6x^3 + 8x^2$		
	<hr/>	<hr/>		
	$3x^2 + 2x$	$3x^4 + 12x^3 + 12x^2$		
	$2x$	$-12x^2 - 24x + 16$		
	<hr/>	<hr/>		
	$3x^2 + 4x$	$3x^4 + 12x^3 + 0x^2 - 24x + 16$		
	$2x$			
	<hr/>			
	$3x^2 + 6x$			
	<hr/>			
	-4			
	<hr/>			
	$3x^2 + 6x - 4$			
	<hr/>			

Hence the cube root is $x^2 + 2x - 4$.

ALGEBRAIC SOLUTIONS.

3.	0	0	12,994,449,551(2351, the cube-root
	2	4	8
	—	—	— 1
	2	4	4994
	2	8	4167
	—	— 1	— 2
	4	12	827449
	2	189	810875
	— 1	—	— 3
	6	1389	16574551
	3	198	16574551
	—	— 2	—
	63	1587	
	3	3475	
	—	—	
	66	162175	
	3	3500	
	— 2	— 3	
	69	165675	
	5	7051	
	—	—	
	695	16574551	
	5	—	
	—	—	
	700		
	5		
	— 3		
	705		
	— 1		
	—		
	7051		
	—		

In this method of extracting the cube root, all abridgment of the work has been disregarded, in order that the operation may be exhibited in the fullest detail. Those who are desirous of seeing it in a more compact form, may consult the author's "Analysis and Solution of Cubic and Biquadratic Equations."

In the example next following, the decimals of the root are interminable, since 2 is not an exact cube; it is required to approximate to the cube root as far as eleven or twelve places of decimals only; so that there is no necessity, in carrying on the work of development, to make any provision for decimals beyond this prescribed limit; and, accordingly, in the operation on next page, the decimals in the several columns have been restrained from accumulating to an unnecessary extent. You will, of course, remember that in multiplying a number abridged of final decimals, the *carryings* from the rejected decimals are to be taken account of, as noticed at page 240,

ALGEBRAIC SOLUTIONS.

4.	0	0	2 (1.25992104989 . . . , the cube-root.
	1	1	1
	—	—	— 1
	1	1	1
	1	2	.728
	—	3 1	— 2
	2	3	.272
	1	.64	.225125
	— 1	—	— 3
	3	3.64	46875
	.2	.68	42491979
	—	— 2	— 4
	3.2	4.32	4383021
	.2	.1825	4282778799
	—	—	— 5
	3.4	4.5025	100242201
	.2	.1850	95242392
	— 2	— 3	—
	3.6	4.6875	4999809
	5	33831	4762199
	—	—	—
	3.65	4.721331	237610
	5	33912	190488
	—	— 4	—
	3.70	4.755243	47122
	5	340011	42860
	— 3	—	—
	3.75	4.75864311	4262
	9	340092	3810
	—	— 5	—
	3.759	4.76204403	452
	9	7559	429
	—	—	—
	3.768	4.7621196,2	23
	9	756	
	— 4	—	
	3.777	4.7621952	
	9	38	
	—	—	
	3.7779	4.762199,0	
	9	4	
	—	—	
	3.7788	4.7,6,2,2,03	
	9		
	— 5	—	
	3.7,7,9,7		

Hence the cube-root of 2, true as far as eleven places of decimals, is $\sqrt[3]{2} = 1.25992104989$. In the third column of the work, the decimals have not been allowed to accumulate after the step marked 5, since more decimals, to the right of those furnished at that step, would have been superfluous, if only eleven or twelve decimals are required in the root; and, in order to provide against this unnecessary increase of decimals, the two preceding columns are curtailed of the decimals which are foreseen

ALGEBRAIC SOLUTIONS.

to contribute only to that portion of the third column thus rejected. Another decimal—viz., 4, or 5 very nearly—might obviously have been added to those already in the root; so that we may with safety affirm that $\sqrt[3]{2} = 1.259921049895$ is true, to the nearest unit, in the twelfth place of decimals. Had the suppression of additional decimals been postponed till another step of the work had been reached, we should have found

$$\sqrt[3]{2} = 1.259921049894873 \dots$$

which is true as far as fifteen places of decimals.

Such an extent of figures is very rarely, if ever, required in actual practice, and they have been given here merely to show the accuracy with which a cube root may be extracted by the foregoing contracted method.

5.	0	0	959(9.8614218
	9	81	729
	<hr/>	<hr/>	<hr/>
	9	81	230
	9	162	212.192
	<hr/>	<hr/>	<hr/>
	18	243	17.808
	9	22.24	17.393256
	<hr/>	<hr/>	<hr/>
	1		
	27	265.24	.414744
	.8	22.88	.291688
	<hr/>	<hr/>	<hr/>
	27.8	288.12	.123056
	.8	1.7676	.116692
	<hr/>	<hr/>	<hr/>
	28.6	289.8876	6364
	.8	1.7712	6835
	<hr/>	<hr/>	<hr/>
	2		
	29.4	291.6588	529
	6	296	292
	<hr/>	<hr/>	<hr/>
	29.46	291.688,4	237
	6	30	233
	<hr/>	<hr/>	<hr/>
	29.52	291.718	4
	6	12	
	<hr/>	<hr/>	<hr/>
	3		
	2,9,5,8	291.73,0	
		1	
		<hr/>	
		29,1,7,4	

Hence, the cube-root of 959 is 9.8614218, true to seven places of decimals.

6. To find the cube root of

$$x^6 - 15x^5y + 69x^4y^2 - 138x^3y^3 + 60xy^5 - 8x^6$$

From this expression a term was accidentally omitted; but as it is instructive to deal with it as it is, the wanting term is purposely left unsupplied, and the work carried on as in next page.

ALGEBRAIC SOLUTIONS.

0	0	$x^6 - 15x^4y + 69x^4y^2 - 138x^2y^4 - 60xy^5 - 8x^6(x^2 - 5xy - 2y^2)$
x^2	x^4	x^6
<hr/>	<hr/>	<hr/>
x^2	x^4	$-15x^4y + 69x^4y^2 + 0x^2y^3$
x^2	$2x^4$	$-15x^4y + 75x^4y^2 - 125x^2y^3$
<hr/>	<hr/>	<hr/>
$2x^2$	$3x^4$	$-6x^4y^2 + 125x^2y^3 - 138x^2y^4 - 60xy^5 - 8x^6$
x^2	$-15x^2y + 25x^2y^2$	$-6x^4y^2 + 60x^2y^3 - 138x^2y^4 - 60xy^5 - 8x^6$
<hr/>	<hr/>	<hr/>
$3x^2$	$3x^4 - 15x^2y + 25x^2y^2$	$65x^2y^3$
$-5xy$	$-15x^2y + 50x^2y^2$	
<hr/>	<hr/>	
$3x^2 - 5xy$	$3x^4 - 30x^2y + 75x^2y^2$	
$-5xy$	$-6x^2y^2 + 30xy^3 + 4y^4$	
<hr/>	<hr/>	
$3x^2 - 10xy$	$3x^4 - 30x^2y + 69x^2y^2 + 30xy^3 + 4y^4$	
$-5xy$		
<hr/>		
$3x^2 - 15xy$	$-2y^2$	
<hr/>		
$3x^2 - 15xy - 2y^2$		

Hence the cube-root of the proposed polynomial is $x^2 - 5xy - 2y^2$, with $65x^2y^3$ for remainder; so that the expression proposed differs by $65x^2y^3$ from the complete cube of $x^2 - 5xy - 2y^2$. If the remainder be introduced, with changed sign, into the polynomial, it will then become a complete cube: that is,

$$\begin{aligned} x^6 - 15x^4y + 69x^4y^2 - 65x^2y^3 - 138x^2y^4 - 60xy^5 - 8x^6 \\ = (x^2 - 5xy - 2y^2)^3. \end{aligned}$$

And in this way we may always ascertain what expression must be introduced into a proposed polynomial, in order to render it a complete cube.

NOTE.—The process adopted above, in imitation of that at page 237 of the Algebra, occupies a good deal more space than the work by the old method; but it must be observed that *here* there are no bye-operations: the whole is placed fairly before the eye, and every step may be performed with great ease and rapidity, and may be readily revised in case of mistake, advantages not to be overlooked.

[End of the Solutions to the Examples for Exercise.]

◆

The solutions now completed will, I think, afford to the learner all the aid he can reasonably expect in his efforts to make himself acquainted with the PRINCIPLES OF ALGEBRA. Wherever his own attempts to accomplish the satisfactory solution of a question fail, he will find it of much service to him to have at his command the assistance here offered; and even when his endeavours are successful, he will often gain instruction by comparing his own work with the details thus given. In the expectation that the present collection of solutions will be consulted with a view to such instruction, I have frequently given different methods of working out the same example, and of thus exhibiting certain algebraical artifices and expedients—familiar

ALGEBRAIC SOLUTIONS.

enough to proficient, but which can be acquired by a learner only by practice, and the careful examination of illustrative models. No one can become an algebraist by *Rule*: all that rules can do is to dictate the mode of applying general principles; while, in many special cases, independent judgment and ingenuity must be exercised, in reference to the particular circumstances of the inquiry, in order to avoid an unnecessary accumulation of symbols, and a needless outlay of time and trouble:—in fact, in order to give to the algebraic process that compactness of form, and neatness of finish, which constitute what is called an elegant solution. This mastery over his subject the student can acquire only by consulting the best models, and by cultivating the power, himself, of proceeding under the guidance of his own free judgment and penetration, unfettered by the shackles of *rules*. A learner should always be on the look-out for those facilitating expedients, which are often to be brought into operation in cases, in reference to which rules can afford but imperfect guidance; he would do well, however, to keep in remembrance that a *short* solution is not necessarily the *best* solution: what looks short upon paper may be the result of more mental exertion than what looks long; the art is so to manage that the expenditure of time, and thought, may be reduced to the smallest possible amount: a solution thus characterized is entitled to be called an elegant solution. To those merely mechanical operations—the performance of which it is the business of the early parts of Algebra to teach—these remarks do not, of course, apply; they refer exclusively to the subject of problem-solving, and to the more advanced portions of algebraical research.

J. R. YOUNG.



ERRATA IN THE SOLUTIONS.

- Example 13, page 7, for $1\frac{1}{10}$ read $2\frac{1}{10}$.
 „ 5, „ 10, in the first term, for n^3 read n^4 .
 „ 7, „ 10, „ „ for 8 read — 8.
 „ 6, „ 11, the answer is $8x^3 + 10ax^2 - 13a^2x - 15a^3$.
 „ 5, „ 16, for $\frac{3}{2}y^2z^2$ read $\frac{3}{2}xy^2z^2$.
 „ 15, „ 19, supply the index 3 over $\sqrt{}$.
 „ 17, „ 19, for $a^{-\frac{1}{2}}$ read $a^{\frac{1}{2}}$.
 „ 14, „ 21, for $(x + y)(x + z)$ read $(x + z)(y + z)$.
 „ 6, „ 21, for x^2x read a^2x .
 „ 11, „ 23, for — $3a$ read $3a$.
 „ 7, „ 43, for = $\frac{n}{4}$ read + $\frac{n}{4}$.

* This correction should also be made in the Algebra, page 195.

