

Andrew Dansie · Heidi K. Alleway ·
Benno Böer *Editors*

The Water, Energy, and Food Security Nexus in Asia and the Pacific

The Pacific

OPEN ACCESS

 Springer

Water Security in a New World

There is a greatly heightened sense of awareness amongst politicians, policymakers, researchers and the general public that water security is a new and emerging threat. Just in the past few years, a number of high-level meetings involving the world's leaders and thinkers have focused on water security. With water security now commanding global attention, specific questions are posed on the likelihood of armed conflict and war over shared water resources, on the continuing availability of water resources to produce sufficient food for 9 or 10 billion people, on the probability of providing safe drinking water to every man, woman and child, and on the impact of climate change to create extreme water events – such as typhoons, floods and droughts – for which we are not prepared. By bringing together inputs from the world's leading thinkers, experts, practitioners and researchers, the Water Security in a New World series aims to provide evidence-based and policy-relevant responses to these and many other questions related to water security. The volumes in this series will provide in-depth analysis of the various dimensions of water security and are meant to be used by researchers, policymakers and practitioners alike.

Editorial Board:

Zafar Adeel, Pacific Water Research Centre, Simon Fraser University, Canada
(Editor-in-Chief)

David Devlaeminck, Xiamen University, China

Dustin Garrick, University of Oxford, UK

Michael Glantz, University of Colorado, Boulder, USA

Joyeeta Gupta, University of Amsterdam, The Netherlands

Uma Lele, Independent Scholar, Formerly Senior Advisor, The World Bank, USA

Bob Sandford, University of British Columbia, Canada.



Andrew Dansie · Heidi K. Alleway · Benno Böer
Editors

The Water, Energy, and Food Security Nexus in Asia and the Pacific

The Pacific

 Springer

Editors

Andrew Dansie
Global Water Institute
University of New South Wales
Sydney, NSW, Australia

Heidi K. Alleway
Provide Food and Water
The Nature Conservancy
Arlington, VA, USA

Water Research Center, School of Civil
and Environmental Engineering
University of New South Wales
Sydney, NSW, Australia

Benno Böer
UNESCO
New Delhi Office
New Delhi, India

Published jointly by the United Nations Educational, Scientific and Cultural Organization (UNESCO), 7, place de Fontenoy, 75007 Paris, France, the UNESCO Office in Bangkok, Mom Luang Pin Malakul Centenary Building, 920 Sukhumvit Road, Prakanong, Klongtoei, Bangkok 10110, Thailand, the UNESCO Office in Jakarta, Jl. Galuh II no. 5, Kebayoran Baru, 12110 DKI Jakarta, Indonesia and Springer Nature Switzerland AG, Gewerbestrasse 1, 6330 Cham, Switzerland.

© UNESCO 2024
ISBN UNESCO 978-92-3-100599-2

ISSN 2367-4008 ISSN 2367-4016 (electronic)
Water Security in a New World
ISBN 978-3-031-25462-8 ISBN 978-3-031-25463-5 (eBook)
<https://doi.org/10.1007/978-3-031-25463-5>



This book is licensed under the terms of the Creative Commons Attribution-ShareAlike 3.0 IGO License (<https://creativecommons.org/licenses/by-sa/3.0/igo/>), which permits use, sharing, adaptation, distribution, and reproduction in any medium or format, as long as you give appropriate credit to UNESCO, provide a link to the Creative Commons license and indicate if changes were made. If you remix, transform, or build upon this book or a part thereof, you must distribute your contributions under the same license as the original. This publication is also available at the UNESCO Open Access Repository: <https://unesdoc.unesco.org>.

The designations employed and the presentation of material throughout this publication do not imply the expression of any opinion whatsoever on the part of UNESCO concerning the legal status of any country, territory, city or area or of its authorities, or the delimitation of its frontiers or boundaries.

The authors are responsible for the choice and the presentation of the facts contained in this book and for the opinions expressed therein, which are not necessarily those of UNESCO and do not commit the Organization.

The designations employed and the presentation of material on the maps do not imply the expression of any opinion whatsoever on the part of the Secretariat of the United Nations concerning the legal status of any country, territory, city or area or of its authorities, or concerning the delimitation of its frontiers or boundaries. Dotted line represents approximately the Line of Control in Jammu and Kashmir agreed upon by India and Pakistan. The final status of Jammu and Kashmir has not yet been agreed upon by the parties. Areas in white represent Non-Self Governing Territories.

This Springer imprint is published by the registered company Springer Nature Switzerland AG
The registered company address is: Gewerbestrasse 11, 6330 Cham, Switzerland

SHORT SUMMARY

Pacific leadership must be supported

Global climate targets and the call to action from the Pacific must be heeded while major environmental, societal and economical progress is needed in the region. Leadership from Pacific Island Countries and Territories needs to be supported with action and resourcing to meet both global net zero goals and regional SDGs.

This volume applies the water, energy, and food security nexus approach solely in a Pacific context for the first time, bringing together the region's 17 countries and 7 Territories. This approach improves the security of each sector and supports regional climate and environmental priorities. Effective intersectoral solutions exist with connectivity between the water-food and water-energy sectors of particular benefit. Traditional knowledge and crop production have historically and will continue to play a major role in food security and water resources management in the region. Increased energy demand needs to be met with increased renewables installation as well as new technologies that encompass storage and transport considerations.



Governments, decision makers, research communities, and practitioners dealing with water, energy, or food as well as the environment in the Pacific are invited to build on the findings of this volume and work together on Pasifika-led solutions for the region and the world.



"Since wars begin in the minds of men and women it is in the minds of men and women that the defences of peace must be constructed"

Foreword by Hilda C. Heine

In January 2020, I was sitting under a coconut tree at my house in Majuro in the Marshall Islands talking climate change with a journalist. I shared that water came over the seawall into my garden every month as a result of sea-level rise, bringing with it waste, debris, and high levels of salinity.

I can now share that over two years later, the situation has gotten worse with the pandemic contributing to unaffordable energy prices at the fuel pumps and exorbitant costs of imported food items in the stores. At the same time, the continuing sea-level rise intensifies salinity levels in our water lenses limiting types of food crops that can be grown to sustain us. There is no question that the solutions are few and far between and are not coming fast enough to ease the lives and livelihoods of the vulnerable in our communities.

While our talk was only two years ago, my sincere hope at the time was that we would see some real change being made by now to increase water, food, and energy security—not only in the Marshall Islands—but all over the Pacific. Our people, ecosystems, and economies have been grappling with these issues for decades, and it's clear that while we have indeed had some small successes in specific areas, past approaches have not yet had the integrated impact we so gravely need.

The concept of a water-energy-food (WEF) nexus approach that considers the Pacific's unique needs and challenges is timely and an opportunity to be embraced. We know that we must keep progressing and pivoting when needed, and I read this publication with a great deal of hope and anticipation. The WEF approach carefully considers critical interdependencies and linkages in different regions of the Pacific which, without due regard, can set us back rather than moving us forward.

We have the impetus and we have the evidence. Importantly, the WEF approach also considers cross-cutting issues such as gender; one that is close to my heart as I have experienced, seen, and continue to see the inequality facing women and girls in the Pacific—especially those in rural areas. Rural women already play a key role in sectors like agriculture and fisheries. If the WEF approach can empower these women to lead, the benefits will flow beyond water, energy, and food security to improve the social, economic, and political status of rural women and girls.

If we can make a commitment to the WEF approach through governance and policy, and if the right investment can be secured, we will be in a much better position to contribute to global agendas and secure a healthier, safer, and more prosperous future for all. Now is the time to be bold and take action.

Majuro, Marshall Islands

Senator Hilda C. Heine

Hilda C. Heine was the 8th President of the Republic of the Marshall Islands from 2016 to 2020. She was the first Marshallese woman to hold this office and the first woman to lead an independent Pacific Island nation.

Foreword by Shahbaz Khan

In this volume ‘The Water, Energy, and Food Security Nexus in Asia and the Pacific’ an overview of the sub-region is presented, and the nexus-concept is introduced. The volume is a part of a three-volume series to examine in an integrated manner the water-energy-food nexus in the Asia and Pacific Region. It explores the socioeconomic implications of the nexus approach with a focus on cross-cutting issues, such as climate change, gender, urbanization, impacts on environment and economy, and transboundary issues. It provides new insights into nexus solutions in the region. This volume is of particular interest for Pacific Island Countries and Territories as well as small island developing states (SIDS) globally, highlighting the challenges and opportunities for SIDS.

The islands in the vast Pacific Ocean have been home for people for tens of thousands of years. Currently, there are ca. 43.7 million people living in this realm. The overall area includes Australia and New Zealand, Melanesia (Papua New Guinea, Solomon Islands, Fiji, Vanuatu, New Caledonia), Micronesia (Guam, Kiribati, Micronesia, Northern Mariana Islands, Marshall Islands, Palau, Nauru), and Polynesia (French Polynesia, Samoa, Tonga, American Samoa, Cook Islands, Wallis and Futuna Islands, Tuvalu, Niue, Tokelau). Australia and New Zealand’s population has grown from ca. 10 million in 1950 to 31 million in 2020. In the same time-period, the number of people living in Melanesia combined grew from just over 2 million to more than 10 million, in Micronesia from just over 150,000 to more than 550,000, and from more than 200,000 to 700,000 in Polynesia.

Especially for people living on small islands, the water, food, and energy availability has always been a major constraint to sustainable existence, but local knowledge and traditional ways of life have allowed adaptability to both seasonal and multi-year La Niña-El Niño weather cycles. This difficulty has only increased due to the region now being integrated into the global economy, supporting growing and increasingly urbanized populations, and impacted severely by anthropogenic climate change issues. Many of these places now depend on the import of food and energy, providing supply-chain risks and major financial add-on costs over such vast distances, and are at the mercy of coastal infrastructure to sea-level rise and increasingly severe major storm events. Often limited surface and groundwater resources

place a major importance on rainfall to provide freshwater, especially so on low-lying islands and atoll nations, such as the Marshall Islands and Kiribati, with more than 70% SIDS suffering from water shortages.

It is highly advisable to look into water, food, and energy security in a concerted fashion, in a nexus, encouraging a dialogue and motivating a holistic approach for the management of these vital resources by the stakeholders that are involved, including producers, consumers, and regulators.

This book and related analysis could be an important contribution to improve the situation.

In order to achieve the ambitious tasks of the Sustainable Development Goals 2 (Zero Hunger), 6 (Water, Sanitation and Hygiene), and 7 (Clean and Affordable Energy), all stakeholders need to do much more and be better coordinated than ever before.

Actions to improve the situation will have to involve future generations; it has to involve women and men, and the youth, via education for sustainable development, as well as via scientific research into existing and innovative technologies, aimed at improving water, food, and clean energy management.

It is time to re-adjust global, regional, national, provincial, and local priorities with a clear view toward those parameters that are of the greatest importance for human survivability.

I thank the University of New South Wales Global Water Institute for the partnership, jointly producing this volume with UNESCO, and I congratulate the editors and authors of the volume for the production of this well-structured scholarly work, under the able leadership of Dr. Andrew Dansie, together with a formidable woman in science, Dr. Heidi Alleway (The Nature Conservancy).

Prof. Shahbaz Khan
Director, UNESCO Office in Beijing,
and former Director, Regional Science
Bureau in Jakarta

Contents

1	An Introduction and Overview to Building Water, Energy, and Food Security in the Pacific Using a Nexus Approach	1
	Andrew Dansie, Heidi K. Alleway, and Benno Böer	
Part I A Regional Overview		
2	State of Freshwater Resources in the Pacific	23
	Nicholas Schofield and Hemant Ojha	
3	Energy Security in the Pacific	51
	Katerina Syngellakis and Peter Johnston	
4	State of Food and Nutrition Security in the Pacific	85
	Federico Davila, Sarah Burkhart, and Tarli O’Connell	
Part II Regional Issues of the Pacific		
5	Regional Climate Drivers, Trends and Forecast Change	109
	Clare Stephens and Arona Ngari	
6	The Water-Food Equation in the Pacific	129
	Heidi K. Alleway and Wade L. Hadwen	
7	The Water-Energy Equation	149
	Richard R. Rushforth	
8	Desalination in the Pacific	165
	Yingfei Huang, Conna Leslie-Keefe, and Greg Leslie	
9	Towards a Circular Logistics Partnership: Regional Trade, Waste, and Inter-Sectoral Cooperation	187
	Simon Bennett, Anthony Talouli, and Vinayak V. Dixit	

10	Infrastructure Vulnerability to Disruption: A Particularly Pacific Problem	201
	Matt Blacka, Fiona Johnson, and Ron Cox	
Part III Cross-Cutting Themes for Security		
11	Adapting to Change? Traditional Knowledge and Water	229
	Melissa Nursey-Bray, Sally Jerome Korerura, Monifa Fiu, Siosinamele Lui, Philip Malsale, Azarel Mariner, Filomena Nelson, Salesa Nihmei, Meg Parsons, and Espen Ronneberg	
12	Energy Transitions	249
	Richard Corkish, Sandip Kumar, and John Korinihona	
13	Secured WEF and Gender: Better Data for Equality and Resilience	281
	Laura Imburgia	
14	Poverty in the Pacific: Trends, Progress, and Challenges in the Early Twenty-First Century	297
	Michael Burnside, Sarah Cook, and Akhil Suresh Nair	
15	Living in Oceania	335
	Amit Singh, Atishma Lal, and Janez Susnik	
Part IV An Integrated Approach		
16	Nexus as a Lens for SDG Implementation	361
	Natalie Degger, Christian Severin, and Vladimir Mamaev	
17	UNESCO-Designated Sites in the Pacific	381
	Hans Dencker Thulstrup	
18	Clean Energy Options for the Future	395
	Emma Lovell, Rahman Daiyan, Jason Scott, and Rose Amal	
19	Geothermal Energy for PICTs	415
	Edoardo Santagata, Klaus Regenauer-Lieb, and Richard Corkish	
20	Towards Food, Nutrition and Income Security in Papua New Guinea Through Inland Fish Farming	445
	Jesmond Sammut, Havini Vira, Shanice Tong, Matthew Nicholl, Joshua Noiney, Debashish Mazumder, Jacob Wani, Kiros Hiruy, and Sue Mei Lau	

Contributors

Heidi K. Alleway Provide Food and Water, The Nature Conservancy, Arlington, VA, USA

Rose Amal Particles and Catalysis (PartCat) Research Group, School of Chemical Engineering, Tyree Energy Technologies Building, University of New South Wales, Sydney, Australia

Simon Bennett Swire Shipping Pte. Ltd, Singapore

Matt Blacka Climate Change Cook Islands, Office of the Prime Minister, Cook Islands Government, Avarua, Cook Islands;
Water Research Laboratory, School of Civil and Environmental Engineering, UNSW Sydney, Manly Vale, NSW, Australia

Benno Böer UNESCO Natural Sciences Unit, New Delhi, India

Sarah Burkhart Australian Centre for Pacific Islands Research, University of the Sunshine Coast, Sunshine Coast, QLD, Australia

Michael Burnside Sustainable Development Reform Hub, University of New South Wales, Sydney, NSW, Australia;
Institute for Global Development, University of New South Wales, Sydney, NSW, Australia

Sarah Cook Institute for Global Development, University of New South Wales, Sydney, NSW, Australia;
Southern Center for Inequality Studies, University of the Witwatersrand, Johannesburg, South Africa

Richard Corkish School of Photovoltaic and Renewable Energy Engineering, University of New South Wales, Sydney, NSW, Australia

Ron Cox Water Research Laboratory, School of Civil and Environmental Engineering, UNSW Sydney, Manly Vale, NSW, Australia

Rahman Daiyan Particles and Catalysis (PartCat) Research Group, School of Chemical Engineering, Tyree Energy Technologies Building, University of New South Wales, Sydney, Australia

Andrew Dansie Global Water Institute, University of New South Wales, Sydney, Australia;

Water Research Center, School of Civil and Environmental Engineering, University of New South Wales, Sydney, NSW, Australia

Federico Davila Institute for Sustainable Futures, University of Technology Sydney, Sydney, NSW, Australia

Natalie Degger International Waters Learning Exchange And Resources Network (IW:LEARN), Intergovernmental Oceanographic Commission of UNESCO (IOC-UNESCO), Marine Policy and Regional Coordination Section, Paris, France

Vinayak V. Dixit Research Centre for Integrated Transportation Innovation, University of New South Wales, Sydney, NSW, Australia

Monifa Fiu Climate Change Resilience Programme, Secretariat of the Pacific Regional Environment Programme, Apia, Apia, Samoa

Wade L. Hadwen School of Environment and Science and Climate Action Beacon, Australian Rivers Institute, Griffith University, Brisbane, QLD, Australia

Kiros Hiruy Faculty of Business and Law, Swinburne University of Technology, Melbourne, Australia

Yingfei Huang School of Chemical Engineering, UNSW, Sydney, Australia

Laura Imburgia UNESCO World Water Assessment Programme (WWAP), Perugia, Italy

Fiona Johnson Water Research Centre, School of Civil and Environmental Engineering, UNSW Sydney, Kensington, NSW, Australia

Peter Johnston Energy and Environmental Consultants Ltd., Suva, Fiji

Sally Jerome Korerura School of Environment, University of Auckland, Auckland, NSW, New Zealand

John Korinhona Energy Division of the Ministry of Mines, Energy and Rural Electrification, Solomon Islands Government, Honiara, Solomon Islands

Sandip Kumar Global Sustainable Energy Solutions, (GSES), Botany, Australia

Atishma Lal Water Authority of Fiji, Suva, Fiji;
IHE Delft, Delft, The Netherlands

Sue Mei Lau Prince of Wales Clinical School, The University of New South Wales, Sydney, Australia;

Department of Diabetes and Endocrinology, The Prince of Wales Hospital, Randwick, Australia

Conna Leslie-Keefe School of Law, Society and Criminology, UNSW, Sydney, Australia

Greg Leslie School of Chemical Engineering, UNSW, Sydney, Australia;
Global Water Institute, UNSW, Sydney, Australia

Emma Lovell Particles and Catalysis (PartCat) Research Group, School of Chemical Engineering, Tyree Energy Technologies Building, University of New South Wales, Sydney, Australia

Siosinamele Lui Climate Change Resilience Programme, Secretariat of the Pacific Regional Environment Programme, Apia, Apia, Samoa

Philip Malsale Climate Change Resilience Programme, Secretariat of the Pacific Regional Environment Programme, Apia, Apia, Samoa

Vladimir Mamaev United Nations Development Programme (UNDP), Istanbul, Turkey

Azarel Mariner Climate Change Resilience Programme, Secretariat of the Pacific Regional Environment Programme, Apia, Apia, Samoa

Debashish Mazumder Centre for Ecosystem Science, The School of Biological, Earth and Environmental Sciences, The University of New South Wales, Sydney, Australia;
The Australian Nuclear Science and Technology Organisation, Sydney, Australia

Akhil Suresh Nair Faculty of Arts, Design and Architecture, University of New South Wales, Sydney, NSW, Australia

Filomena Nelson Climate Change Resilience Programme, Secretariat of the Pacific Regional Environment Programme, Apia, Apia, Samoa

Arona Ngari Cook Islands Meteorological Service, Avarua, Cook Islands

Matthew Nicholl Centre for Ecosystem Science, The School of Biological, Earth and Environmental Sciences, The University of New South Wales, Sydney, Australia

Salesa Nihmei Climate Change Resilience Programme, Secretariat of the Pacific Regional Environment Programme, Apia, Apia, Samoa

Joshua Noiney The National Fisheries Authority of Papua New Guinea, Port Moresby, Papua New Guinea

Melissa Nursey-Bray Department of Geography, Environment and Population, Faculty of Arts, Business, Law and Economics (ABLE), University of Adelaide, North Terrace, Australia

Tarli O'Connell Independent Researcher, Melbourne, Victoria, Australia

Hemant Ojha Institute for Study and Development Worldwide, Sydney, NSW, Australia;

Centre for Deliberative Democracy and Global Governance, University of Canberra, Bruce, ACT, Australia

Meg Parsons School of Environment, University of Auckland, Auckland, NSW, New Zealand

Klaus Regenauer-Lieb Energy Transition Institute, WA School of Mines: Minerals, Energy and Chemical Engineering, Perth, Australia;
Minerals and Energy Resources Engineering, UNSW, Sydney, Australia

Espen Ronneberg Climate Change Resilience Programme, Secretariat of the Pacific Regional Environment Programme, Apia, Apia, Samoa

Richard R. Rushforth School of Informatics, Computing and Cyber Systems, Northern Arizona University, Flagstaff, AZ, USA

Jesmond Sammut Centre for Ecosystem Science, The School of Biological, Earth and Environmental Sciences, The University of New South Wales, Sydney, Australia;
The Australian Nuclear Science and Technology Organisation, Sydney, Australia

Edoardo Santagata School of Photovoltaic and Renewable Energy Engineering, University of New South Wales, Sydney, Australia;
Collaboration On Energy and Environmental Markets, University of New South Wales, Sydney, Australia

Nicholas Schofield University of New South Wales, Kensington, Sydney, NSW, Australia;
Global Future Research, Canberra, ACT, Australia

Jason Scott Particles and Catalysis (PartCat) Research Group, School of Chemical Engineering, Tyree Energy Technologies Building, University of New South Wales, Sydney, Australia

Christian Severin Global Environment Facility (GEF), Washington, DC, USA

Amit Singh Ministry of Waterways and Environment, Suva, Fiji

Clare Stephens Hawkesbury Institute for the Environment, Western Sydney University, Richmond, NSW, Australia;
Water Research Centre, School of Civil and Environmental Engineering, University of New South Wales, Sydney, NSW, Australia

Janez Susnik IHE Delft, Delft, The Netherlands

Katerina Syngellakis Global Green Growth Institute, Suva, Fiji

Anthony Talouli The Secretariat of the Pacific Regional Environment Programme, Apia, Samoa

Hans Dencker Thulstrup Division of Ecological and Earth Sciences, UNESCO, Paris, France

Shanice Tong Centre for Ecosystem Science, The School of Biological, Earth and Environmental Sciences, The University of New South Wales, Sydney, Australia

Havini Vira Centre for Ecosystem Science, The School of Biological, Earth and Environmental Sciences, The University of New South Wales, Sydney, Australia; The Ok Tedi Development Foundation, Kiunga, Papua New Guinea

Jacob Wani The National Fisheries Authority of Papua New Guinea, Port Moresby, Papua New Guinea

Chapter 1

An Introduction and Overview to Building Water, Energy, and Food Security in the Pacific Using a Nexus Approach



Andrew Dansie, Heidi K. Alleway, and Benno Böer

An integrated approach to improve progress towards the UN SDGs and a Net Zero Future that supports environmental, societal and economic prosperity in the Pacific.

Abstract The Pacific is not on track to achieve any of the SDGs by 2030 with major progress needed across each of the environmental, societal, and economical realms. Progress towards certain SDGs should not come at the expense of others and adding further complexity, new methodology are now also being developed to meet more recent national targets under the 2050 Paris Agreement net zero greenhouse gas emission aspirations. A water, energy, food (WEF) nexus approach provides a framework with which to increase the security of each of the three sectors, underpinned by a healthy environment and recognizes the role and need for functioning ecological services. The blue carbon market offers a particularly well-suited opportunity for the Pacific to combine sound environmental stewardship with economic opportunity and follow-on societal benefits. This unique ‘blue continent’ of islands and archipelagos spread across the Pacific Ocean requires a regional-specific consideration of the WEF nexus often overlooked as part of the larger ‘Asia–Pacific’. However, applying a WEF nexus approach in the Pacific is not a one-size-fits all undertaking. Discussed in chapter-specific detail in this volume, it requires country- or territory-specific

A. Dansie (✉)

Global Water Institute, University of New South Wales, Sydney, Australia
e-mail: a.dansie@unsw.edu.au

Water Research Center, School of Civil and Environmental Engineering, University of New South Wales, Sydney, NSW, Australia

H. K. Alleway

Provide Food and Water, The Nature Conservancy, Arlington, VA, USA

B. Böer

UNESCO Natural Sciences Unit, New Delhi, India

© UNESCO 2024

A. Dansie et al. (eds.), *The Water, Energy, and Food Security Nexus in Asia and the Pacific*, Water Security in a New World,
https://doi.org/10.1007/978-3-031-25463-5_1

consideration of existing water resources, food systems, energy needs, and traditional knowledge while addressing challenges from anthropogenic climate change, human population growth, and ever-increasing demands for resource consumption.

Keywords Pacific · Water · Energy · Food · Nexus · Blue Carbon · WEF

1.1 Overview of Securing Water, Energy, and Food in the Pacific

The Asia and Pacific region is home to over 4.3 billion people, or 60% of the world's population, and some of the most pressing global challenges for sustainability and human prosperity. This volume considers the “water, energy, food (WEF) nexus” in the Pacific and is a part of a three-volume book series, accompanying ‘East and Southeast Asia’ and ‘Central and South Asia’. ‘This Pacific volume comprises the regions of Micronesia, Melanesia, Polynesia, and Australasia. Geographically and culturally diverse, this part of the world requires dedicated focus if sustainable development across environmental, societal, and economical aspirations is to be made at a pace rapid and responsive enough for those that live here.

Seventeen sovereign countries (Australia, Cook Islands [*Kūki 'Āirani*], Federated States of Micronesia [FSM], Fiji, Kiribati, Marshall Islands, Nauru, New Zealand [*Aotearoa*], Niue, Palau, Papua New Guinea [PNG], Samoa, Solomon Islands, Timor-Leste, Tonga, Tuvalu, and Vanuatu) and seven territories (American Samoa, French Polynesia, Guam, New Caledonia, Northern Mariana Islands, Tokelau, and Wallis and Futuna) are spread across the northern and southern hemispheres of the Pacific Ocean, a blue expanse that covers a fifth of the world's surface area but contains only 1% (44.5 million people) of the Asia Pacific population or 0.5% of the global population. All of these countries and territories are characterized by small populations, high transportation costs and, with the exception of Papua New Guinea and Timor-Leste, a geographical remoteness stemming from no land borders with another country. The authors note that Timor-Leste is not geographically a Pacific Island Country but for the scope of this book has more in common with the challenges of the Pacific compared to Southeast Asia and is included in this volume.

In this volume the current state of water resources, energy security, and food security in the Pacific are considered in Part I. This foundation then allows attention to be given to regional issues associated with the major challenges and importance of climate trends and change, infrastructure, trade, and waste (Part II). Here, water security and its intersectionality each with the energy and food sectors in the Pacific highlights the significance of both land and marine food systems and connectivity between water and energy. It is shown that these systems cannot be separated from challenges associated with infrastructure, transport, and waste that are unique to the vast archipelagic region.

Throughout this volume particular focus is on the Pacific Island Countries and Territories (PICTs) of the region because Small Island Developing States (SIDS) face urgent and shared regional challenges. To address these challenges the WEF nexus offers a coordinated approach to managing water, energy, and food sectors centred on cooperation between sectors to ensure a healthy environment and functioning ecosystem services needed by all. Cross-cutting themes for water, energy, and food security—those that are essential for meaningful and sustained improvement in the environmental, societal, and economic aspirations of the United Nations Development Goals (UN SDGs)—are then explored (Part III). Developing solutions that are cognizant of the world’s colonial past and the global inequalities that persist today is essential for meaningful change. The path forward is one that brings traditional knowledge and awareness of the Pacific water and food systems. Conversely, national energy demands need to look to the future and the need to hasten energy transition away from fossil fuels is clear, true in both the Pacific and globally. Such solutions need to lessen inter- and intranational economic and demographic inequalities. To do this we must ensure that a gendered, equitable, and inclusive approach underpins all that we set to achieve. An integrated manner to improving water, energy, and food security using a nexus approach is presented in Part IV, including two case study chapters that demonstrate proven and potential WEF nexus approaches in the Pacific.

Fossil fuels have played a major role in supporting the tremendous economic and industrial growth seen (unequally) across the globe. The technical advances they have allowed has supported human population growth of almost 6 billion people in the last 100 years, with 50% of this growth having been since the 1990s, to a total global human population that now exceeds 8 billion people. The resulting carbon dioxide emissions, along with other greenhouse gases and emissions from human activity, are responsible for the anthropogenically altered climate we now all live in. Anthropogenic climate change threatens environmental, social, and economic security worldwide with particular urgency faced by many people of the Pacific due to sea level rise, increasing cyclone intensities, and changing rainfall regimes (IPCC 2021). But carbon also offers to be part of the solution, with nature-based solutions (NbS) and Blue Carbon presenting tremendous opportunity in the Pacific to provide environmental and socio-economic outcomes. Blue Carbon in the Pacific is especially well-placed to support a WEF-approach in the region due to there being no additional pressures on freshwater resources or productive agricultural lands.

1.2 The Water, Energy, Food Nexus

The nexus is a useful concept to consider and address the complex and interrelated nature of water, energy, and food systems (Fig. 1.1). In practical terms, as defined by FAO (2014), it presents a conceptual approach to better understand and systematically analyze the interactions between the natural environment and human activities, and to work towards a more coordinated management and use of natural

resources across sectors and scales. This approach allows for a more informed way to identify and manage trade-offs and to build synergies through our responses as societies and nations, allowing for united and cost-effective planning, decision-making, implementation, monitoring, and evaluation.

The nexus concept was launched at the 2011 World Economic Forum through the lens of water security in a session titled ‘Water Security: The Water-Energy-Food-Climate Nexus’. That forum laid out the complex challenges faced in managing future water needs towards 2030 and the imperative of accounting for social, political, and economical considerations. Later in the same year, the Bonn Conference on ‘The Water Energy and Food Security Nexus—Solutions for the Green Economy’ applied the nexus lens to both water and food with emphasis on understanding interdependencies and linkages. In 2012 the German delegation to the Rio+20 conference used the nexus approach as a method to enhance transition towards a greener economy. Operating within planetary boundaries is part of the nexus-concept (Fig. 1.1) but something industries and communities are currently a long way from achieving.

Since 2012 the WEF nexus approach has gained a firm foothold in multilateral development agencies, national dialogues, and academia. The nexus itself is still

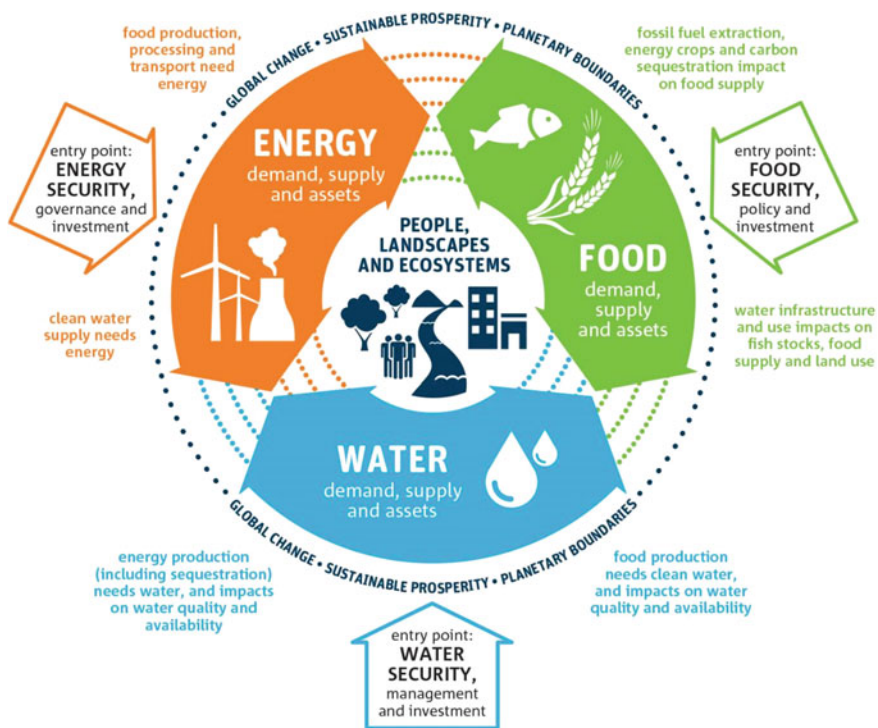

Fig. 1.1 An example of the water, energy, and food nexus concept showing examples of the linkages between sectors, the central role of people and ecosystems, and the outer sustainability principles within which the nexus approach operates (CSIRO 2015)

broadly interpreted by different users of the concept but agreement is seen in its calls for transdisciplinary integration of efforts, greater focus on inter-sectoral analysis, and improvements in policy coherence. The FAO nexus definition and approach is not unique, but has roots in other strategies including Integrated Water Resources Management (IWRM), Ridge to Reef (R2R), Integrated Coastal Zone Management (ICZM) and other multisectoral and multistakeholder approaches that seek to balance the water needs of society, the environment and the economy (Wichelns 2017). The unique aspect of the nexus approach, however, is the use of clear terminology of ‘water’, ‘energy’ and ‘food’. These immediately tangible concepts provide direct connectivity into existing federal agencies and ministerial and regulatory portfolios. The nexus approach that encourages interlinkages between the sectors fosters a dialogue of reciprocity on key issues across legislative and government branches and, therefore, encourages decisions that are appreciably multisectoral.

Importantly, the nexus approach examined in this book builds on the evolution of approaches and terminology made prior to 2011 as well as the progress made in the international development sector since the 1950’s. For example, more than 80% of UN member states have laid the foundations for IWRM (UN Environment 2018) with 54% of the countries having made some degree of implementation of IWRM (SDG6 Target 6.5.1) at the global level by 2020 (UN Water, n.d.). Taking a nexus approach can further assist with the implementation of such efforts and enhance the integration of investment and development decisions within the water, energy and food sectors. Further, taking a water, energy and food nexus approach also allows progress to be planned and implemented across a suite of SDGs, minimizing the unintended advance of certain SDGs at the expense of others. It is this call to interdisciplinarity and integration that the nexus approach uniquely brings to sustainable development, and building resilient environmental systems, societies and economies to 2030 and beyond.

1.3 The Pacific Region

The Pacific region is also referred to as Oceania, and this perfectly captures the essence of the region. It is comprised of island nations, ranging from the continent-sized Australia to atoll nations such as Kiribati (Fig. 1.2). The 44.5 million people that live in the region belong to either Micronesia, Polynesia, Melanesia, or Australasia sub-regions. The cultural backgrounds of these sub-regions are distinct, yet, with geographical similarities, and they all face regionally unique challenges for the provision of secure water, energy, and food resources in this ocean-dominated portion of the globe. In facing these challenges the countries that comprise the Pacific (Table 1.1) also have vastly different capacities, ranging from high-income countries of the Global North (Australia and New Zealand) to four of the world’s UN Least Developed Countries (Kiribati, Solomon Islands, Timor-Leste, Tuvalu). The remaining countries fall into the category of low-middle income countries (World Bank 2022) with major progress to be made against the SDGs; as a region the Pacific is not

on track to achieve any of the SDGs by 2030. At the current rate they will not be achieved until 2065 (ESCAP 2022) and much remains to be done. Lack of progress is common across all 17 Goals but SDG 13 Climate Action (SDG 13) and Responsible Consumption and Production (SDG 12) has actually gone backwards, for the Asia–Pacific as a whole as reported by UN ESCAP (2022). Affordable and Clean Energy (SDG 7) has made the most progress of any Goal, but increased energy demands in the Pacific is still seeing increased fossil fuel imports as well as renewable energy installation. Access to Clean Water (SDG 6) progress is approximately one-sixth of where it should currently be and Zero Hunger (SDG 2) a bit over a third of progress required to be on track for 2030 Goal attainment.

In the PICTs the diverse cultural landscape shares two main island geomorphology types: low-lying coral atoll islands, some average just 1.5 m above sea level at their highest point (e.g., Kiribati), and high volcanic islands that can rise up to heights of 2,000 m (Solomon Islands)—4,000 m (PNG). In between these two extremes lay all kinds of assemblages of low and high islands, with approximately 30,000 islands across the Polynesia, Micronesia, and Melanesia sub regions of the Pacific

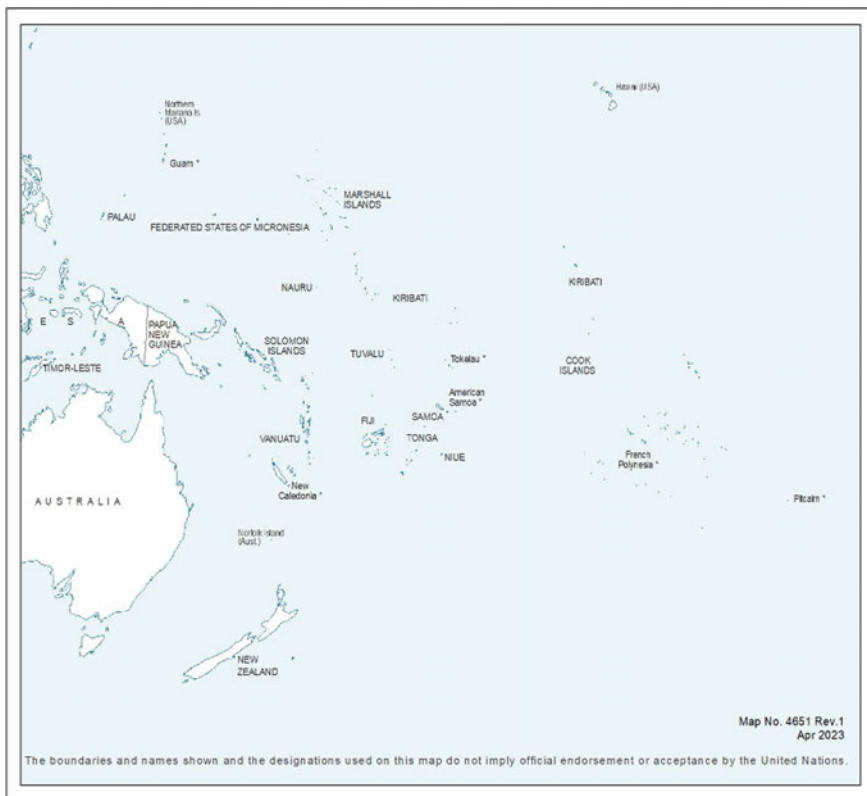

Fig. 1.2 Pacific regional map, adapted from UN Geospatial (2023)

Table 1.1 National social, economic, and development factors in the Pacific compared to with access to safe drinking water, gigajoules of energy production per capita, and agricultural contribution at national level (blank cells equate to no data available)

	Population ^a	Surface Area ^a (km ²)	GDP (million USD) ^a	GDP per capita (USD) ^a	HDI value ^b	Water ^a (% access [urban/rural])	Energy ^a (GJ per capita)	Agriculture ^a (% of GVA)
Australia	25,788,000	7,692,024	\$1,380,208	\$54,763	0.994	99/–	217	2
Papua New Guinea	9,119,000	462,840	\$24,970	\$2,845	0.555		19	18.4
New Zealand	4,861,000	268,107	\$206,936	\$43,229	0.931		199	6.1
Timor Leste	1,344,000	14,919	\$2,018	\$1,560	0.606		6	14.1
Fiji	903,000	18,272	\$5,504	\$6,185	0.743		28	13.2
Solomon Islands	704,000	28,896	\$1,303	\$1,945	0.567		12	26.1
Vanuatu	313,000	12,189	\$907	\$3,023	0.609	56/–	12	22.9
New Caledonia	288,000	19,100	\$9,880	\$34,941			262	2
French Polynesia	282,000	3,687	\$6,023	\$21,566			43	3.6
Samoa	200,000	2,842	\$845	\$4,286			27	10.1
Guam	170,000	541					1	
Kiribati	121,000	726	\$195	\$1,657	0.630	21/06	14	27.1
Federated States of Micronesia	116,000	702	\$414	\$3,640	0.620		19	27.4
Tonga	107,000	747	\$508	\$4,866	0.725	50/21	19	23.4
Marshall Islands	60,000	181	\$237	\$4,038	0.704		39	16.1
Northern Mariana Islands	58,000	457						
American Samoa	55,000	199						

(continued)

Table 1.1 (continued)

	Population ^a	Surface Area ^a (km ²)	GDP (million USD) ^a	GDP per capita (USD) ^a	HDI value ^b	Water ^a (% access [urban/rural])	Energy ^a (GJ per capita)	Agriculture ^a (% of GVA)
Palau	18,000	459	\$280	\$15,573	0.826	96/70	166	3.4
Cook Islands	18,000	236	\$379	\$21,604			62	2.7
Tuvalu	12,000	26	\$47	\$4,036		50/-	12	21.4
Wallis and Futuna	11,000	142				- /58	31	
Nauru	11,000	21	\$133	\$12,351			70	
Niue	2,000	260					64	
Tokelau	1,000	12						

^aUN Data (2021)^bUNDP (2020)

(Shea et al. 2001). The type of island influences the relative importance of water source type for water security, for example, there is more groundwater and surface water resources on high volcanic islands and less-to-none on atoll islands causing a greater reliance on rainfall collection for atoll islands. Similarly for food, rich soils on volcanic soils support a higher agricultural contribution to the diet while limestone coral reef atolls have less productive soils and leave a greater reliance on coastal and marine food sources to satisfy caloric and nutritional needs. Energy sources also differ; solar power is ubiquitous in its suitability to all countries in this sunny equatorial region whereas geothermal energy is only an option for islands with suitable geological make-up, largely related to the volcanic history of the island. It is important to remember that none of these attributes are absolutes and a water, energy, and food nexus approach needs to operate along a sliding scale of characteristics applied within the specific context of the island or combination of island types that are the focus.

Major differences in population size, land area, and national wealth across the region (Table 1.1) require that tailored and country specific WEF approaches are developed. For example, variation in the ratio of urban to rural populations across countries, from one extreme to the other (Fig. 1.3), provides important context for local water, energy, and food needs. Access to safe drinking water ranges from barely any (6% in rural Kiribati) to almost complete urban coverage (96%) and very high rural coverage (70%) in Palau (Table 1.1). The Human Development Index (HDI) provides further insight into where improvements in quality of life and livelihoods are needed. HDI considers three dimensions to measure human development at a national scale, considering life expectancy at birth, expected and mean years for schooling, and GNI per capita (PPPS). Countries with low HDI values (e.g., FSM, Kiribati, Solomon Islands, Timor-Leste) and a lack of data (e.g., Tuvalu, Niue, Samoa) require the most “development” to be made and face the greatest challenges (Table 1.1). These countries also possess the greatest opportunity to ‘leapfrog’ with advances in technological and/or resource management systems and potentially benefit most from a WEF nexus approach. This is because where major infrastructure is not already in place then decentralized and water-energy-food interconnected projects can take precedence, learning from mistakes and knowledge in Global North countries as well as PICT neighbours. Countries with higher proportions of urbanized population will have different needs for their water resources, and energy and food sectors, with a general trend of more centralized systems of production and transport required as more of the population is consolidated within urban environments. In contrast, rural areas of a country, and countries or territories with a largely rural populations generally, are more reliant on the small-scale and household level means of production. These more agricultural PICTs, those with a higher percentage of agricultural gross value added (GVA), have lower GDPs, both overall and per capita, and also lower energy needs (Table 1.1). The connectivity between industrialization as a wealth generator for the economy and development is well understood but small land areas, small populations, and geographical isolation (Fig. 1.2) make large-scale industrialization of the economy unlikely for PICTS to any great extent.

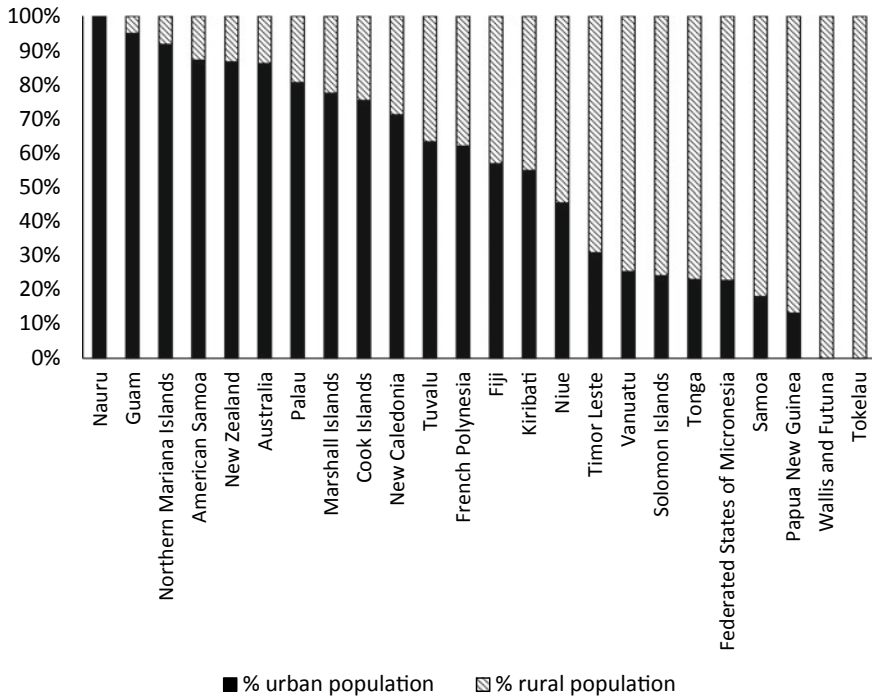

Fig. 1.3 Urban and rural populations in Pacific countries (UN Data 2021)

1.3.1 *The Community of the Pacific—Geopolitics, Aid, and Trade*

What the Pacific does have in spades is environmental resources and ambition, this ‘blue continent’ as it was recently referred to for the 2050 strategy endorsed by the Pacific Island Forum Leaders in July 2022, offers opportunity to lead the world, with some of it kicking and screaming, towards a net zero carbon emissions planet by 2050. To follow the last millennia’s path of growth and “development”, one tied to energy production and high energy consumption and CO₂ emissions per capita from fossil fuels, is folly at this crucial last stand against catastrophic temperature rise and long-term effects from anthropogenic driven climate change. Development is important as a means to increase water, food, and energy security, especially for the underprivileged and disadvantaged. But it must be de-coupled from continued use of fossil fuels. The PICTs have long shown leadership in highlighting and advocating for the urgency of this issue. They also have and continue to be frustrated by politicization of the science behind climate change globally, and perhaps most damagingly by the regional economic and carbon emitting per capita heavy weight, Australia.

The Pacific faces the two main global challenges of human population and climate change caused by anthropogenic global warming pressures like everywhere else,

but the unique geographical traits of the region, comprised largely of island and archipelagic nations, make the impacts of sea level rise and changing climate especially acute. These impacts are disproportionately felt, in most cases, to national contribution of greenhouse gas emissions and natural resource consumption. The outliers here are Australia and New Zealand, producing 15.5 and 6.6 tons of CO₂e per capita respectively (UN Data 2021) making them the 14th and 37th CO₂e contributors per capita globally. Australia also sits as the 14th overall producer of CO₂e globally, producing 492 million tons in 2021 (Australian Government 2021). The problem of climate change was not caused within any one national border and the solution must similarly be found in international cooperation.

Unification among PICTs has shown solidarity and ambition to improve global progress in addressing climate change. The former Fijian Prime Minister, and at the time Chair of the Pacific Island Forum, Frank Bainimarama, clearly stated this in the lead up to the 2021 Glasgow Climate Talks when he drew specific reference to Australia and New Zealand in that “The developed world must deliver on the \$100 billion dollars promised in climate finance”(O’Malley 2021). This lays bare the division in the region and the unfair burden of climate change that is placed on low and middle-income countries while high-income countries have been the major contributors to greenhouse gas emissions. The fossil fuels and natural resource consumption required to build the economies and industries of the Global North, of which Australia and New Zealand are a part, are responsible for the climate impacts that affect all of us, but PICTs are especially vulnerable due to their small size, reliance on sea freight and increasing coastal damage and marine intrusion due to higher intensity cyclones and storm surge in the region. Preceding the Glasgow Climate Talks, the Republic of the Marshall Islands demonstrated some deft diplomacy at the Paris negotiations to bring a ‘as close to 1.5 °C’, rather than a broader ‘below 2 °C’ target to the ultimately successful talks that resulted in the Paris Convention. This is especially important for PICTs and SIDS in other regions due to, amongst others, the increased threat of sea level rise associated with rising global average temperatures (IPCC 2021). The PICT-originating group garnered support of 90 countries to form the High Ambition Coalition (HAC) that was ultimately successful in making the Paris Agreement target more ambitious. The \$100 billion referred to was funds committed to be mobilized during United Nation talks in Copenhagen 2009 that is now managed under the Green Climate Fund. The commitment has not been met by donors from the Global North and more financial support is needed in an attempt to balance the inequality of climate change impact and mitigation efforts.

International funds have a large impact on PICT economies and activities. The smaller population and economies of PICTs make the Pacific the most aid-dependent region in the world, when aid contribution is considered as a proportion of GDP. Aid money therefore has great influence over international development through the sectors that it prioritizes, which can be influenced by the political interests of the countries that providing this support. The region receives approximately USD2 billion each year in aid. However, the most up to date reporting of complete data of aid funds spent in the Pacific is 2019; 2000 onwards is not reported for all donors. Looking at the 2019 data, Australia is the largest donor (USD864 million) followed by New

Zealand (USD254 million) and then Japan (USD179 million (Lowy Institute 2022)). The three largest lenders are Asian Development Bank (USD169 million, China (USD113 million), and the World Bank (USD69 million) (Lowy Institute 2022). Remittances are also playing a larger role in the regions with family members working overseas sending money back to support their family. In 2020 this has exceeded 10% of PICT GDP (World Bank 2020), with some countries remittance incomes representing a large percentage of their GDP, in particular Tonga (39%) and Samoa (25%) (World Bank 2020). China is the largest trading partner in the region and many PICTs are signatories to China's Belt and Road Initiative. Trade commitments and agreements have, similar to aid, influence over national priorities and natural resource management. Current ongoing unsustainable logging practices by foreign companies in the Solomon Islands (Kabutaulaka 2000; Hameiri 2012) or PNG (Marshall 1990) serves as an example of history repeating itself. Most extreme is the collapse of Nauru's economy and destruction of already limited water resources and arable land due to foreign discovery and exploitation of phosphate. The phosphate resource, in the form of thousands of years of bird guano accumulation since fossilized, was discovered by the British at the turn of the 20th Century. Strip mining, foreign exploitation, and corruption saw much of the wealth sent overseas and corruption and mismanagement at the national level squandering chances of effective royalty management since independence in 1968, albeit after much of the finite resource had been extracted.

Geopolitics in the Pacific is a major influence in aid, trade, and policy that facilitates the movement of people for paid labour and education. The major global economic powers of China, the US, and the EU are increasing their attempts of influence and partnership with PICTs, with the scarcity of land in the Pacific Ocean making the small Countries and Territories of immense military and security interest. The shared challenges and priorities of PICTs to address the critical challenge of climate change provide unification, in the most part, for PICTs to increasingly have influence above what might otherwise be expected for their individual small country "weight" in international forums. Geopolitical allies that heed the urgency of the High Ambition Coalition, Pacific Islands Forum, SAMOA Pathway and other regional bodies and cohesive stances should urgently consider domestic greenhouse gas emission shortcomings the same time as seeking to build aid, trade, migration or other bridges with PICTs.

1.3.2 Water, Energy, and Food in the Pacific

In the Pacific freshwater resources are highly variable, comprising some of the global extremes in terms of availability and access. This region, covering approximately a fifth of the planet's surface, supports extensive biomes from arid deserts to lush tropical forests so also is home to tremendously diverse food systems. The diversity in food systems sees an array of animal and plant species that have been important to

food security for millennia, and traditional knowledge that has enabled this security. But again, traditional knowledge is diverse, as distinct as the biomes that have supported people living in this region. Human society presence ranges from estimates of over 50,000–60,000 years in Australia to more recent estimates of 3,000 years ago in remote parts of Polynesia. In the last few hundred years these natural and societal systems have been upended through the global impacts of colonialization and an increasingly industrialized world. Water and food security in this region now face major challenges, and the need for energy now greatly exceeds household requirements and is a driver of concern for national security and economic stability and growth. It is in this post-colonial period of globalization that the water, energy, and food nexus approach offers opportunity to pivot as quickly as possible to a more sustainable use of water resources, a more sustainable use of land and sea for food production, and a more sustainable generation of energy by looking both to the past and to the future. In order to manage sustainably across water, food, energy, and the environment a holistic approach that leverages the diverse and location-specific traditional knowledge is essential. Addressing the sectors of water, energy, and food simultaneously must be absolute in that the underpinning biomes and environment that support them are healthy and functioning.

1.3.3 Air Quality

Alongside broader trends in climate change and its impact an emerging issue of concern in PICTs is increasing rates of respiratory illness. Energy and food are intrinsically tied to this through expanding road infrastructure allowing more and more combustion engine-powered transport, diesel generator-powered grid electricity, agricultural practices for export crops such as sugarcane burn off, indoor cooking using wood burning, industrial processes such as cement production, and waste burning due to lack of effective municipal collection and management practices.

Globally the story is similar, the harmful effects of air pollution on human health (Kampa and Castanas 2008; Dominski et al. 2021) are becoming increasingly apparent in our progressively populated and industrialized world. However, like the effects of climate change it is often the poorest people that are most impacted by air pollution from indoor and outdoor sources (Emmelin and Wall 2007; World Health Organization 2021a). In September 2021, the World Health Organisation (WHO) updated their recommended limit for air pollution from the burning of fossil fuels and issued a statement that clean air is a “fundamental human right” (World Health Organization 2021b). Clean air and energy generation are therefore intrinsically linked, even in “tropical island” places we may not think of having polluted air: low- and middle-income PICTs. These island nations are at the forefront of climate change impacts of sea level rise and increasing weather severity (IPCC 2021), with transition away from fossil fuels to provide both climate and human health benefits. However, the increasing awareness of the need for cleaner air is focussed on research in cities in high income countries and there is a dearth of data from the Global South.

This emerging health problem and the need to monitor air quality has been identified by the Governments of the Solomon Islands, Fiji, Vanuatu, and Tonga and the Pacific Regional Office of the WHO. It is women and children in poor households that are the most vulnerable to negative impacts of poor air quality and a gendered and demographical approach is to be taken to identify those at most risk. Empirical data is needed to support government partnership with multilateral agencies for investment in renewable energy and international development activities that improve air quality thought energy transitions and livelihood improvements.

It is in this context it is perhaps interesting to pause and note that there are SDGs dedicated to water, as well as to food, but none to air. One cannot help but to ask ‘*Why is there no SDG for Clean Air to Breathe? Has this simply been forgotten?*’, considering humans can survive weeks without food, days without water, but only minutes without air. However, there are recent developments with The United Nations General Assembly declaring on the 29th of July 2022 that everyone on the planet has a right to a healthy environment that included clean air, a move backers say is an important step in countering the alarming decline of the natural world. In a resolution passed at UN headquarters in New York City, the General Assembly said climate change and environmental degradation were some of the most pressing threats to humanity’s future. The resolution is not legally binding on the 193 UN Member States but “the resolution sends a message that nobody can take nature, clean air, and water, or a stable climate away from us—at least, not without a fight” said Inger Andersen, Executive Director of the UN Environment Programme (UNEP). The resolution comes as the planet grapples with what Andersen called a triple planetary crisis of climate change, nature and biodiversity loss, and pollution and waste. Left unchecked, the new resolution said those problems could have disastrous consequences for people around the world, especially the poor, and women and girls. The UN General Assembly stated they were encouraged by the increasing interest of the international community in clean air and emphasizing the need to make further efforts to improve air quality, including reducing air pollution, to protect human health, and in December 2019 designated 7 September as the International Day of Clean Air for blue skies.

1.3.4 A Nexus Approach in the Pacific

Applying a WEF nexus approach in the Pacific is not a one-size-fits all approach and as discussed in chapter-specific detail in this volume, requires careful consideration of existing water resources, food systems, energy needs, and supplies. It must also consider population demographics and a design that assists and empowers those most in need that are suffering from poverty, inequality, or injustice. The nexus approach must be forward looking to build resilience for projected populations and resource consumption requirements associated with development, as well as current and projected climate change impacts. Infrastructure and long versus short term return on investment decisions must be made to facilitate a WEF approach and large

multilateral financial support will be needed to achieve such transitions. For 2030 SDG climate and climate-related targets and 2050 Net Zero targets energy transition will be especially key, and investment in major infrastructure to support non-fossil fuel energy production, such as geothermal, solar, hydrogen, kinetic, wind, will be needed in both PICTs and as part of all Nationally Determined Contributions (NDCs). Abundant sources of clean, affordable energy will support increased provision of safe drinking water and nutritious food. Effective and integrated water and natural resources management will be needed to ensure the security of both terrestrial and coastal food systems. Traditional knowledge and staple foods are especially important in building resilience against climate change and increasing food security, most so in the poorer and rural environments and PICTs.

Underpinning all of this is the need for a healthy environment and functioning ecosystem services. Without addressing the environmental targets of the SDGs displayed in Fig. 1.3, and ensuring this environmental base, societal and then economic aspirations will be unsustainable, if not completely unachievable. Central to achieving true sustainability for PICTs and broader Pacific region is the role of carbon, in both the problems it creates and solutions it supports. NDCs provide a roadmap for national carbon emissions (in reality a suite of greenhouse gases that include carbon-dioxide, methane, nitrous-oxide, and others, referred to as CO₂e or CO₂ equivalent emissions) and while reducing emissions in the first place is preferable to CO₂e sequestration, both are now needed to keep global warming below 2 °C and as close to 1.5 °C as possible.

1.3.5 The Role of Carbon as a Particularly Pacific-Specific Solution

The international carbon market was established under the Kyoto Protocol in 1997, in an effort to reduce greenhouse gases. Carbon credits are now tradable on the international market to offset national or private sector greenhouse gas emissions where reduction is not possible or desirable. The last decade has seen the prominence of ‘blue carbon’, that which is stored within coastal ecosystems such as mangroves, seagrass, salt marsh, and tidal habitats, regarded as a particularly effective form of carbon sequestration. The large CO₂e potential sequestration in the form of blue carbon lies in both the biomass and sediments of the marine and tidal ecosystems. Tropical forest CO₂e storage potential is 800 tons per hectare (ha) comprising 600/200 in biomass and in the soil respectively (Wetlands International 2022). Mangroves in comparison have a total (biomass/soil) CO₂e storage potential of 3,767 (928/2,839) tons per ha (Wetlands International 2022)—over four times as much. Salt marshes have a potential of 949 (32/917) tons per ha and seagrass meadows a potential of 511 (11/500) tons per ha (Wetlands International 2022). Given the Pacific is the ‘blue continent’ blue carbon, consequently, provides a timely and pivotal opportunity for PICTs to apply a WEF nexus approach centred around

a healthy environment (Fig. 1.1), and a foundation to then sustainably address societal and economical SDG and development target aspirations (Fig. 1.4). Importantly, the highly effective blue carbon capturing ecosystems offer opportunities to capture carbon and generate carbon credits for sale with no additional pressures on freshwater resources, especially important in water-scarce PICTs. Further, rather than rows of monoculture timber plantations that compromise some terrestrial carbon capture approaches, the coordination of environmental management with food systems (fisheries and terrestrial), water resources, and energy development, as well as coastal infrastructure offers major return on investment on top of the value of the carbon credits sold. Examples of the additional return of investment include better fish stocks due to mangrove, seagrass, or near-shore reef habitat that supports the varying life-cycle stages of commercially targeted or community-reliant fish species, salt marsh that supports bird and insect life, and vegetated shorelines that protect against storms overtopping event that salinize groundwater and soils and aid to capture and attenuate shore-based pollution. This added on return on investment can be maximized through coordinated management, which can be enhanced using a WEF Nexus approach.

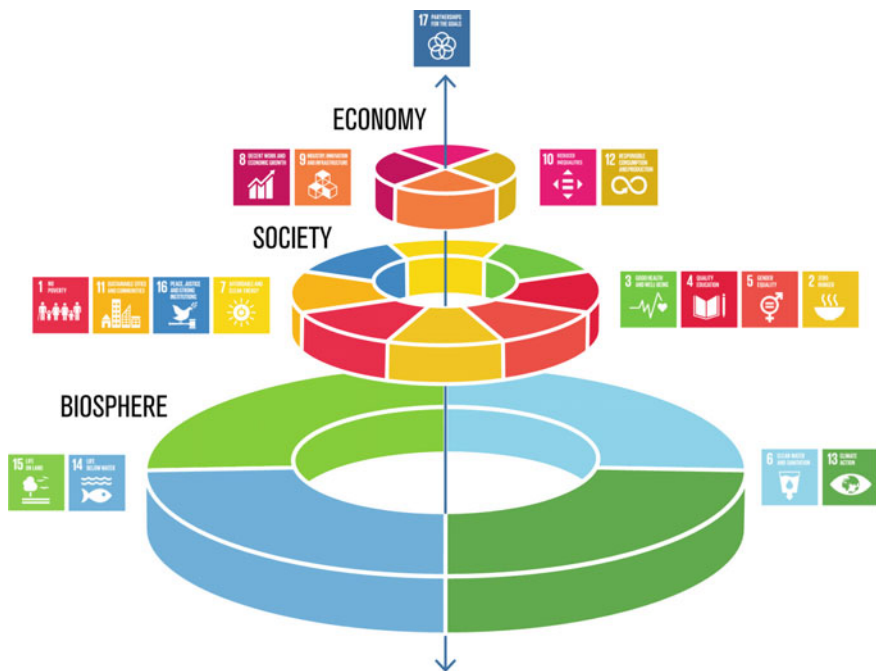

Fig. 1.4 Environmental systems and functions are essential to supporting subsequent societal and economical SDG aspirations (Stockholm Resilience Center 2016)

1.4 Addressing Future Challenges Using a WEF Nexus Approach

Socioeconomic advances in the Pacific are a challenge, with progress on eradicating extreme poverty and reducing national poverty hindered due to low public investment in education and health services (ESCAP 2022). COVID-19 has increased inequalities worldwide and negatively impacted progress toward achieving the SDGs. It is no different in the Pacific. The geographical isolation initially held back COVID-19 outbreaks in Australia, New Zealand, and many of the PICTs, but this isolation has not been enough, and the impact of COVID-19 is now being felt throughout the region. Impacts on GDP, trade, remittances, tourism, and food imports have all negatively affected Pacific countries.

Importantly, a WEF nexus approach builds on and does not negate the integrated and coordinated efforts to date in the Pacific through IWRM, Ridge to Reef, Source to Sea, UNESCO Biosphere Reserves, Integrated Coastal Zone Management, and similar approaches. Areas of most concern in the Pacific, those showing regression rather than advancement of SDG targets, are clean water and sanitation (SDG 6), reduced inequalities (SDG 10), sustainable cities and communities (SDG 11), responsible consumption and production (SDG 12), climate action (SDG 13) and life below water (SDG 14) (ESCAP 2022). Limited progress has been made towards good health and well-being (SDG 3), affordable and clean energy (SDG 7), industry, innovation and infrastructure (SDG 9), life on land (SDG 15), and partnerships for the goals (SDG 17) (ESCAP 2022). These areas of most concern would all benefit from a WEF nexus approach and are detailed in the chapters of this regional volume.

Globally, major greenhouse gas emitters need to step up for the environmental and economic benefit of all, including themselves. Within the region some Australian private sector companies are closing coal-fired power plants earlier than planned due to purely financial rationale, much to the political chagrin of some and jubilation of others. Nexus solutions that hasten the rate of transition away from fossil-fuels are needed and renewable energy generation and storage technology advances are thankfully providing economic incentives where political cohesion has been lacking. The energy transition includes energy generation for the provision of water, food, and transport services as well as households and industrial processes. Energy independence and removing reliance on fossil fuel imports will strengthen national security and the ability for self-determination of national development objectives. This is especially critical for low- and middle-income PICTs that are now seeing an unprecedented push for geopolitical influence in the region.

References

Australian Government (2021) Australia's greenhouse gas emissions: March 2021 quarterly update [Online]. <https://www.industry.gov.au/news/australias-greenhouse-gas-emissions-march-2021-quarterly-update#:~:text=The%20update%20estimates%20Australia's%20national,year%20for%20the%20Paris%20Agreement>

- CSIRO (2015) Australian National Outlook 2015: Living standards, resource use, environmental performance and economic activity, 1970–2050. CSIRO, Canberra
- Dominski FH, Branco JHL, Buonanno G, Stabile L, DaSilva MG, Andrade A (2021) Effects of air pollution on health: a mapping review of systematic reviews and meta-analyses. *Environ Res* 201:111487
- Emmelin A, Wall S (2007) Indoor air pollution: a poverty-related cause of mortality among the children of the world. *Chest* 132:1615–1623
- ESCAP (2022) Asia and the Pacific SDG progress report 2022: widening disparities amid COVID-19. United Nations
- Food and Agriculture Organization of the United Nations (FAO) (2014) The water-energy-food nexus: A new approach in support of food security and sustainable agriculture. FAO, Rome
- Hameiri S (2012) Mitigating the risk to primitive accumulation: state-building and the logging boom in Solomon Islands. *J Contemp Asia* 42:405–426
- IPCC (2021) Summary for policymakers. In: Masson-Delmotte V, Zhai P, Pirani A, Connors SL, Péan C, Berger S, et al (eds) *Climate Change 2021: the physical science basis. Contribution of working group I to the sixth assessment report of the intergovernmental panel on climate change*. IPCC
- Kabutaulaka TT (2000) Rumble in the jungle: land, culture and (un) sustainable logging in Solomon Islands. In: Hoop A (ed) *Culture and sustainable development in the Pacific*. ANU Press, Suva, pp 88–97
- Kampa M, Castanas E (2008) Human health effects of air pollution. *Environ Pollut* 151:362–367
- Lowy Institute (2022) Pacific Aid Database. Sydney
- Marshall G (1990) The political economy of logging: the Barnett Inquiry into corruption in the Papua New Guinea timber industry. *Ecologist* 20:174–181
- O'Malley (2021) <https://www.smh.com.au/environment/climate-change/how-australia-got-blindsided-in-the-great-pacific-climate-coup-20211008-p58y9d.html>
- Shea EL, Dolcemascolo G, Anderson CL, Barnston A, Guard CP, Hamnett, MP, et al (2001) Preparing for a changing climate: the potential consequences of climate variability and change. East-West Center, Honolulu, p 102
- SPREP (2022) Pacific EEZ boundary (Map) Papua New Guinea environmental data portal. SPREP
- Stockholm Resilience Center (2016) The SDGs wedding cake. Stockholm University, Sweden
- UN Data (2021) Country and regional profiles: general, economic, social and environmental and infrastructure indicators. UN Data
- UN Environment (2018) Progress on integrated water resources management: global baseline for SDG 6 indicator 6.5.1-degree of IWRM implementation. 6. Clean water and sanitation. UNEP-DHI Centre, Hørsholm
- UN Geospatial (2023) Map of the World. Copyright United Nations. <https://www.un.org/geospatial/content/map-world-1>
- UN Water (n.d.) UN-Water SDG 6 data portal. <https://www.sdg6data.org/>
- UNDP (2020) Human development reports. <https://hdr.undp.org/data-center/country-insights/#ranks>
- Wetlands International (2022) White paper—we need wetlands: the urgent case for global wetland targets. Wetlands International, Ede
- Wichelns D (2017) The water-energy-food nexus: is the increasing attention warranted, from either a research or policy perspective? *Environ Sci Policy* 69:113–123
- World Bank (2020) Personal remittances, received (% of GDP)—Pacific island small states. <https://data.worldbank.org/indicator/BX.TRF.PWKR.DT.GD.ZS?end=2020&locations=S2&start=1979&view=chart>
- World Bank (2022) World Bank country and lending groups [Online]. <https://datahelpdesk.worldbank.org/knowledgebase/articles/906519-world-bank-country-and-lending-groups>
- World Health Organization (2021) Using multidimensional poverty and vulnerability indices to inform equitable policies and interventions in health emergencies: research brief. WHO, Geneva

World Health Organization (2021b) WHO global air quality guidelines: particulate matter (PM2.5 and PM10), ozone, nitrogen dioxide, sulfur dioxide and carbon monoxide, World Health Organization. WHO, Geneva

The opinions expressed in this chapter are those of the author(s) and do not necessarily reflect the views of the UNESCO: United Nations Educational, Scientific and Cultural Organization, its Board of Directors, or the countries they represent.

Open Access This chapter is licensed under the terms of the Creative Commons Attribution-ShareAlike 3.0 IGO License (<https://creativecommons.org/licenses/by-sa/3.0/igo/>), which permits use, sharing, adaptation, distribution, and reproduction in any medium or format, as long as you give appropriate credit to the UNESCO: United Nations Educational, Scientific and Cultural Organization, provide a link to the Creative Commons licence and indicate if changes were made. If you remix, transform, or build upon this book or a part thereof, you must distribute your contributions under the same licence as the original.

The use of the UNESCO: United Nations Educational, Scientific and Cultural Organization's name, and the use of the UNESCO: United Nations Educational, Scientific and Cultural Organization's logo, shall be subject to a separate written licence agreement between the UNESCO: United Nations Educational, Scientific and Cultural Organization and the user and is not authorized as part of this CC-IGO licence. Note that the link provided above includes additional terms and conditions of the licence.

The images or other third party material in this chapter are included in the chapter's Creative Commons licence, unless indicated otherwise in a credit line to the material. If material is not included in the chapter's Creative Commons licence and your intended use is not permitted by statutory regulation or exceeds the permitted use, you will need to obtain permission directly from the copyright holder.



Part I
A Regional Overview

Chapter 2

State of Freshwater Resources in the Pacific



Nicholas Schofield and Hemant Ojha

Freshwater in Oceania is highly variable, with the Pacific islands having generally limited access to freshwater which is under increasing threats from climate change and a variety of socio-economic drivers including overextraction and pollution.

Abstract The freshwater resources of Oceania are highly variable, comprising some of the global extremes in terms of availability and access. The Pacific Island Countries and Territories (PICTs) have lower water security than Australia and New Zealand, the two developed nations in the region. Among PICTs, whilst surface and groundwater resources are available on high volcanic islands, small, low-lying coral and limestone atolls have limited groundwater and no surface water, hence are highly dependent on rainfall. Almost all islands utilize groundwater if not for potable purposes, then for washing needs. The development of water resources for human uses has focused largely on urban centres, whilst smaller and remote communities in PICTs often lack basic water services. Available water resources are also subject to multiple threats, mainly from untreated human and mine wastes, agricultural chemicals, and sediments from forestry operations. Freshwater lenses in PICTs are facing saline intrusion resulting from over-exploitation, sea-level rise, and storm surges. Climate change is altering long-term rainfall and evapotranspiration patterns and exacerbating extreme events such as cyclones, floods, and droughts. The small populations, limited financial resources, and low capacity across the water sector in PICTs, continue to inhibit progress with SDG 6, despite considerable donor support.

N. Schofield (✉)

University of New South Wales, Kensington, Sydney, NSW 2052, Australia

e-mail: nick@globalfutureresearch.com

Global Future Research, Canberra, ACT, Australia

H. Ojha

Institute for Study and Development Worldwide, Sydney, NSW, Australia

Centre for Deliberative Democracy and Global Governance, University of Canberra, Bruce, ACT, Australia

© UNESCO 2024

A. Dansie et al. (eds.), *The Water, Energy, and Food Security Nexus in Asia and the Pacific*, Water Security in a New World,
https://doi.org/10.1007/978-3-031-25463-5_2

23

Keywords Pacific freshwater · Freshwater resources · Water and resilience · Water policy · Water security · Pacific islands

2.1 Introduction

The Pacific, and the larger Oceania region, includes countries and territories that are highly diverse not only in terms of natural freshwater resources availability and access but also in terms of the capacity to manage available water resources. Pacific Island Countries and Territories (PICTs) have generally limited freshwater resources. They are highly diverse in terms of culture and hydrogeography yet share a set of common challenges: small land area, limited groundwater and aquifer capacities, and high dependence on rainfall (Allen 2020; Falkland and White 2020). PICTs also have limited institutional and technical capacity to ensure access to water for everyone. Unlike the PICTs, Australia and New Zealand, the two developed nations of Oceania, have larger amounts of freshwater resources per capita, and also have advanced water management systems.

For a large oceanic region with numerous small islands and advanced economies like Australia and New Zealand, generalizing the state of freshwater resources is challenging, especially when comparable and recent data are limited for PICTs. Focusing on PICTs, this chapter aims to provide an overview of water resources, covering four key aspects: freshwater sources (supply), types and trends in demand on these resources (demand), existing and emerging threats to freshwater resources and water security (threats), and the effectiveness of efforts to achieve water security (responses). We draw on publicly available literature, key informant interviews, and global and regional databases.

2.2 Naturally Occurring Freshwater Sources

The three main forms of naturally occurring freshwater in Oceania are rainwater, surface water and groundwater. The distribution of freshwater is highly uneven among Australia, New Zealand, and PICTs (see Table 2.9 in Appendix 1). Although Australia is the driest inhabited continent on the planet, it is using less than 6% of renewable water resources each year (Prosser 2011; Jackson et al. 2017). New Zealand has abundant water resources with only 3% of its freshwater being used (World Bank 2021). Unlike these two advanced economies, PICTs have limited freshwater resources in general, with Fongafale islet in Tuvalu and Nauru, for example, having no confirmed accessible freshwater resources (Duncan 2011). Papua New Guinea (PNG) is an exception with 120,000 m³ of water per person. Geographic

features such as island area, shape, topography, soils, and lithology greatly influence both the occurrence and distribution of natural freshwater sources (Falkland and White 2020). Geologically, the PICTs are a combination of five main forms, namely high volcanic, uplifted limestone, low-lying coral island and atolls and mixed combinations of these forms (Duncan 2011) (see Fig. 2.1). The larger, mountainous volcanic islands have substantial surface water and groundwater resources, while the small, low-lying coral, sand and limestone islands have very limited surface and groundwater (Falkland and White 2020).

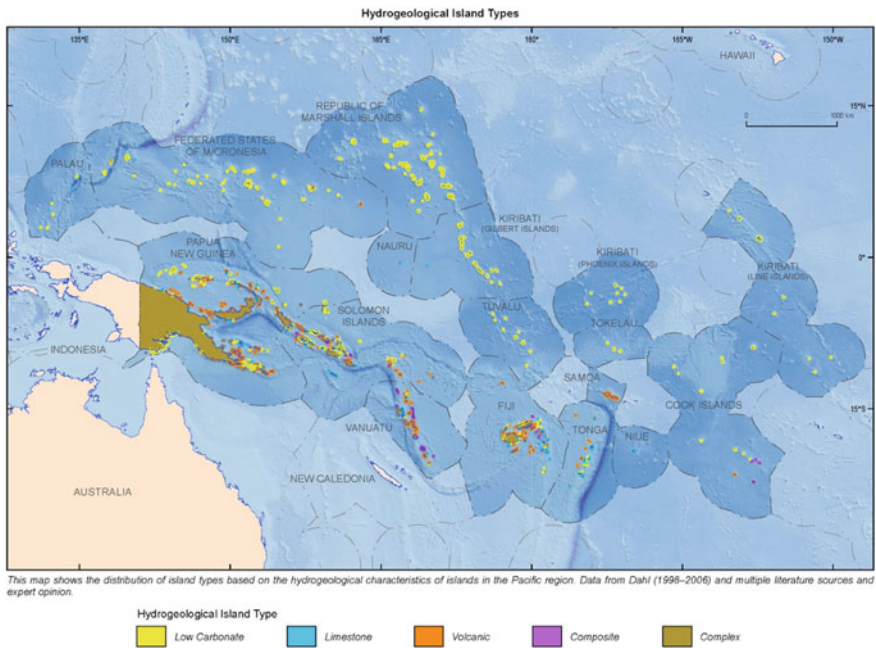

Fig. 2.1 Hydrological island types (Source Dixon-Jain et al. 2014). Commonwealth of Australia (Geoscience Australia) 2021. This product is released under the Creative Commons Attribution 4.0 International Licence. Disclaimer: The boundaries and names shown and the designations used on this map do not imply official endorsement or acceptance by the United Nations

Table 2.1 Surface water availability for some countries (UN Water 2021)

Country	Year	Surface water (billion cubic metres)
Papua New Guinea	2017	801
Vanuatu	2017	10
Fiji	2017	28.55
Solomon Islands	2017	44.7
Australia	2017	440
New Zealand ^a	2017	327
Timor Leste ^a	2014	8.2

^aData based on World Bank (2021), and the data category “renewable internal resources”. Data for other countries not available in both databases

2.2.1 Surface Water

For PICTs, Falkland (2015) recognizes four forms of surface water: (a) surface and subterranean streams, (b) springs, (c) lakes and swamps (or wetlands), and (d) dams on some of the larger islands. Perennial streams only occur on the larger, higher rainfall islands such as in PNG, Fiji, and Solomon Islands. Ephemeral streams occur more typically in small, steeper catchments where flows occur for days or hours following rainfall. While data does not exist for most countries in the region, available data shows that PNG, Australia, and New Zealand have significantly higher amounts of freshwater (Table 2.1).

Springs are an important water source on volcanic islands where bedrock has low permeability; here communities rely heavily on springs, although flow declines during droughts.¹ Wetlands are important sources of surface water for Pacific islands. There are four types according to Ellison (2009): riverine, lacustrine, freshwater swamp forests, and marshes. Freshwater lakes are found on some larger volcanic islands in the craters of extinct volcanoes, such as on Upolu, Samoa, or depressions in the topography (Falkland and White 2020). The small volcanic island of Niuafo’ou in northern Tonga has fresh and brackish lakes within its crater (Ellison 2009). The small atoll island Teraina (Washington Island), Kiribati has a central freshwater lagoon.

On some islands, dams have been constructed to store surface runoff for water supply, such as Vaturu Dam on the Nadi River, Viti Levu, Fiji, and the Fena Valley Dam, and Guam; and for hydroelectricity generation in French Polynesia, Fiji, New Caledonia, Samoa, and PNG (Falkland and White 2020). A dam is currently under construction in Solomon Islands for hydroelectricity (TRHDP 2021) (see Table 2.2 for dam capacity to harness water for all purposes in selected countries where data is available).

¹ Personal email communication, Peter Sinclair, SPC, 18 December 2020.

Table 2.2 Dam capacity per capita for selected countries in Oceania (UN Water 2021)

Country	Year	Dam capacity (billion cubic metres)
Papua New Guinea	2010	89.49
New Zealand	2015	3589
Fiji	2015	146.9
Samoa	2015	50.92
Australia	2015	3182

Australia's water supply is secure in all but the most extreme droughts (ADB 2020a). It has high water storage per capita (approximately 21,481 cubic metres recorded in the period 2008–2012, FAO 2021) which is supplemented by six large desalination plants for its major coastal cities (total capacity 527 million cubic metres per annum). New Zealand's water supply is also highly secure (ADB 2020a) with storage per capita of 69,544 cubic metres (recorded in the year 2017, FAO 2021), excepting during unprecedented droughts in recent years, associated with climate change.

2.2.2 Groundwater

Groundwater constitutes the majority of naturally occurring freshwater on small Pacific islands (Holding et al. 2016), with some islands using it as the only reliable freshwater (Dixon-Jain et al. 2014). Groundwater occurs on many small coral and limestone islands as 'fresh groundwater lenses' (Alberti et al. 2017). The groundwater lenses vary depending on rainfall, evapotranspiration, groundwater abstraction, and mixing with surrounding saline groundwater, with a coral island usually having 5–10 m thick groundwater lens (White and Falkland 2010). Leeward islands sustain larger lenses with slower discharge of groundwater and reduced mixing. In some islands, such as Nauru, fresh groundwater is found only on parts of the island due to the highly permeable karst limestone which promotes mixing of fresh and underlying saline water (White and Falkland 2010). The amount of groundwater for some countries with available data is given in Table 2.3.

Small island aquifers, unexpectedly, can host freshwater lenses next to the coastline (Alberti et al. 2017). Many of these lenses shrink during low rainfall periods with reductions in the available resources of 50–100% (Falkland 1993; Duncan 2011). Seawater located beneath the freshwater lens limits the amount of groundwater that can be extracted due to potential for salinization (McKenzie 2017). Salinization is escalated by poorly managed abstraction of groundwater, as found in Kiribati (Lal and Datta 2019). Saline water from storm surge overtopping can infiltrate from the surface to mix with the underlying freshwater lens, resulting in brackish water. Observations

Table 2.3 Groundwater resources for selected countries with available data (UN Water 2021)

Country	Year	Billion cubic metres
Papua New Guinea	2017	211.6
Vanuatu	2017	4.377
Nauru	2017	0.01
Fiji	2017	5.273
Solomon Islands	2017	11.92
Australia	2017	72
New Zealand	2018	712 ^a

^aData for New Zealand based on Ministry for the Environment (2020)

confirm the potential of rainfall to replenish the freshwater lens, typically floating on saline groundwater, with a brackish transition zone.² Australia, New Zealand, and PNG have more abundant groundwater than PICTs. In Australia, groundwater makes up approximately 17% of accessible water resources and accounts for over 30% of its total water consumption (Geoscience Australia 2020). New Zealand's groundwater usage accounts for 30% of total water usage (GNS Science 2021).

2.2.3 Rainwater

Rainwater harvesting has been a valuable supplement to water supply in small island nations (SOPAC 2004). Rainwater is the cheapest freshwater supply source and generally has the highest quality in PICTs.³ Rainwater is also the main source of subsistence irrigation (Gale and deBrun 2017). A variety of factors, from climate change and El Niño and La Niña oscillations to shifts in rainfall belts due to volcanic eruptions, affect rainfall distribution in the Pacific (Higgins et al. 2020) (see Table 2.4 for long term trends of precipitation for some countries). Storage is important to access rainwater, and even high rainfall small islands such as Marshall Islands which receive 2000–4000 mm per year can undergo water stress due to lack of natural storage (SOPAC 2007c).

In PICTs, rainwater roof harvesting and tank storage is the primary source of household and community freshwater, as found prominently on islands such as Tokelau, Solomon Islands, Tuvalu, and some islands in Tonga (Quigley et al. 2016; Falkland and White 2020). On the island of Fongafale, Funafuti atoll, Tuvalu, water supply is a combination of rainwater harvesting and water produced by the island's

² Personal email communication, Peter Sinclair, SPC, 18 December 2020.

³ Personal email communication, Cameron Smith, HunterH2O, Australia, December 2020.

Table 2.4 Long term average precipitation in selected PICTs (UN Water 2021)

Country	Year	Precipitation (mm)
Australia	2018–19	534
Vanuatu	2014	2,000
Samoa	2014	2,880
Papua New Guinea	2017	3,142
Fiji	2017	2,592
Solomon Islands	2017	3,028
New Zealand		1,732

desalination plant.⁴ On the Marshall Islands rainfall is collected from public buildings such as the Majuro High School, Majuro Hospital, and Ebeye Hospital⁵ and, on Majuro atoll, from a concrete runway and pumped to large above-ground storages (Falkland and White 2020). However, in Ebeye, rainwater harvesting issues such as suitability of roofing materials, gutters, downpipes, maintenance of tanks, and contamination were ignored.⁶ In the Cook Islands, large open buildings have been constructed solely to harvest rainwater and store it in 45,000 L concrete storage tanks (Falkland and White 2020). On some outer islands of PNG, plastic barrels placed under the crown of coconut trees collect rainwater for local use (Scott et al. 2003). Despite community-based rainwater harvesting systems working reasonably well in several island states (Bailey et al. 2018), concerns for water quality remain, as monitoring of pathogens and installation of remedial technologies are often overlooked (Kirs et al. 2017). UNESCO’s concept of UNESCO Green Academies might play an important role for rainwater collection, storage, and utilization (Henning et al. 2010; UNESCO, UN Habitat and SEAMEO 2021).

In New Zealand, 10% of the population, mostly in rural areas, depend on rainwater as a source of drinking water (New Zealand Ministry of Health 2019). Australia commenced non-potable rainwater harvesting during the Millennium Drought and it is now the third largest source of water after surface water (dams) and groundwater, constituting 9% of residential water (Rainwater Harvesting Australia 2021).

⁴ According to the Asian Development Bank, “Dry periods longer than 10 days typically result in water shortages, which require desalinated water to be delivered via trucks to household and community tanks” (ADB 2020b).

⁵ Personal email Communication, Stephen Blaik, Asian Development Bank, 8 December 2020.

⁶ Personal email Communication, Stephen Blaik, Asian Development Bank, 8 December 2020.

2.2.4 *Derived Freshwater Sources*

The three main derived freshwater sources supplementing natural sources are desalination of sea water, wastewater reuse, and imported bottled water. These are currently small relative to the naturally occurring sources, and wastewater reuse has not yet become a common source for potable water in PICTs.⁷ Desalination has been the primary source of potable water in Nauru for more than 20 years (SOPAC 2007a). In 2014, Vanuatu established a solar powered desalination plant on Ambae Island and a diesel-powered plant on Aniwa Island to provide freshwater to 11,000 people (PIF 2015). In 2018, a reverse osmosis desalination system was installed to provide clean water for the 800 people that live in Uripiv, Vanuatu. Funafuti has approximately 130,000 L/day supply from two desalination plants. The Republic of Marshall Islands has small suitcase styled desalination units which they deploy during times of emergency to outer islands, as part of their drought response.⁸ Reverse osmosis (RO) units are also used for producing bottled water in Tongatapu, Tonga, and on a small number of tourist islands such as in Cook Islands and Fiji (Falkland and White 2020). These technologically sophisticated desalination systems are appropriate only where and when replacement parts can be obtained reasonably quickly, and trained personnel are available; neither circumstance is common across the Pacific (Allen 2020) except when outsourced to the private sector such as in Ebeye⁹ and Nauru.

Imported bottled water has become an increasingly common source of derived water for drinking in some PICTs, especially as an emergency measure during droughts. In the 2011 drought, New Zealand shipped bottled water to Tuvalu, and Tokelau imported bottled water from Samoa. As bottled water is more expensive than conventional supply in PICTs (Duncan 2011), it is less likely to be a major source. Piping water between islands is another mechanism for water supply as in the case of Samoa, where freshwater is supplied by submarine pipeline over a distance of 4 km from the western end of Upolu to Manono Island (Falkland and White 2020). Bottled water, however, is also likely to cause another problem: plastic pollution.

Treating wastewater of all types and recycling for non-potable and potable water uses may emerge as a significant opportunity for PICTs in the future, should financial and technical capacity gaps be overcome. Treated wastewater is used for irrigation of garden and recreational areas at some tourist resorts and hotels in Fiji (Falkland and White 2020). Seawater and brackish groundwater are used for specific purposes on small islands where and when freshwater is scarce (Alberti et al. 2017). Some atoll islands use brackish groundwater for drinking and cooking during periods of severe drought. Seawater is used for toilet flushing and as a potential source for firefighting in densely populated parts of Tarawa and Majuro atolls and all of Ebeye island, Kwajalein Atoll, Marshall Islands (Falkland and White 2020). In severe water scarcity times, seawater is even used for cooking.

⁷ Personal email Communication, Stephen Blaik, Asian Development Bank, 8 December 2020.

⁸ Personal email, Peter Sinclair, SPC, 18 December 2020.

⁹ Personal email Communication, Stephen Blaik, Asian Development Bank, 8 December 2020.

Australia follows the global trend of increasing use of desalination as a source of drinking water (Lattemann et al. 2010; Turner et al. 2016), both as primary and supplemental sources during droughts (as discussed in detail in Chap. 8. New Zealand's reliance on desalinated water is low, although it has been considered as a promising option for drought-hit Auckland). Recycling wastewater is an increasing trend in Australia since 1990 (Radcliffe and Page 2020) and New Zealand in urban areas, especially for irrigation and toilet flushing.

2.3 Demand and Supply Status

Water demand in Oceania is gradually increasing due to ongoing urbanization, population growth, and expanding economic activity (see Table 2.10 in Appendix 1). While advanced economies are able to meet most of the water demand, in the case of PICTs, about 6.9 million people cannot access improved sanitation and more than 4.8 million cannot access improved water supplies (WHO 2016). Improvements have been slow, with improved sanitation increasing from 29% in 1990 to 31% in 2015, and improved water sources from 46% in 1990 to 52% in 2015 (WHO 2016).

Most PICTs are urbanizing rapidly (Keen and Barbara 2016), with growing informal settlements (ADB 2016; Sanderson and Bruce 2020). Urban centres are generally supplied by public water utilities which are slowly improving their capacity to supply clean water and safely treat wastewater. Private water service providers are infrequent but are emerging as a key player as in the case of Port Vila, Vanuatu (SOPAC 2007b; UTS 2011).

All too often urban water supply can be unreliable, of limited availability, suffer leaks and illegal connections, be contaminated, and not generate adequate revenue for asset maintenance (Duncan 2011; Allen 2020). This issue is particularly challenging as informal communities in urban and peri-urban areas are the fastest growing communities in PICTs, with population growth rates of up to 26% per year, for example in some Honiara informal settlements (World Bank et al. 2015). A unique form of village cities has physically developed around a patchwork of native and traditional villages on customary land, creating a mosaic of towns and native and traditional villages (ADB 2016). The rapid rate of urbanization and growth of informal communities pose a profound challenge to providing services and building overall community resilience (Sanderson and Bruce 2020). Populations settling on and around water reserves are a major threat to water quality and quantity due to the lack of regulation for protecting water sources either from pollution or over-abstraction. Increasing urbanization is occurring on islands already water stressed such as Fongafale (Tuvalu), Tarawa (Kiribati) and Majuro and Ebeye (Marshall Islands). Port Moresby, PNG, with a population nearing one million, has a water supply designed to supply about 250,000 people. Honiara, Solomon Islands, is another example of urbanization stressing water supply, growing at more than twice the national population growth rate (preliminary 2019 census data indicates that the average annual growth rate in Honiara between 2009 and 2019 was about 5.6%).

Water quality is a major challenge in urbanizing areas of PICTs. Typically, about 10% of all deaths of children less than five years old in the Pacific islands are attributable to diarrheal diseases. About 90% of these diseases can be attributed to the lack of sanitation treatment systems, high levels of unimproved drinking water, and poor hygiene (WHO and SOPAC 2008), although the overall health impacts may be significantly higher with an indirect influence of these risk factors on many other causes of death.

In rural and remote areas, accounting for 70% of the population, collecting and storing drinking water from rain or local surface sources is an ongoing individual, family, and/or community task and disproportionately the responsibility of women and girls. Here, buying bottled water for drinking and food preparation is not an option due to lack of funds and/or local availability of bottled water (Anthonj et al. 2020).

Rural water supply systems are often managed by village or island councils or community ‘water committees.’ In some cases, such as village water supply schemes in Tonga, a small fee is charged to households to cover operational expenses (Falkland and White 2020). Across the Pacific, water utilities often have no commercial incentive to extend services to informal or remote settlements.

Australia’s water consumption is dominated by the agricultural sector which uses 50% (Jackson et al. 2017). The regional distribution of use is highly uneven across Australia. Despite being a water-rich country, New Zealand’s largest cities face water scarcity because of an increasingly variable climate, aging infrastructure, and growing populations (Talbot-Jones et al. 2020).

2.4 Threats to Water Security

Freshwater in the Pacific is becoming increasingly limited because of increasing demand (e.g., population growth and tourism) and decreasing supply (e.g., pollution and precipitation patterns) (UNESCO and UN Water 2020). Drinking water and sanitation coverage in most PICTs falls short of global averages (Hadwen et al. 2015). Sea level rise and extreme events related to climate change have significant additional impacts on water security (UNGA 2014). Exacerbated by weak governance, Pacific countries are amongst the most vulnerable in the world to disasters, which are becoming more intense and more frequent (Kumar et al. 2020).¹⁰ Climate change impacts and threats are covered in more detail in Chaps. 5 and 11.

¹⁰ In 2014, the UN Conference on Small Island Developing States in Samoa detailed numerous threats facing the region, including: overexploitation of surface, ground, and coastal waters; saline intrusion; drought and water scarcity; soil erosion, inadequate water, and wastewater treatment; and lack of access to sanitation and hygiene.

2.4.1 Climate Extremes and Related Disasters

Climate change is a major challenge to the Pacific islands (Nurse et al. 2014; Barnett and Waters 2016; Kumar et al. 2020; McNamara et al. 2020), widely recognised as an impact multiplier for many of the challenges that the water sector already faces (Burns 2002; Holding et al. 2016; Chand et al. 2017; Day et al. 2019; Oppenheimer et al. 2019). Various projections of climate impacts differ significantly between and within PICTs (see Table 2.5), yet increasing water security risks is common in these assessments. IPCC 2014 concluded that current and future climate-related drivers of risk for small islands during the twenty-first century include sea level rise (SLR), tropical and extratropical cyclones, increasing air and sea surface temperatures, and changing rainfall patterns (Nurse et al. 2014). The Pacific Climate Change Science Programme (PCCSP) additionally anticipates that the Pacific will experience an increase in extremely hot days, extreme rainfall events, and ocean acidification. Sea-level rise is expected to be 0.18–0.59 m by 2080–2099 relative to 1980–1999. Droughts are projected to occur less often, but with increased severity. Annual average rainfall is expected to increase. Tropical storms and cyclones are expected to decrease in frequency but increase in intensity. The intensifying risk of cyclones, coupled with sea-level rise, will bring more disruptions in water supply systems and increased salinization of groundwater lenses, through storm surge overtopping.

Table 2.5 Summary of climate change projections for the Pacific (after Falkland and White 2020, based on Australian Bureau of Meteorology [BOM] and Commonwealth Scientific and Industrial Research Association [CSIRO] 2014)

Country	Mean rainfall	Drought frequency and duration	Extreme rainfall frequency and intensity	Tropical cyclone frequency
Cook Island	Similar	Similar	Increase	Decrease
FSM	Increase	Decrease	Increase	Decrease
Fiji	Little change	Slight decrease	Increase	Decrease
Kiribati	Increase	Decrease	Increase	No projections
Marshall Islands	Increase	Decrease	Increase	Decrease
Nauru	Increase	Decrease	Increase	No projections
Niue	Slight increase	Slight decrease	Increase	Decrease
Palau	Increase	Decrease	Increase	Decrease
PNG	Increase	Decrease	Increase	Decrease
Samoa	Little change	Similar	Increase	Decrease
Solomon Islands	Slight increase	Slight decrease	Increase	Decrease
Tonga	Little change	Slight decrease	Increase	Decrease
Tuvalu	Little change	Slight decrease	Increase	Decrease
Vanuatu	Little change	Similar or slight decrease	Increase	Decrease

Rainfall across the southern Pacific islands is strongly influenced by the El Niño Southern Oscillation (ENSO) phenomenon (see Chap. 5), whose characteristics will also be altered by climate change. The La Niña drought of 2011 severely impacted parts of Samoa, Tokelau and Tuvalu placing Tokelau and Tuvalu under states of emergency and requiring bottled water supply from donors (Kuleshov et al. 2014). Cyclones and heavy rainfall events can damage water supply infrastructure or contaminate drinking water supplies on volcanic islands or continental coastal areas. Sea-level rise is expected to inundate 4500 km of PNG's total shoreline affecting 30% of the country's population by 2050 (World Bank 2011).

The dependence of food production upon rain-fed agriculture across all PICTs means that their economies and livelihoods are particularly vulnerable to drought and rainfall variability caused by both cyclical influences of ENSO and anthropogenically-forced changes to the climate system. Increased variability in rainfall patterns, particularly more intense drought periods, significantly increases the freshwater vulnerability of islands such as Tuvalu and Kiribati. In rural PNG, the droughts of 1997–1998 and 2015–2016 affected over a million people, impacting water, and food security and many other sectors (PNG National Disaster Centre 2016).

Oceania has the highest regional disaster risk profile (Day et al. 2019) due to its exposure to extreme natural events¹¹ and because it is strongly affected by sea-level rise. Countries at particularly high risk are Vanuatu, Tonga, Solomon Islands, PNG, and Fiji. Critically, some of the Pacific countries at greatest risk to natural disasters are those that are the least developed to manage these risks (UNCTAD 2005).

The intense cyclonic rainfall and runoff experienced in several large volcanic islands has caused flooding on the coastal plains. In Vanuatu, Cyclone Pam damaged or contaminated water supplies leaving nearly half of the population (110,000) without drinking water (Handmer and Iveson 2017). Again, in Vanuatu, Cyclone Harold hit amidst COVID-19 lockdown, restricting movement of people and supplies needed to assist the cyclone-affected communities.

2.4.2 Pollution, Water Quality, and Development

Mortality rate attributed to unsafe water, sanitation, and hygiene services appear to be associated with Human Development Index (HDI) rank. Australia (HDI rank 8) and New Zealand (HDI rank 14) have a mortality rate of children under 5 years of age of 3.1 and 4.7 per 1000 births respectively, Fiji (HDI rank 93) has 21.6, Samoa (HDI rank 111) has 13.6, Tonga (HDI rank 104) has 13.4 (UNDP 2020). In PICTs, surface water and rainwater are subject to microbial (viral, bacterial, fungal,

¹¹ Risk assessment covers exposure to these hazards: earthquakes, cyclones, floods, drought, and sea level rise.

Table 2.6 Percentage of people adopting open defecation (UN Water 2021)

Country	Year of data	Open defecation %
French Polynesia	2006	1.52
Cook Islands	2012	1.12
Micronesia (Federated States of)	2014	9.5
Kiribati	2017	28.45
Marshall Islands	2017	10.06
Nauru	2017	2.59
Papua New Guinea	2017	14.47
Solomon Islands	2017	53.69
Oceania (excluding Australia and New Zealand)	2017	13.94
Australia and New Zealand	2017	0

Table 2.7 Proportion of treated sewage for some countries with available data (UN Water 2021)

Country	Year	Percentage of treated sewage
Tuvalu	2015	0
Papua New Guinea	2015	6.5
Palau	2015	0
New Zealand ^a	2016	84
Australia ^a	2018	93

^aAustralia and New Zealand data based on Statista (2021)

protozoan, etc.) contamination often in contact with organic debris. Besides salt, such microorganisms are the major contaminants of freshwater in Pacific islands, while metal, mineral, pesticide, or other chemical contamination are generally much less of an issue (Allen 2020). Many such pathogens can induce illness. Countries in Oceania vary widely in terms of sanitation services, as exemplified by the rate of open defecation (Table 2.6) and percentage of sewerage treated (Table 2.7).

Agricultural chemical use, such as fertilizers and pesticides, increased significantly from the mid-1990s in the Pacific region and continues to be a threat to water supplies and ecosystem health (Diarra and Surendra 2020). Sediment loads arising from agricultural and forestry activities also compromise water treatment capacity in water supplies (Duncan 2011).

The highly porous nature of the sandy, calcareous, and volcanic soils commonly found on PICTs makes many groundwater resources (especially shallow aquifers) and surface waters vulnerable to pollution from sanitation systems (Duncan 2011; Dixon-Jain et al. 2014). Aquifers have been polluted through septic tank seepage, as was reported in Majuro (Marshall Islands) and Tarawa (Kiribati) where water was compromised by septic tank seepage from densely populated urban areas overlying shallow aquifers (Falkland 2002). Septic tank seepage is also a significant source of contamination of Port Vila Harbour, Vanuatu, leading to the banning of swimming.

Eutrophication of waters from leaking sanitation systems and agricultural chemicals has been identified as the major threat to Pacific aquatic ecosystems (Duncan 2011).

While the proportion of the population using improved sanitation facility is 99.4% for Australia and New Zealand, it is only for 34.2% for other countries in Oceania (UN Water 2021).

The hydropower potential of Pacific islands is being increasingly recognised (Hourçourigaray et al. 2014) but is also a threat to freshwater systems by altering natural flow regimes. Hydropower systems do offer a potential co-benefit to water supply systems which require a consistent daily flow that is supported by storage to cover dry periods. Consideration of this dual benefit to water security requires a more holistic consideration of hydropower schemes.

Mining is a significant source of income in Papua New Guinea and Nauru; however, impacts of mine waste are potentially catastrophic (Duncan 2011). For example, the Ok Tedi Mine located in the central PNG highlands has severely impacted the Fly River by discharging tonnes of waste and tailings into the river for decades (Carr 2007). This shows that local mining impacts can be extreme and affect a much wider environment. In Fiji, mineral extraction has been raised as a concern regarding its impact on rivers and waterways, identifying the need for more effective regulations (UNDP and SPC 2018).

Deforestation in catchments of volcanically young, high islands has led to massive soil erosion and impacts upon wetlands (SPREP 2011). Soil erosion and sediment loads are a significant threat to freshwater ecosystems and near-shore reefs and potentially compromise water treatment capacity in water supplies. In Honiara, Solomon Islands, water quality of the Kongulai Spring, which is the source of about 40% of the city's water, is compromised by logging (deforestation) and in 2019 resulted in 59 shutdowns of the water source as turbidity exceeded public health standards (20 NTU). To address this issue, Solomon Water is investing in a new water treatment plant.

Contaminants of emerging concern (CECs) are ubiquitous globally (OECD 2017, 2020) but research on these contaminants is limited across the Pacific. These include pharmaceuticals, hormones, antibiotics, micro/nanoplastics, industrial and household chemicals, personal care products, pesticides, and flame retardants.

2.5 Current Efforts and Future Priorities to Achieve Water Security

PICTs face intensifying challenges to achieve adequate access to sanitation and safe drinking water, protect sensitive ecosystems, and generate productive use of variable water resources (Duncan 2011; Gheuens et al. 2019). These challenges require innovative approaches and tailoring of solutions to the complex combination of geographical and socio-economic constraints of individual islands. Despite being

Table 2.8 State of national water security in some PICTs as defined by ADB (2020a)

Country	Population (in thousands)	NWS score		
		2013	2016	2020
Cook Island	19	66.3	70.4	72.5
Fiji	886	57.1	59.8	59.5
Kiribati	113	45.8	45.8	48.2
Marshall Islands	55	42.9	40.9	48.9
Federated State of Micronesia	103	39.5	37.7	42.0
Nauru	11	55.9	62.0	58.6
Niue	1.7	55.5	59.9	61.0
Palau	18	62.8	69.4	73.0
Papua New Guinea	9,019	41.1	42.8	42.8
Samoa	198	57.2	62.9	62.8
Solomon Islands	667	51.9	49.6	49.3
Tonga	100	61.4	61.4	61.5
Tavalu	12	47.1	48.3	53.0
Vanuatu	285	51.1	49.7	49.9
Average population weighted	11,485	44.1	45.5	45.4
Average without PNG	2,466	55.3	55.3	54.7

Note The NWS score represents an index of water security compared to the total water security situation of 100

a global hotspot of water insecurity, ADB (2020a, b) shows some positive trends in water security from 2013 to 2020 (Table 2.8).

Some innovative solutions are offering new ways for Pacific communities to enhance their water security and resilience (Poustie et al. 2016) and self-sufficiency. Water sensitive cities' principles are being trialled as part of the RISE (Revitalising Informal Settlements and their Environments) program in Fiji whereby local solutions are being integrated with broader water resource management to improve public health (CRC-WSC 2020). New water filtering technologies are increasing effectiveness and decreasing costs of local treatment (Allen 2020).

In a significant regional policy commitment made in 2014 and known as Samoa Pathway (United Nations 2014), Pacific states committed collectively to:

- develop institutional and human capacities for the effective, inclusive, and sustainable implementation of the integrated management of water resources;
- provide and operate appropriate facilities and infrastructure for safe drinking water, sanitation, hygiene, and waste management systems;
- facilitate the expansion of wastewater treatment, recycling, and reuse;
- improve water-use efficiency and work towards eliminating over-extraction, especially of groundwater, and to mitigate the effects of saltwater intrusion.

Despite such clearly articulated policy visions, PICTs face several challenges to achieve SDG 6.

First, the water supply and sanitation challenge is particularly difficult for rural and remote communities that account for 70% of the region's population. Informal urban settlements often have poor sanitation facilities, and water quality alongside high population densities. Water, sanitation, and hygiene (WASH) services remain inadequate in hospitals of the Pacific (Mannava et al. 2019). According to UNICEF (2020), PNG lies at the bottom of all Pacific countries in water and sanitation ranking, with over 6,000 diarrheal deaths per year.

Second, the problems of water management and policy are rooted in some of the unique socio-cultural dynamics of the region: (1) coexisting formal and informal governance types, (2) customary land tenure and attitudes toward land and water ownership, (3) tensions between urbanizing societies and the traditional values of subsistence communities, (4) a lack of trust in the capacity of institutions to provide core services, and (5) traditional gender roles related to water collection. Most PICTs lack gender disaggregated data and policy response (Michalena et al. 2020). Water governance is often centralized, focused within a few government agencies, with limited coordination between agencies, communities, and the private sector. National water and sanitation regulations are limited in scope or absent, and institutional roles and responsibilities are unclear in many situations. Situations of 'legal pluralism' exist wherein indigenous rules come in conflict with the formal state legislations (Roche et al. 2019).

Third, PICTs have high dependency on overseas support, receiving official development assistance exceeding 30% of their GDP (Duncan 2011) (see Table 2.11 in Appendix 1). Private financing of water and sanitation services is limited due to poor cost recovery and a lack of 'economies of scale.' Coordination between donors and other international and local organizations is generally weak. A recent assessment of 32 community-based adaptation initiatives across 20 communities in the Pacific suggests a shift towards adaptation that is locally led, with donors and implementers becoming facilitators rather than providing highly prescriptive models (McNamara et al. 2020).

Fourth, the low capacity of the water sector in PICTs remains a critical challenge (Paeniu et al. 2016; Dahan 2018). Many countries have small administrations dealing with the varying complexities of main and outer island issues, without the economies of scale. In addition, most PICTs have very small numbers of trained water resources specialists, and their ability to undertake strategic planning and action is often limited. In a 2007 assessment of IWRM in the Pacific, all the countries identified a lack of water resources expertise and baseline knowledge as being a barrier to informed decision-making related to water management (SOPAC and UNDP 2007). A 2018 report again identified expertise and institutional capacity as the major limiting factors in the water sector in PICTs (Dahan 2018). Hence fit-for-purpose training, as well as increased formal water and environmental education will be an essential component of improving water security in the long term.

Fifth, integration across development, climate change adaptation, and disaster risk management remains weak. For example, in Tarawa, Kiribati, the threat of sea-level rise and drought exacerbates the existing development pressures of rapid urbanization, pollution, and poor sanitation. However, the population of South Tarawa has developed sophisticated strategies for coping with inadequate water supply.¹² Households follow several advanced water scarcity management principles, such as diversification of water resources, fit-for-purpose water use, thrifty water consumption, and adaptive strategies of water use, depending on the local level of water stress. Collectivism and water sharing also play a critical role in reducing affordability challenges, water-related conflicts, and vulnerability to drought.

Sixth, there is inadequate water data collection, infrastructure, data analysis, and reporting to generate action-oriented knowledge to inform decision making in most Pacific countries (Kohlitz et al. 2016; Catchlove et al. 2019). Communication across sectors and between communities and government is often disjointed. Information may also be unavailable due to a lack of data sharing and limited coordination between bodies responsible for water management (Dahan 2018). Data on river health and threats of many islands is incomplete (Bunn et al. 2019). Researchers have also highlighted the need for strengthening local to regional scale information management and knowledge brokering (Morioka et al. 2019).

2.6 Conclusion

Countries and territories in Oceania vary greatly in terms of freshwater availability and water security. Of the largest nations, Australia and New Zealand are at an advanced stage of water security; Papua New Guinea, the third largest nation, struggles to ensure water security despite being endowed with plenty of surface and groundwater. The freshwater resources of PICTs are generally limited and highly variable both spatially and temporally. PICTs also face the additional challenges of remoteness, small size, fragility, natural vulnerability, and limited human and financial resources, which continue to inhibit progress with SDG 6, despite having considerable donor support. Climate change is altering long-term rainfall patterns and exacerbating extreme events such as floods, droughts, and cyclones.

Whilst surface and groundwater resources are available on high volcanic islands, they are limited on small, low-lying coral and limestone atolls, giving rise to a greater dependence on rainfall. Available water resources are also subject to multiple threats—untreated human effluent, mine wastes, agricultural chemicals, and sediments from forestry operations. Freshwater lenses are facing saline intrusion from over-exploitation, sea-level rise, and storm surges. The development of water

¹² Specific examples of improving South Tarawa resilience to climate change are recorded by the World Bank (2019) and provide potential solutions to other islands under water stress.

resources for human uses has focused on established urban centres, whilst informal, smaller, and remote communities frequently lack basic water services. Rainwater harvesting, desalination, and bottled water have helped poorer communities in rural areas to meet household water demands.

The future water security of Pacific islands will be determined by the effectiveness of climate change adaptation and disaster risk management, integrated with development efforts. Investment in infrastructure, institutional capacity, and knowledge systems, co-designed in island specific contexts, will be essential. Improved implementation of enabling national policies and legislation, will help mitigate freshwater vulnerability. Sustained capacity development and retention, focusing particularly on gender equality and social inclusion, will have a positive impact across all water related sectors. Enhanced data collection, analysis, and conversion to actionable knowledge will underpin water security.

If access to improved water and sanitation is to be effectively promoted in Pacific island countries, governments must continue to refine policy to ensure good governance and service delivery. A mixture of integrated water resources management, nature-based solutions, and appropriate infrastructure is required to advance SDG 6 across the Pacific region. There is also an opportunity to deepen partnerships and cooperation between advanced water management countries such as Australia and New Zealand and the PICTs.

Acknowledgements We are grateful for comments and inputs from Jim Keary, Alan Thornton and Cameron Smith (Hunter H2O), Stephen Blaik (ADB), Shona Fitzgerald and Stephane Dahan (World Bank), and Peter Sinclair (Pacific Community). We also thank editors for useful comments and advice on sourcing data and defining the scope of the chapter.

Appendix 1: State of Water Resources by Country

See Tables [2.9](#), [2.10](#), [2.11](#).

Table 2.9 Overview of freshwater availability in the Pacific where data is available

Country	Total renewable water resources $M m^3 \cdot yr^{-1}$	Average rainfall $mm \cdot yr^{-1}$	Water use $M m^3 \cdot yr^{-1}$	Total rainfall $M m^3 \cdot yr^{-1}$	Rainfall productivity $\$/m^{-3}$	Primary water resources	Range of mean annual rainfall in country (mm)	Groundwater renewable resource $M m^3 \cdot yr^{-1}$
American Samoa	No data	No data	No data	No data	No data	SW, GW	300–600	No data
Australia	4,40,000	534	24,450	3,700,000		SW, GW	50–3,500	72,000
Cook Islands	564	2,040	4.45	140	0.48	SW, GW, RW	1,800–4,500	No data
Federated States of Micronesia	20,346	4,115	No data	2,900	0.08	SW, GW, RW, d	2,600–8,200	No data
Fiji	28,550	2,592	70	56,000	0.05	SW, GW, RW	1,500–6,000	No data
Kiribati	218	2,000	No data	1,600	0.09	GW, RW, d	900–3,100	No data
Marshall Islands	~0	2,900	1.7	610	0.24	RW, GW, d	1,200–4,000	No data
Nauru	~0	2,160	0.42	48	0.42	d, RW, GW		No data
New Zealand	327,000	1,732	No data	No data	No data	No data	600–1,600	612,000
Niue	~0	2,180	0.002	570	0.03	GW, RW		No data
Palau	1,100	3,780	5.5	1,700	0.10	SW, GW, RW	3,200–4,300	No data
Papua New Guinea	801,000	3,142	392	1,100,000	0.01	SW, GW, RW	900–9,000	No data
Samoa	132,817	2,880	12.4	8,400	0.06	SW, GW, RW	2,500–7,500	No data

(continued)

Table 2.9 (continued)

Country	Total renewable water resources $M m^3 \cdot yr^{-1}$	Average rainfall $mm \cdot yr^{-1}$	Water use $M m^3 \cdot yr^{-1}$	Total rainfall $M m^3 \cdot yr^{-1}$	Rainfall productivity $\$/m^3$	Primary water resources	Range of mean annual rainfall in country (mm)	Groundwater renewable resource $M m^3 \cdot yr^{-1}$
Solomon Islands	44,700	3,028	No data	92,000	0.01	SW, GW, RW	1,800–9,000	No data
Tonga	~0	2,060	No data	1,300	0.20	GW, RW	1,700–2,500	No data
Tuvalu	~0	2,850	0.22	74	0.24	RW, GW, d	2,400–4,000	No data
Vanuatu	10,000	2,000	1,227	29,000	0.18	SW, GW, RW	2,000–4,000	No data

Duncan (2011). Last column data adopted from Kumar et al. (2020). Australia and New Zealand data: Authors research
 SW Surface water, GW Groundwater, RW rainwater, d desalination

Table 2.10 Water demand in countries with available data (FAO 2021)

Country	Year	Agricultural water withdrawal (10^9 m ³ /year)	Industrial water withdrawal (10^9 m ³ /year)	Municipal water withdrawal (10^9 m ³ /year)	Irrigation water withdrawal (10^9 m ³ /year)	Fresh groundwater withdrawal (10^9 m ³ /year)	Total freshwater withdrawal (10^9 m ³ /year)	Total water withdrawal (10^9 m ³ /year)	Irrigation water requirement (10^9 m ³ /year)	Environmental Flow Requirements (10^9 m ³ /year)
Australia	2017	10.5	2.662	3.392	9.969	4.962 (2000)	15.94	16.55	3.892 (2010)	243.3
Fiji	2005	0.05	0.0096	0.0253	No data	No data	0.0849	0.0849		
New Zealand	2010	3.207	1.184	0.81	2.8	2.564 (2014)	9.875 (2014)	5.201	1.492	204.3 (2017)
Papua New Guinea	2005	0.001	0.1676	0.2235	No data	No data	0.3921	0.3921	No data	504.5 (2017)

Table 2.11 Amount of water and sanitation related official development assistance (million 2019 USD) received by PICTs (UN Water 2021)

Samoa	2019	8
Wallis and Futuna Islands	2019	0.012
Tuvalu	2019	0.026
Tonga	2019	1.1
Tokelau	2019	0
Papua New Guinea	2019	29
Palau	2019	7
Marshall Islands	2019	2.1
Micronesia (Federated States of)	2019	1.5
Northern Mariana Islands	2019	0
Niue	2019	0.011
New Zealand	2019	0
Vanuatu	2019	4.8
New Caledonia	2019	0
Nauru	2019	0.18
Guam	2019	0
Kiribati	2019	5.1
French Polynesia	2019	0
Fiji	2019	21
Cook Islands	2019	1.8
Solomon Islands	2019	17

References

- ADB (2016) The emergence of Pacific urban villages: urbanisation trends in the Pacific Islands. Asian Development Bank, Manila
- ADB (2020a) Asian water development outlook 2020 report. Asian Development Bank, Manila
- ADB (2020b) Tuvalu: preparing for the Funafuti water and sanitation project, project readiness financing report (Project Number 53417-001). Asian Development Bank, Manila
- Alberti LI, La Licata I, Cantone M (2017) Saltwater intrusion and freshwater storage in sand sediments along the coastline: hydrogeological investigations and groundwater modeling of Nauru Island. *Water* 9(10):788. <https://doi.org/10.3390/w9100788>
- Allen E (2020) Building water security on small pacific islands. *Security Nexus*. Daniel K. Inouye Asia-Pacific Center for Security Studies
- Anthonj C, Tracy JW, Fleming L, Shields KF, Tikoisuva WM, Kelly E et al (2020) Geographical inequalities in drinking water in the Solomon Islands. *Sci Total Environ* 712:135241
- Australian Bureau of Meteorology (BoM) and Commonwealth Scientific and Industrial Research Association (CSIRO) (2014) Climate variability, extremes and change in the Western Tropical Pacific: new science and updated country reports. http://www.pacificclimatechangescience.org/wp-content/uploads/2014/07/PACCSAP_CountryReports2014_WEB_140710.pdf
- Bailey RT, Beikmann A, Kottermair D, Taboroši JJW (2018) Sustainability of rainwater catchment systems for small island communities. *J Hydrol* 557:137–146
- Barnett J, Waters E (2016) Rethinking the vulnerability of Small Island States: climate change and development in the Pacific Islands. In: Grugel J, Hammett D (eds) *The Palgrave handbook of*

- international development. Palgrave Macmillan, London, pp 731–748. https://doi.org/10.1057/978-1-137-42724-3_40
- Bunn S, Kennard M, Jackson S (2019) Environmental water management in the Indo-Pacific: An Australian perspective. Australian Water Partnership, Canberra
- Burns WCG (2002) Pacific Island developing country water resources and climate change. In: Gleick PH, Burns WCG, Chalecki EL, Cohen M, Cushing KK, Mann AS, et al (eds) *The world's water 2002–2003: the biennial report on freshwater resources*, pp 113–131
- Carr F (2007) Government decision making and environmental degradation, Masters thesis, Murdoch University, Australia
- Catchlove R, Stewart B, Hankinson A (2019) Pacific countries and territories hydrological capacity assessment and needs. A report for Pacific Hydrological Services Panel and SPREP
- Chand SS, Tory KJ, Ye H, Walsh KJE (2017) Projected increase in El Niño-driven tropical cyclone frequency in the Pacific. *Nat Clim Change* 7(2):123–127. <https://doi.org/10.1038/nclimate3181>
- CRC-WSC (2020) Technical design of water sensitive urban design solutions project statistics—Suva, Fiji and Indonesia. <https://watersensitivecities.org.au/institute/technical-design-of-water-sensitive-urban-design-solutions/>. Accessed 22 Dec 2020
- Dahan S (2018) Rapid review of water knowledge for Pacific small islands developing states (June 2018). World Bank Group
- Day SJ, Forster T, Misereor JH, Korte L, Mucke P, Radtke K, Thielböcker P, Weller D (2019) World risk report 2019-focus: water supply
- Diarra I, Surendra P (2020) The current state of heavy metal pollution in Pacific Island Countries: a review. *Appl Spectrosc Rev* 56(1):27–55. <https://doi.org/10.1080/05704928.2020.1719130>
- Dixon-Jain P, Norman R, Stewart G, Fontaine K, Walker K, Sundaram B, Flannery E, Riddell A, Wallace L (2014) Pacific Island groundwater and future climates, Geoscience Australia, Department of Environment, Australian Government. RECORD 2014/43
- Duncan D (2011) Freshwater under threat: Pacific Islands—vulnerability assessment of freshwater resources to environmental change. United Nations Environment Programme, Bangkok
- Ellison JC (2009) Wetlands of the Pacific Island region. *Wetlands Ecol Manage* 17:169–206. <https://doi.org/10.1007/s11273-008-9097-3>
- Falkland A (1993) Hydrology and water management on small tropical islands. Hydrology of Warm Humid Regions. In: *Proceedings of the Yokohama symposium, July 1993*. IAHS Publ. no. 216:263–303
- Falkland A (2002) A synopsis of information relating to the quality of freshwater and watershed management issues in the Pacific Islands Region. *Issues for Community-based Sustainable Resource Management and Conservation: Considerations for the Strategic Action Programme for the International Waters of the Pacific Small Island Developing States, Vol. 2, Technical Report 2002/02*, SPREP Apia
- Falkland T (2015) Water resources management in the Pacific Islands, Workshop on Enhancing climate indices for sector-specific applications in the Pacific Islands region, World Meteorological Organisation Fiji Meteorological Services, pp 1–28
- Falkland T, White I (2020) Freshwater availability under climate change. In: Kumal L (ed) *Climate change and impacts in the Pacific*. Springer Climate. Springer, Cham, pp 403–448. https://doi.org/10.1007/978-3-030-32878-8_11
- FAO (2021) AQUASTAT main database, Food and Agriculture Organization of the United Nations (FAO), Roam. <http://www.fao.org/nr/water/aquastat/data/query/index.html?lang=en>. Accessed 11 Sept 2020
- Gale A, deBrun H (2017) Water challenges in the Marshal Islands: managing drought in a high rainfall Atoll country. *Water e-Journal* 2(2). <https://doi.org/10.21139/wej.2017.018>
- Geoscience Australia (2020) Groundwater. <https://www.ga.gov.au/scientific-topics/water/groundwater/basics/what-is-groundwater>. Accessed 29 Mar 2021
- Gheuens J, Nagabhatla N, Perera E (2019) Disaster-risk, water security challenges and strategies in Small Island Developing States (SIDS). *Water* 11(4):637. <https://doi.org/10.3390/w11040637>

- GNS Science (2021) Groundwater: addressing water exploration, quality and management. <https://www.gns.cri.nz/Home/Our-Science/Environment-and-Climate/Groundwater>. Accessed 29 Mar 2021
- Hadwen WL, Powell B, MacDonald MC, Elliott M, Chan T, Gernjak W, Aalbersberg WG (2015) Putting WASH in the water cycle: climate change, water resources and the future of water, sanitation and hygiene challenges in Pacific Island Countries. *J Water Sanit Hyg Dev* 5(2):183–191
- Handmer J, Iveson H (2017) Cyclone Pam in Vanuatu: learning from the low death toll. *Aust J Emerg* 32(2):60–65
- Henning S, Breulmann M, Sutcliffe M, Böer B, Al-Hashimi N, Batanouny K, et al (2010) Enhanced water-, energy-, and waste-management in Arab urban ecosystems—globally applicable, UNESCO, Doha Office. [Better Buildings - Enhanced water-, energy-, and waste-management in Arab urban ecosystems - globally applicable \(quest4action.org\)](https://www.quest4action.org/Better-Buildings-Enhanced-water-energy-and-waste-management-in-Arab-urban-ecosystems-globally-applicable)
- Higgins PA, Palmer JG, Turney CSM, Andersen MS, Cook ER (2020) One thousand three hundred years of variability in the position of the South Pacific convergence zone. *Geophys Res Lett* 47(17):e2020GL088238
- Holding S, Allen DM, Foster S, Hsieh A, Larocque I, Klassen J, Van Pelt SC (2016) Groundwater vulnerability on small islands. *Nat Clim Change* 6:1100–1103. <https://doi.org/10.1038/nclimate3128>
- Hourcougharay J, Wary D, Bitot S (2014) Renewable energy in the Pacific Islands: an overview and exemplary projects. Research and Development Division (RED), AFD
- Jackson W, Argen R, Bax N, Clark G, Coleman S, Cresswell I, Emmerson K, Evans K, Hibberd M, Johnston E, Keywood M (2017) Australia state of the environment 2016: overview. Department of the Environment and Energy (Australia)
- Keen M, Barbara J (2016) Pacific urbanisation: changing times, Devpolicy Blog. 25 February 2016. Australian National University, Canberra. [https://devpolicy.org/pacific-urbanisation-changing-times-20160225/#:~:text=Pacific%20island%20countries%20are%20rapidly,growth%20rate%20\(Figure%201\).&text=Without%20adequate%20urban%20policies%2C%20planning,expansion%20can%20hinder%20economic%20growth](https://devpolicy.org/pacific-urbanisation-changing-times-20160225/#:~:text=Pacific%20island%20countries%20are%20rapidly,growth%20rate%20(Figure%201).&text=Without%20adequate%20urban%20policies%2C%20planning,expansion%20can%20hinder%20economic%20growth). Accessed 22 Dec 2020
- Kirs M, Moravcik P, Gyawali P, Hamilton K, Kisand V, Gurr I, Shuler S, Ahmed W (2017) Rainwater harvesting in American Samoa: current practices and indicative health risks. *Environ Sci Pollut Res Int* 24(13):12384–12392
- Kohlitz J, Chong J, Willetts J (2016) Monitoring the human rights to water and sanitation: an analysis of policy in Pacific island countries. *Water Policy* 189(6):1436–1453. <https://doi.org/10.2166/wp.2016.007>
- Kuleshov Y, McGree S, Jones D, Charles A, Cottril DA, Prakash B et al (2014) Extreme weather and climate events and their impacts on island countries in the Western Pacific: cyclones, floods and droughts. *Atmos Clim Sci* 4(5):803–818
- Kumar L, Jayasinghe S, Gopalakrishnan T, Nunn PD (2020) Climate change and the Pacific Islands. In: Kumar L (ed) *Climate change and impacts in the Pacific*. Springer, Cham, pp 1–31
- Lal A, Datta B (2019) Optimal groundwater-use strategy for saltwater intrusion management in a Pacific Island Country. *J Water Res Plan Manag* 145(9):04019032
- Lattemann S, Kennedy MD, Schippers JC, Amy G (2010) Global desalination situation. In: Escobar IC, Schäfer AI (eds) *Sustainability science and engineering*, vol 2. Sustainable Water for the Future. Elsevier, The Netherlands, pp 7–39
- Mannava P, Murray JC, Kim R, Sobel HL (2019) Status of water, sanitation and hygiene services for childbirth and newborn care in eight countries in East Asia and the Pacific. *J Glob Health* 9(2). <https://doi.org/10.7189/jogh.09.020430>
- McKenzie, M (2017) Collaborating for success: sustaining water supply on a Pacific Island. <https://toolkit.climate.gov/case-studies/collaborating-success-sustaining-water-supply-pacific-island>. Accessed 18 Dec 2020
- McNamara KE, Clissold R, Westoby R, Piggott-McKellar AE, Kumar R, Clarke T et al (2020) An assessment of community-based adaptation initiatives in the Pacific Islands. *Nat Clim Change* 10(7):628–639

- Michalena E, Straza TRA, Singh P, Morris CW, Hills JM (2020) Promoting sustainable and inclusive oceans management in Pacific islands through women and science. *Mar Pollut Bull* 150:110711
- Ministry for the Environment and Stats New Zealand (2020) New Zealand's environmental reporting series: our freshwater 2020 Summary. <https://www.mfe.govt.nz/overview-our-freshwater-2020#summary>
- Morioka K, McGann M, Mackay S, Mackey B (2019) Applying information for climate change adaptation planning and decision making in the Pacific: situation analysis. Griffith University, Brisbane
- New Zealand Ministry of Health (2019) Guidelines for drinking-water quality management for New Zealand. Chapter 19: Small, individual, and roof water supplies, May 2019
- Nurse LA, McLean RF, Agard J, Briguglio LP, Duvat-Magnan V, Pelesikoti N, et al. (2014) In: Barros VR, Field CB, Dokken DJ, Mastrandrea MD, Mach KJ, Bilir TE (eds) *Climate change 2014: impacts, adaptation, and vulnerability. Part B: Regional aspects. Contribution of Working Group II to the fifth assessment report of the intergovernmental panel on climate change*. Cambridge University Press, Cambridge, United Kingdom and New York, NY, USA, pp 1613–1654
- OECD (2017) Diffuse pollution, degraded waters: emerging policy solution. OECD studies on water. OECD Publishing, Paris. https://read.oecd-ilibrary.org/environment/diffuse-pollution-degraded-waters_9789264269064-en#page1. Accessed 20 Dec 2020
- OECD (2020) OECD work on water 2019–20. https://issuu.com/oecd.publishing/docs/brochure-oecd_work-on-water. Accessed 10 Dec 2020
- Oppenheimer M, Glavovic BC, Hinkel J, van de Wal R, Magnan AK, Abd-Elgawad A, et al (2019) Sea level rise and implications for low-lying islands, coasts and communities. In: Pörtner HO, Roberts DC, Masson-Delmotte V, Zhai P, Tignor M, Poloczanska E (eds) *IPCC special report on the ocean and cryosphere in a changing climate*
- Paeniu L, Yuen L, Samani T, Iese V, Tuisavusavu A, Koroi A et al (2016) Overview of water security in Pacific Islands with recommendations for best practices. The University of the South Pacific. Suva, Fiji, Pacific Centre for Environment and Sustainable Development (PaCE-SD)
- PIF (2015) Vanuatu PEC fund profile. Pacific Regional Data Repository, Pacific Island Forum Secretariat. <http://prdrse4all.spc.int/data/vanuatu-pec-fund-profile>
- PNG National Disaster Centre (2016) El Niño 2015–2016 post drought assessment, Report of the Interagency Post Drought Assessment in Papua New Guinea, 50 p
- Poustie MS, Frantzeskaki N, Brown RR (2016) A transition scenario for leapfrogging to a sustainable urban water future in Port Vila, Vanuatu. *Technol Forecast Soc Change* 105:129–139
- Prosser I (2011) Current water availability and use. In: Prosser I (ed) *Water: science and solutions for Australia*. CSIRO, Melbourne, pp 1–16
- Quigley N, Beavis SG, White I (2016) Rainwater harvesting augmentation of domestic water supply in Honiara, Solomon Islands. *Aust J Water Resour* 20(1):65–77
- Radcliffe JC, Page D (2020) Water reuse and recycling in Australia-history, current situation and future perspectives. *Water Cycle* 1:19–40
- Rainwater Harvesting Australia (2021) About rainwater harvesting. <https://rainwaterharvesting.org.au>. Accessed 29 Mar 2021
- Roche JR, Govan H, Schlüter A, Ferse SC (2019) A legal pluralism perspective on coastal fisheries governance in two Pacific Island countries. *Mar Policy* 100:90–97
- Sanderson D, Bruce L (eds) (2020) *Urbanisation at risk in the Pacific and Asia: disasters, climate change and resilience in the built environment*. Taylor and Francis Ltd., London, UK
- Scott D, Overmars M, Falkland T, Carpenter C (2003) *Pacific dialogue on water and climate*. SOPAC, Suva, Fiji Islands
- SOPAC and UNDP (2007) *Integrated water resources management in Pacific Island countries: a synopsis*, Fiji
- SOPAC (2004) *Environmental vulnerability index*, South Pacific Applied Geoscience Commission, SOPAC Technical Report 384
- SOPAC (2007a) *National integrated water resource management diagnostic report: Nauru*, SOPAC Milestone Report 640

- SOPAC (2007b) National integrated water resource management diagnostic report: Vanuatu, SOPAC Milestone Report 648
- SOPAC (2007c) National integrated water resource management diagnostic report: Republic of the Marshal Islands, SOPAC Milestone Report 639
- SPREP (2011) Regional wetlands action plan for the Pacific Islands 2011–201, Secretariat of the Pacific Regional Environment Programme (SPREP). Apia, Samoa
- Statista (2021) Share of resident population connected to an urban wastewater collection system in Australia from 2009–2018 <https://www.statista.com/statistics/981766/australia-share-of-population-with-access-to-public-sewerage-system/>
- Talbot-Jones J, Hale S, Greenhalgh S (2020) Review of policy instruments for freshwater management, Motu Working Paper 20–10, Wellington, New Zealand
- TRHDP (2021) The Tina river hydropower development project, Solomon Islands. <https://www.tina-hydro.com>
- Turner A, Sahin O, Giurco D, Stewart R, Porter M (2016) The potential role of desalination in managing flood risks from dam overflows: the case of Sydney, Australia. *J Clean Prod* 135:342–355
- UNDP and SPC (2018) Baseline assessment of development minerals in Fiji, UNDP Pacific Office in Suva, Fiji
- UNDP (2020) Human development report 2020, United Nations Development Programme
- UNCTAD (2005) Statistical profiles of the least developed countries. United Nations Conference on Trade and Development. https://unctad.org/en/Docs/ldcmisc20053_en.pdf
- UNESCO and UN Water (2020) United Nations world water development report 2020: water and climate change, UNESCO, Paris
- UNESCO, UN Habitat and SEAMEO (2021) Guidelines for climate resilient buildings, UNESCO Green Academies, UNESCO, Bangkok Office. [372158eng.pdf \(unhabitat.org\)](https://www.unhabitat.org/372158eng.pdf)
- UNGA (2014) Report of the third international conference on small island developing states, Apia, Samoa, 1–4 Sept 2014, UN General Assembly
- UNICEF (2020) Water, sanitation and hygiene: clean water, basic and good hygiene practices are essential for the survival and development of children and women. UNICEF, Papua New Guinea. <https://www.unicef.org/png/what-we-do/water-sanitation-and-hygiene>. Accessed 17 Dec 2020
- UTS (2011) Vanuatu WASH sector brief. University of Technology Sydney. https://www.google.com/url?sa=t&rct=j&q=&esrc=s&source=web&cd=&ved=2ahUKEwiM2Nq9wq_wAhVPWysKHfYwBYAQFJAegQIBhAD&url=%3A%2F%2Fwww.uts.edu.au%2Fsites%2Fdefault%2Ffiles%2FISF_VanuatuWASH.pdf&usq=AOvVaw2yIneCasvRk8vmu3uZ9sMI
- United Nations (2014) SIDS Accelerated Modalities of Action (SAMOA) Pathway (69/15), Resolution adopted by the General Assembly on 14 November 2014. United Nations
- UN Water (2021) Sustainable Development Goal 6 on water and sanitation SDG 6 Data Portal. <https://www.sdg6data.org/>. Accessed 12 Apr 2021
- White I, Falkland T (2010) Management of freshwater lenses on small Pacific islands. *Hydrogeol J* 18(1):227–246. <https://doi.org/10.1007/s10040-009-0525-0>
- WHO (2016) Sanitation, drinking water and health in Pacific Island Countries: 2015 update and future outlook. World Health Organisation, UN-Habitat, UNICEF, and Pacific Community
- WHO and SOPAC (2008) Sanitation, hygiene and drinking-water in the Pacific Island countries: converting commitment into action, Geneva, Switzerland. <https://rb.gy/8xqbuz>. Accessed 10 Dec 2020
- World Bank (2011) Vulnerability, risk reduction and adaptation to climate change, Papua New Guinea. Climate Risk and Adaptation Country Profile Washington DC, The World Bank Group
- World Bank (2019) Building urban water resilience in Small Island Countries: the case of South Tarawa, Kiribati. World Bank, Washington, DC
- World Bank (2021) World Bank Data Portal. <https://data.worldbank.org/indicator/ER.H2O.FWTL.ZS?view=chart>. Accessed 12 Apr 2021
- World Bank, WSD, UN-Habitat, ADB and PRIF (2015) Unsettled: water and sanitation in urban settlement communities of the Pacific. <http://hdl.handle.net/10986/23336>

The opinions expressed in this chapter are those of the author(s) and do not necessarily reflect the views of the UNESCO: United Nations Educational, Scientific and Cultural Organization, its Board of Directors, or the countries they represent.

Open Access This chapter is licensed under the terms of the Creative Commons Attribution-ShareAlike 3.0 IGO License (<https://creativecommons.org/licenses/by-sa/3.0/igo/>), which permits use, sharing, adaptation, distribution, and reproduction in any medium or format, as long as you give appropriate credit to the UNESCO: United Nations Educational, Scientific and Cultural Organization, provide a link to the Creative Commons licence and indicate if changes were made. If you remix, transform, or build upon this book or a part thereof, you must distribute your contributions under the same licence as the original.

The use of the UNESCO: United Nations Educational, Scientific and Cultural Organization's name, and the use of the UNESCO: United Nations Educational, Scientific and Cultural Organization's logo, shall be subject to a separate written licence agreement between the UNESCO: United Nations Educational, Scientific and Cultural Organization and the user and is not authorized as part of this CC-IGO licence. Note that the link provided above includes additional terms and conditions of the licence.

The images or other third party material in this chapter are included in the chapter's Creative Commons licence, unless indicated otherwise in a credit line to the material. If material is not included in the chapter's Creative Commons licence and your intended use is not permitted by statutory regulation or exceeds the permitted use, you will need to obtain permission directly from the copyright holder.



Chapter 3

Energy Security in the Pacific



Katerina Syngellakis and Peter Johnston

Renewable electricity generation has made progress but dependence on imported petroleum fuels remains significant and climate related risks must also be addressed to strengthen energy security.

Abstract Energy security is a multifaceted concept, depending on whether the perspective is national or household level, urban or rural, higher or lower income, commercial or individual. Energy security in the Pacific Island Countries and Territories (PICTs) has progressed in some areas such as energy access and renewable electricity generation but less in others such as affordability and energy efficiency, while a significant dependence on petroleum imports remains. New aspects of energy security are emerging, notably climate resilience, transport, and gender. Better data can inform evidence-based decision making but the cost and effort against the available capacities for data collection and analysis must be considered. While continued investment is needed for renewables and energy efficiency, a greater shift in climate finance towards adaptation and development of resilient energy systems in the PICTs is vital. Finance must also be found for securing petroleum supplies and their safe use while they are still needed.

Keywords Energy · Renewable · Petroleum · Efficiency · Security · Affordability · Access · Policy · Climate Change · Gender

K. Syngellakis (✉)

Global Green Growth Institute, Level 8, Ro Lalabalavu House, Victoria Parade, Suva, Fiji
e-mail: katerina.syngellakis@gggi.org

P. Johnston

Energy and Environmental Consultants Ltd., Samabula, Box 4206, Suva, Fiji
e-mail: johnston@unwired.com.fj

© UNESCO 2024

A. Dansie et al. (eds.), *The Water, Energy, and Food Security Nexus in Asia and the Pacific*, Water Security in a New World,
https://doi.org/10.1007/978-3-031-25463-5_3

3.1 Introduction

This chapter provides a review of the current status of energy security in the Pacific, with a focus on Pacific Island Countries and Territories (PICTs). First, we examine what energy security means for the Pacific, the data available to assess energy security, and selection of suitable indicators at a regional level. We then present the data available for selected indicators and discuss the implications for different aspects of energy security. The limitations and challenges, and additional indicators that could be used to assess energy security, are then presented. Finally, the chapter touches upon future trends that could affect energy security in both a negative and positive way and makes some recommendations for the way forward.

The concept of ‘Energy Security’ has many aspects and thus has been defined and refined in many ways over the last 20 years (Raghoo et al. 2018). Assessing Pacific energy security should carefully consider the concept from several perspectives (governments, urban dwellers, low-income households, etc.) and both over the short-term and longer term (Johnston 2012). Long-term energy security often focuses on major investments to secure a more reliable supply which aligns with sustainable development and environmental imperatives, while short-term energy security is more about the ability of a given energy system to react promptly to sudden changes in the supply–demand balance (IEA 2021a). The classic International Energy Agency (IEA) formulation focusing on availability, accessibility, affordability, and acceptability does not embed the concepts of risk and resilience or address “security for whom?”, “security for which values?” and “security from what threats?” (Månsson et al. 2014). These are valid questions which are amongst the elements of energy security that this chapter will examine.

All countries are vulnerable to adverse environmental, economic, and financial conditions with low- and middle-income countries particularly vulnerable due to less diversified and robust economies, often geographical remoteness, a higher dependency on development assistance, and constrained human capacity. The Pacific region has a mix of remote high-, middle- and low-income countries with the majority being the Pacific Island Countries and Territories (PICTs).¹ As these 14 countries and eight territories face the greatest challenges in the Pacific in terms of energy security and climate change, this chapter focuses on them.

¹ For the purposes of this paper, the Pacific Islands Countries are defined as the following 14 countries: the Cook Islands, the Federated States of Micronesia (FSM), Fiji, Kiribati, Nauru, Niue, Palau, Papua New Guinea (PNG), the Republic of the Marshall Islands (RMI), Samoa, Solomon Islands, Tonga, Tuvalu, and Vanuatu. For some graphs additional Pacific territories (American Samoa, French Polynesia, Guam, New Caledonia, and others), are included or omitted depending on data availability. This is indicated in the text and/or the graph as appropriate. Australia and New Zealand energy use is much greater than that of the PICTs and is excluded from coverage.

Due to their status as middle-, low-income and Least Developed Countries² and natural geographic characteristics, PICTs are extremely susceptible to natural disasters, climate change, external economic fluctuations, and shocks (ADB 2021b). They are facing the devastating impacts of climate change including increasing droughts and water scarcity, coastal flooding and erosion, changes in rainfall that affect ecosystems, forestry, and food production and have adverse impacts on human health (IPCC 2021).

The Pacific region is also expected to be increasingly impacted by cyclones. The increasing severity, rainfall, and flooding impacts of these is discussed in Chap. 5. As examples of the economic damage from individual storm events, Vanuatu and Fiji lost 64% (ILO 2015) and 33% (Government of Fiji 2016) respectively of their GDP in 2015 and 2016 when they were hit by Cyclones Pam (Vanuatu) and Winston (Fiji). Four PICTs (Papua New Guinea [PNG], Solomon Islands, Tonga, and Vanuatu) rank in the top ten globally for disaster risk, where very strong exposure to natural hazards combined with poor economic and social circumstances, makes them particularly vulnerable (United Nations University 2016). Amongst other aspects, the vulnerability of PICTs is characterized by a high to very high dependence on development assistance and remittances, a narrow export base, low foreign direct investment, and high poverty rates. PICTs populations are also disproportionately at higher risk of adverse consequences of global warming above 1.5 °C. With a very high proportion of PICT populations being coastal and agricultural communities dependent on food production and coastal livelihoods, they are particularly threatened by climate change induced sea-level rise (IPCC 2018). Impacts of the COVID-19 pandemic have exacerbated existing challenges and pose a severe threat to development (ADB 2021b).

This vulnerability is further compounded by very high dependence on imported fuel for commercial energy production (UNDP 2007) and constrained access to reliable, affordable energy. Seven of the ten countries in the Asia and Pacific region most vulnerable to oil price volatility are PICTs (ADB 2009). The PICTs' geographical isolation and small fuel volumes result in high transport costs which, alongside shocks in fuel prices, can decrease both energy and food security. In July 2008, for instance, the Republic of the Marshall Islands government declared a State of Economic Emergency due in part to high fuel and food prices (CFE-DM 2019).

Petroleum consumption in PICTs has increased from 76,000 barrels per day to almost 110,000 in line with population and GDP growth between 2000 to 2017 (Fig. 3.1). The top four consumers for which data was available, Fiji, Guam, PNG, and New Caledonia, account for about 80% of the total.

² Kiribati, Solomon Islands, and Tuvalu are classified as Least Developed Countries by the United Nations Committee on Development Policy, as of February 2021.

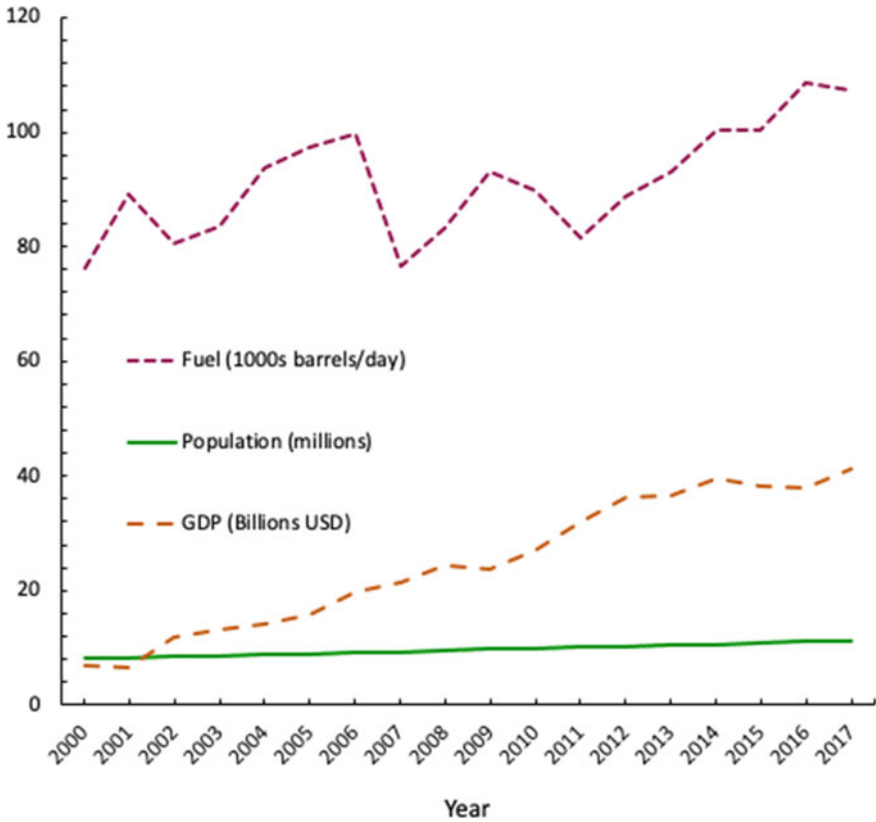

Fig. 3.1 Pacific Islands and Territories³ petroleum fuel consumption (USEIA, n.d.)

Recent accurate data showing energy use by sector is not available for the PICTs. While there is limited up-to-date and consistent data on the use of commercial energy, there is nearly no reliable data on non-commercial energy consumption (e.g., wood for cooking).^{4,5} Commercial energy consumption in PICTs from 2000 to 2017

³ Fuel data was available for American Samoa and other US Pacific Island Territories, Cook Islands, Fiji, French Polynesia, Guam, Kiribati, New Caledonia, PNG, Samoa, Solomon Islands, Tonga, and Vanuatu. Population and GDP data available for American Samoa, Fiji, FSM, Kiribati, RMI, Northern Mariana Islands, Nauru, Palau, PNG, French Polynesia, Samoa, Solomon Islands, Tonga, Tuvalu, and Vanuatu.

⁴ There were a dozen or so household energy surveys carried out in the PICTs during the 1980s which weighed wood and other biomass (converted to dry weight equivalent) used for cooking and some agricultural drying but biomass energy use since then has mostly been estimated, based on rural population changes and households which reportedly (census, household income and expenditure surveys, ADB & UNDP-funded household energy surveys) cook with biomass. There is still considerable biomass cooking in most PICs in both urban and rural communities, but the accuracy of data is questionable.

⁵ There is some data on bagasse (sugar cane fibre) for electricity generation.

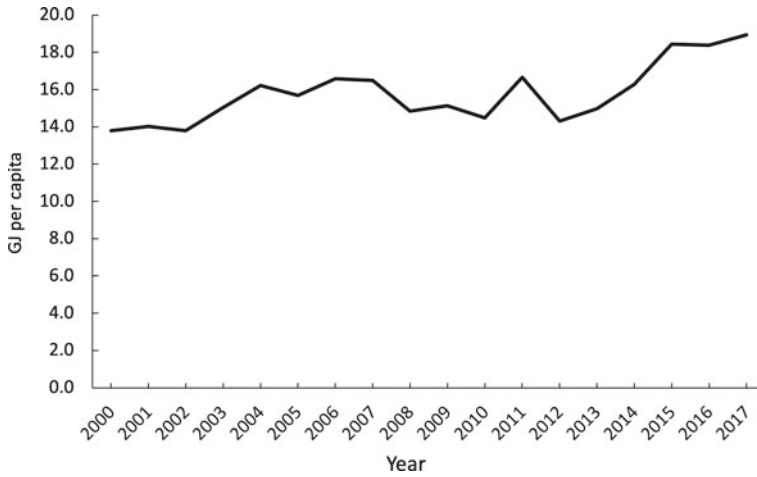
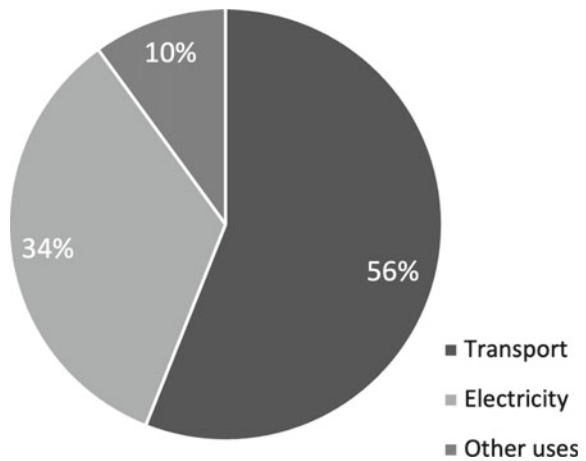

Fig. 3.2 Averaged commercial energy consumption in seven PICs 2000–2017 (USEIA, n.d.)

Fig. 3.3 Breakdowns of commercial (petroleum) energy use in the PICTs in 2017



(Fig. 3.2) shows a modest 2% average annual increase in commercial energy use in representative PICTs.⁶

Final commercial energy consumption by sector was estimated at 38.4% transport, 10.9% residential, 41.4% industry, and 9.3% others in 2008 (APEC, ADB 2013). Based on 2017 data from IRENA and USEIA, and power sector fuel consumption from the Pacific Power Association (PPA), commercial energy use has been approximated at 56% transport, 34% electricity, and 10% other uses (see Fig. 3.3). The lack of sectoral data at the national level and the uncertainty and inconsistency regarding

⁶ Due to data limitations this only covers the following seven countries: Fiji, Kiribati, PNG, Samoa, Solomon Islands, Tonga, and Vanuatu.

final energy consumption by sector demonstrates the need for improved data collection, analysis, and dissemination. The available sectoral breakdowns are qualitative, but access to energy for transport (currently petroleum) is a crucial factor in energy security, although PICT policies and targets have focused primarily on a transition to renewables in the electricity sector as shown in the following sections of this chapter and covered in detail in Chap. 12.

3.2 What Does Energy Security Mean for the Pacific and PICTs in Particular?

The concept of energy security was developed by the IEA in the 1970s and initially concerned adequate supplies of liquid petroleum fuels, gas, and electricity for the wealthier nations. Today it considers the adequacy of responses to energy supply and distribution problems to maintain or improve reliance. It can be ambiguous, can involve different priorities for different people, government, or organizations and has evolved and is still evolving with time. Governments may assume that less reliance on petroleum imports, a higher percentage of energy from local renewable resources, improved efficiency of energy end-use, affordability, and a wider range of sources for petroleum fuels automatically improve energy security (UNESCAP 2012). However, these goals can often compete and there may be different short-term and long-term dimensions (UNESCAP 2012). Regardless of the definition adopted, changes in PIC energy security over time are not easy to definitively quantify due to incomplete data and multiple ways in which energy security could potentially be defined and measured.

The traditional and most broadly accepted definition is that of the IEA (2021a): “the uninterrupted availability of energy sources at an affordable price” with long-term aspects (timely investments to supply energy in line with economic developments and environmental needs) and short-term (the ability of the energy system to react promptly to sudden changes in the supply–demand balance). In the past, the emphasis was on petroleum and other fossil fuels but recently the IEA has included renewables and promoted the need for reducing vulnerability by improving resilience to a wide variety of shocks, including natural disaster and geopolitical conflicts.

Despite evolution in the IEA approach, there is no consensus on a definition of energy security (Ebinger 2011) in part because the concept depends on where in society one sits: governments tend to emphasize measures to mitigate supply disruptions (e.g., through supply diversification or energy stocks), private citizens and small business want reliability and affordability, and urban communities want to avoid power disruptions. For low-income groups and rural communities, a limited basic supply of commercial fuel and electricity can empower women and girls, lead to better education for children, and improve health and healthcare. For the poor, energy security is also often about guaranteed access.

In Australia, the Clean Energy Council defines energy security in relation to the electricity grid or power system and includes “the grid’s capability to react and recover securely to major events such as faults or generation tripping” while the Federal Government takes a broader definition, that energy security consists of “adequate, reliable and competitive supply of energy across the electricity, gas and liquid fuel sectors, where reliability is the provision of energy with minimal disruptions to supply” (Australian Government 2012).

Only in the last decade has there been much discussion of what energy security means for PICTs with the concept becoming associated in part with the transition to renewable energy and linked to climate change mitigation. On the other hand, until recently PICT energy policies, strategies, and plans either did not mention at all or placed little emphasis on adaptation to climate change for energy systems. This is starting to change with the new regional *Framework for Energy Security and Resilience in the Pacific* (FESRIP: 2021–2030),⁷ which was endorsed by the region’s leaders at the 2021 Pacific Island Forum (PIFS 2021).⁸

FESRIP emphasizes energy sector climate robustness and resilience (SPC 2021) and PICT governments are beginning to integrate climate change adaptation into energy plans, for example, the Tonga Energy Road Map Plus Framework (Government of Tonga 2020). However, the identification of increased energy security with increased use of renewable energy and responses to the climate emergency have not been taken up universally across the Pacific region, with the Australian Federal Government’s hesitancy to move away from fossil fuels⁹ at odds with most PICTs and individual Australian states and territories which are setting targets of 100% renewable electricity and making net zero pledges. Additionally, the ban on nuclear power stations in both Australia and New Zealand means that non-fossil fuel transition will necessarily be towards renewables. Therefore, the reality of energy security in the Pacific region and the PICTs remains complex, is evolving and involves several, sometimes competing government and societal aspects, such as reliability, cost, availability, and universality of supply versus affordability and climate action versus national security considerations.

The PICT’s *Framework for Action on Energy Security in the Pacific* (FAESP): 2010–2020 (SPC 2010), stated that, “Energy security depends on the availability, accessibility, affordability, stability, and uses of energy” and “Energy security exists when all people at all times have access to sufficient sustainable sources of clean and affordable energy and services to enhance their social and economic well-being”. This definition is highly ambitious, and not easy to quantify and therefore measure progress over time. The 2020–2030 FESRIP does not provide a definition but specifies that its focus is on “improving energy sector robustness and resilience

⁷ Some information from an early draft FESRIP, for which one of the authors was the lead consultant, has been used in this chapter.

⁸ This ‘virtual’ summit included 9 PICT leaders, 3 PICT ministers or envoys and the Prime Ministers of Australia and New Zealand.

⁹ The Australian Prime Minister has announced a conditional net-zero target by 2050 (BBC 2021) but coal, oil, and gas production will keep growing at least until 2040, reaching levels more than double what is needed to prevent a 2 °C temperature rise (UNEP 2021).

to adverse climate change and natural disasters . . . , universal access to secure, robust, sustainable and affordable electricity, transport fuel and household energy services that are increasingly supplied by renewable resources, with improved energy efficiency, upgraded energy infrastructure and improved technologies”. Those aspects most commonly used to describe energy security or used alongside energy security and other joint objectives in the FESRIP and PICT national energy frameworks, roadmaps, strategies, and policies include:

- Reliability of supply
- Accessibility
- Affordability
- Efficiency of use
- Environmental quality/Renewable energy
- Resilience
- Adequate institutional frameworks and enabling environment
- Sufficient capacity, technical knowledge, and data availability

Achieving energy security is linked to various socio-economic benefits, including energy for the transport and productive sectors, water, and agriculture in particular. Energy security is also strongly linked to an affordable energy supply for key industries such as tourism which drives the economies of several PICTs. For health, energy has always been a key consideration, with an emphasis on electricity as vital for good functioning of health facilities. This has again been evident during the COVID-19 pandemic, for example for vaccine refrigeration. Lastly, achieving energy security links to a wide variety of socio-economic and environmental targets of the Sustainable Development Goals, as discussed in detail in Chap. 16.

3.3 Measuring Energy Security in the PICTs

3.3.1 Energy Security Indicators

A set of 36 quantitative and qualitative indicators was developed in 2011 to provide a means to measure changes or achievements in energy security (SPC 2011a). From these, this paper selects six indicators to discuss the status of energy security in the PICTs. These six indicators have not been chosen to cover all energy security aspects mentioned above but rather are in the opinion of the authors among the more unambiguous indicators and also those for which data are available and reasonably accurate. The six indicators of Table 3.1 are used to exemplify estimates and aspects of energy security in the PICTs.

Table 3.1 Indicators to assess aspects of PICT energy security

Indicator	Aspect of energy security
1. Petroleum fuel imports as a percentage of GDP	Affordability (at the national level)
2. Energy cost as percentage of household expenditure	Affordability (at the household level)
3. Changes in the average electricity tariff	Affordability, reliability of supply
4. Percentage of households electrified	Access
5. Renewable energy as a share of electricity generation	Reliability of supply, environmental quality
6. Number of energy and climate policies that promote renewable energy and energy efficiency	Institutional frameworks and enabling environment

3.3.2 *Status of Energy Security in PICTs*

Has energy security changed over time in PICs and how? Here we examine selected indicators (Table 3.1) and estimate the current state of energy security in the PICTs based on available data.

Indicator 1: Petroleum fuel imports as a percentage of GDP. This indicator assumes that these are retained imports, excluding re-exports.¹⁰ The data show a mixed situation (Fig. 3.4). Despite an overall reduction in fuel imports by value across the region, heavy dependence remains. For some of the smaller countries the value of fuel imports/GDP have changed by 5% or less – essentially unchanged.¹¹ However, for most, imports as a percentage of GDP have fallen over the period. Using the Caribbean as a benchmark where oil imports average 9% of GDP (CCREEE 2018), most PICTs are similar with 2015 fuel imports in seven PICs accounting for 6 to 12% of GDP. The PICTs have done slightly better overall than the Caribbean, with an average of 7.5% in 2018–2019.

Indicator 2: Energy cost as percentage of household expenditure. The value is largely the same for 2009 and 2015 (Fig. 3.5). However, the data collected do not indicate the difference between rural and urban households or between higher and lower-income households. Energy expenditure as a percentage of total household expenditure of low-income households is typically between 2 and 10% in Africa and Asia (Bacon et al. 2010), while low-income households in the United States spend on average between 4 and 14% of their income on energy (USDOE 2018). The share across different income groups in Latin America ranges between 7 and 9% (IADB 2021). PICT data, ranging between 4 and 23% in 2015, is averaged across income

¹⁰ Re-exports are significant for Fiji, Guam, and sometimes other PICTs.

¹¹ For the smaller PICs, with only a few fuel shipments per year, a shipment might arrive either late one year or early the following year, skewing the data for both years. A 5% change in imports year-to-year does not indicate the same percentage change in consumption, as fuel stock levels at year-end will also differ.

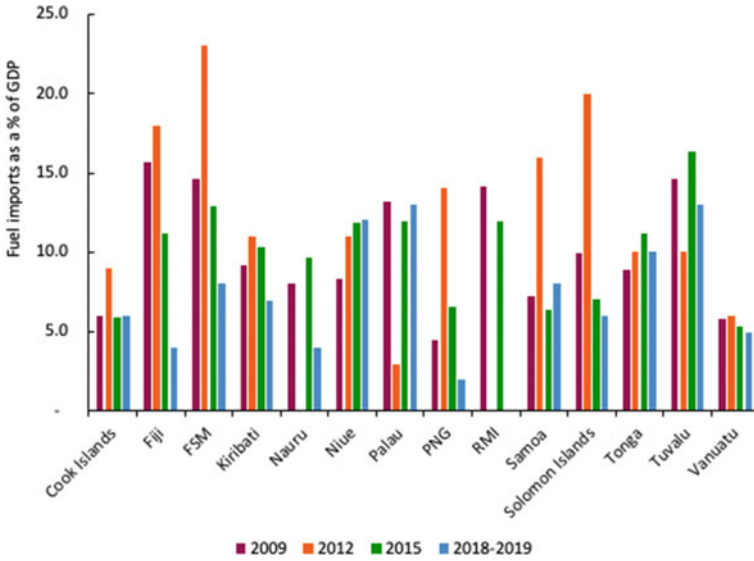

Fig. 3.4 PICT petroleum fuel imports as percentage of GDP (SPC 2017; PRIF 2021a)

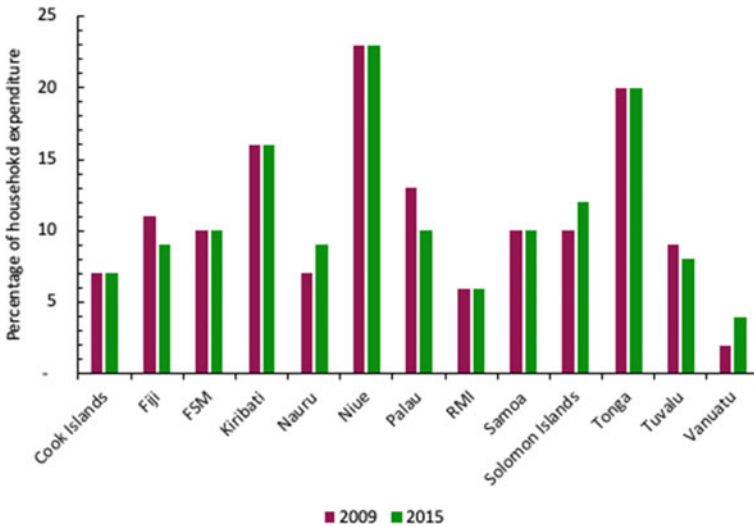

Fig. 3.5 Energy expenditure as percentage of total household expenditure (SPC 2017)

groups and so may indicate that households’ energy expenditure is relatively high in many PICTs. This indicator may also signal vulnerability to future energy price changes, and to increases in food and transport costs which are impacted by energy cost increases.

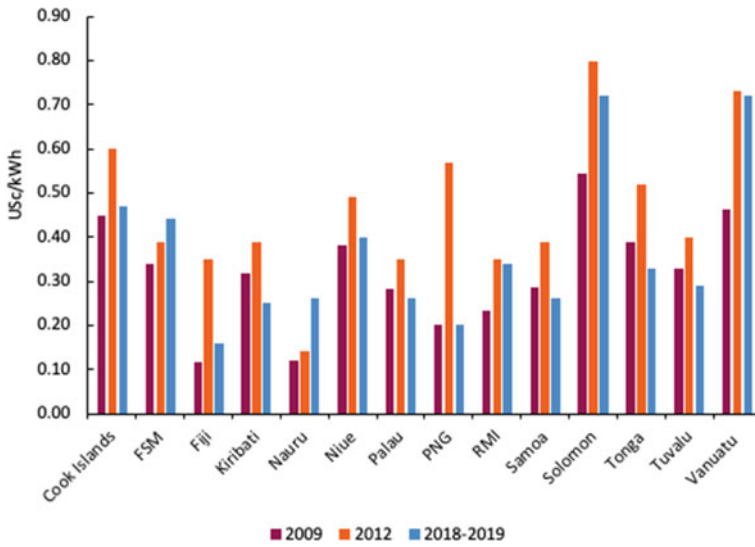

Fig. 3.6 Residential utility (grid-connected) electricity tariffs in PICs (SPC 2019; PRIF 2021a)

Indicator 3: Changes in the average grid-electricity tariff. After a peak in 2012, residential tariffs across the region had dropped by 2018–2019 (Fig. 3.6). This reflects the trend in world oil prices (PRIF 2021a). However, in some PICTs subsidies and below cost tariffs are still being used to keep electricity price at an affordable level. While there is a role for subsidies for low-income households, below cost tariffs applied too broadly could have negative impacts for energy security as governments have to cover the cost of subsidies. Utilities that do not charge or recover the full cost of supply will be less able to provide consistent and reliable operation and maintenance (O&M) and therefore more reliable electricity in the long run.

The mean PICT residential electricity tariff in 2012 was 0.46 USD/kWh, while by 2018–2019, the mean was 0.36 USD/kWh (PRIF 2021a). For commercial users across the PICTs, the mean electricity tariff in 2012 was 0.49 USD/kWh which by 2018–2019 had dropped to 0.41 USD/kWh per kWh (PRIF 2021a). Other categories of users, such as industry and government broadly follow the same pricing trend as commercial users.

The Caribbean, with an average of 34c/kWh (Renewable Energy World 2017) shows that electricity supply in the Pacific for both residential and commercial users is generally more expensive than in a comparable island region which has a far higher per capita GDP. High cost could be a barrier for access to electricity for low-income PICT households, as well as a significant operational cost for businesses.

This indicator is for grid-supplied electricity and does not tell the whole story: in remote communities and smaller islands which are not serviced by a utility grid, the tariff often exceeds USD 1.00/kWh (Mofor et al. 2013). Actual supply cost for both on-grid and off-grid electricity are likely to be higher than the price consumers

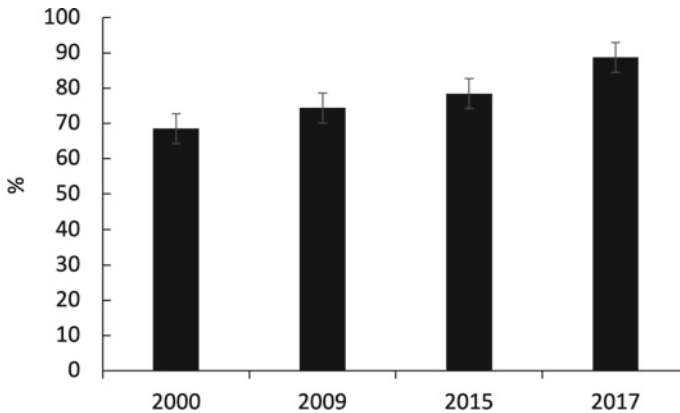

Fig. 3.7 Average percentage of population electrified (*Source* World Bank 2000, 2017; SPC 2012; SPC & PRIF 2019)

are paying as many PICTs provide subsidies (whether explicit or indirect) to protect consumers from the full price of power generation (ADB 2021a).

Indicator 4: Percentage of households electrified. This indicator gives a reasonable measure of access to energy, although for many countries, the quality and availability of electricity supply to households and to men and women is not uniform. Grid-connected households enjoy a higher level of service and availability than those connected through off-grid systems where service is often only 4–6 h of supply per day with more frequent and longer interruptions due to lack of fuel and/or O&M. The average electrification rate across the region increased from under 70% in 2000 to almost 90% in 2017 (Fig. 3.7) with many countries at or almost at 100% (Fig. 3.8).

An appropriate step to refine this indicator would be to consider equity of access between men and women and level of service, including, for example, hours of electricity available per day and number and length of outages. Electrification has brought with it, especially in rural areas, access to technologies to assist with water supply (pumps, reverse osmosis, desalination) for both consumption and productive use in agriculture and tourism and with food storage and processing (freezers, small-scale agro-processing mills) and communication technologies (mobile phone, internet) which have enabled micro and small business development, although these benefits need further research to be quantified.

Indicator 5: Renewable energy as a share of electricity generation. PICTs, and small island developing states (SIDS) in general, are often touted as examples of an ambitious transition towards renewable energy so this is a key indicator to measure that progress. Renewable electricity is also seen as a key pillar of diversification of supply with numerous aims, including reduced dependency on fossil fuels, increased reliability of supply, reduced cost, and mitigating climate change. It is difficult to judge whether the increased use of renewables has met all of these aims.

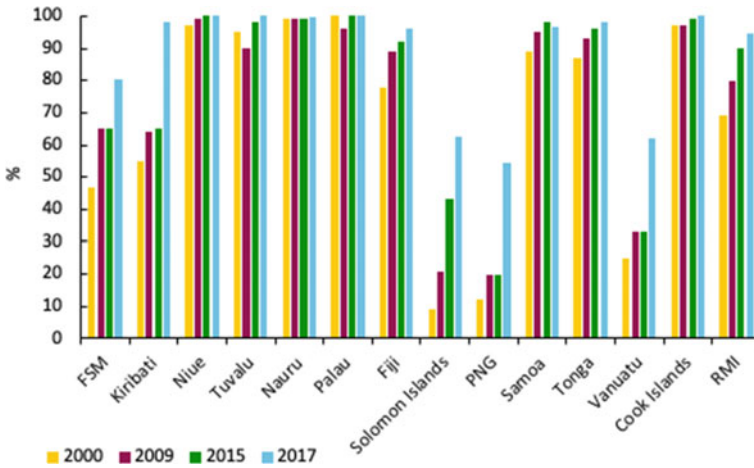

Fig. 3.8 Household Electrification Rates for 14 PICTs 2000–2017 (Source World Bank 2000, 2017; SPC 2012; SPC & PRIF 2019)

An absolute increase over time in renewable power production (GWh) relative to petroleum-based generation does suggest increased energy security.¹² By this measure, renewable energy generation has remained substantively unchanged at 28% of the PICT total (Fig. 3.9) since 2000. This is about the same as renewable energy generation globally, which was 26% in 2018. However, if two of the largest countries of the fourteen (PNG and Fiji) are excluded, renewable energy as a percentage of generation grew from 14% in 2000 to 21% in 2017, a significant diversification of electricity supply contributing to improved electrical energy security for the twelve smaller countries.

Despite substantial investments since 2000, there is still a heavy PICT dependence on fuel imports (Fig. 3.10) in part because Pacific economies continue to evolve with generally increasing trends in power demand. In Fiji for example, there has been an average annual demand increase of over 3% from 2017–2019 (EFL 2020).

The two graphs above do not paint the whole picture regarding development of renewable energy in the Pacific. There has been a significant increase in GWh of renewable generation since 2000, with solar PV generation (Fig. 3.11) growing from less than 0.1% of generation to 7.2%. There have been, and are, also ongoing investments in hydropower in several PICTs, notably the 40 MW Nadarivatu hydro in Fiji, and the rehabilitation of hydro in Samoa, both completed, as well as the 15 MW Tina hydropower plant in the Solomon Islands and the 400 kW Brenwe hydro plant in Vanuatu which are under construction (PCREEE 2020). This chapter does not provide details of specific sustainable energy technologies and future trends in the energy transition for the Pacific as these are covered in Chap. 12.

¹² This would provide more energy if fuel supplies were disrupted compared to a 100% petroleum facility.

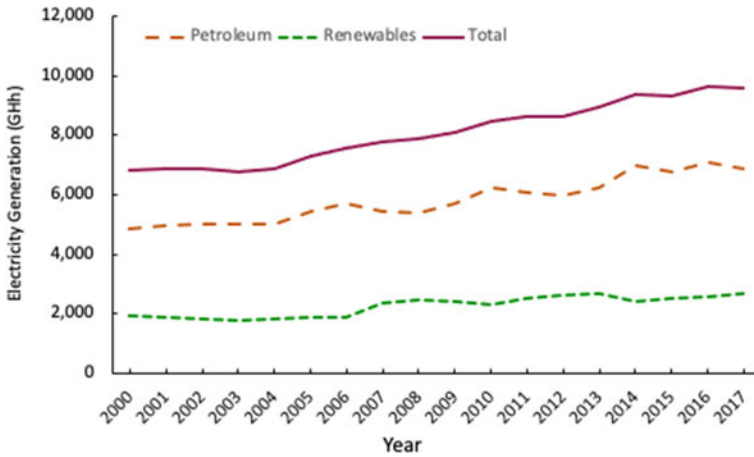

Fig. 3.9 Electricity generation for 19 PICTs from 2000 to 2017 (GWh)¹³ (Source Calculated from data available at https://www.irena.org/IRENADocuments/IRENA_Stats_Tool.xlsb IRENA)

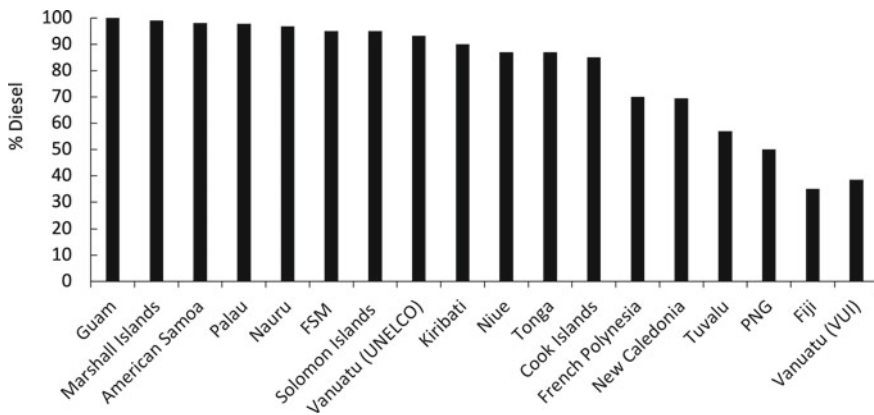

Fig. 3.10 Percentage diesel contribution to PICT electric power, 2016 (URA 2017)¹⁴

If PICTs are divided into the larger Melanesian, small-to-mid-sized Polynesian, and smaller Micronesian categories, renewables as a percentage of main-grid electricity generation differ considerably,¹⁵ as illustrated in Table 3.2, reflecting that for

¹³ This graph includes data from American Samoa, Cook Islands, Fiji, French Polynesia, Guam, Kiribati, RMI, FSM, Nauru, New Caledonia, Niue, Palau, PNG, Samoa, Solomon Islands, Tokelau, Tonga, Tuvalu, and Vanuatu.

¹⁴ Vanuatu has two commercial power utilities, UNELCO and VUI.

¹⁵ Melanesia = Fiji, New Caledonia, PNG, Solomon Islands, and Vanuatu. Polynesia = American Samoa, Cook Islands, French Polynesia, Niue, Samoa, Tokelau, and Tonga. Micronesia = Federated States of Micronesia, Guam, Kiribati, Marshall Islands, Nauru, Palau, and Tuvalu.

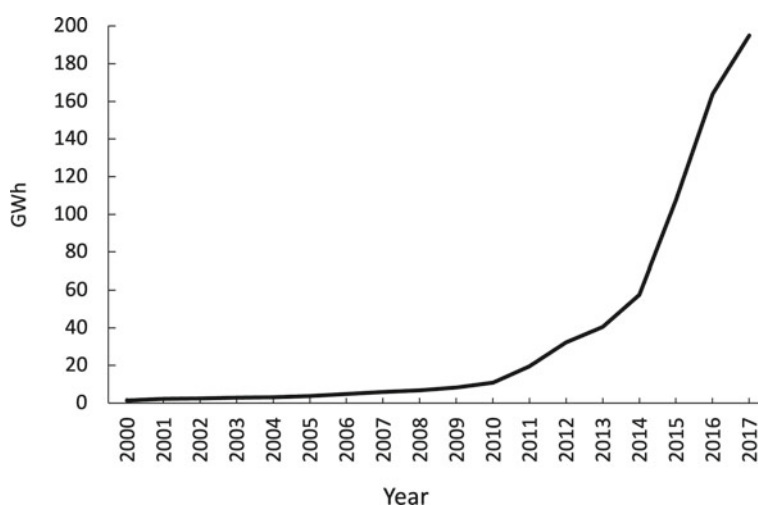

Fig. 3.11 PICT solar PV generation 2000–2017 (GWh) (Source Calculated from data available at https://www.irena.org/IRENADocuments/IRENA_Stats_Tool.xlsb IRENA)

Table 3.2 Renewable electricity in Melanesia, Polynesia, and Micronesia (2017)¹⁶

Category	Melanesia	Polynesia	Micronesia
RE as % of generation	37	25	4
Solar PV as % of RE	2	26	99

Source Calculated from data available at https://www.irena.org/IRENADocuments/IRENA_Stats_Tool.xlsb

the smaller Pacific islands, solar is the main option for renewable energy generation. To reach higher levels of penetration large amounts of energy storage will also need to be installed in the future.

Indicator 6: Number of energy and climate policies that promote renewable energy and energy efficiency. Since 2010 there has been a steadily increasing realization of the urgency of promoting sustainable energy among PICTs in both energy and climate change policies (Fig. 3.12). Among the strategies is a commitment to targets for renewable energy electricity production (Table 3.4) and to a much lesser extent energy efficiency. The development of policies which explicitly promote renewables and energy efficiency strengthens the enabling environment for implementation and is an important step in developing the legislation, regulations, standards, and business models required to meet policy objectives. The PICs have also made commitments to RE and EE through their Nationally Determined Contributions (NDCs) to the Paris Agreement.

¹⁶ Guam accounts for 85% of Micronesian generation but the above percentages do not change appreciably if Guam is excluded.

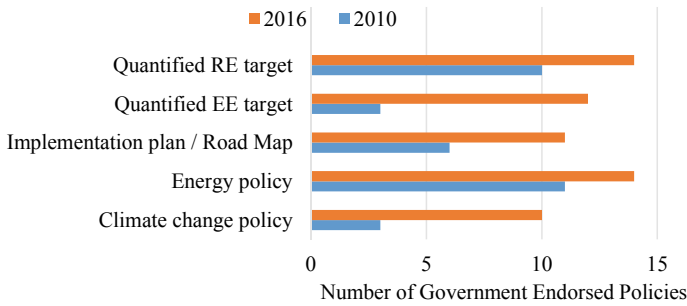

Fig. 3.12 Number of endorsed energy and climate policies promoting renewable energy and energy efficiency

Table 3.3 Feed-in tariffs and net metering in PICs

Country	Feed in tariff	Net metering policy
Cook Islands	Yes	Yes
Fiji	Yes ¹⁸	No
FSM	Yes	No
Kiribati	No	No
Nauru	No	No
Niue	No	No
Palau	Yes	Yes
PNG	Yes	No
RMI	No	No
Samoa	Yes	No
Solomon Islands	Yes	No
Tonga	Yes	Yes
Tuvalu	No	No
Vanuatu	Yes	Yes

Table 3.3 examines the prevalence in PICs of two other key policy measures which have been successful catalysts for supporting growth in renewables in many countries globally, namely net metering and feed-in tariffs (FIT)¹⁷ (Mofor et al. 2013; Shokri and Heo 2012; El-Ashry 2012; IRENA 2019).

¹⁷ Both feed-in tariff (FIT) and net metering are methods the power utility uses to compensate a homeowner or producer for energy fed back into the grid. Net metering requires one meter which runs backwards when the solar panels produce more electricity than the consumer uses. The price the utility pays for power is the same as the selling price. FIT requires two meters, one to measure consumption, the other to measure generation, which allows different pricing for consumption and generation (Applied Materials, Inc. 2009).

¹⁸ There was a regulated FIT up to early 2020 but currently there is no minimum FIT applied.

Table 3.4 Renewable electricity targets and renewable energy generation for selected PICTs in 2000 and 2017

Country	Renewable energy target ^a (%)	By [year]	Actual 2000	Actual 2017 (%)
Cook Islands	100	2020	0.0%	15.1
Fiji	100	2030	82.4%	53.5
FSM	30	2020	0.0%	2.7
Kiribati	23 (South Tarawa)	2025	0.0%	17
Nauru	50	2020	0.0	2.5
Niue	80	2020	0.0%	0.0
Palau	45	2025	0.0	2.1
PNG	100	2030	57.1%	69.2
RMI	100	2050	4.2%	2.8
Samoa	100	2025	54.0%	60.4
Solomon Islands	79	2030	1.4%	7.8
Tokelau	100	Long-term	0.0%	98
Tonga	50	2020	0.2%	9.3
Tuvalu	100	2020	0.2%	23.3
Vanuatu	100	2030	1.8%	20.7

^aRE targets are from Renewable Energy Costs in the Pacific (PRIF 2019), except for RMI which is from the RMI Renewable Electricity Roadmap (Government of the Republic of the Marshall Islands 2018); Source for 2000 and 2017 data is: calculated from data available at https://www.irena.org/IRENADocuments/IRENA_Stats_Tool.xlsb

Arguably the policies which have been developed over the last decade have catalyzed development of RE in the power sector (as discussed above). However, there is a significant gap between the targets set and their achievement. This is most easily quantifiable by the most common target set across PICTs which is for electricity generation from renewables. As shown in Table 3.4, although most countries have made progress, the ambitious policy (and NDC) targets are not being achieved (Michalena et al. 2018). Much electricity sector legislation and regulations are outdated and do not reflect recent technological developments, including renewables. Feed-in tariffs are still unclear and usually technology neutral.

When renewable energy and energy efficiency (EE) are pursued together, they result in higher shares of renewable energy, a faster reduction in energy intensity, and a lower cost for the energy system (IRENA 2017). Table 3.5 summarizes some measures put in place by PICTs and indicates that fiscal and regulatory incentives are lacking for energy efficiency, particularly in the buildings sector. Samoa incorporated minimum energy performance standards in its 2017 national building code (SEI-API 2019) and EE standards have recently been proposed for revised building codes in the Solomon Islands and Vanuatu (PRIF 2021b, c) while Fiji is in the process of developing guidance for energy efficiency in buildings to be integrated into the

Table 3.5 Energy efficiency fiscal and regulatory incentives in PICTs

Fiscal or regulatory incentives for improved energy efficiency ¹⁹			
Country	Appliances	Vehicles	Buildings
Cook Islands	No	Yes	No
Fiji	Yes	Yes	Proposed, 2021
FSM	No	No	No
Kiribati	No	No	No
Nauru	No	No	No
Niue	No	No	No
Palau	No	No	No
PNG	No	Yes	No
RMI	Yes	No	No
Samoa	No	Yes	Yes, 2017
Solomon Islands	No	No	Proposed, 2021
Tonga	No	Yes	No
Tuvalu	No	No	No
Vanuatu	No	No	Proposed, 2021

Sources SPC (2016), SEIAPI (2019), PRIF (2021b, c)

Fiji building code (GGGI 2022). Renewable energy and energy efficiency should be included in the development or review of building codes across all PICTs (PRIF 2021d).

Despite gaps in policy and regulatory measures, EE remains a significant untapped opportunity for a cost-effective increase in energy security in PICTs (Johnston 2012; SPC 2021). Only two major EE regional initiatives have been undertaken over the last decade (ADB 2012; SPC 2011b). Although EE is mentioned in numerous PICT energy policies, there has been a shortage of funding and concrete actions. The slow implementation of EE is incongruous with its potential significant benefits for the PICTs and therefore could be a low hanging opportunity for improvements in the near future. To reach the IEA's Sustainable Development Scenario by 2040, and a maximum global temperature increase of 1.5–2.0 °C by 2050, improved EE globally must deliver over 40% of the reduction in energy-related greenhouse gas emissions (IEA 2020, 2021b). There have been no assessments of the percentage of PICT energy sector investments which should be dedicated to cost-effective EE to meet PICT mitigation targets and improve energy security, but it is undoubtedly significant.

¹⁹ Including lower import duties and taxes and standards and energy efficiency regulations for appliance and vehicle imports.

3.3.3 Limitations of Current Measurement of Energy Security in PICTs

The energy security indicators above have their limitations. For example, electrification may not be sustained if a grid is highly susceptible to flooding in low-lying areas or to cyclone winds. Off-grid systems may be inoperable for long periods waiting for repairs. Changes in the electricity tariff might not be a true indication of affordability if the consumer price is less than the cost of supply, which in itself creates financial insecurity for the supplier and may make the supply unsustainable in terms of fuel purchase or effective O&M, leading to brown outs or black-outs and even termination of service. The vast majority of the policy objectives and targets developed refer only to the power sector, excluding any commitments for the transport sector (land, maritime, and aviation) which is still 100% dependent on petroleum fuels. Diversification of fuel supply, for both electricity and transport, also needs to be addressed within policies and plans to strengthen energy security and this also needs to be reflected in appropriate indicators.

Some discussion of quantifying other aspects of energy security, such as reliability of supply and efficiency of use and areas for improvement of indicators to measure energy security in PICTs, is provided in Sect. 3.5. The indicators above do not paint a clear picture of PICT energy security trends as there is reasonably consistent data across the fourteen countries for only between two and four years for most indicators. Data from SPC's Pacific Regional Data Repository (PRDR—<https://prdrse4all.spc.int/>) has been supplemented from various sources but significant gaps remain. For the Pacific territories, information is even more scattered. An ongoing systematic collection of additional data for recent years would improve the ability to analyze trends alongside strengthening capacities and technical expertise in PICTs institutions including collection, management, distribution, and analysis (SPC 2019; ADB 2021b). To plan and act effectively for a more energy secure future, good data are vital.

3.4 Climate Change and Energy Security

Accounting for, and adapting to, the impact of climate change is essential for the future energy security of PICTs for supply and demand for RE but also for fossil fuels. Bulk fuel storage capacity is a good short- to medium-term security indicator but only if installations account for and mitigate the risks of flooding, sea level rise, and increased intensity of cyclones due to climate change. Energy secure facilities need to be well-maintained and located in areas unlikely to flood,²⁰ with independent certification indicating high resistance to floods and cyclone damage, as it is for renewable installations. In Fig. 3.13 (Climate Central Inc. 2021) for Tonga's main

²⁰ There is considerable anecdotal evidence but few, if any, recent independent assessments on the safety of bulk storage in the Pacific, required for meaningful indicators.

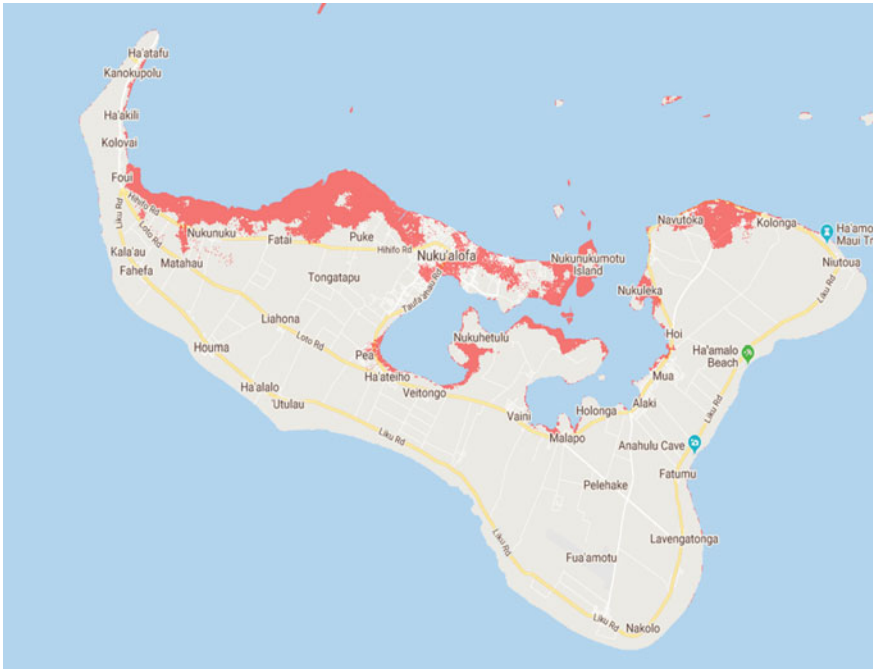

Fig. 3.13 Tongatapu, Kingdom of Tonga land at risk of flooding by 2050 (Climate Central Inc. 2021)

island of Tongatapu, land shown in red is highly vulnerable to future flooding during the lifetime of new facilities constructed now; any energy facilities located there only provide long-term security if specifically designed for flood conditions, if at all (SPC 2021).

Some types of energy generation may be more vulnerable to adverse climate change than others, as illustrated in Table 3.6. The interface of water resources (Chap. 2) on energy generation and security is also shown to impact oil storage, natural gas, hydropower, and biomass technologies.

Short-term vulnerability to climate change, and thus reduced energy security, is exacerbated by Pacific specific practices and environmental conditions. These are (SPC 2021):

- Most electric power lines are overhead and often close to trees, susceptible to high winds and storms.
- Power generation is usually located in low-lying areas and subject to flooding or sea level rise damage.
- Fuel pipes and tanks are often only several meters from the sea, and subject to damage or destruction from storms, and in the longer-term sea-level rise.

Table 3.6 Indicative short-term impacts of climate change on power generation, transmission, and end use in PICs

Technology	Δ Air temp	Δ Water temp	Δ Water availability	Δ Wind speed	Δ Sea level	Floods	Heat waves	Storms
Oil storage	1	2	1-3	-	1-3*	3	1	2-3
Natural gas	1	2	1-3	-	-	3	1	-
Hydropower	-	-	1-3	-	-	3	-	1
Wind	-	-	-	1-3	3*	-	-	1
Photovoltaic (PV)	-	-	-	-	-	-	1	1
CSP/Solar tracking	-	-	-	2	-	1	1	2
Biomass/Biofuel	1	2	1-2	1-3*	3*	3	1	-
Geothermal	-	-	-	-	-	1	-	-
Ocean	-	1	-	-	1	N/A	-	3
T&D grids	3	-	-	1	3*	1-2	1	2-3
End use	2	-	-	-	-	-	3	-

Notes 3=Severe Impact; 2=Medium Impact; 1=Limited Impact; - = No Significant Impact; N/A = Not Applicable
CSP = Concentrating Solar Power; Δ = 'change in'; *=coastal or low-lying areas; T&D = transmission & distribution

(Source SPC 2021)

- Biomass production for power generation or biofuel conversion is subject to the full range of vulnerabilities of agricultural systems in general, including effects of changing rainfall patterns, temperature changes, and winds.
- Where climate change increases cloud cover or even the speed of cloud movement, PV output can suffer significantly, especially if a single inverter services the entire PV array.
- There is a lack of climate modelling for hydropower generation, where rainfall patterns are changing in catchment areas.

Finally, although the impact of climate change on energy demand is uncertain, there is some evidence that an increase in demand from increased use of air conditioning may arise.

Uncertainty remains around the exact impacts of climate change on energy supply, distribution, storage and generation across fossil fuels, traditional biomass and renewable energy, as well as its influence on demand as there is limited data to assess the above dimensions and technologies. Given the vulnerable status of energy security and the need to plan ahead²¹ to improve resilience and energy security, further investigation into supply-side and demand-side impacts of climate change should be undertaken with urgency and integrated into the appropriate regulations and policies, insurance and financing and risk modelling.

²¹ Energy generation systems typically operate for 30 years or more if reasonably well-maintained. Systems built today should be designed for conditions expected or anticipated by 2050.

3.5 Monitoring Progress—Future Challenges and Indicators for Energy Security

This chapter cannot capture all the aspects of energy security in the Pacific. Important aspects not discussed but included in SPC's energy security indicators, provide opportunities for further assessment of progress including energy intensity (MJ/US\$ of GDP), carbon footprint (tonnes of CO₂ emissions/GDP or per capita), and fuel supply security (days of storage). As the PICTs transition to renewables (Republic of the Marshall Islands 2018; Government of Fiji 2018; Government of Tonga 2020; SPC 2021; ADB 2021b), the supply, storage, and distribution of fossil fuels in the interim needs to be secure. For regional security the main fuel re-exporting PICTs should agree to share with the other PICTs in times of supply crisis if tankers are available. The capacity of bulk fuel storage in days or months of consumption is an appropriate indicator of short- to medium-term national energy security if the storage facilities are well-maintained and not in danger of failure in the short-term or to severe threats of climate-induced disruption in the medium- to long-term. An improved measure of fuel security might be storage capacity restricted to those facilities that meet international safety standards, are well maintained, and are resistant to floods and climate change (SPC 2021).

Considering the emergence of resilience to climate change and the transport sector as crucial dimensions of energy security, the indicators used to measure security should be re-assessed at the regional and national level. Indicators examined in this chapter show the limitations of a focus on electricity but also the difficulty in selecting measurable, fair, transparent, and equitable indicators and timely data acquisition. It is further recommended that additional indicators be considered. The following dimensions would enrich the conversation around energy security in the Pacific:

- improved resilience/responsiveness of energy infrastructure to adverse climate change and natural disasters;
- development of energy policies and plans that demonstrate robustness to known and likely risks of future events, not static plans for a fixed objective;
- consideration of both the short to medium-term reality of continued dependence on petroleum fuel as well as the long-term perspective of the shift to 100% renewable electricity (Table 3.4) and net-zero emissions by 2050 (Government of Fiji 2018; Republic of Marshall the Islands 2018);
- more emphasis on how different sectors and demographics of society are affected by energy insecurity (government, business, electricity consumers, the poor, women, etc.);
- attention not only to electricity services but also to the land, maritime, and air transport sectors;

- attention to various risks affecting the energy sector that the region may face in the next 30 years or more (pandemics, tourism²² trends for tourism-dependent PICs), prioritizing those which are considered most likely and with major impacts; and
- improved site environmental management (for coastal and other areas sensitive to climate change, flooding, etc.).

Indicators for these would vary for Government, the commercial sector, urban dwellers, rural people, and rural economic activities. A non-exhaustive list of possible indicators for the different energy security dimensions above are presented in Table 3.7 which could assist to strengthen monitoring of progress towards sustainable energy security.

This is an extensive list yet is far from complete and omits some key areas such as rural non-commercial energy use. Measuring rural biomass use for cooking and agricultural processing, for example, would require surveys (physical measurements) of the quantities used, which are expensive and difficult to carry out across all the PICTs.

Existing indicators (Sect. 3.3) and others developed by SPC (2011a) can also be used alongside the proposed indicators (Table 3.7) to give a fuller picture of energy security in the Pacific in the future. Apart from using a wider selection of indicators, access to accurate, consistent and up-to-date national energy data to measure progress is essential and remains an issue. The need for improved data has been highlighted at numerous meetings of the region's energy ministers in the past decade, most recently in September 2019 at the Pacific Energy Ministers' meeting (SPC 2019).²³ Having advocated for more indicators it is also important to bear in mind the capacity for data collection and analysis. National staff (including national statistics offices, departments of energy and transport, power utilities, etc.) are already hard-pressed to gather and analyze data in many areas. Therefore, to strike a balance, it may be useful to agree on a minimum set of indicators for which data can be reliably and regularly collected at reasonable cost, and which enable a satisfactory monitoring of progress of energy security.

3.6 Conclusion and Recommendations

Energy security in the PICTs has progressed in some areas (energy access, renewable power generation, reduction in petroleum imports as a percentage of GDP), and enabling environment (more so for RE than for EE) but arguably not in others such as energy cost and affordability, while other aspects are difficult to assess at this time. It is also clear that there are many different aspects of energy security, and each can

²² In the Caribbean, air-conditioning accounts for nearly 50% of electricity use in the tourism sector; for PICs the percentage is lower but unknown.

²³ In a 2019 resolution, Pacific energy ministers "noted the data management challenges of the Pacific Islands and call on the World Bank to urgently appraise and treat the SPC data funding proposal as a matter of priority."

Table 3.7 Possible future indicators and means of measurement

Thematic area	Possible indicator(s)	Aspect of energy security (SPC 2010, 2021)	Possible means of measurement
Data	Inclusion of relevant energy and transport related questions in censuses, Household Income and Expenditure Surveys (HIES) and other collaborative work with regional and national statistics offices	Sufficient capacity, technical knowledge and data availability for analyses	Number of energy security indicators drawing data directly from censuses and HIES reports; Number of new additions into the Pacific Regional Data Repository/year
Electricity	Greater diversity of supply for on-grid-electricity	Resilience	GWh or percentage generated from different energy sources
Electricity	Improved protection of grids from extreme weather (grid hardening)	Resilience/robustness; Reliability of supply	USD invested per year in protection measures
Electricity	Decentralized generation combined with local battery storage and microgrids which can be disconnected from the main grid during floods or cyclones	Resilience/robustness; Reliability of supply	Number of decentralized facilities on main island with battery and capable of running off-grid; Number of days of autonomy of those micro-grids
Electricity	Energy system designs that explicitly require robustness and resilience to anticipated climate change	Resilience; Adequate institutional frameworks and enabling environment	Number of legislations, standards, and regulations requiring energy system design to be robust and climate resilient
Electricity	Utility demand forecasts, and corresponding investment needs, based on least-cost supply (including investments in energy savings)	Sufficient capacity, technical knowledge, and data availability	Number and frequency of utility plans incorporating least-cost supply
Electricity	For grid-electrification, investment policies and plans that explicitly require a higher investment in renewable energy (in terms of MW or GWh) in each five-year period than in petroleum-based supply	Adequate institutional frameworks and enabling environment	Number of policies and frequency of updates; Investment in million USD mobilized per year

(continued)

Table 3.7 (continued)

Thematic area	Possible indicator(s)	Aspect of energy security (SPC 2010, 2021)	Possible means of measurement
Energy efficiency	Reducing fuel imports for electricity and transport, through improved efficiency of energy end-use	Efficiency of energy use	Petroleum fuel use/year/sector; Electricity consumption/capita; Vehicle fleet fuel efficiency km/L % of hybrid vehicles and EVs registered
Energy efficiency	Appliance electricity consumption	Efficiency of energy use	% of imported appliances with three-star or higher rating/year for refrigerators, freezers, and other appliances
Energy efficiency	Building energy consumption	Efficiency of energy use	Adopted building codes with minimum energy use standards (y/n) and penalties and enforcement (y/n)
Equity	For energy consumers, the costs of an adequate energy supply as a percentage of income for all income quintiles	Affordability	Measure of all energy usage by quintile in HIES and census reporting
Equity	Gender equity in the energy sector ²⁴	Sufficient capacity, technical knowledge, and data availability; Accessibility; Affordability	Percentage of women working in the energy sector and percentage of women in senior and management positions both split by public and private sector

(continued)

²⁴ For most PICTs, there is a lack of sex-disaggregated data on gender and energy and therefore it is difficult to assess gender considerations of various energy security aspects such as access and affordability. A gender-based assessment covering Samoa, Tuvalu, Solomon Islands, Fiji, Kiribati, and RMI was carried out in 2020 (Ecoloner 2020). This identifies further dimensions of gender equity in the energy sector which could also be considered. Further national gender-based assessments of the energy sector are needed to establish a baseline for all PICTs. This analysis could, amongst others, identify the challenges related to women's inclusion in the clean energy value chain and outline recommendations on priority actions and main entry points.

Table 3.7 (continued)

Thematic area	Possible indicator(s)	Aspect of energy security (SPC 2010, 2021)	Possible means of measurement
Human resources	Human resource capacity in energy sector (government; majority state owned enterprises)	Sufficient capacity, technical knowledge, and data availability	Number of staff in energy department/transport dept/state-owned utility per capita; Number of staff with Technical and Vocational Education and Training (TVET), Bachelors and post-graduate qualifications (where possible compared to requirements of job descriptions); As above for private sector and civil society
Human resources	Human resource capacity in the energy sector (private, civil society)	As above	
National Development	The extent to which energy sector plans and policies are aligned with climate change policies and NDC goals and national development plans	Adequate institutional frameworks and enabling environment	Number of energy and transport sector plans aligned with each other and with climate change policies, NDC goals, and national development plans
Petroleum	Arrangements for securing continuity of petroleum fuel imports during times of crisis	Reliability of supply	Status of arrangement; assessment of arrangement
Petroleum	For bulk petroleum storage, particularly coastal populated areas, regular assessments of resilience and robustness to cyclones, flooding, and other likely threats	Adequate institutional frameworks and enabling environment	Distance of bulk fuel storage facilities from flood prone zones; independent safety inspections with certification of safety at least five-yearly
Transport	Existence and cost of public transport and coverage within a country	Efficiency of energy use; provision of public transport	Number of small (mini-bus) and large (bus) public transport vehicles per capita; Cost of public transport USD/km travelled

(continued)

Table 3.7 (continued)

Thematic area	Possible indicator(s)	Aspect of energy security (SPC 2010, 2021)	Possible means of measurement
Transport	Use of non-motorized transport	Efficiency of use; Environmental quality	Number of bicycles/capita/year imported; kms/capita of bicycle paths
Transport	Types and efficiency of conventional (internal combustion engine) vehicles and vessels	Efficiency of use; Environmental quality	Percentage of vehicles/vessels using different fuel types by sub-sector litres/km
Transport	Transition to electric land and maritime transport	Efficiency of use; Environmental quality	Number of hybrid and/or electric vehicles/capita; Number of electric small vessels/capita

take on a different meaning depending on whether the perspective is from the national or household level, urban or rural, higher or lower income, businesses or individuals. The analysis undertaken in this chapter, which aggregated the PICTs, would likely look somewhat different in many respects if the larger countries (PNG, Fiji) are excluded. Therefore, energy security for the PICTs is best assessed and reported on a country-by-country basis and including additional indicators to integrate new aspects of energy security, notably climate resilience, transport, and gender.

Not all of these aspects can necessarily be quantified and measured easily. There needs to be a considered approach to balance the cost and effort against the available capacities and the benefit of the data collected, to optimize the type, quantity, and frequency of data collection against that needed for good, evidence-based decision making. One recommendation on data is to increase support for existing data collection efforts at both national (census, HIES, national energy databases) and regional (PRDR, Pacific Power Association utility benchmarking reports) rather than setting up new initiatives.

To improve energy security, financing and investment is a very important element. Climate finance has become a key part of the investment landscape in RE for electricity in the PICTs. The 2009 commitment by developed countries²⁵ to provide USD 100 bn per year by 2020 to assist developing countries implement adaptation and mitigation actions can contribute to improving energy security development in the PICTs, especially if directed towards both RE and EE plus transport and gender.²⁶ Also important is a shift in climate finance for PICTs from mitigation to adaptation and development of resilient energy systems.²⁷ However, finance must also be found for securing petroleum supplies while they are still needed.

Funding of PICT energy projects has largely been from the public sector and overseas development aid. PICTs have indicatively mobilized over USD 2.2 billion in climate finance in the past 10 years across all sectors (UNDP 2021). The amount of climate finance being accessed by PICTs is increasing but is still well short of the estimated investment needs required to meet NDC targets including in the energy sector, estimated at over USD 3 bn over 10 years (UNDP 2021), while aid dependence arguably reduces energy security, as anticipated future levels and sources of aid flows are not guaranteed.

It is also recognized that public finance alone, whether domestic or international, stands no chance of meeting climate mitigation and adaptation needs, but although

²⁵ The commitment was made at COP 15 in Copenhagen, in decision 2/CP.15.

²⁶ This commitment is yet to be met with an estimated USD 78bn provided in 2018 and \$80bn provided in 2019 according to OECD figures (OECD 2021a). The USD 100bn target is projected to be met in 2023 (OECD 2021b). However, Oxfam has estimated public climate financing at only \$19 billion–\$22.5 billion in 2017–2018, around one-third of the OECD's estimate, arguing that, besides grants, only the benefit accrued from lending at below-market rates should be counted, not the full value of loans as well as other points of difference with OECD figures (Carty et al. 2020).

²⁷ Adaptation actions across all sectors in PICTs are increasingly important as there are strong indications that Paris Agreement goals (1.5–2.0 °C maximum heating) may be increasingly difficult to achieve. Climate change is discussed in detail in Chap. 5.

globally the private sector has provided the bulk of investment for the energy transition (OECD 2020), in the PICTs, private investment has been slower to mobilize. The continued reliance on donor finance to fund large scale renewable energy projects contributes to the disincentivization of the domestic private sector from investing in renewable energy (UNDP 2021). Strengthening the investment environment such as RE feed-in tariffs and EE fiscal regulatory measures examined earlier in this chapter and introducing measures to also promote investment into resilience and adaptation would support greater private sector participation.

PICTs face difficulties meeting their infrastructure needs (construction and O&M) in general, not just in the energy sector. Investment requirements are high and expected to increase further in the years ahead. Taking Fiji as an example, its climate vulnerability assessment emphasized the need for future infrastructure investment to ensure resilience to climate change and natural hazards and indicated that almost FJD 9 billion will be needed to climate-proof infrastructure, including energy, transport, water, and sanitation over the next ten years. Climate-ready energy infrastructure typically adds 3% to upfront costs globally but typically saves \$4 overall for every dollar spent (Global Commission on Adaptation and World Resources Institute 2019). Therefore, to strengthen energy security cost-effectively, every energy infrastructure project going forward needs to find the finance to cover this upfront adaptation cost to lower the long-term adaptation cost to the PICTs. A regional approach and cooperation on best practices, standards, and other areas, could assist in aggregation of projects, increase effectiveness and efficiency, and incentivize private sector investment, particularly for energy in tourism, maritime and land transport, and energy efficiency.

References

- ADB (2009) Taking control of oil: managing dependence on petroleum fuels in the Pacific. Asian Development Bank. <https://www.adb.org/publications/taking-control-oil-managing-dependence-petroleum-fuels-pacific>
- ADB (2012) Climate risk and adaptation in the electric power sector Asian Development Bank <https://www.adb.org/publications/climate-risk-and-adaptation-electric-power-sector>
- ADB (2013) Energy statistics in Asia and the Pacific (1990–2009). Asia-Pacific Economic Cooperation (APEC) and ADB. October 2013. <https://www.adb.org/sites/default/files/publication/30286/energy-statistics-1990-2009.pdf>
- ADB (2021a) Pacific energy update 2020. Asian Development Bank
- ADB (2021b) Pacific approach 2021–2025. Asian Development Bank
- Applied Materials, Inc. (2009) Feed-in tariffs or net metering? What's the difference? Applied Materials, Inc. 2009. <https://blog.appliedmaterials.com/feed-tariffs-or-net-metering-what-s-difference>. Accessed 5 Oct 2021
- Australian Government (2012) Energy white paper, Department of Resources, Energy and Tourism
- Bacon R, Bhattacharya S, Masami K (2010) Expenditure of low-income households on energy: evidence from Africa and Asia. Extractive industries and development series; No. 16. World Bank, Washington, DC. <https://openknowledge.worldbank.org/handle/10986/18284>
- BBC (2021) Climate change: Australia pledges net zero emissions by 2050. <https://www.bbc.com/news/world-australia-59046032>. Accessed 5 Nov 2021

- Carty T, Kowalzig J, Zagma B (2020) Climate finance shadow report 2020. Oxfam
- CCREE (2018) 2018 Energy report card: Caricom. Caribbean Centre for Renewable Energy and Energy Efficiency. www.ccreee.org
- CFE-DM (2019) Republic of the Marshall Islands disaster management reference handbook. Centre for Excellence in Disaster Management & Humanitarian Assistance. December 2019
- Climate Central Inc. (2021) Land projected to be below annual. Coastal Climate Central. <https://www.climatecentral.org>. Accessed Sept 2021
- Ebinger (2011) The meaning of energy security depends on who you are. Brookings Institute <http://www.brookings.edu/research/opinions/2011/10/10-energy-security-ebinger>
- Ecoloner (2020) Pacific energy and gender network, gender-based assessment, part 1: clean energy sector analysis, draft version—June 2020, Ecoloner with IUCN, Canadian Trade and Investment Facility for Development and Pacific Community
- EFL (2020) Sector overview: renewable energy and grid power supply, Holiday Inn, Suva, Fiji, Wednesday 22 July 2020. Anand Nanjangud, General Manager Special Projects, Energy Fiji Limited
- El-Ashry MT (2012) National policies to promote renewable energy. *Daedalus* 141(2):105–110
- GGGI (2022) Fiji-GGGI low emissions climate resilient development programme. Internal communication to the Fiji Ministry of Infrastructure, 2021
- Global Commission on Adaptation (2019) Adapt now: a global call for leadership on climate change resilience. Global Commission on Adaptation and World Resources Institute, 2019. https://reliefweb.int/sites/reliefweb.int/files/resources/GlobalCommission_Report_FINAL.pdf
- Government of Fiji (2016) Fiji post-disaster needs assessment. Tropical Cyclone Winston, Suva, Fiji, February 20, 2016
- Government of Fiji (2018) Fiji low emissions development strategy. Ministry of Economy.
- Government of the Republic of the Marshall Islands (2018) Navigating our energy future: Marshall Islands Electricity Roadmap
- Government of Tonga (2020) Tonga energy road map plus framework 2021–2035. Department of Energy, MEIDECC
- IADB (2021) How do households consume energy in Latin America and the Caribbean? <https://blogs.iadb.org/energia/en/how-do-households-consume-energy-in-latin-america-and-the-caribbean/>
- IEA (2020) Energy efficiency 2020. IEA. https://iea.blob.core.windows.net/assets/59268647-0b70-4e7b-9f78-269e5ee93f26/Energy_Efficiency_2020.pdf
- IEA (2021a) IEA energy security topics and Energy security areas of work. <https://www.iea.org/topics/energy-security> and <https://www.iea.org/areas-of-work/ensuring-energy-security>. Accessed 2 June 2020
- IEA (2021b) Energy efficiency, the first fuel of a sustainable global energy system. IEA. <https://www.iea.org/topics/energy-efficiency>. Accessed 5 Oct 2021
- ILO (2015) Cyclone PAM causes devastating impact on employment and livelihoods. International Labour Organization Accessed 13 June 2020 from https://www.ilo.org/suva/public-information/WCMS_368560/lang-en/index.htm
- IPCC (2018) Summary for policymakers. In: Masson-Delmotte V, Zhai P, Pörtner H-O, Roberts D, Skea J, Shukla PR, et al. (eds) Global warming of 1.5 °C. An IPCC special report on the impacts of global warming of 1.5°C above pre-industrial levels and related global greenhouse gas emission pathways, in the context of strengthening the global response to the threat of climate change, sustainable development, and efforts to eradicate poverty.
- IPCC (2021) Sixth assessment report, Working Group I—The Physical Science Basis
- IRENA (2017) Synergies between renewable energy and energy efficiency, a working paper based on Remap. International Renewable Energy Agency (IRENA), Abu Dhabi. www.irena.org/remap
- IRENA (2019) Innovation landscape brief: Net billing schemes. International Renewable Energy Agency, Abu Dhabi, 2019. https://www.irena.org/-/media/Files/IRENA/Agency/Publication/2019/Feb/IRENA_Net_billing_2019.pdf?la=en&hash=DD239111CB0649A9A9018BAE77B9AC06B9EA0D25

- Johnston P (2012) Pacific perspectives on the challenges to energy security and the sustainable use of energy UNESCAP. <https://www.unescap.org/sites/default/files/energy-security-final.pdf>
- Månsson A, Johansson B, Nilsson LJ (2014) Assessing energy security: an overview of commonly used methodologies. *Energy* 73(9):1–14
- Michalena E, Kouloumpis V, Hills J (2018) Challenges for Pacific Small Island Developing states in achieving their nationally determined contributions (NDC). *Energy Policy* 114:508–519. https://www.researchgate.net/publication/322506249_Challenges_for_Pacific_Small_Island_Developing_States_in_achieving_their_Nationally_Determined_Contributions_NDC/link/5a63d0eaa6fdccb61c54c987/download
- Mofor L, Isaka M, Wade H, Soakai A (2013) Pacific lighthouses, renewable energy roadmapping for Islands IRENA
- OECD (2020) Climate finance provided and mobilised by developed countries in 2013–2020 (OECD, 6 Nov 2020). <https://www.oecd-ilibrary.org/deliver/f0773d55-en.pdf?itemId=%2Fcontent%2Fpublication%2Ff0773d55-en&mimeType=pdf>
- OECD (2021a) Organisation for economic co-operation and development. Climate finance provided and mobilised by developed countries: aggregate trends updated with 2019 data.
- OECD (2021b) Statement by the OECD Secretary-General on future levels of climate finance. Developed countries likely to reach USD 100 billion goal in 2023. October 2021. <https://www.oecd.org/newsroom/statement-by-the-oecd-secretary-general-on-future-levels-of-climate-finance.htm>. Accessed 5 Nov 2021
- PCREEE (2020) Brenwe Hydro contract signed with NZ joint venture, Pacific Centre for Renewable Energy and Energy Efficiency (PCREEE), May 2020. <https://www.pcreee.org/article/brenwe-hydro-contract-signed-nz-joint-venture>. Accessed 5 Nov 2021
- PIFS (2021) Fifty-first pacific islands forum communique, 6 August 2021. <https://www.forumsec.org/2021/08/11/communique/>. Accessed 30 Oct 2021
- PRIF (2019) Renewable energy costs in the Pacific—final report, collation of renewable energy infrastructure project cost data in the Pacific. Pacific Regional Infrastructure Facility
- PRIF (2021a) Review of economic infrastructure in the Pacific. Pacific infrastructure performance indicators. Pacific Regional Infrastructure Facility & Pacific Community (SPC). August 2021. https://www.theprif.org/sites/default/files/documents/Pacific%20Infrastructure%20Performance%20Indicators_2021a_Web_0.pdf
- PRIF (2021b) Regional diagnostic study on the application of building codes in the Pacific. Solomon Islands Case Study. Consultant’s report. Pacific Regional Infrastructure Facility. [Sector Studies—Presented by Sector I Pacific Regional Infrastructure Facility \(PRIF\) \(theprif.org\)](https://www.theprif.org/sites/default/files/documents/PRIF%20Building%20Codes%20Guidance%20Document%20Vanuatu_web.pdf)
- PRIF (2021c) Regional diagnostic study on the application of building codes in the Pacific. Vanuatu Case Study. Consultant’s Report. Pacific Regional Infrastructure Facility. https://www.theprif.org/sites/default/files/documents/PRIF%20Building%20Codes%20Guidance%20Document%20Vanuatu_web.pdf
- PRIF (2021d) Regional diagnostic study on the application of building codes in the Pacific. Consultant’s Report. Pacific Regional Infrastructure Facility. <https://www.theprif.org/sites/default/files/documents/PRIF%20Building%20Codes%20Guidance%20Document%20WEB.pdf>
- Raghoo P, Surroop D, Wolf F, Leal W, Jeetah FP, Delakowitz B (2018) Dimensions of energy security in small island developing states. *Util Policy* 53:94–101 <https://www.sciencedirect.com/science/article/pii/S0957178717302308>
- Renewable Energy World (2017) The global transition to renewable energy-can the Caribbean lead the way? Part 1: The Potential. <https://www.renewableenergyworld.com/baseload/the-global-transition-to-renewable-energy-can-the-caribbean-lead-the-way-part-1-the-potential/#gref>. Accessed 26 Sept 2021
- Republic of the Marshall Islands (2018) Tile Til Eo. 2050 Climate strategy “Lighting the way”. The Republic of the Marshall Islands. https://unfccc.int/sites/default/files/resource/180924%20rmi%202050%20climate%20strategy%20final_0.pdf
- SEI-API (2019) Energy efficiency residential and small commercial applications guidelines. <https://www.seiapi.com/guidelines/>

- Shokri A, Heo E (2012) Energy policies to promote renewable energy technologies; learning from Asian countries experiences. College of Engineering, Seoul National University, Republic of Korea, Program
- SPC (2010) Framework for action on energy security in the Pacific <http://prdrse4all.spc.int/node/4/content/framework-action-energy-security-pacific>
- SPC (2011a) Indicators for the framework for action on energy security in the Pacific (G Zieroth, SPC, 3 March 2011). https://www.spc.int/nmdi/Reports/Final_Report_Energy_Security_Indicators_2011.pdf
- SPC (2011b) The costs and benefits of introducing standards and labels for electrical appliances in Pacific Island countries. Prepared for the Secretariat of the Pacific Community by G. Wilkenfield
- SPC (2012) Country energy security indicator profile 2009 (SPC, 2012) series is available at http://prdrse4all.spc.int/list/publication?field_year_published_value_selective%5B%5D=2012&field_publication_thematic_areas_tid_selective%5B%5D=141&created=All&keys=
- SPC (2016) Stocktake of energy sector institutions, legislation, policies and fiscal incentives in fourteen Pacific Island Countries/prepared by the Energy Programme, Economic Development Division of the Pacific Community
- SPC (2017) FAESP progress report for 2011–2015. <http://prdrse4all.spc.int/node/4/content/progress-report-framework-action-energy-security-pacific-2010-2020-implementation>
- SPC (2019) Fourth Pacific regional energy and transport ministers meeting, “Sustainable energy and transport services for the Blue Pacific”. Resolution of Energy Ministers. September 2019
- SPC (2021) Framework for energy security and resilience in the Pacific (FESRIP). The Pacific Community Volumes 1 and 2
- SPC & PRIF (2019) Review of the framework for action on energy security in the Pacific (FAESP) 2010–2020, In cooperation with UNDP, PCREEE and GGGI, October 2019 https://prdrse4all.spc.int/sites/default/files/faesp_report_finalnew.pdf
- UNDP (2007) Overcoming vulnerability to rising oil prices: options for Asia and the Pacific. ISBN: 978-92-1-126213-1
- UNDP (2021) Climate finance effectiveness in the Pacific—are we on the right track? Suva, Fiji
- UNEP (2021) 2021 Report: the production gap. https://productiongap.org/wp-content/uploads/2021/11/PGR2021_web_rev.pdf. Accessed 5 Nov 2021
- UNESCAP (2012) Promoting regional cooperation for enhanced energy security and the sustainable use of energy in Asia and the Pacific. Pacific perspectives on the challenges to energy security and the sustainable use of energy. UNESCAP. October 2012. [energy-security-final.pdf \(unescap.org\)](https://www.unescap.org/sites/default/files/energy-security-final.pdf)
- United Nations University (2016) World risk report. United Nations University Institute of Environment and Human Security in cooperation with the University of Stuttgart
- URA (2017) Comparative report: Pacific region electricity bills, utility regulatory authority of Vanuatu, 2017
- USDOE (2018) Low-income household energy burden varies among states—efficiency can help in all of them, office of energy efficiency and renewable energy. DOE/GO-102018-5122
- USEIA (n.d.) US energy information administration—EIA—independent statistics and analysis. Accessed from <https://www.eia.gov/international/data/world>
- World Bank (2000, 2017) World Bank open data. <https://data.worldbank.org/>. Accessed 5 Nov 2021

The opinions expressed in this chapter are those of the author(s) and do not necessarily reflect the views of the UNESCO: United Nations Educational, Scientific and Cultural Organization, its Board of Directors, or the countries they represent.

Open Access This chapter is licensed under the terms of the Creative Commons Attribution-ShareAlike 3.0 IGO License (<https://creativecommons.org/licenses/by-sa/3.0/igo/>), which permits use, sharing, adaptation, distribution, and reproduction in any medium or format, as long as you give appropriate credit to the UNESCO: United Nations Educational, Scientific and Cultural Organization, provide a link to the Creative Commons licence and indicate if changes were made. If you remix, transform, or build upon this book or a part thereof, you must distribute your contributions under the same licence as the original.

The use of the UNESCO: United Nations Educational, Scientific and Cultural Organization’s name, and the use of the UNESCO: United Nations Educational, Scientific and Cultural Organization’s logo, shall be subject to a separate written licence agreement between the UNESCO: United Nations Educational, Scientific and Cultural Organization and the user and is not authorized as part of this CC-IGO licence. Note that the link provided above includes additional terms and conditions of the licence.

The images or other third party material in this chapter are included in the chapter’s Creative Commons licence, unless indicated otherwise in a credit line to the material. If material is not included in the chapter’s Creative Commons licence and your intended use is not permitted by statutory regulation or exceeds the permitted use, you will need to obtain permission directly from the copyright holder.



Chapter 4

State of Food and Nutrition Security in the Pacific



Federico Davila, Sarah Burkhart, and Tarli O'Connell

Pacific food systems are influenced by multiple governance and socio-ecological systems, and opportunities for transformations exist from expanding traditional understandings of food and nutrition security to include agency and systems thinking.

Abstract Pacific Island Countries and Territories (PICTs) are home to tremendously diverse food systems. These systems are made up of rich cultures, a growing young population, and diverse bio-geographic and multiple agro-ecological zones. This Pacific uniqueness, however, is being disrupted by historical international forces, food consumption behaviours, and climate change. The region's food systems currently face a triple burden of malnutrition, which when combined with poverty and climate change impacts, creates major food and nutrition security risks. In this synthesis chapter, we provide summary of evidence on the state of food and nutrition security in the Pacific using an expanded five pillar framework of food security. We present a synthesis of research and development dynamics in the context of availability, accessibility, stability, utilization, and agency as the five pillars of Pacific food and nutrition security. Agency is emphasized as a novel addition to capture the unique socio-cultural systems of the region that contribute to food systems. The future of Pacific food systems will depend on proactive focus on the multi-dimensional nature of food and nutrition security, and the use of integrative frameworks and policies will help address this important development opportunity.

Keywords Food security · Nutrition · Food systems · Pacific Islands · Indo-Pacific

F. Davila (✉)

Institute for Sustainable Futures, University of Technology Sydney, Building 10, Level 10,
235 Jones Street, Ultimo, Sydney, NSW 2007, Australia
e-mail: federico.davila@uts.edu.au

S. Burkhart

Australian Centre for Pacific Islands Research, University of the Sunshine Coast, Sunshine Coast,
QLD, Australia

T. O'Connell

Independent Researcher, Sunshine Coast, Australia

© UNESCO 2024

A. Dansie et al. (eds.), *The Water, Energy, and Food Security Nexus in Asia and the Pacific*, Water Security in a New World,
https://doi.org/10.1007/978-3-031-25463-5_4

85

4.1 Introduction

The Pacific region is a hugely heterogeneous region in regard to cultures, climatic zones, and hydro-geological profiles. This diversity has created equally complex food systems in marine and agriculture areas. A food system is generally defined as the interaction of all food activities, ranging from production to waste management, and their feedbacks with multi-scalar socio-economic and global environmental change (Béné et al. 2019; Ingram 2011). Feedbacks throughout this system lead to the ultimate system outcome: food and nutrition security (FNS), defined as “a situation that exists when all people at all times have access to safe and nutritious food to meet their dietary needs and preferences” (FAO 2020c). This complex systemic outcome includes issues of nutrition and health, economic and physical access, social diversity and acceptability, and the agency of communities to make informed food choices (HLPE 2020). Substantial work has been done to document the food security situation from an economic and calorific energy intake perspective (McGregor et al. 2009) within the context of climate change (Barnett 2011) and within a regional vulnerability context (SPC 2011). The disruption of socio-economic impacts of COVID-19 in the Pacific has also created an imperative to articulate pathways for building future food systems resilience and improving FNS for Pacific countries (Davila et al. 2021; Ferguson et al. 2022). While there continue to be multiple analyses of FNS in individual countries and communities in the Pacific, there is less regional focused literature conceptualizing FNS in the region.

Pacific island nations have a rich history of traditional land and marine systems management that continues to influence how communities manage their natural resources (Campbell 2015; Wairiu 2017). Pre-colonial food systems were characterized by diverse activities surrounding food production and exchange, which included a mix of subsistence farming and hunter-gatherer food harvesting systems, bartering, and regional trade between islands. Nutrient rich diets with leafy vegetables and complex carbohydrates were traditionally normal, with plant foods constituting 83% of the diet, and poultry, fish, and pigs making up the protein requirements of many Pacific Island people (Connell 2015; Gniecchi-Ruscione and Painsi 2017). With the surge of trade liberalization in the mid-1990s, the region experienced a rapid increase of cheap imported highly processed foods such as noodles, rice, and baked goods (Charlton et al. 2016; Plahe et al. 2013). These imports have slowly shifted food eating habits, and have been accompanied by increasingly sedentary lifestyles, both of which contribute to the substantial burden of non-communicable diseases (NCDs) in the region (Sievert et al. 2019) (also see Table 4.1). The breadth of such burdens experienced throughout the region spans wasting, stunting, and micronutrient deficiencies, as well as obesity and diabetes. Table 4.1 compiles available data to provide an overview of food production (agriculture and fisheries), health context, and food consumption for selected PICTs. The table offers insights from selected countries across a spectrum of food systems, from largely import dependent (like Kiribati and Tuvalu), to productive agricultural countries like Fiji and Papua New Guinea (PNG). The table summarizes the diversity of food system contexts, with data on nutrition,

food consumption, and agricultural activities. There is a large paucity of food, nutrition, and health data throughout the region (similarly for water, see Chap. 2), which makes collating accurate and up to date information for decision-making a challenge. For example, food consumption and nutrition surveys are conducted through the Household Income and Expenditure Surveys, but the ad hoc frequency of these surveys and limitations in data access make it hard to use this source with any consistency. We note that the Sustainable Development Goals have pushed for more accurate data, and efforts by regional agencies like the Pacific Community (SPC) have made substantial efforts in organizing food systems data (see for example the Pacific Data Hub website).

Data from the most recent Global Burden of Disease (GBD) (IHME 2018) study shows that the top two risk factors causing the greatest burden of disease in the region are malnutrition (including nutritional deficiencies) and dietary risks (including diabetes, kidney disease, and cardiovascular diseases). As is the case in many areas around the world, such diseases coexist with nutritional insufficiency. Differences in the experience of various NCDs across genders is evident in the summary of various nutritional indicators of men, women, and children in selected PICTs presented in Table 4.2. Table 4.2 showcases the concerning rates of malnutrition, for example with Melanesia experiencing more than double the global average in stunting in children under five. Diabetes and obesity, across all three regions, is well over the global average for men and women. Delivering improved nutritional outcomes from food systems is crucial to limiting the increasing impact on health systems and supporting the overall wellbeing of vulnerable Pacific communities. This is particularly important to support the physical and cognitive development of the young people, which in some countries make up the majority of the population (SPC 2014).

The above human nutrition context from Table 4.2, coupled with risks from climate impacts in the region, make food and nutrition security core elements of the water-food-energy nexus. In this chapter, we present an overview of how five major dimensions of FNS are currently illustrated across different Pacific food systems. We discuss the five pillars of FNS with different examples from throughout the region, showcasing the complexity of regional approaches to improving FNS outcomes in food systems. To capture the different dimensions of food and nutrition security, we organize the chapter around the four pillars of food and nutrition security, and add an additional pillar focused on agency to capture the crucial issue of sovereignty and equity that have traditionally been missed from food security analyses (Chappell 2018). We conclude with reflection on the large socio-ecological conditions that will influence the future of food and nutrition security changes in the Pacific region.

4.2 Food and Nutrition Security Analytical Framework

Measuring and understanding the FNS of a community, nation, or region is highly complex and can be done through multiple approaches (Burchi and De Muro 2016). Traditional approaches to FNS analysis have focused on food availability

Table 4.1 Summary of nutrition outcomes, food production, and food consumption aspects of selected Pacific food systems

Category and United/Country	Kiribati	Solomon Islands	Tuvalu	Samoa	Tonga	Papua New Guinea	Vanuatu
Nutrition and demographic measures							
Stunting rate ^a (% under 5 years)	15.2	31.6	10	4.9	8.1	49.5	28.5
Wasting rate ^a (% under 5 years)	3.7	8.5	3.3	3.9	5.2	14.1	4.4
Obesity ^a (% male/female)	42/50	18/27	47/56	40/55	41/54	17/26	20/30
Population distribution ^b (% rural/urban)	46/54	76/24	38/62	82/18	77/23	87/13	75/25
Production							
Agricultural land ^c (% land area)	42	3.9	60	12.4	45.8	25.6	15.3
Agriculture and fisheries, value added ^b (% of GDP)	30.8	35	16.5	9.8	17.2	17.7	25.8
Per capita food production variability (2015) ^d (\$ per person constant 2004–2006)	24.1	2	1.3	4	9.8	1.9	16.8

(continued)

Table 4.1 (continued)

Category and United/Country	Kiribati	Solomon Islands	Tuvalu	Samoa	Tonga	Papua New Guinea	Vanuatu
Value of food imports over total merchandise exports ^d (3-year average) (2015–2017) (Percent)	261	22	14	158	231	8	123
Emissions (CO ₂ equivalent) from land-based agriculture (2018) In gigagrams (1,000 tonnes)	8.45	65.55	5.95	181.52	68.81	4,738.58	434.06
Top staple foods (Note that most rice is imported into PNG and PICT countries)	Banana, coconut, taro, breadfruit ^c	Sweet potato, coconut, rice, cassava, banana taro, yam ^e	Swamp taro, coconut, banana, breadfruit, taro, cassava, sweet potato ^f	Taro, rice, coconut, banana, wheat-based foods ^g	Cassava, coconut, sweet potato, yam, taro, banana ^c	Sweet potato, rice, banana, coconut, yam, cassava, <i>Colocasia</i> taro, <i>Xanthosoma</i> ^h taro, sago	Taro, coconut, rice, banana, yam, cassava, sweet potato ⁱ

(continued)

Table 4.1 (continued)

Category and United/Country	Kiribati	Solomon Islands	Tuvalu	Samoa	Tonga	Papua New Guinea	Vanuatu
Consumption							
Average national energy consumption (kcal/capita/day)	2,760 ^j	2,640 ^k	2,800 ^l	2,800 ^m	2,900 ⁿ	2,629 ^o	3,056 ^p
Proportion of energy consumed as:							
Protein (%; note WHO recommends 10–15%)	13	11	14	11	14	8 ^o	12 ^p
Fats (%; note WHO recommends 15–30%)	17	22	29	34	27	No data	22 ^p
Carbohydrates (%; note WHO recommends 55–75%)	70	67	57	55	59	No data	No data
Fruits and vegetables consumed (grams/capita/day; WHO recommends 400 g)	130	182	102	300	260	No data	No data

(continued)

Table 4.1 (continued)

Category and United/Country	Kiribati	Solomon Islands	Tuvalu	Samoa	Tonga	Papua New Guinea	Vanuatu
Food consumed from local (in-country) production, contribution to total dietary energy consumed (%)	12	52	25	30	19	No data	No data
Contribution of food groups and food products to average dietary energy consumption ⁴							
Cereals and their products (%)	44	24	34	29	22		26 ^r
Meat and meat products (%)	>5	>5	8	10	13		11
Fish, shellfish, and their products (%)	8	7	7	>5	>5		>5
Sweets, sugar, and syrups (%)	17	5	17	7	5		6
Pulses, seeds, and nuts (%)	5	19	No data	No data	No data		No data

(continued)

Table 4.1 (continued)

Category and United/Country	Kiribati	Solomon Islands	Tuvalu	Samoa	Tonga	Papua New Guinea	Vanuatu
Oil crops (%)	No data	No data	19	18	No data		6
Roots, tubers, plantains, and their products	>5	36	>5	10	29		No data

^aGlobal Nutrition Report (2020) Note national nutrition surveys may have more recent statistics. For ease of comparison and data access we have used the Global Nutrition Report for all countries. Due to the Global Nutrition Report not having stunting rate and wasting rate data for Kiribati we have used the UNICEF, WHO and World Bank Group Joint Child Malnutrition Estimates Expanded Database (2020)

^bWorld Bank World Development Indicators (2021)

^cFAO (2020b) and for PNG see Allen and Bourke (2009)

^dFAO (2021)

^eGovernment of Solomon Islands (2015)

^fGovernment of Tuvalu (2016)

^gGovernment of Samoa (2016)

^hBourke and Vlassak (2004)

ⁱGovernment of Vanuatu (2020)

^jFAO, SPC and Kiribati Food Security Profile (2020) same reference for: Proportion of energy consumed as protein, fats, carbohydrates; fruits and vegetables consumed; food consumed from own production, contribution to total dietary energy consumed; contribution of food groups and food products to average dietary energy consumption

^kFAO and SPC, Solomon Islands Food Security Profile (2020)

^lFAO, Tuvalu Central Statistics Division and SPC (2020)

^mFAO (2021b)

ⁿFAO, SPC and Tonga Department of Statistics (2020)

^oFAO (2003)

^pMartyn et al. (2014)

^qEstimates are based on the analysis by FAO of food data collected in Household Income and Expenditure Surveys. The definition of food groups and food products vary between countries. Caution is highly advised when comparing data. For example, in some cases 'meat products' also include eggs, in others it does not. Some data is also over a decade old

^rWHO, Vanuatu—Food and Nutrition Security Profiles (2021)

Table 4.2 Summary of malnutrition and obesity in the Pacific Islands countries, based on data from the Global Nutrition Report (2020)

	Melanesia (Fiji, Papua New Guinea, Solomon Islands, Vanuatu) (%)	Polynesia (Samoa, Tonga, Tuvalu) (%)	Micronesia (Kiribati, Marshal Islands, Federal States of Micronesia, Nauru, Palau) (%)	Global average (%)
Women of reproductive age with anemia	35.9	27.9	25.1	32.8
Stunting, children under 5-years	49.5	4.9	Data not available	21.9
Wasting, children under 5-years	13.3	3.9	Data not available	7.3
Overweight in children under 5-years	13.7	5.3	Data not available	5.9
Men with diabetes	15.3	22.4	21.7	9
Women with diabetes	14.8	26.4	22.8	7.9
Men with obesity	17.5	54.9	43.6	10.5
Women with obesity	26.8	40.7	53.1	14.7

approaches, which looked at the balance between population and food, or on income-based approaches, which focused on incomes and purchasing power. While valid metrics, these approaches fail to capture the underlying determinants that lead to pervasive food insecurities, notably the socio-cultural and underlying societal norms. The seminal approaches, focused on entitlements (Sen 1982) and livelihoods (Scoones 2009), have become common lines of enquiry to understand the structural conditions that can enable FNS. The combination of these different approaches is now used by policy agencies across scales to understand the ultimate impacts on the major categories of FNS: availability, accessibility, adequacy, acceptability. These four major pillars are well recognized; however, they lean towards focusing on quantifiable metrics of FNS and miss influential social dimensions (HLPE 2020). To overcome these limitations, much of critical food scholarship from food sovereignty has focused on how cultural diversity and power relations influence FNS in different contexts. Rather than perpetuating the tradition to contrast agency-based approaches with metric-based approaches, some authors have proposed that the inclusion of sovereignty and agency is now a well-recognized principle for genuine FNS (Chappell 2018; Davila 2020; HLPE 2020). Furthermore, agency is a core determinant of long-term resilience across scales, as it allows the diversity of actors, including marginalized ones, to have a greater voice in decisions being

made. Creating equitable Pacific food systems requires embedding agency into decision-making in formal food security interventions, to work with the traditional and reciprocal approaches of engaging with food in PICTs.

The framework used in this chapter builds from the common pillars in food security, but adds the socio-political lens grounded in food sovereignty. The 5 Pillars Framework is proposed as a way of focusing on the economic and health dimensions of traditional definitions of food security and includes additional principles of agency and decision-making to address underlying issues of justice and equity that are often missed in food security debates. Chappell (2018) argues that agency is an essential ingredient in bridging food sovereignty as a *process* that can contribute to more equitable food security *outcomes* in specific cases. Agency emerges from much longer traditions that critique common framings of food security, which tend to lean towards markets, and build from elements of food *sovereignty* definitions, which focus on processes, power relations, and the ability of communities and nations to define their food systems (Davila 2020).

Since the 1980s, Pacific food systems have globalized, with increased food imports throughout the region. Diverse diets and food staples have been replaced by more affordable or attractive high-calorie foods, contributing to the increase in NCDs. Analysis of historical trade data shows that the Pacific region has become a net importer of food, with Melanesian leading the region with growing from approximately 200 tonnes in 1997 to 800 tonnes in 2017 (Andrew et al. 2022). The degree of reliance on imports as a percentage of food expenditure is different throughout the region, with most nations having negative food balances (McGregor et al. 2009; SPC 2011). The reliance on international food exposes PICTs to fluctuations in food prices, which can have serious implications for food security for the poor and vulnerable. In the previous global food crisis in 2008, an analysis by the United Nations Development Programme (UNDP) showed that 50% of Pacific people, even in rural areas, buy their food (rather than grow it) to meet their food security needs (Parks and Abbott 2009). Despite the general increase in imports, agricultural productivity and exports have been relatively stagnant in the region, notably in Polynesia and Micronesia (Farrell et al. 2020). This makes Pacific communities dependant on international food production systems, making them vulnerable to changes in these distant agricultural landscapes, and impacting the incomes of communities through the requirement to purchase foods.

4.2.1 Availability

Availability of food relates to *having a quantity and quality of food sufficient to satisfy the dietary needs of individuals, free from adverse substances and acceptable within a given culture, supplied through domestic production or imports* (HLPE 2020). Food availability depends on the extent in which rural communities depend on subsistence or purchased foods and varies widely depending on household incomes. Subsistence production is widespread in the region, particularly within rural areas, but can be

constrained by soil quality, climatic conditions, and limited area for food production (Taylor et al. 2016). While there may be availability of foods, including staple root crops, diversity within food groups can be limited (Bottcher et al. 2020; Hidalgo et al. 2020; Savage et al. 2020). Production diversity is very limited in atolls like Kiribati or Tuvalu, which are less than 5 km wide and very flat, with poor coral-based soils and limited freshwater (Chap. 2). These biophysical conditions limit the type of food that can be grown, and with growing and increasingly urbanized populations (Trundle et al. 2019), food has to be imported. For example, up to 72% of diets in Kiribati are made up of imported foods (Estimé et al. 2014). Imported foods can provide stability in food availability, but can increase a country's vulnerability to changes in global food supply chains and pricing (Savage et al. 2020). As capacity to import food has increased, so has the availability of processed foods, with long-shelf lives highly suited to long sea voyages, within the region (Snowdon et al. 2013). Given the evidenced link between ultra-processed foods and poor health outcomes (Monteiro et al. 2019), this is of current and great concern in the Pacific (Table 4.2).

Food production in the region has been impacted by urbanization and trade with impacts seen in rural and urban settings. In rural settings, a move towards a formal (or monetary based) economy has impacted food availability. As rural populations move towards engaging with roles that provide an income, there is less time for food production activities (Savage et al. 2020) and at times, an increased reliance on more convenient, imported processed foods (Hidalgo et al. 2020). Commodity crops (e.g., Kava in Fiji), sometimes replace or displace traditional root crops or vegetables (Campbell 2015), reducing the availability of traditional staple foods for local communities. As communities and villages increase in population size, less land may be available for gardening. This has led to increased urbanization in the region, with the perverse outcome of informal settlements emerging in larger cities like Suva, Port Moresby, and Honiara. These informal urban and peri-urban settlements, which often have people living below the poverty line, have limited land available for growing food in home gardens and their food security is largely dependent on what they are able to buy. People in these settlements also have limited access to clean water (Chap. 2) and affordable, reliable, and clean energy (Chap. 3).

Climate hazards (Chaps. 5 and 10) and environmental concerns also place pressure on local food production, ultimately impacting the diversity of, and overall food availability. In the PICTs particularly, major climate events such as tropical cyclones, can result in long-lasting damage to land. For example, in a remote island of Ono in the Kadavu province of Fiji, communities report climate change as an ongoing challenge to food security (Hidalgo et al. 2020). Villagers are deterred from planting fruits and vegetables due to variable water availability and rising temperatures and describe how land damage from a tropical cyclone in 1979 has only recently seen to be improving. At the same time, fishermen report that once plentiful supplies of fresh fish and shellfish close to shore are now accessed by fisherman who are required to travel further from shore, for longer periods of time, and sometimes at night. These climate events restrict market access for producers and consumers (Campbell 2015). Different food crops are more or less susceptible to different climate hazards. Banana

plantations are highly susceptible to storm damage, for example the crop decimation in Samoa by Cyclone Gita in 2018. Taro plantations in coastal alluvial plains are most at risk from soil and groundwater salinization. Uncertainty and severity of future climate hazards will continue to impact food availability in the region.

4.2.2 *Accessibility*

Access to food relates to the ability of people to obtain safe and nutritious food to meet their dietary needs. While availability relates to the physical presence of food, accessibility includes aspects of geographical and economic access to food. For example, Bogard et al. (2021) explain that different types of food environments exist within the Solomon Islands, and the type of food environment determining the access to types of healthy foods. They found that participants in rural areas are more likely to access the WHO recommended daily >400 g of non-starchy fruit and vegetables, partially due to the immediate physical access to this food. Access is also determined by the underlying structural issues of class, access to land, and gender relations (FAO 2019a, b, 2020a). As noted above, different types of food availability exist throughout the region depending on the type of food harvested or fished. Accessing this food thus depends on the economic and physical conditions of people. For example, while PNG has a productive agricultural sector, high poverty rates and limited access to physical markets means carbohydrates are the main source of food; protein, fats, and oils more often being inaccessible or expensive (Bourke and Harwood 2009; Iese et al. 2018). These different economic and physical dimensions of food access thus limit the ability of individuals to achieve FNS, regardless of its availability.

There are two major factors limiting access to nutritious food. The first is the cost of healthy food. As per the availability section—imported foods are now common to Pacific diets. However, a different dimension of this import reliance is the costs of it, and the impact it has on the ability to access. Imported food can be cheaper than local products, which in a region with increasing poverty, means that imported foods might be more accessible. Furthermore, the conveniences of using imported food such as rice and noodles can save substantial time for households, making fresh food preparation less appealing. The combination of this convenience and cost factors creates barriers for healthy food preparation and consumption. A second limiting factor is the ongoing and projected threats of climate change in the region and the impacts it will have on either producing subsistence food or producing cash crops for incomes to access food. For example, the 2019 Tropical Cyclone Harold in Vanuatu destroyed 95% of homes in Pentecost; with cash-crop damages ranging from 50–100%. The globalization of food meant that some of the affected communities had been intensively planting kava for international consumers in Australia and the United States, and had limited to no subsistence food crops planted when the cyclone hit. With kava crops destroyed, these communities were left without incomes overnight, and thus without the ability to access food either through subsistence or through purchasing. The proximity of individuals and communities to coastal areas also poses

major risks, as projected sea level rise will likely impact households and distribution networks, limiting access to food in the future.

Access to different types of foods has changed in the region. Andrew et al. (2022) showed that since 1995, import tonnage of food and beverages for the region have been dominated by cereals other than rice (14%), rice (12%), sugar and sugar confectionary (7%), wheat and meslin flour (5%) and poultry meat and offal (5%). Data on food imports between 2001 and 2009 in the region shows that in Melanesia, approximately 17–20% of energy is obtained from imported food (an outlier is Fiji, with 58%). Contrastingly, in the more productive fertile countries like Tonga and Vanuatu, island cabbage, sweet-potato, cassava, yams, and taro make up the main foods consumed by poorer households who grow these in their home gardens. In urban areas in Tonga, there is high accessibility to mutton flaps and imported chicken, accounting for more than a quarter of the daily energy needs and about a fifth of the total household expenditure on food (SPC 2011). Meat consumption has increased in the region from 34 kg per person to 52 kg between 1973 and 2003 (SPC 2011), with Tongans consuming approximately 107 g of chicken per person per day in 2020 (FAO 2020d). Changes in food accessibility have led to an overall dietary transition in the region, which when coupled with increased sedentary lifestyles, has resulted in a surge in NCDs (Table 4.2) which present a long-term burden and risk to health systems in the region (Charlton et al. 2016; Thaman 1988).

Access to food is also conditional on the proximity to coastal areas, given a generally high reliance on fish for animal based protein and as a source of livelihood for communities in the region (Charlton et al. 2016). Proximity to coastal areas is extremely high in the Pacific with 97% of the population living less than 1 km from the coast when PNG is excluded, or 50% when PNG is included (Andrew et al. 2019). This proximity to coastal areas, and the location of major capitals with food markets near coastal areas as well, means physical access to food is relatively adequate in the region. The coastal proximity of most of the population means that access to fish is high and provides a 50–90% of required animal-protein for 50% of the Pacific population (SPC 2015). A review of fish consumption in the Pacific found that per capita annual fish consumption ranges from 18 to 64 kg; however, with projected population growth it is expected that coastal ecosystems will be unable to yield sufficient fish to maintain required protein needs (Charlton et al. 2016). This decline in fish species, which will be accelerated by loss of coral reef habitats due to ocean acidification (Johnson et al. 2015), can pose long-term food security risks to Pacific communities. Offshore, the tuna industry provides a major contribution to both domestic and export markets and is targeted by both PICT and international fishing fleets with the four main target species of yellowfin, skipjack, albacore, and bigeye not currently considered to be overfished (Hare et al. 2020). Given the highly nutritious value of fish, determining how protein will be sourced and how marine environments can be sustained to meet the requirements of the population in the future is an important area of continued research and policy for food and nutrition security (Bell et al. 2009).

4.2.3 Adequacy

Food adequacy has two components and has received increasing attention in food and nutrition security policy discourses which previously focused on physical and market access and stability. The first component relates to the extent to which the food consumed is able to meet the dietary needs of the population. There is widely accepted nutritional research that shows Pacific communities are consuming inadequate food (Farmery et al. 2020; Lyons et al. 2020; Vogliano et al. 2021). Over-nutrition is persistent and has contributed to obesity and high prevalence of NCDs in the region. NCDs cause 60–80% of deaths in the Pacific, influencing life expectancy which averages from mid- to low-60 years. Contrastingly, stunting and wasting are chronic in some rural areas in the larger Melanesian countries. For example, in PNG the prevalence of stunting in children under five years of is 49.5%, significantly higher than the low- and middle-income country average of 25% or the global average of 21.9% (Table 4.2). There has been an increase in poverty in the region since the 1990s (Chap. 14), and with limited safety nets and public support systems, household income is limited for making adequate food choices (Edwards 2020; SPC 2011). Analysis of trade agreements and sales of processed foods between 2004 and 2018 across various Pacific islands has shown there has been an increase in sales of imported items, such as vegetable oils and meat (Plahe et al. 2013). They note that the urbanization trends in the region lead to people having decreased available time and limited physical space, making cooking with oils over traditional cooking methods more convenient (Sievert et al. 2019). Historical analysis points towards the fundamental shifts colonialism played in transforming diets and farming systems, establishing new trade systems, intensifying commodity production, and transitioning the region from subsistence towards a system where cash was required to access food (Connell 2015; Plahe et al. 2013). The conflation of colonial legacies (Chap. 11), urbanization and poverty, and changing food import and export patterns have all impacted the current adequacy of nutritious food in the region.

The second component of adequacy relates to the sustainability of farming and fishing, and the extent to which it is adequate to support ecological and climate resilience. As discussed in more detail in Chap. 6, Pacific Islands have hugely diverse natural resources and ecosystems that are the basis of these industries. Countries like PNG, Fiji, and Solomon Islands benefit from highly fertile soils and in some instances abundant water resources (Chap. 2), while the drier islands of Tonga and Samoa, or coral based Tuvalu and Palau make farming much more difficult. Oceanic fish resources are governed by the Pacific Islands Forum Fisheries Agency (FFA), with standards and regulation for deep ocean species (such as tuna) maintained along with oversight for monitoring and sustainable catch standards (Barclay and Cartwright 2007). Coordinated management is more limited in coastal fisheries, which are moving towards community based management systems to support more sustainable use of resources through inclusion of diverse knowledges (SPC 2015). In agricultural systems, there is ongoing tension between subsistence agriculture and

more ‘modern’ and industrial oriented agricultural practices. The focus on international exports of cash commodities like taro, sugar, and cocoa lead towards tendencies to intensify production at the cost of marginal land. The region is dominated by small farms of under 10 hectares, and farmers tend to grow a mix of cash commodities for local markets and subsistence produce. Use of chemicals (fertilizer for enhanced growth and insecticide/fungicide for pest and disease control) has increased and has seen national policy prioritizing use in particular industries (for example sugar in Fiji); however, the high cost of these means most farmers continue to farm using more traditional low-input methods. Theoretically communities in the atolls have an opportunity to develop innovative low-cost composting and circular economy systems that help capture nutrients for the low-quality soils. Types of interventions like this already exist to support adequate sustainable farming, but up-scaling and adoption of the technologies remains a barrier.

4.2.4 Acceptability

Cultural diversity in the Pacific region fosters different perceptions of what acceptable food consumption is. Acceptability of food is heavily influenced by a combination of class and status, social practices, religion and belief systems, and specific traditions (Briones Alonso et al. 2018). For example, pigs in PNG are the most valuable livestock commodity and play an important cultural and ceremonial role. They are used to celebrate weddings, Christmas, graduations, as well as for dispute settlements and other bartering processes (Ayalew et al. 2011). This makes this source of protein acceptably consumed only in special occasions. But what is ‘acceptable’ to eat, and the way people eat has changed through time in the region. Before colonialization there was highly acceptable trading and bartering within and between countries, and food was eaten communally across households (Campbell 2015). These cultures of sharing are still very prevalent in the region, but the type of food that is consumed has shifted. There are now efforts to develop culturally appropriate and healthy diets based on local produce. For example, the Pacific Guidelines for Healthy Living provide an accessible guide to normalizing the consumption of diets that meet global health guidelines, as well as encouraging consumption of vegetables from home gardens commonly present in the region (SPC 2018). The COVID-19 pandemic has led to a resurgence in home gardening and domestic food production, and has created an opportunity to reframe the acceptability of eating local fresh food over more convenient imported foods (Davila et al. 2021).

An important factor that influences food security is the acceptability of gender roles and norms in food systems in PICTs. Gender relates to the socially constructed attribution of roles and norms to specific members of society, and is normally linked to the binary distinction between male and female roles (Barclay et al. 2018). In Pacific islands, there continues to be a strong acceptability on distinct roles of men and women in particular parts of the value chain. For example, in coastal fisheries, it is more acceptable for men to go out on boats and do the days fishing, while the women are responsible for processing and selling the caught fish and preparing any

household meals from the men's labour. Contrastingly, women play an important role in shallow water fishing and catching bivalves, crustaceans, and small pelagics, and then selling them (Barclay et al. 2018; Kronen and Vunisea 2009). These gender roles and norms throughout the region intersect with how food is prepared and accessed by families. The increase in women's contribution, to more than just food production, can help shift the accepted framings towards ones where women are agents of change in household food security.

4.2.5 Agency

The first four pillars of food security examined in this chapter cannot be achieved without agency (Chappell 2018; HLPE 2020). Agency is the capacity of communities to shape their food systems, to make empowered decisions about what they eat and, in doing so, to realize their own food and nutrition security (Chappell 2018).

In the PICTS, agency over food choices has become disproportionately influenced by large corporations and other global actors with interests in advancing the globalization of food supply (Plahe et al. 2013; Thow et al. 2011). Trade agreements and investments have enabled these actors to affect what food consumers have access to (Campbell 2020; Sievert et al. 2019). This has eroded the sovereignty governments in PICTs have over their food systems and, as their food supply has become saturated with imported foods, the agency that individuals have to make healthy food choices (Campbell 2020; Plahe et al. 2013). In response, several Pacific governments have adopted policy measures to enable and empower their communities to choose healthy foods, such as tax exemptions on fruit and vegetable imports and endorsing national dietary guidelines (Tin et al. 2020). Policy gaps remain however, and progress is impeded by corporate pressure and weak governance. Inequities in food and nutrition security persist as certain community groups have less agency over the food system and decision-making than others (HLPE 2020). In PICTs, this includes women whose decisions around food production, marginalized urban poor citizens, and rural communities who lack access to accurate information needed to make informed choices (FAO 2019b). This results in poorer food security and nutrition outcomes for these groups and, ominously, for their children.

Despite these challenging agency conditions, there are also strong narratives of localized community agency that enable food and nutrition security. The region continues to have strong cultures of food sharing and distribution, and with the reduced market opportunities due to COVID-19 there has been a re-surgency of bartering and informal trading networks. One domain where long-term national outcomes can be attained is the area of child nutrition, which is critical for the human potential of the region. Stunting is of high concern in Melanesian countries, and the adequate feeding of infants is determined by a mix of economic, cultural, and gender factors. For example, in Vanuatu, one-in-three children under five years living in rural areas are stunted, compared with one-in-five children under five years living in urban areas (SPC 2013). Twenty-one percent of women of reproductive age have anaemia

and only 29% of children in Vanuatu aged 6–23 months are fed according to recommended infant and young child feeding practices (SPC 2013). In rural areas, communities have limited access to services such as health care and education, and men tend to control decision-making at both the household and community level (FAO 2020a). Recommended policy measures to regulate corporate influence over infant and young child feeding practices have not been adopted by government (WHO 2020). However, some interventions to boost individuals' agency over nutrition outcomes do exist (see Box 4.1).

Box 4.1 Enhancing agency for nutrition in Vanuatu

To address poor nutrition and health among children living in rural areas of Vanuatu, World Vision undertook a three-year project with 79 villages in remote South West Tanna Island (World Vision Australia 2015). At baseline, 47% of children were stunted, only 52% of infants under six months were exclusively breastfed, and only 28% of mothers reported increased food intake while pregnant. Participants had limited access to health services and limited or no understanding of dietary guidelines and the benefits of a healthy diet.

A way of boosting agency in this program was engagement of the different community members in building an understanding of child nutrition. Given known gender and power inequities, the project involved the engagement of community leaders including chiefs and pastors, and their appointment of a male and female volunteer to each participating village. Volunteers were trained in nutrition and, with the support of community leaders, undertook activities to enable men and women to better understand nutrition and health. This included providing antenatal and nutrition education to men and women in separate and combined forums, developing a cookbook of healthy local recipes, and advocating to government for improved health service access. Within its short lifespan the project achieved many significant improvements in nutrition, including increasing the rate of exclusive breastfeeding to an impressive 90%, and reducing the prevalence of stunting to 37%. Having access to accurate information and practical resources like a cookbook increased the agency project participants had to make informed decisions about what they and their children eat. By including men and community leaders in the project, women were empowered and supported to apply the knowledge they acquired at household and community level.

The case above illustrates the transformative potential of interventions that enable agency and local acceptance of different ways of meeting the nutritional needs of children. Farmer organizations are spread throughout the region and provide opportunities for landholders to have greater say in their farming decisions. The COVID-19 impacts, largely health related and economic in the Pacific due to losses from tourism, have interestingly led to a growth in country level focus on agricultural production, and government incentives have been established to enable farmers to establish more crops and home gardens as a way of improving the immediate food security of the country. Yet, while these examples of agency are good in local scale, wider structural challenges remain for genuine sovereignty in the Pacific region. A major determinant are land rights, which vary widely throughout the region and continue to be contested in some areas. A further determinant is the increased focus on export of cash commodities (sugar, cacao, etc.), which can create perverse incentives and move communities away from growing food towards growing high value commodities which are more vulnerable to changes in global markets.

4.3 Conclusion: Looking to the Future of Systems-Based Food and Nutrition Security

This chapter has outlined some of the general trends in the state of food and nutrition security of the Pacific region. The huge diversity of the PICTs makes distilling any recommendations complex, as the socio-ecological conditions of each state impact the five pillars of food security. Despite this, some major drivers of change are clear across the region and will influence food interventions into the future. The first is climate change—it undeniably creates major disruptions across food production systems, value chains, and natural resources. While the impacts will be differentiated throughout the region, they will be felt by all. This indicates urgency in adaptation strategies that are cognizant of the implications of climate change in future food security. The second is increasing levels of poverty and the triple burden of malnutrition in the region. As incomes fluctuate and imported unhealthy and convenient food remains widely available and accessible, the health crisis is unlikely to go away. Furthermore, healthy food might still be unavailable from traditional systems, for example in coral atolls which have challenging agricultural conditions for vegetable production. Much of the Pacific food system remains at the mercy of international trade agreements—ones that enable the flow of cheap and unhealthy food that other (richer) countries do not want in their domestic markets. Increasing equitable trade systems and matching poverty reduction with healthy eating strategies can help reduce health risks into the future. Third is the deeply embedded traditions and cultures that enable different types of agency throughout Pacific cultures. Language, history, song, and dance have allowed Pacific communities to retain their uniqueness, while also creating a shared identity as a region connected by ocean resources. As the international food systems community re-orient itself towards more place and locally based food systems, the Pacific is in a position to amplify traditional farming systems, water and resource

management practices, and food sharing networks to increase the agency of communities in their localized food systems. Finally, the inseparable connection between land, sea, and people remains crucial to future Pacific food and nutrition security. Land is a mixed resource in the Pacific—in some places it is abundant, like in PNG, in others it is scarce and disappearing, like in atoll nations. The biophysical contexts of landscapes, and the associated tenure systems, will need to be considered if healthy food is to be enabled throughout the region's diverse geography. Similarly, the diversity of fish available will require ongoing sustainable management in light of the projected population growth and pressures on the resource. International interest and commitment to systemic approaches, such as the water, energy, and food nexus approach, that link landscapes, people, and health outcomes in a changing geopolitical and environmental context can provide important leverage for changing the status of Pacific food and nutrition security into the future.

References

- Allen B, Bourke RM (2009) People, land, and environment. In: Bourke RM, Harwood T (eds) *Food and agriculture in Papua New Guinea*. ANU E Press, Canberra, pp 27–127
- Andrew NL, Allison EH, Brewer T, Connell J, Eriksson H, Eurich JG et al (2022) Continuity and change in the contemporary Pacific food system. *Glob Food Sec* 32:100608
- Andrew NL, Bright P, de la Rua L, Teoh SJ, Vickers M (2019) Coastal proximity of populations in 22 Pacific Island countries and territories. *PLoS ONE* 14:e0223249
- Ayalew W, Danbaro G, Dom M, Amben S, Besari F, Moran C et al (2011) Genetic and cultural significance of indigenous pigs in Papua New Guinea and their phenotypic characteristics. *Anim Genet Resour Inf* 48:37–46
- Barclay K, Cartwright I (2007) *Capturing wealth from tuna case studies from the Pacific*. Asia-Pacific Press, Canberra
- Barclay K, Luduc B, Mangubhai S, Donato-Hunt C (2018) *Pacific handbook for gender equity and social inclusion in coastal fisheries and aquaculture*. Pacific Community, Noumea
- Barnett J (2011) Dangerous climate change in the Pacific Islands: food production and food security. *Reg Environ Change* 11:229–237
- Bell JD, Kronen M, Vunisea A, Nash WJ, Keeble G, Demmke A et al (2009) Planning the use of fish for food security in the Pacific. *Mar Policy* 33:64–76
- Béné C, Oosterveer P, Lamotte L, Brouwer ID, de Haan S, Prager SD et al (2019) When food systems meet sustainability—current narratives and implications for actions. *World Dev* 113:116–130
- Bogard JR, Andrew NL, Farrell P, Herrero M, Sharp MK, Tutuo J (2021) A typology of food environments in the Pacific Region and their relationship to diet quality in Solomon Islands. *Foods* 10:2592
- Bottcher C, Underhill SJ, Aliakbari J, Burkhart SJ (2020) Food access and availability in Auki, Solomon Islands. *J Hunger Environ Nutr* 16(6):751–769
- Bourke RM, Harwood T (2009) *Food and agriculture in Papua New Guinea*. ANU E-Press, The Australian National University, Canberra
- Bourke RM, Vlassak V (2004) *Estimates of food crop production in Papua New Guinea*. The Australian National University, Canberra
- Briones Alonso E, Cockx L, Swinnen J (2018) Culture and food security. *Glob Food Sec* 17:113–127
- Burchi F, De Muro P (2016) From food availability to nutritional capabilities: advancing food security analysis. *Food Policy* 60:10–19
- Campbell JR (2015) Development, global change and traditional food security in Pacific Island countries. *Reg Environ Change* 15:1313–1324

- Campbell JR (2020) Development, global change and food security in Pacific Island countries. In: Connell J, Lowitt K (eds) *Food security in Small Island States*. Springer, Singapore, pp 39–56
- Chappell MJ (2018) *Beginning to end hunger: food and the environment in Belo Horizonte, Brazil, and beyond*. University of California Press, Berkeley
- Charlton KE, Russell J, Gorman E, Hanich Q, Delisle A, Campbell B et al (2016) Fish, food security and health in Pacific Island countries and territories: a systematic literature review. *BMC Public Health* 16:285
- Connell J (2015) Food security in the island Pacific: Is Micronesia as far away as ever? *Reg Environ Change* 15:1299–1311
- Davila F (2020) Human ecology and food discourses in a smallholder agricultural system in Leyte, The Philippines. *Agric Hum Values* 37(1). <https://doi.org/10.1007/s10460-019-10007-6>
- Davila F, Bourke RM, McWilliam A, Crimp S, Robins L, van Wensveen M et al (2021) COVID-19 and food systems in Pacific Island countries, Papua New Guinea, and Timor-Leste: opportunities for actions towards the sustainable development goals. *Agric Syst* 191:103137
- Edwards R (2020) Bubble in, bubble out: lessons for the COVID-19 recovery and future crises from the Pacific. *World Dev* 135:105072
- Estimé MS, Lutz B, Strobel F (2014) Trade as a structural driver of dietary risk factors for noncommunicable diseases in the Pacific: an analysis of household income and expenditure survey data. *Glob Health* 10:48
- FAO (2003) *Nutrition country profile: Papua New Guinea*. Food and Agriculture Organization, Rome
- FAO (2019a) *Country gender assessment of agriculture and the rural sector in Papua New Guinea*. Food and Agriculture Organization, Port Moresby
- FAO (2019b) *Country gender assessment of agriculture and the rural sector in Solomon Islands*. Food and Agriculture Organization, Rome
- FAO (2020a) *Country gender assessment of agriculture and the rural sector in Vanuatu*. Food and Agriculture Organization, Port Vila
- FAO (2020b) *FAOSTAT country profiles*. Food and Agriculture Organization, Rome
- FAO (2020c) *The state of food security and nutrition in the world*. Food and Agriculture Organization, Rome
- FAO (2020d) *Tonga food security profile*. Food and Agriculture Organization
- FAO (2021a) *FAOSTAT*. Food and Agriculture Organization, Rome
- FAO (2021b) *Samoa food security profile*. Food and Agriculture Organization, Apia
- FAO, SPC and Government of Kiribati (2020) *Kiribati food security profile*. Food and Agriculture Organization, SPC, Government of Kiribati, Tarawa
- FAO and SPC (2020) *Solomon Islands food security profile*. Food and Agriculture Organization, SPC, Apia
- FAO, SPC and Tonga Department of Statistics (2020) *Tonga food security profile*. Food and Agriculture Organization, SPC, Tonga Department of Statistics
- FAO, SPC and VNSO (2021) *Vanuatu food security profile*. Food and Agriculture Organization, Vanuatu National Statistics Office, SPC, Port Vila
- FAO, Tuvalu Central Statistics Division and SPC (2020) *Tuvalu food security profile*. Food and Agriculture Organization, SPC, Tuvalu Central Statistics Division, Tuvalu
- Farmery AK, Scott JM, Brewer TD, Eriksson H, Steenbergen DJ, Albert J et al (2020) Aquatic foods and nutrition in the Pacific. *Nutrients* 12:3705
- Farrell P, Thow AM, Wate JT, Nonga N, Vatucawaqa P, Brewer T et al (2020) COVID-19 and Pacific food system resilience: opportunities to build a robust response. *Food Secur* 12:783–791
- Ferguson CE, Tuxson T, Mangubhai S, Jupiter S, Govan H, Bonito V et al (2022) Local practices and production confer resilience to rural Pacific food systems during the COVID-19 pandemic. *Mar Policy* 137:104954
- Global Nutrition Report (2020) *Country profiles*
- Gnecchi-Ruscione E, Paini A (2017) *Tides of innovation in Oceania: value, materiality and place*. ANU Press, Canberra
- Government of Samoa (2016) *Agriculture sector plan 2016–2020*. Ministry of Agriculture and Fisheries, Apia

- Government of Solomon Islands (2015) Agriculture and livestock sector policy. Ministry of Agriculture and Livestock, Honiara
- Government of Tuvalu (2016) Tuvalu national agriculture sector plan 2016–2023. Department of Agriculture, Funafuti
- Government of Vanuatu (2020) Vanuatu agriculture sector policy. Ministry of Agriculture, Livestock, Forestry, Fisheries, and Biosecurity, Port Vila
- Hare SR, Williams PG, Jordan CC, Hammer P, Hampton J, Scott RD, et al (2020) The western and central Pacific tuna fishery: 2020 overview and status of stocks. SPC, Noumea/Suva
- Hidalgo DM, Witten I, Nunn PD, Burkhart S, Bogard JR, Beazley H et al (2020) Sustaining healthy diets in times of change: linking climate hazards, food systems and nutrition security in rural communities of the Fiji Islands. *Reg Environ Change* 20:73
- HLPE (2020) Food security and nutrition: building a global narrative towards 2030. Committee on World Food Security, Rome
- Iese V, Holland E, Wairiu M, Havea R, Patolo S, Nishi M et al (2018) Facing food security risks: the rise and rise of the sweet potato in the Pacific Islands. *Glob Food Sec* 18:48–56
- IHME (2018) Global burden of disease compare. University of Washington. Accessed July 2020 from <http://vizhub.healthdata.org/gbd-compare>
- Ingram J (2011) A food systems approach to researching food security and its interactions with global environmental change. *Food Sec* 3:417–431
- Johnson J, Bell J, Gupta, AS (2015) Pacific Islands ocean acidification vulnerability assessment. PREP, Apia
- Kronen M, Vunisea A (2009) Fishing impact and food security—gender differences in finfisheries across Pacific Island countries and cultural groups. SPC Women in Fisheries Information Bulletin, Nouméa
- Lyons G, Dean G, Tongaiaba R, Halavatau S, Nakabuta K, Lonolona M et al (2020) Macro- and micronutrients from traditional food plants could improve nutrition and reduce non-communicable diseases of islanders on atolls in the South Pacific. *Plants* 9:942
- Martyn T, Yi D, Fiti L (2014) Identifying the household factors, and food items, most important to nutrition in Vanuatu. Food and Agriculture Organization, Apia
- McGregor A, Bourke M, Manley M, Tubuna S, Deo R (2009) Pacific island food security: situation, challenges and opportunities. *Pacific Econ Rev* 24(2):24–42
- Monteiro C, Cannon G, Lawrence M, da Costa Louzada ML, Machado P (2019) Ultra-processed foods, diet quality, and health using the NOVA classification system. Food and Agriculture Organization, Rome
- Parks W, Abbott D (2009) Protecting Pacific Island children and women during economic and food crises: working edition one for advocacy, debate and guidance. UNDP, Suva
- Plahe JK, Hawkes S, Ponnampuruma S (2013) The corporate food regime and food sovereignty in the Pacific Islands. *Contemp Pac* 25:309–338
- Savage A, Bambrick H, Gallegos D (2020) From garden to store: local perspectives of changing food and nutrition security in a Pacific Island country. *Food Secur* 12:1331–1348
- Scoones I (2009) Livelihoods perspectives and rural development. *Peasant Stu* 36:171–196
- Sen A (1982) Poverty and famines: an essay on entitlement and deprivation. Oxford University Press, New Delhi
- Sievert K, Lawrence M, Naika A, Baker P (2019) Processed foods and nutrition transition in the Pacific: regional trends, patterns and food system drivers. *Nutrients* 11:1328
- Snowdon W, Raj A, Reeve E, Guerrero RL, Fesaitu J, Cateine K, Guignet C (2013) Processed foods available in the Pacific Islands. *Glob Health* 9:53
- SPC (2011) Food security in the Pacific and East Timor and its vulnerability to climate change. SPC, Suva
- SPC (2013) Vanuatu demographic and health survey. Statistics for Development Division, SPC, Noumea
- SPC (2014) The Pacific Youth Development Framework 2014–2023. SPC, Noumea/Suva
- SPC (2015) A new song for coastal fisheries pathways to change: the Noumera strategy. Pacific Community, Noumea/Suba
- SPC (2018) Pacific guidelines for healthy living. SPC, Suva

- Taylor M, McGregor A, Dawson B (2016) Vulnerability of Pacific Island agriculture and forestry to climate change. SPC Suva Pacific Community, Nouméa
- Thaman RR (1988) Health and nutrition in the Pacific islands: development or underdevelopment? *GeoJournal* 16:211–227
- Thow AM, Heywood P, Schultz J, Qusteded C, Jan S, Colagiuri S (2011) Trade and the nutrition transition: strengthening policy for health in the Pacific. *Ecol Food Nutr* 50:8–42
- Tin STW, Vivili P, Na’ati E, Bertrand S, Kubuabola I (2020) Insights in public health: COVID-19 special column—the crisis of non-communicable diseases in the Pacific and the Coronavirus Disease 2019 Pandemic. *Hawai’i J Health Soc Welf* 79:147
- Trundle A, Barth B, McEvoy D (2019) Leveraging endogenous climate resilience: urban adaptation in Pacific small island developing states. *Environ Urban* 31:53–74
- UNICEF, WHO and World Bank Group Joint Child Malnutrition Estimates Expanded Database (2020) Levels and trends in child malnutrition: 2020 edition, UNICEF, WHO, World Bank
- Vogliano C, Raneri JE, Coad J, Tutua S, Wham C, Lachat C et al (2021) Dietary agrobiodiversity for improved nutrition and health outcomes within a transitioning indigenous Solomon Island food system. *Food Secur* 13:819–847
- Wairiu M (2017) Land degradation and sustainable land management practices in Pacific Island Countries. *Reg Environ Change* 17:1053–1064
- WHO (2020) Marketing of breast-milk substitutes: national implementation of the international code, status report. World Health Organization, Geneva
- World Bank (2021) World development indicators. In: World Bank (ed) Washington, DC. <https://databank.worldbank.org/source/world-development-indicators>
- World Vision Australia (2015) Learning from experience: World Vision Australia annual evaluation review. World Vision Australia, Melbourne

The opinions expressed in this chapter are those of the author(s) and do not necessarily reflect the views of the UNESCO: United Nations Educational, Scientific and Cultural Organization, its Board of Directors, or the countries they represent.

Open Access This chapter is licensed under the terms of the Creative Commons Attribution-ShareAlike 3.0 IGO License (<https://creativecommons.org/licenses/by-sa/3.0/igo/>), which permits use, sharing, adaptation, distribution, and reproduction in any medium or format, as long as you give appropriate credit to the UNESCO: United Nations Educational, Scientific and Cultural Organization, provide a link to the Creative Commons licence and indicate if changes were made. If you remix, transform, or build upon this book or a part thereof, you must distribute your contributions under the same licence as the original.

The use of the UNESCO: United Nations Educational, Scientific and Cultural Organization’s name, and the use of the UNESCO: United Nations Educational, Scientific and Cultural Organization’s logo, shall be subject to a separate written licence agreement between the UNESCO: United Nations Educational, Scientific and Cultural Organization and the user and is not authorized as part of this CC-IGO licence. Note that the link provided above includes additional terms and conditions of the licence.

The images or other third party material in this chapter are included in the chapter’s Creative Commons licence, unless indicated otherwise in a credit line to the material. If material is not included in the chapter’s Creative Commons licence and your intended use is not permitted by statutory regulation or exceeds the permitted use, you will need to obtain permission directly from the copyright holder.



Part II
Regional Issues of the Pacific

Chapter 5

Regional Climate Drivers, Trends and Forecast Change



Clare Stephens and Arona Ngari

Future projections of climate change across the Pacific are uncertain, but severe impacts are likely unless global emissions are urgently reduced and local communities are placed at the centre of adaptation efforts.

Abstract Hydroclimatology across the Pacific depends on the rain-generating South Pacific Convergence Zone and Intertropical Convergence Zone. These convergence zones move northward and southward over time (described by the El Niño Southern Oscillation index), which results in naturally high variability in rainfall, wind, tropical cyclone risk, and sea level. Future changes in convergence zone dynamics will be important for Pacific Island populations but known climate model deficiencies make projections uncertain. Extreme rainfall will probably increase, potentially enhancing flood risk, but drought risk is likely to decline in most countries. Average temperatures will be warmer in the future and marine heatwaves, together with ocean acidification, could threaten important coral reefs and fisheries. Sea level rise presents a key threat to small island nations due to saline intrusion and flooding. Global greenhouse gas emissions must be urgently reduced to avoid the worst impacts on Pacific Island nations. Local communities often have a deep understanding of their surroundings built over many generations and they are highly resilient to variable conditions. Therefore, adaptation strategies should respect and leverage traditional knowledge to maximise their effectiveness.

C. Stephens (✉)

Hawkesbury Institute for the Environment, Western Sydney University, Richmond, NSW, Australia

e-mail: clare.stephens@unsw.edu.au

Water Research Centre, School of Civil and Environmental Engineering, University of New South Wales, Sydney, NSW, Australia

A. Ngari

Cook Islands Meteorological Service, Avarua, Cook Islands

© UNESCO 2024

A. Dansie et al. (eds.), *The Water, Energy, and Food Security Nexus in Asia and the Pacific*, Water Security in a New World,
https://doi.org/10.1007/978-3-031-25463-5_5

109

Keywords Climate change · Convergence zones · El Niño Southern Oscillation · Tropical cyclones · Rainfall · Sea level rise · Ocean acidification · Local knowledge · Resilience

5.1 Introduction

Climate across the Pacific varies substantially in space and time. This is largely due to two atmospheric bands of high rainfall (convergence zones) that naturally shift over timescales of several years. The convergence zones and their changing positions are associated with droughts, floods, cyclones, and sea level variation in different parts of the Pacific. Pacific Island communities have adapted to fluctuating conditions over many generations and are often highly resilient despite limited financial resources.

Increased greenhouse gas emissions caused by anthropogenic activities are causing global climate change with worrying consequences for PICTs. Temperatures will be warmer in the future, and heatwaves are expected to cause substantial human and environmental impacts for PICTs (IPCC 2021). In particular, marine heatwaves could threaten coral reefs and fisheries. At the same time, oceans are absorbing excess carbon dioxide from the atmosphere, resulting in ocean acidification that could further exacerbate the risk to marine life. Sea level rise beyond the range of natural variability is perhaps the most well-known potential consequence of climate change for PICTs and a failure to cut global emissions could see low-lying islands inundated (IPCC 2021). However, the dynamics of erosion and sediment deposition are complex and certain island geologies may prove surprisingly robust under modest sea level rise (Kench et al. 2018; Nurse et al. 2014).

The atmospheric drivers of climate in the Pacific are notoriously difficult to simulate or predict. Together with high baseline variability, this makes climate change impacts on rainfall difficult to foresee. Some research suggests that the behaviour of the convergence zones is becoming more extreme (Power et al. 2017; Lee and McPhaden 2010). Heavy rainfall events are likely to become more frequent and some areas may see more intense (but less frequent) cyclones (IPCC 2021). Drought risk is likely to increase for some PICTs but decrease for others (Australian Bureau of Meteorology and CSIRO 2014).

Altered weather patterns, warmer temperatures, rising sea levels, and more acidic oceans are fast becoming the ‘new normal’ in a world where atmospheric carbon dioxide levels exceed 400 ppm. The situation for PICTs, particularly small island nations with limited resources, is becoming more precarious by the decade. However, there are examples of island communities and environments showing remarkable resilience in the face of climate variability and change. There is still time to avoid the worst impacts through drastic emissions reduction on a global scale, while also using community-centred approaches informed by traditional knowledge to adapt to changes already underway. Countries with substantial resources and high carbon footprints have a responsibility to the communities on the frontlines of climate

change and should commit to rapid emissions reduction along with fair distribution of adaptation funding.

5.2 Baseline Climate in the Pacific

5.2.1 *Weather and Seasonality*

Climatic conditions across different Pacific Island Countries and Territories (PICTs) are diverse, but temperatures are generally warm and annual rainfall high. Most of the countries are positioned close to the equator and experience fairly consistent incoming solar radiation (and relatedly temperatures) throughout the year. Ocean circulation patterns play an important role in regional temperature variation. Warm water is pushed from east to west by the trade winds, resulting in the West Pacific Warm Pool (Australian Bureau of Meteorology and CSIRO 2011) that further increases and stabilizes surrounding temperatures.

At large scales, rainfall across the Pacific is heavily influenced by convergence of the trade winds to create zones of high rainfall (Keener et al. 2013). The Intertropical Convergence Zone (ITCZ) lies north of the equator and drives rainfall in the Federated States of Micronesia, Kiribati, the Marshall Islands, Nauru, Palau, and Papua New Guinea (Australian Bureau of Meteorology and CSIRO 2011). The South Pacific Convergence Zone (SPCZ) approaches the equator diagonally from the southeast and affects rainfall patterns in the Cook Islands, Fiji, Nauru, Niue, Samoa, the Solomon Islands, Tonga, Tuvalu, and Vanuatu (Australian Bureau of Meteorology and CSIRO 2011). The ITCZ and SPCZ converge over the West Pacific Warm Pool. Countries in the western Pacific also receive rainfall associated with the West Pacific Monsoon (WPM), which is highly seasonal and most active over the southern hemisphere summer (Australian Bureau of Meteorology and CSIRO 2011). Changes in strength and position of the ITCZ and SPCZ cause distinct wet and dry seasons throughout the Pacific (Keener et al. 2013). Broadly, the wet season is May to October for northern hemisphere islands and November to April for southern hemisphere islands (CSIRO et al. 2015).

Locally, climate may be impacted by the terrain. High, mountainous islands can experience significant rainfall and temperature gradients. For example, Suva lies on the windward side of Fiji's largest island and receives substantially more rainfall than Nadi on the leeward side (Australian Bureau of Meteorology and CSIRO 2011). Topography is an important driver of climate in the Cook Islands, Fiji, Papua New Guinea (PNG), Samoa, Tonga, and Vanuatu (Australian Bureau of Meteorology and CSIRO 2011), as well as in Australia and New Zealand (Wratt et al. 1996; Cai et al. 2011). Terry and Wotling (2011) showed that the rain-shadow effect was amplified in streamflow, with runoff ratios 40% higher on average for windward catchments across the La Grande Terre in New Caledonia. The result is significant spatial variability in water resources across some islands. There can also be climatic variation across

countries that are spread over a large area (Australian Bureau of Meteorology and CSIRO 2011). For example, the SPCZ sometimes lies between the Northern and Southern Cook Islands, and its position can drive high and low rainfall anomalies in different parts of the country simultaneously (Rongo and Dyer 2014).

5.2.2 Interannual and Decadal Climate Variability

As discussed in Sect. 5.2.1, conditions across the PICTs are influenced by the positions of the ITCZ and SPCZ (Ludert et al. 2018), which are bands of cloudiness associated with the trade winds. The relative positions of these convergence zones vary at the interannual timescale, and this movement is described by the El Niño Southern Oscillation (ENSO). La Niña events are associated with drier conditions around the equator as the rain-generating ITCZ and SPCZ shift northward and southward respectively, while El Niño events produce drier conditions in the north-west and south-west Pacific as both convergence zones move towards the equator (Fig. 5.1). Extreme El Niño phases are associated with ‘zonal’ SPCZ events, where the convergence zone swings up to 10° north of its average position and becomes less diagonally orientated (Cai et al. 2012).

The phases of ENSO are linked to natural disasters (Power et al. 2017) and there has been a strong research focus on better understanding the associated dynamics (Matthews 2012; Rojo Hernández et al. 2020; Wang et al. 2019; Wodzicki and Rapp 2016). However, ENSO is notoriously difficult to predict or even simulate accurately

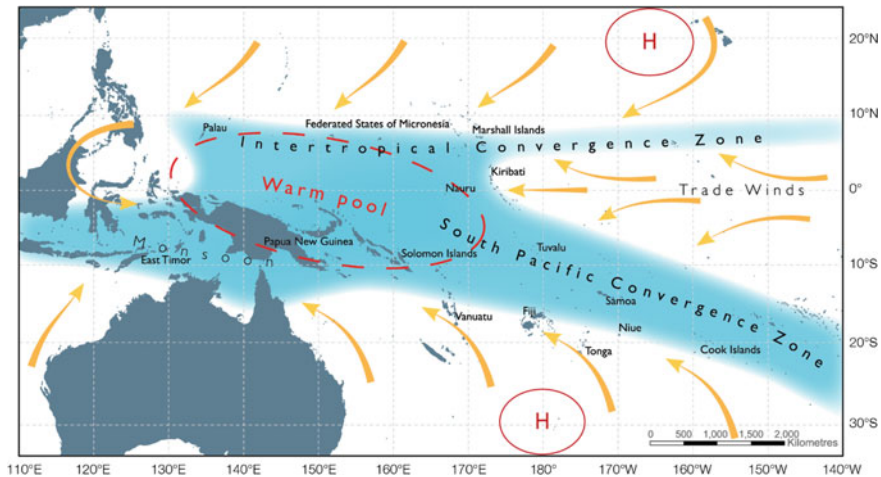

Fig. 5.1 Conceptual map of the ITCZ, SPCZ and Pacific Warm Pool, which determine climate conditions across the Pacific. Shifts of the ITCZ and SPCZ towards the equator are associated with the El Niño phase of ENSO, while poleward shifts are associated with the La Niña phase (Figure reproduced with permission from Australian Bureau of Meteorology and CSIRO 2011)

due to known climate model biases in the region (Grose et al. 2014; Samanta et al. 2019). While this creates a challenge for forecasting and preparing for ENSO shifts on the ground, many PICT communities have adapted to high interannual climate variability over generations and have developed remarkable resilience. Knowledge gaps left by uncertain weather and climate models are filled by local understanding derived directly from lived experience (Rongo and Dyer 2014). For example, some residents of the Cook Islands associate high yields of certain crops over summer with subsequent transition to El Niño, and hence heightened cyclone risk. Traditional farming techniques that are particularly robust to climatic variation have been developed in Vanuatu (Mael 2013).

Secondary drivers are thought to influence the climate across the Pacific at longer timescales. The Interdecadal Pacific Oscillation (IPO) and Pacific Decadal Oscillation (PDO) are connected to fluctuations in wind, heat flux, and ocean ‘memory’ over time periods of 15–30 years (Newman et al. 2016). The two phenomena are related, but the IPO encompasses a broader area than the PDO (Folland et al. 2002). These fluctuations influence the strength of ENSO events and the background rainfall across the Pacific (Ludert et al. 2018; Salinger et al. 2001). In fact, Folland et al. (2002) showed that IPO-driven decadal shifts in SPCZ position were comparable in magnitude to interannual shifts induced by ENSO. These longer-scale oscillations are not well understood, and recent research has suggested that they may be the result of external forcing rather than intrinsic low-frequency cycles (Mann et al. 2020).

5.2.3 *Climate Extremes*

Climate extremes including drought, extreme rainfall, tropical cyclones, and storm surge events can have devastating impacts on PICTs. Some countries, including PNG and Australia, are also highly vulnerable to wildfires. The risk of natural disasters across the Pacific is strongly linked to the phases of ENSO.

Drought in the Pacific can have damaging consequences as surface water stores are depleted and groundwater resources become strained, impacting water and food security. These challenges are especially acute for small atoll islands where the freshwater lens (the layer of groundwater that is not salty and hence usable by communities) is typically thin, but lost agricultural productivity, decreased electricity production, and other serious impacts have also been highlighted for high islands (McGree et al. 2016). Barkey and Bailey (2017) cite island size, soil permeability and local rainfall patterns as key factors influencing freshwater lens thickness and hence drought vulnerability. As noted in Sect. 5.2.2, La Niña and El Niño events can cause drought in different regions of the Pacific. In some cases, the strength of an ENSO event can impact the sign of the rainfall change; for example, rainfall over Nauru normally increases during the El Niño phase, but extreme El Niño events have caused severe drought (Brown et al. 2013a).

In alternate ENSO phases, PICTs are more likely to experience flooding rains, tropical cyclones, and storm surge. Heavy rainfall and wet antecedent conditions

caused severe flooding in Vanua Levu (Fiji) in 2012, first in January and then again in March. Eight people died and thousands were displaced, with damages to crops and infrastructure estimated at USD 50 million (Kuleshov et al. 2014). The same island was hit by Tropical Cyclone Ami in 2003, resulting in both fluvial and storm surge flooding. The storm killed 17 people and left 30,000 without a safe water supply, causing damages totalling USD 30 million (Terry et al. 2004; OCHA 2003). Tropical cyclones are behind ~76% of natural disasters in the South West Pacific (Diamond et al. 2013), with most incubating within 10°S of the SPCZ (Vincent et al. 2011). Around 80% of Western North Pacific cyclones develop in the ITCZ region (Cao et al. 2012). Even far-distant tropical cyclones can cause storm surge flooding on PICTs due to propagating waves (Nurse et al. 2014).

5.3 Effects of Anthropogenic Climate Change

As greenhouse gas concentrations in the atmosphere climb, an anthropogenically altered climate is fast becoming the ‘new normal’. The following sections detail the observed and projected climate change impacts on the Pacific, including implications for ENSO dynamics, rainfall, cyclones, temperatures, sea level rise, and ocean acidification.

5.3.1 *Shifts in the ITCZ, the SPCZ and ENSO*

Climate conditions in the Pacific are dependent on the ITCZ and SPCZ, so future changes in their behaviour will be extremely consequential. However, high underlying variability (in both space and time) makes it difficult to detect trends or attribute them to anthropogenic climate change. In many small PICTs, a lack of long-term, reliable records of temperature, rainfall, streamflow, wind, and water extraction poses an additional barrier. The result is relatively high uncertainty around the observed effects of climate change across the Pacific (McGree et al. 2016). The Coupled Model Inter-comparison Project¹ 5 (CMIP5) simulations indicate that ENSO events have already increased in frequency since pre-industrial times (Power et al. 2017). This conclusion is supported by the analysis of Lee and McPhaden (2010), who showed increasing frequency and intensity of El Niño events in the central-equatorial Pacific through analysis of satellite observations. Higher background warming has been observed in the western than eastern Pacific in recent decades, altering sea surface temperature gradients and potentially driving a shift towards more extreme El Niño events (Wang

¹ CMIP global climate models are subject to a wide array of tests against historical observations, as well as analyses of the models’ relative sensitivity to future emissions scenarios. Considering the aggregated results of these well-validated models is one of the most robust options available for projecting future climate change.

et al. 2019). However, these trends could be due to natural variability rather than climate change (Capotondi et al. 2015).

There are known problems with climate model simulations of the Pacific stemming from mischaracterization of underlying sea surface temperature patterns (Widlansky et al. 2013; Grose et al. 2014; IPCC 2021). The Pacific Ocean temperatures along the equator tend to be too low and too much rainfall is simulated over a region south of the equator (Samanta et al. 2019). Relatedly, the ITCZ is located too far north in most simulations and the diagonal slope of the SPCZ is typically underestimated (Brown et al. 2013b; Stanfield et al. 2016). These problems, along with uncertainty around the physical processes governing ITCZ and SPCZ behaviour (Byrne and Schneider 2016; Popp and Bony 2019), make projection of climate change impacts difficult. Individual models tend to show a wide range of shifts, often in contradictory directions (Brown et al. 2013b; Byrne et al. 2018). As a result, the ensemble average shifts are often close to zero, but this should not be interpreted as a robust projection of minimal change (Evans et al. 2016). Rather, it suggests that large shifts are plausible but current projections are highly uncertain.

5.3.2 Future Drought and Rainfall Projections

Because average rainfall across the Pacific is heavily influenced by the ITCZ and SPCZ, future changes in the convergence zones and ENSO will affect the hydrology of the region. Unfortunately, as discussed in Sect. 5.3.1, there is little consensus around climate change impacts on these large-scale atmospheric drivers so future rainfall shifts are also uncertain. The problem is complicated further for islands where the terrain (e.g., mountains) impacts rainfall, since GCMs are run across grids with cells in the order of 100 km² and cannot simulate these effects (Nurse et al. 2014). In general, increased average rainfall is expected near the equator, with decreases more likely in the subtropics related to changes in atmospheric circulation (Australian Bureau of Meteorology and CSIRO 2014; CSIRO and BoM 2015; McGree et al. 2016).

Extended periods of low rainfall can lead to drought, impacting agriculture and water security in the Pacific (McGree et al. 2016). While there is a perception of increased drought risk over recent decades, McGree et al. (2016) found mostly nonsignificant and spatially variable trends. Deo (2011) showed statistically significant downward trends in precipitation across Fiji from 1949 to 2008, but these were mostly driven by very low rainfall between 1969 and 1988. McGree et al. (2014) reported statistically significant decreases in average rainfall from 1951 to 2011 in the South Pacific subtropics, likely due to changes in atmospheric circulation (McGree et al. 2016). Southern Australia has seen drying, with downward trends in rainfall and upward trends in atmospheric evaporative demand (Chiew et al. 2014; Stephens et al. 2018; Delworth and Zeng 2014) and this is projected to continue as the climate warms (Grose et al. 2015). Overall, enhanced drought risk is projected for parts of Australia (CSIRO and BoM 2015) and the northern Cook Islands under a scenario of

continued greenhouse gas emissions (Australian Bureau of Meteorology and CSIRO 2014). Uncertain or reduced future drought risk is projected for most small PICTs, but often these assessments consider precipitation changes only (Australian Bureau of Meteorology and CSIRO 2014). If warmer temperatures drive increased evaporative demand in the future, water supplies could be negatively impacted. The sixth IPCC assessment projects drier conditions for the subtropical Southern and Eastern Pacific (IPCC 2021).

Extreme rainfall can be a driver of damaging floods in the Pacific, particularly when combined with wet antecedent conditions (Kuleshov et al. 2014). Extreme rainfall is less dependent on ENSO than average rainfall (McGree et al. 2014), allowing higher certainty around future changes. Because warmer air temperatures enhance the atmosphere's moisture holding capacity, increases in extreme rainfall are expected globally (Westra et al. 2014). For the PICTs, climate modelling suggests that current 5% Annual Exceedance Probability events, i.e., storms that are currently only seen once every 20 years on average, could occur four times more often in the future (Australian Bureau of Meteorology and CSIRO 2014). Such a change could substantially increase flood risk, especially in areas with increased average rainfall that could simultaneously drive wetter pre-storm soil conditions (Australian Bureau of Meteorology and CSIRO 2011; Wasko and Nathan 2019). However, high natural variability and limited long-term records hamper efforts to detect recent trends in many PICTs. Analysing an unusually long-term streamflow record for Ba River in Fiji (122 years), McAneney et al. (2017) found no significant change in flood risk.

5.3.3 *Tropical Cyclones*

Tropical cyclones are behind many natural disasters in PICTs including damaging winds, storm surge, coastal inundation, erosion, and fluvial flooding (Magee et al. 2020). The Western North Pacific region is a global hotspot for cyclone formation due to monsoon trough activity, and tropical cyclones are also a major cause of natural disasters in the South Pacific (Diamond et al. 2013; Keener et al. 2013). A decrease in cyclone frequency, but a greater proportion of major events, has been identified in the South Pacific across several studies (Keener et al. 2013; Deo et al. 2011; Webster et al. 2005), which is broadly consistent with the latest IPCC findings of increased cyclone intensity globally (IPCC 2021). However, high natural variability, operational changes that affect detection rates, and a lack of quality observations complicate cyclone trend analysis (Landsea et al. 2006). Kuleshov et al. (2008) reported a significant increase in severe tropical cyclone activity in the South Pacific, but later found that the trends were actually driven by problems with data reliability (Kuleshov et al. 2010). There are contradictory reports on tropical cyclone trends for the Western North Pacific. Keener et al. (2013) report fewer, but stronger, cyclones while Deo et al. (2011) point to weakened cyclone activity. CSIRO et al. (2015) note that contradicting trends in cyclone activity in the Western North Pacific region have been found by researchers using different datasets. The sixth IPCC report notes a

north-westward shift in tropical cyclone tracks in the western North Pacific since the 1980s, but there is low confidence that this was caused by anthropogenic climate change.

Theoretically, fewer cyclones are expected in a warmer future climate because the minimum sea surface temperatures required to drive deep convection will increase (Walsh et al. 2012). Analysis based on satellite observations suggests that this threshold is already rising (Johnson and Xie 2010). Climate simulations largely produce decreased cyclone frequency and increased average intensity across the globe (IPCC 2021), but with regional variation (Knutson et al. 2015; Peduzzi et al. 2012). Decreased cyclone frequency is projected across the Pacific, with higher confidence for the South East than the North West region (Australian Bureau of Meteorology and CSIRO 2011). Wide-ranging projections encompassing increases and decreases in average intensity have been reported for the South Pacific (Knutson et al. 2015; Walsh et al. 2012); an increase in average intensity is likely in the North West Pacific (Knutson et al. 2015).

5.3.4 Warming Trends and Heatwaves

Marine heatwaves can cause dramatic impacts on aquatic biodiversity (Oliver et al. 2018; Smale et al. 2019), including damage to coral reefs and the fisheries they support. Extreme warming in 2015/2016, driven by the combined effects of anthropogenic climate change and El Niño, caused severe coral bleaching around many small PICTs and off the eastern coast of Australia (Hughes et al. 2018). In a global study, Smale et al. (2019) noted particularly high ecosystem vulnerability in the southwest Pacific due to strong projected warming and prevalence of species living near their warm range limits. High sea surface temperatures can cause a lag in the larval supply of reef fish and negatively impact spawning, as well as driving seagrass die-off (Nurse et al. 2014). Small island communities could be severely impacted because they rely on these ecosystems for services such as coastal protection, fishing, and tourism (Nurse et al. 2014).

Mean sea surface temperatures in the western Pacific have increased at a rate of around 0.3 °C per decade since the 1980s, in line with some of the strongest trends globally, but relatively little change has been observed in the eastern Pacific (Oliver 2019). In fact, strengthening of the trade winds across the eastern Pacific Ocean and associated cool conditions have been identified as a cause of the well-known global warming hiatus (England et al. 2014), when global temperatures remained steady for about a decade from the early 2000s despite increased incoming longwave radiation. Similar patterns of strong warming in the western Pacific and little change in the eastern Pacific were found by Australian Bureau of Meteorology and CSIRO (2011) and Oliver et al. (2018), who also pointed to large increases in heatwave frequency in the western Pacific. Note that trends in marine heatwaves are generally defined with reference to pre-warming temperature extremes and are largely driven by changes

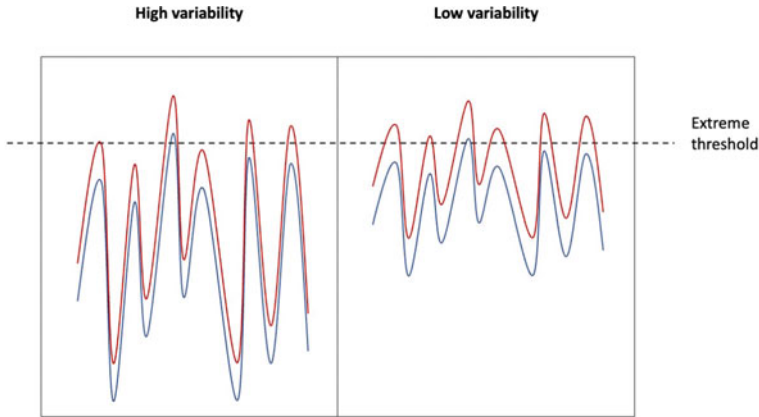

Fig. 5.2 High and low variability time series subject to the same increase in mean (blue = before increase, red = after increase). Both series cross the extreme threshold only briefly in the initial (blue) case. However, for the series with increased mean (red), the high variability series is above the threshold less frequently and for less time than low variability series

in the mean temperature, as opposed to higher variability around the mean. In fact, variance in sea surface temperature has not changed substantially across the Pacific except in the far north (Oliver 2019). Because baseline variability in annual sea surface temperature is low in the tropics, particularly in the Western Pacific Warm Pool, small changes in mean temperature lead to large changes in the probability of exceeding an extreme temperature threshold (Frölicher et al. 2018). This concept is illustrated in Fig. 5.2. The latest IPCC report notes that the tropical Western Pacific region experienced warming in both maximum and minimum temperature extremes over 1951 to 2011, and projects further increases in heatwave frequency, intensity, and duration (IPCC 2021).

As discussed in Sect. 5.3.1, complex large-scale dynamics present a challenge for climate modelling across the Pacific, and this leads to inter-model spread in future projections of Pacific Ocean temperature (Ying 2020). However, the direction of change (warming) is modelled consistently. Frölicher et al. (2018) project large increases in marine heatwave likelihood, especially in the western equatorial Pacific where temperatures exceeding the preindustrial 99th percentile could become 60 times more likely under 3.5 °C global warming. Oliver et al. (2019) use CMIP5 results to show that, under the same high emissions scenario, the tropical Pacific could experience permanent marine heatwaves (i.e., entire years where the temperature never drops below the pre-warming 90th percentile) within the next 20 years. Future ocean warming will drive serious ecological impacts and have consequences for tourism and fisheries. For example, Lehodey et al. (2013) project declining skipjack tuna populations in the western tropical Pacific starting in the mid-twenty-first century as conditions become too warm for spawning.

Land temperatures across small PICTs are strongly influenced by the surrounding oceans. Although parts of the Pacific are seeing some of the strongest ocean warming,

continental land surfaces are expected to warm at a greater rate than oceans (Byrne and O’Gorman 2013). Therefore, future warming across small island nations is likely to be relatively modest compared to warming in other countries, even in the western equatorial Pacific where increases of 1.5–2 °C (low emissions scenario) or 2.5–3 °C (high emissions scenario) are projected (Australian Bureau of Meteorology and CSIRO 2011). However, due to the limited area of small islands, temperature-driven range shifts could drive endemic species to extinction (Nurse et al. 2014). Larger countries in the Pacific are likely to warm at a greater rate; under a high emissions scenario, warming of 4–5 °C is projected for most of Australia and 3 to 4 °C is projected for most of New Zealand and Papua (IPCC 2013). Warm season daily maximum temperatures could become more variable across Australia, especially in mid-latitude Western Australia and in eastern Australia inland from the Great Dividing Range (Meehl and Tebaldi 2004). These temperature changes could drive increased drought and wildfire risk. Instances of fauna death due to temperature extremes are already being reported (Saunders et al. 2011; Welbergen et al. 2008).

5.3.5 *Sea Level Rise*

In small PICTs, sea level rise is expected to drive some of the most detrimental climate change impacts. These could include storm surge flooding, saltwater intrusion in groundwater, salinization and degradation of soils, loss of beaches damage to coastal habitat, and even permanent displacement of communities (CSIRO et al. 2015). Often these problems will be caused by sea level rise together with confounding factors such as increased coastal development pressure, more intense storms, and/or erosion by human activities (Nurse et al. 2014; Storey and Hunter 2010). For example, displacement of a village on the Torres Islands (Vanuatu) in the early 2000s was driven by a combination of sea level rise and tectonic subsidence (Ballu et al. 2011). Residents on the Cook Islands have reported increased sediment transport, rougher ocean conditions, stronger ocean currents, and shorter low tide durations, which seem to be impacting the productivity of fisheries (Rongo and Dyer 2014). Water security of islands reliant on thin freshwater lenses may be particularly vulnerable to sea level rise, although these lenses have been shown to rise with sea level in places where the geology is favourable (Nurse et al. 2014).

Global sea level rise has been attributed to loss of ice sheets, melting glaciers, and ocean thermal expansion with unsustainable groundwater pumping also causing localized exacerbation (Cazenave and Llovel 2010). Prior to the industrial revolution, sea levels were relatively stable for millennia (Cazenave and Llovel 2010). However, in recent decades, they have been rising at an increasing rate, reaching approximately 3.7 mm/year between 2006 and 2018 (IPCC 2021). The rate in the Pacific has been much higher, with a rise of around 12 mm/year observed in the tropical western Pacific between 1993 and 2009 (Nurse et al. 2014). This faster rate is associated with ENSO shifts that can drive variations of 20–30 cm, meaning that it does not reflect

the expected long-term trend (Becker et al. 2012), but natural variation is expected to be overwhelmed by warming-induced sea level rise in the future (IPCC 2021). The recent combination of natural and warming-induced sea level rise has already led to dramatic consequences. For example, salinization of water sources and soils caused significant human migration from some outer islands of Tuvalu to the main island, which now supports over 6000 people within a 2.8 km² land area (Becker et al. 2012). Widespread inundation by extreme waves across Papua New Guinea and the Solomon Islands in 2008 was exacerbated by concurrent high sea levels (Hoeke et al. 2013).

Future sea level rise depends heavily on the emissions trajectory, highlighting the importance of global coordination in urgently cutting global greenhouse gas releases to prevent the worst impacts on PICT communities. By 2100, a high emissions scenario will likely drive global sea level rise of 0.63 to 1.02 m, while a low emissions scenario would probably limit the rise to between 0.28 and 0.55 m (IPCC 2021). Sea level rise projections for high emissions scenarios are uncertain beyond 2100 due to the impact of ice-sheet responses to warming, and it is possible that sea levels could rise up to 5 m by 2150 (IPCC 2021). Average and extreme sea levels are expected to rise variably across the world due to gravitational effects between ice sheets and ocean waters, differing wind dynamics, and shifts in wave climate (Walsh et al. 2012). Models project that differential warming patterns will strengthen the south-easterly trade winds while the trade winds closer to the equator weaken; this could drive slightly faster sea level rise around Vanuatu, New Caledonia, and Fiji, but slower sea level rise around Tuvalu, Kiribati, the Cook Islands, and the Solomon Islands, compared to the global average (Timmermann et al. 2010; Walsh et al. 2012).

Sea level rise clearly presents a threat to communities in the Pacific, especially on small islands and low-lying atolls (Mimura 1999) and in coastal areas vulnerable to storm surge (IPCC 2021). However, there are examples of communities and natural resources showing remarkable resilience. Rapid sea level rise around Tuvalu has coincided with many islands (counterintuitively) becoming larger, likely due to wave and sediment supply processes (Kench et al. 2015). As the ocean continues to rise, it is likely that small sand islands in Tuvalu will shrink but medium and larger islands may continue to expand (Kench et al. 2018). Similar variability in how islands respond to sea level rise has been found in French Polynesia and the Marshall Islands (Nurse et al. 2014). This highlights that islands are not static and, if global greenhouse gas emissions are appropriately reduced, island abandonment may be avoidable even for seemingly vulnerable low-lying atolls (Barnett 2017). Preserving and restoring natural barriers to erosion, including mangroves and coral reefs, will help to maintain islands in the face of sea level rise (Mimura 1999).

5.3.6 *Ocean Acidification*

Around 30–40% of anthropogenic carbon dioxide emissions over the last century have been absorbed by the oceans, leading to chemical changes that have increased

acidity (Lebrec et al. 2019; Wei et al. 2009). This has negative implications for marine environments, especially coral reefs that are critical for fisheries, tourism, shoreline protection, and biodiversity in the tropical Pacific (Shaw et al. 2015; Doney et al. 2009). For example, tourism generates 40% of employment in Palau, and 86% of tourists visit to see coral reefs (Lebrec et al. 2019). Long-term reef monitoring on Rarotonga (Cook Islands) indicates that reef recovery after bleaching is becoming slower (Rongo and Dyer 2014). On Manihiki (Cook Islands), pearl farmers report that oyster shells are becoming thinner and they have noticed increasing pearl deformities (Rongo and Dyer 2014).

Ocean acidity is measured using pH, a logarithmic scale that decreases with increasing acidity. As pH declines, the concentration of calcium carbonate (CaCO_3) in seawater also declines. CaCO_3 may take the form of calcite or aragonite—both minerals are important for calcifying organisms such as corals and some krill (Albright et al. 2010; De'ath et al. 2009). CaCO_3 is most abundant in shallow, tropical marine environments, so the worst effects of ocean acidification are likely to be felt in the higher latitudes first (Orr et al. 2005) and not in the equatorial Pacific. Lebrec et al. (2019) found that large-scale coral damage due to acidification has not yet been observed in the Marshall Islands, Palau, or American Samoa. In fact, some reefs in the tropical Pacific are adapted to unusually high and/or variable acidity; Nikko Bay in Palau has pH levels similar to those expected globally in 2100 but maintains high coral diversity. However, the impacts of higher marine water temperatures will be felt strongly in the tropics (see Sect. 5.3.4) and acidification may make corals more vulnerable to temperature-driven bleaching (Anthony et al. 2008). De'ath et al. (2009) attributed a 14% decline in calcification across 69 reefs in the Australian Great Barrier Reef to a combination of temperature stress and declining aragonite concentrations.

Recent changes in ocean acidity are uncertain due to a lack of direct long-term measurements (Shinjo et al. 2013; Wei et al. 2009). Bates et al. (2014) analysed datasets 15–30 years in length from seven stations around the world, including one off the east coast of New Zealand. They found statistically significant declines in ocean pH across the sites, but the rate of change varied between locations. Shinjo et al. (2013) used coral isotopes sourced from Guam to create a proxy for pH in the West Pacific Warm Pool, noting a declining trend of 0.05–0.08 pH units over 60 years. Another coral isotope study in the southwestern Pacific pointed to large natural variation in pH over 300 years connected to the IPO (Pelejero et al. 2005), suggesting that marine ecosystems could actually be quite robust to changing pH, but this remains an area of contention (Matear and McNeil 2006; Pelejero et al. 2006). Wei et al. (2009) used a similar method to infer ocean acidity in the central Australian Great Barrier Reef over 200 years. They also found substantial natural pH variability connected to large-scale Pacific climate drivers, but rapid oscillations in pH detected around 1998 coincided with a major bleaching event in the Great Barrier Reef (Wei et al. 2009). This indicates that large or quick changes in pH may overwhelm an ecosystem's capacity to adapt. The current rate of acidification is believed to be unprecedented within the last 300 million years (Lebrec et al. 2019), and compound

stressors like overfishing, rising temperatures, and polluted terrestrial runoff may further amplify the negative impacts of acidification (Halpern et al. 2015, 2019).

As atmospheric carbon dioxide levels rise over the coming decades, oceans are expected to acidify further, and this would greatly impact food security in the Pacific. If emissions continue unabated, surface ocean acidity will be 150% higher than pre-industrial levels by 2100 (Lebréc et al. 2019; Orr et al. 2005). Kleypas et al. (1999) suggest a related decrease in aragonite saturation of 30% by 2050, with serious implications for marine ecosystems. Eyre et al. (2018) project that reef sediments will experience faster dissolution than calcification globally, and therefore become net dissolving, from around 2050. Coral breeding could also be impacted by acidification via reduced fertilization and settlement success (Albright et al. 2010). Impacts are likely to vary across locations depending on the rate of acidification and other compounding stressors, as well as the natural variability to which different organisms have been exposed (Shaw et al. 2015; Anthony et al. 2008).

5.4 Conclusions and Outlook

Communities in the Pacific are on the climate change frontline, already experiencing enhanced temperature extremes, rising sea levels, and effects of ocean acidification. They face an uncertain future that will likely include heavier extreme rainfall and possibly more intense tropical cyclones. Some countries may also be at greater risk of drought in upcoming decades. Small island nations are particularly vulnerable to climate change due to their limited natural resources and space. Lack of financial resources may also limit their capacity to respond with engineering adaptation approaches such as infrastructure upgrades. Large countries and high emitters clearly have a responsibility to reduce greenhouse gas releases (ultimately to net zero) to prevent the worst impacts on island communities. The global food and energy sectors, which provide vital services but also generate emissions, have an important role to play.

As an anthropogenically affected climate becomes the ‘new normal’, nations and communities in the Pacific will need to adapt. However, adaptation efforts are hampered by especially large uncertainties around future climate due to known deficiencies in climate model simulations of the region. The common approach of trying to foresee and pre-emptively mitigate against climate change impacts could lead to wasted resources in the Pacific if projections turn out to be unreliable (Barnett 2001). Instead, a flexible approach should be considered in which grassroots initiatives are gradually scaled up and adjusted as information becomes available. PICT communities have adapted over generations to high year-to-year climate variability (Barnett 2001) and have built a wealth of valuable traditional knowledge (Mael 2013; Rongo and Dyer 2014), as discussed further in Chap. 11. This can be leveraged for understanding and adapting to climate change by placing local communities at the centre of future planning efforts. Recent research has highlighted that adaptation to high climate variability increases resilience to climate change (Nathan et al. 2019),

so programs that fortify communities under current variability will also have future benefits. However, transfer of vital traditional knowledge is being interrupted by a shift towards more westernized lifestyles and targeted data collection must ensure that centuries of learnings are not lost (Rongo and Dyer 2014). Climate change awareness programs may help people place their knowledge in the context of adaptation; in a survey conducted by Rongo and Dyer (2014) in the Cook Islands, over 90% of respondents saw a need for such programs. While climate change undoubtedly threatens PICTs and their water, energy, and food security, urgent emissions reduction combined with context-specific adaptation programs can secure a positive future for local societies and the environment. Well-resourced countries with high historical carbon emissions should play a constructive role in supporting more vulnerable countries, particularly within their own region.

References

- Albright R, Mason B, Miller M, Langdon C (2010) Ocean acidification compromises recruitment success of the threatened Caribbean coral *Acropora palmata*. *Proc Natl Acad Sci USA* 107:20400
- Anthony KRN, Kline DI, Diaz-Pulido G, Dove S, Hoegh-Guldberg O (2008) Ocean acidification causes bleaching and productivity loss in coral reef builders. *Proc Natl Acad Sci USA* 105:17442
- Australian Bureau of Meteorology and CSIRO (2011) Climate change in the Pacific: scientific assessment and new research. Volume 1: regional overview. Australian Bureau of Meteorology and Commonwealth Scientific and Industrial Research Organisation
- Australian Bureau of Meteorology and CSIRO (2014) Climate variability, extremes and change in the western tropical pacific: new science and updated country reports. Pacific-Australia Climate Change Science and Adaptation Planning Program Technical Report. Australian Bureau of Meteorology and Commonwealth Scientific and Industrial Research Organisation, Melbourne
- Ballu V, Bouin M-N, Siméoni P, Crawford WC, Calmant S, Boré J-M et al (2011) Comparing the role of absolute sea-level rise and vertical tectonic motions in coastal flooding, Torres Islands (Vanuatu). *Proc Natl Acad Sci USA* 108:13019
- Barkey B, Bailey R (2017) Estimating the impact of drought on groundwater resources of the Marshall Islands. *Water* 9:41
- Barnett J (2001) Adapting to climate change in Pacific Island countries: the problem of uncertainty. *World Dev* 29:977–993
- Barnett J (2017) The dilemmas of normalising losses from climate change: towards hope for Pacific atoll countries. *Asia Pac Viewp* 58(1):3–13
- Bates NR, Astor YM, Church MJ, Currie KIM, Dore JE, González-Dávila M et al (2014) A time-series view of changing surface ocean chemistry due to ocean uptake of anthropogenic CO₂ and ocean acidification. *Oceanography* 27:126–141
- Becker M, Meyssignac B, Letetrel C, Llovel W, Cazenave A, Delcroix T (2012) Sea level variations at tropical Pacific islands since 1950. *Global Planet Change* 80–81:85–98
- Brown JN, Brown JR, Langlais C, Colman R, Risbey JS, Murphy BF et al (2013a) Exploring qualitative regional climate projections: a case study for Nauru. *Clim Res* 58:165–182
- Brown JR, Moise AF, Colman RA (2013b) The South Pacific Convergence Zone in CMIP5 simulations of historical and future climate. *Clim Dyn* 41:2179–2197
- Byrne MP, O’Gorman PA (2013) Land–ocean warming contrast over a wide range of climates: convective quasi-equilibrium theory and idealized simulations. *J Clim* 26:4000–4016
- Byrne MP, Schneider T (2016) Narrowing of the ITCZ in a warming climate: physical mechanisms. *Geophys Res Lett* 43(21): 11350–11357

- Byrne MP, Pendergrass AG, Rapp AD, Wodzicki KR (2018) Response of the Intertropical Convergence Zone to climate change: location, width, and strength. *Curr Clim Change Rep* 4:355–370
- Cai W, Van Rensch P, Cowan T, Hendon HH (2011) Teleconnection pathways of ENSO and the IOD and the mechanisms for impacts on Australian rainfall. *J Clim* 24:3910–3923
- Cai W, Lengaigne M, Borlace S, Collins M, Cowan T, McPhaden et al (2012) More extreme swings of the South Pacific convergence zone due to greenhouse warming. *Nature* 488: 65–369
- Cao X, Huang P, Chen G, Chen W (2012) Modulation of western North Pacific tropical cyclone genesis by intraseasonal oscillation of the ITCZ: a statistical analysis. *Adv Atmos Sci* 29:744–754
- Capotondi A, Wittenberg AT, Newman M, Di Lorenzo E, Yu J-Y, Braconnot P et al (2015) Understanding ENSO diversity. *Bull Am Meteorol Soc* 96:921–938
- Cazenave A, Llovel W (2010) Contemporary sea level rise. *Ann Rev Mar Sci* 2:145–173
- Chiew FH, Potter NJ, Vaze J, Petheram C, Zhang L, Teng J, Post DA (2014) Observed hydrologic non-stationarity in far south-eastern Australia: implications for modelling and prediction. *Stoch Environ Res Risk Assess* 28:3–15
- CSIRO, Australian Bureau of Meteorology and SPREP (2015) Climate in the Pacific: a regional summary of new science and management tools, Pacific-Australia Climate Change Science and Adaptation Planning Program Summary Report. CSIRO, Melbourne
- CSIRO and BOM (2015) Climate change in Australia, Projections for Australia's NRM regions. Australia
- De' Ath G, Lough JM, Fabricius KE (2009) Declining coral calcification on the Great Barrier Reef. *Science* 323:116
- Delworth TL, Zeng F (2014) Regional rainfall decline in Australia attributed to anthropogenic greenhouse gases and ozone levels. *Nat Geosci* 7:583–587
- Deo RC (2011) On meteorological droughts in tropical Pacific Islands: time-series analysis of observed rainfall using Fiji as a case study. *Meteorol Appl* 18:171–180
- Deo A, Ganer D, Nair G (2011) Tropical cyclone activity in global warming scenario. *Nat Haz* 59:771–786
- Diamond HJ, Lorrey AM, Renwick JA (2013) A Southwest Pacific Tropical cyclone climatology and linkages to the El Niño–southern oscillation. *J Clim* 26:3–25
- Doney SC, Fabry VJ, Feely RA, Kleypas JA (2009) Ocean acidification: the other CO₂ problem. *Ann Rev Mar Sci* 1:169–192
- England MH, McGregor S, Spence P, Meehl GA, Timmermann A, Cai W et al (2014) Recent intensification of wind-driven circulation in the Pacific and the ongoing warming hiatus. *Nat Clim Change* 4:222–227
- Evans JP, Bormann K, Katzfey J, Dean S, Arritt R (2016) Regional climate model projections of the South Pacific Convergence Zone. *Clim Dyn* 47:817–829
- Eyre BD, Cyronak T, Drupp P, De Carlo EH, Sachs JP, Andersson AJ (2018) Coral reefs will transition to net dissolving before end of century. *Science* 359:908
- Folland CK, Renwick JA, Salinger MJ, Mullan AB (2002) Relative influences of the Interdecadal Pacific Oscillation and ENSO on the South Pacific Convergence Zone. *Geophys Res Lett* 29:(13)21-1–21-4
- Frölicher TL, Fischer EM, Gruber N (2018) Marine heatwaves under global warming. *Nature* 560: 360–364
- Grose MR, Bhend J, Narsey S, Gupta AS, Brown JR (2014) Can we constrain CMIP5 rainfall projections in the tropical Pacific based on surface warming patterns? *J Clim* 27:9123–9138
- Grose MR, Moise AF, Timbal B, Katzfey JJ, Ekström M, Whetton PH (2015) Climate projections for southern Australian cool-season rainfall insights from a downscaling comparison. *Clim Res* 62:251–265
- Halpern BS, Frazier M, Potapenko J, Casey KS, Koenig K, Longo C et al (2015) Spatial and temporal changes in cumulative human impacts on the world's ocean. *Nat Commun* 6:7615
- Halpern BS, Frazier M, Afferbach J, Lowndes JS, Micheli F, O'Hara C et al (2019) Recent pace of change in human impact on the world's ocean. *Sci Rep* 9:11609

- Hoeke RK, McInnes KL, Kruger JC, McNaught RJ, Hunter JR, Smithers SG (2013) Widespread inundation of Pacific islands triggered by distant-source wind-waves. *Glob Planet Change* 108:128–138
- Hughes TP, Anderson KD, Connolly SR, Heron SF, Kerry JT, Lough JM et al (2018) Spatial and temporal patterns of mass bleaching of corals in the Anthropocene. *Science* 359:80
- IPCC (2013) Climate change 2013: the physical science basis. Contribution of Working Group I to the Fifth Assessment Report of the Intergovernmental Panel on Climate Change, Cambridge University Press, Cambridge
- IPCC (2021) Climate change 2021: the physical science basis. Contribution of Working Group I to the Sixth Assessment Report of the Intergovernmental Panel on Climate Change. In: Masson-Delmotte V, Zhai P, Pirani A, Connors SL, Péan C, Berger S et al (eds) Cambridge University Press, Cambridge
- Johnson NC, Xie S-P (2010) Changes in the sea surface temperature threshold for tropical convection. *Nat Geosci* 3:842–845
- Keener VW, Hamilton K, Izuka SK, Kunkel KE, Stevens LE, Sun L (2013) Regional climate trends and scenarios for the US national climate assessment, Part 8. Climate of the Pacific Islands. NOAA Technical Reports. US Department of Commerce, Washington, DC
- Kench PS, Thompson D, Ford MR, Ogawa H, Mclean RF (2015) Coral islands defy sea-level rise over the past century: records from a central Pacific atoll. *Geology* 43:515–518
- Kench PS, Ford MR, Owen SD (2018) Patterns of island change and persistence offer alternate adaptation pathways for atoll nations. *Nat Commun* 9:605
- Kuleshov Y, Qi L, Fawcett R, Jones D (2008) On tropical cyclone activity in the Southern Hemisphere: trends and the ENSO connection. *Geophys Res Lett* 35
- Kleypas JA, Buddemeier RW, Archer D, Gattuso J-P, Langdon C, Opdyke BN (1999) Geochemical consequences of increased atmospheric carbon dioxide on coral reefs. *Science* 284:118–120
- Knutson TR, Sirutis JJ, Zhao M, Tuleya RE, Bender M, Vecchi GA et al (2015) Global projections of intense tropical cyclone activity for the late twenty-first century from dynamical downscaling of CMIP5/RCP4.5 scenarios. *J Clim* 28:7203–7224
- Kuleshov Y, Fawcett R, Qi L, Trewin B, Jones D, McBride J, Ramsay H (2010) Trends in tropical cyclones in the South Indian Ocean and the South Pacific Ocean. *J Geophys Res Atmos* 115
- Kuleshov Y, McGree S, Jones D, Charles A, Cottrill A, Prakash B et al (2014) Extreme weather and climate events and their impacts on island countries in the Western Pacific: cyclones, floods and droughts. *Atmos Clim Sci* 4:803–818
- Landsea CW, Harper BA, Hoarau K, Knaff JA (2006) Can we detect trends in extreme tropical cyclones? *Science* 313:452–454
- Lebrech M, Stefanski S, Gates R, Acar S, Golbuu Y, Claudel-Rusin A et al (2019) Ocean acidification impacts in select Pacific Basin coral reef ecosystems. *Reg Stud Mar Sci* 28:100584
- Lee T, Mcphaden MJ (2010) Increasing intensity of El Niño in the central-equatorial Pacific. *Geophys Res Lett* 37
- Lehodey P, Senina I, Calmettes B, Hampton J, Nicol S (2013) Modelling the impact of climate change on Pacific skipjack tuna population and fisheries. *Clim Change* 119:95–109
- Ludert A, Wang B, Merrifield MA (2018) Characterization of dry conditions across the US-affiliated Pacific Islands during near-neutral ENSO phases. *J Clim* 31:6461–6480
- Mael SH (2013) Climate change and agriculture in Vanuatu: a study of crops and farming system. Food and Agriculture Organization of the United Nations, Subregional Office for the Pacific Islands
- Magee AD, Lorrey AM, Kiem AS, Colyvas K (2020) A new island-scale tropical cyclone outlook for southwest Pacific nations and territories. *Sci Rep* 10:11286
- Mann ME, Steinman BA, Miller SK (2020) Absence of internal multidecadal and interdecadal oscillations in climate model simulations. *Nat Commun* 11:49
- Matear RJ, McNeil BI (2006) Comment on ‘preindustrial to modern interdecadal variability in coral reef pH’. *Science* 314:595

- Matthews AJ (2012) A multiscale framework for the origin and variability of the South Pacific Convergence Zone. *QJR Meteorol Soc* 138:1165–1178
- McAnaney J, van den Honert R, Yeo S (2017) Stationarity of major flood frequencies and heights on the Ba River, Fiji, over a 122-year record. *Int J Climatol* 37:171–178
- McGree S, Whan K, Jones D, Alexander LV, Imielska A, Diamond H et al (2014) An updated assessment of trends and variability in total and extreme rainfall in the western Pacific. *Int J Climatol* 34:2775–2791
- McGree S, Schreider S, Kuleshov Y (2016) Trends and variability in droughts in the Pacific Islands and Northeast Australia. *J Clim* 29:8377–8397
- Meehl GA, Tebaldi C (2004) More intense, more frequent, and longer lasting heat waves in the 21st century. *Science* 305:994
- Mimura N (1999) Vulnerability of island countries in the South Pacific to sea level rise and climate change. *Clim Res* 12:137–143
- Nathan RJ, McMahon TA, Peel MC, Horne A (2019) Assessing the degree of hydrologic stress due to climate change. *Clim Change* 156:87–104
- Newman M, Alexander MA, Ault TR, Cobb KM, Deser C, Di Lorenzo E et al (2016) The Pacific decadal oscillation, revisited. *J Clim* 29:4399–4427
- Nurse LA, McLean RF, Agard J, Briguglio LP, Duvat-Magnan V, Pelesikoti N et al (2014) Small islands. In: Arros VR, Field CB, Dokken DJ, Mastrandrea MD, Mach KJ, Bilir TE et al (eds) *Climate change 2014: impacts, adaptation, and vulnerability. Part B: regional aspects. Contribution of Working Group II to the Fifth Assessment Report of the Intergovernmental Panel on Climate Change*. Cambridge University Press, Cambridge
- OCHA (2003) Fiji—Cyclone Ami OCHA Situation Report No. 5. UN Office for the Coordination of Humanitarian Affairs
- Oliver ECJ (2019) Mean warming not variability drives marine heatwave trends. *Clim Dyn* 53:653–1659
- Oliver ECJ, Donat MG, Burrows MT, Moore PJ, Smale DA, Alexander LV et al (2018) Longer and more frequent marine heatwaves over the past century. *Nat Commun* 9:1324
- Oliver ECJ, Burrows MT, Donat MG, Sen Gupta A, Alexander LV, Perkins-Kirkpatrick SE et al (2019) Projected marine heatwaves in the 21st century and the potential for ecological impact. 6
- Orr JC, Fabry VJ, Aumont O, Bopp L, Doney SC, Feely RA et al (2005) Anthropogenic ocean acidification over the twenty-first century and its impact on calcifying organisms. *Nature* 437:681–686
- Peduzzi P, Chatenoux B, Dao H, De Bono A, Herold C, Kossin J et al (2012) Global trends in tropical cyclone risk. *Nat Clim Change* 2:289–294
- Pelejero C, Calvo E, McCulloch MT, Marshall JF, Gagan MK, Lough JM et al (2005) Preindustrial to modern interdecadal variability in coral reef pH. *Science* 309:2204
- Pelejero C, Calvo E, McCulloch MT, Marshall JF, Gagan MK, Lough JM et al (2006) Response to comment on ‘preindustrial to modern interdecadal variability in coral reef pH’. *Science* 314:595
- Popp M, Bony S (2019) Stronger zonal convective clustering associated with a wider tropical rain belt. *Nat Commun* 10:4261
- Power SB, Delage FPD, Chung CTY, Ye H, Murphy BF (2017) Humans have already increased the risk of major disruptions to Pacific rainfall. *Nat Commun* 8:14368–14368
- Rojo Hernández JD, Mesa ÓJ, Lall U (2020) ENSO dynamics, trends and prediction using machine learning. *Weather Forecast* July:2061–2081
- Rongo T, Dyer C (2014) Using local knowledge to understand climate variability in the Cook Islands. Government of the Cook Islands
- Salinger MJ, Renwick JA, Mullan AB (2001) Interdecadal Pacific oscillation and South Pacific climate. *Int J Climatol* 21:1705–1721
- Samanta D, Karnauskas KB, Goodkin NF (2019) Tropical Pacific SST and ITCZ biases in climate models: double trouble for future rainfall projections? *Geophys Res Lett* 46:2242–2252

- Saunders DA, Mawson P, Dawson R (2011) The impact of two extreme weather events and other causes of death on Carnaby's Black Cockatoo: a promise of things to come for a threatened species? *Pac Conserv Biol* 17:141–148
- Shaw EC, Phinn SR, Tilbrook B, Steven A (2015) Natural in situ relationships suggest coral reef calcium carbonate production will decline with ocean acidification. *Limnol Oceanog* 60:777–788
- Shinjo R, Asami R, Huang K-F, You C-F, Iryu Y (2013) Ocean acidification trend in the tropical North Pacific since the mid-20th century reconstructed from a coral archive. *Mar Geol* 342:58–64
- Smale DA, Wernberg T, Oliver ECJ, Thomsen M, Harvey BP, Straub SC et al (2019) Marine heatwaves threaten global biodiversity and the provision of ecosystem services. *Nat Clim Change* 9:306–312
- Stanfield RE, Jiang JH, Dong X, Xi B, Su H, Donner L et al (2016) A quantitative assessment of precipitation associated with the ITCZ in the CMIP5 GCM simulations. *Clim Dyn* 47:1863–1880
- Stephens CM, McVicar TR, Johnson FM, Marshall LA (2018) Revisiting pan evaporation trends in Australia a decade on. *Geophys Res Lett* 45:11164–11172
- Storey D, Hunter S (2010) Kiribati: an environmental 'perfect storm'. *Austr Geog* 41:167–181
- Terry JP, Wotling G (2011) Rain-shadow hydrology: influences on river flows and flood magnitudes across the central massif divide of La Grande Terre Island, New Caledonia. *J Hydrol* 404:77–86
- Terry JP, McGree S, Raj R (2004) The exceptional flooding on Vanua Levu Island, Fiji, during Tropical Cyclone Ami in January 2003. *J Nat Disaster Sci* 26:27–36
- Timmermann A, McGregor S, Jin F-F (2010) Wind effects on past and future regional sea level trends in the Southern Indo-Pacific. *J Clim* 23:4429–4437
- Vincent EM, Lengaigne M, Menkes CE, Jourdain NC, Marchesiello P, Madec G (2011) Interannual variability of the South Pacific Convergence Zone and implications for tropical cyclone genesis. *Clim Dyn* 36:1881–1896
- Walsh KJE, McInnes KL, McBride JL (2012) Climate change impacts on tropical cyclones and extreme sea levels in the South Pacific—a regional assessment. *Glob Planet Change* 80–81:149–164
- Wang B, Luo X, Yang Y-M, Sun W, Cane MA, Cai W et al (2019) Historical change of El Niño properties sheds light on future changes of extreme El Niño. *Proc Natl Acad Sci USA* 116:22512
- Wasko C, Nathan R (2019) Influence of changes in rainfall and soil moisture on trends in flooding. *J Hydrol* 575:432–441
- Webster PJ, Holland GJ, Curry JA, Chang HR (2005) Changes in tropical cyclone number, duration, and intensity in a warming environment. *Science* 309:1844–1846
- Wei G, McCulloch MT, Mortimer G, Deng W, Xie L (2009) Evidence for ocean acidification in the Great Barrier Reef of Australia. *Geochim Cosmochim A* 73:2332–2346
- Welbergen JA, Klose SM, Markus N, Eby P (2008) Climate change and the effects of temperature extremes on Australian flying-foxes. *Proc R Soc B: Biol Sci* 275:419–425
- Westra S, Fowler HJ, Evans JP, Alexander LV, Berg P, Johnson F et al (2014) Future changes to the intensity and frequency of short-duration extreme rainfall. *Rev Geophys* 52:522–555
- Widlansky MJ, Timmermann A, Stein K, McGregor S, Schneider N, England MH et al (2013) Changes in South Pacific rainfall bands in a warming climate. *Nat Clim Change* 3:417–423
- Wodzicki KR, Rapp AD (2016) Long-term characterization of the Pacific ITCZ using TRMM, GPCP, and ERA-Interim. *J Geophys Res Atmos* 121:3153–3170
- Wratt DS, Ridley RN, Sinclair MR, Larsen H, Thompson SM, Henderson R et al (1996) The New Zealand Southern Alps experiment. *Bull Amer Meteorol Soc* 77:683–692
- Ying J (2020) Summary and prospects. In: Ying J (ed) *Sources of uncertainty in the tropical Pacific warming pattern under global warming projected by coupled ocean-atmosphere models*. Springer, Singapore

The opinions expressed in this chapter are those of the author(s) and do not necessarily reflect the views of the UNESCO: United Nations Educational, Scientific and Cultural Organization, its Board of Directors, or the countries they represent.

Open Access This chapter is licensed under the terms of the Creative Commons Attribution-ShareAlike 3.0 IGO License (<https://creativecommons.org/licenses/by-sa/3.0/igo/>), which permits use, sharing, adaptation, distribution, and reproduction in any medium or format, as long as you give appropriate credit to the UNESCO: United Nations Educational, Scientific and Cultural Organization, provide a link to the Creative Commons licence and indicate if changes were made. If you remix, transform, or build upon this book or a part thereof, you must distribute your contributions under the same licence as the original.

The use of the UNESCO: United Nations Educational, Scientific and Cultural Organization's name, and the use of the UNESCO: United Nations Educational, Scientific and Cultural Organization's logo, shall be subject to a separate written licence agreement between the UNESCO: United Nations Educational, Scientific and Cultural Organization and the user and is not authorized as part of this CC-IGO licence. Note that the link provided above includes additional terms and conditions of the licence.

The images or other third party material in this chapter are included in the chapter's Creative Commons licence, unless indicated otherwise in a credit line to the material. If material is not included in the chapter's Creative Commons licence and your intended use is not permitted by statutory regulation or exceeds the permitted use, you will need to obtain permission directly from the copyright holder.



Chapter 6

The Water-Food Equation in the Pacific



Heidi K. Alleway and Wade L. Hadwen

Complexities that exist at the water-food nexus typify the challenge, and the opportunity, for the Pacific region in adapting to a future of change.

Abstract On land and in the sea clean water safeguards food and nutritional security in the Pacific, because it underpins functioning, productive food systems, and human health and wellbeing. Water, food, and communities in the region are intrinsically connected, which makes resolving ecological and socio-economic issues an inherently complex task. Yet, this connectivity, and the geographic diversity of Pacific nations, is also a strength. Nexus solutions can be effective in increasing the sustainability of resource use and the resilience of ecosystems and communities to climate change, as they enable a range of interconnected land and sea ecosystem issues to be considered across multiple spatial scales. They also support communities, governments, and industries to identify and navigate trade-offs in social and ecological objectives. This chapter explores challenges in the water-food equation and several nexus-focused strategies that could foster sustainability and the resilience of ecosystems, resources, and communities in the Pacific.

Keywords Water resources · WASH (water, sanitation, and hygiene) · Food production · Food systems · Climate resilience · Sustainability

H. K. Alleway (✉)

Provide Food and Water, The Nature Conservancy, Arlington, VA 22203, USA
e-mail: heidi.alleway@tnc.org

W. L. Hadwen

School of Environment and Science and Climate Action Beacon, Australian Rivers Institute, Griffith University, Brisbane, QLD 4111, Australia

© UNESCO 2024

A. Dansie et al. (eds.), *The Water, Energy, and Food Security Nexus in Asia and the Pacific*, Water Security in a New World,
https://doi.org/10.1007/978-3-031-25463-5_6

129

6.1 Introduction

The productivity and sustainability of water and food resources and the health of ecosystems are interconnected. Because of this interdependency, challenges in achieving sustainability that arise at the water-food nexus can be complex, and they can require multiple ecological, social, and economic needs to be met. In the Pacific, these challenges and complexities also solidify into a single significant test; without a secure supply of clean water, on land and at sea, food security as well as water security, cannot be achieved. Clean and secure freshwater and marine environments are central to the water needs and sanitation of Pacific communities, and they underpin the productivity, safety, and nutritional value of food. Without clean freshwater and sanitation (SDG 6) communities will experience ongoing impacts to health and well-being, and pressure on the supply of water for land-based food production will escalate due to population growth, competing demands for resources, and climate change. To conserve marine and coastal environments and achieve genuine ecologically sustainable development of resources (SDG 14) healthy ocean waters are essential.

Across the Pacific diverse environmental settings mean that access to sufficient quality and quantity of freshwater is highly variable (Chap. 2). For example, in atoll nations like Tuvalu, the Marshall Islands, and Kiribati, freshwater is in limited supply, and technological and traditional approaches to cope with water scarcity are required to sustain food production and human communities, particularly during dry spells and droughts (MacDonald et al. 2020). In contrast, in Melanesian countries like Papua New Guinea, Solomon Islands, Vanuatu, and Fiji, freshwater is abundant, but the quality of the resource, particularly during and in the aftermath of significant extreme weather events, represents a major threat to human health and the safety of food products (Chan et al. 2020). In all geographies coastal environments and resources make an important contribution to food, livelihood, and community well-being. But degradation of catchments and coastal water quality, brought about by poorly managed development, land-based pollution, and high levels of water consumption threaten these ecosystems and their productivity (Halpern et al. 2015). Human stressors such as eutrophication, overfishing, and pollution, including threats from plastic, light, sound, nutrients, and GHG emissions, are impacting marine and coastal habitats and species at an increasing rate, and climate change is exacerbating their effects (Halpern et al. 2019).

The biogeographic processes that shape geographies in the Pacific mean that many environments are well adapted and inherently resilient to natural disturbance—resilience that has evolved over millions of years—but poorly adapted and highly vulnerable to human-driven impacts (Keppel et al. 2014). Development that increasingly reflects western expectations for water and food systems, especially intensive, high output production systems, and the loss of Indigenous knowledge and practice (Chap. 11) is straining the natural coping capacity of these systems and human communities (Crook et al. 2015). This chapter explores challenges for Pacific nations in the water-food equation and several nexus-oriented strategies that target challenges in sustainable resource use, but could also provide an opportunity to leverage the

interconnected nature of water and food systems to deliver numerous ecological, social, and economic outcomes across many spatial scales.

6.2 Water-Food Systems: Their Importance and Their Challenges

While at a global level the drivers of impacts to the availability and quality of water may be common (e.g., water extraction for increased food production, physical effects of climate and natural hazards) they are unique in time and place throughout the Pacific, insofar as how and to what extent the effects are experienced at regional, national, and subnational levels. Pacific nations are exceptionally diverse, geographically, biologically, and culturally. This diversity is an important feature of adaptable and resilient environments (Keppel et al. 2014), but it also exposes the variability with which nations, particularly the Pacific Island Countries and Territories (PICTs), experience the effects of resource pressure and, increasingly, climate change. For example, the Marshall Islands experiences the effects of drought and sea level rise, both of which reduce the availability of freshwater (MacDonald et al. 2020), whereas flooding that occurs in the Solomon Islands each year generates an excess of freshwater, and most is unused because rainwater harvesting is not common practice (Chan et al. 2020). Such diversity of contexts requires consideration of issues that emerge from within water and food systems and the unique impacts they can have in each, and consideration of the effects they generate across these systems.

6.2.1 Water Systems

While water scarcity and lack of freshwater reserves is a growing problem in the central and eastern parts of the Pacific, many countries in the Western Pacific region suffer periods where monsoonal rainfall creates very different problems. Where freshwater is abundant, careful consideration of the sources of water and their potential contamination is needed, to ensure that communities use safe water for drinking and food production (Elliott et al. 2017; Chan et al. 2020). While interventions supporting the capture and austere use of rainwater, universally deemed to be the safest and highest quality source of water in most settings, are gaining significant support from government and non-governmental organizations (NGOs) (MacDonald et al. 2020), there remain cultural and biophysical constraints in many places that are limiting the success of such interventions (MacDonald et al. 2017; Chan et al. 2020).

Scientific knowledge of water resources remains scarce in many Pacific settings, such that the quantity and quality of freshwater available to a large number of communities remains unknown (see Chap. 2 for discussion on water resource security). An effective understanding of country-specific and community context remains a barrier

to supporting water-food security and achieving the SDGs, particularly as traditional knowledge and cycles of rainfall are no longer as reliable as they once were (Hadwen et al. 2015; Chan et al. 2020). Limited understanding of groundwater recharge and streamflow rates also represents a constraint in water resource planning in many locations, although in some places sufficient information via qualitative information, including anecdotes, government and NGO reports exists to understand if water is scarce across seasons or other time scales.

With year-to-year rainfall variability increasing, there will be growing uncertainty around predictions of rainfall and reliability of freshwater resources for Pacific peoples (Chap. 5). Already, this lack of predictability in rainfall cycles is having an impact on local food production in many countries. Anecdotal evidence suggests that the timing and magnitude of reliable rainfall events has been diminished, and many local people have spoken of failed taro crops and uncertainty around when to plant (Sahin et al. 2021). This erosion of reliability threatens the continuation of subsistence production systems that many Pacific Island peoples rely on for sustenance. Furthermore, changes in rainfall cycles could see an emergence or increase in other threats, such as bushfire events, increased vulnerability of crops, particularly banana and plantain, to fungal disease, and the additional pressure on water resources and infrastructure required for adequate response. Bushfires experienced throughout Australia in summer 2019/2020 and flooding in the summer of 2021/2022 make clear the extremity of the impacts of climate change; impacts that are projected to become more common in many places (IPCC 2019, 2022). Bushfires in the PICTs present a growing threat, and for water and food systems their impacts are numerous. The physical impacts to natural resources supporting primary production can be acute (e.g., loss of crops or stock and sustained effects on water resources through use of water during events), as can contamination of water sources which can impeded recovery. Additionally, heavy rainfall events after bushfires can lead to erosion in catchments and carry sediment to coastal areas. Sedimentation of critical coastal and marine habitats such as coral reefs can lead to further environmental impacts and rapidly and severely deteriorate marine food source systems. To adequately prepare for the increasing threats and effects of bushfires, similar approaches used to responded to address other natural hazards, such as cyclones, will be needed. But there will also be unique, differentiated needs for preparation that must not be overlooked, in particular, access to additional water supply, especially during times of higher bushfire risk, and rapid response to the ways in which supply will be destabilized and quality impacted.

While living with freshwater resources of limited quality or quantity represents a constraint for many people in the Pacific, there are also countless examples of Indigenous adaptations that help communities survive during periods of scarce supply. For example, in the Republic of the Marshall Islands, communities use seawater when cooking their fish (Elliott et al. 2017); this not only preserves the traditional Indigenous way of preparing food, but also preserves the limited available freshwater for drinking use only, which helps the community get through dry spells and droughts (MacDonald et al. 2020). Including Indigenous and customary practices and knowledge into the design of sustainability and climate change adaptation strategies will

ensure the ecological and social uniqueness of the Pacific region remains a strength, and increase the capacity for adaptation under a future of change (Sahin et al. 2021).

6.2.2 Food Systems

In the PICTs, changes in eating habits have resulted in poorer nutrition, the effects of which will be intensified by threats to food security via disruptions to supply chains from climate change. This includes direct impacts to food production, but also disruption to distribution networks and the economic capacity of households to access food (Barnett [2011], and see Chap. 4 for discussion on food and nutrition security). However, despite ubiquitous and sometimes high rates of food imports around 80% of people in the PICTs still draw on agriculture from small landholders to satisfy their daily food needs. Many households have small food producing gardens and these small holder farms play a pivotal role in the stability and quality of supply (Georgeou et al. 2022). Agriculture and seafood production (fishing and aquaculture) also provide the largest source of employment in the region, providing a societal basis for both economic and food security, especially economic security created by small-scale or subsistence fisheries which account for most of fisheries livelihood fisheries in the Asia–Pacific (Kittinger 2013). These dependencies underscore one of the most significant feedback loops that must be addressed in food production today. An estimated 70% of freshwater usage, 80% of habitat degradation, and 26% of total global greenhouse gas (GHG) emissions are associated with global food production (Poore and Nemecek 2018). In the absence of practical or technological advancements to address the environmental impacts of food systems, impacts to resources could increase by 50–90% in the coming years (Springmann et al. 2018). Under these circumstances food and nutritionally insecure nations could face the double jeopardy of needing to expand production to meet increasing demand while also incurring the impacts of increased production, through continued deterioration of water resources, land displacement, and biodiversity loss (Blanchard et al. 2017).

The island nature of the Pacific region lends itself to an important role for seafood, which forms an essential part of diets and cultural and economic livelihood. Oceania maintains the highest regional per capita consumption of seafood globally (an average 24.2 kg per capita), and the contribution of fish and fishery products to the supply of animal protein is more than 20% in a number of countries (FAO 2020). For several small island nations, such as Palau, the Cook Islands, Kiribati, and Tokelau, alternative forms of protein are not readily accessible and so consumption can also be synonymous with reliance.

Small-scale fisheries do and will continue to play a critical role in securing this consumption, even with the effects of climate change (Golden et al. 2021; Short et al. 2021). However, the current distribution of seafood production effort means this reliance is overwhelming directed toward fisheries, which exposes resources to overfishing and the challenge of meeting social objectives for food security at the same time as enabling economic opportunities, such as engaging with export

markets. While production of seafood from aquaculture and its contribution to human consumption has steadily increased since the 1960's at a global level, with the total global volume of production from this industry now equivalent to fisheries, at a regional level this same trajectory of growth has not occurred. Aquaculture production in Oceania is limited in comparison to other regions, with approximately 12–14% of total seafood production (fisheries and aquaculture combined) contributed by aquaculture and decadal growth occurring at a rate of just over 4% (FAO 2020). While the majority of the Pacific has suitable habitat for aquaculture production of marine species, and for a greater diversity of species than that currently produced (Oyinlola et al. 2018), this generally restricted scale of current activity suggests there are multiple technical, regulatory, and social challenges that need to be overcome to increase production from this industry. Whether a country practices aquaculture or not, and to what extent, is influenced by socio-economic factors, particularly the quality of governance and regulation, and development of this industry over time, underscoring the important role these factors will play in enabling sustainable growth into the future (Gentry et al. 2019; Ruff et al. 2020).

6.2.3 *Ecosystems and Economies*

Traditional ways of life in the Pacific are dependent on nature, and these cultural ties, as well as the physical dependence, are critical to wellbeing. For example, biodiversity is fundamental to healthy ecosystems, but it is also closely tied to important avenues for economic productivity, deepening the dependence of the Pacific on healthy and productive water-food ecosystems, and adding to the complexity of balancing multiple community and environmental needs. In particular, marine environments in the central Indo-Pacific have the highest species richness globally (Miller et al. 2018) and this unique biodiversity underpins the opportunities afforded through tourism. Across Asia and the Pacific, international tourist arrivals have steadily increased since 1950, and in 2018 the region received 24.43% of arrivals worldwide (Roser 2017). Yet, while of critical economic importance tourism is a significant creator of waste and the pressure generated through additional use of water resources can limit the availability and access to safe water resources for residents (Becken 2014; Dwyer 2018). Energy-intensive desalination plants (Chap. 8) often only serve international guests, with no direct water benefits for the local communities (Loehr et al. 2021). These interactions could constrain sustainable development of tourism and other industry, and further growth of economic capacity (Briassoulis 2002). As such, a more holistic and integrated approach is needed to ensure that growth and development in the tourism sector does not come at the cost of the local environment, people, or places (Briassoulis 2002; Loehr et al. 2021). As climate change places increasing stress on water resources, location-based or 'destination' approaches will need to be able to ensure the sustainability of tourism in climate-vulnerable nations (Hadwen et al. 2015; Loehr et al. 2021).

Similarly, food consumption by tourists can generate expectations for access to different foods than those produced in local systems and imbalances in food availability, which contributes to the high rates of food importation observed in some Pacific nations (Table 6.1). Food importation requires considerable infrastructure. Where trade networks lack infrastructure or the capacity to sustainably increase the supply of goods from domestic or international markets, there is a risk that attention and funding for maintenance, upgrades, or new initiatives will be diverted toward tourism-centric development and away from needs that best serve local communities. In the short term, the challenges of achieving local water and food security while restoring and increasing economic opportunities associated with food markets and tourism have been complicated by the impacts of the COVID-19 pandemic. The collapse of the tourism economy and reduced economic contributions from fisheries will create long-term debt for many nations (Béné 2020; Northrop et al. 2020) upping the challenge of meeting numerous, sometimes competing, ecological, social and economic demands.

Unfortunately, a comprehensive and harmonized picture of ecological and human-development risk in water-food systems across the Pacific is being compromised by a lack of available data for many PICTs. These data gaps limit the capacity for planning, and comparison of threats and impacts at successive scales to appropriately prioritize investment. For example, the 2019 Global Food Security Index reports rankings for the Pacific nations of Australia and New Zealand, but, despite being a high profile and widely used database, comparable data and scores for many PICTs are not available. This creates an imbalance and bias in the world view of resource vulnerability analyses. Data limitations for the Pacific region also limit down-scaled assessments of climate risk. For instance, Faivre et al. (2022) completed a hazard assessment in Port Resolution Bay, Vanuatu and found very limited data of sufficiently high resolution to model coastal processes effectively, leading to the risk of

Table 6.1 Proportion (%) of key trade processes (consumption by tourists, importation of products, and exportation of products) in 2017, associated with food production (including food, beverages and oils) in select Pacific nations (FAO 2019; Roser 2017)

Country ^a	International arrivals in 2016	Total food production (tonnes) in 2017	Tourist consumption (% of production)	Imports (% of production)	Exports (% of production)
Fiji	792,000	2,312,000	10.38	16.61	11.16
French Polynesia	192,000	230,000	17.83	68.26	3.91
Kiribati	NA	367,000	24.52	7.90	26.70
Samoa	134,000	293,000	19.11	23.89	6.14
Solomon Islands	23,200	1,059,000	17.19	11.71	15.49
Vanuatu	95,100	529,000	11.91	9.26	30.06

^aCountries included are those with available data for consumption of food and beverages by tourists

recommending maladapted approaches. In this example available wave data generated unrealistically high predictions of wave height within the bay, which if taken on face value would lead to a recommendation for extensive and expensive engineering adaptation for coastal protection despite these solutions being likely to fail to prevent ongoing cliff erosion, even under worst case scenarios associated with a Category 5 tropical cyclone. The most appropriate intervention identified by Faivre et al. (2022) was revegetation of clifftops to reduce erosion, a solution that may be lower in immediate and ongoing costs and come with numerous additional ecological and social co-benefits.

6.3 Fostering Sustainability and Resilience Through Water-Food Strategies

The Pacific region is physically, socially, and economically exposed to acute impacts and disruptions from climate change as well as systemic changes, such as sea level rise and species migration through changes in the suitability of habitat (IPCC [2019] and see Chap. 5 for climate change trends). Furthermore, climate change strains the connectivity between systems, displacing or accumulating pressure across ecosystems or communities. Changes in rainfall patterns present direct threats to water security because of the high dependency of many Pacific nations on rainfall due to limited availability of ground and surface water (Chap. 2). Changes in rainfall patterns will likely also impact the production of staple crops, which could exacerbate the burden of malnutrition that is already present in the region (Chap. 4). Such changes have direct impacts and equally problematic indirect impacts. For example, reduced freshwater inputs into catchments can reduce flows to coastal habitats that are necessary for the breeding of commercially or culturally significant freshwater and migratory marine fishes (Arthington et al. 2016). Engineering features designed to mitigate the impacts of increased variability in freshwater resource availability in response to climate change could, therefore, disrupt these natural processes (Crook et al. 2015). Strategies that therefore target the interdependencies between water and food systems will be especially effective in supporting climate adaptation and resilience. Their efficacy is reliant on working across ecosystems, spatial scales, and human dimensions, and the interdependencies become an opportunity to leverage improvements in both systems, their interdependencies, and diversity, which is critical to environmental health and community wellbeing (Fig. 6.1). Below we discuss three strategies that may be especially valuable examples of a nexus approach to water and food sustainability in the Pacific region. We identify some key considerations for each that all actors could take in furthering these approaches.

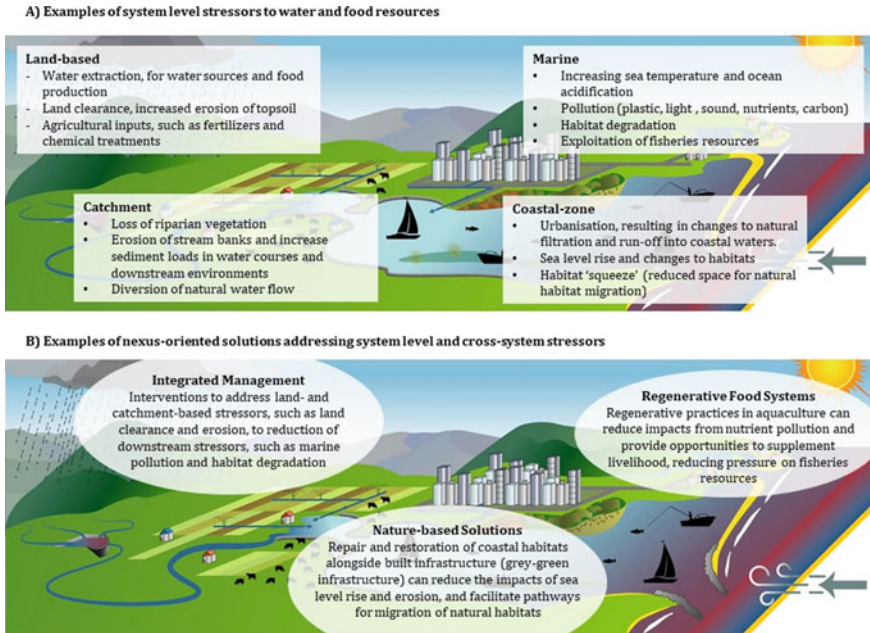

Fig. 6.1 Water-food nexus strategies provide an opportunity to address threats within and across systems (A), through sustainability strategies that work across multiple ecosystems, spatial scales, and human dimensions (B). Figure adapted with permission from A. Blacka and the Water Research Laboratory, University of New South Wales

6.3.1 Integrated Planning and Management

Integrated Management (IM) of resource use and sustainable development is now a generally well-known and promoted approach; and it remains one of the most important ways to achieve effective and equitable outcomes at the water-food nexus. IM can assist to make decisions that require balancing multiple objectives in sustainability, or the need for trade-offs, providing a foundation for transparent governance and decision-making. The importance of this approach is reflected in its explicit inclusion in the SDG’s and their targets, including SDG 6: Clean Water and Sanitation, which identifies “Target 6.5: By 2030, implement integrated water resources management at all levels, including through transboundary cooperation as appropriate”. Integrated Landscape Management (ILM) is the management of production systems and natural resources in an area large enough to produce vital ecosystem services, and small enough to be managed by the people using the land and producing those services (FAO 2017). This definition is extended to catchment and marine applications. In coastal areas, Integrated Coastal Zone Management (ICZM) can play an important role in managing human use of this highly dynamic space, and changing expectations for use of these common property areas and resources.

The value of integrated management, in all its forms, is the focus it adds to planning at the landscape or seascape scale, which drives recognition of the myriad habitats, species, and functions that form an ecosystem and the intent and impact (positive and negative) of a community's interactions with them. An integrated approach also enables challenges such as poverty and food security to be considered alongside efforts to protect or restore environments. Yet, IM has proven difficult to implement, in part because sufficient investment has not been directed toward the capacity needed to monitor and evaluate its efficacy and make adaptations (in the approach), and because it is linked to legislation and jurisdictional cross boundary policy (e.g., catchment management), which requires sustained political will and support from government. Even in areas where IM constitutes a guiding principle for legislation it has had mixed success. Notably, despite having the regulatory and management capacity to implement ICZM, its application in Australia is varied and its results uncertain. This has contributed to the lack of progress made in addressing ongoing declines in globally critical habitats, such as coral reefs and biodiversity (Clark and Johnston 2017). Disconnect in the practices applied in coastal areas and an imbalance between responsibilities and effective resourcing has also meant that complex but increasingly urgent issues, such as sea level rise, are not yet being meaningfully addressed.

The island nature of the PICTs creates the added challenge of realizing integrated management in areas physically disconnected but intrinsically linked, be these linkages in ecosystems, species, or socio-economic and cultural connections. Integrated Island Management (IIM) has been put forward as an approach to this complexity (Jupiter et al. 2014). This work identified ten principles that provide a valuable framework to advance IIM throughout the Pacific:

1. Adopt a long-term, integrated approach to ecosystem management.
2. Use clearly defined boundaries for ecological and governance systems.
3. Maintain and restore connectivity between complex social and ecological systems.
4. Incorporate stakeholders through participatory governance with collective choice arrangements that consider gender and social equity outcomes.
5. Ensure that management rules reflect stakeholder values and conditions.
6. Ensure recognition of rights to organize and develop management rules.
7. Develop appropriate sanctions for users who violate rules.
8. Identify appropriate, efficient, and cost-effective conflict resolution mechanisms.
9. Implement adaptive management where regular monitoring, evaluation, and review in the face of uncertainty lead to evidence-based decision-making.
10. Nest management layers across sectors, social systems, and habitats.

Importantly, the inclusion of Indigenous knowledge and customary practices in sustainability and climate change adaptations (Chap. 11) can inform the design of more effective solutions, in addition to having a positive effect on individual and community wellbeing (Sahin et al. 2021). Indigenous knowledge is not, however, currently well-included in integrated approaches, and practical, 'on the ground'

examples of Indigenous-led or informed strategies are rare (see Nalau et al. 2018 for a recent review of case studies). To implement IM effectively, the inclusion of Indigenous and customary knowledge and practices must be a priority, and actively pursued.

6.3.2 *‘Ridge to Reef’ Investment*

When implemented effectively IM can assist to more efficiently direct interventions and investment. ‘Ridge to Reef’ (Chap. 16) resourcing of sustainability and climate change adaptation strategies is built on an integrated approach but focuses especially on anthropogenic impacts from terrestrial areas, at the source, or top, of the watershed and their potential effects throughout the catchment and its waterways to the coast and ocean. Consequently, as well as enabling the source of problems to be identified a ridge to reef focus can facilitate a more accurate view of the cumulative nature of effects, such as the use agricultural fertilizers and runoff in addition to successive land uses and change (e.g., Carlson et al. 2019). For example, Delevaux and Stamoulis (2022) used spatial analysis of future forest management interventions to map where the greatest benefits of marine conservation in Vanuatu could be achieved. Priority areas for intervention in forests were clearly identified as those being upstream from coral reefs and seagrass in catchments, on the windward side of large high islands where tropical rainfalls were greater.

As well as having challenges common to the implementation of IM, a current barrier to a ridge to reef approach is the size of the ‘pool’ of funding that is currently available. Funding from global agencies and national jurisdictions provides a basis for solutions that are applied in catchments, but public funding is unlikely to generate an increase in investment or revenue that would lead to interventions being sustained over long periods of time, or scaled-up, because integrated approaches typically involve many stakeholders, each with their own changing interests (FAO and Earthscan 2011). Furthermore, funding of climate change adaptation and mitigation is currently well below what is required to effectively protect communities and ecosystems, particularly for strategies that can generate environmental as well as social outcomes. A recent assessment of major global climate funds found that while cumulative investment for climate change mitigation and adaptation projects was USD94 billion, only USD12 billion of this funding was being spent on Nature-based Solutions (NbS; UNEP 2021). Additional finance for adaptation is critically needed.

To supplement public funding, reform of financing and influencing the direction of investment from private entities is emerging as an important approach to build capital for NbS. For example, green bonds provide a financing option for private and public entities to support environmental investments by working to raise capital that explicitly supports environmental projects. The distinction of social values arising from the environmental value, often with links to climate change adaptation, arising from these investments differentiate them from traditional bonds (The World Bank 2015). From the first green bond in 2008 to the end of Jun 2015, the World Bank

issued USD8.5 billion in more than 100 green bond transactions, supporting 70 climate projects around the developing world (The World Bank 2015). The first ever green bond issued by a developing country was issued by Fiji in 2017, as a sovereign bond focused on sustainable development of natural resources, renewable energy, water and energy efficiency, clean transport, wastewater management, and sustainable agriculture to reduce fertilizer run-off into coastal areas (The World Bank 2017).

In recent years ‘blue bonds’ have emerged to support financing of solutions for coastal resilience. Financing for blue bonds is being pursued for the Pacific with planning underway for a Pacific Ocean Bond (BNCFF 2019), meaning the region may be well positioned to capitalize on private investment and provide an ethically and financially attractive market for investors. Emerging financing mechanisms such as these could provide much-needed resources to implement adaptations throughout catchments and in high vulnerability areas, especially in the PICTs. A critical step in ensuring strategies can be effective is maximizing their value and cost efficiency. Embedding consideration of financing in IM at multiple spatial scales, using a ridge to reef approach, provides one of the best opportunities to address issues that impact multiple, connected terrestrial and coastal environments and dependent communities.

6.3.3 Nature-Based Solutions and Regenerative Systems

Central to the water-energy-food nexus is the environment (Chap. 1), with functioning ecosystem services essential for sustainable development. Interactions between the sectors of water, energy, and food do not necessarily physically abut each other to be connected at an ecosystem, catchment, or other scale. The pressures and impacts from each sector interact through pathways as part the broader environment. NbS are actions that protect, sustainably manage, or restore natural and modified ecosystems in ways that address societal challenges effectively and adaptively, to provide both human well-being and biodiversity benefits (IUCN 2020). When applied to climate change, NbS could enable communities to achieve targeted climate mitigation outcomes, including GHG emissions reductions, while also realizing sustainable growth in the use and production of resources, especially water resources and food. Land management actions using these Natural Climate Solutions (NCS) may be able to provide more than one third of the mitigation required to keep climatic warming below 2 °C, and they may be more cost-effective than other approaches (Griscom et al. 2017). A range of NbS and NCS are emerging in agricultural settings and industries, including “regenerative practices”; practices that work to rehabilitate degraded land and reduce GHG emissions through specific farming approaches. The resource burden of global food production is significant, and transformation of this industry is needed. The Food and Land Use Coalition, Global Consultation Report (FOLU 2019) report defines 10 transformations that if implemented could create additional economic outcomes to 2030 worth USD530 billion, through actions that focus on ‘productive and regenerative agriculture’, and USD200 billion

by ‘restoring and protecting nature’. Importantly, NbS present an opportunity to bridge the intent of IM with practical and effective solutions for system-level interventions (e.g., improving soil health) and interlinked interventions that can have broader benefits (e.g., improving soil health to enhance food production, enhance biodiversity, and sustain local cultural values from the landscape).

An emerging illustration of how regenerative practices could foster increased food production while also improving water quality and ecosystem resilience can be seen in restorative aquaculture. It has been estimated that an additional 76 million people in tropical areas of Asia and Oceania could be fed on the high-quality protein provided by bivalve shellfish with an additional development of only 1% of the available (non-conflicted) waters (Willer and Aldridge 2020). However, the comparatively smaller contribution of aquaculture to total seafood production in Oceania (12 to 14%) and low growth rates over the last several decades (4%) present a challenge to increasing production from this industry in the short term (FAO 2020). Also, despite substantial progress in improving industry sustainability and management over the last 20 years issues associated with pathogens, parasites and pests remain, conflicting use of space and resources can be difficult to resolve, and the effects of climate change may present a challenge to the capacity of existing farming methods (Naylor et al. 2021). Therefore, while sustainable development of aquaculture might foster access to food and economic opportunities with minimal pressure to freshwater resources, and provide a means to produce quality protein with lower environmental impacts than terrestrial sources (Gephart et al. 2021), growth in this industry will most likely still increase the risk of environmental impacts, conflicts in resource use, and greater GHG emissions. In contrast, restorative aquaculture, “occurs when commercial or subsistence aquaculture provides direct ecological benefits to the environment, with the potential to generate net positive environmental outcomes” (The Nature Conservancy 2021). It provides an opportunity to direct growth in aquaculture for food or economic activity toward practices that can also generate ecosystem services and environmental benefits, and repair or protect coastal and marine environments. Bivalve shellfish aquaculture has been assessed as having ‘high potential’ for the parallel delivery of food and environmental benefits via restorative aquaculture in the Pacific (Theuerkauf et al. 2019, <https://sites.google.com/view/global-aquatest/home>), and interest in the production of seaweed species—an aquatic food that can be produced with the lowest known GHG emissions (Gephart et al. 2021) and provide a range of ecosystem services as co-benefits (Alleway et al. 2018)—is growing (Box 6.1).

To support effective implementation of NbS the International Union for Conservation of Nature (IUCN) has established global standards that provide a framework to support verification of the efficacy of solutions and guidance on their design (e.g., biodiversity and ecosystem considerations, financial viability, balancing trade-offs), and scaling, the ‘IUCN Global Standard for Nature-based Solutions’ (IUCN 2020). These standards directly and indirectly intersect with water and food industries. The synergies between aquaculture, for example, have been explicitly reviewed, showing that under specific circumstances, and if planned and implemented effectively, aquaculture could contribute to NbS (Le Gouvello et al. 2022). Regional initiatives

are also emerging, such as the Kiwa Initiative (<https://kiwainitiative.org/en/>) which works to strengthen the resilience of Pacific Island ecosystems, communities, and economies to climate change through NbS. In partnership with the Pacific Community (South Pacific Commission) and the Secretariat of the Pacific Regional Environment Programme (SPREP), this initiative recently launched a technical assistance program aimed at:

- identifying and developing large projects addressing climate change adaptation through NbS;
- assisting relevant stakeholders from beneficiary PICTs in project development to be submitted to the Secretariat of the Kiwa Initiative; and
- promoting joint funding opportunities from the Kiwa Initiative and other climate action donors.

The availability of frameworks and support mechanisms such as these provide important guidance for industry, jurisdictions, and communities in immediately engaging with NbS and regenerative practices, and must continue to be developed and maintained. To ensure NbS can be implemented effectively, however, and without undue economic costs through inefficiencies or maladapted responses, collaborative, cross-jurisdictional collaboration that can support the implementation of IM and ensure the inclusion of Indigenous and local knowledge and customary practices in an equitable way, must be reinforced.

Box 6.1 Seaweed—nutritional outcomes with sustainable, environmentally positive food sources

Marine algae (seaweed) produced through sustainable aquaculture is gaining increasing attention for its potential to be a nutritionally valuable source of food that can also provide ecosystem services and environmental benefits during farming (Fig. 6.2). Seaweeds have a range of known co-benefits, meaning the sector could make an important contribution to food security as well as ecosystem health in Pacific. Barrett et al. (2022) estimated that a seaweed farm could remove an average 275 kg of nitrogen $\text{ha}^{-1} \text{yr}^{-1}$ (n estimates = 8; 96–678 $\text{kg ha}^{-1} \text{yr}^{-1}$), worth an average 8,889 (3,084–21,886) USD $\text{ha}^{-1} \text{yr}^{-1}$, and there is the potential for seaweeds to use substantial amounts of carbon during their growth, to the extent that the carbon taken up could support offsetting emissions from the aquaculture industry as a whole (Froehlich et al. 2019). With the right practices seaweeds can be produced with very low GHG emissions and other environmental impacts (Gephart et al. 2021), and could therefore support communities in meeting the objectives of multiple SDG's (Duarte et al. 2021).



Fig. 6.2 Seaweed species have high range nutritional value and can be farmed with few environmental impacts and potential positive effects. (©TNC/Kevin Arnold)

However, despite high annual growth rates in seaweed production activity in seaweed aquaculture is largely nascent in many countries in the Pacific, including the larger industry jurisdictions of Australia and New Zealand (FAO 2020). Production is fragmented across the region, and farming has come up against multiple regulatory, technology, and social barriers. Recent work in the region has identified that actively linking seaweed production and processing to broader social, economic, and environmental goals could be an important pathway to overcoming current production and processing constraints, and building domestic demand and investing in the development of effective local supply chains could be an effective platform for then further growth (Paul 2020). Importantly, despite its nascent status in current production consumption of seaweed is not a new trend. In some Pacific nations seaweeds have cultural significance and are commonly consumed (Tiiti et al. 2022), but capitalizing on the potential for these species to be a nutritionally valuable and environmentally positive source of food will require an evolution from subsistence patterns of consumption to more widespread use (Butcher et al. 2020). Attention will need to be given to differences in local preferences (Butcher et al. 2020) and the production systems that are acceptable and most effective within jurisdictions (Paul 2020).

6.4 Conclusion

Safeguarding the health of fresh and marine water resources and systems will have benefits to the productivity and quality of food systems, as well as the water systems themselves. Without clean freshwater and sanitation, and intact, functioning marine environments, communities will experience ongoing impacts to health and wellbeing and increasing pressure on resources, because of population growth, competing needs for resources and economic opportunities (e.g. tourism), and climate change. The

intrinsic connectivity of water and food provides an important opportunity to design and implement locally contextualized solutions, which can be assisted by thinking about their interdependencies and leveraging approaches that work at the nexus, such as IM, ridge to reef investment, NbS and regenerative practices. Central to this opportunity is the interconnectedness of people, place, and ecosystems in the Pacific. Ensuring Indigenous and local knowledge is included as an integral part of these solutions will be critical to their success (e.g. knowledge to optimize freshwater resource use during periods of acute water scarcity; MacDonald et al. 2020). In some nations and areas, local knowledge is driving the development of original solutions at the forefront of proactive responses, for instance the reinvigoration of traditional and agroecological methods for networked marine protected areas (McLeod et al. 2019). In other nations, Indigenous and local knowledge is being overlooked in favour of technology innovation. Viewing the water-food equation as an opportunity to leverage connectivity and approach trade-offs, rather than viewing this connectivity solely as a challenge—often a highly complex challenge—provides a much-needed lens through which solutions that can improve the sustainability and resilience of ecosystems as well as communities can be developed.

References

- Alleway HK, Gillies CL, Bishop MJ, Gentry RR, Theuerkauf SJ, Jones R (2018) The ecosystem services of marine aquaculture: valuing benefits to people and nature. *Bioscience* 69:59–68. <https://doi.org/10.1093/biosci/biy137>
- Arthington AH, Dulvy NK, Gladstone W, Winfield IJ (2016) Fish conservation in freshwater and marine realms: status, threats and management. *Aquat Conserv* 26:838–857. <https://doi.org/10.1002/aqc.2712>
- Barrett LT, Theuerkauf SJ, Rose JM, Alleway HK, Bricker SB, Parker M et al (2022) Sustainable growth of non-fed aquaculture can generate valuable ecosystem benefits. *Ecosyst Serv* 53:101396. <https://doi.org/10.1016/j.ecoser.2021.101396>
- Barnett J (2011) Dangerous climate change in the Pacific Islands: food production and food security. *Reg Environ Change* 11:229–237. <https://doi.org/10.1007/s10113-010-0160-2>
- Becken S (2014) Water equity—contrasting tourism water use with that of the local community. *Water Resour Ind* 7–8:9–22. <https://doi.org/10.1016/j.wri.2014.09.002>
- Béné C (2020) Resilience of local food systems and links to food security—a review of some important concepts in the context of COVID-19 and other shocks. *Food Secur* 12:805–822. <https://doi.org/10.1007/s12571-020-01076-1>
- Blanchard JL, Watson RA, Fulton EA, Cottrell RS, Nash KL, Bryndum-Buchholz A et al (2017) Linked sustainability challenges and trade-offs among fisheries, aquaculture and agriculture. *Nat Ecol Evol* 1:1240–1249. <https://doi.org/10.1038/s41559-017-0258-8>
- BNCFF (2019) Blue bonds: financing resilience of coastal ecosystems. BNCFF, Gland
- Briassoulis H (2002) Sustainable tourism and the question of the commons. *Ann Tour Res* 29(4):1065–1085
- Butcher H, Burkhart S, Paul N, Tiitii U, Tamuera K, Eria T et al (2020) Role of seaweed in diets of Samoa and Kiribati: exploring key motivators for consumption. *Sustainability* 12. <https://doi.org/10.3390/su12187356>
- Carlson RR, Foo SA, Asner GP (2019) Land use impacts on coral reef health: a ridge-to-reef perspective. *Front Mar Sci* 6:562. <https://doi.org/10.3389/fmars.2019.00562>

- Chan T, MacDonald MC, Kearton A, Elliott M, Shields KF, Powell B et al (2020) A community-level Bayesian-belief-network model to support decision-making and climate adaptation for rural water and sanitation systems in the Solomon Islands. *Sci Total Environ* 714:136681. <https://doi.org/10.1016/j.scitotenv.2020.136681>
- Clark GF, Johnston EL (2017) Australia state of the environment 2016: coasts (Independent report to the Australian Government Minister for Environment and Energy). Australian Government Department of the Environment and Energy, Canberra
- Crook DA, Lowe WH, Allendorf FW, Erős T, Finn DS, Gillanders BM et al (2015) Human effects on ecological connectivity in aquatic ecosystems: integrating scientific approaches to support management and mitigation. *Sci Total Environ* 534:52–64
- Delevaux J, Stamoulis K (2022) Prioritizing forest management actions to benefit marine habitats in data-poor regions. *Conserv Biol* 36:e13792. <https://doi.org/10.1111/cobi.13792>
- Duarte CM, Bruhn A, Krause-Jensen D (2021) A seaweed aquaculture imperative to meet global sustainability targets. *Nat Sustain*. <https://doi.org/10.1038/s41893-021-00773-9>
- Dwyer L (2018) Saluting while the ship sinks: the necessity for tourism paradigm change. *J Sustain Tour* 26(1):29–48. <https://doi.org/10.1080/09669582.2017.1308372>
- Elliott M, MacDonald MC, Chan T, Kearton A, Shields KF, Bartram JK et al (2017) Multiple household water sources and their use in remote communities, with evidence from Pacific Island communities. *Water Resour Res* 53:9106–9117. <https://doi.org/10.1002/2017WR021047>
- Faivre G, Tomlinson R, Ware D, Shaeri S, Hadwen W, Buckwell A et al (2022) Effective coastal adaptation needs accurate hazard assessment: a case study in Port Resolution, Tanna Island Vanuatu. *Clim Change* 170:10. <https://doi.org/10.1007/s10584-021-03304-9>
- FAO (2017) Landscapes for life. Approaches to landscape management for sustainable food and agriculture. Food and Agriculture Organization of the United Nations, Rome
- FAO (2019) FAOSTAT. “New Food Balances.” FAO, Rome
- FAO (2020) The state of world fisheries and aquaculture. Sustainability in action. FAO, Rome
- FAO Earthscan (2011) The state of the world’s land and water resources for food and agriculture—managing systems at risk. Food and Agriculture Organization of the United Nations and Earthscan, Rome and London
- FOLU (2019) Growing better: ten critical transitions to transform food and land use. The Global Consultation Report of the Food and Land Use Coalition
- Froehlich HE, Afflerbach JC, Frazier M, Halpern BS (2019) Blue growth potential to mitigate climate change through seaweed offsetting. *Curr Biol* 29:3087–3093.e3. <https://doi.org/10.1016/j.cub.2019.07.041>
- Gentry RR, Ruff EO, Lester SE (2019) Temporal patterns of adoption of mariculture innovation globally. *Nat Sustain* 2:949–956. <https://doi.org/10.1038/s41893-019-0395-y>
- Georgeou N, Hawksley C, Wali N, Lountain S, Rowe E, West C et al (2022) Food security and small holder farming in Pacific Island countries and territories: a scoping review. *PLOS Sust Transf* 1:e0000009. <https://doi.org/10.1371/journal.pstr.0000009>
- Gephart JA, Henriksson PJG, Parker RWR, Shepon A, Gorospe KD, Bergman K et al (2021) Environmental performance of blue foods. *Nature* 597:360–365. <https://doi.org/10.1038/s41586-021-03889-2>
- Golden CD, Koehn JZ, Shepon A, Passarelli S, Free CM, Viana DF et al (2021) Aquatic foods to nourish nations. *Nature* 598:315–320. <https://doi.org/10.1038/s41586-021-03917-1>
- Griscom BW, Adams J, Ellis PW, Houghton RA, Lomax G, Miteva DA et al (2017) Natural climate solutions. *Proc Natl Acad Sci* 114:11645–11650. <https://doi.org/10.1073/pnas.1710465114>
- Hadwen WL, Powell P, MacDonald MC, Elliott M, Chan T, Gernjak W et al (2015) Putting WASH in the water cycle: climate change, water resources and the future of water, sanitation and hygiene challenges in Pacific Island countries. *J Water Sanit Hyg Dev* 5(2):183–191
- Halpern BS, Frazier M, Afflerbach J, Lowndes JS, Micheli F, O’Hara C et al (2019) Recent pace of change in human impact on the world’s ocean. *Sci Rep* 9:11609. <https://doi.org/10.1038/s41598-019-47201-9>

- Halpern BS, Frazier M, Potapenko J, Casey KS, Koenig K, Longo C et al (2015) Spatial and temporal changes in cumulative human impacts on the world's ocean. *Nat Commun* 6:7615. <https://doi.org/10.1038/ncomms8615>
- IPCC (2019) IPCC special report of the ocean and cryosphere in a changing climate. IPCC, Geneva
- IPCC (2022) *Climate Change 2022: impacts, adaptation, and vulnerability. Contribution of working group II to the sixth assessment report of the intergovernmental panel on climate change.* Cambridge University Press, Cambridge
- IUCN (2020) *Global standard for nature-based solutions. A user-friendly framework for the verification, design and scaling up of NbS, 1st edn.* IUCN, Gland
- Jupiter S, Mangubhai S, Kingsford RT (2014) Conservation of biodiversity in the Pacific Islands of Oceania: challenges and opportunities. *Pac Conserv Biol* 20:206–220
- Keppel G, Morrison C, Meyer J-Y, Boehmer HJ (2014) Isolated and vulnerable: the history and future of Pacific Island terrestrial biodiversity. *Pac Conserv Biol* 20:136–145
- Kittinger J (2013) Human dimensions of small-scale and traditional fisheries in the Asia-Pacific Region. *Pac Sci* 67:315–325. <https://doi.org/10.2984/67.3.1>
- Le Gouvello R, Brugere C, Simard F (2022) Aquaculture and nature-based solutions. Identifying synergies between sustainable development of coastal communities, aquaculture, and marine and coastal conservation. IUCN, Gland
- Loehr J, Dwipayanti NMU, Nastiti A, Powell B, Hadwen W, Johnson H (2021) Safer destinations, healthier staff and happier tourists: opportunities for inclusive water, sanitation and hygiene in tourism. *Tour Manag Perspect* 40:100883. <https://doi.org/10.1016/j.tmp.2021.100883>
- MacDonald MC, Chan T, Elliott M, Kearton A, Shields KF, Barrington DJ et al (2017) Temporal and thematic trends in water, sanitation and hygiene (WaSH) research in Pacific Island countries: a systematic review. *J Water Sanit Hyg Dev* 7:352–368
- MacDonald MC, Elliott M, Langidrik D, Chan T, Saunders A, Stewart-Koster B et al (2020) Mitigating drought in remote island atolls with traditional water usage behaviours and modern technology. *Sci Total Environ* 741:140230. <https://doi.org/10.1016/j.scitotenv.2020.140230>
- McLeod E, Bruton-Adams M, Förster J, Franco C, Gaines G, Gorong B (2019) Lessons from the Pacific Islands—adapting to climate change by supporting social and ecological resilience. *Front Mar Sci* 6. <https://doi.org/10.3389/fmars.2019.00289>
- Miller EC, Hayashi KT, Song D, Wiens JJ (2018) Explaining the ocean's richest biodiversity hotspot and global patterns of fish diversity. *Proc Royal Soc B* 285:20181314. <https://doi.org/10.1098/rspb.2018.1314>
- Nalau J, Becken S, Schliephack J, Parsons M, Brown C, Mackey B (2018) The role of indigenous and traditional knowledge in ecosystem-based adaptation: a review of the literature and case studies from the Pacific Islands. *Weather Clim Soc* 10:851–865. <https://doi.org/10.1175/WCAS-D-18-0032.1>
- Naylor RL, Hardy RW, Buschmann AH, Bush SR, Cao L, Klinger DH et al (2021) A 20-year retrospective review of global aquaculture. *Nature* 591:551–563. <https://doi.org/10.1038/s41586-021-03308-6>
- Northrop E, Konar M, Frost N, Holloway E (2020) A sustainable and equitable blue recovery to the COVID-19 crisis. World Resources Institute, Washington, DC
- Oyinlola MA, Reygondeau G, Wabnitz CCC, Troell M, Cheung WWL (2018) Global estimation of areas with suitable environmental conditions for mariculture species. *PLoS ONE* 13:e0191086. <https://doi.org/10.1371/journal.pone.0191086>
- Paul N (2020) Diversification of seaweed industries in Pacific Island countries. Project number FIS/2010/098 (No. FR2020-014). Australian Centre for International Agricultural Research, Canberra
- Poore J, Nemecek T (2018) Reducing food's environmental impacts through producers and consumers. *Science* 360:987–992. <https://doi.org/10.1126/science.aag0216>
- Roser M (2017) Tourism. <https://ourworldindata.org>

- Ruff EO, Gentry RR, Lester SE (2020) Understanding the role of socioeconomic and governance conditions in country-level marine aquaculture production. *Environ Res Lett* 15:1040a8. <https://doi.org/10.1088/1748-9326/abb908>
- Sahin O, Hadwen WL, Buckwell A, Fleming C, Ware D, Smart JCR et al (2021) Assessing how ecosystem-based adaptations to climate change influence community wellbeing: a Vanuatu case study. *Reg Environ Change* 21:90. <https://doi.org/10.1007/s10113-021-01809-8>
- Short RE, Gelcich S, Little DC, Micheli F, Allison EH, Basurto X et al (2021) Harnessing the diversity of small-scale actors is key to the future of aquatic food systems. *Nat Food* 2:733–741. <https://doi.org/10.1038/s43016-021-00363-0>
- Springmann M, Clark M, Mason-D’Croz D, Wiebe K, Bodirsky BL, Lassaletta L et al (2018) Options for keeping the food system within environmental limits. *Nature* 562:519–525. <https://doi.org/10.1038/s41586-018-0594-0>
- The Nature Conservancy (2021) Global principles of restorative aquaculture. The Nature Conservancy, Arlington, VA
- The World Bank (2015) What are green bonds? The World Bank, Washington, DC
- The World Bank (2017) Fiji issues first developing country green bond, raising \$50 million for climate resilience. <https://www.worldbank.org/en/news/press-release/2017/10/17/fiji-issues-first-developing-country-green-bond-raising-50-million-for-climate-resilience>
- Theuerkauf SJ, Morris JA, Waters TJ, Wickliffe LC, Alleway HK, Jones RC (2019) A global spatial analysis reveals where marine aquaculture can benefit nature and people. *PLoS ONE* 14:e0222282. <https://doi.org/10.1371/journal.pone.0222282>
- Tiitii U, Paul N, Burkhart S, Larson S, Swanepoel L (2022) Traditional knowledge and modern motivations for consuming seaweed (Limu) in Samoa. *Sustainability* 14. <https://doi.org/10.3390/su14106212>
- UNEP (2021) Adaptation GAP Report 2020. UNEP, Nairobi
- Willer DF, Aldridge DC (2020) Sustainable bivalve farming can deliver food security in the tropics. *Nat Food* 1:384–388. <https://doi.org/10.1038/s43016-020-0116-8>

The opinions expressed in this chapter are those of the author(s) and do not necessarily reflect the views of the UNESCO: United Nations Educational, Scientific and Cultural Organization, its Board of Directors, or the countries they represent.

Open Access This chapter is licensed under the terms of the Creative Commons Attribution-ShareAlike 3.0 IGO License (<https://creativecommons.org/licenses/by-sa/3.0/igo/>), which permits use, sharing, adaptation, distribution, and reproduction in any medium or format, as long as you give appropriate credit to the UNESCO: United Nations Educational, Scientific and Cultural Organization, provide a link to the Creative Commons licence and indicate if changes were made. If you remix, transform, or build upon this book or a part thereof, you must distribute your contributions under the same licence as the original.

The use of the UNESCO: United Nations Educational, Scientific and Cultural Organization's name, and the use of the UNESCO: United Nations Educational, Scientific and Cultural Organization's logo, shall be subject to a separate written licence agreement between the UNESCO: United Nations Educational, Scientific and Cultural Organization and the user and is not authorized as part of this CC-IGO licence. Note that the link provided above includes additional terms and conditions of the licence.

The images or other third party material in this chapter are included in the chapter's Creative Commons licence, unless indicated otherwise in a credit line to the material. If material is not included in the chapter's Creative Commons licence and your intended use is not permitted by statutory regulation or exceeds the permitted use, you will need to obtain permission directly from the copyright holder.



Chapter 7

The Water-Energy Equation



Richard R. Rushforth

Across the Pacific region, there is a statistically-significant relationship between a country's electrification rate and the proportion of that country's population served by a piped drinking water system.

Abstract In 1994, Peter Gleick defined the intricate relationship between water and energy as this: “We use energy to help us clean and transport the fresh water we need, and we use water to help us produce the energy we need.” In the Pacific region, where diesel fuel is the primary electricity generation fuel, the water-energy nexus goes further. Globally, large quantities of water are needed to produce the fuel required to electrify the Pacific region. The prevalence of piped water systems in the Pacific region depends on a country's electrification rate. Renewable energy technologies can increase rural electrification rates. A positive statistically significant relationship exists between a country's electrification rate and the prevalence of piped drinking water systems, which gives hope that adopting aggressive renewable energy and climate policies will lead to greater access to improved drinking water sources across the Pacific region.

Keywords Water-energy nexus · Nexus studies · Pacific energy supply chains · Resources interdependencies · Supply chains · Water-for-energy · Energy-for-water · SDG 6 · SDG 7

R. R. Rushforth (✉)
School of Informatics, Computing and Cyber Systems, Northern Arizona
University, Flagstaff, AZ, USA
e-mail: Richard.Rushforth@nau.edu

© UNESCO 2024
A. Dansie et al. (eds.), *The Water, Energy, and Food Security Nexus in Asia and the Pacific*, Water Security in a New World,
https://doi.org/10.1007/978-3-031-25463-5_7

7.1 Introduction

The water-energy nexus defines the linked dependency between how societies consume and utilize water and energy, how water is integral to the production of energy resources, and how energy is key to the production of clean drinking water, the development of piped water systems, and the treatment of wastewater. In 1994, Peter Gleick defined the intricate relationship between water and energy as this: “We use energy to help us clean and transport the fresh water we need, and we use water to help us produce the energy we need” (Gleick 1994). Gleick’s description of the relationship between water and energy underscores the water-energy nexus’s dual nature: we need water to produce energy and we need energy to produce and distribute potable water through piped systems.

The geography of the Pacific basin creates unique challenges for managing resources at the water-energy nexus. The energy supply chains that transport primary energy sources to the Pacific region are long and tenuous, presenting many challenges and vulnerabilities for these countries. Primary energy sources are energy sources that can be utilized without secondary transformation. For example, the US Energy Information Administration lists primary energy sources like fossil fuels such as petroleum, natural gas, coal; nuclear electric power; and renewable energy sources such as geothermal, solar, hydroelectric, wind, and biomass (US Energy Information Administration 2020a). Conventionally, the conversion of primary sources of energy into secondary forms of energy—namely electricity—relies on a thermoelectric process that requires converting water into steam to spin turbines that generate electricity (Kohli and Frenken 2011). Because the challenges presented by long supply chains has hindered diversification of electricity generation fuel sources in the Pacific—a recent estimate showed that imported fossil fuels accounted for 90% of energy use in the Pacific region (Abbasov 2020)—the water-energy nexus has significant implications for water resources consumption in the region.

On its face, the water-energy equation is two-sided; energy is necessary to produce clean water and treat wastewater while water is necessary for energy generation; but it is multifaceted due to feedback loops in these complex coupled natural-human systems (Liu et al. 2007). While it is important to understand how and why water is necessary to produce energy in all its forms, energy is necessary to produce clean, potable drinking water and to clean wastewater. The energy intensity of water treatment to produce potable drinking water is dependent on the initial quality of the water being treated. Not surprisingly, water requiring more treatment is more energy intensive. In a region with limited freshwater resources but abundant access to the ocean for desalination, the energy intensity of water treatment is an important consideration; the desalination of and treatment of ocean water (Chap. 8) can be orders of magnitude more energy-intensive than performing the same process on brackish water (Plappally 2012). In turn, there is a water intensity to our energy, as water (steam) is essential to the production of electricity at thermoelectric power plants; though in geographies where diesel fuel is the primary energy source for electricity generation this relationship is not as intense. Finally, while wastewater treatment

is an energy intensive process, wastewater itself is a potential source of energy through the production of biogas via anaerobic digestion (Qadir et al. 2020) and is an underutilized source of energy in area with low levels of wastewater infrastructure development. Hydroelectricity generated through control of rivers via dam construction is not prevalent in Pacific Island Countries and Territories (PICTs) but does exist (Chap. 2) and requires balancing upstream/downstream and seasonal demands for energy and water sectors. Even though the water-energy equation is seemingly straightforward, the numerous touchpoints between these two systems create complexity and opportunities for innovations that increase the sustainability of both systems in tandem.

This chapter will explore both lenses of the water-energy nexus and its implications for water access and security in the Pacific region, with focus mostly on the PICTs rather than the geographically larger and high-income countries of Australia and New Zealand. This chapter will present data on the supply chains that link the water-energy nexus across the Pacific region and present process-level data that quantifies the relationships between energy and water. We will discuss the impact that energy transitions away from fossil fuels will have on water resources. Further, we will discuss how a changing climate affects water availability and quality across the Pacific region and this, in turn, impacts the energy intensity of water production.

7.2 Water-For-Energy in the Pacific Region

Water is essential to the production of energy in all of its forms. Indeed, water itself is a form of energy stored behind dams or when river and ocean currents are utilized to spin turbines that produce electricity (US Department of Energy 2020). For the Pacific region, the water-for-energy relationship takes two forms. First, the direct usage of water to produce energy in the form of electricity. Direct water usage is the physical consumption of water to produce electricity through thermoelectric processes. The second form is indirect water use in the supply chains that produce the region's primary energy resources. Since the Pacific region's largest fuels for electricity generation are fossil fuels, mainly diesel in PICTS and coal in Australia (as detailed in Chaps. 3 and 12), we must also consider the water consumption required to produce these energy commodities. Through the water-energy nexus, water scarcity and other issues that affect the quantity, quality, and availability of water resources can affect the Pacific region's energy supply at the local level where electricity is generated and at the global level where fossil fuels are produced. In this section, we first discuss the direct use of water for energy production, followed by indirect water use in the Pacific region's energy supply chain. The section concludes with a discussion on the water implications of the Pacific region's transition away from fossil fuels.

7.2.1 Overview of Energy Generation Fuels Across the Pacific Region

Numerous challenges exist facing the electrification of the Pacific region. First and foremost, the region's remoteness creates long fuel supply chains to link the countries in the Pacific region to fuel suppliers. These long supply chains have created a dependence of fossil fuel in PICT nation electricity systems, both in the transport of fuel to islands and the utilization of petroleum products (fuel oils and diesel) as a primary fuel source for electricity generation. Population density also presents a large challenge to energy development and diversification. According to the Asian Development Bank (2019), the nations of Papua New Guinea, Fiji, Solomon Islands, Vanuatu, Samoa, Kiribati, Tonga, the Federated States of Micronesia, Marshall Islands, the Cook Islands, Palau, Nauru, Tuvalu, and Niue are comprised of approximately 3,200 islands/atolls. Given these countries' populations, the population per island/atoll ranges from 60 inhabitants per island/atoll in Palau to 21,889 inhabitants per island/atoll in Samoa (Asian Development Bank 2019). Previous studies have indicated that differences in electrification rates across PICT have pointed to geography—the vast number of islands/atolls in the region—along with differences in population density and GDP per capita as primary reasons (Dornan 2014). As shown in Table 7.1, in 2011 there was a weak relationship present between PICT electrification rates and both population density and GDP per capita. However, in 2019, the relationship identified by Dornan (2014) no longer held as many of the PICT nations with low electrification rates had substantially increased electrification rates by 2019. Specifically, the PICT nations of Vanuatu, Solomon Islands, and Papua New Guinea increased electrification rates by 282%, 450%, and 530%, respectively, illustrating the success that these countries have had making progress toward Sustainable Development Goal (SDG) 7, which includes ensuring “access to affordable, reliable, sustainable and modern energy for all,” (Wu and Wu 2015). This needed and welcomed SDG electrification progress is due to increases in both fossil fuel-based and renewable energy electricity generation (Chap. 3).

Across the PICT region, fossil fuels, specifically fuel oils and diesel, play an outsized role in electricity generation due to the length of PICT supply chains, the high energy content of these fuels, and the relative portability of these fuels compared to other primary sources of energy for electricity generation. Oil and petroleum product dependence is a well-documented and longstanding concern for PICT nations. For decades, research studies have discussed the vulnerability of PICT nations to oil price shock and supply chain disruptions in their energy systems (Yu and Taplin 1997). A 1998 study evaluated the Fijian energy system oil dependencies and cited trade statistics showing net energy import dependence exceeding 90% as far back as the 1970s (Reddy 1998). Further, Reddy (1998) and Currie (1996) discussed various policy measures to reduce Fijian dependency on imported oil products, underscoring that the current efforts to reduce PICT nation fossil fuel dependency have deep roots.

Table 7.1 Electrification rates across the Pacific region

Country	2011			2019		
	GDP per capita ^a (\$2019 USD)	Population density ^b (person per km ²)	Electrification rate ^c (%)	GDP per capita ^a (\$2019 USD)	Population density ^b (persons per km ²)	Electrification rate ^c (%)
Guam	31,210	296	100	37,724	310	100
Nauru	6,560	503	100	10,983	538	100
Niue	11,372	6	100	12,095	7	100
Tuvalu	3,643	354	100	4,056	389	100
Northern Mariana Islands	13,497	117	100	20,660	124	100
Cook Islands*	17,837	74	99	28,486	75	100
Samoa	3,933	66	99	4,324	70	99
Palau	11,095	39	97	14,908	39	100
Tonga	4,003	144	95	4,903	145	98
Fiji	4,371	47	89	6,176	49	100
Marshall Islands	3,046	314	95	4,073	327	95
Kiribati	1,735	129	63	1,655	145	100
Federated States of Micronesia	3,009	148	54	3,585	163	75
Vanuatu	3,174	20	17	3,102	25	65
Solomon Islands	1,939	19	14	2,344	24	70
Papua New Guinea	2,407	17	10	2,829	19	63

^aUnited Nations Statistics Division (2019)

^bUnited Nations, Department of Economic and Social Affairs, Population Division (2019)

^cTracking SDG 7: The Energy Progress Report (2021)

Global data gathered by the US Energy Information Administration show on average fossil fuels comprise 80% of country level electricity generation portfolios in the Pacific region (US Energy Information Administration 2020b, 2020c). These data are shown in Table 7.2. According to the Asian Development Bank, the Cook Islands and Majuro, Marshall Islands are almost entirely diesel dependent for energy sources (Asian Development Bank 2019). According to a 2012 profile by the US National Renewable Energy Laboratory (NREL) of the 20.1 MW of nameplate capacity on the Federated States of Micronesia, diesel generators made up 18.6 MW of nameplate capacity (National Renewable Energy Laboratory 2016). In addition, a 2011 technical assessment conducted by NREL on Guam's energy system found

an almost 100% reliance on petroleum products to meet energy demands; further, 52% of the petroleum products consumed (by volume) on island were consumed by the Guam Power Authority (Baring-Gould et al. 2011). As will be discussed later, the historic reliance on fossil fuels across the PICT region creates supply chain vulnerabilities with severe energy-water implications.

The heavy dependence of many PICT nations on fossil fuels for the generation of electricity is shown in Table 7.2 (see also Chap. 3). Of the nations with available data, 79% of generated electricity is generated from fossil fuel sources, with many being more than 95% dependent on fossil fuel for generation. Fiji is the outlier among the countries listed in Table 7.2 by generating 55% of electricity from renewable sources. While many PICT nations are listed in Table 7.2, source data only lists combustible fuels, hydropower, nuclear, and other sources as electricity sources, which provides a narrow view on electricity generation sources (United Nations 2020). Data availability has been documented as a limiting factor by regional energy system studies (Mishra et al. 2009; Lucas et al. 2017). However, the future of electricity generation will reduce fossil fuel dependence in electricity generation and shift to near-universal renewable energy development in the near future (Table 7.3). In many cases, the shift away from fossil fuels for electricity generation, which is an expensive fuel source, will positively impact Pacific region nations' economies. In 2012, Tokelau began generating 150% of power demands from renewable energy sources, saving the island approximately \$829,000 per year of fuel costs (Government of Tokelau n.d.; Wilson 2012).

7.2.2 The Water Intensity of Electricity Generation

Fossil fuels are not only an expensive electricity generation fuel; they are also a highly water-intensive fuel source for generating kilowatt-hours. Between 2008–2012, the consumptive water use of electricity generation in Oceania (the Pacific Region) was 1,957 m³ per year (Mekonnen et al. 2015); nearly three fourths (1,405 m³ per year) of this water consumption occurred during the operational phase of electricity generation and the phase of electricity generation and the remainder (approx. 551 m³ per year) occurred within the fuel supply chain. For this analysis, most of this water footprint (1,012 million m³ per year) was from hydropower generation (evaporation occurring at water impoundments), while 584 and 13 million m³ per year were consumed by coal lignite and oil generation, respectively (Mekonnen et al. 2015). However, this study takes a broad look at Oceania. The data is biased to countries for which data is available for in international data repositories, which may not account for diesel generators' fuel supply chain and energy mix of smaller Pacific region nations.

The reliance on diesel fuel for generation presents a challenge for traditional water-energy evaluations of the Pacific region's electricity generation since diesel fuel is typically treated as a transportation fuel instead of a stationary energy fuel source. A study by Lampert et al. (2016), from Argonne National Laboratories in the

Table 7.2 Fossil fuel dependence in electricity generation across the Pacific region

Country	Fossil fuel generation (2018, million kWh)	Total electricity generation (2018, million kWh)	Fossil fuel generation (%)
American Samoa	163	168	97
Cook Islands	31	41	76
Federated States of Micronesia	65	90	72
Fiji	464	1,042	45
French Polynesia	494	696	71
Gaum	1,663	1,715	97
Kiribati	27	31	87
Marshall Islands	88	90	98
Nauru	35	36	97
New Caledonia	3,077	3,486	88
Niue	3	4	75
Northern Mariana Islands	390	390	100
Palau	95	95	100
Papua New Guinea	3,180	4,482	71
Samoa	90	154	58
Solomon Islands	106	110	96
Tokelau ^a	–	–	–
Tonga	64	68	94
Tuvalu	6	8	75
Vanuatu	62	80	78
Wallis and Futuna	20	20	100
Total	10,123	12,806	79

Source United Nations (2020)

^aTokelau's GHG emissions are tabulated as part of New Zealand's GHG inventory (Ministry for the Environment, 2021) and has pledged to generate more renewable energy than is used on island (Government of Tokelau, n.d.)

United States, found that diesel production's lifecycle water consumption is 5.97 L of water/L of diesel produced. In 2012, the Cook Islands spent USD 29.8 million on diesel fuel for electricity generation (Asian Development Bank 2019). During 2012, the average worldwide diesel price was USD 1.265 per L (World Bank 2020), which implies that the Cook Islands consumed approximately 23.56 million diesel L for electricity generation. Given the figures derived by Lampert et al. (2016), the Cook Islands electricity generation's supply chain water consumption was 139,162 m³ or approximately 16 m³ per capita. Using the data from Table 7.2, diesel generation on the Cook Islands consumed approximately 4.48 L of water in its diesel supply chain

Table 7.3 Pacific region nations' renewable energy targets

Country	Renewable energy target (%)	Renewable energy target year
Federated States of Micronesia	>30	2020
Fiji	100	2030
Kiribati	23–40	2025
Marshall Islands	20	2020
Nauru	50	2020
Niue	80	2025
Palau	45	2025
Papua New Guinea	100	2030
Samoa	100	2025
Solomon Islands	79	2030
Tonga	50	2020
Tuvalu	100	2020
Vanuatu	100	2030

Note Adapted from Asian Development Bank (2019)

per kWh generated. Diesel fuel for electricity generation also poses risks for energy security with large, coastal storage facilities at risk from both severe storm damage and general age-related decay (Chaps. 10 and 12).

However, what we can see in Table 7.2 is that the Cook Islands is just a small fraction of fossil fuel generation in the Pacific region. Excluding Australia and New Zealand, the Cook Islands make up less than 1% of fossil fuel generation (9 billion kWh) in the Pacific region. Assuming that most fossil fuel generation in the Pacific region, excluding Australia and New Zealand, comes from diesel, and extrapolating from the Cook Island example, the Pacific region consumes 39 million m³ of water in its diesel supply chain related to electricity generation. The climate policies (Table 7.3) undertaken by the Pacific region countries have a dual impact. Not only will these policies reduce diesel consumption in the region by hundreds of millions of liters, but they will also lessen the region's pressure on global water resources.

7.3 Energy-For-Water in the Pacific Region

For the Pacific region, the other half of the water-energy equation is understanding the energy-for-water relationship. Fundamentally, the amount of energy required to treat water depends on its source and its quality. Water sources with lower initial quality will require more treatment—a wider variety of technologies or more energy-intensive processing—than water sources of higher initial quality. On the most energy-intensive end of this spectrum is seawater (Chap. 8). The desalination of

seawater requires large amounts of energy, and the energy intensity of desalination increases with seawater salinity.

However, for the Pacific region, the energy-for-water equation starts with the status of water systems. Piped water systems with centralized treatment are the most energy-intensive water system. According to WHO, in 2015, only 20% of the Pacific region (excluding Australia and New Zealand) had access to piped drinking water directly on their premises; this is the lowest proportion for any region in the world (World Health Organization 2016). In total, 52% of people in the Pacific region have access to improved water systems, while the remaining 48% rely on surface water (34%) and other unimproved water sources (14%) (World Health Organization 2016). Access to piped drinking water into households varies widely across the Pacific region. Niue and Tuvalu have nearly universal access to piped drinking water into households at 98% and 97%, respectively (World Health Organization 2016). On the low end of this spectrum, only 9% of the population of Papua New Guinea and only 3% of the population of the Marshall Islands have piped drinking water into households (World Health Organization 2016). It is important to note that the country-level statistics belie the drastic urban–rural divide between water access in the Pacific region. In all countries in the Pacific region, urban areas have greater access to improved water sources, including piped drinking water systems than rural areas. After factoring the urban/rural divide into these statistics, 67% of the Pacific region’s urban population has access to piped drinking water systems, while only 9% of the rural population access the equivalent water access (World Health Organization 2016).

The energy-for-water question for the Pacific region is fundamentally a question of water access (Chap. 2). Where populations are centralized (i.e., the urban areas), there is greater access to piped drinking water systems, the most energy-intensive types of water systems. Where populations are dispersed across the Pacific region’s rural areas, there is little-to-no access to piped drinking water (Fig. 7.1). Except for the Marshall Islands, there is a tight relationship between a country’s electrification rate and the prevalence of piped water systems. Across the Pacific region, there is a statistically significant relationship between a country’s electrification rate and the proportion of a country’s population served by a piped drinking water system. This pattern indicates that where electrification occurs across the PICT region, other infrastructure improvements follow, such as the development of piped drinking water infrastructure system, corroborating findings on rural electrification increasing the prevalence of household piped water systems (Grogan and Sadanand 2013). For all countries (listed in Fig. 7.1), the relation has an R -squared of 0.54 ($p < 0.01$); excluding the Marshall Islands from this analysis, the relationship becomes more significant (R -squared: 0.84; $p < 0.01$). This energy-for-water relationship in the Pacific region hinges upon a question of scale. An area’s population density must reach a critical point to make the economics of a piped drinking water system viable. The expansion of piped water across the Pacific region will be dependent on the progress of energy efficiency improvements to water treatment and distribution technologies.

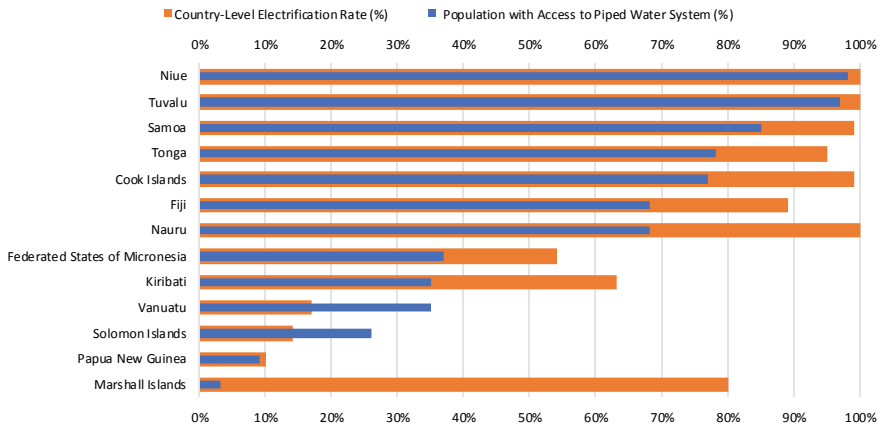

Fig. 7.1 Comparison of electrification rates and prevalence of piped water systems in the Pacific region. Electrification rate data sourced from Dornan (2014) and piped water system access data sources from World Health Organization (2016)

7.4 Using the Water-Energy Equation to Understand Vulnerabilities at the Nexus

Electrification through the development of diesel and fuel oil electricity generation assets has proven to be a scalable solution for PICTs (Table 7.1). However, the almost singular dependence on petroleum products for electricity generation creates systemic vulnerabilities at the nexus points between islanded energy system and water systems, and, moreover, all other critical infrastructure. Across PICTs, and much of the developing world, electrification has led to the investment and improvement of piped water systems. However, these improvements are laden with embedded vulnerabilities. Energy systems that are highly dependent on petroleum products convey petroleum product dependence to the critical infrastructure systems dependent on electrification for functionality. Therefore, and critically, the functioning of PICT water systems is intrinsically and wholly dependent on the functioning of petroleum product supply chains that facilitate the distribution and delivery of fuel across the region. Supply shocks to oil and petroleum products refining, price shocks, and disruptions to distribution systems—either through accidents, natural hazards (Chap. 10), or climate change (Chap. 5)—are also systemic vulnerabilities to PICT water systems. Furthermore, as the fuel inputs into the PICT energy systems are carbon intensive so too are the dependent water systems. Diversifying PICT energy portfolios to include greater levels of renewable energy sources not only makes these systems more resilient, but also lessens the climate burden of these systems. Further, due to the remoteness of some PICTs, the physical length of supply chain linkages becomes a critical system characteristic. Disruptions to PICT fuel distribution systems thousands of miles away through accidents, natural hazards, or climate

change can present fundamental challenges to the functioning of energy systems, water systems, health, and human safety for PICTs.

Here, we use a hypothetical PICT nation to illustrate this point. Like many PICT nations, our exemplar sources the majority of its petroleum products through Singapore, but occasionally sources diesel and refined fuel from Japan and South Korea, and sometimes Malaysia and China. Given the remoteness of the island, diesel and refined fuel oil delivery usually takes around two weeks from the tanker leaving Singapore; the tanker journey time is longer if leaving from South Korea, Japan, or China. Due to the length of the delivery time, the PICT has developed on-island fuel reserves, which provide the island a 2–3 day buffer of fuel supplies if a delivery is delayed. The buffer includes a 2–3 day supply of fuel for electricity generation in addition to reserve fuel capacity for the piped water system. Altogether, the water system has 4–6 days of buffer capacity, and can remain operational even after the electricity system is no longer functioning. Nonetheless, long petroleum products supply chains create substantial risk for PICT water systems.

Disruptions can occur anywhere along the delivery route, but the most tangible to envision are at the site of the distribution fuel terminals (e.g., Singapore, South Korea, or Japan) and the on-island fuel terminals at our exemplar PICT nation. Indirectly, the island's energy, water, and other critical infrastructure system are dependent on the continued functioning of shipping lanes in the Strait of Malacca. A tanker accident in the Strait of Malacca that shuts down freight traffic for three weeks would be catastrophic to PICT nation fuel supply chains (ERIA 2016) necessitating for the reorganization of fuel supply chains to source new resources from other Pacific sources, for example, Japan, South Korea, New Zealand, or Australia. However, as Singapore is the major fuel supplier for the Pacific, numerous other countries are also reconfiguring their fuel supply chains, pushing refuel windows longer and longer. In this example, an incident in the Strait of Malacca supply chain reconfiguration could push the island beyond its fuel buffer window, leading to forced rationing in the form of scheduled brownouts/blackouts and the potential disruption to dependent infrastructure systems, like the island's piped water system. Energy supply diversification through the development of on-island renewable sources provides our example PICT nation a source of electricity decorrelated from risks in crowded shipping lanes thousands of miles away. The six-day blockage of the Panama Canal by the *Ever Given* container ship in March 2021 provided an example of how global supply chains can be suddenly and catastrophically disrupted.

Typhoons pose multiple threats to the island's energy and water. As fuel deliveries occur by tanker, the island's main fuel terminals are located on a bay just outside the main city. Fuel is then distributed throughout the island by pipeline and truck. Wind damage from a major typhoon can cause damage to aboveground pipeline infrastructure or fuel racks (Guard et al. 2003). Similarly, storm surges and tsunamis can flood petroleum terminals and fuel racks, causing severe damages through multiple means such as crushing, tie down failures, and sliding (Naito et al. 2013). If these damages, were to result in fuel leakage and combustion, the fuel terminal could remain offline for an indefinite period of time and cause on-island and off-island damages. In 2003, Super Typhoon Pongsona passed over Guam, creating a fire at

major terminal that lasted for five days, and disrupted gasoline distribution on-island and across Micronesia (Guard et al. 2003). The impact of Super Typhon Pongsona underscore lessons learned from other typhoons: pre-existing system dependencies and supply chain length matters and can negatively affect recovery time of energy and dependent systems (Palin 2018).

7.5 Conclusions

A reliance on fossil fuels, specifically diesel fuel, for electricity generation has created a significant water dependency across PICT energy supply chains. On average, 5.90 L of water is consumed to produce 1 L of diesel. For nations that consume tens of millions to hundreds of millions of diesel liters to produce electricity, the $5.9 \times$ water multiplier in its diesel supply chain means that the region consumes millions of cubic meters of water to produce electricity annually.

For the Pacific region, the energy-for-water relationship comes down to the fundamental differences between urban and rural communities and electricity access. According to WHO statistics, urban areas across the Pacific region are 7.4 times more likely to have access to piped drinking water systems. Piped water systems are energy-intensive, so there is a strong statistical relationship between a country's electrification rate and the proportion of the population served by piped water systems. There is no question that population density and energy intensity of piped water systems limit the expansion of these water systems across the region. Decentralized approaches such as rainwater harvesting (Chap. 2) and small-scale solar set ups (Chap. 12) will need to play a role in securing water and energy in disparate and rural populations.

The water intensity of the Pacific region's electricity supply will decrease over the near future. Five Pacific region nations—Fiji, Papua New Guinea, Samoa, Tuvalu, and Vanuatu (Table 7.3)—have enacted climate policies to obtain electricity from 100% renewable sources by 2030. Another four countries—Nauru, Niue, Solomon Islands, Tonga (Table 7.3)—have policies to generate more than 50% of electricity from renewable sources by 2030. The diversification of electricity sources across the Pacific region away from diesel will necessarily decrease the region's electricity generation's total water intensity. Governments and electric utilities can leverage renewable energy technologies to increase rural electrification rates (Mofor et al. 2013). The statistically significant positive relationship between a PICT nation's electrification rate and the prevalence of piped drinking water systems (Fig. 7.1) presented suggest that national strategies that pursue increasing electrification rates should have a spillover effect of increasing the prevalence of improved water sources and piped water systems. Therefore, PICT nations can pursue coordinated approaches that address the water-energy equation by taking a coupled approach to improving the status of their populations with respect to SDG 6 (“Ensure access to and sanitation for all”) and SDG 7 (“Ensure access to affordable, reliable, sustainable and modern energy for all”). As many PICT nations have aggressive renewable energy generation

targets, a coupled approach to SDG 6 and SDG 7 can be achieved in a climate neutral manner, ensuring climate neutral energy and water development for disadvantaged populations.

Finally, the systemic risks and vulnerabilities to PICT nations resulting from disruptions to petroleum products supply chains need to be addressed in a long-term vision to improve energy security in the face of both climate change and increasing human population pressures. Given the length of PICT petroleum products supply chains, a thin margin exists between a disruption being a transitory occurrence or precipitating a cascading failure across other critical infrastructure systems and sub-regional petroleum productions distribution systems. These supply chain risks coupled with the existential threat created by climate change demonstrates the fundamental importance of diversifying PICT energy supply chains. The renewable energy targets set by PICTs (Table 7.3) alleviate the systemic risks of relying on petroleum products for food, energy, and water provision. Renewable energy integration into PICT electricity systems and directly into water infrastructure systems decarbonizes and de-risks both islanded energy and water systems, creating systems that are more resilient (Weir and Kumar 2020) to severe weather (e.g., typhoons, tsunamis), non-local disruptions (e.g., Strait of Malacca disruption, oil price shocks), and climate change.

References

- Abbasov R (2020) Can the Pacific become the world's first fossil-fuel-free zone? <https://blogs.adb.org/blog/can-pacific-become-world-s-first-fossil-fuel-free-zone>
- Asian Development Bank (2019) Pacific energy update 2019. <https://www.adb.org/sites/default/files/institutional-document/545686/pacific-energy-update-2019.pdf>
- Baring-Gould I, Conrad M, Haase S, Hotchkiss E, McNutt P (2011) Guam initial technical assessment report, United States. <https://doi.org/10.2172/1012498>
- Currie C (1996) Energy efficiency and energy intensity. *J Pac Stud* 9:83–97
- Dornan M (2014) Access to electricity in Small Island Developing States of the Pacific: Issues and challenges. *Renew Sust Energy Rev* 31:726–735
- ERIA (2016) Crisis scenario. In: Kobayashi Y, Anbumozhi V (eds) Cooperation framework for oil stockpiling and emergency response system. ERIA Research Project Report 2015-7. ERIA, Jakarta, pp 3–28
- Gleick PH (1994) Water and energy. *Annu Rev Environ Resour* 19(1):267–299
- Government of Tokelau (n.d.) Solar project: the world's first truly renewable energy nation. <https://www.tokelau.org.nz/Solar+Project>
- Grogan L, Sadanand A (2013) Rural electrification and employment in poor countries: evidence from Nicaragua. *World Dev* 43:252–265
- Guard C, Chiu ANL, Lander MA (2003) NOAA/NWS meteorological assessment for typhoon pongsona. <https://citeseerx.ist.psu.edu/viewdoc/download?doi=10.1.1.694.931&rep=rep1&type=pdf>
- Kohli A, Frenken K (2011) Cooling water for energy generation and its impact on national-level water statistics. Food and Agriculture Organization, AQUASTAT Programme
- Lampert DJ, Cai H, Elgowainy A (2016) Wells to wheels: water consumption for transportation fuels in the United States. *Energy Environ Sci* 9(3):787–802
- Liu J, Dietz T, Carpenter SR, Alberti M, Folke C, Moran E et al (2007) Complexity of coupled human and natural systems. *Science* 317(5844):1513–1516

- Lucas H, Fifita S, Talab I, Marschel C, Cabeza LF (2017) Critical challenges and capacity building needs for renewable energy deployment in Pacific Small Island Developing States (Pacific SIDS). *Renew Energy* 107:42–52
- Mekonnen MM, Gerbens-Leenes PW, Hoekstra AY (2015) The consumptive water footprint of electricity and heat: a global assessment. *Environ Sci Water Res Technol* 1(3):285–297
- Mishra V, Sharma S, Smyth R (2009) Are fluctuations in energy consumption per capita transitory? Evidence from a panel of Pacific Island countries. *Energy Policy* 37(6):2318–2326
- Mofor L, Isaka M, Wade H, Soakai A (2013) Pacific lighthouses: renewable energy roadmapping for islands. International Renewable Energy Agency, United Arab Emirates
- Naito C, Cox D, Yu QSK, Brooker H (2013) Fuel storage container performance during the 2011 Tohoku, Japan, tsunami. *J Perform Construc* 27(4):373–380
- National Renewable Energy Laboratory (2016) Federated States of Micronesia: pursuing a sustainable and resilient energy future. <https://www.nrel.gov/docs/fy16osti/66692.pdf>
- Palin PJ (2018) Learning from HIM (Harvey, Irma, Maria): preliminary impressions for supply chain resilience. *Homeland Security Affairs*, 14
- Plappally AK (2012) Energy requirements for water production, treatment, end use, reclamation, and disposal. *Renew Sust Energy Rev* 16(7):4818–4848
- Qadir M, Drechsel P, Jiménez Cisneros B, Kim Y, Pramanik A, Mehta P, et al. (2020) Global and regional potential of wastewater as a water, nutrient and energy source. *Nat Resour Forum* 44(1):40–51
- Reddy M (1998) Energy consumption and economic activity in Fiji. *J Pacific Stud* 22:81–96
- Tracking SDG 7 (2021) The energy progress report. Country profiles. <https://trackingsdg7.esmap.org/countries>
- United Nations (2020) 2018 electricity profiles. United Nations Publications, New York
- United Nations Statistics Division (2019) Per capita GDP at current prices: US dollars. <http://data.un.org/Data.aspx?d=SNAAMA&f=grID%3A101%3BcurrID%3AUSD%3BpcFlag%3A1>
- United Nations, Department of Economic and Social Affairs, Population Division (2019) World population prospects 2019, online edition. rev. 1
- US Department of Energy (2020) Types of hydropower turbines. <https://www.energy.gov/eere/water/types-hydropower-turbines>
- US Energy Information Administration (2020a) Primary energy. <https://www.eia.gov/tools/glossary/index.php?id=Primary%20energy>
- US Energy Information Administration (2020b) International energy data—electricity generation <https://www.eia.gov/opa/data/qb.php?category=2134412>
- US Energy Information Administration (2020c) International energy data—fossil fuel electricity generation <https://www.eia.gov/opa/data/qb.php?category=2134652>
- Weir T, Kumar M (2020) Renewable energy can enhance resilience of small islands. *Nat Hazards* 104(3):2719–2725
- Wilson C (2012) Pacific Island sets renewable energy record: sustainable energy for all. <https://www.seforall.org/news/pacific-island-sets-renewable-energy-record>
- World Bank (2020) Pump price for diesel fuel (US\$ per liter). <https://data.worldbank.org/indicator/EP.PMP.DESL.CD>
- World Health Organization (2016) Sanitation, drinking-water and health in Pacific Island countries: 2015 update and future outlook. WHO.
- Wu J, Wu T (2015) Ensure access to affordable, reliable, sustainable and modern energy for all. *UN Chron* 51(4):17–18. <https://doi.org/10.18356/24ef28d2-en>
- Yu X, Taplin R (1997) A survey: international aid for renewable energy in the Pacific Islands since the 1970s. *Energy Policy* 25(5):501–516

The opinions expressed in this chapter are those of the author(s) and do not necessarily reflect the views of the UNESCO: United Nations Educational, Scientific and Cultural Organization, its Board of Directors, or the countries they represent.

Open Access This chapter is licensed under the terms of the Creative Commons Attribution-ShareAlike 3.0 IGO License (<https://creativecommons.org/licenses/by-sa/3.0/igo/>), which permits use, sharing, adaptation, distribution, and reproduction in any medium or format, as long as you give appropriate credit to the UNESCO: United Nations Educational, Scientific and Cultural Organization, provide a link to the Creative Commons licence and indicate if changes were made. If you remix, transform, or build upon this book or a part thereof, you must distribute your contributions under the same licence as the original.

The use of the UNESCO: United Nations Educational, Scientific and Cultural Organization's name, and the use of the UNESCO: United Nations Educational, Scientific and Cultural Organization's logo, shall be subject to a separate written licence agreement between the UNESCO: United Nations Educational, Scientific and Cultural Organization and the user and is not authorized as part of this CC-IGO licence. Note that the link provided above includes additional terms and conditions of the licence.

The images or other third party material in this chapter are included in the chapter's Creative Commons licence, unless indicated otherwise in a credit line to the material. If material is not included in the chapter's Creative Commons licence and your intended use is not permitted by statutory regulation or exceeds the permitted use, you will need to obtain permission directly from the copyright holder.



Chapter 8

Desalination in the Pacific



Yingfei Huang, Conna Leslie-Keefe, and Greg Leslie

Abstract Desalination has traditionally underpinned public water infrastructure in the Middle East and is now an important component of urban water supplies for communities in Asia, Southern Europe, the Americas, and Australia. However, the deployment of this technology in the Pacific at scale has mostly been used to support defense installations, mining operations, and tourist resorts. Drawing on data from more than 60 facilities, this chapter charts the use of seawater desalination as a source of freshwater in the Pacific. Beginning with the first installation of a multi-stage flash distillation system in 1964 on Hao Atoll, French Polynesia, the chapter summarizes the features of the thermal distillation and reverse osmosis desalination systems deployed in Polynesia, Micronesia, and Melanesia, as well as the motivation for the projects, institutional arrangements, and current operational status. At present, the utilization of desalination in the Pacific per capita is lower than other countries of comparable gross domestic product (GDP) and water vulnerability as defined by the United Nations Environment Programme (UNEP). While non-government actors, including sovereign and international development banks have plans to develop desalination facilities, a variety of obstacles prevent the wider distribution of the benefits of this climate-resistant water source. The chapter examines the potential applications of desalination in enabling economic activity, reducing pressure on freshwater resources.

Keywords Desalination · Thermal desalination · Multi-stage flash distillation · Multi-effect distillation · Reverse osmosis · Mechanical vapour compression distillation · Potable water

Y. Huang · G. Leslie (✉)
School of Chemical Engineering, UNSW, Sydney, Australia
e-mail: g.leslie@unsw.edu.au

C. Leslie-Keefe
School of Law, Society and Criminology, UNSW, Sydney, Australia

G. Leslie
Global Water Institute, UNSW, Sydney, Australia

© UNESCO 2024

A. Dansie et al. (eds.), *The Water, Energy, and Food Security Nexus in Asia and the Pacific*, Water Security in a New World,
https://doi.org/10.1007/978-3-031-25463-5_8

165

8.1 Introduction

Desalination describes a variety of mechanisms used to produce potable water by removing dissolved solids and salts from raw water sources, which may include river water, seawater, brackish water, and wastewater (Australia National Water Commission 2008). Desalination plants are used to supply potable water to coastal communities and urban areas in over 40 countries and are the main source of potable for countries in the Arabian Gulf (Australia National Water Commission 2008). While the Pacific differs significantly in climate and weather patterns from the Arabian Gulf, limitations and obstacles to the reliable collection and distribution of potable water has necessitated the use of seawater desalination systems for defense, industrial, and commercial developments across Pacific Island Countries and Territories (PICT). The following chapter describes the technology used in desalination plants, the history of deployment in PICTs, features of selected applications across the three regional areas, and challenges in the use of desalination to enable economic activity and reduce pressure on freshwater resources.

8.2 Overview of Desalination Technology

8.2.1 Description

The objective of the desalination process is to remove salts and other molecules that form the Total Dissolved Solids (TDS) content in untreated water sources to an upper limit of 1000 mg/L, which is the World Health Organization's (WHO) acceptable limit for potable water (World Health Organization 2011). In seawater desalination plants, the TDS of the feedwater ranges from 33,000 to 45,000 mg/L depending on the location and is typically reduced to less than 500 mg/L for municipal water applications and less than 20 mg/L for industrial applications (Australia National Water Commission 2008). In municipal applications, the desalination process is followed by additional treatment, including chemical stabilization to adjust the TDS to match the local drinking water supply and prevent corrosion or damage to the distribution system and disinfection for pathogen control in the potable supply.

The two main desalination processes used in PICTs include thermal distillation systems and the pressure driven reverse osmosis membrane systems (Australia National Water Commission 2008). Both processes are energy intensive and offer direct water-energy nexus interaction and trade-offs to be managed according to energy requirements and cost per liter of production considerations for water use. The following section describes the technical features of these systems, beginning with the thermal process which was first used in the Pacific prior to the widespread use of membrane systems in the 1970s.

8.2.2 Thermal Desalination

Thermal processes are the oldest form of desalination technology which separates based on differences in vapor pressure between water molecules and the dissolved salts (Australia National Water Commission 2008). Thermal energy is used to break hydrogen bonds between water molecules and effect a change of phase from the liquid to vapor state. Dissolved salts are retained in solution while the vapor is removed and then condensed with negligible levels of TDS (Australia National Water Commission 2008). Thermal desalination plants are typically co-located with power generation facilities and utilize the waste heat from the turbines (Australia National Water Commission 2008). However, in smaller application, diesel engines or mechanical compressors are used to generate the thermal energy. Consequently, the technology has been deployed at scales ranging from less than a megalitre per day (ML/d) to over 400 ML/d. Thermal desalination facilities were first utilized to deliver drinking water to metropolitan centers in the 1950s, and by the turn of the twenty-first century, they had processed 70% of worldwide desalted water capacity (Australia National Water Commission 2008).

Thermal desalination systems used in PICTs include Multi-Stage Flash (MSF), distillation Multiple Effect Distillation (MED) and Mechanical Vapor Compression MVC.

8.2.2.1 Multi-Stage Flash Desalination System

Multi-Stage Flash (MSF) distillation uses a series of chambers operating at progressively lower temperatures and pressures (Australia National Water Commission 2008). Each chamber has three sections (Fig. 8.1a): a bottom where seawater is heated and forced to flash into steam; a top section containing a bundle of the tube heat exchangers where the vapor collects and condenses; and a middle a distillate collection chamber, located directly below the heat exchangers (Australia National Water Commission 2008).

Seawater enters the system through the heat exchangers in the last chamber and is progressively heated by the hot vapor before the temperature is boosted by the external source to achieve the final top brine temperature (TBT), typically 90 °C to 115 °C. High temperature and low-pressure force the brine water to boil violently and is instantly vaporized into steam, which rises rapidly to the top of the chamber. It passes through demister pads to remove entrained brine, and then is condensed on the outer surface of the tube heat exchanger and flows in the opposite direction via the collection trough (Australia National Water Commission 2008).

The first desalination systems installed in the Pacific in the 1960s used MSF technology. The equipment was supplied as skid-mounted, self-contained systems that were easily transported, and installed on concrete pads or plinths to minimize construction costs (Fig. 8.2). MSF can operate as a “once-through” process which discharges brine directly into the ocean, or include additional recirculation pumps,

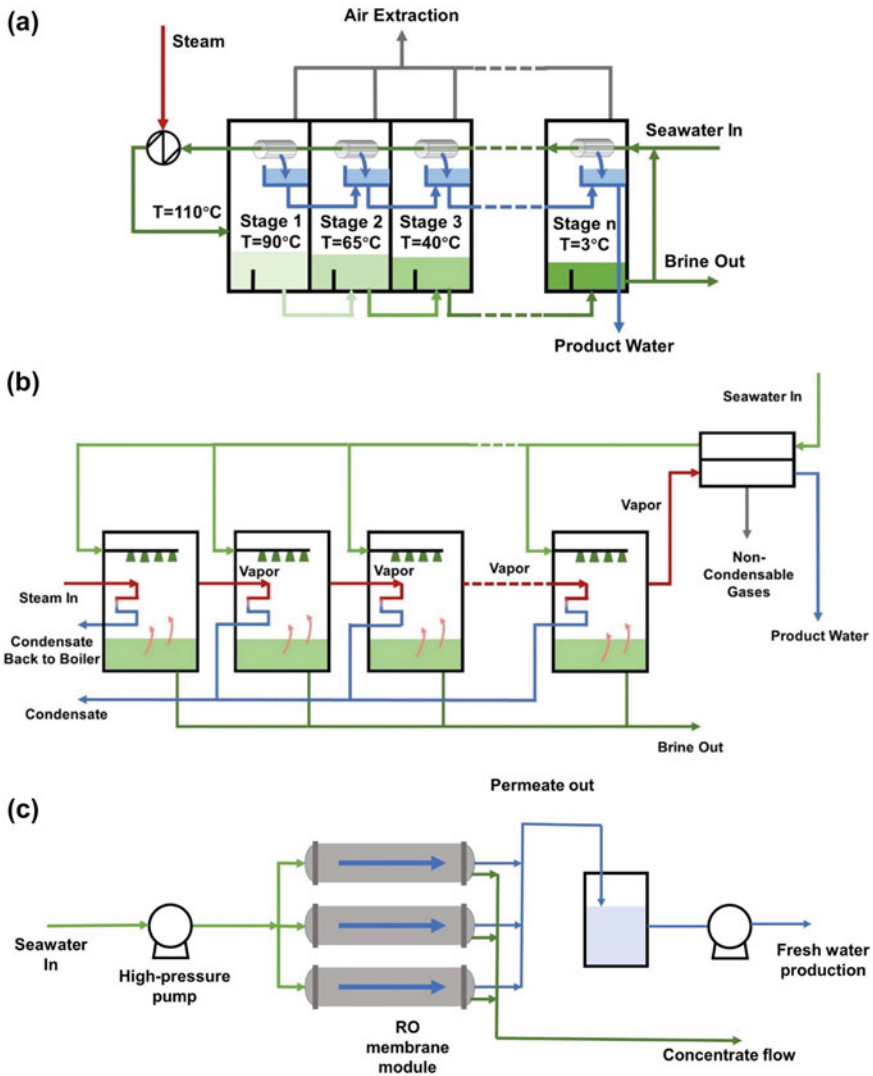

Fig. 8.1 (a) Multi-stage flash distillation, (b) multi-effect distillation and (c) reverse osmosis membrane system

to recycle and reprocess the brine which reduces consumption of antiscalant and anti-foaming agents, thereby reducing operational costs (Australia National Water Commission 2008).



Fig. 8.2 An 817 m³/d flash evaporator c.1970 (© Tom Pankratz)

8.2.2.2 Multiple Effect Distillation Desalination System

Multiple effect distillation (MED) also use a series of chambers divided into three sections, however, unlike MSF, evaporation occurs when a seawater film meets the heat transfer surface, and “flashes” in each chamber to form the vapor (Australia National Water Commission 2008; Nannarone et al. 2017) (Fig. 8.1b). The objective of having several chambers at lower pressures is to enhance energy recovery in the vaporization condensation cycle and take advantage of the decreased heat needs for vaporization. The use of Thermal Vapor Compression (TVC) can increase the velocity of the steam flowing on the interior of the tube, as an alternative to increasing the surface area of the heat exchanger to improve the heat transfer efficiency (Nannarone et al. 2017). The inclusion of TVC increases the mechanical complexity of the distillation plant but decreases the size and improves efficiency. Like MSF, MED systems are modular and have been installed in offshore operations (Fig. 8.3) and were widely used in the Caribbean in applications similar to those in PICTs (Figs. 8.4, 8.5, 8.6, 8.7 and 8.8).

8.2.2.3 Mechanical Vapour Compression Desalination Systems

Mechanical Vapour Compression (MVC) distillation is a technique using mechanical energy as the main driving force instead of steam as the primary source of thermal energy (Tleimat 2010).



Fig. 8.3 A 768 m³/d offshore MED-TVC c.2000s (© Tom Pankratz)



Fig. 8.4 A Caribbean MED (no TVC) c.1986 (© Tom Pankratz)

MVC evaporator-condensers progressively increase the temperature of seawater through a series of tubular heat exchangers until water vapor condenses on the upper surface of the tube which cause seawater on the other side of the tube to evaporate which allows water vapor in the tube to condense as permeate. The smallest MVC systems are generally single effect units that operate at a temperature of 102 °C and pressure slightly above the atmospheric pressure (Australia National Water Commission 2008).



Fig. 8.5 A Caribbean MED-TVC c.1971 (© Tom Pankratz)

Fig. 8.6 A Caribbean MVC in 1960s–1990s (© Tom Pankratz)

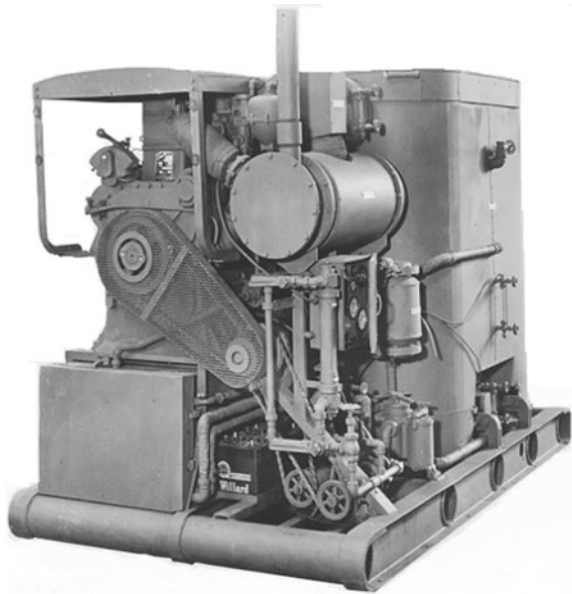

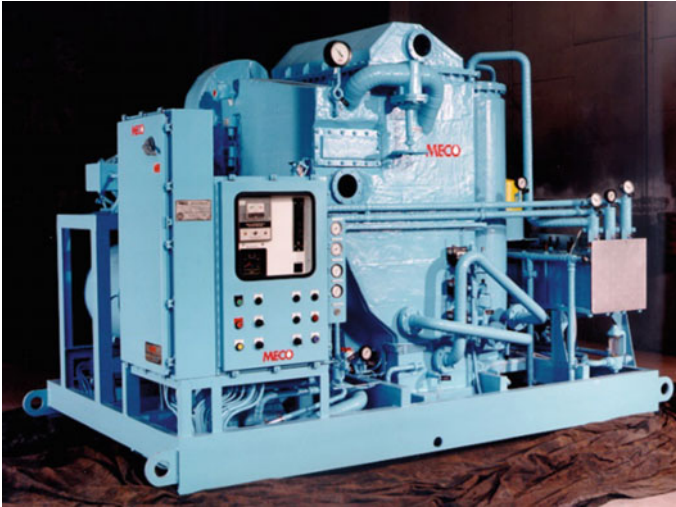

Fig. 8.7 An island/offshore MVC c.1985 (© Tom Pankratz)



Fig. 8.8 A larger Caribbean MVC c.1985 (© Tom Pankratz)

8.2.2.4 Reverse Osmosis

Reverse osmosis (RO) is a member of the family of pressure driven, liquid phase membrane separation processes. Mechanical energy supplied by a pump raises the feed pressure above the osmotic pressure of the seawater which moves water

molecules across a semipermeable polymeric membrane at a faster rate than the dissolved salts (Truby 2008). In a RO system, the flow of feedwater across the membrane surface is tangential to the flow of product water (permeate) which passes across the membrane (Fig. 8.1c). Unlike thermal processes that produce near distilled quality water, the separation efficiency and product water quality of the RO process depends on the type of membrane, the concentration of salts in the feedwater, and the permeate flow rate. The ratio of the feedwater flow to the permeate flow is referred to as the process recovery. Increasing the recovery increases the concentration in the feedwater and the osmotic pressure, which decreases the net pressure driving and decreases permeate flowrate. The optimum recovery rate for RO in seawater desalination applications ranges from 40 to 50%. RO membranes are cast as flat sheets that are sandwiched between a mesh feed spacer on the top and a woven permeate spacer on the bottom. The membrane sheets are assembled into a spiral wound configuration with sealed edges to separate the feed and permeate channels. Spiral wound elements are arranged in series inside pressure vessels. The inlet of the pressure vessel is connected to the discharge of the high-pressure pump, with two outlets at the end of the pressure vessel to collect concentrate salt stream (brine) and the permeate stream. Pressure vessels used in seawater desalination applications typically contain between six and eight elements.

Reverse osmosis plants, unlike thermal desalination plants, require a pretreatment step to remove material from the feedwater that can block the feedwater channels and foul the membrane surface. The feedwater channels in spiral wound membranes range from 0.07 to 0.08 mm, therefore a filtration step using granular media or membrane filtration is required to remove fine particles. Chemical addition is also required to prevent inorganic scale formation on the membrane and periodic chemical cleaning is required to restore membrane permeability. Consequently, while RO is at least four times more energy efficient than thermal processes, the processes have higher consumable costs (membranes and chemicals) (Australia National Water Commission 2008). Notwithstanding this, RO has replaced thermal processes as the preferred technology for seawater desalination in PICTs due to the simplicity of design and operation and the lower capital costs.

8.3 History of Desalination in the Pacific

The following section was based on analysis of a database of desalination plants produced by global water intelligence. The database was accessed with license in 2020 and contained information of the year of construction, location, capacity, and technology of the desalination plants in the Pacific (Global Water Intelligence Desalination Database 2020). The information was analyzed by geographic regions and communities.

8.3.1 *Polynesia*

Modern desalination plants were first deployed in Polynesian countries with use in military, industrial, and commercial applications. Deployment of the technology can be divided into three waves: 1966–1968, 1983–1998, and 2016–2017 (Global Water Intelligence Desalination Database 2020). In 1965 the first MSF plant was installed on Hao Atoll by the French military, followed by the installation of an additional 15 thermal desalination plants on Hao and Mururoa Atolls. Overall, the cumulative thermal desalination capacity installed in Polynesia was approximately 8600 m³/day with plant capacities ranged from 121 m³/day to 1200 m³/day (Table 8.1; Fig. 8.9). Commencing in 1968, 13 MSF facilities were constructed over seven years to produce industrial grade (TSD < 10 ppm) water (Global Water Intelligence Desalination Database 2020). These facilities were built to support the French military base on Hao Atoll, housing personnel working on the nuclear test program on Mururoa Atoll. When atomic testing ceased in 1996, and French military activity in the area came to an end in 1998, the region saw a new wave of RO desalination projects to supply drinking water to tourist facilities (Global Water Intelligence Desalination Database 2020). By 2020 the total cumulative capacity of RO plants was 650 m³/day and ranged from 0.65 m³/day and 200 m³/day respectively. A municipal level drinking water facility was built in Rangiroa, French Polynesia in 1998, and was able to conveniently supply the nearby Hotel Kia Ora Resort. The first desalination facility exclusively supplying tourist facilities in Polynesia was operational in Tahiti in 2008 (Global Water Intelligence Desalination Database 2020).

8.3.2 *Micronesia*

The first Micronesian desalination facility was a 114 m³/day MED plant built in 1973 on Saipan, Northern Mariana Islands for a resort (Table 8.1; Fig. 8.9).

Additional plants were installed in two waves between 1990 to 2017. A total of 32 RO desalination plants were established, mainly in Northern Mariana Island and Tuvalu, with a total aggregated capacity of 9970 m³/day. Plants ranged in size from 10 m³/day to 1600 m³/day (Global Water Intelligence Desalination Database 2020). The market for desalination in Micronesia has been driven by the tourism sector, including several championship golf courses, with the exception of a 1200 m³/day MED plant installed in 1993 for industrial applications. Facilities on the island used predominantly seawater as their feedwater, though some facilities made use of brackish and inland water sources. Municipal drinking water facilities were also installed in 1995 and 2001 on Saipan, and on Rota Island in 1995, but the tourism industry remains the dominant consumer of desalinated water in the Northern Mariana Islands where the largest plant has three times the capacity of the municipal plant. In addition to plants in the Northern Mariana Islands, a dedicated membrane

Table 8.1 Summary of desalination plant installation history in Polynesia, Micronesia, and Melanesia located in Pacific Region with data accessed from DesalData

Region	Polynesia	Micronesia	Melanesia
<i>First plant</i>			
Year of installation	1965	1973	1990
Location	Hao, Tuamotu Archipelago	Saipan, Northern Mariana Islands	Mamanuca Island, Fiji
Application	Military support	Tourism	Tourism
Technology	MSF	MED	RO
Capacity (m ³ /d)	165	114	50
<i>Total plants</i>			
Installations—Total	22	34	21
Applications—Total	Municipal drinking water (11) Industry (9) Tourism (1)	Municipal drinking water (15) Tourism (14) Emergency (3)	Tourism (10) Municipal (8) Industry (3)
<i>Thermal desalination</i>			
Installations	16	2	0
Total capacity (m ³ /d)	8600	1314	-
Max. Capacity (m ³ /d)	1200	1200	-
Min. Capacity (m ³ /d)	121	114	-
Active Plants	0	0	-
<i>RO</i>			
Installations	6	32	21
Total capacity (m ³ /d)	5500	9970	7150
Max. capacity (m ³ /d)	200	1600	100
Min. capacity (m ³ /d)	0.65	10	2.5
Active plants	6	28	19
Database with license (Global Water Intelligence Desalination Database 2020)			

desalination facility supplying drinking water to tourist facilities was installed in 1999 in Kiribati (Fraser Thomas Partners 2012).

Desalination projects at the municipal level outside the Northern Mariana Island can be found in Nauru and Palau. The Aiwo District of Nauru installed a MED thermal desalination facility in 1993, the largest plant ever installed in the region, to supply municipal drinking water, while in 2016 a municipal desalination facility was installed to supplement rainfall and groundwater, the island's other sources of drinking water (SOPAC Water and Sanitation Programme 2018).

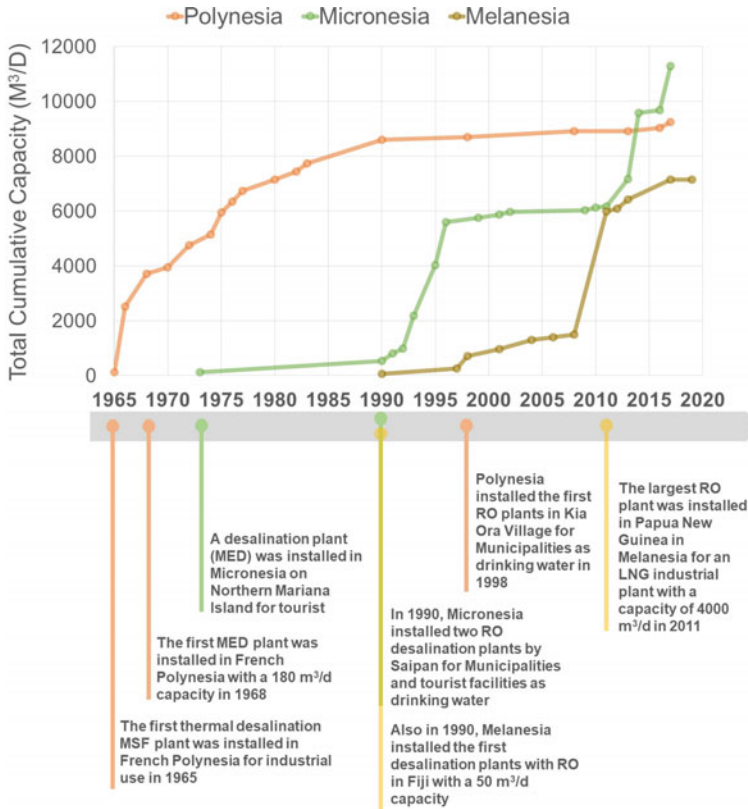

Fig. 8.9 Total cumulative desalination plant capacity in Polynesia, Micronesia, and Melanesia with data accessed from DesalData Database with license (Global Water Intelligence Desalination Database 2020)

The Marshall Islands are located near the equator in the Pacific Ocean, part of a larger group of islands in Micronesia. It is the most densely populated island in the Pacific Ocean and is almost entirely dependent on desalinated seawater to meet its freshwater demands. Kili, Utrik, and Ebeye, located on Marshall Island, installed RO membrane desalination systems in 2014 and 2017, to provide residents with a stable and sufficient source of freshwater (SOPAC Water and Sanitation Programme 2018). Prior to the installation of the facility, residents of the site suffered not only from drought but also from groundwater contamination. The entire plant can be powered by wind and solar energy, saving tens of thousands of dollars in fuel costs each year (Fraser Thomas Partners 2012). In addition, with increasingly expensive fuel and unreliable supplies caused by seasonally choppy seas, the alternative energy power system ensures a continuous, affordable supply of water.

8.3.3 *Melanesia*

Installations of desalination facilities in Melanesia began relatively late compared to Polynesia or Micronesia. The region's facilities have exclusively employed RO. The first facility had a capacity of 50 m³/day and was installed on Castaway Island in Fiji in the late 1980s. By 2020 the total capacity was estimated to be 7150 m³/day. The largest installation is a RO plant with a capacity of 4000 m³/day installed in an industrial application in Papua New Guinea (PNG). The plant was installed in 2011 following work by the Government of Papua New Guinea. Since the 1990s, several oil and gas companies have studied the feasibility of developing a natural gas plant in the country to commercialize natural gas resources for export as liquified natural gas (LNG) to customers around the world (Global Water Intelligence Desalination Database 2020). The RO desalination plants established at the site are for industrial use for the PNG LNG project awarded by the Chiyoda and JGC joint venture. The smallest desalination plant in the region is a plant with a capacity of 2.5 m³/day in a hospital in the Solomon Islands. The plants were installed in 2017 and 2019 at the Youth With A Mission (YWAM) training center in Samarae Maternal Clinic and a hospital in Honiara. They use solar-powered desalination units, aiming to provide adequate freshwater resources for residents, patients, fishermen, staff, and clinical use (Pacific Island Forum Secretariat 2018).

Other facilities in Melanesia are in Fiji and Vanuatu. Fiji has established total 15 desalination plants, accounting for approximately 70% of all desalination plants in Melanesia. Tourism represents around 40% of Fiji's GDP in a given year. The nation's dependence on the industry is reflected in the number of desalination facilities dedicated to drinking water for tourist facilities (Weber 2007).

In Vanuatu, a 96 m³/day desalination plant was installed on Ambae Island at the Lolowai Medical Center in 2013 to supplement the island's water supply (Global Water Intelligence Desalination Database 2020). The plant is also designed to provide water to more than 10,000 people on the island in case of an emergency. Due to the high cost of fuel and logistical difficulties, the RO plant was installed with a solar power system to save fuel.

8.4 Desalination as a Driver of Economic Development

The availability of reliable fresh water is essential for developing economies (Davies and Mirti 2005). This section considers examples of initiatives to expand economic activity and the attendant need for desalination to supplement available water supplies.

8.4.1 Nauru

The Republic of Nauru (area 22 km²) is an isolated, elevated limestone island located 41 km south of the equator (South Pacific Applied Geoscience Commission 2007).

Nauru's economic income has traditionally come from phosphate exports, but reserves are expected to be depleted within a few years (South Pacific Applied Geoscience Commission 2007). Nauru has virtually no agriculture and no tourism-related economic income. Phosphate mining, which used to be the main economic activity, has turned central Nauru into a wasteland because of over-intensive excavation (South Pacific Applied Geoscience Commission 2007). Because the mined land is now unusable, rehabilitation of the mines and alternative income from phosphate, as well as adaptation to climate change, are challenges for the sustainable development of their country. Nauru plans to rehabilitate land that was mined and repurpose it for agricultural use over the next 20 to 30 years (South Pacific Applied Geoscience Commission 2007). This could provide Nauruan with fresh fruits and vegetables, which are generally in short supply, and ensure national food security (Chap. 4). There will be greater demand for water for agriculture, which will involve a very high demand for groundwater resources. The use of alternative water sources, such as desalinated seawater for irrigation, could allow the region to maintain adequate water supply needs during drought conditions.

The main water sources include rainwater, shallow groundwater, imported water, and desalinated water (South Pacific Applied Geoscience Commission 2007). Potable water is collected in rainwater tanks on the roofs of residential and commercial buildings, while non-potable water is obtained from boreholes in the homes of island residents. Shallow groundwater is the primary aquifer between rainy seasons. However, seawater ingress due to over-pumping, coupled with the percolation of wastewater from homes, stores, and commercial buildings is having an adverse effect on water quality (SOPAC Water and Sanitation Programme 2018).

There is one large evaporative desalination plant and four small RO desalination plants on the island. A large desalination plant previously built on the island, which could use waste heat from power generation for desalination, was commissioned in 1992 (South Pacific Applied Geoscience Commission 2007). However, due to the age of the generators, they operate at less than maximum capacity, resulting in a lower waste heat output, causing a decrease in desalination capacity. According to the statistics, just 3% of the possible output was supplied to customers in 2005/2006 owing to a scarcity of water tankers (South Pacific Applied Geoscience Commission 2007).

To address the high energy demand of desalination plants, the use of renewable energy is a viable option. Nauru supplied and installed a grid-connected solar power system and a reverse osmosis plant in 2013, providing a daily treatment capacity of 100 m³ of water (Pacific Island Forum Secretariat 2018). Not only are the operation and maintenance costs low, but the performance and energy efficiency are also high.

8.4.2 Kiribati

The Republic of Kiribati is a tropical atoll nation located between the central and western Pacific Ocean and consists of 32 low-lying coral islands and three main islands (Fraser Thomas Partners 2012).

Kiribati's income is derived from agriculture, industry, fishing, and foreign exchange, with relatively little tourism (Fraser Thomas Partners 2012). The country's export revenue comes from the sale of fishing rights in its vast national waters, exports of copra and seaweed, and remittances from overseas Kiribati. Overseas revenue also comes from the sale of fishing licenses to other countries (Fraser Thomas Partners 2012).

Kiribati has no perennial surface water flow, and its water resources are limited to shallow unconfined groundwater, rainwater, imported water, or desalinated seawater. Rainfall is closely related to the location of the Pacific warm pool which is controlled by the seasonal movements and annual variations of the Intertropical Convergence Zone and the Equatorial Low-Pressure Zone (Fraser Thomas Partners 2012). The country's average annual rainfall ranges from 1,300 mm south of the equator to 2,000 mm in Tarawa, with the northernmost islands exceeding 3,200 mm, while the eastern Lain Islands, Kiritimati averages less than 1,000 mm per year (Fraser Thomas Partners 2012). Kiribati has been using rainwater harvesting techniques for many years, but it is seen as a supplementary water source at best. Shallow fresh groundwater is highly susceptible to natural and anthropogenic changes (Chap. 2) and is more susceptible to rainfall variability and over-extraction. Storm surges, droughts, and overexploitation lead to seawater intrusion (Chap. 10).

Five desalination plants have been established in Kiribati over the past seven years in communities that are entirely reliant on rainwater harvesting due to the absence of surface water or the high salinity of groundwater. These desalination plants require a reliable power supply and on-going maintenance which is difficult to sustain in small, isolated rural island communities. Consequently, only one desalination plant is partially operational on Barnabas Island (Fraser Thomas Partners 2012).

The capital of Kiribati, South Tarawa, located on Tarawa Atoll in the Gilbert Islands has a population of 62,000 residents (43.5% of the population) of South Tarawa (Fraser Thomas Partners 2012). South Tarawa rely on rainwater as a primary supply use saline or contaminated groundwater as a reserve water source.

On November 19, 2020, a grant agreement of nearly \$42 million was signed to help improve the water supply for the people of South Tarawa (Asian Development Bank 2020). The project addresses the issue of waterborne diseases by providing new, climate-resilient water supply infrastructure including a desalination plant with a maximum capacity of 6000 m³/day, along with water, sanitation, and hygiene awareness programs. The construction of a solar desalination plant will be central to making South Tarawa's water supply more resilient to climate change (Asian Development Bank 2020).

The most significant impacts of the project will be health benefits and the expected decrease in infant mortality due to diarrheal disease. The installation of solar photovoltaic cells will provide a steady supply of water to customers and will create a network of reliable and dependable sources of drinking water (Pacific Island Forum Secretariat 2018). Solar energy will also help to minimize greenhouse gas emissions by generating energy using renewable energy sources rather than burning fossil fuels. Indirect greenhouse gas reductions will also be achieved by providing uncontaminated, high-quality water, which will ultimately reduce the need to burn fossil fuels to produce water that boils to make it suitable for energy consumption. Rehabilitation of the existing water supply network will reduce the level of non-revenue water use and improve the performance of the pumping system. This has an indirect positive impact by reducing the amount of energy needed to produce and deliver water to all customers.

8.4.3 *Uleveu Island—Vanuatu*

The Republic of Vanuatu is located in the Western Pacific Ocean and its islands are formed by raised limestone and volcanoes. The population is approximately 200,000, 80% of which is still rural. The main economic sources of this country are agriculture, fishing, forestry, and tourism. Agriculture products, particularly fruit, cocoa, coffee, and dried coconuts, are the main economic exports, while tourism is second only to agriculture in importance to the country's economy. Tourism is concentrated in Port Vila and some of the outer islands (Nath et al. 2006a).

In urban areas of Vanuatu, the main water resource is groundwater, while in rural areas, sources can be wells, springs, rivers, and rainwater. Average rainfall in the area varies from 4000 mm per year in the north to 1500 mm per year in the southern islands (Nath et al. 2006a). The rainy season is from January to March and the rest of the year is the dry season. Rivers and streams are common on the larger islands, but their flow is also seasonal. In addition, the quality of surface water is often polluted from upstream sources (Nath et al. 2006a).

While urban water quality is generally good in Port Vila and Luganville, in rural areas most water supply comes from surface water, rainwater, and groundwater. Also, in most places outside of the major urban centers, water supply systems are either poor or non-existent, for example, the island of Uleu, located within the Vanuatu archipelago, with a population of over 1800 people (Vanuatu's National Advisory Board on Climate Change and Disaster Risk reduction 2012). Contamination of drinking water is primarily bacterial, usually by bacteria from human or animal excrement (Nath et al. 2006a).

In 2012, a solar solution was proposed that was suitable for powering a desalination plant located near the Sangali School on the north side of Uleu Island (Vanuatu's National Advisory Board on Climate Change and Disaster Risk reduction 2012). The system is designed to provide up to 3000 L of water per day during the dry season. With the addition of the water storage facility, the new system can provide

4 L of water to each of the 1500 residents (Vanuatu's National Advisory Board on Climate Change and Disaster Risk reduction 2012). The solar panels that drive the desalination system generate excess solar energy that can be used to make ice, as a secondary product to fund plant maintenance, which is used to keep the fish in the market cool and extend the fishing time by a few days.

8.5 Barriers to Development and Future Projections

Desalination has the potential to supplement water supplies across Polynesia, Micronesia, and Melanesia. While the challenges around desalination in larger urban centers are well understood, deployment of the technology at the local scale will require co-development of energy supplies, water distribution infrastructure, capacity, and training. More importantly, the solutions must be linked to broader community development including economic activity. The following section considers the barriers that must be overcome for wider use of desalination.

8.5.1 Energy

Seawater desalination is energy intensive, typically requiring a minimum of 3.5 kWh/m³ of water produced (García-Rodríguez 2003). The power required by large desalination plants may be offset by the installation of renewable power; however, continuous operation requires connection to a stable, grid supplied power source. However, in small applications, particularly for plants operating below 10–50 m³/day a few types of renewable desalination systems have been implemented and piloted in the Pacific. The outcome of the pilot studies was to reduce technical risks that have historically limited continuity of power supply and thus availability of treatment capacity which is needed to improve commercial viability (Davies and Mirti 2005). The following section considers four sources of renewable energy that can be used to directly power desalination plants in the Pacific.

Concentrated solar power (CSP) cogeneration is a technology that uses solar irradiation to generate thermal energy for use in turbines to generate electricity. CSP stores heat at a relatively low cost and maintains the plant in operation during evening peak load hours, which is one of its main advantages. When used in conjunction with a desalination system, heat from the CSP unit can be ejected from the low-pressure turbine and delivered to the brine heater instead of being expanded in a further low-pressure turbine (International Renewable Energy Agency 2015).

Photovoltaic (PV) technology converts solar radiation directly into electricity with PV cells made of semiconductor materials, through which an electric current is generated when exposed to the sun. As the temperature increases, the efficiency of PV cells decreases, so dense PV systems require active cell cooling. This heat can be used for different purposes. Considering the electrical and thermal output,

the overall efficiency can be around 80%. Photovoltaic systems can be directly integrated RO systems; however, the capacity is limited (typically less than 10 m³/day) (International Renewable Energy Agency 2015).

Wind energy is usually converted directly into mechanical energy, and it can be mechanically combined with a desalination system such as RO. To accommodate wind fluctuations, electrical or mechanical energy storage can be integrated into a wind desalination system using flywheels, for example. Wind energy is a proven technology that has proven to be economically viable in combination with desalination systems (García-Rodríguez 2003).

Tidal energy captured from rising and falling tides is converted into electricity by turbines connected to generators. However, because almost all ocean energy technology systems are in the pilot plant or prototype stage, the technology is not yet mature or economically competitive. The lesser-known Ocean Thermal Energy Conversion (OTEC) is the most promising ocean energy extraction method for desalination energy needs (International Renewable Energy Agency 2015). As it is developed and costs are low, it may attract more attention in the coming years.

8.5.2 Water Distribution and Transport

Currently, there are still barriers to water transport in PICTs. In Nauru, for example, the water network serves only a very small area and both the pipeline network and storage tanks have seen continued deterioration and lack of maintenance. Consequently, water produced by desalination plants is usually transported by water tanker trucks to individual homes and other storage tanks. However, due to the lack of tanker trucks, only a small percentage of their output is delivered to consumers (South Pacific Applied Geoscience Commission 2007).

In order to improve the water supply structure on the islands, the aging water pipeline network needs to be repaired or replaced. It is also necessary to expand the service area of the network so that the rural population also has access to fresh and safe water through the piped water network. Additional tanker trucks for water on the island are needed after the installation of desalination facilities to transport the actual amount of water produced to consumers and increase market demand and supply.

8.5.3 Human Skills and Capacity

Each island has a different infrastructure capacity and labor market capacity, which means that desalination projects need to be set up on an island-by-island basis. Low construction capacity and lack of labor can lead to failure in setting up projects, making the already high initial investment a significant barrier for economies without the necessary financial means. This means that staff recruitment and training are factors that affect the continued deployment of renewable desalination. Advances in

desalination technology are unlikely to be achieved through breakthrough technological pathways at this time; instead, their operational and economic efficiency will be improved through multidisciplinary optimization and capacity building (Nath et al. 2006b).

Training for construction and ongoing operation and maintenance of desalination systems can be conducted at universities or central training institutions through local workshops. Consideration must be made where a lack of basic education of the staff to be trained exists and where English is not a first language. These must be addressed through country-tailored training programs that include hands-on experience and workshops, and the use of training materials and languages appropriate to the competencies and educational background of the personnel concerned (Nath et al. 2006b).

8.5.4 Economic Factors

Desalination systems require a significant capital investment, typically \$3–4/L of installed treatment capacity. The decision to invest must be supported at the political level and have sufficient administrative resources to ensure that the plants operate at capacity over the life of the asset. According to the World Health Organization, an investment of \$1 in water supply and sanitation yields a return of \$2.80 in developed countries and \$6 in developing countries (International Renewable Energy Agency 2015). The decision to invest in desalination plants over alternative options for the development of reliable water supplies cannot proceed without ensuring reliable energy supplies. As the cost of fossil energy increases, and the cost of renewable energy and desalination technology decreases, the economic return on investment in renewable desalination on islands is likely to rise. The main cost of deploying renewable desalination on small islands is due to energy storage, compared to islands with large grids that use traditional desalination methods. Unless the cost of energy storage decreases significantly in the future (Chaps. 12 and 18), the cost competitiveness of renewable desalination will remain weaker than the cost of freshwater production with conventional water supply infrastructure (International Renewable Energy Agency 2015).

8.6 Conclusion

Historically, the development of desalination systems in the Pacific has been tied to military, industrial, and tourism projects. Most plants in the Pacific use reverse osmosis, which is a mature technology, but requires reliable supplies of power and is attended by ongoing operating and maintenance costs. Consequently, the development of desalination as a supply of municipal water has most utility in the capital

cities and major population centers when linked to the development of other infrastructure. In rural areas, desalination systems linked to solar and renewable energy are emerging; however, the scale is not suitable to address water supply for food security.

References

- Asian Development Bank (2020) ADB and Kiribati sign grant for project for safer water. Asian Development Bank
- Australia National Water Commission (2008) Emerging trends in desalination: a review, [electronic resource] Canberra, ACT, National Water Commission
- Davies S, Mirti AV (2005) Drinking water quality in the Pacific Island Countries: situation analysis and needs assessment. SOPAC Joint Contribution Report 18
- Fraser Thomas Partners (2012) South Tarawa sanitation improvement project TA-7359(KIR): South Tarawa water supply options assessment desalination feasibility study. Pacific Region Infrastructure Facility, Government of Kiribati and Asian Development Bank
- García-Rodríguez L (2003) Renewable energy applications in desalination: state of the art. *Sol Energy* 75:381–393
- Global Water Intelligence Desalination Database (2020) Global water intelligence desal data/International Desalination Association [license]. Global Water Intelligence
- International Renewable Energy Agency (IRENA) (2015) Renewable desalination: technology options for islands. International Renewable Energy Agency
- Nannarone A, Toro C, Sciubba E (2017) Multi-effect distillation desalination process: modeling and simulation. In: *Proceedings of Ecos 2017—the 30th international conference on efficiency, cost, optimization, simulation and environmental impact of energy systems July 2–July 6, 2017, San Diego, California, USA*
- Nath D, Mudaliar M, Loan C (2006a) Water safety plant—water supply description assessment—Vanuatu. In: *South Pacific and Asia conference (SOPAC). Water Safety Plans Programme*
- Nath D, Mudaliar M, Parakoti B (2006b) Water safety plan water supply system description cook islands. In: *South Pacific and Asia conference (SOPAC). Water Safety Plans Programme*
- Pacific Island Forum Secretariat (2018) Pacific environment community consolidated regional report 2018. Pacific Island Forum Secretariat
- SOPAC Water and Sanitation Programme (2018) Desalination for Pacific Island countries. UN Climate Technology Centre and Network (CTCN). SOPAC Water and Sanitation Programme
- South Pacific Applied Geoscience Commission (2007) National integrated water resource management diagnostic report—NAURU. SPREP LIBRARY. In: *South Pacific and Asia conference (SOPAC). Integrated Water Resource Management (IWRM)*
- Tleimat B (2010) Thermal desalination processes, encyclopedia of desalination and water resources
- Truby RL (2008) Seawater desalination by ultralow-energy reverse osmosis. In: Li NN, Fane AG, Ho WSW, Matsuura T (eds) *Advanced membrane technology and applications*. Wiley, New York, pp 87–100
- Vanuatu's National Advisory Board on Climate Change & Disaster Risk Reduction (2012) Solar powered desalination system Uleveu Island—Vanuatu. National advisory board: Government of Vanuatu
- Weber E (2007) Water in the Pacific Islands: case studies from Fiji and Kiribati. In: Grover VI (ed) *Water: a source of conflict or cooperation?* Enfield: Science Publishers, Inc
- World Health Organization (2011) Guidelines for drinking-water quality. World Health Organization

The opinions expressed in this chapter are those of the author(s) and do not necessarily reflect the views of the UNESCO: United Nations Educational, Scientific and Cultural Organization, its Board of Directors, or the countries they represent.

Open Access This chapter is licensed under the terms of the Creative Commons Attribution-ShareAlike 3.0 IGO License (<https://creativecommons.org/licenses/by-sa/3.0/igo/>), which permits use, sharing, adaptation, distribution, and reproduction in any medium or format, as long as you give appropriate credit to the UNESCO: United Nations Educational, Scientific and Cultural Organization, provide a link to the Creative Commons licence and indicate if changes were made. If you remix, transform, or build upon this book or a part thereof, you must distribute your contributions under the same licence as the original.

The use of the UNESCO: United Nations Educational, Scientific and Cultural Organization's name, and the use of the UNESCO: United Nations Educational, Scientific and Cultural Organization's logo, shall be subject to a separate written licence agreement between the UNESCO: United Nations Educational, Scientific and Cultural Organization and the user and is not authorized as part of this CC-IGO licence. Note that the link provided above includes additional terms and conditions of the licence.

The images or other third party material in this chapter are included in the chapter's Creative Commons licence, unless indicated otherwise in a credit line to the material. If material is not included in the chapter's Creative Commons licence and your intended use is not permitted by statutory regulation or exceeds the permitted use, you will need to obtain permission directly from the copyright holder.



Chapter 9

Towards a Circular Logistics Partnership: Regional Trade, Waste, and Inter-Sectoral Cooperation



Simon Bennett, Anthony Talouli, and Vinayak V. Dixit

How Governance, Science and Business are successfully working together to reduce the build-up of waste and no-longer-wanted goods in the Pacific Islands Countries and Territories.

Abstract Trade in the Pacific connects economies and communities, but also relies on profitmaking transactions. An outcome of this is that waste and no-longer-wanted goods build up on island nations and if not properly managed are directly detrimental to water resources and communities, and indirectly to tourism-driven revenue, upon which many Pacific Island Countries and Territories (PICT) depend. The logistics of distances exacerbates these issues. Careful analysis and leveraging slacks in the logistics systems helps not only improve economic efficiencies through recycling, but also reduce in situ waste streams. However, implementation of a circular logistics system requires strong partnerships between Governance, Science and Business working together. This chapter details a case study in the PICT to load empty shipping containers with refuse for recycling when they are relocated back to the Pacific Rim for reloading with more finished goods for import to PICT. Building on the above, a proposed project to manage the disposal of the increasing numbers of end-of-life vehicles, batteries, and other light grade metals in the Pacific will also be described. This is notwithstanding that the preferred method of avoiding disposal by abandonment is to legislate for Extended Producer Responsibility (through extended Advanced Disposal Fee (ADF) schemes) to engineer the issue away at source.

S. Bennett (✉)
Swire Shipping Pte. Ltd, Singapore, Singapore
e-mail: simon.bennett@swireshipping.com
URL: <https://www.swireshipping.com>

A. Talouli
The Secretariat of the Pacific Regional Environment Programme, Apia, Samoa
URL: <https://www.sprep.org>

V. V. Dixit
Research Centre for Integrated Transportation Innovation, University of New South Wales,
Sydney, NSW 2052, Australia

© UNESCO 2024

A. Dansie et al. (eds.), *The Water, Energy, and Food Security Nexus in Asia and the Pacific*, Water Security in a New World,
https://doi.org/10.1007/978-3-031-25463-5_9

187

Keywords Waste · Circular economy · Basel · Rotterdam · Stockholm · BSR · Conventions · Public–private partnership · PPP · SPREP · Swire · Intersectional cooperation

9.1 Introduction

The Pacific Island Countries and Territories (PICT) are responsible for managing ~10% of the world's oceans, including a third of the Pacific Ocean. The logistics of distance and the lack of economies of scale, are compounding the issues of waste management in the PICT, wherein the wastes streams generated are beyond their capacity to manage. This is particularly more prominent in the case of plastics from packaging and/or designed as single use.

A large majority of the PICT (Fig. 9.1) are too small (in area or population) to justify financially viable recycling plants. The waste streams are often dumped in official, or unofficial, landfill dumping sites. However, the broader issue arises from the impact on the ecology and the changing climate (Chap. 5). The wastes are blown into the surrounding seas by extreme weather, such as storms and cyclones (which now occur in increasing and changing energy and frequency) that pass through the Pacific Islands. Wastes are then ingested by the marine life that the islanders rely on to survive and makes its way up the food chain to the Pacific Islanders. Recent studies show that microplastics have entered human digestive systems, and nanoplastics have entered the human blood system.

There are competent, licenced recycling plants around the Pacific Rim. But the small scale and low value of the waste streams *in situ* means that once all the additional costs of shipping to the Pacific Rim are factored in, it becomes a loss-making venture to send the waste to responsible recycling facilities (Chap. 10). Consequently, the waste remains on the PICT and:

- (a) Degrades the environment visually, reducing the tourism value.
- (b) May leach toxic chemicals into the marine and land environment, harming the people, flora and fauna locally.
- (c) Occupies often scarce land, that could have been better used for agriculture or for other economic production.

On realizing that Swire Shipping (formally The China Navigation Company [CNCo], which changed name to Swire Shipping Pte. Ltd. [SSL] on the 15th October 2021) (SWIRECNCO 2022) was contributing to the problem by transporting finished, packaged goods into PICT, Swire Shipping took the initiative in collaboration with the Secretariat of the Pacific Regional Environment Programme (SPREP) (SPREP 2022) to help resolve the issue. SPREP is the regional organization responsible for protecting and managing the environment and natural resources of the Pacific Island states. After significant analysis of the entire logistics systems, SSL determined that as it was repositioning the unloaded, empty containers back to the Pacific Rim (to reload more finished goods), it could also be a part of the solution by shipping waste

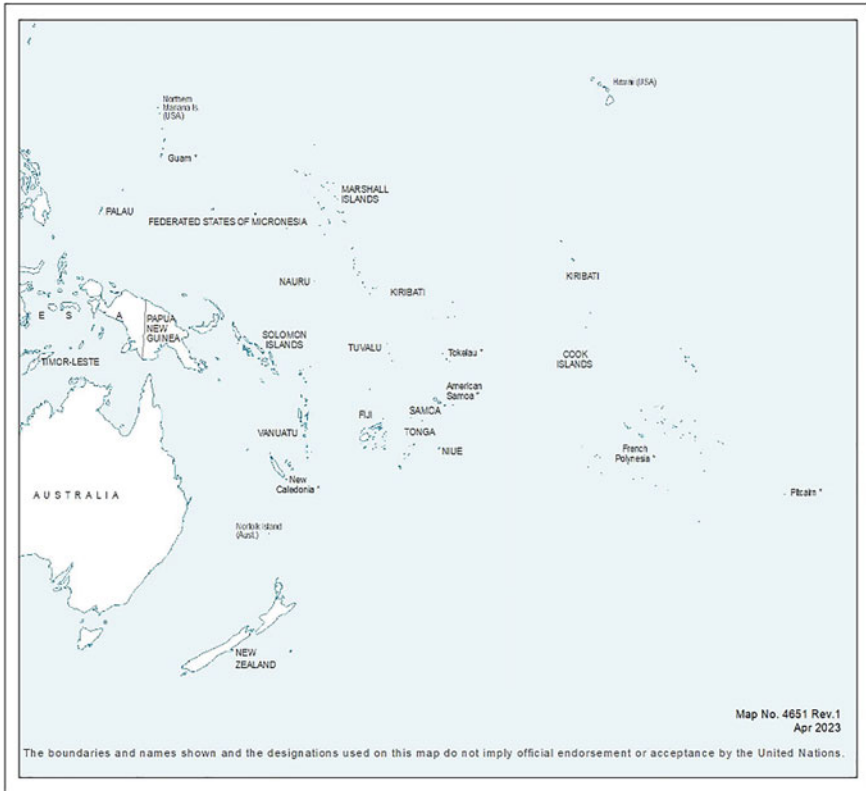

Fig. 9.1 Pacific regional map, adapted from UN Geospatial (2023)

that was collecting in the PICT back out to responsible, competent, licenced recycling plants. This realization led to the Moana Taka Partnership (Moana Taka Partnerships 2022).

Though there have been research studies in waste logistics for food rescue (Nair et al. 2016, 2017a, 2017b), no such research papers were found with respect to maritime waste logistics. Therefore, careful analysis of such case studies is particularly important. A particular barrier in PICT is the availability of data. Despite this, the systematic approach to leverage existing logistics operations towards improving sustainability is an important case study, that cannot only potentially secure other logistics operations in PICT towards similar goals, but also more broadly globally as part of a public-private Partnership.

9.2 The Problem

With increasing affluence and adoption of urban lifestyles, the 43.7 million people living in the Oceania region, which includes PICTs as well as Australia and New Zealand, naturally and rightly expect higher living standards (see Chap. 14). This typically demands more imported goods, which tend to be consumables, such as food, household goods, electronic goods, and vehicles, and this inevitably leads to an increase in the amount of waste produced.

The situation is further exacerbated by the fact that the PICTs are limited in size and population and have few financially viable options to properly process or recycle waste on the islands. This means that land taken up by the waste could potentially have been better used for agriculture or towards raising economic capacity locally.

The waste that goes to landfill may affect islanders' health due to air pollution, or seepage into precious groundwater. However even if it does not affect the air or groundwater, the waste entering the sea inflicts damage on marine biodiversity. Marine life is a critical and integral part of Pacific Island culture, to the extent that Mr. Kosi Latu (SPREP Director-General 01 April 2022) argued, "*if they're gone, part of our culture is also gone.*" Environmental damage by pollution from liquid and solid wastes is hypothesized to have led to a substantial economic loss for the region.

The third United Nations Environment Assembly (UNEA-3) took place in Nairobi, Kenya in December 2017. The main thematic cluster of UNEA-3 was the "Clean Planet Pledge" with specific reference to ocean plastics and how to prevent them. The messages of the presentations given during that session were very clear:

1. PICT are heavily impacted by waste from local and global sources, with high dependence on imported products and with small-scale markets far from overseas recycling centres.
2. The plastics present in the oceans and on land in the PICT were being imported:
 - i. as onshore waste carried down rivers and entering the region on ocean currents, *and/or*
 - ii. as "Ghost Nets": the 6% of all fishing nets, 9% of all traps, and 29% of all lines are lost abandoned or discarded from fishing vessels each year, *and/or*
 - iii. as garbage from cruise and other ships, *and/or*
 - iv. as legitimate cargo, such as packaging for finished goods being imported on container/cargo ships.
3. The stark and unavoidable conclusion was that, shipping companies and cargo carriers, were part of the problem and needed to find a way to be part of the solution

Furthermore, there are international conventions regulating the transboundary movement of waste to stop its dumping. These are principally the Basel Convention, and the local PICT version that also forbids transport and dumping of nuclear waste, the Waigani Convention (Waigani Convention 2022). However, these conventions do

not forbid the transboundary movement of waste but *do* seek to regulate it, such as to ensure that the waste streams are properly, responsibly, and competently handled at the destination country.

9.3 The Solution

Swire Shipping owns, operates, and manages around 50 general cargo and container-ships serving 14 deep-sea or international trade routes in the Pacific Ocean (Fig. 9.2).

Swire Shipping carries a material portion of the finished goods that are imported into the PICT. A large portion of these have plastic and other packaging that is removed and disposed of once the goods reach the ultimate end user. As nearly all of the PICT are too small (in area or population) to financially justify viable recycling plants, these plastic/packaging waste streams are often then dumped into official or unofficial landfill dumping sites, many of which are shallow areas remaining after building materials have been extracted.

Swire Shipping then repositions the newly emptied containers on ships heading out of the central Pacific, generally back to Pacific Rim countries, to be loaded for the next inward voyage. It was very obvious that the waste streams that had previously been unviable to ship out for processing (until such time that local recycling plants are established), could be carried to the best destination. The containers owned by Swire Shipping that are typically rented to shippers at a daily rate, were made available *pro bono*. The freight charge (on a Free In Free Out basis) was also waived as the

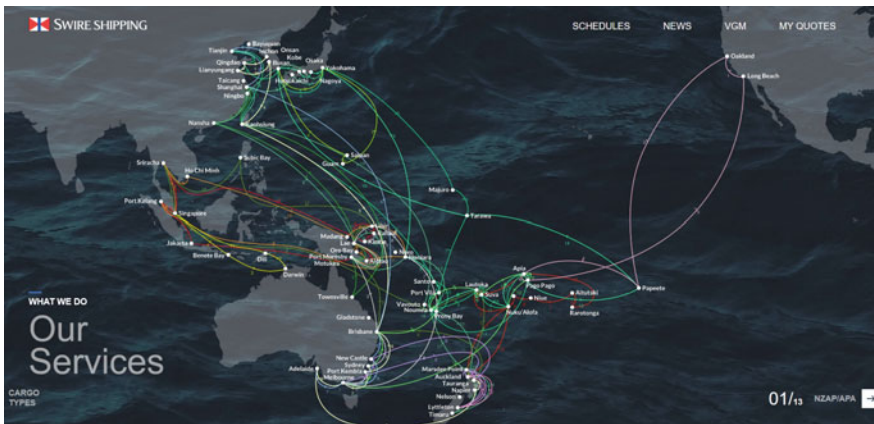

Fig. 9.2 Swire Shipping lines route map as at February 2023. The boundaries and names shown and the designations used on this map do not imply official endorsement or acceptance by the United Nations. (<https://www.swireshipping.com/information/info-pages/our-solutions/liner-shipment/>). Figure credit: Swire Shipping Pte. Ltd.

containers were needing to be re-positioned in any case. For no extra cost to either the waste stream “owners” or the shipping company, the waste could be carried out.

SPREP is the secretariat of the Waigani Convention and is the Pacific Regional Centre for the Basel Convention and is thus able to ensure that the required Prior Informed Consent, licenses, exemptions etc. are all in place for all relevant ports before any shipment of cargo is authorized and accepted.

In addition to the principal stakeholders, the PICTs’ national governments, the other key stakeholders comprise the shipping firm and owner of the empty containers, SSL, the regional Intergovernmental body for the Environment, SPREP, plus the Ministries of the Environment (or waste) and in some cases the Ministries for Tourism of the PICT. SPREP was crucial to facilitate the government-to-government interactions. At the same time, it can also connect potential investors and IGOs (e.g., UNEP, UN ESCAP, World Bank, Asian Development Bank, European Union) with the governments on environmental initiatives, such as developing suitable recycling plants.

Shippers of waste stream cargos were also one of the stakeholder groups. A potential shipper could be a recycling company, a non-governmental body, or a government agency. The typical month-long permit application process would be triggered by the shipper which had to reside in an exporting country that was a member of SPREP and/or the Pacific Islands Forum (PIF). The waste shipment exemption application is then made through SPREP.

The partnership between SSL/Swire and SPREP/UNEP was to engineer a “win-win” situation for the two parties, as well as the shippers, the exporting countries’ communities and the destination recycling plants. This was known as the “Moana Taka Partnership” (MTP). *Moana* is the Polynesian for ocean and *taka* is the word for circulate in Polynesian, and “waste” in Swahili. The MTP memorandum of understanding (MOU) signed on Global Recycling Day, 2018 established the operational processes by which SSL vessels carry their owned containers, lent *pro bono* to the shippers to fill with recyclable waste from eligible Pacific island ports (viz. on Swire Shipping’s route network, initially, to avoid complications of transshipment), to then be shipped with *pro bono* freight fees, so that the waste could be sustainably treated and recycled in suitable ports in Asia Pacific elsewhere on its route network.

Specifically, the MTP focused initially on moving cargos explicitly covered under the Waigani and Basel Convention, an agreement that regulates transboundary movement of defined toxic, poisonous, explosive, corrosive, flammable, eco-toxic, infectious, and radioactive wastes. Under this agreement, PICTs that have insufficient or inappropriate landfill space to store waste, inadequate waste treatment facilities, or lack the financial ability to ship recyclable waste are eligible to apply. Recyclable materials include plastics, aluminium cans, waste oil and ozone depleting substances (ODS), amongst those on the list in the Basel Convention. When the agreement initially took effect it did not support non-hazardous (but still non-commercial) shipments, but it has done so since mid-2019. The fourteenth meeting of the Conference of the Parties to the Basel Convention (COP-14, 29 April–10 May 2019) adopted amendments to Annexes II, VIII and IX to the Convention with the objectives of

enhancing the control of the transboundary movements of plastic waste and clarifying the scope of the Convention as it applies to such waste. The MTP was instrumental to SPREP in helping to deliver a part of its initiatives toward implementing its Cleaner Pacific goal by the year 2025 (Cleaner Pacific Strategy Plan 2022). It had set aside USD 4 million for waste management system in the region. As part of the MTP agreement, the regional organization could help identify a competent, licensed, willing, and suitable waste stream recycler/waste reception facility/buyer, unless the applicant for shipping the waste out from the Pacific Islands had already identified one.

The UN Environment Programme (UNEP) is the international agency that coordinates the UN’s environmental activities, helping developing countries to implement environmentally sound policies and practices. UNEP supported this partnership, and found that it held the potential to help realize several of the UN’s Sustainable Development Goals (SDG) which had been promoted since 2015; in particular the three goals shown in Fig. 9.3.

For Small Islands Developing States (SIDS) it is noteworthy to mention, that the Biosphere Reserve of the Island of Príncipe (São Tomé and Príncipe) and UNESCO have launched an awareness and mobilization campaign entitled ‘*No plastic. A small gesture in our hands*’. The campaign follows one of the resolutions of the International Meeting of the East Atlantic Biosphere Reserve Network, which took place on the Island of Príncipe in May 2013, and aims to reduce plastic waste and promote access to drinking water in the biosphere reserve. The campaign intends to involve the whole population in collecting plastic bottles. Fifty plastic bottles can be exchanged for a ‘Príncipe Biosphere Bottle’, a reusable stainless-steel bottle made from safe,



Assisting PICTs with sustainable consumption by reducing waste to air and to landfills, increasing national recycling rate and adopting product life cycle approach to resource management.



By removing toxic waste in a controlled manner this project will reduce marine pollution from land based activities which in turn leads to protection of the marine and coastal ecosystems.



Reducing toxic and slow degradable waste to landfills helps to reduce negative impact on terrestrial and inland freshwater ecosystems and their services as well as assisting with the loss of biodiversity.

Fig. 9.3 United Nations Sustainable Development Goals

plastic-free materials. These bottles can be replenished at various treated water points installed across the island of Príncipe.

9.4 The Agreement

Through the good offices of SPREP and the Pacific Island Forum (PIF), in contact with the various PICT national Ministries’ of the Environment, there is now a wide knowledge of the MTP amongst those whose business concerns disposal of waste streams. Prior to the introduction of MTP, waste streams had a negative profitability when shipped commercially from places with no disposal facilities to the ports where disposal could be done in a licenced, competent, and sustainable way. The entire negative profitability equation is turned on its head when both the container hire costs and freight charges are waived by the shipping company relocating the empty containers, which it has to do anyway.

A copy of the flow chart for the MTP Charter is shown in Fig. 9.4.

The owner of the waste stream must:

- 4.1 First determine if this partnership offer will be applicable in their county and national circumstances.
- 4.2 Submit an application form which outlines the type of waste stream (hazardous or non-hazardous), the location and the quantity, the condition, the current owner, and the preferred timescale for removal.

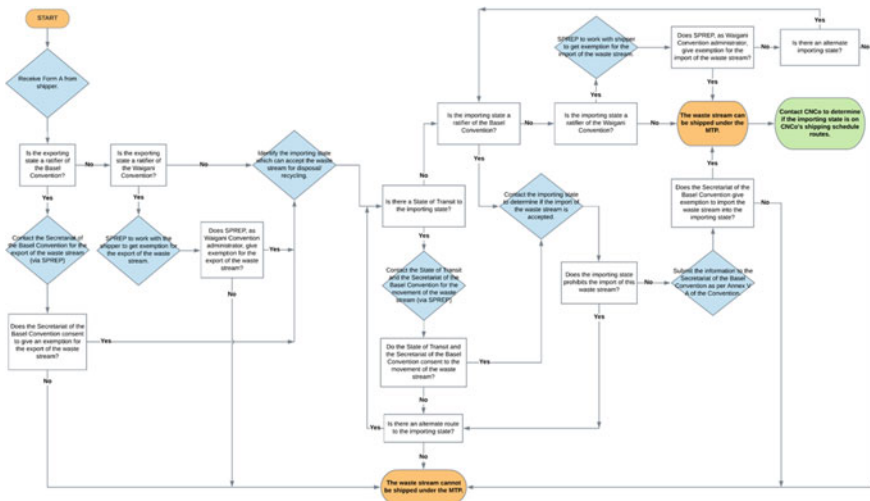

Fig. 9.4 The MTP Charter and Process (source The Moana Taka Partnership Charter; <https://dcasvmm70pnz.cloudfront.net/assets/Sustainability/The-Moana-Taka-Partnership-Charter-Rev-2.3-Non-commercial.pdf>). Figure credit: Swire Shipping Pte. Ltd. and SPREP

- 4.3 Provide the name and location of competent, licensed, willing and suitable waste stream recycler (for which SPREP is able to provide assistance if needed).
- 4.4 Critically warrant that the waste shipment is *non-commercial*. This is interpreted as “the waste stream has not been shipped between the ports involved within the past two years”. This is to prevent this environmental and social initiative cannibalizing existing commercial bookings that have been carried out previously without any need for a subsidy. This could commercially disadvantage both the shipping company and other waste shippers who have been paying to ship the same waste stream up to the development of the MTP.

Swire Shipping will then review the application form to determine:

- 4.5 If they have any suitable empty containers in a port near the waste location that need to be moved to a port near the recycling location.
- 4.6 If they have any suitable ships serving the port pair in 4.3.
- 4.7 If they have space to transport the container from and to the port pair in 4.3. Assuming yes, then
- 4.8 the MTP dedicated resource will then liaise with the owner of the waste stream to make a cargo slot booking.

SPREP, as the Pacific Regional Centre of the Basel Convention/Waigani Convention Secretariat, will then:

- 4.9 liaise with the shipper, consignee, shipping booking department, and ALL countries on the route between the port pair in 4.3 (viz. departure, intermediate, and destination ports) to obtain Prior Informed Consent under the Basel/Waigani Convention, *if* the cargo is on the hazardous cargo lists in the convention schedules.

When (and only when) all the above administration is complete can the operation begin.

The shipper has the responsibility for arranging and paying for all matters such as filling the containers, transport to the port, loading onto the ship, issuance of bills of lading and securing any necessary insurance prior to loading, and also the arrangement and payment of importation fees (including manage bio-security issues where relevant), moving away from the port, storage, unstuffing, and container cleaning after discharge at the destination port. It must also be noted that it is not always possible for such *pro bono* shipments to be performed from all points, to all point as may be preferred by the shippers.

Currently the company cannot ship to ports outside the Asia–Pacific, or destinations not covered by its schedule routes, as it cannot commit 3rd party Ship Owners to provide *pro bono* services. However, and crucially, this partnership is not seen as a revenue line item, but rather an environmental and social investment in its key communities. Consequently, the processes involved are all available, in editable format, for any other like-minded ship owners to rebadge and copy the MTP. Swire Shipping reports that that this has begun to happen in the Pacific Ocean for other PICT not served by Swire Shipping, and is being

reviewed by UN Environment for replication for SIDS in both the Indian Ocean and the Caribbean Sea in conjunction with the GEF-funded ISLANDS Waste-free Shipping Programme (see GEF ISLANDS <https://www.thegef.org/newsroom/press-releases/island-nations-get-new-lifeline-beat-pollution> 2022). This demonstrates the successful public–private partnership offers continued opportunity for replication and growth.

9.5 The Impact

The first shipment (SWIRECNCO Waste Shipment 2022) took place in March 2018, just 115 days from the meeting under an acacia tree at UNEA-3 and when the ink on the MTP agreement had barely dried, on the Swire Shipping vessel, *MV Melanesian Pride*, from Apia, the capital of Samoa, carrying 2 TEUs (twenty-foot equivalent units) with 56 tonnes of scrap metal, to Brisbane, Australia.

Since then, in 2019 the MTP shipped 50 TEU / 616 tonnes from Australia, Fiji, the Marshall Islands, and Papua New Guinea (PNG), to Australia, Kiribati, Malaysia, Samoa, Singapore, and Vietnam.

A few barriers were discovered including:

- one existing waste shipper felt strongly that his business, which he had built up over years, was being harmed. Swire Shipping attempted to engage with the individual, pointing out that no single “commercial cargo” had been shipped, viz. “a waste stream has been shipped between the ports involved within the past two years”, but to no avail.
- one shipment for which the consignee’s waste recycling permit expired on the voyage, so the destination port customs would not allow it to be landed (requiring Swire Shipping return it to its port of origin at its own cost). A longer buffer is now set in place to avoid this. The use of requesting a bank bond to cover the costs of returning the shipment to the loading port is being considered, but has yet been instituted.

However, the scalable model and the material impact that garnered broader support, has meant that other shipping companies in the Pacific have begun to adopt this model. If the take-up develops further in this way, it is possible that the partnership can be expanded to encompass movement of waste streams to an expanded destination port network by using two separate shipping lines, with trans-shipment at an intermediate port (in exactly the same way as baggage transfers are possible between two airlines in the same alliance who agree to “inter-line”). UNEP is considering transferring this model to other ocean basins such as the Indian and Caribbean Sea.

9.6 The Future

One issue that has been very visible as Swire Shipping has taken a deeper interest in under/improperly processed waste in PICT, is the number of abandoned End of Life Vehicles (ELV) observed on every island. To reduce the volume of discarded waste materials, particularly ELV in the PICTs, an integrated logistics supply chain and recycling operation that will enable the ongoing recycling of various waste streams that is sustainable both financially and environmentally is needed.

Geographic presence and logistics network coverage to deliver sustainable outcomes for the communities of the PICTs, now and for the future is critical. Future plans can build on the learning from this partnership.

- Build from the Moana Taka Partnership (MTP), a proven successful, innovative regional project.
- It is regarded as a scalable project due to the number of satellite plants and the capabilities of our network.
- The project is targeted to scale; starting with the recovery of waste irresponsibly discarded in an environmentally unfriendly manner aiming to eventually see proactive final owners delivering to commercial and industrial (user pays) sites, and thus assisting in the recovery and recycling of mining and other industrial users.
- It is intended that this will eventually be a commercially viable project for all stakeholders, rather than solely an environmental/CSR project.
- It will create employment, skills, and enrich the lives of local people.
- Target a measurable reduction, and eventually a complete avoidance of material sent to landfill, while maximizing the closed loop recycling of a variety of materials that are currently just seen as waste streams.

There is an imbalance between the levels of import and exports in the PICTs, and this has resulted in large numbers of ELVs and bulky domestic appliances being abandoned in the region. The Swire MTP proposition detailed earlier is to ‘do better’ with them.

Appropriate disposal to landfill or for resource recovery is currently unsustainable in the PICTs due to the constraints of their wide geographic distribution, the low value and low volume of the scrap available, distance to the relevant markets, lack of public funding, specialist skills, or enterprise to do better, and the presence of Persistent Organic Pollutants (POPs) as flame retardants in the ELV soft fittings that must be removed prior to recycling to mitigate leakage of toxic compounds into the environment. The aim of the partnership is to ensure on-going delivery of best practice waste minimization methods and best possible outcomes for the environment and the PICTs communities.

However, it is clearly recognized that cleaning up irresponsibly abandoned ELVs is a reactive solution aimed at treating the symptoms and not the cause. It is believed that IGOs helping the PICTs enact legislation that suits them, to encourage

responsible disposal at the end of life of the asset will be a material improvement, building off the work that the likes of SPREP have done in the past with the Extended Producer Responsibility (EPR) (Extended Producer Responsibility 2022), the circular economy, the life cycle approach and all the other efforts they have made in the past. The authors' view is that Advance Disposal Fees (ADF) (Advanced Disposal Fees 2022) are the next step on road to the behavioural change, albeit an important one.

It is believed that ADFs are a relatively new concept in the PICTs, with the exception of Tokelau where the idea has yet to be fully developed. It may well be some time before there is any legislation put in motion as a result of Tokelau's leading work in this area. However, if SSL's "Project Rivendell" gets the go-ahead, legislation will greatly help to progress this solution. The ownership of the abandoned scrap in each country is a potential obstacle to the viability of this project, as it would be in any region. To overcome this, the project will need support from local governments.

While it would of course be possible for each of the PICTs to set up the legislation individually themselves, we feel this may be inefficient, re-inventing the same wheel. The legislation should be quite similar from country to country, so adopting a similar package avoids the cost in time and money for each single country and territory. The end result of adopting non-common legislation will be to delay the implementation of the project and the clean-up of the islands.

Most businesses in our sector do not involve themselves in lobbying government; it is not Swire Shipping's desire, or core business or area of expertise. This is where public-private partnerships with inter-governmental bodies, based on the data-backed science and business operations can once again work together to produce a solution that gives wins to the three parties in the Science-Policy-Business area and the key stakeholders of the communities of the PICTs.

References

- Advanced Disposal Fees (2022) <https://www.sprep.org/sites/default/files/documents/publications/advanced-recovery-fee-deposit-factsheet.pdf>
- Cleaner Pacific Strategy Plan (2022) <https://www.sprep.org/attachments/Publications/WMPC/cleaner-pacific-strategy-imp-plan-2025.pdf>
- Extended Producer Responsibility (2022) https://en.wikipedia.org/wiki/Extended_producer_responsibility
- Iese V, Paeniu L, Pouvalu SIF, Tuisavusavu A, Bosenaqali S, Wairiu M, et al. (2015) *Food security: Best practices from the Pacific*. Pacific Centre for Environment and Sustainable Development (PaCE-SD), The University of the South Pacific, Suva, Fiji
- Moana Taka Partnership (2022) <https://www.swirencoco.com/CNCWeb/media/Departments/SD/Moana-Taka-partnership.pdf>
- Nair DJ, Rashidi TH, Dixit VV (2016) Estimating surplus food supply for food rescue and delivery operations. *Socio-Econ Plan Sci*. <https://doi.org/10.1016/j.seps.2016.09.004>
- Nair DJ, Rey D, Dixit VV (2017a) Fair allocation and cost-effective routing models for food rescue and re-distribution. *IISE Trans* 49(12):1172–1188. <https://doi.org/10.1080/24725854.2017.1351043>

- Nair DJ, Grzybowska H, Fu Y, Dixit VV (2017b) Scheduling and routing models for food rescue and delivery operations. *Socio-Econ Plan Sci* 63:18–32. <https://doi.org/10.1016/j.seps.2017.06.003> SPREP
- SPREP (2022) <https://www.sprep.org/circular/cir20101-moana-taka-partnership-publication>
- SWIRECNCO (2022) <https://www.swirecnco.com>
- SWIRECNCO Waste Shipment (2022) <https://www.swirecnco.com/CNCoWeb/media/Departments/Communications/Media%20Room/2018/Press-Release-20-March-2018.pdf>
- UN Geospatial (2023) Map of the World. Copyright United Nations. <https://www.un.org/geospatial/content/map-world-1>
- Waigani Convention (2022) <https://www.sprep.org/convention-secretariat/waigani-convention>

The opinions expressed in this chapter are those of the author(s) and do not necessarily reflect the views of the UNESCO: United Nations Educational, Scientific and Cultural Organization, its Board of Directors, or the countries they represent.

Open Access This chapter is licensed under the terms of the Creative Commons Attribution-ShareAlike 3.0 IGO License (<https://creativecommons.org/licenses/by-sa/3.0/igo/>), which permits use, sharing, adaptation, distribution, and reproduction in any medium or format, as long as you give appropriate credit to the UNESCO: United Nations Educational, Scientific and Cultural Organization, provide a link to the Creative Commons licence and indicate if changes were made. If you remix, transform, or build upon this book or a part thereof, you must distribute your contributions under the same licence as the original.

The use of the UNESCO: United Nations Educational, Scientific and Cultural Organization's name, and the use of the UNESCO: United Nations Educational, Scientific and Cultural Organization's logo, shall be subject to a separate written licence agreement between the UNESCO: United Nations Educational, Scientific and Cultural Organization and the user and is not authorized as part of this CC-IGO licence. Note that the link provided above includes additional terms and conditions of the licence.

The images or other third party material in this chapter are included in the chapter's Creative Commons licence, unless indicated otherwise in a credit line to the material. If material is not included in the chapter's Creative Commons licence and your intended use is not permitted by statutory regulation or exceeds the permitted use, you will need to obtain permission directly from the copyright holder.



Chapter 10

Infrastructure Vulnerability to Disruption: A Particularly Pacific Problem



Matt Blacka, Fiona Johnson, and Ron Cox

Increasing the climate resilience of infrastructure is vital for Pacific communities to support daily living and disaster response.

Abstract Infrastructure and climate have important roles in driving the water-energy-food nexus in the Pacific region. The significance of infrastructure is woven throughout the United Nation's 2030 Agenda for Sustainable Development, with Sustainable Development Goals relevant to infrastructure and its links to the water-energy-food nexus. Pacific Island Countries and Territories (PICTs) differ from larger developed neighbouring countries in Oceania such as Australia and New Zealand, bringing about a unique set of challenges for infrastructure. Physical characteristics include small, remote populations and small land masses, and susceptibility to natural hazards. Institutional challenges such as governance, small economies, and limited infrastructure expertise are prevalent. Yet, despite all these challenges, climate change is perhaps the largest. This chapter considers the interconnectivity of infrastructure and the water-energy-food nexus, and the importance of building climate resilience within the infrastructure sector reflected through the lens of three key infrastructure areas namely maritime transport, coastal protection, and Water, Sanitation and Hygiene (WaSH) infrastructure.

Keywords Infrastructure · Water supply · Sanitation · Ports · Maritime · Transport · Coastal · Adaptation

M. Blacka (✉) · R. Cox
Climate Change Cook Islands, Office of the Prime Minister, Cook Islands Government, Avarua, Cook Islands
e-mail: m.blacka@wrl.unsw.edu.au

M. Blacka
Water Research Laboratory, School of Civil and Environmental Engineering, UNSW Sydney, Manly Vale, NSW 2093, Australia

F. Johnson
Water Research Centre, School of Civil and Environmental Engineering, UNSW Sydney, Kensington, NSW 2052, Australia

© UNESCO 2024

A. Dansie et al. (eds.), *The Water, Energy, and Food Security Nexus in Asia and the Pacific*, Water Security in a New World,
https://doi.org/10.1007/978-3-031-25463-5_10

201

10.1 Introduction

The United Nations (2015) identifies the central role of infrastructure through the Sustainable Development Goals (SDGs) and its links to the water-energy-food nexus. SDG 6 and SDG 7 relate to water and energy respectively and SDG 9 aims to “build resilient infrastructure, promote inclusive and sustainable industrialization and foster innovation.” These SDGs are relevant across the Pacific region but have particular importance for the Pacific Island Countries and Territories (PICTs) which are predominantly classified as lower and upper middle-income economies and include four of the world’s least developed countries (Kiribati, Solomon Islands, Timor Leste, Tuvalu) (United Nations 2021). The challenges facing these communities is reflected in SDG 9a, which focuses specifically on resilient infrastructure for small island developing states.

At a national level, the SDG infrastructure-related goals are echoed through the sustainable development plans of many, if not all, PICTs. For example, Infrastructure and Technology is one of five National Outcomes of the Tonga Strategic Development Framework 2015–2025 (Government of Tonga 2015), and Building Resilient Infrastructure is a National Development Goal of the Cook Islands National Sustainable Development Plan 2016–2020 (Government of Cook Islands 2016). World Bank (2006) similarly identifies infrastructure-related development goals for Fiji, Kiribati, and Solomon Islands within their national development planning agendas.

However, the PICTs are diverse in geography, culture, climate, and have unique development challenges. The small land masses, remote geography, rapid urbanization, and important role of the ocean in terms of infrastructure sets the PICTs apart from their larger neighbouring countries of Australia and New Zealand. This chapter, therefore, focuses on the relationship between infrastructure and climate change impacts on the water-energy-food nexus in the PICTs.

10.2 Infrastructure Functions in the Water-Energy-Food Nexus

Infrastructure in the PICTs can broadly be considered to support three principal outcomes (Baker and Week 2011), or a combination of them:

- Basic well-being of the population;
- Delivery of Government services; and
- Enabling economic activity.

Figure 10.1 maps different infrastructure categories to their intended principal outcome (or outcomes), from which it can be seen that basic well-being of populations is a fundamental outcome supported by most infrastructure types, and indirectly supported (through income generation, for example) by all types. In most instances, infrastructure supports the basic needs and well-being of communities through its role

in the provision of clean water, stable energy, or secure food supplies—fundamental components of the water-energy-food nexus.

What differentiates infrastructure within the Pacific region from many other areas of the world, are the geographical and geophysical characteristics of the island nations that characterize the region, combined with the social and cultural characteristics of human populations. Dominated by dispersed island communities spread over vast areas of ocean, and with many communities inherently restricted to the coastal margin, there are strong traditional cultural ties, as well as modern needs associated with the ocean and coasts. Capital and maintenance costs for infrastructure services in the PICTs are comparably high, for a number of reasons, including the often small, dispersed, and remote settlements and inherent vulnerability to natural disasters (World Bank 2006).

To holistically consider climate impacts on infrastructure and subsequently the water-energy-food nexus, we need to look beyond the direct impacts on infrastructure itself, considering also the impacts on interdependent sectors supported by infrastructure (Baker and Week 2011). For example, a seaport is not only directly impacted

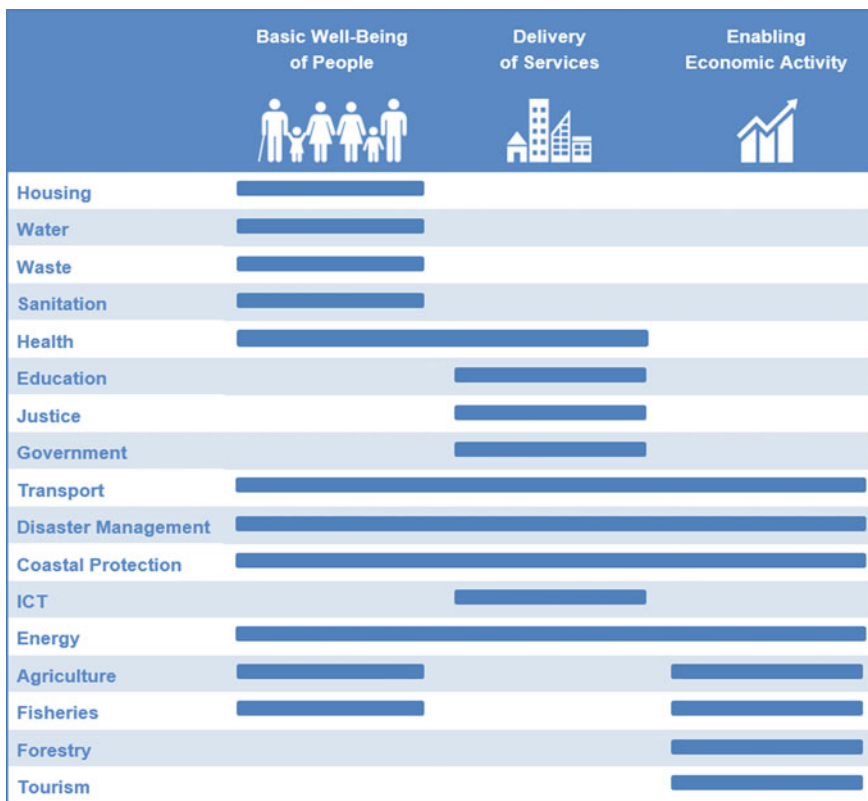

Fig. 10.1 Principal outcomes of sectors supported by infrastructure for PICTs

by rising sea levels and more extreme wave conditions, but also indirectly by climate change impacts on connected infrastructure. These indirect impacts occur on infrastructure such as the coastal protection structures that provide safe shelter for vessels, roads that service freight linkages, energy and fuel supplies that power operations, communications, and on local communities that require the import/export trade (Cox et al. 2013, 2014).

10.2.1 Maritime Transport Infrastructure

Communities across the PICTs have historically had (and continue to have) very close ties with the ocean. In addition to this strong cultural connectivity, maritime transport provides a fundamental link for international and inter-island freight, passenger travel, and is an essential component of both commercial and subsistence fisheries. Long distances between ports, low trade volumes, imbalanced exports/imports, and the widely varying standard of ports and their operations result in relatively high shipping service costs within the region (ADB 2007).

Each PICT has a number of ports with different functions. Typically, each country has just one or two major ports that process international trades, and these facilities are often government owned (ADB 2007). Secondary ports, typically located on outer islands or in provincial towns, provide domestic and inter-island freight and transport services. While these facilities are low-key and often under-maintained (Pacific Infrastructure Advisory Center 2013), they are the lifeblood of remote island communities through which essential supplies are received including food, medical supplies, building supplies, fuel, and gas. The secondary ports are sometimes owned and managed at an island or provincial government level (not national government), such as in the Cook Islands, introducing further funding and capacity constraints to maintain the assets and infrastructure.

Port infrastructure across the region varies vastly in operational standard and condition depending on the required functions. Even international cargo and bulk facilities in some countries (e.g., Cook Islands as shown in Fig. 10.2) comprise only a basic wharf, mooring, and water-side equipment, and completely rely on vessels to provide cargo handling equipment and personnel. In small, remote island communities, facilities are typically very basic timber or concrete wharves serviced by a narrow (and often dangerous) reef passage (Fig. 10.2). Small local barges and tenders pass through the reef and form a transfer link with larger freight vessels that remain offshore in deeper water during cargo transfer operations. In contrast, some countries with larger economies (French Polynesia and New Caledonia, for example) have major wharves and coastal protection infrastructure to support sophisticated facilities and cargo-handling that is of world-class standard (ADB 2007).

For maritime transport infrastructure such as seaports, the links between infrastructure and the water-energy-food nexus are strong within the PICTs due to a range of unique factors:



Fig. 10.2 A cargo vessel awaits to unload offshore of the reef at Arutanga Wharf, Aitutaki, The Cook Islands (©M. Blacka)

- All incoming fossil fuel supplies from international locations are either offloaded to storage facilities, often located on vulnerable land along the coast, or domestically transhipped through major ports. These fossil fuels are typically the dominant source of fuel used to produce energy in the form of electricity, which then powers water treatment and distribution infrastructure and refrigerates stored food.
- The imported fuels that pass through ports also drive land-based transportation networks that distribute food, bottled water, and other goods, and drive domestic shipping and recreational boating that underpins commercial and subsistence fisheries.
- Gas imported through ports forms a significant source of heat for cooking food and boiling drinking water.
- Jet fuel imported through ports is vital for air transport, and in particular supports the key economic role of tourism in the region.
- Ports provide for the extensive domestic and international commercial fisheries industries that are a significant component of local and regional economies, and a critical source of food for many countries.
- For countries with minimal arable land (atoll-dominated countries, for example), imported food via sea transport forms a major component of people's diet to supplement locally available produce.
- Domestic ports and harbours provide the opportunity for inter-island movement of food, both imported and exported from domestic agriculture, aquaculture, and

other primary producers, and for movement of other supplies and produce between remote communities.

- Domestic harbours are the safe base and hub through which many local fishermen access the seas surrounding their islands to undertake subsistence fishing.

10.2.2 Water, Sanitation, and Hygiene (WaSH) Infrastructure

Infrastructure for water supply and sanitation is varied across the Pacific, and access to both water and sanitation is uneven. Approximately 50% of the population of the PICTs have access to an improved water source (United Nations 2020). However, there are strong inter-country differences; for example Australia, Niue, and New Caledonia have close to 100% access to improved water sources, whilst Vanuatu and Tuvalu have less than 50% and Samoa only around 10% (United Nations 2020). Similarly access to safely managed sanitation (SDG 6.2.1) is highly variable across the Pacific ranging from approximately 30% for Kiribati and Tonga, close to 50% for Samoa, and up to 75–80% for Australia and New Zealand (United Nations 2020). There is limited data for many of the PICTs for sanitation coverage (see Chap. 2 for more details).

Centralized, piped water systems are common in the larger cities and can be fed by groundwater or surface water sources. For example, traditionally communities in Samoa settled around freshwater springs (Macpherson and Macpherson 2017), and aside from household personal water tanks, almost 100% of distributed water on Rarotonga (Cook Islands) is through intakes on upper catchment streams. Similarly, surface water provides 95% of water requirements in French Polynesia. For some islands, such as the atolls in the northern group of the Cook Islands, rainfall is the predominant potable water source, captured within both community and household tanks (Parakoti and Davie 2007). Purpose-built roofs can provide a catchment surface for larger community tanks (Fig. 10.3), though often community buildings such as churches, halls, and schools provide a roof catchment.

Fresh groundwater lenses are important water sources in low-lying atolls and limestone islands and basal aquifers can also occur along the coastal zones of volcanic islands (Falkland and White 2020). The sizes of these freshwater lens varies substantially. Investigations in Tonga and Niue, for example, show sustainable reserves while the small freshwater lens in Nauru disappeared completely during the 2008 drought (White and Falkland 2010). In some locations, water from freshwater lenses is used for non-potable or supplementary supplies because salinity levels are too high for drinking purposes.

Reverse osmosis (RO) for seawater desalination is used in some locations (see Chap. 8 for more information). Desalination in Nauru is used during drought periods and for supplementary supply at other times. Small-scale containerized desalination operates in Fiji, Kiribati, Solomons, Papua New Guinea (PNG), Nauru and Palau, among other PICTs in the region. Transportable desalination plants are becoming



Fig. 10.3 Community water tank and catchment roof on the atoll of Manihiki (©Melina Tuiravakai)

more common as a tool for rapid deployment to remote communities during emergency water shortages. For instance, such a system was used in the atoll of Penrhyn in the northern Cook Islands during the La Niña driven drought in 2020/2021 (Cook Island News 2021; Radio New Zealand 2021). Private desalination plants are operated by tourist resort owners in some PICTs. Desalination has now also been widely implemented for major cities around Australia, with multiple plants installed in Perth, western Australia due to the declining water resources in this region as a result of shifting rainfall patterns (Hope et al. 2006; Ummenhofer et al. 2008).

Informal settlements in urban and peri-urban areas are an increasingly important consideration in PICTs, where high urbanization rates are a result of migration for education and employment (Weir et al. 2017). Informal settlements are rarely considered in official urban planning and are under-served in terms of water and sanitation infrastructure (Anthonj et al. 2020). Sinharoy et al. (2019) note that globally unreliable or intermittent supplies in informal communities are associated with poorer water quality forcing householders to store more water, which can also lead to contamination. Access is often from shared community standpipes, which may be illegal connections or have higher tariffs (Schrecongost et al. 2015). Sanitation facilities in informal settlements are particularly problematic, with poor waste management and shared facilities leading to health and safety risks, particularly for women and girls (Sinharoy et al. 2019), and further deterioration of available water resources.

Examples of how WaSH infrastructure affects the water-energy-food nexus include:

- Alternative water supply technologies such as RO have high energy costs and if not using renewable energy, require fuel to be imported, providing further cross linkages with transport infrastructure.
- Similarly, energy, and therefore fuel, is required for water treatment plants and pumps for boreholes and surface water intakes. As highlighted above, energy supply disruptions can lead to households storing more water to mitigate against intermittent supplies. This can contribute to poorer water quality and health outcomes.
- Unsustainable groundwater use, leading to drawdown or salinisation of aquifers, requires higher energy inputs due to increased pumping and treatment requirements.
- Life on Pacific atolls can be “harsh and precarious,” due to their low agricultural productivity and highly porous soils, coupled with limited available land area, leading to food insecurity and the need to import food (Terry and Chui 2012). Attempts to improve productivity through fertilizers and pesticides risk contaminating the limited freshwater reserves and impacting adjacent coastal ecosystems.
- More research is required into safe rearing practices for livestock that better protects freshwater sources in the Pacific context (MacDonald et al. 2017). For example, the proximity of domesticated pigs to community water sources increases the risk of leptospirosis through contamination of freshwater by urine.

10.2.3 Coastal Protection Infrastructure

Whereas seaport and WaSH infrastructure can directly influence water-energy-food nexus outcomes, coastal protection infrastructure has a more indirect (though no less important) role. Many low-lying island communities rely on coastal protection infrastructure to reduce impacts from coastal erosion and inundation during extreme cyclones, large swell wave events (Hoeke et al. 2013), or king tide events (Lin et al. 2014; Davies 2015; Australia News Network 2014). In some cases the need for coastal protection is not driven by climate event extremes, but instead linked with other underlying climatic and physical processes, including degradation of coral reef health, longer-term climate cycles that influence waves and currents, removal of coastal sands by mining of beaches, and the trapping of sediment by rivers and other coastal structures (PRIF 2017).

Coastal protection works can or do mitigate risks to water, energy, or food systems. For example:

- For many island communities agricultural crops, in particular taro crops grown in low-lying freshwater wetlands, form staple food sources but can be destroyed by saline ocean water from wave overwash and storm surge processes, or damaged through erosion (e.g., impacts from Cyclone Pam on outer islands of Tuvalu) (Taupo and Noy 2017).

- Freshwater lagoons, wetlands and shallow groundwater aquifers that form drinking water reserves can become contaminated with salt water (Storlazzi et al. 2018), destroying their viability for decades into the future (e.g., impacts from Cyclone Percy on the atoll of Pukapuka in the northern group of the Cook Islands) (Terry and Falkland 2010).
- Protection of other infrastructure within the coastal zone that supports the water-energy-food interdependencies, including water distribution infrastructure, transport infrastructure (road, port, and air), power supply infrastructure, fuel storage etc., from the impacts of these extreme ocean events.

The use of rock armoured seawalls is widespread throughout the PICTs, as well as a host of other formal and ad-hoc coastal protection systems, including vertical concrete walls, grouted stone and coral boulder walls, sand and grout-filled bags, gabion baskets, and materials of opportunity such as rubber tires, tree trunks, scrap metal and machinery, and drums that are filled with concrete. While concrete armour units have been used, they are generally limited to ports or other areas of higher value. Table 10.1 identifies the length of coastline for most countries in the Pacific region, along with the types of human-created coastal protection in place around each country (including both nature-based and engineered coastal protection works).

Natural systems also provide significant coastal hazard protection to island communities throughout the Pacific region. On high-energy coastlines, coral reefs act as a natural dissipator of waves (Ferrario et al. 2014), regulating the wave energy that eventually reaches the shorelines. Healthy reef ecosystems also generate sediment that sustains the beaches of many islands providing further coastal protection value for communities. In low-energy coastal environments, mangroves also provide natural dissipation of wave energy and protection of communities from coastal flooding hazards (Gilman et al. 2006).

10.3 Climate-Related Vulnerabilities

The major intersections of current and future climate with infrastructure centre on rainfall patterns and sea levels (see further description of Pacific climatology and its future changes in Chaps. 1, 2 and 5). Extreme weather events, specifically tropical cyclones, are the major disrupting force for all infrastructure types. They lead to large rainfall totals, high intensity rainfall, and storm surges, which all contribute to flooding and can impact the efficient operation of infrastructure and potentially lead to infrastructure damage. At longer time scales, variability is primarily driven by the El Niño Southern Oscillation (ENSO) (see Chap. 5 for details), and water supply and food production are particularly at-risk during ENSO-induced droughts. The impacts of anthropogenic climate change on floods and droughts and key uncertainties and their links with hydrologic infrastructure in the Pacific are described in Johnson et al. (2021). Considering the infrastructure categories summarized in Fig. 10.1, these climatic intersections and vulnerabilities impact infrastructure across almost

Table 10.1 Coastline lengths and coastal protection types used in selected PICTs

Country	Coastline length (km)	Reported coastal protection types
Cook Islands	120	Concrete sea walls, rock boulder revetments, groynes, rock breakwaters, grouted coral sea walls, geotextile sandbag revetments, gabion baskets, beach planting, beach replenishment
Fiji	1,129	Mass concrete seawalls, reinforced concrete seawalls, rock revetments, rubber tires, gabion baskets, mangrove planting
Federated States of Micronesia	6,112	Grouted coral seawalls, stacked coral boulders
Kiribati	1,143	Small-stacked sandbags, grout-filled and mortared sandbags, reinforced concrete, grout mattress, tetrapod armour units, rock revetments, gabion baskets, stacked coral, grouted coral, planted mangroves
Republic of Marshall Islands	370	Rock rip-rap revetments, sandbags, vertical concrete block or cemented coral walls, concrete armour units, gabion baskets filled with coral gravel, stacked tires, scrap metal and old heavy machinery
Niue	64	Concrete seawalls
Nauru	30	Coral boulders, concrete seawalls, rock seawalls
Palau	1,519	Rock riprap, grouted rock, vertical concrete
Papua New Guinea	20,197	Stacked rock, bricks, sandbags, tree trunks, gabion baskets, concrete filled tires
Samoa	403	Grouted stone walls, rock revetments, groynes, beach replenishment, mangrove planting
Solomon Islands	9,880	Rock revetments, stacked rock behind wooden piles, mangrove planting, vertical concrete walls, concrete armour units (tetrapods), gabion baskets

(continued)

Table 10.1 (continued)

Country	Coastline length (km)	Reported coastal protection types
Tonga	419	Limestone/coral boulders, mangrove planting, grout-filled bags
Tuvalu	24	Vertical concrete walls, gabion baskets, concrete cubes, steel drums filled with concrete
Vanuatu	2,528	Vertical concrete walls, stacked coral, grouted coral, gabion baskets, revegetation
Timor Leste	735	Rock revetments, concrete armour units, mangrove planting, coastal and marine protected areas

Modified from PRIF (2017), Paeniu et al. (2015)

all sectors and are particularly vital to understand in the water-energy-food nexus. Infrastructure vulnerabilities differ from high islands to low atolls, nevertheless, even on high islands the majority of infrastructure tends to be clustered within the coastal zone due to the often rugged and mountainous nature of inland areas (Fig. 10.4), which is particularly sensitive to disruption by climatic and environmental drivers, and the impacts of climate change. Close to 60% of built infrastructure for 12 PICTs is located within 500 m of their coastlines (Kumar and Taylor 2015), amounting to a total replacement value of USD 21.9 billion (World Bank 2016).

10.3.1 Maritime Transport Infrastructure

For seaports in the Pacific, typical day-to-day weather fluctuations have minimal impact for port infrastructure but do impact port operations. Vessel navigation to enter, berth, and depart a port (be it larger scale international freight and bulk vessels through to smaller personal fishing boats) is sensitive to wind speed and direction, wave conditions, and ocean currents. Likewise, cargo handling operations (cranes, for example) are impacted by wind and wave conditions (Cox et al. 2013; Dyer 2019). Energy consumption for powering port operations is also sensitive to air temperature changes (UN Trade and Development Board 2014). For larger islands with reasonable land mass, intense wet-season rainfall events can cause localized flooding that can overtop wharf areas and impact landside infrastructure (PIANC 2020). The influence of these weather fluctuations can translate to operational disruptions, which differ both between seasons and with longer-term climate drivers such as ENSO. For smaller domestic outer island and provincial harbours, seasonal climate fluctuations and longer-term climatic fluctuations influence the frequency at which their intermittent cargo services are disrupted, or missed entirely, due to inclement conditions



Fig. 10.4 Rarotonga, the main island of the Cook Islands, has a high mountainous interior, yet infrastructure is clustered along the coastal fringe (*Source* Cook Islands Ports Authority)

that prevent ship unloading (UN Trade and Development Board 2014; Cook Island News 2013 for example). When operational disruptions result in shortages of food, fuel, medical supplies, and other essential goods that can last many months, this can translate to significant health and social impacts for remote communities.

Tropical cyclones can have a significant impact on both port infrastructure and operations, predominantly through damage from storm surge and large waves to both waterside and landside assets. Due to the inter-connected nature of ports with other infrastructure and links with water, energy, and food as previously described, these disruptions can be extensive and last many years or decades beyond the event, and result in economic impacts that stretch much further beyond the re-build costs. Given that ports form the primary transport links with other parts of the world, damage to port and harbour infrastructure can also have a significant impact on emergency response in the period immediately following an event due to delays in providing required materials for infrastructure repairs as well as emergency food, water, and shelter supplies.

Over the long term, the highest risk impacts from climate change for port infrastructure in the Pacific are generally related to sea level rise and waves. Changes to both of these environmental variables will impact the day-to-day operations of ports, and exacerbate damage sustained during cyclone events. In the majority of ports (small and large), facilities such as wharves and boat ramps are constructed for current sea levels and tide ranges, such that they function with quite specific freeboard. Increase

in mean sea level effectively reduces this freeboard and will eventually result in these facilities becoming increasingly unsafe to operate and losing functionality.

Small scale port and harbour facilities typical in the outer islands of many PICTs have very limited engineered protection from waves, often relying on the sheltering provided by the island itself and the dissipation of wave energy by fringing reefs. As sea levels increase relative to reef topography, the effectiveness of this natural wave dissipation will be reduced, and these harbours will be subject to increasing wave energy. Where breakwaters are present, they are typically low-crested and have limited to no maintenance, therefore vulnerable to this climate-change phenomenon (Fig. 10.4). For these low-key and often remote facilities, the effects of sea level rise and increased nearshore wave heights represent an extreme risk to public safety, including:

- More regular overtopping of the wharves, breakwaters, and ancillary facilities, making them unsafe or undesirable for use by the community;
- Reduced high-tide freeboard for vessels at berth, compromising the ability to safely load and unload cargo;
- Permanent inundation of the shoreline connections and/or wharves, making the infrastructure unsafe or unusable; and
- Increased maintenance requirements due to increased nearshore wave heights and cyclonic activity.

Larger ports in the region are not immune to these long-term issues, and in time will require significant adaptation to reduce climate-related risks. Wharf decks will need to be elevated, as discussed in ADB (2014) for Avatiu Port in the Cook Islands, and breakwater structures that provide wave protection will need to be strengthened, as discussed in ADB (2018) for Apia Port in Samoa. These being just two examples of the significant investment that will be required to reduce indirect climate-related impacts on the water-energy-food nexus that will result through impacts on the maritime transport sector.

10.3.2 WaSH Infrastructure

Most PICTs have strong wet and dry seasons (Chap. 5), and these annual cycles can lead to regular water shortages, particularly towards the end of the dry season for communities that rely on rainwater tanks or shallow groundwater-fed systems (MacDonald et al. 2017). On islands where they are present, perennial rivers can become much more important sources during the dry season (Elliott et al. 2017).

At longer time scales, the major ongoing risk for WaSH infrastructure comes from the influence of ENSO (Chap. 2) on water resources systems across the Pacific. ENSO-induced droughts are a major challenge across the Pacific (Chap. 5) directly impacting the security of the water-energy-food nexus. For example the 2002/2003 drought in Samoa led to electricity shortages because there was insufficient water for hydro-electricity generation (Kuleshov et al. 2014). The 2011 drought in Tuvalu

led to water rationing and required deliveries of fresh water supplies and portable desalination equipment from overseas (Kuleshov et al. 2014).

The primary cause of the largest flood events in the Pacific is tropical cyclones, although tropical depressions and flash flooding induced by short duration, high intensity rainfall events also contribute substantially to flood risk and associated devastating impacts on infrastructure. Cyclone Val in 1991 caused USD 200 million damage in Samoa alone, to energy, water, and telecommunications infrastructure as well as private and government buildings (Kuleshov et al. 2014). Importantly, there is substantial traditional knowledge in PICTs in terms of household level preparation for cyclones that should be drawn on to support climate resilience, including food storage techniques and traditional housing construction that enable rebuilding with local materials following a cyclone (Weir et al. 2017). Equally resilient designs are required for infrastructure. Community-wide piped water systems are considered very vulnerable to potential disruptions (Howard et al. 2010). For example, water treatment plants can be overloaded by high sediment loads in source water following extreme rainfall events or power losses can lead to lack of treatment, highlighting the importance of understanding the water-energy-food nexus. Back-up rainwater tanks are one solution that can be used to mitigate these risks (MacDonald et al. 2017) and in Samoa unused springs have been reinstated following extreme weather events (Macpherson and Macpherson 2017).

Rising sea levels, as well as increasing rainfall extremes and increased intensity for tropical cyclones from climate change will magnify existing vulnerabilities in water infrastructure. Extensive research has been undertaken in Australia to understand the potential impacts of climate change on water supply (Khan et al. 2015) and water resources infrastructure (Chiew et al. 2011). Some recommendations have been developed for floodplain management and infrastructure design (Bates et al. 2016), although there remain outstanding questions regarding modelling approaches (Stephens et al. 2019) and how changes in catchment wetness will interact with increasing rainfall intensities (Stephens et al. 2018). Similar research is urgently required for PICTs although data availability is a constraint (Johnson et al. 2021).

The risk of saltwater intrusion into groundwater systems will increase with climate change (Weir et al. 2017; Terry and Chui 2012). Given that freshwater lenses are entirely rainfall fed, any changes in rainfall patterns will also affect their recharge rates and therefore sustainability (Terry and Chui 2012). Higher temperatures are likely to amplify existing problems with algae growth in water supply reservoirs (Paerl et al. 2016; Ministry of Health 2018). Johnson et al. (2021) adapted the global qualitative review of Howard et al. (2010) on the resilience of different water supply and sanitation options, considering the applicability of a range of WaSH options in PICTs. They found that increasing the resilience of water supply options in the Pacific for climate change adaptation is challenged by under-resourced institutions, remote geography, and high rates of urbanization.

10.3.3 Coastal Protection Infrastructure

Sea level rise represents the most significant climate change challenge for coastal protection infrastructure in the Pacific region (Shand and Blacka 2017). World Bank (2016) suggest that the highest adaptation cost for PICTs by 2040 will be coastal protection works. Increases in sea level will directly result in increased frequency and magnitude of waves breaking over coastal protection infrastructure, and thus increased inundation (Quataert et al. 2015; Beetham and Kench 2018). Sea level also modulates incoming wave heights at the reefs along the coastlines of many islands of the Pacific (Monismith et al. 2013). Therefore, higher sea levels will also result in larger waves impacting coastal defences. Ocean water level and sea level rise has also been shown to have a significant impact on hydrodynamics of reef and lagoon systems of PICTs (Hoeke et al. 2011; Blacka et al. 2019). This will result in significant long-term changes in sediment transport and morphology of coastlines (Webb and Kench 2010; Masselink et al. 2020), further impacting built coastal protection structures such as seawalls through processes such as undermining (supporting sand removed from under foundations of structures) and out-flanking (supporting sand removed from around ends of structures), and natural protection offered by vegetation.

Increases in wave energy reaching the coastline (either through more intense cyclone events or through reduced nearshore wave breaking due to higher sea levels) may also have a significant impact on coastal protection structures. The required mass of rock or concrete armouring for seawalls and breakwaters for example, has a cubic power relationship to wave height (USACE 2002)—a 15% increase in wave height requires a 50% increase in the mass of coastal protection armour. Increases in demand for local rock adds further pressure both on local quarries and a finite extractable resource. This is especially true on small or non-volcanic islands, with increased sedimentation and deterioration of local waterways associated with such activities. With concrete production itself being a major contributor to global CO₂ emissions (Habert et al. 2010), increasing demand for this is also counterproductive, and suffers the same finite supply limitations due to limits on locally available aggregates.

10.4 Management and Adaptation

10.4.1 Infrastructure Adaptation Options

There are a range of solutions to the infrastructure vulnerabilities discussed above, summarized in Table 10.2 for each of the focus infrastructure areas. The major difference between the three classes of infrastructure and the adaptations that could be employed is the spatial scale and extent of the communities that they serve. Nevertheless the interconnectedness of infrastructure across the water-energy-food nexus

means that it is vital that these potential adaptations are not considered in isolation. Maladaptation is a real risk from isolated adaptation approaches, for example sea walls that do not accommodate increased rainfall and flood risk can trap water on the landward side (McNamara et al. 2020; Piggott-McKellar et al. 2020). In the context of the water-energy-food nexus, there is limited benefit from adaptation of port facilities if internal road infrastructure servicing the port does not have a similar level of resilience to climate change or extreme events. Failure of coastal infrastructure to prevent overtopping and erosion on shorelines will result in negative impacts on local food (household gardens, taro crops in low-lying areas) and water (shallow aquifers) resources.

An adaptation case study

Avatiu Port on the island of Rarotonga (Figs. 10.4 and 10.5) is the main international seaport in the Cook Islands, processing 90% of total imported goods arriving via sea transport (ADB 2014), as well as visiting international yachts and cruise ships. In 2012–2013 an ADB-funded project led to infrastructure improvements targeted at building climate resilience for the port. Prior to the upgrade, the port was restricted to ships with a maximum length of 90 m and draft of 6 m (Youdale and Tou 2013). The main wharf and quay were deteriorating and had suffered periodic damage from cyclones prior to the upgrade (Blacka et al. 2013).

One of the key features of the upgrade was rehabilitating the wharf deck including modifying the design to improve drainage and allow for projected sea level rise. Importantly the new design ensured that future adaptation works could more easily be implemented (such as further raising of the wharf deck level). To address the risk of extreme waves, a new inner harbour rock revetment was constructed, and additional rock armour added to the breakwater to protect the northern end of the quay. Highlighting the interconnectedness of infrastructure with energy and food, the port works also included land-side improvements such as relocating and strengthening the stevedoring and cargo sheds and rearranging the petroleum handling pipes and hazardous materials area. The redevelopment of the port of Avatiu has undoubtedly improved the climate-security of supplies to the Cook Islands via seaborne cargo, which supports energy and food security of the country. Nevertheless, some climate risks to the facility remain and are still being identified.

10.4.2 Pacific Strengths and Barriers to Infrastructure Adaptation

Beyond technical aspects, the complexities in developing adaptive responses to mitigate climate change impacts on infrastructure vary across the Pacific region due to geophysical, cultural, social economic, and environmental differences between countries and islands. A ‘one-size-fits-all’ approach does not work for the region (World Bank 2016). Land tenure is a major consideration in providing infrastructure in PICTs. Communities have deep spiritual, cultural, and ancestral ties to land and water (Weir et al. 2017). There are examples of conflicts over water being based on land tenure in Kiribati where government control of land to create water reserves intersected with the interests of the traditional owners (White et al. 2008).

Table 10.2 Potential adaptation options for climate change impacts on infrastructure

Effect of climate change	Impact on infrastructure	Potential adaptation responses
Marine transport infrastructure		
Changes to seasonal climatology such as winds, air temperature, ocean currents, and waves	Implications for navigation and berthing of vessels	Altered operating rules for vessels entering port, modifications to navigation channels, and harbour wave protection structures
	More frequent occurrences when vessels cannot enter port or safely transfer cargo to island barges	Modify harbour facilities to provide additional shelter or safer passage during broader window of conditions, consider alternative/backup unloading facilities, increase storage of goods held on-island
	Implications for operation of cargo unloading equipment (such as cranes), cold storage, etc.	Alter operations to accommodate periods of down-time, adapt cargo-handling methods to accommodate higher winds or air temperature, improve efficiency of cold storage facilities
Sea level rise	More frequent inundation of wharf facilities	Structural changes to raise wharf deck levels and lift other infrastructure
	Increased wave conditions impacting port due to deeper water or increased winds	More frequent maintenance of wave protection structures
		Modifications to wave protection structures
Landward retreat of adjoining coast	Protection of adjacent areas of coast (soft or hard), modifications to interface areas of wharves/surrounding terrain	
More intense cyclones	More frequent and/or more intense storm surge inundation of wharves and other port infrastructure	Raise level of wharf decks and other infrastructure, adapt land-side facilities to tolerate short periods of inundation, modify coastal protection to reduce impacts of wave setup and infragravity waves, modify cyclone preparations to accommodate more severe conditions

(continued)

Table 10.2 (continued)

Effect of climate change	Impact on infrastructure	Potential adaptation responses
	Larger waves and higher water levels impacting on coastal protection structures	Raise and increase armouring of protection structures, increase maintenance top-ups of armouring, adapt protection structure designs to tolerate more intense conditions
	Additional wind damage on cargo handling and other land-side equipment/facilities	Strengthen cargo handling equipment and storage facilities, modify cyclone preparations to accommodate more severe conditions
WaSH infrastructure		
Changes to seasonal and annual rainfall cycles	Water shortages due to insufficient storage	Increase storage and catchment areas, more diverse water sources developed
	Reduced recharge for springs and freshwater lens	Sustainable yields identified, more diversity in sources
More intense rainfall events	Increased flood risk and damage to infrastructure	Diverse water supply sources
	Cross contamination of freshwater from sanitation infrastructure	Improved water sources with less exposure to surface water inflows, improved design and siting of sanitation infrastructure
Sea level rise	Increased saltwater intrusion for freshwater lens	Limited ability to adapt to this impact
More intense cyclones	Increased incidence of wave overtopping for freshwater lens	Limited ability to adapt to this impact
	Extreme rainfall and wind speed damage to infrastructure	Diverse water supply sources
Increased temperatures	Changes in microbial growth	Wider use of improved water sources, wider use of system or household disinfection systems
	Increases in algal growth	Improved catchment protection Mechanical and chemical treatment
Engineered coastal protection infrastructure		
Sea level rise causing increased water levels at protection structure	Increased frequency and volume of overtopping	Raise structure crest to reduce overtopping or adapt backshore areas to tolerate higher overtopping flows

(continued)

Table 10.2 (continued)

Effect of climate change	Impact on infrastructure	Potential adaptation responses
Larger waves caused by higher wind speeds or deeper water at protection structure	Higher wave loading on armour units	Place larger armour over existing units or create berm/beach in front of structure to induce early wave breaking and dissipation
	Increased frequency and volume of overtopping	Raise structure crest to reduce overtopping or armour backshore to tolerate higher flows or create berm/breakwater/beach in front of structure to induce early wave breaking and dissipation
Landward retreat of shoreline under rising sea level or faster lagoon currents	Erosion of sand from around ends of protection structures	Extend structure alongshore or re-align ends to accommodate new shoreline position
	Beach level lowers in front of structure	Extend or create deeper toe (base of protection structure) using additional armour material (rock, sand-filled geotextile bags etc.), sheet piling or concrete

Modified from Shand and Blacka (2017)

Pacific strengths around dialogue and the importance of relationships and reciprocity suggest ways to approach infrastructure adaptation. Brown et al. (2018) show that the collective nature of iTaukei communities in Fiji provides for better ability to recover from natural hazards, and Macpherson and Macpherson (2017) document success in government policies to manage water in Samoa, which was previously seen as a community owned resource. This success was attributed to the wide consultation process and emphasis on national interest, aligning with the importance of dialogue more broadly in PICTs. Similar experiences are occurring in the Cook Islands with major water supply and wastewater infrastructure development on the island of Rarotonga, again highlighting the importance of ongoing communication between government, donors, and other stakeholders. Chapter 11 covers traditional knowledge and its role in adaptation to the current climate change threats in the Pacific in detail.

Institutional arrangements in the Pacific affect infrastructure provision and adaptation. For example, informal settlements are often not included in the service areas for water supply authorities (Anthonj et al. 2020). Additionally the PICTs have some of the highest rates of non-revenue water in the Asia Pacific with rates between 30 and 60% (World Bank 2016). These high rates of non-revenue water also increase the operational expenditure, with particularly high rates in the Solomon Islands and Samoa leading to elevated costs of input water (World Bank 2016). Other institutional



Fig. 10.5 Cyclone damage to Avatiu Port from wave and storm surge impacts (Reproduced from Blacka et al. 2013)

barriers include the scarcity of experienced professionals, insufficient resources for operation and maintenance of existing infrastructure and poor infrastructure planning (Baker and Week 2011). For example, Falkland and White (2020) suggest that long term performance of RO units in the PICTs has been poor due to these types of barriers. Issues with operation and maintenance of infrastructure (PRIF 2014) have day-to-day impacts, as well as reducing the resilience of PICTs to natural disasters, which will likely become more severe with climate change (Pacific-Australia Climate Change Science and Adaptation Planning Program 2014).

One of the major constraints on infrastructure adaptation is that the ability to provide economies of scale through the Pacific is hampered by the geography of remote islands and distributed populations (Weir et al. 2017). Although tourism is an important part of the economies of many PICTs, most tourist infrastructure is private and of limited benefit to local communities (Baker and Week 2011; Pearce et al. 2018). Major public infrastructure investment relies on international donors and/or loans, which come with their own requirements and the priorities of donors (e.g., donor preferences may be for centralized infrastructure), and donor coordination can be poor (Baker and Week 2011). McNamara et al. (2020) found that

the high performing adaptation projects tend to be delivered by local organizations and/or locally funded, highlighting the value that comes from sustainable community involvement in adaptation and the importance of decentralized/local infrastructure, regardless of the source of funding, particularly given the remote geography.

10.5 Conclusion

Infrastructure plays a vital role in the provision of water, energy, and food in the Pacific region. Significant investment is required to ensure the continued efficient operation of this infrastructure under a changing climate. Countries such as Australia and New Zealand may have sufficient economic and technical resources to achieve these outcomes. However, the physical and institutional challenges that face PICTs are substantial. Communities in the PICTs have a long history of living with climate variability and particularly distinctive aspects of Pacific culture, such as collectivism, the importance of building relationships, and strong traditional knowledge of the climate, oceans, and land, can support resilience. The water-energy-food nexus is a useful framework for exploring infrastructure interdependencies, as shown in this chapter, because of the extensive linkages between infrastructure that supports multiple social and economic outcomes. These linkages are important day-to-day to support the livelihoods of Pacific communities but become even more vital during disaster response and recovery. With climate change expected to increase the prevalence and/or intensity of coastal and hydrological extremes, improving the resilience of infrastructure must be prioritized to further promote social and economic resilience in the Pacific. There are a number of steps that could be taken to improve the resilience of infrastructure in PICTs, thereby reducing the vulnerability of the Pacific population to threats to their water, energy, and food security.

- Framing infrastructure investment using the water-energy-food nexus is vital to ensure that the interconnectedness of infrastructure is not missed and to prevent maladaptation. Ad-hoc or individual infrastructure improvements will not increase the resilience of PICTs.
- Building knowledge and capacity within the region to:
 - Mainstream climate risk considerations as part of the initial design of new, and adaptation of existing infrastructure, such that integration with natural environmental systems and local knowledge is captured within designs, and that expertise is retained;
 - Improve design standards for infrastructure; and
 - Support maintenance of infrastructure across its functional life.
- Continuing to close the gap in scientific knowledge and use traditional knowledge of island-specific processes, such that infrastructure interventions are fit-for-purpose in terms of their own longevity, the service they provide, and the impact of the site-specific environment within which they sit.

- Ensuring whole-of-life sustainability for infrastructure interventions and integration of engineering and nature-based solutions, such that climate adaptation works appropriately reflect the scale required, and due consideration is given to the specific environmental and cultural context.

References

- ADB (2007) Oceanic voyages: shipping in the Pacific. Asian Development Bank. Available from <https://www.adb.org/sites/default/files/publication/29760/shipping-pacific.pdf>
- ADB (2014) Climate proofing ADB investment in the transport sector. Asian Development Bank, Mandaluyong City, Philippines. Available from <https://www.adb.org/sites/default/files/publication/152434/climate-proofing-adb-investment-transport.pdf>
- ADB (2018) Independent state of Samoa: port development project. Available from <https://www.adb.org/sites/default/files/project-documents/47358/47358-003-pda-en.pdf>
- Anthony C, Tracy JW, Fleming L, Shields KF, Tikoisua WM, Kelly E et al (2020) Geographical inequalities in drinking water in the Solomon Islands. *Sci Total Environ* 712: 135241
- Australia News Network (2014) King tides contaminate water, destroy crops in Kiribati. <https://www.abc.net.au/news/2014-03-07/an-king-tides-inundate-kiribati/5305394>. Accessed 6 Sept 2020
- Baker A, Week D (2011) Infrastructure and climate change in the Pacific. Department of Climate Change and Energy Efficiency
- Bates B, McLuckie D, Westra S, Johnson F, Green J, Mummery J, Abbs D (2016) Climate change considerations. In: Ball JE (ed) Australian rainfall and runoff: a guide to flood estimation. Geoscience Australia, Canberra
- Beetham E, Kench P (2018) Predicting wave overtopping thresholds on coral reef-island shorelines with future sea-level rise. *Nat Commun* 9:1–8
- Blacka M, Drummond C, Rahman P, Miller B (2019) Hydrodynamic investigation of Muri Lagoon and Avana Harbour, Rarotonga, Cook Islands. UNSW, Sydney
- Blacka M, Flocard F, Rayner D, Rahman P, Parakoti B (2013) A case study of vulnerability to cyclones and climate change: Avarua, Rarotonga. Presentation given at the 21st Australasian coastal and ocean engineering conference and the 14th Australasian port and harbour conference.
- Brown P, Daigneault AJ, Tjernstrom E, Zou WB (2018) Natural disasters, social protection, and risk perceptions. *World Dev* 104:310–325
- Chiew F, Young W, Cai W, Teng J (2011) Current drought and future hydroclimate projections in southeast Australia and implications for water resources management. *Stoch Env Res Risk Assess* 25:601–612
- Cook Islands Government (2016) Te Kaveinga Nui, National Sustainable Development Plan 2016–2020. Central Policy and Planning Office, Office of the Prime Minister, Rarotonga, Cook Islands
- Cook Island News (2013) Cargo boats to deliver supplies to outer islands. Available from <https://www.cookislandsnews.com/outer-islands/cargo-boats-to-deliver-supplies-to-outer-islands/>
- Cook Island News (2021) Desalination units assist water woes on drought-stricken Penrhyn. Available from <https://www.cookislandsnews.com/internal/national/outer-islands/desalination-units-assist-water-woes-on-drought-stricken-penrhyn/>
- Cox R, Panayotou K, Cornwell R, Blacka M (2014) Climate risk assessment for ports and connected infrastructure. Case study Avatiu Port, Rarotonga, Cook Islands. In: PIANC (ed) PIANC World Congress. San Francisco
- Cox R, Panayotou K, Cornwell RM (2013) Climate risk assessment of avatiu port and connected infrastructure. UNSW, Sydney

- Davies R (2015) Marshall Islands king tide floods. <http://floodlist.com/australia/marshall-islands-king-tide-floods>. Accessed 6 Sept 2020
- Dyer J (2019) The impact of climate change on the future of Pacific maritime supply chains, seaports and shipping: how stakeholders can adapt. Doctor of Philosophy, University of Tasmania.
- Elliott M, Macdonald MC, Chan T, Kearton A, Shields KF, Bartram JK et al (2017) multiple household water sources and their use in remote communities with evidence from Pacific Island Countries. *Water Resour Res* 53:9106–9117
- Falkland T, White I (2020) Freshwater availability under climate change. In: Kumar L (ed) *Climate change and impacts in the Pacific*. Springer Climate, Cham, pp 403–448
- Ferrario F, Beck MW, Storlazzi CD, Micheli F, Shepard CC, Airoidi L (2014) The effectiveness of coral reefs for coastal hazard risk reduction and adaptation. *Nat Commun* 5:1–9
- Gilman E, Van Lavieren J, Ellison V, Jungblut L, Wilson F, Areki G, et al (2006) Pacific Island mangroves in a changing climate and rising sea. United Nations Environment Programme Nairobi, Kenya
- Government of Tonga (2015) *Tonga Strategic Development Framework 2015–2025*. Tonga Ministry of Finance and National Planning, Nuku'alofa, Tonga
- Habert G, Billard C, Rossi P, Chen C, Roussel N (2010) Cement production technology improvement compared to factor 4 objectives. *Cem Concr Res* 40:820–826
- Hoeke R, Storlazzi C, Ridd P (2011) Hydrodynamics of a bathymetrically complex fringing coral reef embayment: wave climate, in situ observations, and wave prediction. *J Geophys Res Oceans* 116(C4). <https://doi.org/10.1029/2010JC006170>
- Hoeke RK, McInnes KL, Kruger JC, McNaught RJ, Hunter JR, Smithers SG (2013) Widespread inundation of Pacific islands triggered by distant-source wind-waves. *Glob Planet Change* 108:128–138
- Hope PK, Drosowsky W, Nicholls N (2006) Shifts in the synoptic systems influencing southwest Western Australia. *Clim Dyn* 26:751–764
- Howard G, Charles K, Pond K, Brookshaw A, Hossain R, Bartram J (2010) Securing 2020 vision for 2030: climate change and ensuring resilience in water and sanitation services. *J Water Clim Change* 1:2–16
- Johnson F, Higgins P, Stephens C (2021) Climate change and hydrological risk in the Pacific: a Humanitarian Engineering perspective. *J Water Clim Change* 12(3):647–678
- Khan SJ, Deere D, Leusch FDL, Humpage A, Jenkins M, Cunliffe D (2015) Extreme weather events: should drinking water quality management systems adapt to changing risk profiles? *Water Res* 85:124–136
- Kuleshov Y, McGree S, Jones D, Charles A, Cottrill A, Prakash B et al (2014) Extreme weather and climate events and their impacts on island countries in the Western Pacific: cyclones, floods and droughts. *Atmospher Clim Sci* 4:803
- Kumar L, Taylor S (2015) Exposure of coastal built assets in the South Pacific to climate risks. *Nat Clim Change* 5:992–996
- Lin C-C, Ho C-R, Cheng Y-H (2014) Interpreting and analyzing king tide in Tuvalu. *Nat Hazards Earth Syst Sci* 14:209
- Macdonald MC, Chan T, Elliott M, Kearton A, Shields KF, Barrington DJ et al (2017) Temporal and thematic trends in water, sanitation and hygiene (WaSH) research in Pacific Island Countries: a systematic review. *J Water Sanit Hyg Dev* 7:352–368
- MacPherson C, MacPherson LA (2017) Culture and the commodification of water in Samoa. *Asia Pac Viewp* 58:86–98
- Masselink G, Beetham E, Kench P (2020) Coral reef islands can accrete vertically in response to sea level rise. *Sci Adv* 6(24):eaay3656
- McNamara KE, Clissold R, Westoby R, Piggott-McKellar AE, Kumar R, Clarke T et al (2020) An assessment of community-based adaptation initiatives in the Pacific Islands. *Nat Clim Change* 10:628–639

- Ministry of Health Labour and Welfare (2018) Capacity development project on the planning and operation & maintenance of water supply system in the west and the north in the republic of Fiji. Available from <https://www.mhlw.go.jp/content/10900000/000360552.pdf>
- Monismith SG, Herdman LM, Ahmerkamp S, Hench JL (2013) Wave transformation and wave-driven flow across a steep coral reef. *J Phys Oceanogr* 43:1356–1379
- Pacific-Australia Climate Change Science And Adaptation Planning Program (2014) Climate variability, extremes and change in the western tropical Pacific: new science and updated country reports. Available from https://www.pacificclimatechangescience.org/wp-content/uploads/2014/07/PACCSAP_CountryReports2014_WEB_140710.pdf
- Pacific Infrastructure Advisory Center (2013) Infrastructure maintenance in the Pacific: challenging the build-neglect-rebuild paradigm. Pacific Region Infrastructure Facility, Sydney. Available from <http://prdrse4all.spc.int/system/files/149856004-infrastructure-maintenance-in-the-pacific-challenging-the-build-neglect-rebuild-paradigm.pdf>
- Paeniu L, Iese V, Jacot Des Combes H, De Ramon N'Yeurt A, Korovulavula I, Koroi A et al (2015) Coastal protection: best practices from the Pacific. Pacific Centre for Environment and Sustainable Development (PaCE-SD), The University of the South Pacific. Available from https://drive.google.com/file/d/0B7_cRuUWvik2VTZadG5lUkNsSG8/view
- Paerl HW, Gardner WS, Havens KE, Joyner AR, McCarthy MJ, Newell SE et al (2016) Mitigating cyanobacterial harmful algal blooms in aquatic ecosystems impacted by climate change and anthropogenic nutrients. *Harmful Algae* 54:213–222
- Parakoti B, Davie T (2007) National integrated water resource management diagnostic report: Cook Islands. Available from <https://cookislands-data.sprep.org/system/files/Islands%20-%202007%20-%20Cook%20islands.pdf>
- Pearce T, Currenti R, Mateiwai A, Doran B (2018) Adaptation to climate change and freshwater resources in Vusama village, Viti Levu, Fiji. *Reg Environ Change* 18:501–510
- PIANC (2020) Climate change adaptation planning for ports and inland waterways. PIANC, Brussels. Available from <https://www.pianc.org/shop/download/12611>
- Piggott-McKellar AE, Nunn PD, McNamara KE, Sekinini ST (2020) Dam(n) seawalls: a case of climate change maladaptation in Fiji. In: Leal Filho W (ed) *Managing climate change adaptation in the Pacific Region*. Springer International Publishing, Cham
- PRIF (2014) Infrastructure maintenance in the Pacific. Challenging the build-neglect-rebuild paradigm. Pacific Region Infrastructure Facility, Sydney. Available from https://www.theprif.org/sites/default/files/documents/build_neglect_rebuild_revised_full_report_2014.pdf
- PRIF (2017) Affordable coastal protection in the Pacific Islands. Pacific Region Infrastructure Facility, Sydney. Available from https://www.theprif.org/sites/default/files/documents/prif_affordable_coastal_report_web.pdf
- Quataert E, Storlazzi C, van Rooijen A, Cheriton O, van Dongeren A (2015) The influence of coral reefs and climate change on wave-driven flooding of tropical coastlines. *Geophys Res Lett* 42:6407–6415
- Radio New Zealand (2021) Water being shipped to drought-stricken northern Cook Island. Radio New Zealand. <https://www.rnz.co.nz/international/pacific-news/434229/water-being-shipped-to-drought-stricken-northern-cook-island>. Accessed 22 Nov 2021
- Schrecongost A, Wong K, Dutton P, Blackett I (2015) Delivering water and sanitation to Melanesian informal settlements. *Water: Journal of the Australian Water Association* 42:40
- Shand T, Blacka M (2017) Guidance for coastal protection works in Pacific Island countries. Pacific Region Infrastructure Facility (PRIF), Sydney. Available from https://www.theprif.org/sites/default/files/documents/guidance_for_coastal_protection_works_web.pdf
- Sinharoy SS, Pittluck R, Clasen T (2019) Review of drivers and barriers of water and sanitation policies for urban informal settlements in low-income and middle-income countries. *Util Policy* 60:100957
- Stephens CM, Johnson FM, Marshall LA (2018) Implications of future climate change for event-based hydrologic models. *Adv Water Resour* 119:95–110

- Stephens CM, Marshall LA, Johnson FM (2019) Investigating strategies to improve hydrologic model performance in a changing climate. *J Hydrol* 579:124219
- Storlazzi CD, Gingerich SB, van Dongeren A, Cheriton OM, Swarzenski PW, Quataert E et al (2018) Most atolls will be uninhabitable by the mid-21st century because of sea-level rise exacerbating wave-driven flooding. *Sci Adv* 4:eaap9741
- Taupo T, Noy I (2017) At the very edge of a storm: the impact of a distant cyclone on Atoll Islands. *Economics of Disasters and Climate Change* 1:143–166
- Terry JP, Chui TFM (2012) Evaluating the fate of freshwater lenses on atoll islands after eustatic sea-level rise and cyclone-driven inundation: a modelling approach. *Glob Planet Change* 88–89:76–84
- Terry JP, Falkland AC (2010) Responses of atoll freshwater lenses to storm-surge overwash in the Northern Cook Islands. *Hydrogeol J* 18:749–759
- Ummenhofer C, Gupta A, Pook M, England M (2008) Anomalous rainfall over southwest Western Australia forced by Indian Ocean sea surface temperatures. *J Clim* 21:5113–5134
- UN Trade and Development Board (2014) Small island developing states: challenges in transport and trade logistics. United Nations Conference of Trade and Development. Available from https://unctad.org/system/files/official-document/cimem7d8_en.pdf
- United Nations (2015) Transforming our world: the 2030 Agenda for Sustainable Development. United Nations, New York. Available from <https://sustainabledevelopment.un.org/content/documents/21252030%20Agenda%20for%20Sustainable%20Development%20web.pdf>
- United Nations (2020) SDG indicators United Nations Global SDG Dataset. <https://unstats.un.org/sdgs/indicators/database/>. Accessed 2 Jul 2020
- United Nations (2021) List of least developed countries. Committee for Development Policy. https://www.un.org/development/desa/dpad/wp-content/uploads/sites/45/publication/ldc_list.pdf. Accessed on 5 October 2021
- USACE (2002) Coastal engineering manual. United States Army Corp of Engineers, Washington DC
- Webb AP, Kench PS (2010) The dynamic response of reef islands to sea-level rise: evidence from multi-decadal analysis of island change in the Central Pacific. *Glob Planet Change* 72:234–246
- Weir T, Dovey L, Orcherton D (2017) Social and cultural issues raised by climate change in Pacific Island countries: an overview. *Reg Environ Change* 17:1017–1028
- White I, Falkland T (2010) Management of freshwater lenses on small Pacific islands. *Hydrogeol J* 18:227–246
- White I, Falkland T, Metutera T, Katatia M, Abete-Reema T, Overmars M et al (2008) Safe water for people in low, small Island Pacific Nations: the rural-urban dilemma. *Development* 51:282–287
- World Bank (2006) The Pacific infrastructure challenge: a review of obstacles and opportunities for improving performance in the Pacific Islands. World Bank Group, Washington. Available from <http://documents1.worldbank.org/curated/en/680631468249703830/pdf/360310Pacific01ture0Report01PUBLIC1.pdf>
- World Bank (2016) Climate and disaster resilience. World Bank Group, Washington. Available from <http://documents1.worldbank.org/curated/en/655081503691935252/pdf/119111-WP-PUBLIC-p154324-ppClimatechangebackgroundfinal.pdf>
- Youdale J, Tou B (2013) Avatiu Port development, Cook Islands. 21st Australasian coastal and ocean engineering conference and the 14th Australasian port and harbour conference. Engineer Australia, Sydney

The opinions expressed in this chapter are those of the author(s) and do not necessarily reflect the views of the UNESCO: United Nations Educational, Scientific and Cultural Organization, its Board of Directors, or the countries they represent.

Open Access This chapter is licensed under the terms of the Creative Commons Attribution-ShareAlike 3.0 IGO License (<https://creativecommons.org/licenses/by-sa/3.0/igo/>), which permits use, sharing, adaptation, distribution, and reproduction in any medium or format, as long as you give appropriate credit to the UNESCO: United Nations Educational, Scientific and Cultural Organization, provide a link to the Creative Commons licence and indicate if changes were made. If you remix, transform, or build upon this book or a part thereof, you must distribute your contributions under the same licence as the original.

The use of the UNESCO: United Nations Educational, Scientific and Cultural Organization's name, and the use of the UNESCO: United Nations Educational, Scientific and Cultural Organization's logo, shall be subject to a separate written licence agreement between the UNESCO: United Nations Educational, Scientific and Cultural Organization and the user and is not authorized as part of this CC-IGO licence. Note that the link provided above includes additional terms and conditions of the licence.

The images or other third party material in this chapter are included in the chapter's Creative Commons licence, unless indicated otherwise in a credit line to the material. If material is not included in the chapter's Creative Commons licence and your intended use is not permitted by statutory regulation or exceeds the permitted use, you will need to obtain permission directly from the copyright holder.



Part III
Cross-Cutting Themes for Security

Chapter 11

Adapting to Change? Traditional Knowledge and Water



Melissa Nursey-Bray, Sally Jerome Kororura, Monifa Fiu, Siosinamele Lui, Philip Malsale, Azarel Mariner, Filomena Nelson, Salesa Nihmei, Meg Parsons, and Espen Ronneberg

Future water adaptation approaches in the Pacific must be informed by traditional knowledge to enable the incorporation of localized, detailed, and historical knowledge and experience into contemporary management regimes.

Abstract Pacific Islander communities need to maintain traditional knowledge and practice about their water systems, despite the ongoing legacy of colonial impact, in order to adapt to climate change where its impacts will significantly impact water quality and reliability. Without healthy water systems, Pacific communities will become increasingly vulnerable. Traditional knowledge has a role to play in building the adaptive capacity of islanders to water shortages and in adapting to climate impacts over time. While colonization, belief in God, and loss of traditional knowledge are barriers to effective adaptation, Pacific Islanders across the region are using existing traditional knowledge in combination with other knowledge systems to build resilience to climate change and innovative adaptation solutions. Approaches informed by traditional knowledge enable the incorporation of localized, detailed, and historical knowledge, and experience into contemporary management regimes, which then enable the development of tailored and appropriate place-based adaptation. Importantly, the use of traditional knowledge also strengthens community receptivity to adaptation initiatives.

Keywords Pacific · Gender · Climate adaptation · Resilience · Water

M. Nursey-Bray (✉)

Department of Geography, Environment and Population, Faculty of Arts, Business, Law and Economics (ABLE), University of Adelaide, Adelaide, North Terrace, Australia
e-mail: melissa.nursey-bray@adelaide.edu.au

M. Fiu · S. Lui · P. Malsale · A. Mariner · F. Nelson · S. Nihmei · E. Ronneberg
Climate Change Resilience Programme, Secretariat of the Pacific Regional Environment Programme, Apia, Apia 240, Samoa

S. J. Kororura · M. Parsons
School of Environment, University of Auckland, Auckland, NSW, New Zealand

© UNESCO 2024

A. Dansie et al. (eds.), *The Water, Energy, and Food Security Nexus in Asia and the Pacific*, Water Security in a New World,
https://doi.org/10.1007/978-3-031-25463-5_11

229

11.1 Introduction

Pacific Island Countries and Territories (PICTs) face an uncertain future as they confront the impacts of extreme and rapid onset events such as cyclones, droughts, or heavy rainfall, which have tested past and present coping strategies by Pacific communities to safeguard their water security. Globally, water security is emerging as a major issue: global water demand is increasing at approximately 1% per annum, whilst between 4.8 and 5.7 billion people are projected to live in areas that are potentially water scarce for one month per year by 2050 (UNESCO World Water Assessment Programme 2019). In the Pacific, a dependence on water resources is additionally affected by a combination of structural fragilities which increase population demand for water and heighten inequality and poverty. In this context, climate change will place additional pressure on water resources and amplify water insecurity and risk. This chapter explores the cultural dimension of this challenge for PICTs by exploring how Indigenous and local knowledge (ILK)¹ can be deployed to build water security and resilience. We argue that ILK will be central to future water management and security in the Pacific and to date its historical application has enabled locals to survive, prosper, and live for many generations.

In the Pacific region ILK is being increasingly applied in management projects to combat climate change. For example, in the BoeBoe village, Solomon Islands, integrated traditional and scientific knowledge using participatory three-dimensional modelling (P3DM) is helping build responses to sea level rise (Leon et al. 2015) and in Tuvalu, traditional environmental knowledge has been used to assist policy makers in making adaptive decisions that reflect community risks and priorities, thus increasing the likelihood of community engagement in formal adaptation (Lazrus 2015).

We build on this work but focus on how ILK about water can be used to build water security in a time of climate stress. We note the interconnectedness of water to food and water to energy and that ILK for water is intrinsically tied to traditional agriculture and sustainable use of the local environment. The scope of this chapter focuses on the water aspect of the WEF nexus with context for the WEF approach provided in Chap. 1. We first provide an overview of climate threats for the region, and then provide a range of examples that highlight the use of ILK into water management across the Pacific. Our analysis then reflects on the factors that drive and impact on the success of these water adaptation initiatives. In this section, we argue that while there are many responses to address the climate impacts on water in the Pacific, that adaptation to it is also affected by the historical influence of colonization and Christianity. These two historical factors have not only impacted on Indigenous and local knowledge systems but in reflecting their own knowledge systems, create barriers to community acceptance of water adaptation programs based on climate (and other) science.

Ultimately, we argue that to achieve water security in the region it is crucial to acknowledge that numerous knowledge systems are co-existent in the Pacific:

¹ For this chapter we use the term Indigenous and Local Knowledge (ILK), as employed by the Intergovernmental Panel on Climate Change (IPCC).

ILK, religious (Christian) and Western scientific knowledges. All these knowledges co-exist to a greater or lesser extent depending on the place (island or even village context) and we argue that this represents a diversity which also brings a strength that can be harnessed to redress climate related water security issues into the future.

11.2 Climate Impacts and Water in the Pacific

PICTs are internationally recognized as highly vulnerable to an array of climate change impacts and related hazards. Systematic observations, research, and modelling have shown a range of climatic trends and associated hazards that have affected the region in recent decades. Such climate impacts are all the more acute given that 55% of the population in these countries live within 500 m of the coast, with 20% of those peoples living within 100 m of the coast. Predictions highlight that temperatures are likely to reach 1.5 °C between 2030 and 2052 (high confidence) (Watanabe et al. 2021; IPCC 2021) and sea level rise is likely to increase 0.5–0.6 m by 2100 compared to 1986–2005 (Australian Bureau of Meteorology and CSIRO 2014; Church et al. 2013). Overall, these impacts will create abrupt changes in the climate variability of the tropical Pacific region (Kleypas et al. 2015) including changes in precipitation (Barnett 2011) and the El Niño Southern Oscillation (ENSO). The ENSO, often referred to as individual La Niña or El Niño events, is a natural multi-year cyclical (as detailed in Chap. 5), but anthropogenic warming of the atmosphere is leading to increased uncertainty in the system and severity of weather-related events (Kumar 2020). For example, severe drought driven by a La Niña event in Tuvalu in 2011 led to a state of emergency, with impacts including groundwater contamination and water rationing (McGree et al. 2016). By contrast, extreme rainfall can cause damaging floods (Kuleshov et al. 2014) with such events forecast to increase with increased rainfall during severe weather events known to be associated with human-induced climate change (Kumar 2020; IPCC 2021). Cyclone frequency globally is projected to increase due to climate change (IPCC 2021, B.24; Christensen et al. 2013), but this trend is not clear for the Pacific. However, it is widely agreed that in the Pacific, and globally, they will be more intense and damaging when they occur (Keener et al. 2013; IPCC 2021). Further, projected ocean warming and acidification (IPCC 2021; Wu et al. 2018) is causing ecosystem vulnerability in the southwest Pacific (Smale et al. 2019). The pH of the tropical Pacific Ocean is decreasing at a rate of 0.02 units per decade: projections estimate this may decrease by 0.15 units relative to 1986–2005 by 2050 (Hoegh-Guldberg et al. 2014). This will cause related impacts such as decline in coral cover (Hoegh-Guldberg et al. 2014), which will in turn impact fishing and greatly reduce food security due to the heavy reliance on marine sourced contributions to Pacific diets (Chap. 4).

There will a number of direct impacts on both people and the environment that will include damages to health, water and other infrastructure, and people. For example, Cyclone Pam in 2015, not only disrupted ecosystems, but also destroyed 21 of the

24 health facilities across the 22 affected islands (Esler 2015) with ongoing indirect impacts including an increase in the geographic ranges of vectors and increased pathogen loads in food and water (McIver et al. 2012). The three global biodiversity hotspots located within the Pacific region will also be affected, causing severe impacts on regional biodiversity (Taylor and Kumar 2016). As Kumar and Tehrany (2017) found in their assessment of 23 countries in the Pacific, 674 of the islands host at least one terrestrial vertebrate species that is either vulnerable, endangered, or critically endangered.

However, notwithstanding the regional trends, it is crucial to recognise that climate risk profiles, as well as water security risk, will vary on an island-by-island basis (Kumar et al. 2020). This variation results from diverse island geography, geology, and topographic characteristics. In relation to water security, the main climate risks to which all islands are exposed are temperature rise, changes to rainfall regimes, and sea-level rise. There are also risks from tropical cyclones and drought, but these do not affect the entire Pacific in the same manner, for the reasons outlined above. Non-climate risks further complicate water security (Chap. 2) and certainty for building resilience against current and future climate change impacts. The main non-climate risks are those due to increasing human demand for water due to the increasing human population increasing demand for water, food, and energy, changes in urban versus rural population demographics, and increased use for industrial and “development” of the country and economy.

For the atoll countries in the Pacific, that do not have strong mountainous features (like some higher volcanic islands), the situation under climate change is especially challenging (Zack and Ronneberg 2003). Fresh groundwater lenses located in the shallow subsurface environment of oceanic carbonate islands and atolls throughout the Pacific represent the only naturally occurring potable water supply, where no rainfall catchment infrastructure exists (Chap. 2). The groundwater lenses have formed from rainfall percolating through the soil to reside in fragile hydrodynamic equilibrium with the underlying saltwater, separated by slight differences in density. During prolonged drought and increased demand for fresh drinking water, the lenses become thinner, and the sustainable withdrawal of fresh groundwater becomes limited by saltwater contamination. In limestone or coralline islands and atolls, such saltwater intrusion is a vertical phenomenon (Polemio and Walraevens 2019). Pumping wells—screened in the freshwater lens—can induce a vertical flow component from the underlying saltwater regions, causing the saltwater to migrate upwards and become intercepted by the pumping well. The development of fresh groundwater supplies under these circumstances has been problematic to island water authorities. Also, saltwater coning during groundwater pumping agitates the interface, further widening the zone of diffusion and dispersion, and ultimately reducing the freshwater lens thickness.

For many atoll countries in the Pacific, freshwater lenses are the only source of water (Chap. 2). Usually less than 15 m deep, they are recharged by rainfall and tend to float on the top of denser seawater (Zack and Ronneberg 2003). Many factors determine the formation of freshwater lenses on islands and atolls, in terms of their distribution, geometry, and permanence. Lenses are thicker on atolls with larger,

more elevated landmasses and those receiving the greatest rainfall, evenly distributed throughout the year. Freshwater lenses are subject to many threats, in particular salt-water intrusion, droughts, storm surges, unsustainable water abstraction, and coastal erosion (Klaver et al. 2019). These factors may change salinity levels of the lenses as well as reduce their size. Climate change will amplify these effects and impact water security (Chaps. 2 and 5).

11.3 Traditional Knowledge in the Pacific

The utility of traditional knowledge for adaptation is increasingly grounded in evidence (Nakashima et al. 2018; Pearce et al. 2015; Nursey-Bray et al. 2020; Bryant-Tokalau 2018; Lebel 2013; Nunn et al. 2014; McNamara et al. 2020; 2016a, b), and internationally, there are calls to embrace Indigenous knowledge (IPBES 2019). The use of ILK can enhance scientific knowledge by revealing details within environmental systems and plays a critical role in enabling resilience and facilitating adaptation to climate change (Finn et al. 2017; Huntington et al. 2017; Plotz et al. 2017). Globally ILK is increasingly recognized as offering the opportunity to create locally appropriate climate adaptation strategies (Ford et al. 2016; Nalau et al. 2018). For example, Indigenous farmers in Bolivia and the Peruvian Andes assisted scientists to discover links between El Niño and tropospheric cloud cover by deploying and sharing their knowledge about how to forecast weather patterns (Orlove et al. 2002). In Mongolia, ILK is being used to respond and adapt to the changes in temperate dryland ecosystems (Tugjamba et al. 2021), and in Australia, there are many examples of how traditional knowledge is progressing adaptation, whether in the north (Leonard et al. 2013a, b; Bird et al. 2013) or the central desert (Nursey-Bray et al. 2013, 2020). Examples of the importance of incorporating ILK into management include the use of Aboriginal fire management approaches in Australia (Bliege Bird et al. 2018), Sami knowledge of reindeer herding (Eira et al. 2013), rainwater harvesting in India (Bhattacharya 2015), and Indigenous farming methods in Africa (Basdew et al. 2017; Faye et al. 2021).

Yet, despite the loss of components of ILK, the worldviews and ethics of many Pacific Islanders continue to be shaped by ILK. The Samoan way of life (*fa'asamoa*) for example, emphasizes the importance of collective wellbeing, the duties and responsibilities individuals possess to one's family (*aiga*) as well as to their wider community (their village and Church). The practice of reciprocity is critical (Parsons et al. 2017). In other areas of the Pacific, people draw on multiple knowledge systems, particularly Christianity, scientific knowledge, as well as ILK, to explain and interact with the world around them (including their understandings of climate change, and how best to manage the security of their water and food supplies). For the Indigenous people from the small atoll island of Andra in Papua New Guinea, for instance, the Catholic Church now plays a critical role in daily life, beliefs, and feelings of belonging and social networks. In particular, women from Andra Island report that the Catholic Church's women's networks have created strong linkages within and

between island communities and fosters a sense of community cohesion (both intra- and inter-island). The sense of community and shared cultures (across clan and island groups), the women argue, is essential to them being able to work together and provide assistance to one another in times of crisis. In contrast, Andra Island men consider that it is their customary or traditional systems of governance (laws, decision-making processes, and socio-cultural institutions) that underpin their social cohesion (lack of inter-personal conflict and collective distribution of resources). This translates into high social capital. In particular, the men of Andra Island note how one person (known as the hausbois) on the council governs the clan representing each sub-clan group. However, the position of hausbois is restricted to men (as is the role of the chief) and women become excluded from decision-making processes. Accordingly, the Catholic Church's women's group provides women with an avenue to participate in discussions about community matters as well as plan for and respond to crises, including droughts and floods, effectively bypassing the patriarchal clan governance system.

In some parts of the Pacific, particularly in remote locations away from large urban areas and western-style development activities, different communities continue to employ ILK as their central way to monitor environmental conditions, make decisions about natural resource management, and manage environmental risks (Rarai 2018). Farmers in Niue (Fig. 11.1) for example benefitted from inclusion of traditional knowledge (TK) in weather reports. In the Northern area of Pentecost Island (Vanuatu), ILK is still widely employed by Indigenous people to forecast weather conditions, enact natural resource management strategies, and reduce their vulnerability to climate extremes. Individuals carefully observe cloud formations, winds, and waves, as well as the behaviour of plants and animals (all-important environmental indicators) to forecast weather conditions (months, weeks, or days in advance). Such an understanding of the interconnectivity of all living beings underpins Pacific Islander knowledge systems and parallels the holistic nature of ILK more generally as discussed previously by numerous scholars (Berkes 1999; Leonard et al. 2013a, b; Nalau et al. 2018; Nursey-Bray 2016). The next few sections present case studies which shed light on how traditional knowledge is being brought to bear on water management in the context of climate change.

11.3.1 Case Study 11.1. Water Management and the Northern Pentecost Island, Vanuatu

Freshwater management is an ongoing challenge for the Indigenous peoples of Northern Pentecost Island (NP) due to natural variability of precipitation rates as well as increased variability associated with climate change; however, Indigenous communities are successfully employing a variety of ILK-based and western knowledge-based water management strategies to reduce their vulnerability to water insecurity. One issue faced in NP is how to store rainwater for and during drought events (such as associated with El Niño). Historically, the only source of water



Fig. 11.1 Hakupu agriculture show day, Niue. Farmers in Niue benefited from inclusion of traditional knowledge (TK) in weather reports (© Siosinamele Lui)

when the rivers and streams dried out (during extreme droughts), were the coiled roots of large trees that held water (tumu). Accordingly, many NP people recall the difficulties that they and their ancestors faced with water shortages during droughts. However, NP people traditionally used a variety of methods to store water and manage water usage to prepare for and manage drought conditions, which continue to be utilized to a greater or lesser degree in different villages on Pentecost Island.

These include coiled roots of large trees, coconut stems, and dug ground wells. However, over the last two decades, the introduction of new knowledge about community health (underpinned by scientific knowledge), as well as new technologies to parts of NP resulted in a shift away from water storage techniques based solely on ILK to one that incorporates multiple knowledges and approaches. The local people from Ahivo and Aute districts, for instance, continue to rely on rainwater for their water supplies, but now store their freshwater supplies (used for drinking and cooking only) in cement and plastic water tanks (that can store between 6,000 to 10,000 L of water). These new technologies help local villagers manage water more effectively during droughts, with nearly every household now having water tanks (Rarai 2018). Research participants observe that now, with the water tanks and careful communal management of water usage, villages typically possess enough water to last them throughout the dry season or drought event.

Alongside new technologies, residents manage freshwater supplies (particularly during frequent drought events linked to El Niño conditions, worsening because of climate change) using a mixture of western technologies (water storage) and

traditional water management practices. Rather than emphasize individual water rights and usage, water is collectively managed and strictly monitored. Water is also more freely available due to the introduction of western-style portable water tanks and containers. The combination of western water storage techniques and traditional methods of water management has meant that the Pentecost community is better prepared to respond to climate impacts on water.

11.3.2 Case Study 11.2. Water and Food Adaptation Strategies

A range of water adaptation strategies are being used in many regions. Onesomw Island, Micronesia, which is located in the Chuuk State lagoon, has already been affected by climate change, particularly during typhoons and high tide events. Fresh-water supplies are affected by coastal flooding, drought, and saltwater intrusion. However, to address these impacts, the Onesomw community has drawn on its ILK and revitalized traditional wells and undertaken a range of management actions including (1) cleaning them, (2) planting buffer strips around them to stabilise banks, and (3) installing covers on the wells to reduce pollution and contamination (McLeod et al. 2018).

Increasingly, traditional farming practices are also being revitalized. The use of traditional knowledge in this way has enabled Pacific islanders to build food security and combat water insecurity. Some methods include shading crops with palm leaves, maintenance of trees around other plants to make shade and the use of seaweed for compost. For example, the Ahus people of Manus Island in Papua New Guinea have implemented revitalized crop practice, developed raised gardens, and instituted local water collection in drums and small tanks (McLeod et al. 2018). They have diversified their crops and raised beds to avoid saltwater intrusion and initiated aquaculture projects. Elsewhere in Palau, the GEF-SPREP Pacific Adaptation to Climate Change project has supplied and tested various varieties of salt resistant taro. Three national varieties have now been selected for wider use.² In the Yap islands, community members have established a nursery using traditional composting techniques and in so doing have reduced reliance on depleted fish stocks, diversified food, and protected water supplies (Nunn et al. 2016a, b). Nalau et al. (2018) highlight extensive application of climate adaptation activities which have a strong ILK focus including crop rotation systems in Tanna Island in Vanuatu and historical climate adaptation in Samoa where traditional water rainwater harvesting has been strengthened to adapt to current challenges. Another example, as illustrated in Fig. 11.2, is in Tonga, where resident farmers are using TK to work out how to predict and manage rainfall and drought.

In Vanuatu, traditional knowledge has been deployed to build an innovative water adaptation program via music (Grant 2019). Port Vila, one of the world's most at risk

² See <https://www.youtube.com/watch?v=MWXYRq11pZc>.



Fig. 11.2 Young man tending his yam and taro patch in Nukualofa, Tonga. Tonga is now incorporating TK in practical outreach to farmers around rainfall predictions and drought (© Siosinamele Lui)

cities from climate change (Komugabe-Dixson et al. 2019) will experience (amongst other impacts) poorer water quality, intrusion of saltwater into freshwater systems and the associated impacts of floods and drought. In order to preserve their *kastom*, villagers relocated to a place called Luganville and decided to protect their knowledge via establishment of the Leweton Cultural Village. This move was meant to “enable and encourage the continued practice in the community, across all generations, of the language and cultural traditions of Gaua and Merelava” (Grant 2019, 44). One of these cultural practices is called “Etetung”. This means Vanuatu Women’s Water Music and is a form of water percussion. The practice of Etetung has enabled the articulation and keeping of cultural knowledge about water, its importance, and use for generations. It is a:

sonic way of knowing and understanding the world, an acoustemology...as the women of Leweton represent in the water the sounds familiar to them through their experience of the world...a dolphin, falling rain on taro leaves, thunder, a waterfall, whale fish, skull fish, certain local species of birds, water ebbing back through the rocks at high tide—they manifest ‘localized creative dialogue with the specificity of place’ through their performance. (Grant 2019, 50)

Today, the Etetung is a top cultural tourist attraction for Vanuatu, but more than that, it enables an active and contemporary expression of traditional knowledge about water. In so doing, the tourism it drives becomes in effect a form of cultural water adaptation for the community. It does so in two ways; first by preserving traditional

knowledge through performance and second, it enables the purchase of important resources that will build ongoing adaptive capacity—financial returns have enabled the building and improvement of water and other infrastructure in the villages. As one of the villagers reflects in the context of the relationship between the Etetung, knowledge and adaptation: “Climate change changes everything about nature and us...if we keep our culture strong, we can keep our nature alive” (cited in Grant 2019).

11.3.3 Case Study 11.3. Drought Management in Abaiang Island, Kiribati

On the island of Abaiang, Kiribati, a number of villages are vulnerable to the impact of climate related drought. Drought affects village health and well-being because freshwater becomes brackish, and hard to access over time (Sutton et al. 2015). Despite these impacts however, the residents of Abaiang have taken pro-active steps to plan for drought based on a commitment to work with the resources they have to build adaptive capacity. Implemented at village, household, and island levels, drought actions assist villages to make decisions about what they do both prior to and during droughts. This adaptation employs traditional knowledge to help islanders adapt at multiple scales. One strategy is to conserve fresh well water near houses, so that it is protected from contamination and so that during droughts it can be consumed without any adverse health impacts (Sutton et al. 2015). The drought planning for the island is operationalised by an eight-step communications plan, which is implemented via a network of village drought committees that undertake the required actions (Sutton et al. 2015).

Actions at household level include by-laws, water monitoring, and identification of appropriate wells, including those where the owners are willing to share resources. Installation of pipes re-route overflows, and gutter and downpipes are put in and maintained. At community level, actions include the repair of leaks, weekly inspections, and community by laws to ration freshwater (Sutton et al. 2015).

At an island scale, water is transported to vulnerable communities, people are temporarily relocated to areas of low vulnerability, and funds are allocated to improve and repair water systems overall (Sutton et al. 2015). Collectively, this case study reflects how groups of people work together to bring their knowledge and know-how to the mutual endeavour of protecting and maintaining their water supplies amidst climate-related drought events (Sutton et al. 2015). The actions taken by islanders in this case, show the capacity to respond and build adaptive capacity by harnessing existing resources in a creative and effective way.

11.4 Discussion: Water Security in the Pacific—Barriers to Change

It is clear that across the Pacific, different peoples are not only experiencing climate-related water insecurity, but also using their ILK systems to address them. However, there exist other factors that affect contemporary adaptation in practice, and which need to be acknowledged before adaptation can fully occur. One of these factors is the legacy of colonization in the Pacific, and by association, the introduction of Christianity. This needs consideration in three ways: (1) the impact of colonization on ILK and traditional knowledge (TK), (2) the specific and lived reality of Christianity today, and (3) the privileging of Western knowledge and science (imported by colonization) which has occurred. All three elements shape and affect traditional approaches to a challenge like water security.

In parts of the Pacific for example, Euro-Western imperialism and colonialism (be it British, French, Australian, New Zealand, United States, German, Spanish, or Japanese) as well as the arrival of Christianity since the eighteenth century onwards has caused massive changes to Pacific knowledge systems, laws, governance, and management approaches, and ways of life. The arrival of, and conversion to Christianity in much of the Pacific significantly altered ILK both in terms of its intergenerational transmission and day-to-day usage. Some places saw substantive reduction in the use of ILK as missionaries and Christian leaders sought to restrict or ban the use of what was called then “heathen” knowledge. Despite these impacts, it is important to recognize that Christianity is now an embedded and important part of many Pacific Island cultures, and an active living knowledge system in its own right. As such, Christianity is deployed as an additional knowledge system that is exercised alongside ILK. However, at times, these knowledges conflict as climate change becomes explained by and within religious, rather than traditional norms. For example, while many Islanders might attribute various impacts to climate change, they in turn attribute climate change per se to ‘God’s will’, believing it is ‘God’s punishment’, or a warning from God to behave better. Some see climate change as the harbinger of the end of times spoken about in some Christian traditions (Janif et al. 2016). In the Fijian village of Nawairuku, for example, the Bible remains a key authority and informs current adaptive strategies to climate change—sometimes supporting them and at others acting as a barrier to change (Currenti et al. 2019). The influence of religion is overlain in turn by the predominance of Western science and processes, which as another competing knowledge system, has similarly overtaken traditional ones. In being prioritized and valorized by the colonizers, Western scientific knowledge has become entrenched in contemporary environmental and policy management modes. ILK and ways of doing things is not accorded automatic space to flourish. In practice, the parallel existence of Christian and Western scientific knowledge systems (effectively the living legacy of historical colonization) with ILK, fractures opinion and ideas around how to manage for the latest challenge—climate change.

This shift in emphasis on what is ‘useful’ knowledge and the fact all knowledges compete now for attention in the contemporary world, has meant that local and traditional knowledge in some regions have experienced large scale decline in use as well as deterioration in content (Campbell 1990; Hetzel and Pascht 2017; Hofmann 2017; Kuruppu and Liverman 2011). Many Samoans, for instance, do not widely employ ILK-based environmental information to forecast weather conditions and make decisions about natural resource management, even though they may be aware of such knowledge. Instead, they rely on the weather forecasts and hazard warnings produced by government or news media (which they receive via the internet, TV, and radio) (Lefale 2010; Mow et al. 2017; Nalau et al. 2017; Parsons et al. 2017).

Such loss of ILK (particularly of environmental information) because of the introduction of new knowledge systems, economies, technologies, educational curricula, and modes of living is commonplace. Indeed, the movement of people (temporarily or permanently) from rural to urban areas, people’s exposure to new ideas, technologies, and knowledges, as well as the adoption of different livelihoods, individually and cumulatively, result in people being less likely and less able to engage with their local environments (Davies 2015; Gharbaoui and Blocher 2016; Granderson 2017; Hetzel and Pascht 2017; Kuruppu 2009). Further, lack of interactions with local environments (and unfamiliarity with environments particularly in the case of migrants) means that the information that used to be shared by elders is no longer accessed, especially their knowledge of how to monitor environmental conditions and formulate forecasts about weather conditions. Crucial information is thus not being applied to decision-making about how to maintain human security (food, water, physical safety) and responding to environmental risks (Carson et al. 2018; Haynes et al. 2011; Leonard et al. 2013a, b).

In other instances, the reliance on just *one* knowledge system can have maladaptive impacts. For example, the reliance on Western water technologies and approaches, and their implementation via top-down approaches mitigate their effectiveness on the ground. Without taking account of local knowledge about people’s way of life (e.g., gender roles, see Chap. 13), ways of managing and governing for, their understanding of and values about water, there is an implicit assumption from many donors that one size fits all. As a result, throughout the Pacific, adaptation strategies have often failed to reduce community vulnerability to variable water supplies (Le Dé et al. 2018; Pearce et al. 2018). Not only does the reliance on technology mean there is diminished use of ILK, but that when there is a drought, local peoples suffer more than they would have in the past as they have stopped or lost the knowledge about traditional water conservation techniques. They are therefore more at risk such as when drought or a saltwater intrusion event occurs.

Another significant dimension to achieving effective water adaptation is the fact that women’s ILK receives little attention. In many parts of the Pacific women hold unique ILK and it is essential for and tied to water and land security. Yet the imposition of colonization has changed male/female roles to privilege men. For instance, in many parts of Micronesia, land tenure is passed down the female line and a substantive amount of ILK is held by women, whereas men’s ILK is associated with the sea and ocean and fishing/harvesting. Yet, men are the ones who the colonizers mandated

Table 11.1 Diversity of adaptations by Pacific women at various scales

Palau	When cutting grass, women leave parts of it to protect the ground
Kosrae	Palms leaves laid over soil
Republic of Marshall Islands	Mangroves and pandanus planted to prevent coastal erosion
Kosrae and Chuuk	Women rely on traditional knowledge and practice to manage drought including the drying and fermenting of breadfruit to offset food insecurity
Pohnpei	Knowledge held by women of locations of traditional wells, supports them to find potable water and build new shallow wells (summarised from McLeod et al. 2018)

with positions of authority as government leaders or chiefs meaning that men occupy positions of power and women were (and still are) predominantly excluded from formal decision-making processes (at higher levels for both government and tribal). It is critical for those undertaking or supporting ILK projects (be it research institutions, NGOs, governments) to include a diversity of participants within and across Indigenous communities (Aikman 2019; Berkes 1999; Ohmagari and Berkes 1997; Voeks 2007).

There are several strategies by which this may be enacted—specific ILK held by women could be recognised and supported more by governments, researchers, and NGOs for a start (McLeod et al. 2018). Pacific women are involved in adaptation projects at multiple levels and scales as shown in Table 11.1.

However, getting Pacific women involved in such existing and new adaptation projects requires increased access to climate change funding and support from organizations to allow them to meet the requirements of international climate change grants (McLeod et al. 2018). Aid organizations need to ensure they are not just talking the talk but walking the walk in offering the appropriate assistance. Women from Pacific small island developing states could also be offered specific education and training to women’s groups to allow them to create strategic action plans, mission statements, learn financial reporting requirements, as well as general leadership and institutional training (McLeod et al. 2018).

11.5 Moving Forward: Co-existence of Knowledge for Water Security

Different islands face different climate challenges, and have each experienced, and manifest a diverse composite of knowledge production and dissemination. Today, as a result of the long history of Christianity and colonization, multiple knowledges exist and are juggled in the Pacific—traditional (ILK), religious (Christianity), and Western scientific. In the Marshall Islands for example, climate change is understood as a blend between clan magic, biblical exegesis, and scientific knowledge

(Rudiak-Gould 2013). In others, as is the case in Tuvalu, climate change is an abstract concept, not real, too distant to worry about, or—as it is based in Christian belief—perhaps beyond one’s control anyway (Mortreux and Barnett 2009). Moving forward, we suggest that building water security in the Pacific will require the delicate balancing of multiple knowledges and ontologies. Taking a nexus approach to build this security across water, energy, and food systems places increased reliance in ILK as part of the balancing act, in recognition of these interconnected systems and their traditionally interconnected management and understanding, before colonialization and outside knowledge systems. As Barnett (2010) asserts, adaptation approaches require acknowledging of the plurality of perceptions and approaches about climate change so that they can enable the creation of locally appropriate responses that are sustainable over time and space.

11.6 Conclusion: Recommendations for Ways Forward

The future will continue to bring many challenges to PICTs and, as we have explored on a case-by-case basis, how these challenges are experienced will be differentiated and place-based. Water security, access to it, its quality and use will all be affected by climate change, but as we have shown, also by the ways in which historical and new knowledges work together to produce solutions. As with many other regions, there is a clear need to build adaptation—in this case for water—in ways that are tailored to local cultures and communities and align with cultural ways of knowing and being. In this context, adaptation approaches need to recognize that knowledge itself is a differentiated and sophisticated entity, with multiple knowledge systems vying for attention. Adaptation programs that create the entry point to allow a flexible weaving between and within different knowledges will work to their strengths, to create more robust adaptation overall. To ensure effective implementation however, working out ‘how’ to do it is not enough: working out ‘who’ will be implementing it will be of equal importance. In this context, developing effective, culturally appropriate—and palatable—modes of governance, will be essential, and ideally, will include local peoples so that local voices can be heard and represented in decision making processes. Building local agency in this way will have benefits in the water adaptation frameworks that will evolve. Finally, it is important to remember at all times that climate change as it manifests today, is a new challenge for us all. As such, enabling Pacific Islanders to be trained and equipped in how to adapt to this change in both Western scientific, as well as cultural management approaches will enable all parties, from local community groups, to international NGOs, politicians, and policy makers, to face climate change together. As such, we recommend the following for consideration in future planning for water adaptation in the Pacific.

- That water adaptation programs are tailored to the local conditions and specific likely and predicted climate impacts.

- That Indigenous and local knowledge systems are recognized and appropriately incorporated into water policy and planning.
- That local governance arrangements include local people who can actively participate in and bring their own perspectives and knowledges into the water adaptation and policy.
- That Pacific Islanders are trained in scientific management and knowledge so as to strengthen opportunities for integrated water planning.

References

- Aikman S (2019) Indigenous knowledge, skills and action: Indigenous women's learning in the Peruvian Amazon. *Stud Educ Adults* 51(2):195–212
- Australian Bureau of Meteorology and CSIRO (2014) *Climate Change in the Pacific: Scientific Assessment and New Research*. Volume 1: Regional Overview. Volume 2: Country Reports
- Barnett J (2011) Dangerous climate change in the Pacific Islands: food production and food security. *Reg Environ Chang* 11(1):229–237
- Barnett J (2010) Adapting to climate change: three key challenges for research and policy—an editorial essay. *Wiley Interdiscip Rev Clim Change* 1(3):314–317
- Basdew M, Obert J, Mafongoya L (2017) Integration of indigenous and scientific knowledge in climate adaptation in Kwa Zulu Natal, South Africa. *Chg and Adapt in Socio-Ecol Syst* 3(1):56–67
- Berkes F (1999) *Sacred ecology: traditional ecological knowledge and management systems*. Taylor & Francis, Philadelphia
- Bhattacharya S (2015) Traditional water harvesting structures and sustainable water management in India: A socio-hydrological review. *Int Lett Nat Sci* 37:30–38
- Bird D, Govan J, Murphy H, Harwood S, Haynes K, Carson D, et al (2013) *Future change in climate adaptation in northern Australia*. (NCCARF Publication; 117/13). Gold Coast: National Climate Change Adaptation Research Facility
- Bliege Bird R, Bird DW, Fernandez LE, Taylor N, Taylor W, Nimmo D (2018) Aboriginal burning promotes fine-scale pyrodiversity and native predators in Australia's Western Desert. *Biol Conserv* 219:110–118
- Bryant-Tokalau J (2018) *Indigenous Pacific approaches to climate change*. Pacific Island Countries Springer International Publishing, Cham
- Campbell JR (1990) Disasters and development in historical context: tropical cyclone response in the Banks Islands, Northern Vanuatu. *Int J Mass Emerg Disasters* 8(3):401–424
- Carson SL, Kentachime F, Nana ED, Njabo KY, Cole BL, Godwin HA (2018) Indigenous Peoples' concerns about loss of forest knowledge: implications for forest management. *Conserv Soc* 16(4):431–440
- Christensen J, Kanikicharla K, Marshall G, Turner J (2013) Climate phenomena and their relevance for future regional climate change. In: *IPCC WGI Fifth Assessment Report*. Cambridge University Press, Cambridge
- Church J, Clark P, Cazenave A, Gregory JM, Jevrejeva S, Levermann A, Payne AJ (2013) Sealevel and ocean heat-content change. *Int Geophys* 103:697–725. <https://doi.org/10.1016/%20B978-0-12-391851-2.00027-1>
- Currenti R, Pearce T, Salabogi T, Vuli L, Salabogi K, Doran B, et al (2019) Adaptation to climate change in an interior Pacific Island village: a case study of Nawairuku, Ra, Fiji. *Hum Ecol Interdiscip J* 47(1): 65–80
- Davies K (2015) *Kastom, Climate Change and Intergenerational Democracy: Experiences from Vanuatu*. In: Leal Filho W (ed) *Climate change in the Asia-Pacific Region*. Springer, Cham. pp 49–66. https://doi.org/10.1007/978-3-319-14938-7_4

- Eira IMG, Jaedicke C, Magga OH, Maynard NG, Vikhamar-Schuler D, Mathiesen SD (2013) Traditional Sámi snow terminology and physical snow classification—two ways of knowing. *Cold Reg Sci Technol* 85:117–130
- Esler S (2015) Vanuatu post-disaster needs assessment tropical cyclone Pam. Government of Vanuatu, Vanuatu. <https://dfat.gov.au/about-us/publications/Documents/post-disaster-needsassessment-cyclone-pam.pdf>
- Faye J, Hopple A, Bridgham S (2021) Indigenous farming practices increase millet yields in Senegal, West Africa. *Agroecol Sustain Food Syst* 45(2):159–174
- Finn S, Herne M, Castille D (2017) The value of traditional ecological knowledge for the environmental health sciences and biomedical research. *Environ Health Perspect* 125(8):085006
- Ford JD, Camerson L, Rubis J, Mailliet M, Nakashima D, Willox AC, Pearce T (2016) Including Indigenous knowledge and experience in IPCC assessment reports. *Nat Clim Change* 6(4):349
- Gharbaoui D, Blocher J (2016) The reason land matters: relocation as adaptation to climate change in Fiji Islands. In: Milan A, Schraven B, Warner K, Cascone N (eds) *Migration, risk management and climate change: evidence and policy responses* Springer, Cham, pp 149–173. https://doi.org/10.1007/978-3-319-42922-9_8
- Granderson AA (2017) The role of traditional knowledge in building adaptive capacity for climate change: Perspectives from Vanuatu. *Weather Clim Soc* 9(3):545–561. <https://doi.org/10.1175/WCAS-D-16-0094.1>
- Grant C (2019) Climate justice and cultural sustainability: the case of Etétung (Vanuatu Women's Water Music). *Asia Pac J Anthropol* 20(1):42–56. <https://doi.org/10.1080/14442213.2018.1529194>
- Haynes K, Bird D, Carson D, Larkin S, Mason M (2011) Institutional response and Indigenous experiences of Cyclone Tracy. National Climate Change Adaptation Research Facility, Gold Coast, 79 pp. https://nccarf.edu.au/wp-content/uploads/2019/03/Haynes_2011_Indigenous_experiences_of_Cyclone_Tracy.pdf Accessed 31 Aug 2020
- Hetzel D, Pascht A (2017) Young ni-Vanuatu encounter climate change: reception of knowledge and new discourses. In: Dürr E, Pascht A (eds) *Environmental transformations and cultural responses: ontologies, discourses, and practices in Oceania*. Palgrave Macmillan, New York, pp 103–124. https://doi.org/10.1057/978-1-137-53349-4_5
- Hoegh-Guldberg O, Cai R, Poloczanska ES, Brewer PG, Sundby S, Hilmi K et al (2014) The ocean. In: *Climate change 2014: impacts, adaptation, and vulnerability. Part B: Regional aspects. Contribution of Working Group II to the Fifth Assessment Report of the Intergovernmental Panel on Climate Change*. Cambridge University Press, Cambridge
- Hofmann R (2017) Experiencing environmental dynamics in chuuk, Micronesia. In: Dürr E, Pascht A (eds) *Environmental transformations and cultural responses: ontologies, discourses, and practices in Oceania*. Palgrave Macmillan, New York, pp 75–101. https://doi.org/10.1057/978-1-137-53349-4_4
- Huntington HP, Quakenbush LT, Nelson M (2017) Evaluating the effects of climate change on Indigenous marine mammal hunting in Northern and Western Alaska using traditional knowledge. *Front Mar Sci*. <https://doi.org/10.3389/fmars.2017.00319/full>
- IPBES (2019) Nature's dangerous decline 'unprecedented,' species extinction rates 'accelerating'. <https://ipbes.net/news/Media-Release-Global-Assessment>
- IPCC (2021) Summary for policymakers. In: Masson-Delmotte V, Zhai P, Pirani A, Connors SL, Péan C, Berger S, et al (eds) *Climate change 2021: the physical science basis. Contribution of Working Group I to the Sixth Assessment Report of the Intergovernmental Panel on Climate Change* Cambridge University Press
- Janif SZ, Nunn PD, Geraghty P, Aalbersberg W, Thomas FR, Camailakeba M (2016) Value of traditional oral narratives in building climate-change resilience: insights from rural communities in Fiji. *Ecol Soc* 21(2):7. <https://doi.org/10.5751/ES-08100-210207>
- Keener V, Hamilton K, Izuka S, Kunkel K, Stevens L, Sun L (2013) Regional climate trends and scenarios for the US national climate assessment, Part 8. Climate of the Pacific Islands. NOAA Technical Reports. US Department of Commerce, Washington, DC

- Klaver S, Nederhoff CM, Giardino A, Tissier MF, van Dongeren AR, van der Spek AJ (2019) Impact of coral reef mining pits on nearshore hydrodynamics and wave runup during extreme wave events. *J Geophys Res Oceans* 124(4):2824–2841
- Kleypas J, Castruccio F, Curchitser E, Mcleod E (2015) The impact of ENSO on coral heat stress in the western equatorial Pacific. *Glob Chang Biol* 21(7):2525–2539. <https://doi.org/10.1111/gcb.12881>
- Komugabe-Dixson AF, de Ville NS, Trundle A, McEvoy D (2019) Environmental change, urbanisation, and socio-ecological resilience in the Pacific: Community narratives from Port Vila, Vanuatu. *Ecosyst Serv* 39:100973
- Kuleshov Y, McGree S, Jones D, Charles A, Cottrill A, Prakash, et al (2014) Extreme weather and climate events and their impacts on island countries in the Western Pacific: cyclones, floods and droughts. *Clim Atmos Sci* 4(5): 803–818. <https://doi.org/10.4236/acs.2014.45071>
- Kumar L (ed) (2020) *Climate change and impacts in the Pacific*. Springer, Cham
- Kumar L, Tehrani M (2017) Climate change impacts on the threatened terrestrial vertebrates of the Pacific Islands. *Sci Rep* 7(1):5030. <https://www.nature.com/articles/s41598-017-05034-4>
- Kuruppu N (2009) Adapting water resources to climate change in Kiribati: the importance of cultural values and meanings. *Environ Sci Policy* 12(7):799–809
- Kuruppu N, Liverman D (2011) Mental preparation for climate adaptation: the role of cognition and culture in enhancing adaptive capacity of water management in Kiribati. *Glob Environ Change* 21(2):657–669
- Lazrus H (2015) Risk perception and climate adaptation in Tuvalu: a combined cultural theory and traditional knowledge approach. *Hum Org* 74(1):52–61
- Le Dé L, Rey T, Leone F, Gilbert D (2018) Sustainable livelihoods and effectiveness of disaster responses: a case study of tropical cyclone Pam in Vanuatu. *Nat Hazards* 91(3):1203–1221
- Lebel L (2013) Local knowledge and adaptation to climate change in natural resource-based societies of the Asia-Pacific. *Mitig Adapt Strateg Glob Chang* 18 (7):1057–1076
- Lefale PF (2010) Stormy weather today: traditional ecological knowledge of weather and climate. The Samoa experience. *Clim Change* 100(2):317–335. <https://doi.org/10.1007/s10584-009-9722-z>
- Leon JX, Hardcastle J, James R, Albert S, Kereseka J, Woodroffe CD (2015) Supporting local and traditional knowledge with science for adaptation to climate change: lessons learned from participatory three-dimensional modelling in BoeBoe, Solomon Islands, *Coast Manage* 43(4):424–438
- Leonard S, Parsons M, Olawsky K, Kofod F (2013a) The role of culture and traditional knowledge in climate change adaptation: insights from East Kimberley, Australia *Glob Environ Change* 23(3):623–632
- Leonard S, Parsons M, Olawsky K, Kofod F (2013b) The role of culture and traditional knowledge in climate change adaptation: Insights from East Kimberley, Australia. *Glob Environ Change* 23(3):623–632. <https://doi.org/10.1016/j.gloenvcha.2013.02.012>
- McGree S, Schreider S, Kuleshov Y (2016) Trends and variability in droughts in the Pacific Islands and Northeast Australia. *J Clim* 29:8377–8397
- McIver L, Naicker J, Hales S, Singh S, Dawainavesi A (2012) Climate change and health in Fiji: environmental epidemiology of infectious diseases and potential for climate-based early warning systems. *Fiji J Public Health* 1:7–13
- Mcleod E, Arora-Jonsson S, Masuda YJ, Bruton-Adams M, Emaurois CO, Gorong B, et al (2018) Raising the voices of Pacific Island women to inform climate adaptation policies. *Mar Policy* 93:178–185. <https://doi.org/10.1016/j.marpol.2018.03.011>
- McNamara KE, Clissold R, Westoby R, Piggott-McKellar AE, Kumar R, Clarke T, et al. (2020) An assessment of community-based adaptation initiatives in the Pacific Islands. *Nat Clim Change* 10(7):628–639
- Mortreux C, Barnett J (2009) Climate change, migration and adaptation in Funafuti, Tuvalu, *Glob Environ Change* 19(1):105–112

- Mow IC, Shields C, Sasa H, Fitu L (2017) Towards a people centred early warning and disaster response system in Samoa: the use of ICT by Samoans during disaster. *Electron J Inf Syst Dev Countries* 81(1):1–18. <https://doi.org/10.1002/j.1681-4835.2017.tb00594.x>
- Nakashima D, Krupnik I, Rubis JT (2018) Indigenous knowledge for climate change assessment and adaptation. Cambridge University Press, Cambridge
- Nalau J, Becken S, Noakes S, Mackey B (2017) Mapping tourism stakeholders' weather and climate information-seeking behavior in Fiji. *Weather Clim Soc* 9(3):377–391
- Nalau J, Becken S, Schliephack J, Parsons M, Brown C, Mackey B (2018) The role of Indigenous and traditional knowledge in ecosystem-based adaptation: a review of the literature and case studies from the Pacific Islands. *Weather Clim Soc* 10(4):851–865
- Nunn PD, Aalbersberg W, Lata S, Gwilliam M (2014) Beyond the core: community governance for climate-change adaptation in peripheral parts of Pacific Island Countries', *Reg Environ Change* 14(1):221–235
- Nunn PD, Mulgrew K, Scott-Parker B, Hine DW, Marks ADG, Mahar D, et al (2016a) Spirituality and attitudes towards Nature in the Pacific Islands: insights for enabling climate-change adaptation *Clim Change* 136(3):477–493
- Nunn PD, Runman J, Falanruw M, Kumar R (2016b) Culturally grounded responses to coastal change on islands in the Federated States of Micronesia, northwest Pacific Ocean. *Reg Environ Change* 17(4):959–971
- Nursey-Bray M (2016) Cultural indicators, country and culture: the Arabana, change and water. *Rangel J* 37(6):555–569
- Nursey-Bray M, Fergie D, Arbon V, Rigney L-I, Palmer R, Tibby J, et al (2013) Community based adaptation to climate change: the Arabana, South Australia, National Climate Change Adaptation Research Facility, Gold Coast, 133 pp
- Nursey-Bray M, Palmer R, Stuart A, Arbon V, Rigney L-I. (2020) Scale, colonisation and adapting to climate change: insights from the Arabana people, South Australia. *Geoforum* 114:138–150
- Ohmagari K, Berkes F (1997) Transmission of Indigenous knowledge and bush skills among the Western James Bay Cree women of subarctic Canada. *Hum Ecol* 25(2):197–222
- Orlove B, Chiang J, Cane M (2002) Ethnoclimatology in the Andes: a cross-disciplinary study uncovers a scientific basis for the scheme Andean potato farmers traditionally use to predict the coming rains. *Am Sci* 90(5):428–435
- Parsons M, Brown C, Nalau J, Fisher K (2017) Assessing adaptive capacity and adaptation: insights from Samoan tourism operators. *Clim Dev* 10(7):644–663. <https://doi.org/10.1080/17565529.2017.1410082>
- Pearce P, Ford J, Cunsolo WA, Smit B (2015) Inuit traditional ecological knowledge (TEK), subsistence hunting and adaptation to climate change in the Canadian Arctic. *Arctic* 68(2):233–245
- Pearce T, Currenti R, Mateiwai A, Doran B (2018) Adaptation to climate change and freshwater resources in Vusama village, Viti Levu, Fiji. *Reg Environ Change* 18(2):501–510
- Plotz RD, Chambers LE, Finn CK (2017) The best of both worlds: a decision-making framework for combining traditional and contemporary forecast systems. *J Appl Meteorol Climatol* 56(8):2377–2392
- Polemio M, Walraevens K (2019) Recent research results on groundwater resources and saltwater intrusion in a changing environment. *Water* 11(6):1118
- Rarai A (2018) Traditional knowledge and environmental change in Vanuatu (Thesis). The University of Auckland. Retrieved from <https://researchspace.auckland.ac.nz/handle/2292/44107>
- Rudiak-Gould P (2013) Climate change and tradition in a small Island State: the rising tide. Routledge, Abingdon
- Smale D, Wernberg T, Oliver E, Thomsen M, Harvey B, Straub S, et al. (2019). Marine heatwaves threaten global biodiversity and the provision of ecosystem services. *Nat Clim Change* 9: 306–312
- Sutton J, Carpenter C, Mariner A, Willie R, Reenate V (2015) Drought planning and response plan for Abaiuang Island Community: Summary, SPREP, Samoa
- Taylor S, Kumar L (2016) Global climate change impacts on Pacific Islands terrestrial biodiversity: a review. *Trop Conserv Sci* 9(1):203–223

- Tugjamba N, Walkerden G, Miller F (2021) Adaptation strategies of nomadic herders in northeast Mongolia: climate, globalisation and traditional knowledge. *Local Environ* 1–20
- UNESCO World Water Assessment Programme (2019) *The United Nations World Water Development Report 2019: Leaving No One Behind*. Paris, UNESCO
- Voeks RA (2007) Are women reservoirs of traditional plant knowledge? Gender, ethnobotany and globalization in northeast Brazil. *Singapore J Trop Geogr* 28(1):7–20
- Watanabe M, Dufresne J-L, Kosaka Y, Mauritsen T, Tatebe H (2021) Enhanced future warming constrained by past trends in the equatorial Pacific sea surface temperature gradient *Nat. Clim Chang* 11:33–37. <https://doi.org/10.1038/s41558-020-00933-3>
- Wu HC, Dissard D, Douville E, Blamart D, Bordier L, Tribollet A, et al. (2018) Surface ocean pH variations since 1689 CE and recent ocean acidification in the tropical South Pacific. *Nat Commun* 9(1):2543–2513
- Zack A, Ronneberg E (2003) The applicability of scavenger wells to control saltwater intrusion in wellfields, Majuro, Marshall Islands. Secretariat of International Conference on Renewable Energy Sources for Islands—Tourism and Water (26 to 28 May 2003), Crete, Greece, June 2003

The opinions expressed in this chapter are those of the author(s) and do not necessarily reflect the views of the UNESCO: United Nations Educational, Scientific and Cultural Organization, its Board of Directors, or the countries they represent.

Open Access This chapter is licensed under the terms of the Creative Commons Attribution-ShareAlike 3.0 IGO License (<https://creativecommons.org/licenses/by-sa/3.0/igo/>), which permits use, sharing, adaptation, distribution, and reproduction in any medium or format, as long as you give appropriate credit to the UNESCO: United Nations Educational, Scientific and Cultural Organization, provide a link to the Creative Commons licence and indicate if changes were made. If you remix, transform, or build upon this book or a part thereof, you must distribute your contributions under the same licence as the original.

The use of the UNESCO: United Nations Educational, Scientific and Cultural Organization's name, and the use of the UNESCO: United Nations Educational, Scientific and Cultural Organization's logo, shall be subject to a separate written licence agreement between the UNESCO: United Nations Educational, Scientific and Cultural Organization and the user and is not authorized as part of this CC-IGO licence. Note that the link provided above includes additional terms and conditions of the licence.

The images or other third party material in this chapter are included in the chapter's Creative Commons licence, unless indicated otherwise in a credit line to the material. If material is not included in the chapter's Creative Commons licence and your intended use is not permitted by statutory regulation or exceeds the permitted use, you will need to obtain permission directly from the copyright holder.

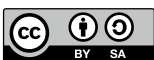

Chapter 12

Energy Transitions



Richard Corkish, Sandip Kumar, and John Korinihona

Cleaner, more autonomous, lower-cost, and more resilient futures are tantalizingly close for the Pacific peoples and the opportunities might be grasped if an analogue of the focus, urgency and camaraderie, and competitive-yet-cooperative spirit that has characterized the multinational race for COVID-19 vaccines in 2020 can be brought to bear on this other crisis too.

Abstract This chapter addresses the opportunities for the Pacific region nations and territories to participate in the global transition from fossil to renewable energy supplies and, in so doing, gain greater autonomy, resilience and more equitable energy supplies and reduced contributions to the evolving crisis arising from excessive atmospheric carbon. Most of the region's jurisdictions have made little historical contribution to that problem but many are particularly vulnerable to its impacts. A set of critical energy capture and conversion technologies is examined in the Pacific context, as are some key energy services in actual or potential transition, before examining progress and potential for improved policy, regulation, and support, such as technical training. Much has been achieved but much remains to be done and a supportive multinational effort is required to realize the potential.

Keywords Pacific · Energy transition · Solar energy · Solar power · Wind energy · Geothermal · Micro-grid · Renewable energy · Hydropower · Capacity building

R. Corkish (✉)

School of Photovoltaic and Renewable Energy Engineering, UNSW Sydney, Sydney, NSW 2052, Australia

e-mail: r.corkish@unsw.edu.au

S. Kumar

Global Sustainable Energy Solutions (GSES), Botany, Australia

J. Korinihona

Energy Division of the Ministry of Mines, Energy and Rural Electrification, Solomon Islands Government, Honiara, Solomon Islands

© UNESCO 2024

A. Dansie et al. (eds.), *The Water, Energy, and Food Security Nexus in Asia and the Pacific*, Water Security in a New World, https://doi.org/10.1007/978-3-031-25463-5_12

249

12.1 Introduction

In the words of the World Economic Forum's Global Future Council on Energy (Bond 2020), "... the energy transition will unleash significant creative destruction, create large new opportunities for wealth formation, and will ultimately lead to greater prosperity and major societal benefits." The IEA (2019) strikes a more sober tone, noting that "the energy world is marked by a series of deep disparities" including that almost one billion people remain without access to electricity and that the world remains reliant on fossil fuels. Arguably, the potential identified by the WEC is true for the PICs, for the reasons outlined in the chapters of this volume, but its realization remains challenging.

There are many sources of hope. The renewable energy technologies for at least the start of the transition of global energy from fossil fuels exist and they are following rapid learning curves, driving costs below those of fossil sources. Globally, the incremental cost of a new energy system was estimated to be 16% higher than business as usual, but the incremental benefits outweigh this by 3–7 times (IRENA 2019a). Improved end-use efficiency and renewables place incumbent energy industry participants at risk of reduced incomes and stranded assets if they continue to invest in the status quo (Bond 2020). However, there are significant barriers to change, and global and Pacific policy-makers need to act more assertively to drive the transition, just to meet the requirements of the Paris Climate Change Agreement, let alone to deliver energy and other services to communities that lack them (Gielen et al. 2019). There is tremendous scope for major policy action and for enacting and implementing the intended transitions in energy efficiency and renewables (see Chap. 3).

Access to infrastructure for achieving SDG 7 (Affordable and Clean Energy) is less in Oceania than in most other regions (Sachs et al. 2020). Figure 12.1 shows estimates for per-capita energy-related equivalent CO₂ emissions in the region's countries and territories for which data is available.

Clean grid electricity share has increased dramatically in many of the smaller grids but declined in some of the larger PICT networks (Fig. 12.2).

On the other hand, small island states in the region, among the countries that are the most vulnerable to climate change (UN-OHRLLS 2015), have performed well compared to the rest of the world on SDG 13 (Climate Mitigation) (Sachs et al. 2020). Access to electricity and to clean fuels and technology for cooking is quite variable across the region (Fig. 12.3) but it is likely that use of wood and waste biomass is under-reported (Johnston personal communication). We further note that energy security remains challenged by heavy reliance on fossil fuels (Johnston personal communication).

The Small Island Developing States (SIDS) will benefit most from the transition since their import of fossil fuels consumes 8% of GDP and many are extremely vulnerable (GCGET 2019; UN-OHRLLS 2015). The PICTs possess renewable resources to meet most of their domestic energy needs and the shift would cut import costs, promote sustainable development, and improve resilience. Renewables can promote social justice, human welfare, local empowerment and wealth creation,

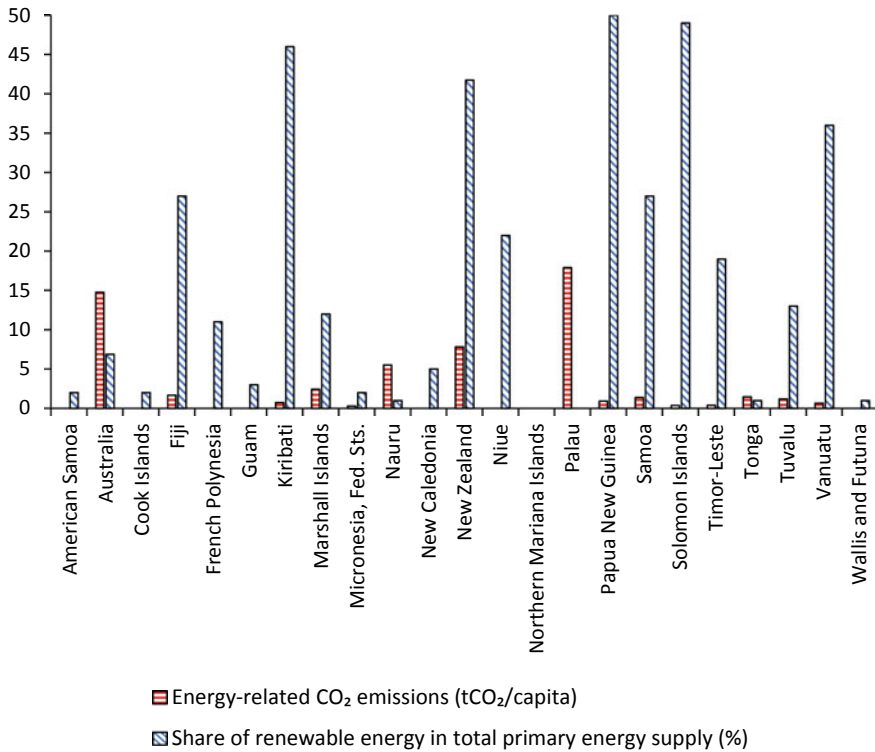

Fig. 12.1 Energy-related CO₂ emissions (tCO₂/capita) for several PICTs and renewables shares in primary energy supplies Sachs et al. (2020) and Tracking SDG7 (2020)

public health, gender equality and educational opportunities, and contribute to a safer climate, supporting all 17 of the SDGs (IRENA 2017a).

Others have reviewed energy transition issues for the PICTs recently. Dornan (2015), Taibi et al. (2016) and Weir (2018) reviewed renewable energy deployment, with Lucas et al. (2017) describing the implementation, results, and recommendations arising from a 2013 survey of stakeholders. The International Renewable Energy Agency’s (IRENA 2017b, 2020a) SIDS Lighthouses Initiative provides a framework for action to support SIDS, including many PICTs, in the transformation to a resilient renewables-dominated energy system, primarily through partnerships with public, private, intergovernmental, and non-government organizations. An extensive two-volume report, “Framework for Energy Security and Resilience in the Pacific (FESRIP)”, was published in 2021 (Pacific Community 2021a, 2021b).

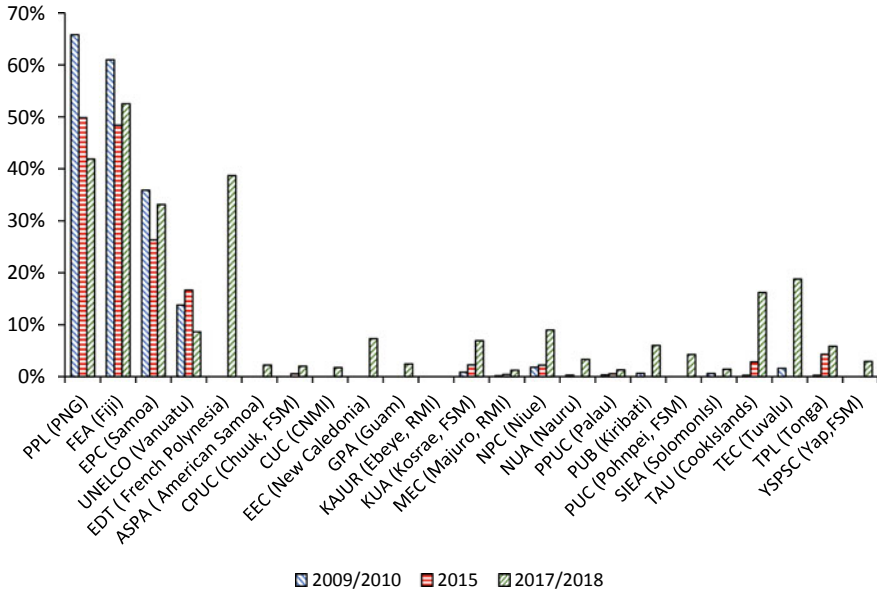

Fig. 12.2 Evolution of clean electricity contributions in the main public utility grids operated by the members of the Pacific Power Association (PPA) since 2009/2010. Note that the Fijian utility is currently known as EFL—Energy Fiji Limited and that, in this figure, we adopt the definition of “clean” as used by the PPA (*Source* PPA Benchmarking reports PPA [2017])

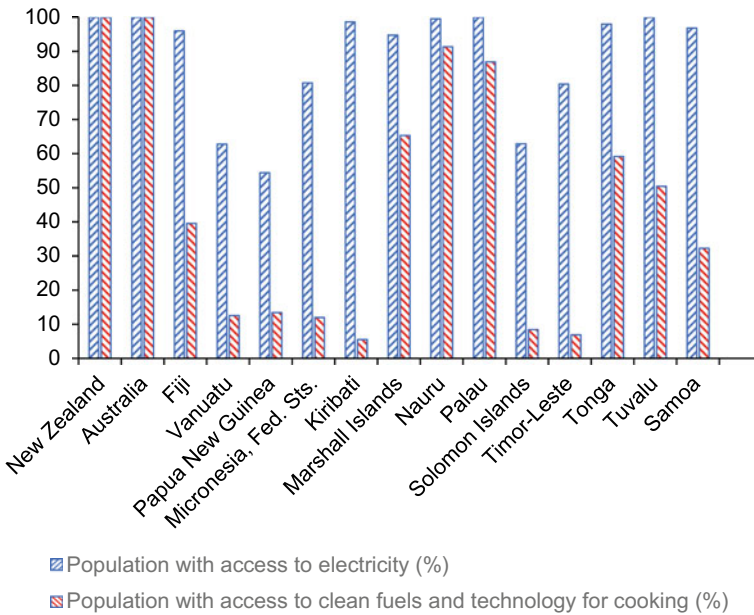

Fig. 12.3 Electricity and clean fuels and technology for cooking access for some PICTs

12.2 Critical Energy Technologies

To limit global warming to the Paris target of 1.5 °C, we need to dramatically and rapidly adopt renewable energy, modernize power grids, and improve energy efficiency through (Engel 2020):

- Renewable energy;
- Electric vehicles;
- Grid storage;
- Expanded and reinforced grids;
- Improved energy productivity;
- Green hydrogen;
- Electrification of manufacturing;
- Heat-pumps;
- Rail transport; and
- Carbon capture, utilization, and storage.

All of these are relevant to the PICTs, though to a different extent in each country/territory, and some are already factored into their Intended Nationally Determined Contribution (NDC) plans (IRENA 2019b) but the PICTs face challenges to successful implementation of renewable energy projects: energy resources, human resources, institutional capacity, science and technology infrastructure, policy and legislation, and financing (Singh and Bijay 2020).

This chapter will survey the evolving energy transition across the PICTs from traditional biomass and fossil fuel dependence to accessing indigenous, renewable energy opportunities; reporting on key international support instruments; and noting the range of policy ambitions and supporting regulations. We will highlight how the increasing affordability of renewable electricity and other renewable energy forms are impacting various end uses.

12.2.1 *Solar Photovoltaics (PV)*

It is common knowledge that research and development (R&D) and mass manufacturing innovations have been coupled for a dramatic cost reduction for solar PV (Fischer et al. 2020). For Australia, the levelized cost of electricity (LCOE) of utility-scale PV fell 78% from 2010 to 2019 (IRENA 2020b) and solar power dominates the new (2014–2018) renewable energy installed capacity in the 15 PICT partners of The International Renewable Energy Agency's (IRENA) Lighthouses Initiative (IRENA 2020a).

This, underpinned by light emitting diode lighting technology (Cho et al. 2017; Lighting Global 2020) and mobile payments (IEA 2017) has already facilitated the replacement of almost all kerosene lighting (Vanuatu Department of Energy 2016; Prasad and Raturi 2020). Resorts, mini-grids, and health and telecommunications

facilities are additional off-grid loads being supplied by PV, but for which there is still a large unmet demand (Prasad and Raturi 2020).

PV is also being applied to cut fuel costs and reduce emissions in PICT grids (see Sect. 12.2.4) where operators allow and technical barriers to intermittent generation can be overcome. Fiji could consume 167 GWh by 2030 in three island grids (Prasad and Raturi 2020), allowing the country to surpass its NDC target (Fiji Ministry of Economy 2018).

In the biggest regional market, Australia remains one of the top ten photovoltaics markets in the world, despite a lack of federal policy direction from 2013–2022, but encouraged by state governments and industrial and residential customers (APVI 2020; Morton and Readfearn 2020). However, the industry is experiencing problems of delays, connection problems, and cost over-runs (Parkinson 2020).

12.2.2 Water Heating

Solar water heaters, in demand in PICT resorts and in the cooler and more affluent regions, are widely available. Supplementary heating, commonly from electricity or gas, is often included and may be effectively mandated in some jurisdictions to reduce risk of Legionnaires' disease (Queensland Government 2020). Decreasing PV costs have greatly improved the feasibility of heating water with high performance heat pumps (air or water or ground coupled) running on PV-sourced electricity (Behi et al. 2020; Panagiotidou et al. 2020). Water heating can also absorb excess PV electricity in case of restricted grid exports (Forcey 2015). Geothermal water heating is a third renewable approach (Vasiliev et al. 2017). See also, Sect. 12.2.5.

There are extensive opportunities for advanced water heating in the PICTs but availability, higher capital costs, and access to technical and maintenance support are likely to limit growth in the near term.

12.2.3 Wind Turbines

Wind turbine hub height, rotor span, and power rating are all growing larger (Earnest and Rachel 2019) as the technology matures and onshore and offshore applications are increasingly competitive. Oceania experienced the largest LCOE reductions (54%) globally between 2010 and 2019 for onshore wind generation and projects are increasingly achieving LCOEs under USD 0.040/kWh (IRENA 2020b).

Australia and New Zealand have installed significant amounts of onshore wind turbines in their grids (ARENA 2020a; EECA 2020). Wind is one of the two main replacement technologies retiring Australian coal-fired power stations but there are concerns that the growth of wind and solar might not be sufficient to avoid a shortfall in power generation (Adisa 2020). Grid access is constraining growth in Australia (Parkinson 2020), but the establishment of renewable energy zones (Heidari et al.

2020; NSW Government 2020) will partially relieve this. A limiting factor for expansion in New Zealand is impending oversupply following the closure of an aluminum smelter (Roy and AAP 2020).

Wind resources are commonly regarded as being too small and/or inconsistent and turbines too prone to cyclone damage for many PICTs, but lowerable turbines have been successfully used in Vanuatu and were assessed to have acceptable payback periods if installed on other islands too (Singh et al. 2019; Joseph and Prasad 2020a).

12.2.4 Micro-Grids and Small Grids

High shares of renewable energy penetration in microgrids have become feasible and economically attractive over recent decades through rapid technology developments (Veilleux et al. 2020), accessible design support (e.g., GSES India 2015; HOMER 2020) and documented examples (Bushlight 2010; HorizonPower 2020; ITP 2013; Maisch 2020; RMI 2021), although islands have special issues (Marczinkowski et al. 2019). Learnings from other islands can inform developments in the Pacific (Bunker et al. 2020; Locke and Burgess 2020; Burgess and Goodman 2020).

A review was undertaken of business models for the introduction of hybrid renewable energy to islands by Eras-Almeida and Egado-Aguilera (2019). They confirmed that there are vast opportunities to insert renewables into fossil-fueled microgrids but identified that some PICTs need to strengthen their weak regulatory frameworks and define suitable business models to promote renewable energy, involve private entities, and find alternative funding sources. IRENA (2018) identified the major technical challenges to integration of large fractions of renewables into small grids: generation adequacy; supply intermittency; system stability, physical limits of networks; protection systems; and power quality. They proposed planning approaches to overcome those technical concerns.

12.2.5 Geothermal

Potential uses for geothermal heat have been reported, ranging from bathing to electricity generation (Lund 2012). Resources were identified with high or moderate potential for electricity generation, in priority order, in PNG, Vanuatu, Samoa, Tonga, and Northern Mariana Islands, Fiji, New Caledonia and Solomon Islands (McCoy-West et al. 2009). There is also a major resource in New Zealand, which has been extensively exploited. Papua New Guinea has a large population, unsatisfied energy demand, and a 22 TWh geothermal resource (Kuna and Zehner 2015). Lihir gold mine operates a 50 MW geothermal power plant but non-technical issues appear to be inhibiting further developments, particularly, policy and legal frameworks and, consequently, finance availability (PNG 2012; Mine.OnePNG 2020).



Fig. 12.4 Mt. Yasur on the east side of Tanna Island, Vanuatu is in a zone of accessible geothermal energy (©Richard Corkish)

Interest remains active for several nations (Petterson 2016) but an intended 5MW_e and potentially 10 MW_e geothermal power station for Efate Island, Vanuatu (Geodynamics 2014) did not win a contractually committed offtake partnership to allow it to proceed to construction (Fig. 12.4).

12.2.6 Hydropower

Hydro power constitutes a significant share of dispatchable renewable energy generation in PICTs, including in the three most populous, Australia, New Zealand, and PNG (IHA 2019). Hydropower, after solar, constitutes the second most intensive (2014–2018) renewable energy technology in the 15 PICT partners of IRENA's Light House Initiative. However, the global weighted-average LCOE of newly commissioned hydropower projects has increased 27% relative to 2010 and installed costs in Oceania are high for large (>10 MW) hydropower (IRENA 2020b). In 2014–2018, 18 MW of hydropower were installed in Papua New Guinea and 3.6 MW in Samoa (IRENA 2020a).

Several small hydro power projects have been constructed and are in progress in the PICTs (IHA 2019), but the environmental conditions for project delivery and persistence can be daunting (Vanuatu Daily Post 2020). The 15 MW public–private Tina River project in the Solomon Islands is expected to reduce the country's reliance

on imported diesel and aims to eventually provide 68% of the capital's electricity demand by 2025 (Tina River Hydropower Development Project 2020) and allow it to overachieve its 2025 emissions reduction target. A recent resource assessment for the Fijian island of Viti Levu and Vanua Levu found that the potential for new hydro could be far greater than that previously identified (Singh 2020).

12.2.7 Biofuel

It is possible to run diesel generators on straight or blended coconut oil (Cloin 2007; Raturi 2012). Grid electricity on Efate Island, Vanuatu has had between 10 and 25% local coconut oil supply supplementing its diesel fuel since 2011 (UNELCO 2019). Raturi (2012) found that PNG, Fiji, and Solomon Islands could produce about 80 ML of coconut oil per year, potentially replacing about 71 ML of diesel. However, while the promise of coconut oil use in modified diesel engines or cocomethyl ester in unmodified diesel engines is well known, there have been some cautionary experiences that should generate hesitation in encouraging rollout for remote community use (Johnston and Wade 2016).

While there are significant opportunities to offset imported fossil fuel with locally supplied renewable coconut oil, progress depends on competing diesel costs. Some PICTs have developed plans to protect coconut supplies (Vanuatu Department of Agriculture and Rural Development 2016; Republic of Vanuatu 2019) but crops are threatened by cyclones (McGarry 2020), pests (Jackson 2017), and land competition (Charan 2020).

Ethanol, from wheat flour or sorghum production, is available as a 10% mix in petrol in eastern Australia (E10 Fuel for Thought n.d.) and co-generation plants operate at several sugar mills which operate on steam produced from bagasse combustion (Hussain 2017). Singh (2020a) found jatropha-based biodiesel production in Fiji to be economically unviable but pongamia biofuel production on marginal land was more promising (Singh 2020b; Prasad and Singh 2020). Bio-butanol, made from residual lignocellulosic feedstock or from molasses production, could save 71% of Fiji's NDC target from sustainable biomass plantation and waste-to-energy (Singh 2020b).

12.2.8 Waste to Energy

Industrial, agricultural, or municipal waste is not extensively converted to energy in the region although bagasse is exploited in Australian and Fijian sugar industries and some piggery and food waste is diverted (ARENA 2020b). Gases from municipal and human wastes are captured and recovered in the larger repositories and processing plants (ARENA 2020b, Bioenergy Association 2020; Joseph and Prasad 2020b) but there are many unused opportunities (Nadan 2020; Bioenergy Association 2020).

According to Nadan (2020), incineration and anaerobic digestion are more viable than other waste to energy technologies for PICTs, due to their lower costs and higher efficiency.

Bio-butanol, a petrol alternative made from waste lignocellulosic feedstock or from molasses production, could save 71% of Fiji's NDC target from sustainable biomass plantation and waste-to-energy (Singh 2020b). The palm oil industry in Solomon Islands and PNG use waste oil palm fruit husks and shells as feedstock (Salomón et al. 2009), for heating of processing steam and for providing electricity for oil mills and staff housing.

12.2.9 Energy Efficiency

Few PICs have seriously pursued energy efficiency to help mitigate the challenges faced related to climate change and heavy reliance on imported diesel fuel. To address these issues, the Pacific Appliance Labelling and Standards program (PALS 2019), was intended to support ten PICTs since 2012 to implement Minimum Energy Performance Standards and Labelling (Dethman et al. 2019), but the scheme is no longer active and seems to have not progressed beyond estimates of net energy savings (Johnston personal communication).

Table 12.1 shows the MEPSL status for the 10 PICTs participating in PALS at the time of evaluation (2019). Five PICs had enacted MEPSL legislation and five had drafted legislation.

The PALS experience suggests that if the settings are right, PICs can bypass more conservative voluntary strategies and pursue legislation directly. Passing MEPSL legislation establishes a baseline of high appliance efficiency and does not preclude complementary strategies. Qualitative results from PALS and global MEPSL programs suggest PALS provided good value for money: the average cost per PIC was AUD 50 K per year (Dethman et al. 2019), but it faced many challenges, and its success was not uniform (Table 12.1). Concern remains about how the other PICTs enhance energy efficiency. A technical guideline has been published (SEI-API/PPA 2020) to support renewable energy installers to undertake basic energy audits.

At utility scale, PPA has implemented a benchmarking tool with assistance from the World Bank (PPA 2017), including data on generation, transmission, and distribution losses that could be used by the 21 member utilities to enhance overall efficiency (Nair 2019).

Table 12.1 Status of MEPSL in participating PICTs participating in PALS

PIC	Status of MEPSL	Date MEPSL in effect	Appliances covered			
			Refrigerators & freezers	Air conditioners	Lighting	Other
Fiji	Enacted	1/2012	✓	Proposed	Proposed	Televisions
Samoa	Enacted	5/2018	✓	✓	✓	
Solomon Islands	Enacted	4/2017	✓	✓	✓	
Vanuatu	Enacted	3/2017	✓	✓	✓	
Kiribati	Final Draft 2018	N/A	✓	✓	✓	
Cook Islands	Draft 2014	N/A	✓	✓		
Tuvalu	Enacted	4/2016	✓	✓	✓	
Tonga	Draft 2017	N/A	✓	✓	✓	
Niue	Draft 2018	N/A	✓	✓	✓	
PNG	Draft 2017	N/A	✓	✓	✓	

Data from Dethman et al. (2019)

12.2.10 Energy Storage Technologies

Affordable, reliable, and sustainable energy storage is a core component of energy transitioning. A wide range of storage technologies have been developed (Koochi-Fayegh and Rosen 2020), with differing levels of technological maturity, useful storage times, capacities, and costs. In particular, battery energy storage is in the midst of a revolution, with the workhorse of lead acid yielding market share to a range of newer technologies, most notably lithium-based and flow batteries, and costs are declining rapidly. Many storage methods may find application in the Pacific region but in the foreseeable future, batteries are likely to dominate, firstly in stand-alone and minigrid systems and later in grid connection, counteracting the intermittency of solar and wind supplies. Battery-free stand-alone solar water pumps (GSES 2015) are commonly designed to pump sufficient water to elevated storage tanks to satisfy demand despite intermittent availability of sunshine. Hydrogen will be required in future if the hydrogen-fueled applications mentioned below and in Chap. 18 of this volume penetrate the region.

12.3 Energy Services in Transition

12.3.1 *Transport*

The vastness of the region, the sparseness of the population, the remoteness from major markets, and for many PICTS, a low level of transport infrastructure development, challenging terrain, and frequent extreme weather events (MCST 2020) make land, sea, and air transport all vitally important but very energy intensive and expensive for the PICTs. The most vulnerable of the PICT population live on remote islands, for which maritime transport is often the routine way to connect to services such as health, education, and food supplies and are core to building economies (Pacific Community 2020). The reliance on imported fossil fuel for all three modes exacerbates the PICTs' balances of payments (Juswanto and Ali 2016) and hastens climate change.

12.3.1.1 Land Transport

Recent years have seen dramatic improvements in performance (Yu et al. 2020) and availability of electric vehicles (EVs) globally, but to a lesser extent in the Pacific than in Europe or North America. The potential pioneers in the region, with accessible resources and market access, are Australia and New Zealand. While the latter's national government is supportive of EV uptake (New Zealand Ministry of Transport 2020) the former's government has been simultaneously supportive (Department of Industry Science, Energy and Resources 2020) and disparaging (Remeikis 2019). On the other hand, Australia is trialing and accepting expansion of battery electric (Mazengarb 2020) public buses. Lord Howe Island, with its very limited, low speed road network, is potentially an easy entry point for high penetration of mass-market 'city-style' EVs (Watson 2020).

Road conditions in many PICTs may not suit the urban EVs currently available but stronger utility-style vehicles and conversions are entering the market (Jaunt Motors 2019; Tancredi 2019; Schmidt 2021). Draft regional electric mobility policy and technical documents have been released, considering e-scooters, e-bikes, e-trykes, cars, light and heavy trucks, and buses, supported by renewable energy generation (PCREEE 2020). The study's draft conclusions found potential for most forms of EVs, conditional on avoidance of large uncontrolled demands on small grids while vehicle-to-home and managed charging from on-site renewable energy generation are worthy of support now.

12.3.1.2 Water Transport

The International Maritime Organisation (IMO 2019) promotes improvements in shipping efficiency through the Energy Efficiency Design Index (EEDI) for new ships and the Ship Energy Efficiency Management Plan (SEEMP) for all ships.

Castellanos et al. (2019) have reviewed promising energy options for shipping, including biofuels, methanol/hydrogen/ammonia, battery electric, wind, solar, and efficiency improvements. Biofuels are feasible now, as are hydrogen and its derivatives. Battery-electric ships are viable for distances less than 95 km, provided charging infrastructure could be provided. Bouman et al. (2017) found that CO₂ emissions could be reduced by over 75%, using 2017 technologies, if policies and regulations were focused on achieving these reductions and alternative fuels are expected to become financially competitive in the medium- to long-term (Castellanos et al. 2019).

Fiji, for example, is striving to significantly reduce its carbon impact from shipping (Nuttall et al. 2014; Goundar et al. 2017; Prasad and Raturi 2019) but non-EEDI compliant second-hand vessels are commonly used in PICTs. Nuttall et al. (2014) identify that perceptions of lower financial returns and the need for collateral restrict availability of finance for PICT trials of innovative technologies. On the other hand, measures such as hull cleaning and coating, propeller polishing, speed reduction, with a change to 5% biodiesel blend, are more likely to find acceptance (Prasad and Raturi 2019). A technical review by PCREEE (2020) notes that electrification of small, slow-speed vessels operating close to shore, small fishing boats, and tourist ferries could be financially viable now and in the near future. Shipping also provides opportunity for waste management as part of waste-to-energy and circular economy approaches to energy transitions (Chap. 9).

The Pacific Blue Shipping Partnership (PBSP 2020) targets a domestic shipping transition to zero carbon by 2050 with a 40% reduction by 2030 in PICTs through concessional loan investments to support low carbon infrastructure (ships, ports, energy supply, support infrastructure). Low-carbon passenger and cargo ferries are the first priorities, including “eco-diesel”, wind-hybrid, and electric propulsion, reducing energy costs by 20–80%. In 2019, electricity use and emissions were reduced for three PICT ports (17–27% decrease in electricity use), a solar array was fitted to a landing craft to supplement diesel-generated electricity (saving 87.5% of fuel costs), and a pilot project to install solar power on an interisland ferry in was completed (Pacific Community 2020).

12.3.1.3 Air Transport

The expanse of the Pacific Ocean generates significant demand for fossil-fueled air transport for passengers and cargo (Chap. 3). There are currently no available or near-term options, especially for long-distance routes, although hydrogen (Clean Sky 2 and FCH 2 2020; Hill 2020), battery-electric (Gnadt et al. 2019; Filatoff

2020), biofuel (Gutierrez-Antonio et al. 2017; Zhou 2018), and lighter-than-aircraft for cargo (Hunt et al. 2019) are all topics of R&D and trials.

12.3.2 Water Pumping

Water pumping in remote regions has long been an application in which solar power has been competitive with fossil-fuel energy, particularly since the intermittency of the solar supply can commonly be compensated by provision of pumped water storage rather than by batteries (Aliyu et al. 2018). PV pumps are cost effective, quiet, clean and need low maintenance (GSES 2015; Sontake and Kalamkar 2016; Chandel et al. 2017) and, thus, highly suited to expanded application in the Pacific region.

When information is unavailable and initial purchase price concerns dominate equipment choices, as is common for purchasers with low capital and poor access to credit, poor choices can result in high life-cycle costs (Sproul 2005; Sustainability Victoria 2015). A recent study of 17 UK water companies (Walker et al. 2020) found that, on average, companies could reduce energy inputs by 92% by reducing leaks, helping consumers reduce demand, reducing number of abstraction sources, and use of fewer larger treatment plants. There is little reason to expect that significant savings in energy costs are not also possible in PICTs.

12.3.3 Crop Drying

Food security (see Chap. 4) implies availability of preservation and storage of local food supplies which, implies access to local energy supply. Refrigeration is one method and may be considered simply as an electrical load and electricity supply, covered elsewhere in this chapter. Solar thermal drying is an alternative, cost-effective, and sustainable method to conserve agricultural products (Curtis et al. 2015; Udomkun et al. 2020) but there has been low social acceptance of solar crop dryers in the Pacific (Vanuatu Daily Post 2012; Ligo 2015).

Geothermal heat, where easily accessible, might also be used to preserve agricultural produce (Nguyen et al. 2015) but is under-exploited.

12.4 Energy Policy, Regulation and Support

Politics and policies will affect and be affected by the energy transition to renewables. The Global Commission on the Geopolitics of Energy Transformation has studied the geopolitical implications of the global energy transformation and identified why renewables will transform geopolitics (GCGET 2019). Ubiquitous availability, with

consequent democratizing effects, reduced supply disruption, deployment at any scale, low marginal costs, and rapidly falling capital costs. The PICTs will benefit most from the transition, but regulatory solutions are needed to ensure stability and profitability. Renewables offer PICTs an opportunity to leapfrog further dependence on fossil fuels and, in some cases, centralized electricity grids, like the leap over landline networks to mobile phones (GCGET 2019).

However, change will not come easily or quickly unless barriers are removed, and opportunities are facilitated by public and private organizations. The transition in recent years for many small islands has not been proceeding well, with many becoming more vulnerable during 2010–2014 (Praene et al. 2019).

12.4.1 Governments' Planning

While there are reasonable arguments that only a few of the region's jurisdictions have had significant culpability in causing the climate change crisis, all have, nevertheless, joined with the global community to undertake their NDC measures (IRENA 2019b). In September 2019, the 44 Member States, including 15 from the Pacific, of the Alliance of Small Island States (AOSIS) presented the "SIDS Package" at the UN Climate Action Summit in 2019 (AOSIS 2019). This package includes a set of initiatives and partnerships that address all the climate action areas highlighted at the Summit: energy transition, industry transition, infrastructure, cities and local action, climate finance and carbon pricing, mitigation, nature-based solutions, resilience and adaptation, social and political drivers, and youth and public mobilization. It included a collective commitment to update their NDCs in 2020, to achieve net zero emissions by 2050, conditional on receiving necessary international assistance, and to pursue 100% renewable energy targets by 2030 (AOSIS, 2019). Renewable energy capacity is projected to boom in the SIDS, from 2.3 gigawatts (GW) in 2014 to 8.6GW in 2030 (IRENA 2019b). The Pacific Community (2020) invests in renewable energy and energy-efficient technologies, an enabling environment for transport and energy security, and capacity strengthening, including supporting the drafting of the regional energy security framework mentioned in the Introduction.

Lucas et al. (2017) analyzed the results of a 2013 survey of 32 PICTs stakeholders in the region and identified and assessed renewable energy deployment challenges in six categories: resource data, policy and regulation, financing, human resources (including education and training), infrastructure (including standards and guidelines), and social/cultural issues. They went on to make recommendations to overcome these challenges:

- Donor support should move to capacity building and technical assistance;
- Capacity-building programs should be more comprehensive and also increase the offer of RE curricula within the existing education and training system (see Sects. 12.4.2 and 12.4.3);
- PICT grid stability studies should be undertaken;

- Policy and regulatory framework should be developed targeting the leverage of private investments; and
- Data should be made more available.

Similarly, Eras-Almeida and Egido-Aguilera (2019) identified, inter alia, that the least developed PICTs need to strengthen their weak regulatory frameworks and find appropriate business models to promote renewable energy and seek alternative funding sources other than foreign aid. The authors propose renewable energy service companies, competitive auctions, and tax incentives to achieve this.

Fortunately, there has been some steps already taken in the jurisdictions with the greatest capacity. Fiji has been the subject of extensive study of renewable energy progress and options (Singh 2020a) to meet the country's NDC (Fiji Ministry of Economy 2017, 2018), identifying complex and interrelated barriers, considering just finance aspects alone (Anantharajah 2019). New Zealand's electricity supply is already around 80% renewable (NZ Ministry of Business, Industry & Employment 2019) and a target of 100% renewable by 2035 (Woods 2019) and a legislated national goal of net zero carbon emissions by 2050 (NZ Government 2019).

The jurisdiction with the biggest regional impact, Australia, has excellent availability of energy resources, with economically demonstrated solar and wind resources estimated to be 75% greater than its combined coal, gas, oil, and uranium resources (BZE 2015), available information and a well-regarded Integrated System Plan (AEMO 2020) for grid electricity in the eastern states and South Australia. It "sets out the optimal development path needed for Australia's energy system, with decision signposts to deliver the affordability, security, reliability, and emissions outcome for consumers through the energy transition" (AEMO 2020). Non-government organizations have also generated credible plans (Butler et al. 2020) but it remains to be seen whether implementation will follow. State governments in Australia have shown strong interest in encouraging renewable energy developments in the context of economic recovery from COVID-19 (State of Western Australia 2020; NSW Government 2020; Victoria State Government 2020) but Australia is lagging other developed countries in shutting coal-fired electricity infrastructure and transitioning to renewables (ATSE 2020; Jones et al. 2020; Morton and Readfean 2020).

Solar (IRENA 2014; SolarGIS 2020; NASA 2020), wind (Global Wind Atlas 2019), and geothermal (Coro and Trumphy 2020) energy resource data have been made more accessible in recent years, thanks to local and international efforts. Open availability of information, including realistic costs information (ITP 2019) and examples (ITP 2013; IRENA 2020a) is providing valuable support.

12.4.2 Technical Guidelines for Renewable Energy

In response to an absence of national standards, the Pacific Power Association and the Sustainable Energy Industry Association of the Pacific Islands (SEIAPI) developed 16 voluntary technical guidelines for the Pacific region (SEIAPI/PPA 2020)

for designing, constructing, and maintaining PICT implementations of grid and off-grid PV, PV/fossil hybrid, PV/battery, and micro-hydro systems. Additional guidelines have been produced for solar water pumping, solar water heating, control/data acquisition systems, and energy efficiency. However, an effective joint regional collaboration is considered important to create awareness and ensure in-country adoption.

12.4.3 Training

Training and knowledge exchange have long been identified as essential parts of successful energy transition (Gregory and McNelis 1994; Lucas et al. 2017). Over the last 5–8 years donors have spent in excess of USD 1 billion on solar projects in the Pacific region that included hardware (Keeley 2017) but there have been negligible amounts spent on training and capacity building (Stapleton and Kumar 2020).

In 2011, SEI-API and the University of the South Pacific formed the Renewable Energy & Energy Efficiency Training Competency Standards Advisory Committee (REEETCSAC) (Stapleton 2016). In order to obtain provisional certification, individuals must attend training courses that use the competency standards developed and approved by the REEETCSAC in their curricula. SEI-API and PPA also introduced, and relaunched in 2014, the PPA/SEI-API Certification/Accreditation Program, an industry-based certification and accreditation scheme for individuals and organizations, supporting the development of a high-quality sustainable energy industry (SEI-API/PPA 2020) and more are proposed. The EU-PacTVET project (Shaw 2015) focused on training for climate change and sustainable energy and led to the development of courses for Certificate I, II, III and IV in Sustainable Energy.

From 2018 to 2020, as part of the SEIDP (Sustainable Energy Industry Development Project), SEI-API/PPA ran 34 4-day workshops based on the technical guidelines (SEI-API/PPA 2020) in 12 PICTs, benefitting around 638 different participants (Fig. 12.5). Also, under this project, two sub-regional workshops on PV Operations and Maintenance and SCADA were facilitated in 2018 for the utility members of PPA.

Furthermore, through SEIDP, PPA and SEI-API updated old and developed new competency standards on renewable energy and energy efficiency under the Pacific Register of Qualifications and Standards (DFAT 2016). These standards are relevant to design, installation, operation, and maintenance of off-grid and grid connected PV, solar water pumping, solar water heating, micro hydro power, and grid connected PV/battery systems and residential energy efficiency.

In 2019, GIZ (2020) purchased for PPA a license to use GSES training resource material for four courses on grid connected PV, off-grid PV, PV/fuel generator hybrid systems, and grid connected PV with battery energy storage. Furthermore, using these training resources, GIZ supported development of a training center at Solomon Islands National University (Fig. 12.6) and facilitated Training of Trainers. Based



Fig. 12.5 PPA sub-regional workshops in 2018, funded by the World Bank: **a** Solar PV Operation and Maintenance Training Workshop held in Samoa; and **b** Solar PV Operation and Maintenance Training Workshop held in Pohnpei, Federated States of Micronesia (*Image credits* PPA, SEI-API)

on the positive feedback of this initiative and upon reaching normalcy after COVID-19 pandemic, there should a high possibility of expanding this support to other countries in the Pacific in the coming years, with a strong focus by SEI-API to make more training avenues accessible for their members.

The small but variable populations of the PICTs is a major challenge to having sustainable quality training programs delivered through the region. To mitigate this issue, in 2019, Pacific Region Infrastructure Facility (PRIF 2020) administered a regional training program scoping study in 2019, intended to investigate and confirm training needs in the energy sector which can be best addressed by a regional approach. During the time of writing, the recommendations and outcomes of this report were yet to be finalized but there are reasons to believe that the outcomes will accelerate regional training.



Fig. 12.6 GIZ-funded PV set-up for training by GSES in Solomon Islands (©Global Sustainable Energy Solutions Pty Ltd)

12.4.4 Aid Projects

The effectiveness of aid projects is a major topic on its own and space does not permit its proper treatment here. Considering island communities, Hills et al. (2018) warned that innovation concerns, not just technology and economics terms, but also governance (Sandu et al. 2020), culture, and a multidisciplinary understanding is required for effective local responses. Their village off-grid solar case study indicates inadequate community engagement, management, maintenance, and monitoring, leading to poor outcomes, showing that some of the problems identified long ago (Gregory and McNelis 1994) have persisted. Improved planning of the socio-technological aspects could help strengthen communities' resilience. On the other hand, there are examples in the region of excellent guides (Bushlight 2011; SEI-API/PPA 2020; ITP 2013) based on long experience and successful projects.

Keeley (2017) identified that international aid supporting high renewable energy targets needs well-structured plans, effective regulatory bodies, and close attention to financial aspects of utilities. Encouragingly, Betzold (2016) observed a greater recent international aid emphasis on renewables for energy and on off-grid solar in particular, including on non-hardware aspects such as capacity building, training, and policymaking.

12.5 Conclusion

The PICTs, with a few exceptions, have small culpability for causing the climate crisis that besets the world, but are intensely threatened by its impacts. Consequently, they have a strong motivation and opportunity to participate very actively in the global energy transition from dominance of imported fossil fuel to a future with generally accessible, affordable renewable energy services, and improved balances of payments. While not evenly distributed across the region, there are abundant renewable energy resources in the region (Chap. 3) and in this chapter we have addressed many of the established and, in some case, rapidly improving, and emerging technologies available to convert the naturally available energy to electricity and other useful forms and make it available to Pacific populations.

Significant advances have been made already, including the effective exclusion of kerosene from the lighting market and there are now opportunities for PICTs to bypass the fossil-fueled centralized electricity grid model in locations that did not already take that path, by overcoming the challenges and taking advantage of falling costs as outlined above. Capacity building policy and forming regulatory frameworks to leverage private investments are key enablers. However, much of the abovementioned potential remains unrealized due to mostly non-technical barriers, such as weak regulatory frameworks and inappropriate business models to facilitate financing and partnerships to mobilize and motivate public-private partnerships for the general community benefit, continuing to block the full benefits of the transition.

Cleaner, more autonomous, lower-cost, and more resilient futures are tantalizingly close for the Pacific peoples and the opportunities might be grasped if an analogue of the focus, urgency and camaraderie, and competitive-yet-cooperative spirit that has characterized the multinational race for COVID-19 vaccines in 2020 can be brought to bear on this other crisis too.

Acknowledgements The authors are grateful for helpful comments, advice, and information provision from Peter Johnston of Environmental & Energy Consultants, Ltd., Fiji, and an author of Chap. 3 of this work, as well as Geoff Stapleton, Managing Director of Global Sustainable Energy Solutions Pty Ltd (GSES).

References

- Adisa L (2020) Now speed up, gas pedal, gas pedal: faster transition for NSW? Cornwall Insight Group. <https://www.cornwall-insight.com.au/now-speed-up-gas-pedal-gas-pedal-faster-transition-for-nsw/>. Accessed 8 Jul 2020
- AEMO (2020) 2020 integrated system plan. Australian Energy Market Operator. <https://aemo.com.au/energy-systems/major-publications/integrated-system-plan-isp/2020-integrated-system-plan-isp>. Accessed 31 Jul 2020
- Aliyu M, Hassan G, Said SA, Siddiqui MU, Alawami AT, Elamin IM (2018) A review of solar-powered water pumping systems. *Renew Sust Energ Rev* 87:61–76. <https://doi.org/10.1016/j.rser.2018.02.010>
- Anantharajah K (2019) Governing climate finance in Fiji: barriers, complexity and interconnectedness. *Sustainability* 11(12):18. <https://doi.org/10.3390/su11123414>
- AOSIS (2019) Documents. Alliance of Small Island States. <https://www.aosis.org/documents/>. Accessed 25 Aug 2020
- APVI (2020) IEA PVPS Annual Report. Australia 2019. Available online: https://apvi.org.au/wp-content/uploads/2020/02/PVPS-Annual-Report-2019-Aus_v2.pdf. Accessed 10 Aug 2020
- ARENA (2020a) Wind energy. Australian Renewable Energy Agency. <https://arena.gov.au/renewable-energy/wind/#:~:text=Wind%20energy%20in%20Australia,GW%20of%20wind%20generation%20capacity>. Accessed 3 Aug 2020
- ARENA (2020b) What is bioenergy and energy from waste? Australian Renewable Energy Agency. <https://arena.gov.au/renewable-energy/bioenergy/>. Accessed 11 Aug 2020
- ATSE (2020) Australia's emissions targets—are we on track? Australian Academy of Technology and Engineering (ATSE). <https://www.atse.org.au/news-and-events/article/emissions-targets-are-we-on-track/>. Accessed 18 Aug 2020
- Behi B, Baniyadi A, Arefi A, Gorjy A, Jennings P, Pivrikas A (2020) Cost-benefit analysis of a virtual power plant including solar PV, flow battery, heat pump, and demand management: a Western Australian case study. *Energies* 13 (10). <https://doi.org/10.3390/en13102614>
- Betzold C (2016) Fueling the Pacific: aid for renewable energy across Pacific Island countries. *Renew Sust Energ Rev* 58:311–318
- Bioenergy Association (2020) Using biogas technologies to reduce methane emissions from waste and facilitating circular economies. Bioenergy Association. <https://www.biogas.org.nz/>. Accessed 11 Aug 2020
- Bond K (2020) The A-Z of the energy transition: knowns and unknowns. World Economic Forum in collaboration with the Global Future Council on Energy 2019–2020, Geneva. http://www3.weforum.org/docs/WEF_Energy_transition_known_and_unknown_2020.pdf. Accessed 6 Jul 2020

- Bouman EA, Lindstqand E, Riallan AI, Stromman AH (2017) State-of-the-art technologies, measures, and potential for reducing GHG emissions from shipping—a review. *Transp Res D Transp Environ* 52:408–421
- Bunker K, Gumbs D, Locke J, Torbert R (2020) Green stimulus in the Caribbean. Resilient Distributed Energy Resources Can Support Job Creation and Economic Diversification. Rocky Mountain Institute. <https://rmi.org/stimulus-white-papers/>. Accessed 10 Aug 2020
- Burgess C, Goodman J (2020) Solar under storm. Select best practices for resilient ground-mount PV systems with hurricane exposure. Rocky Mountain Institute. <https://rmi.org/insight/solar-under-storm/>. Accessed 27 Jul 2020
- Bushlight (2010) Bushlight® RE system users manual, BL2-PS1 Edition 8 edn. Centre for Appropriate Technology, Desert Knowledge Precinct, South Stuart Highway, Alice Springs, NT, Australia. https://www.territorystories.nt.gov.au/jspui/bitstream/10070/755003/1/BL2-PS1_User_Manual_Final.pdf. Accessed 10 Aug 2020
- Bushlight (2011) Bushlight's community energy planning model. 2nd edn. Centre for Appropriate Technology, Alice Springs. <https://cfat.org.au/bushlights-community-energy-planning-model>. Accessed 24 Aug 2020
- Butler C, Denis-Ryan A, Graham R, Kelly R, Reedman L, Stewart I, Yankos T (2020) Decarbonisation futures: solutions, actions and benchmarks for a net zero emissions Australia. Climate Works. <https://www.climateworksaustralia.org/resource/decarbonisation-futures-solutions-actions-and-benchmarks-for-a-net-zero-emissions-australia/>. Accessed 8 Jul 2020
- BZE (2015) Renewable energy superpower: zero carbon Australia. Beyond Zero Emissions. <https://bze.org.au/wp-content/uploads/renewable-energy-superpower-bze-report-2015.pdf>. Accessed 18 Aug 2020
- Castellanos G, Ruiz C, Roesch R (2019) Navigating the way to a renewable future: solutions to decarbonise shipping. IRENA. <https://www.irena.org/publications/2019/Sep/Navigating-the-way-to-a-renewable-future>. Accessed 26 Jun 2020
- Chandel SS, Naik MN, Chandel R (2017) Review of performance studies of direct coupled photovoltaic water pumping systems and case study. *Renew Sust Energ Rev* 76:163–175. <https://doi.org/10.1016/j.rser.2017.03.019>
- Charan D (2020) A life cycle analysis of the potential avoided emissions from coconut oil-based B5 transportation fuel in Fiji. In: Singh A (ed) *Translating the Paris agreement into action in the Pacific*. Springer, Cham
- Cho J, Park JH, Kim JK, Schubert EF (2017) White light-emitting diodes: history, progress, and future. *Laser Photonics Rev* 11(2). <https://doi.org/10.1002/lpor.201600147>
- Clean Sky 2 and FCH 2 (2020) Hydrogen-powered aviation. A fact-based study of hydrogen technology, economics, and climate impact by 2050. Clean Sky 2 and Fuel Cells & Hydrogen Joint Undertakings. <https://doi.org/10.2843/471510>
- Cloin J (2007) Coconut oil as a fuel in the Pacific Islands. *Nat Resour Forum* 31(2):119–127. <https://doi.org/10.1111/j.1477-8947.2007.00145.x>
- Coro G, Trumpy E (2020) Predicting geographical suitability of geothermal power plants. *J Clean Prod* 267:121874. <https://doi.org/10.1016/j.jclepro.2020.121874>
- Curtis T (2012) Solar thermal crop dryer for the preservation of *C. indicum* nuts in remote regions of Melanesia. UNSW Sydney, Sydney. <https://unsworks.unsw.edu.au/entities/publication/39fe6fe0-957c-4406-967b-01cba7ed9ed3>. Accessed 8 Apr 2022
- Curtis T, Corkish R, Fuller RJ, Sproul AB (2015) A mixed mode low profile solar tunnel dryer for *Canarium indicum*. Paper presented at the second Asia Pacific solar research conference, Brisbane, 8–10 December 2015
- Department of Industry Science, Energy and Resources (2020) A national strategy for electric vehicles. Department of Industry, Science, Energy and Resources. <https://publications.industry.gov.au/publications/climate-change/climate-change/publications/national-strategy-electric-vehicles.html>. Accessed 5 Jul 2020
- Dethman L, Wabuke M, Illingworth A, Waqavonovono E (2019) Pacific appliance labelling and standards programme. Final evaluation. Final report. The Pacific Community, Geosciences, Energy &

- Maritime Division, Suva, Fiji. http://prdrse4all.spc.int/sites/default/files/final_pals_evaluation_report.pdf. Accessed 23 Aug 2020
- DFAT (2016) Pacific register of qualifications and standards (PRQS): strategic review and management response. Department of Foreign Affairs and Trade. <https://www.dfat.gov.au/about-us/publications/Pages/pacific-register-of-qualifications-standards-strategic-review-mgt-resp>. Accessed 24 Aug 2020
- Dornan M (2015) Renewable energy development in Small Island Developing States of the Pacific. *Resources-Basel* 4(3):490–506. <https://doi.org/10.3390/resources4030490>
- E10 Fuel for Thought (n.d.) NSW government. <https://www.nsw.gov.au/topics/e10-fuel/facts>. Accessed 14 Jul 2020
- Earnest J, Rachel S (2019) Wind power technology. PHI Learning, India
- EECA (2020) Wind. Energy Efficiency & Conservation Authority. <https://www.eeca.govt.nz/energy-use-in-new-zealand/renewable-energy-resources/wind/#:~:text=Currently%20New%20Zealand%20has%2019,producing%20electricity%20in%20late%202020.&text=New%20Zealand%20currently%20has%20no%20offshore%20wind%20farms>. Accessed 3 Aug 2020
- Engel D (2020) Setting the scene: solutions, strategies and policies for a clean energy future. Transition Faster Together. DNV-GL. <https://www.dnvgl.com/transition-faster/index.html?elqTrackId=9e8b07d12805455b8776547ee457b17a&elqaid=1675&elqat=2>. Accessed 16 Jul 2020
- Eras-Almeida AA, Egado-Aguilera MA (2019) Hybrid renewable mini-grids on non-interconnected small islands: Review of case studies. *Renew Sust Energ Rev* 116:20. <https://doi.org/10.1016/j.rser.2019.109417>
- Fiji (2017) Fiji NDC implementation roadmap 2017–2030. Ministry of Economy, Republic of Fiji, Suva. https://cop23.com.fj/wp-content/uploads/2018/03/FIJI-NDC-IMPLEMENTATION-ROADMAP_LOWRES.pdf. Accessed 15 Jul 2020
- Fiji Ministry of Economy (2018) Fiji low emission development strategy 2018–2050. Fiji, Suva. https://gggi.org/site/assets/uploads/2018/12/Fiji-LEDS-2018_DIGITAL.pdf. Accessed 15 Aug 2020
- Filatoff N (2020) Electric aircraft engines could take to the skies over Australia. *PV Magazine*, 1 Jun 2020. <https://www.pv-magazine.com/2020/06/01/electric-aircraft-engines-could-take-to-the-skies-over-australia/>. Accessed 5 Jul 2020
- Fischer M, Woodhouse M, Herritsche S, Trube J (2020) International technology roadmap for photovoltaic (ITRPV) 2019 results, 11th edn. VDMA, Frankfurt am Main. <https://itrvp.vdma.org/>. Accessed 28 Aug 2020
- Forcey T (2015) Get more out of your solar power system by using water as a battery. *The Conversation*. <https://theconversation.com/get-more-out-of-your-solar-power-system-by-using-water-as-a-battery-37807>. Accessed 27 Jul 2020
- GCGET (2019) A new world. The Geopolitics of the Energy Transformation. Global Commission on the Geopolitics of Energy Transformation. http://geopoliticsofrenewables.org/assets/geopolitics/Reports/wp-content/uploads/2019/01/Global_commission_renewable_energy_2019.pdf. Accessed 15 Aug 2020
- Geodynamics (2014) Takara geothermal power project. Draft environmental and social impact assessment. Geodynamics. https://issuu.com/timhewatt6/docs/esia_takara_geothermal_power_plant_. Accessed 5 Jul 2020
- Gielen D, Boshell F, Saygin D, Bazilian MD, Wagner N, Gorini R (2019) The role of renewable energy in the global energy transformation. *Energy Strategy Rev* 24:38–50. <https://doi.org/10.1016/j.esr.2019.01.006>
- GIZ (2020) Deutsche Gesellschaft für Internationale Zusammenarbeit (GIZ). GmbH. <https://www.giz.de/en/html/index.html>. Accessed 24 Aug 2020
- Global Wind Atlas (2019) World Bank, ESMAP, Technical University of Denmark, Vortex. <https://globalwindatlas.info/>. Accessed 14 Jul 2020
- Gnadt AR, Speth RL, Sabnis JS, Barrett SRH (2019) Technical and environmental assessment of all-electric 180-passenger commercial aircraft. *Prog Aeosp Sci* 105:1–30. <https://doi.org/10.1016/j.paerosci.2018.11.002>

- Goundar A, Newell A, Nuttall P, Rojon I, Samuwai J (2017) King Canute muses in the South Seas: why aren't Pacific Islands transitioning to low carbon sea transport futures? *Mar Pol* 81:80–90. <https://doi.org/10.1016/j.marpol.2017.02.012>
- Gregory JA, McNelis B (1994) Nontechnical barriers to the commercialization of PV in developing countries. In: Conference record of the IEEE first world conference on photovoltaic energy conversion. IEEE, New York, pp 700–707
- GSES (2015) Solar water pumping guide. Global Sustainable Energy Systems, Alexandria, NSW
- GSES India (2015) Installation, operation and maintenance of solar PV microgrid systems. GSES India, New Delhi
- Gutierrez-Antonio C, Gomez-Castro FI, de Lira-Flores JA, Hernandez S (2017) A review on the production processes of renewable jet fuel. *Renew Sust Energ Rev* 79:709–729. <https://doi.org/10.1016/j.rser.2017.05.108>
- Heidari A, Nezhad AE, Tavakoli A, Rezaei N, Gandoman FH, Miveh MR et al (2020) A comprehensive review of renewable energy resources for electricity generation in Australia. *Front Energy* 14:510–529. <https://doi.org/10.1007/s11708-020-0671-6>
- Hill JS (2020) Airbus envisions green hydrogen-powered flights by early 2030s. *RenewEconomy*. <https://reneweconomy.com.au/airbus-envisions-green-hydrogen-powered-flights-by-early-2030s-50259/>. Accessed 28 Jul 2020
- Hills JM, Michalena E, Chalvatzis KJ (2018) Innovative technology in the Pacific: building resilience for vulnerable communities. *Technol Forecast Soc Chang* 129:16–26. <https://doi.org/10.1016/j.techfore.2018.01.008>
- HOMER (2020) HOMER Pro. HOMER energy by UL. <https://www.homerenergy.com/products/pro/index.html>. Accessed 10 Aug 2020
- HorizonPower (2020) Onslow distributed energy resource (DER) project. 2020 Horizon Power. <https://horizonpower.com.au/our-community/projects/onslow-distributed-energy-resource-der-project/>. Accessed 8 Jul 2020
- Hunt JD, Byers E, Balogun A-L, Leal Filho W, Colling AV, Nascimento A, Wada Y (2019) Using the jet stream for sustainable airship and balloon transportation of cargo and hydrogen. *Energy Convers Manag* X 3:100016. <https://doi.org/10.1016/j.ecmx.2019.100016>
- Hussain J (2017) Diversification into renewable energy production in the sugar industry. Paper presented at the regional workshop - south exchange on renewable energy & energy efficiency – 6 October 2017. https://www.pcreee.org/sites/default/files/event/files/day_5_session_13_-_renewable_energy_fsc_0.pdf. Accessed 14 Jul 2020
- IEA (2017) Special report: energy access outlook in World Energy Outlook 2017. International Energy Agency, Paris. https://www.pcreee.org/sites/default/files/event/files/day_5_session_13_-_renewable_energy_fsc_0.pdf. Accessed 15 Aug 2020
- IEA (2019) World energy outlook 2019. Executive summary. International Energy Agency, Paris. <https://webstore.iea.org/download/summary/2467?fileName=1.English-Summary-WEO2019.pdf>. Accessed 28 Aug 2020
- IHA (2019) Hydropower worldwide. International Hydropower Association. <https://www.hydropower.org/discover/hydropower-around-the-world>
- IMO (2019) Energy efficiency measures. International Maritime Organization. <https://www.imo.org/en/OurWork/Environment/Pages/Technical-and-Operational-Measures.aspx>
- IRENA (2014) Global atlas for renewable energy. IRENA, International Energy Agency, Abu Dhabi. <https://irena.org/globalatlas>. Accessed 14 Jul 2020
- IRENA (2017a) Rethinking Energy 2017a: accelerating the global energy transformation. International Renewable Energy Agency, Abu Dhabi. <https://www.irena.org/publications/2017a/Jan/REthinking-Energy-2017-Accelerating-the-global-energy-transformation>. Accessed 15 Aug 2020
- IRENA (2017b) National energy roadmaps for islands. IRENA, Abu Dhabi. <https://www.irena.org/publications/2017/Feb/National-Energy-Roadmaps-for-Islands>. Accessed 11 Aug 2020

- IRENA (2018) Transforming small-island power systems: technical planning studies for the integration of variable renewables. International Renewable Energy Agency, Abu Dhabi. <https://www.irena.org/publications/2019/Jan/Transforming-small-island-power-systems>. Accessed 11 Aug 2020
- IRENA (2019a) Transforming the energy system—and holding the line on the rise of global temperatures. International Renewable Energy Agency, Abu Dhabi. <https://www.irena.org/publications/2019/Sep/Transforming-the-energy-system>
- IRENA (2019b) NDCs in 2020: advancing renewables in the power sector and beyond, International Renewable Energy Agency, Abu Dhabi. https://www.irena.org/-/media/Files/IRENA/Agency/Publication/2019/Dec/IRENA_NDCs_in_2020.pdf. Accessed 19 Aug 2020
- IRENA (2020a) SIDS lighthouses initiative. International Renewable Energy Agency, Abu Dhabi. <http://islands.irena.org/#Home>. Accessed 11 Aug 2020
- IRENA (2020b) Renewable power generation costs in 2019. International Renewable Energy Agency. <https://irena.org/publications/2020/Jun/Renewable-Power-Costs-in-2019>. Accessed 15 Aug 2020b
- ITP (2013) Government of Tokelau, renewable energy project. Case study. Government of Tokelau, Canberra. <https://itpau.com.au/wp-content/uploads/2018/08/TREP-case-study.pdf>. Accessed 24 Aug 2020
- ITP (2019) Renewable energy costs in the Pacific. ITP Renewables, Canberra. <https://itpau.com.au/wp-content/uploads/prif-re-web.pdf>. Accessed 23 Aug 2020
- Jackson G (2017) Pacific pests and pathogens - fact sheets: coconut rhinoceros beetle - *Oryctes* (108): Australian Centre for International Agricultural Research. https://www.pestnet.org/fact_sheets/coconut_rhinoceros_beetle__oryctes_108.pdf. Accessed 26 Jun 2020
- Jaunt Motors (2019) Land Rover ev conversions, rental vehicles. Australia. <https://jauntmotors.com/>
- Johnston P, Wade H (2016) Renewable energy electrification master plan for Vanuatu (project final report). Environmental and Energy Consultants Ltd (Suva, Fiji) for The Government of Vanuatu and Deutsche Gesellschaft für Internationale Zusammenarbeit (GIZ), GmbH
- Jones D, Graham E, Tunbridge P (2020) Wind and solar now generate one-tenth of global electricity. Global half-year electricity analysis. Ember. <https://ember-climate.org/project/global-electricity-h12020/>. Accessed 17 Aug 2020
- Joseph L, Prasad R (2020a) Viability of commercial on-shore wind farm sites in Viti Levu, Fiji. In: Singh A (ed) Translating the Paris agreement into action in the Pacific. Springer International Publishing, Cham, pp 151–176. https://doi.org/10.1007/978-3-030-30211-5_7
- Joseph LP, Prasad R (2020b) Assessing the sustainable municipal solid waste (MSW) to electricity generation potentials in selected Pacific Small Island Developing States (PSIDS). *Jclea Prod* 248:19. <https://doi.org/10.1016/j.jclepro.2019.119222>
- Juswanto W, Ali Z (2016) Policy brief; renewable energy and sustainable development in Pacific Island Countries. Asian Development Bank Institute. <https://www.adb.org/sites/default/files/publication/215216/adb-pb2016-5.pdf>. Accessed 27 Dec 2020
- Keeley AR (2017) Renewable Energy in Pacific Small Island Developing States: the role of international aid and the enabling environment from donor's perspectives. *J Clean Prod* 146:29–36. <https://doi.org/10.1016/j.jclepro.2016.05.011>
- Koohi-Fayegh S, Rosen MA (2020) A review of energy storage types, applications and recent developments. *J Energy Storage* 27. <https://doi.org/10.1016/j.est.2019.101047>
- Kuna I, Zehner R (2015) Papua New Guinea country update. Paper presented at the proceedings world geothermal congress 2015 Melbourne, Australia, 19–25 April 2015. http://seslpng.com/wp-content/uploads/files/SESLPNG_Article01028.pdf. Accessed 6 Jul 2020
- Lighting Global (2020) Our impact. Lighting Global. <https://www.lightingglobal.org/about/our-impact/>. Accessed 11 Aug 2020
- Ligo G (2015) Charlot Long Wah dies. *Vanuatu Daily Post*, 28 Feb. https://dailypost.vu/news/charlot-long-wah-dies/article_46aaab79-bf20-5048-8450-fcc533116a77.html. Accessed 18 Jul 2020

- Locke J, Burgess C (2020) Beyond 60 minutes: the Caribbean, center stage for the soft energy pathway. Rocky Mountain Institute. <https://rmi.org/beyond-60-minutes-the-caribbean-center-stage-for-the-soft-energy-pathway/>. Accessed 10 Aug 2020
- Lucas H, Fifita S, Talab I, Marschel C, Cabeza LF (2017) Critical challenges and capacity building needs for renewable energy deployment in Pacific Small Island Developing States (Pacific SIDS). *Renew Energy* 107:42–52. <https://doi.org/10.1016/j.renene.2017.01.029>
- Lund JW (2012) Direct heat utilization of geothermal energy. In: *Comprehensive renewable energy: vol 7: geothermal energy*. <https://doi.org/10.1016/b978-0-08-087872-0.00707-1>
- Maisch M (2020) Microgrid management technology hard at work in Onslow. PV Magazine. <https://www.pv-magazine-australia.com/2020/02/20/microgrid-management-technology-hard-at-work-in-onslow/>. Accessed 8 Jul 2020
- Marczinkowski HM, Ostergaard PA, Djourup SR (2019) Transitioning island energy systems-local conditions, development phases, and renewable energy integration. *Energies* 12(18):20. <https://doi.org/10.3390/en12183484>
- Mazengarb M (2020) NSW unveils plan to switch Sydney's 8,000 buses to all-electric. The Driven. <https://thedriven.io/2019/10/28/nsw-transport-minister-wants-all-of-sydneys-8000-buses-to-go-all-electric/>. Accessed 5 Jul 2020
- McCoy-West AJ, Bignall G, Harvey CC (2009) Geothermal power potential of selected Pacific nations. GNS science consultancy report 2009/180, Institute of Geological and Nuclear Sciences Limited (GNS science). http://prdrse4all.spc.int/system/files/geothermal_potential.pdf. Accessed 5 Jul 2020
- McGarry D (2020) 'It's all gone': cyclone Harold cuts a deadly path through Vanuatu. The Guardian, 10 April 2020. <https://www.theguardian.com/world/2020/apr/10/its-all-gone-cyclone-harold-cuts-a-deadly-path-through-vanuatu>. Accessed 26 Jun 2020
- MCST (2020) Micronesian center for sustainable transport. <https://mcst-rmiusp.org/>. Accessed 27 Dec 2020
- Morton A, Readfearn G (2020) UN climate summit president thanks Australian states – but not Morrison government – for backing net zero. The Guardian, Australian Edition, 2 December. <https://www.theguardian.com/environment/2020/dec/02/net-zero-emissions-by-2050-target-climate-summit-president-thanks-australian-states-but-not-morrison-government>
- Mine.OnePNG (2020) Lack of policy hampering potential geothermal investments in Papua New Guinea. World-Energy. <https://www.world-energy.org/article/9947.html>. Accessed 5 Jul 2020
- Nadan MK (2020) Waste to energy: biogas from municipal solid waste for power generation. In: Singh A (ed) *Translating the Paris agreement into action in the Pacific*. Springer International Publishing, Cham, pp 129–149. https://doi.org/10.1007/978-3-030-30211-5_6
- Nair K (2019) Pacific power utilities benchmarking report. 2018 fiscal year. Pacific Power Association, Suva, Fiji. https://www.ppa.org.fj/wp-content/uploads/2019/09/2018-FY-Benchmarking-Report_update_220719-FINAL.pdf. Accessed 23 Aug 2020
- NASA (2020) The POWER project. NASA. <https://power.larc.nasa.gov/>. Accessed 14 Jul 2020
- New Zealand Ministry of Transport (2020) Electric vehicles. New Zealand Ministry of Transport. <https://www.transport.govt.nz/multi-modal/climatechange/electric-vehicles/>. Accessed 5 Jul 2020
- Nguyen MV, Arason S, Gissurarson M, Pálsson PG (2015) Uses of geothermal energy in food and agriculture: opportunities for developing countries, agriculture and consumer protection. FAO, Rome. <http://www.fao.org/3/a-i4233e.pdf>. Accessed 17 Aug 2020
- NSW Government (2020) Renewable energy zones. NSW Government. <https://energy.nsw.gov.au/renewables/renewable-energy-zones>. Accessed 3 Aug 2020
- Nuttall P, Newell A, Prasad B, Veitayaki J, Holland E (2014) A review of sustainable sea-transport for Oceania: providing context for renewable energy shipping for the Pacific. *Mar Pol* 43:283–287. <https://doi.org/10.1016/j.marpol.2013.06.009>
- NZ Government (2019) Climate change response (zero carbon) amendment act. Wellington. <https://www.mbie.govt.nz/dmsdocument/7040-energy-in-new-zealand-2019>. Accessed 5 Aug 2020

- NZ Ministry of Business, Industry & Employment (2019) Energy in New Zealand 2019. Ministry of Business, Innovation & Employment, Wellington. <https://www.mfe.govt.nz/climate-change/zero-carbon-amendment-act>. Accessed 5 Aug 2020
- Pacific Community (2020) Pacific community results report 2019. <https://www.spc.int/resource-centre/key-documents/pacific-community-results-report-2019>. Noumea Accessed 29 Jan 2021
- Pacific Community (2021a) Framework for energy security and resilience in the Pacific (FESRIP) 2021–2030, vol 1. Pacific Community (SPC), Suva, Fiji. <https://pacificdata.org/data/dataset/oai-www-spc-int-fafde076-6927-4cb6-ac84-9363ff7f7a97>
- Pacific Community (2021b) Framework for energy security and resilience in the Pacific (FESRIP) 2021–2030, vol 2. Issues and Background Papers. Pacific Community (SPC), Suva, Fiji. <https://pacificdata.org/data/publications/oai-www-spc-int-697fe781-8219-4d7e-bb1f-e4539fe6293d/resource/5d30ccc2-9ea9-4127-8496-7045b87f3af0>
- PALS (2019) Pacific appliance labelling and standards (PALS). Pacific Community. <https://gem.spc.int/projects/pals>. Accessed 23 Aug 2020
- Panagiotidou M, Aye L, Rismanchi B (2020) Solar driven water heating systems for medium-rise residential buildings in urban Mediterranean areas. *Renew Energy* 147:556–569. <https://doi.org/10.1016/j.renene.2019.09.020>
- Parkinson G (2020) Another big international group hit by Australian solar project losses. *RenewEconomy*. <https://reneweconomy.com.au/another-big-international-group-hit-by-australian-solar-project-losses-30868/>. Accessed 10 Aug 2020
- PBSP (2020) Concept note. The Pacific blue shipping partnership (draft for consultation). Pacific Blue Shipping Partnership. https://mcst-rmiusp.org/images/Projects/PBSP2019/PBSP_Concept_Note_Feb_2020.pdf. Accessed 4 Jul 2020
- PCREEE (2020) Online validation of the regional e-mobility policy and program for Pacific Islands. PCREEE. <https://www.pcreee.org/event/online-validation-regional-e-mobility-policy-and-program-pacific-islands>. Accessed 26 Jul 2020
- Peterson MG (2016) Geothermal energy prospects in selected Pacific Island countries and territories. Paper presented at the 50th anniversary of CCOP. https://www.researchgate.net/publication/322568615_Geothermal_Energy_prospects_in_Selected_Pacific_Island_Countries_and_Territories. Accessed 5 Jul 2020
- PNG (2012) Geothermal energy policy. Government of Papua New Guinea, <https://policy.asiapacificenergy.org/node/861>. Accessed 5 Jul 2020
- PPA (2017) Benchmarking portal. Pacific Power Association. <https://www.ppa.org.fj/benchmarking-portal/>. Accessed 23 Aug 2020
- Praene JP, Payet M, Benard-Sora F (2019) Corrigendum to “Sustainable transition in small island developing states: assessing the current situation” [Utilities Policy (2018) 86–91]. *Util Policy* 56:194–200. <https://doi.org/10.1016/j.jup.2018.10.004>
- Prasad RD, Raturi A (2019) Fuel demand and emissions for maritime sector in Fiji: Current status and low-carbon strategies. *Mar Pol* 102:40–50. <https://doi.org/10.1016/j.marpol.2019.01.00>
- Prasad RD, Raturi A (2020) Solar energy for power generation in Fiji: history, barriers and potentials. In: Singh A (ed) *Translating the Paris agreement into action in the Pacific*. Springer, pp 177–199. <https://doi.org/10.1007/978-3-030-30211-5>
- Prasad S, Singh A (2020) Economic feasibility of biodiesel production from Pongamia Oil on the Island of Vanua Levu. *SN Appl Sci* 2(6):1086. <https://doi.org/10.1007/s42452-020-2883-0>
- PRIF (2020) Pacific region infrastructure facility. <https://theprif.org/>. Accessed 24 Aug 2020
- Queensland Government (2020) Legionnaires’ disease prevention. <https://www.qld.gov.au/health/conditions/all/prevention/legionnaires-prevention>. Accessed 27 Jul 2020
- Raturi A (2012) Status of and potential for utilizing coconut oil (CNO) in power generation and industrial use in Pacific Island Countries. SEFP, World Bank, Fiji. https://www.researchgate.net/publication/266349801_Status_of_and_Potential_for_Utilizing_Coconut_Oil_CNO_In_Power_Generation_and_Industrial_Use_in_Pacific_Island_Countries. Accessed 25 Jun 2020

- Remeikis A (2019) ‘Shorten wants to end the weekend’: Morrison attacks Labor’s electric vehicle policy. *The Guardian*. <https://www.theguardian.com/australia-news/2019/apr/07/shorten-wants-to-end-the-weekend-morrison-attacks-labors-electric-vehicle-policy>. Accessed 5 Jul 2019
- Republic of Vanuatu, Intended Nationally Determined Contribution (INDC). 2019. Republic of Vanuatu, Port Vila. <https://www4.unfccc.int/sites/ndcstaging/PublishedDocuments/Vanuatu%20First/VANUATU%20%20INDC%20UNFCCC%20Submission.pdf>. Accessed 6 Jul 2020
- RMI (2021) Islands energy program. Rocky Mountains Institute. <https://rmi.org/our-work/islands-energy-program/>. Accessed 1 Jan 2021
- Roy EA, AAP (2020) Rio Tinto smelter in New Zealand to close with loss of 1,000 jobs. *The Guardian*, 9 July. <https://www.theguardian.com/world/2020/jul/09/rio-tinto-smelter-in-new-zealand-to-close-with-loss-of-1000-jobs#:~:text=More%20than%201%2C000%20jobs%20will,the%20business%20was%20not%20viable>. Accessed 3 Aug 2020
- Sachs J, Schmidt-Traub G, Kroll C, Lafortune G, Fuller G, Woelm F (2020) The sustainable development goals and COVID-19. Sustainable development report 2020. Cambridge University Press, Cambridge. <https://dashboards.sdgindex.org/downloads>. Accessed 6 Jul 2020
- Salomón M, Leal E, Gonzalez-Salazar M, Martin A, Fransson T (2009) Energy potential of coconut and palm oil residues. Paper presented at the Dubrovnik conference on sustainable development of energy, water and environment systems, Dubrovnik, Croatia. https://www.researchgate.net/publication/258553765_Energy_Potential_of_Coconut_and_Palm_Oil_Residues. Accessed 28 Aug 2020
- Sandu SW, Yang MY, Shi XP, Chi YY (2020) A governance perspective on electricity industry development: the case of Papua New Guinea. *Energy Policy* 141:10. <https://doi.org/10.1016/j.enpol.2020.111464>
- Schmidt B (2021) Australia’s GB Auto secures huge deal to convert Hilux Utes and Land Cruisers to electric. *The Driven*. <https://thedriven.io/2021/01/27/australias-gb-auto-secures-huge-deal-to-convert-hilux-utes-and-land-cruisers-to-electric/>. Accessed 27 Jan 2021
- SEI-API/PPA (2020) Guidelines. Sustainable Energy Industry Association of the Pacific Islands (SEI-API). <https://www.seiapi.com/>. Accessed 8 Jul 2020
- Shaw A (2015) PACTVET Pacific technical and vocational education and training in sustainable energy and climate change adaptation. Sustainable Energy for All (SE4ALL), Suva. <https://prdrse4all.spc.int/node/4/content/pactvet-pacific-technical-and-vocational-education-and-training-sustainable-energy>
- Singh A (2020a) Translating the paris agreement into action in the Pacific. https://doi.org/10.1007/978-3-030-30211-5_13
- Singh A (2020b) Summary of outcomes and implications for the Fiji NDC implementation roadmap. In: Singh A (ed) Translating the Paris agreement into action in the Pacific. Springer International Publishing, Cham, pp 317–323. https://doi.org/10.1007/978-3-030-30211-5_13
- Singh SR (2020) An Assessment of the Hydro Potential for Viti Levu, Fiji Using GIS Techniques. In: Singh A (ed) Translating the Paris agreement into action in the Pacific. Springer International Publishing, Cham, pp 101–127. https://doi.org/10.1007/978-3-030-30211-5_5
- Singh A, Bijay P (2020) Mitigating through renewable energy: an overview of the requirements and challenges. In: Singh A (ed) Translating the Paris agreement into action in the Pacific. Springer International Publishing, Cham, pp 29–57. https://doi.org/10.1007/978-3-030-30211-5_2
- Singh K, Bule L, Khan MGM, Ahmed MR (2019) Wind energy resource assessment for Vanuatu with accurate estimation of Weibull parameters. *Energy Explor Exploit* 37:1804–1833. <https://doi.org/10.1177/0144598719866897>
- SolarGIS (2020) Solar resource maps and GIS data for 200+ countries. SolarGIS. <https://solargis.com/maps-and-gis-data/overview>. Accessed 14 Jul 2020
- Sontake VC, Kalamkar VR (2016) Solar photovoltaic water pumping system—a comprehensive review. *Renew Sust Energ Rev* 59:1038–1067. <https://doi.org/10.1016/j.rser.2016.01.021>

- Sproul AB (2005) Design of PV powered, high efficiency pool pump systems. Solar 2005, Dunedin, NZ. https://scholar.google.com/scholar_lookup?title=Design%20of%20PV%20powered%2C%20high%20efficiency%20pool%20pump%20systems&author=A.B.%20Sproul&publication_year=2005. Accessed 28 Aug 2020
- Stapleton G (2016) PPA SEI-API accreditation/certification program. Paper presented at the SPC regulators workshop, Tonga August. http://prdrse4all.spc.int/sites/default/files/day_5_2._ppa_sei_api_certification_program_0.pdf. Accessed 24 Aug 2020
- Stapleton G, Kumar S (2020) Update on quality technical training initiatives for the Pacific. PPA Magazine, vol 28. Pacific Power Association. https://www.ppa.org.fj/wp-content/uploads/2020/07/VOLUME_28_ISSUE_2_A4_LAYOUT_COMPLETE-FINAL-240620-1.pdf. Accessed 24 Aug 2020
- State of Western Australia (2020) WA recovery plan. State of Western Australia, Perth. https://www.wa.gov.au/sites/default/files/2020-07/WA_Recovery_Plan.pdf
- Sustainability Victoria (2015) Best practice guide. In: Energy efficiency: pumping systems. Sustainability Victoria, Melbourne. <https://www.sustainability.vic.gov.au/-/media/SV/Publications/Business/Efficient-business-operations/Energy-efficiency-for-business/Energy-efficiency-best-practice-guidelines/SRSB-EEBPG-Pumping-Systems-Mar-2015.pdf?la=en>. Accessed 10 Jul 2020
- Taibi E, Gualberti G, Bazilian M, Gielen D (2016) A framework for technology cooperation to accelerate the deployment of renewable energy in Pacific Island Countries. Energy Policy 98:778–790. <https://doi.org/10.1016/j.enpol.2016.03.009>
- Tancredi T (2019) All-electric 4WD launched in Adelaide. WhichCar. <https://www.whichcar.com.au/news/zero-automotive-zed70-launched>. Accessed 5 Jul 2020
- Tina River Hydropower Development Project (2020) Tina River hydropower development. Project. <https://www.tina-hydro.com/>. Accessed 11 Aug 2020
- Tracking SDG 7 (2020) The energy progress report. <https://trackingsdg7.esmap.org>. Accessed 7 Jul 2020
- Udomkun P, Romuli S, Schock S, Mahayothee B, Sartas M, Wossen T et al (2020) Review of solar dryers for agricultural products in Asia and Africa: An innovation landscape approach. J Environ Manage 268:110730. <https://doi.org/10.1016/j.jenvman.2020.110730>
- UN-OHRLLS (2015) SIDS accelerated modalities of action (S.A.M.O.A.) pathway. United Nations Office of the High Representative for the Least Developed Countries, Landlocked Developing Countries and Small Island Developing States. <https://unohrlls.org/custom-content/uploads/2015/01/SAMOA-Pathway.pdf>
- UNELCO (2019) Copra for electricity. UNELCO, Port Vila. https://www.unelco.engie.com/imagenes/doc/copra_oil_in_vanuatu_03.pdf. Accessed 26 Jun 2020
- Vanuatu Daily Post (2012) Solar crop dryer can revolutionise nangai production: Longwah. 12 Jun. <https://hawaii-agriculture.com/solar-crop-dryer-can-revolutionise-nangai-production-longwah-vanuatu-daily-post/>. Accessed 18 Jul 2020
- Vanuatu Daily Post (2020) Official opening of Talise hydro stage 2. Vanuatu Daily Post, 29 July. https://dailypost.vu/news/official-opening-of-talise-hydro-stage-2/article_7fc83e19-031a-573a-8872-6f3824800eee.html. Accessed 10 Aug 2020
- Vanuatu Department of Agriculture and Rural Development. 2016. Vanuatu National Coconut Strategy 2016–2025. Department of Agriculture and Rural Development, Vanuatu, Port Vila. <https://pafpnet.spc.int/attachments/article/651/Vanuatu%20National%20Coconut%20Strategy%202016-2025.pdf>. Accessed 26 Jun 2020

The opinions expressed in this chapter are those of the author(s) and do not necessarily reflect the views of the UNESCO: United Nations Educational, Scientific and Cultural Organization, its Board of Directors, or the countries they represent.

Open Access This chapter is licensed under the terms of the Creative Commons Attribution-ShareAlike 3.0 IGO License (<https://creativecommons.org/licenses/by-sa/3.0/igo/>), which permits use, sharing, adaptation, distribution, and reproduction in any medium or format, as long as you give appropriate credit to the UNESCO: United Nations Educational, Scientific and Cultural Organization, provide a link to the Creative Commons licence and indicate if changes were made. If you remix, transform, or build upon this book or a part thereof, you must distribute your contributions under the same licence as the original.

The use of the UNESCO: United Nations Educational, Scientific and Cultural Organization's name, and the use of the UNESCO: United Nations Educational, Scientific and Cultural Organization's logo, shall be subject to a separate written licence agreement between the UNESCO: United Nations Educational, Scientific and Cultural Organization and the user and is not authorized as part of this CC-IGO licence. Note that the link provided above includes additional terms and conditions of the licence.

The images or other third party material in this chapter are included in the chapter's Creative Commons licence, unless indicated otherwise in a credit line to the material. If material is not included in the chapter's Creative Commons licence and your intended use is not permitted by statutory regulation or exceeds the permitted use, you will need to obtain permission directly from the copyright holder.



Chapter 13

Secured WEF and Gender: Better Data for Equality and Resilience



Laura Imburgia

Better informed WEF system analyses improve security, equality and resilience.

Abstract Under increasing climate uncertainties and extremes, threats to water, energy, and food (WEF) security affect vulnerable social groups in disproportionate ways. In the Pacific region, women and girls continue to be disadvantaged in access to water, sanitation, and hygiene services; in their decision-making power over natural resources management, and in developing their full potential for economic autonomy. Gender disparities are usually based on structural inequalities rooted in cultural norms, social stratification, and relations of power. Sector analyses often do not adequately reflect how the WEF security nexus and gender interrelate. One main factor conditioning ill-informed sector analyses is the lack of sex-disaggregated data. The chapter briefly discusses availability of gender disaggregated WEF-related data in the Pacific region with a focus on the Pacific Small Island Developing States. It then proposes an integrative gender methodology for the analysis of natural resources management and agricultural development programmes for policy and project development. Useful methodological tools for disaggregating data by gender are further discussed.

Keywords Water security · Gender · Equality · Sex-disaggregated data · Gender-analytical framework · Pacific SIDS

13.1 Introduction

Increasing climate variability and increasing social stratification present challenges to sustaining livelihoods and community resilience in the Pacific Region. One of the

L. Imburgia (✉)
UNESCO World Water Assessment Programme (WWAP), Via dei Ceraioli, 45, 06134 Perugia,
Italy
e-mail: lv.imburgia@unesco.org

© UNESCO 2024

A. Dansie et al. (eds.), *The Water, Energy, and Food Security Nexus in Asia and the Pacific*, Water Security in a New World,
https://doi.org/10.1007/978-3-031-25463-5_13

281

results is the growing difficulty for large segments of the Pacific population to secure access to water and sanitation—being denied, in effect, a human right (UN 2010, 2016). Likewise, energy poverty, particularly in rural areas, compromises efforts to make livelihoods more reliable and sustainable. Access to affordable and nutritious food poses similar challenges, especially in urban and peri-urban environments. Combined, threats to safe, reliable, affordable, and equitable access to water, energy, and food (WEF) affect the most vulnerable in disproportionate ways. Further, in Pacific communities, adaptive strategies and resilience are compromised by climate extremes and frequent natural disasters.

Today, inclusion and equality issues related to water, in particular those of gender, rank highly in international policy frameworks and agreements. Although the rights and roles of women in water and sanitation services have received increasing attention in country policy and planning, in many countries, severe inequalities in water security persist (UNESCO WWAP 2021). Women and girls continue to be disadvantaged in access to water, sanitation and hygiene (WASH) services while simultaneously bearing the household burden of providing daily water needs. Moreover, gaps in the participation and leadership of women in water jobs and in water resources management are significant (World Bank Group 2019).

Environmental and water policies largely overlook the unpaid care and domestic work responsibilities of women, exacerbating their difficulties for equal and meaningful participation in and administration of the water sector. The critical part women play in the productive uses of water, including irrigation, related micro-enterprises, and employment in water-related jobs is still lacking adequate attention in practice (Das 2017).

Social differences and inequalities, including those related to gender, are substantial in the Pacific region (WFP and SPC 2018). Many women are disproportionately disadvantaged in terms of access to, use and control of water and other resources for food production and for livelihoods (CARE 2020). Disadvantages and constraints include that women remain underrepresented in political spheres and a large proportion of women are subject to gender-based violence (UN Women 2014; ADB 2016). Evidence exists about the gendered and social dimensions of water insecurity (UNESCO WWAP 2021), food insecurity (Broussard 2019), and energy poverty (UN-Women 2017) which are often rooted in structural inequalities including differences in education, income and socio-economic status determined by social norms, social stratification, and relations of power (Broussard 2019; Imburgia et al. 2021). Accordingly, WEF security is a factor not only of gender but also of class, age, ethnicity, type of access, and locality among others. These dimensions compound other conditions of vulnerability, notably health conditions and disability (Mactaggart et al. 2021).

Root causes of gender inequalities and different vulnerabilities are not always well understood due to incomplete or ill-informed sector analyses (Lefore et al. 2017; Imburgia 2019). Sectoral analyses often do not adequately reflect the intersections between the WEF security nexus and gender. This results in a poor understanding of how water, energy, and food security are gendered. The direct consequence is a lack of

effective gender inclusion in policy and implementation with direct impact on investments for improvements in WEF. The main factor conditioning ill-informed sector analyses is the lack of sex-disaggregated data. This problem is further compounded by disparities in data availability in different Pacific countries (ADB 2016; CARE 2020; Michalena et al. 2020).

Water-energy-food security and gender inequalities are complex and multi-dimensional issues, calling for an integrative analysis approach. *How could gender disaggregated data contribute to the understanding of the interrelations between climate crisis, deficient access to water, sanitation, and energy, and secure livelihoods?*

The following sections will briefly discuss availability of gender disaggregated WEF-related data in the Asia–Pacific region with a focus on the Pacific Small Islands Developing States (SIDS). It will then propose an integrative gender methodology for the analysis of natural resources management and agricultural development programmes for policy and project development. Useful methodological tools for disaggregating data by gender will be discussed.

13.2 Gender and Sex-Disaggregated WEF Data Availability in the Pacific SIDS Sub-Region¹

The 2014 SIDS Accelerated Modality of Action (SAMOA) Pathway recognized the transformative and multiplier effect of gender equality and realization of human rights for women and girls on sustainable development, economic growth, and adaptation to climate change in the Pacific SIDS (UN 2014). Gender equality and a perspective on the empowerment of women have been guiding major country-donor activity in the region for the last decade (USAID, n.d.; World Bank 2012; DFAT 2016; MFAT 2021).

The SAMOA Pathway included an explicit commitment to “improve the collection, analysis, dissemination and use of gender statistics and data disaggregated by sex, age, disability and other relevant variables in a systemic and coordinated manner at the national level, through appropriate financial and technical support and capacity-building, while recognizing the need for international cooperation in this regard” (UN 2014). In recent years, significant progress has been reported from the Pacific region in conducting population and housing censuses and collecting household income and expenditure data (ADB 2016). On the other hand, few countries in the region have advanced the monitoring and evaluation of gender issues through statistics, due to weak technical and financial capabilities (ADB 2016). Some of the Pacific SIDS count on national statistical systems available online with statistics provided, for example, by the Parliament (Fiji), by the Ministry of Finance and Economic Development (Kiribati), or by the National Statistics Department (Niue and Tonga). These sources provide mostly economic and demographic statistics.

¹ Assistance in the literature review provided by Arianna Fusi, UNESCO WWAP Junior Consultant.

Gender data and the monitoring needs are to a large extent being bridged by global and regional donor agencies, and development agencies,² which play a critically important role in assessing and generating disaggregated data and evidence-based information for decision making (ADB 2016; UNESCAP 2021). Efforts are also addressing the necessity of better data quality and accessibility by supporting statistical innovation and capacity development.³

The amount and quality of information available in each Pacific Island Country varies. The larger countries, by population size, tend to have relatively comprehensive information and datasets, and are also the ones receiving more attention in studies and development documents (ADB 2016). In general, gender disaggregated data availability in the Pacific SIDS is quite variable and, in many cases, updates are needed. Countries with the greatest need to update their gender disaggregated data include Nauru, New Caledonia, Niue, Palau, Tokelau, and Tuvalu. Other countries, such as Cook Islands, Federated States of Micronesia, Marshall Islands,⁴ Kiribati, Samoa, Solomon Islands, Timor-Leste, Tonga, and Vanuatu have more recent data; however, they also rely significantly on outdated resources (2010–2015). Fiji and Papua New Guinea are the countries with the most recent data (2018 and newer).

Agriculture and fisheries are key development sectors providing major sources of livelihoods and food security in the Pacific SIDS. In 2020, 61% of the population was reported to be rural; on average, agriculture, forestry, and fishing represent close to 13% of the GDP of the Pacific SIDS that record this information, with some countries including Kiribati, Solomon Islands, and Vanuatu exceeding 25% of the GDP (World Bank, n.d.). In countries with a large representation of rural population and agriculture as the most important livelihood, disaggregated land tenure data provide an important proxy for gender equality. Revision of relevant databases and statistical resources⁵ indicated the following overall results: Cook Islands, Fiji, Palau, Papua New Guinea, Samoa, Solomon Islands, Timor-Leste, Tonga, and Vanuatu collect sex-disaggregated data on land tenure. Fiji and Papua New Guinea rank first in data availability regarding access to land, landownership, and land rights. Solomon Islands and Tonga mostly rely on general, non-disaggregated information on land tenure. The Federated States of Micronesia, Kiribati, Marshall Islands, Nauru,

² Agencies and organizations with the largest involvement in collecting data are UN Women, FAO, the Asian Development Bank (ADB), and the World Bank. Water related data, in particular WASH, are largely collected by the JMP, World Health Organization (WHO)-UNICEF, CARE Australia, and the Pacific Community.

³ The World Bank project “Statistical Innovation and Capacity Building in the Pacific Islands” implemented by the Pacific Community—Statistics for Development Division (SPC-SDD) provides an example of such efforts: <https://projects.worldbank.org/en/projects-operations/project-detail/P168122>.

⁴ The ADB project “Promoting Evidence-Based Policy Making for Gender Equity in the Pacific (Phase II)” presents a compilation of key statistics disaggregated by gender in Marshall Islands. <https://www.adb.org/publications/marshall-islands-gender-equality-overview>.

⁵ Databases and statistical resources included: Parliament of the Republic of Fiji, <http://www.parliament.gov.fj/gender-data-hub/>; Databank of The World Bank, <https://databank.worldbank.org/home>; Asia and the Pacific UN Women databases, <https://asiapacific.unwomen.org/en/countries>; PNG land area data, <https://www.land-links.org/country-profile/papua-new-guinea/>.

New Caledonia, Niue, Palau, Tokelau, and Tuvalu lack gender-disaggregated data on landownership.

In the agriculture and fisheries sectors, gender disaggregated data on employment are some of the most available in the region, although with high variability among countries. These data are mostly available for Melanesia, Samoa, Tonga, and Timor-Leste (FAO, n.d.; World Bank, n.d.). However, comparability is difficult as some countries have more fine-grained, specific data compared to the others, and not all countries use standardized parameters. Data on employment and roles of women in fisheries are available for Cook Islands, Federal State of Melanesia, Fiji, Papua New Guinea, Samoa, Solomon Islands, Timor-Leste, and Tuvalu. To a large extent, the information available on participation of women in fisheries belongs to country case studies and qualitative studies.⁶

For water and sanitation data, all countries rely only on non-disaggregated data by household; some countries also include WASH data for schools and health facilities (JMP, n.d.). Countries with higher availability of sex-disaggregated water and/or sanitation data include Fiji (data on access to water and WASH), Kiribati (access to drinking water and WASH), Marshall Islands (WASH for children and access to drinking water), Papua New Guinea (gender and water, irrigation and water collection), Solomon Islands (data on water deprivation and sanitation deprivation), Timor-Leste (access to water and sanitation), Tonga (access to drinking water, time spent collecting water, sanitation), and Vanuatu (access to WASH). In the energy sector, data on access to electricity are usually collected at the household level, therefore gender differences in energy security are usually difficult to identify. Cooperation development in the energy sector is including gender considerations and the overall goal of accelerating progress towards gender equality in the sector (UNWomen 2017; ADB 2021), although sex-disaggregated data collection to inform energy development investments is yet to be collected.

13.3 The Need for Integrative Gender Analyses and Sex-Disaggregated Water Data—Available Methodological Tools

The 2030 Agenda for Sustainable Development with its 17 Sustainable Development Goals (SDG) provided a roadmap for countries and asked for their commitments to overcoming poverty (SDG 1) and food insecurity (SDG 2) by investing in rural areas, supporting agricultural livelihoods, including fisheries (UN 2019), promoting sustainable and inclusive access to energy (SDG 7), and promoting strategies to cope and adapt to climate variabilities and change (SDG 13) while protecting marine (SDG 14) and land (SDG 15) resources. Relevant to all SDGs is the call for secured

⁶ Contributions can be found in the Women in Fisheries Bulletin from the Pacific Community Coastal Fisheries Programme, available at <https://coastfish.spc.int/en/publications/bulletins/women-in-fisheries/510>.

water and sanitation access and sustainable water resources management (SDG 6) with special considerations to the role of women and girls in securing water for their households and families and overcoming gender inequalities (SDG 5). As a necessary input for integrative analyses, relevant data must be disaggregated by gender as called for in target 17.18 of SDG 17.

Recent reports assessing the achievements of the SDGs in the Pacific Region indicate slow progress toward the achievement of the critical SDGs for the Small Island Development States,⁷ including SDGs 2, 5, 6, 7, 12, 13, 14, 15, and 17 (ADB/UN Women 2018; UNESCAP 2021). There is a clear and present need to re-think development programmes and reinforce holistic, integrative approaches. Secured water, energy, and food, and gender equality are intrinsically linked, hence the related SDGs should be analysed together to more realistically identify driving factors and root causes for vulnerabilities and inequalities. The specific linkages between water, energy, food, and gender equality need to more explicitly be recognized and addressed in implementation actions for SDGs.

Better informed, more effective planning, and implementation require methodological approaches able to capture the intersections between the social, technical, and environmental dimensions interplaying in water, energy, and food. Furthermore, accurate analytical methods and tools need gender disaggregated data to understand women's and men's (and other groups) different access and use of resources, diverse roles and responsibilities, and the social and cultural constructions they are based upon. Accurate gender disaggregated data are also needed to reduce and avoid misconceptions of needs and priorities of different groups, especially women. When these analyses include disaggregated data not only by gender but also by other dimensions of differences, whether age, locality, socio-economic, and vulnerability conditions, they become useful tools for designing programs to promote resilience and sustainable livelihoods (Thompson-Hall et al. 2016).

Although disaggregated data are still sparse in the Pacific Region, it was possible to identify that in Solomon Islands, Marshall Islands, and Tonga, 60% of the administrative and clerical staff officers in government fisheries departments are women; however, only 18% of women work as researchers or managers roles in those offices (Michalena et al. 2020). Proper analyses must identify and describe differences within the islands, which are characterized by very high geographical, environmental, and socio-cultural diversity. Moreover, these analyses should note traditional knowledge and gender roles in daily life and also in decision making, which determine to a large extent those socio-cultural differences. Unless more complete and disaggregated data are incorporated in policy, planning, and implementation, advances in gender equality and inclusivity will continue to be unacceptably slow and insufficient.

⁷ According to UNDESA, related SDGs for SIDS include SDG 2, 5, 6, 7, 12, 13, 14, 15 and Available at: <https://sdgs.un.org/goals>.

13.3.1 An Integrative Methodological Framework for WEF and Gender

To address the need for comprehensive and better-informed analyses, the use of an integrative gender methodological framework to examine WEF systems is proposed that combines the technical dimensions of WEF systems and management, and the social relations dimension of WEF governance (see Imburgia 2019 for a full description). This approach has a focus on the results and practices determined by social behaviour and interactions, notably, gender access, gender roles and relations, and the effect on livelihood strategies.

This framework concentrates on the intersections and nuanced relationships of the technical and social relations aspects of natural resource management (NRM) (of which WEF systems are a part) in three key variables: access, participation, and decision making. This framework was motivated by the analytical approach of the feminist political ecology (FPE), which aims at capturing the social differences and inequalities present in ecological, economic, and development processes due to social relations of power (Rocheleau et al. 1996; Elmhirst 2015). In order to introduce robustness to the “ecology” aspect of the FPE framework, the methodological approach was combined with the conceptualization of NRM system managed collectively as a social-ecological system (SES) of diverse complexity (Anderies et al. 2004), including their interactions and outcomes (McGinnis and Ostrom 2014). For the further construction of this framework, appropriate elements of the social relations framework (Kabeer 1994) were incorporated to more accurately examine gender social interactions that condition uneven access to resources, imbalance in power, and decision making.

By combining selected elements of the three theoretical ideas, FPE, SES, and social relations frameworks, the integrative gender-analytical approach allows examining the nuanced dynamics of social relations that drive the processes and outcomes of NRM governance (see Fig. 13.1).

By applying the methodological framework, four outcomes (see bottom of Fig. 13.1) synthesise the core elements of the functioning of NRM, including WEF systems: (1) security of access to the resources (be these water, energy, food); (2) security of livelihood strategies; (3) autonomy for decision-making and for financial sustenance, and (4) adaptive strategies to environmental, climate, economic, policy, and other changes. The analysis of these outcomes provides key entry points to explain why and how gender differences shape access, use, and participation in resources governance. These outcomes are useful to organize and analyze the empirical evidence. The analysis of these interrelated outcomes allows for a detailed account of the processes of gender differences and inequalities in the sector under study. Importantly, this methodological approach helps to identify entry points for policy and planning implications and highlights critical areas where disregarding gender issues will increase the likelihood of WEF systems failure.

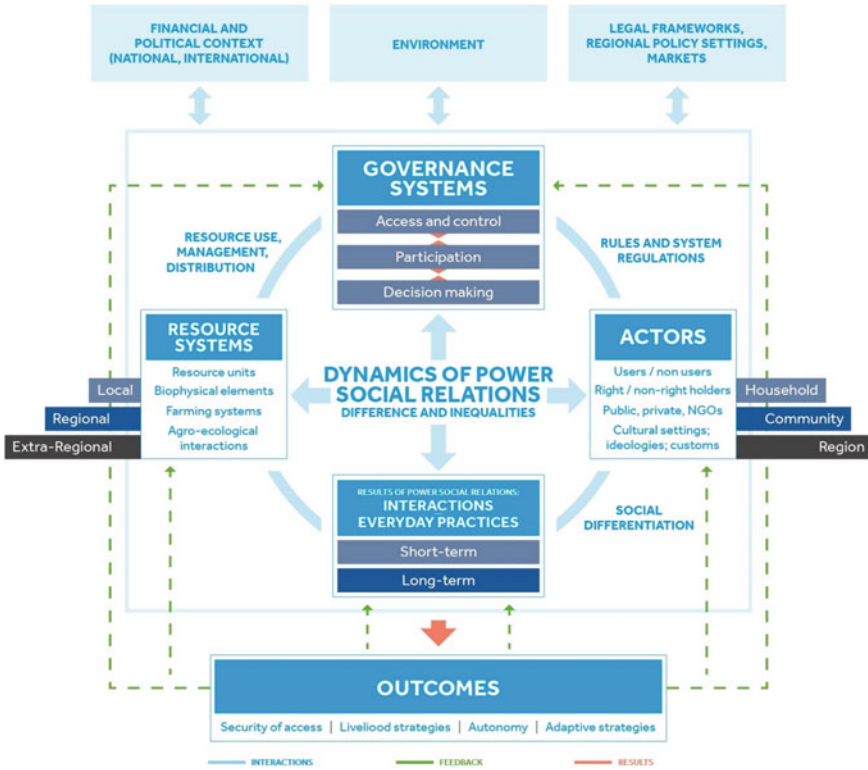

Fig. 13.1 The integrative gender-analytical approach to natural resource governance (Source Imburgia 2019)

The fisheries sector of the Pacific SIDS is suitable to illustrate the use of the framework. This sector integrates complex **resource systems** related to water, biodiversity, food security, and livelihoods, adaptation to climate change and governance. The largest portion of the global workforce in fisheries and aquaculture (85%) is located in Asia; Oceania accounts for 1% of this global workforce (FAO 2020). In the Pacific SIDS, fisheries have a critically important role as a main source of food, employment, and income generation (Charlton et al. 2016). Women involved in the marine resource are **key actors** in these systems. Their involvement influences management results shaped by their knowledge and traditional expertise, but also by cultural norms and beliefs that influence their role in the sector value chain. For example, traditional beliefs in the region hold that fisheries are a male domain (Harper et al. 2013; Michalena et al. 2020) with men mostly involved in the commercial fisheries and in deep-sea fishing (Makhoul 2021), and women mostly filling roles in subsistence fisheries (Harper et al. 2013). It has been observed that women harvesting and selling marine products such as mussels and seaweed close to shores

are not considered fishers (Thomas et al. 2021), and in many cases the resource is under male control (Michalena et al. 2020).

On the other hand, social changes evolving from **every day practices** are increasingly evident. Examples are fish farming in Fiji (Michalena et al. 2020) and the tuna fishing in Solomon Islands (Barclay et al. 2020), in which women are increasing their participation at commercial and management levels. This appears to result in a higher level of female agency and empowerment. The increasing presence of professional women in the **governance** of the Pacific marine economic sector, including governmental agencies for the marine and fishing sector, and as retailers of fishery products in cities improves the visibility of the contribution of women to the sector. Still, the support to women in fishing is mostly focused on improving their technical skills, processing, and marketing; efforts are less oriented to support the managerial abilities of women (Michalena et al. 2020). Male leadership continues to dominate the marine and environmental management.

Legal frameworks for property ownership determine **security of access** for women and men. Even though the Kiribati Constitution determines that women have the same rights as men, cultural practices result in women not being represented in decision making for the nearshore, the main area of fishing for Kiribati women; these areas are under the control of the Island Councils, instances in which women have only 3% of the seats (Gotschall 2020). Similarly, the traditional systems of village council in Samoa—mostly led by men—, influences the communal management of fisheries and marine resources (SPC 2018b). Studies in Solomon Islands indicate that even in matrilineal descent systems, customary traditions of decision making over land and marine areas continues to be based on male leadership (SPC 2018a; Lawless et al. 2019). The underrepresentation of women in community decision-making processes and coastal management activities result in the vicious cycle of maintaining women in poverty and increases the gender gap in employment, and worsen issues such as domestic violence (Gotschall 2020).

Security of livelihoods, therefore, is also linked to the differentiated roles of women and men in production and management of resource systems. When analyzing gender roles, traditional division of labour in male and female roles is found; reports tend to identify men occupying roles associated with fishing, heavy physical labour, and positions with authority and high remuneration. Women are more associated with fish and sea products processing, informal cooking, retailing in domestic markets, and business administration. They are poorly represented in positions of high remuneration and authority. Women are highly involved in subsistence catch activities in Melanesia (80%), while only about a quarter of these activities are performed by women in Micronesia and Polynesia (Harper et al. 2013). Women tend to have only basic fishing equipment and mostly lack motorized vessels, which limits their fishing income options (Makhoul 2021; Barclay et al. 2020). Therefore, social relations, in particular those of gender also determine the **degree of autonomy**, thus the capacity to effectively exercise agency that women can have to make their own financial, personal, and managerial decisions. In the Solomon Islands, it was found that women tend to have fewer livelihood alternatives to opt than men; likewise, women

were found having less involvement in decisions related to communal resources and social issues (Lawless et al. 2019).

As livelihoods strategies across the Pacific SIDS are highly linked to agriculture and fishing, **adaptive strategies** to changing conditions due to climate variability, unpredictable weather patterns, and climate extremes are critically important. Food systems and water and energy infrastructure are prone to destruction; increasing urbanization also determines changing livelihoods (ADB 2020). Women, who are more involved in informal employment and low value activities as described above, may face more challenges to secure their livelihoods.

13.3.2 The Need of Gender Disaggregated Data for Monitoring Impact and Progress in Equality

These examples demonstrate the critical need to collect and analyze gender disaggregated data for more realistic analyses. The analytical approach proposed here allows diverse methods for the collection and use of sex-disaggregated data in order to obtain robust empirical evidence for decision making. The use of disaggregated data by gender allows for the important task of assessing impact of policy and projects but also of measuring progress in gender equality commitments. The results of such analyses are useful to inform development investment decisions. It is important to understand whether, for example, water services are reaching more people of different groups, or improvements in management of farming or fishing resources are being equitably distributed; who is able to afford water services and energy, and who is not. These data, when informing programs, contribute to close the persistent gender gaps, to better address water, energy, and food needs, leading to fairer and more resilient communities.

With this purpose, UNESCO WWAP has developed a methodology, indicators, and tools for the collection and analysis of sex-disaggregated data to tackle the information gap on water and gender (Miletto et al. 2019). The 2019 edition of this set of tools includes 105 gender-responsive indicators on ten priority topics aligned with the SDGs and aims to help decision makers adopt data-driven water policies that can transform gender inequalities across development dimensions including governance, climate, migration, agricultural production, education, and health. Through the application of the WWAP Toolkit it was possible to identify that women acting as secretaries of water users organizations in Cundinamarca, Colombia, were the ones making water managerial decisions, despite those organizations being presided by men.⁸ In an extensive study of the participation of women in academia, science, and management of water resources in Argentina, the application of the WWAP methodology and indicators allowed to set discussions about the need to include

⁸ Results report on the research study “Participation of women in water management in rural areas: case study in Cundinamarca, Colombia”, conducted by the Institute of Environment of Florida University with support of UNESCO-IHP and UNESCO WWAP, 2021 (unpublished).

disaggregated water data at the ministerial level and promoted the mainstreaming of a gender perspective into water infrastructure and service programs (Imburgia et al. 2020). Application of the toolkit to water, energy, and food sectors in the Pacific would provide much needed standardized data across the region.

The WWAP Toolkit has gained international recognition in water and development, having been endorsed by a 2018 resolution of the Intergovernmental Council of UNESCO IHP and a renewed resolution in 2021.⁹ The flexibility in adaptation of these tools to different and interlinked development sectors have resulted in the international recognition of the WWAP Toolkit as a useful tool to complement the efforts towards national and global monitoring of gender equality in WASH (JMP, n.d.; Caruso et al. 2021). The application of the Toolkit extends not only to the water sector but to other resources management areas including food production, traditional knowledge and customary rights, and participation in governance, employment and education in water and energy sectors (Miletto et al. 2019). The flexibility and ability to apply the WWAP Toolkit across interlinked sectors makes it highly suited to integrating gendered data and gender-informed decisions into a WEF security approach.

13.4 Conclusions and Final Considerations

Integrative gender analysis is required to make gender inequalities visible in natural resources management studies and to uncover the considerable potential for synergies realized in integrative programs and in gender-responsive policies. The risks of ill-informed studies for those vulnerable to water, food, and energy shortages seem to be clear.

Importantly, securing water, energy, and food require practical inclusion strategies to build resilience. It is vital that these strategies are effectively informed, planned, and applied recognizing and using the knowledge and capacities of all members of the communities. Disaggregated data by gender and other socio-economic dimensions of difference are key inputs for better informed policies and programs. Well-designed studies require disaggregation of gender data and statistics also by specific production sectors (agriculture, fishing, forestry), due to their differential roles and dynamics (Michalena et al. 2020).

Ultimately, the advancement of gender equality in all development areas including the WEF nexus requires to purposely work on enabling strategies to improve the presence of women both in number and in meaningful participation in decision making. A critical step towards this end is to make knowledge accessible to women. Experiences in the region indicate that this can be successfully done through agricultural extension programs (Akter et al. 2020), on-the-job training, and recruiting more women to careers that relate to the technical dimensions of the WEF systems. Furthermore, supporting women leadership at local and community levels in public services, with

⁹ For more information and access to the Toolkit, see <https://en.unesco.org/wwap>.

locally-adapted strategies, as well as supporting a multi-scale effort for increasing the leadership of women in the Pacific region is a concrete and ongoing approach led by the key donor and development agencies working in the region (Australian Aid 2017).

References

- ADB (Asian Development Bank) (2016) Gender statistics: the Pacific and Timor-Leste. Available at www.adb.org
- ADB (Asian Development Bank) (2020) Asian Water Development Outlook 2020. Available at <https://www.adb.org/publications/asian-water-development-outlook-2020>
- ADB (Asian Development Bank) (2021) Pacific Energy Update 2020
- ADB/UN Women (2018) Gender equality and the Sustainable Development Goals in Asia and the Pacific: baseline and pathways for transformative change by 2030
- Akter S, Erskine W, Spyckerelle L, Branco LV, Imron J (2020) The impact of women's access to agricultural extension on cropping practices in Timor-Leste. *Food Secur* 12:449–463. FAO (2016) State of Food Security and Nutrition in Small Island Developing States (SIDS)
- Anderies JM, Janssen MA, Ostrom E (2004) A framework to analyze the robustness of social-ecological systems from an institutional perspective. *Ecol Soc* 9(1):18
- Australian Aid (2017) Women in leadership synthesis report: informing the Pacific women shaping Pacific Development Roadmap 2017–2022
- Barclay K, McClean N, Adhuri D, Sulu R, Fabinyi M (2020) Gender in tuna value chains: case studies from Indonesia and Solomon Islands. *Women in Fisheries Information Bulletin* No. 31. SPC. <https://coastfish.spc.int/en/publications/bulletins/women-in-fisheries/510>
- Broussard NH (2019) What explains gender differences in food insecurity? *Food Policy* 83:180–194. <https://doi.org/10.1016/j.foodpol.2019.01.003>
- CARE (2020) CARE Rapid Gender Analysis COVID-19 Pacific Region
- Caruso BA, Conrad A, Salinger A, Patrick M, Youm A, Sinharoy S (2021) A conceptual framework to inform national and global monitoring of gender equality in WASH. WHO/UNICEF JMP, June 2021
- Charlton KE, Russel J, Gorman E, Hanich Q, Delisle A, Campbell B et al (2016) Fish, food security and health in Pacific Island countries and territories: a systematic literature review. *BMC Public Health* 16(1). <https://doi.org/10.1186/s12889-016-2953-9>
- Das M (2017) The rising tide: a new look at water and gender. World Bank, Washington, DC. <https://openknowledge.worldbank.org/bitstream/handle/10986/27949/W17068.pdf?sequence=4&isAllowed=y>
- DFAT (Department of Foreign Affairs and Trade, Commonwealth of Australia) (2016) Gender equality and women's empowerment strategy. Department of Foreign Affairs and Trade. Available at <https://dfat.gov.au/about-us/publications/Documents/gender-equality-and-womens-empowerment-strategy.pdf>
- Elmhirst R (2015) *Feminist political ecology: the Routledge handbook of political ecology*. Routledge, London
- FAO (Food and Agriculture Organization of the United Nations) (n.d.) Fisheries and aquaculture country profiles. Available at <https://www.fao.org/fishery/countryprofiles/search/en>
- FAO (Food and Agriculture Organization of the United Nations) (2020) The state of the world fisheries and aquaculture 2020. Sustainability in action, Rome. <https://doi.org/10.4060/ca9229en>
- Gotschall I (2020) An overview of I-Kiribati women in fisheries. *SPC Women in Fisheries Information Bulletin*, vol. 33

- Harper S, Zeller D, Hauzer M, Pauly D, Rashid Sumaila U (2013) Women and fisheries: contribution to food security and local economies. *Mar Policy* 39(1):56–63. <https://doi.org/10.1016/j.marpol.2012.10.018>
- Imburgia L (2019) Irrigation and equality: an integrative gender-analytical approach to water governance with examples from Ethiopia and Argentina. *Water Altern* 12(2):571–587
- Imburgia L, López P, Rafaelli S (2020) Methodological approach for applying the UNESCO WWAP water and gender indicators: an example from Argentina. UNESCO, Paris. Available at <https://unesdoc.unesco.org/ark:/48223/pf0000374925>
- Imburgia L, Osbahr H, Cardey S, Momsen J (2021) Irrigation in agriculture: a driver of social differentiation and an empowering livelihood option for rural women. *wH₂O J Gender Water* 8:27–39. <https://repository.upenn.edu/wh2ojournal/vol8/iss1/4>
- JMP (WHO/UNICEF Joint Monitoring Programme for Water Supply, Sanitation, and Hygiene) (n.d.) Available at <https://washdata.org/data>
- Kabeer N (1994) Reversed realities: gender hierarchies in development thought. Verso, UK
- Lawless S, Cohen P, McDougall C, Orrirana G, Siota F, Doyle K (2019) Gender norms and relations: implications for agency in coastal livelihoods. *Marit Stud* 18(3):347–358. <https://doi.org/10.1007/s40152-019-00147-0>
- Lefore N, Weight E, Mukhamedova N (2017) Improving gender equity in irrigation: application of a tool to promote learning and performance in Malawi and Uzbekistan. International Water Management Institute (IWMI). CGIAR Research Program on Water, Land and Ecosystems (WLE). 31p (WLE Research for Development (R4D) Learning Series 6), Colombo, Sri Lanka. <https://doi.org/10.5337/2017.217>
- Mactagart I, Baker S, Bambery L, Iakavai J, Kim MJ, Morrison C et al (2021) Water, women and disability: using mixed-methods to support inclusive wash programme design in Vanuatu. *Lancet Reg Heal West Pac* 8:100109. <https://doi.org/10.1016/j.lanwpc.2021.100109>
- Makhouf N (2021) A summary of key issues from the Cook Islands gender and fisheries assessment. Women in Fisheries Information Bulletin No. 33. SPC. <https://coastfish.spc.int/en/publications/bulletins/women-in-fisheries/518%22>
- MFAT (New Zealand Foreign Affairs & Trade) (2021) Gender action plan 2021–2025. Available at <https://www.mfat.govt.nz/en/media-and-resources/launch-of-the-gender-action-plan-to-guide-new-zealands-development-cooperation/?m=499099#search:Z2VuZGVyIGFjdGlvb1BwbGFu>
- Michalena E, Straza T, Singh P, Morris C, Hills J (2020) Promoting sustainable and inclusive oceans management in Pacific islands through women and science. *Mar Pollut Bull* 150:110711. <https://doi.org/10.1016/j.marpolbul.2019.110711>
- McGinnis MD, Ostrom E (2014) Social-ecological system framework: initial changes and continuing challenges. *Ecol Soc* 19(2):30
- Miletto M, Pangare V, Thuy L (2019) Tool 1—Gender-responsive indicators for water assessment, monitoring and reporting. UNESCO WWAP Toolkit on Sex-disaggregated Water Data. UNESCO, Paris. <http://www.unesco.org/new/en/natural-sciences/environment/water/wwap/water-and-gender/methodology-indicators-and-toolkit>
- Rocheleau D, Thomas-Slayter B, Wangari E (1996) Gender and environment. *Feminist political ecology: global issues and local experiences*. Routledge, UK, pp 3–23
- SPC (Pacific Community) (2018a) Gender analysis of the fisheries sector—Solomon Islands. Available at https://cgiair-my.sharepoint.com/personal/p_cohen_cgair_org/Documents/Cohenetal/Bos_oCohenetal2018a_Gender_analysis_in_fisheries_SI.pdf
- SPC (Pacific Community) (2018b) Gender and fisheries in Samoa—summary of key issues
- Thomas A, Mangubhai S, Fox M, Meo S, Miller K, Naisilisili W et al (2021) Why they must be counted: significant contributions of Fijian women fishers to food security and livelihoods. *Ocean Coast Manag* 205. <https://doi.org/10.1016/j.ocecoaman.2021.105571>
- Thompson-Hall M, Carr ER, Pascual U (2016) Enhancing and expanding intersectional research for climate change adaptation in agrarian settings. *Ambio* 45(s3):373–382. <https://doi.org/10.1007/s13280-016-0827-0>

- UN (United Nations) (2010) 64/292 The human right to water and sanitation. Resolution adopted by the General Assembly on 28 July 2010. Available at <https://documents-dds-ny.un.org/doc/UNDOC/GEN/N09/479/35/PDF/N0947935.pdf?OpenElement>
- UN (United Nations) (2014) SIDS Accelerated Modalities of Action (SAMOA) Pathway, Resolution adopted by the General Assembly on 14 November 2014. General Assembly document A/RES/69/15. Available at http://unohrlls.org/custom-content/uploads/2017/09/SIDS-In-Numbers_Updated-Climate-Change-Edition-2017.pdf%0Ahttp://unohrlls.org%0Ahttp://scholar.google.com/scholar?hl=en&btnG=Search&q=intitle:Report+on+the+global+AIDS+epidemic#1
- UN (United Nations) (2016) Report of the Special Rapporteur on the human right to safe drinking water and sanitation, Human Rights Council Thirty-third session. <https://doi.org/10.1017/S0020818300013345>
- UN (United Nations) (2019) Improvement of the situation of women and girls in rural areas. Report of the Secretary-General for the seventy-fourth session of the General Assembly. General Assembly document A/74/224
- UN Women (United Nations Entity for Gender Equality and the Empowerment of Women) (2014) Annual Report 2014—Looking to a brighter future: progress for women and girls in Asia and the Pacific in 2014. Available at <https://asiapacific.unwomen.org/en/digital-library/publications/2019/03/un-women-asia-and-the-pacific-annual-report>
- UN Women (United Nations Entity for Gender Equality and the Empowerment of Women) (2017) Gender and energy in the Pacific. Available at http://www.un-expo.org/wp-content/uploads/2017/05/SIDS_Brief_7_Gender_and_Energy_in_the_Pacific.pdf
- UNESCAP (United Nations Economic and Social Commission for Asia and the Pacific) (2021) Asia and the Pacific SDG progress report 2021. <https://doi.org/10.18356/d74fb286-en>
- UNESCO WWAP (World Water Assessment Programme) (2021) Taking stock of progress towards gender equality in the water domain: where do we stand 25 years after the Beijing Declaration? UNESCO, Paris. Available at <http://www.unesco.org/open-access/>
- USAID (United States Agency for International Development) (n.d.) Gender equality and female empowerment. Available at <https://www.usaid.gov/asia-regional/gender-equality-and-female-empowerment>
- WFP (United Nations World Food Programme) and SPC (Pacific Community) (2018) Food security in vulnerable islands: a regional food security atlas of the Pacific. World Food Programme, Fiji. Available at <https://www.wfp.org/publications/food-security-vulnerable-islands-regional-food-security-atlas-pacific-may-2018>
- World Bank (2012) Towards gender equality in East Asia and the Pacific: a companion to the World Development Report. World Bank, Washington, DC. <https://doi.org/10.1596/978-0-8213-9623-0>. <https://openknowledge.worldbank.org/handle/10986/12598>
- World Bank Group (n.d.) World Bank Open Data. Available at <https://data.worldbank.org/indicator>
- World Bank Group (2019) Women in water utilities: breaking barriers. World Bank, Washington, DC. <https://elibrary.worldbank.org/doi/abs/10.1596/32319>

The opinions expressed in this chapter are those of the author(s) and do not necessarily reflect the views of the UNESCO: United Nations Educational, Scientific and Cultural Organization, its Board of Directors, or the countries they represent.

Open Access This chapter is licensed under the terms of the Creative Commons Attribution-ShareAlike 3.0 IGO License (<https://creativecommons.org/licenses/by-sa/3.0/igo/>), which permits use, sharing, adaptation, distribution, and reproduction in any medium or format, as long as you give appropriate credit to the UNESCO: United Nations Educational, Scientific and Cultural Organization, provide a link to the Creative Commons licence and indicate if changes were made. If you remix, transform, or build upon this book or a part thereof, you must distribute your contributions under the same licence as the original.

The use of the UNESCO: United Nations Educational, Scientific and Cultural Organization's name, and the use of the UNESCO: United Nations Educational, Scientific and Cultural Organization's logo, shall be subject to a separate written licence agreement between the UNESCO: United Nations Educational, Scientific and Cultural Organization and the user and is not authorized as part of this CC-IGO licence. Note that the link provided above includes additional terms and conditions of the licence.

The images or other third party material in this chapter are included in the chapter's Creative Commons licence, unless indicated otherwise in a credit line to the material. If material is not included in the chapter's Creative Commons licence and your intended use is not permitted by statutory regulation or exceeds the permitted use, you will need to obtain permission directly from the copyright holder.



Chapter 14

Poverty in the Pacific: Trends, Progress, and Challenges in the Early Twenty-First Century



Michael Burnside, Sarah Cook, and Akhil Suresh Nair

Abstract Poverty persists in the Pacific but is characterized less by standard international measures of absolute or chronic deprivation than by vulnerability and volatility. Communities in the Pacific are generally small and remote, creating challenges for the provision of basic goods and services. Their economies rely heavily on external economic relations—trade, employment, and remittances and tourism and aid—including for essential commodities such as food and energy. Among sources of vulnerability, environmental degradation, loss of biodiversity, and climate change impacts expose nations to shocks, often generating disasters which undermine the livelihoods of households. Over the past three decades progress has been made in reducing poverty and improving well-being; however, significant problems persist related to health and nutrition, access to services, employment, and livelihoods, and most countries have been slow to expand social protection systems to protect the most vulnerable. The Sustainable Development agenda offers the possibility of alternative development strategies that could favour ocean economies. However, this will require significant development assistance and investment from the international community at a time when aid budgets are coming under pressure from COVID-19. The global pandemic, with its travel, trade, and tourism restrictions, highlights the region’s susceptibility to external shocks and is reversing recent gains in poverty reduction.

M. Burnside (✉)

Sustainable Development Reform Hub, University of New South Wales, Sydney, NSW 2052, Australia

e-mail: michael.burnside@unsw.edu.au

M. Burnside · S. Cook

Institute for Global Development, University of New South Wales, Sydney, NSW 2052, Australia

S. Cook

Southern Center for Inequality Studies, University of the Witwatersrand, Johannesburg, South Africa

A. S. Nair

Faculty of Arts, Design and Architecture, University of New South Wales, Sydney, NSW 2052, Australia

© UNESCO 2024

A. Dansie et al. (eds.), *The Water, Energy, and Food Security Nexus in Asia and the Pacific*, Water Security in a New World, https://doi.org/10.1007/978-3-031-25463-5_14

297

Keywords Multi-dimensional poverty · Data paucity · Vulnerability · Economic volatility · Livelihoods · Remittances · Social protection · Sustainable development · Environmental related stress · Climate related stress

14.1 Introduction

Poverty, broadly defined as various forms of deprivation associated with meeting basic needs, accessing essential services and economic opportunities, and participation in family and community life, is closely associated across the Pacific with insecurity of access to water, food, and energy. Given this definition and focus, we exclude the high-income countries of Australia and New Zealand from our analysis, although we recognize forms of poverty do exist there, particularly among Indigenous people.

Distinct histories, including experiences of colonisation, among Pacific Island Countries and Territories (PICTs) have shaped varied development trajectories, but in most cases the small size and remote ocean location of Pacific nations means that standard development options are limited. The region is vulnerable to environmental degradation including pollution of oceans, biodiversity loss, and natural hazards, many now intensified by a changing climate. Some Pacific states face the challenge of having few tradeable commodities or industries, while others are rich in resources (including fisheries and mineral resources) but have limited capacities to develop these. Most are thus heavily dependent economically on overseas employment and remittances and on tourism, while also relying on imports which incur high costs given the geographical distance. This external dependence makes PICTs particularly vulnerable to shifts in other countries' economic policies and to broader economic shocks such as those accompanying the COVID-19 pandemic and its on-going consequences (World Bank 2020).

In this chapter, drawing on secondary sources and available data, we describe key characteristics and trends related to poverty and its reduction in the Pacific and discuss the structural constraints to sustained poverty reduction across an environmentally- and climate-stressed, disaster-prone ocean region. Noting the significant gaps and limitations of comparative data for many countries in the region, we present key indicators of income and multidimensional poverty, population health, and well-being where available. The chapter also reflects on how international debates around poverty, and approaches to its reduction, have evolved particularly since the 1990s, and their relevance to the Pacific context. The early literature suggests that the diverse experiences of poverty across the Pacific did not fit easily into mainstream poverty debates. Rather, participatory research projects referred to notions of 'hardship' in meeting basic needs among a largely subsistence agricultural population, generally managed through traditional informal kinship or community support mechanisms (Abbot and Pollard 2004; UNDP 2014; Ratuva 2005). Such understandings and indeed the experience of poverty in the Pacific appear to have shifted since the latter years of the twentieth century, driven by forces including monetization of the

economy and deeper global integration, increased population pressure on limited resources, and an associated rise in inequality. While indicators of human development improved overall during the era of the Millennium Development Goals (MDGs) from 2000 to 2015, progress towards meeting the Goals and targets was generally mixed (PIF 2015), and subsequently appears to have slowed as nations are challenged by geography and remain vulnerable to economic, climatic, and other environmental shocks. For the most part, PICTs have been relatively slow to expand systems of social protection that can mitigate individual or household insecurity and reduce severe poverty.

At the same time, PICTs along with other Small Island Developing States (SIDS) played an important role in the negotiations for a post-2015 development agenda. Recognizing that their future depends on the protection and sustainable use of natural resources, particularly in relation to oceans, they ensured such concerns are better reflected within what ultimately became the 2030 Agenda for Sustainable Development, comprising the Sustainable Development Goals (SDGs) and agreements on climate change and development finance. For the first time a global development agenda explicitly addresses the unique environment of ocean economies, through Goal 14 which commits to ‘conserve and sustainably use oceans, seas and marine resources for sustainable development’, along with the particular climate-related risks they face and the responsibilities of the global community in mitigating and addressing these risks (Goal 13). Various means to strengthen implementation through partnerships are also explicitly identified through Goal 17, including to finance, develop capabilities, and transfer technologies. This more holistic development agenda potentially marks a significant step forward in addressing the intersecting social, economic, and environmental challenges that drive poverty and insecurity in the Pacific region. In particular, the critical nexus around water, energy, and food addressed in this volume and elaborated further in Chap. 16, will be central to any sustainable pathway to realizing Goal 1—‘the elimination of poverty in all its forms’.

14.2 People and Poverty in the Pacific

Cultural definitions of ‘poverty’ or deprivation vary significantly and may be associated, for example, with the nature of community and support networks, livelihood systems, or access to land and water resources for food and fuel. Even when indicators of poverty defined for international comparison (or related concepts such as human development) show improvements—as they have done in most of the Pacific since the 1990s, these indicators often hide critical dimensions of well-being related to community, culture, and place. These may be disrupted by forces such as population growth, globalization, commercialization, or unequal patterns of economic growth, as well as by natural hazards, and at times even by development projects designed to improve livelihoods and reduce poverty.

Early literature on poverty in the Pacific tended to focus on the nature of community and traditional kinship or other informal systems that provided a subsistence level of security to largely rural populations. In these accounts, notions of ‘hardship’ rather than poverty described the situation of people who might be temporarily affected by shocks but have community mechanisms for coping. As *The State of Human Development in the Pacific 2014* report noted: “Those living on outer islands [or Papua New Guinean highlands] may be financially excluded from the market/monetary economy but be adequately covered by traditional social protection systems. They are also likely to have support from the traditional systems of production and distribution, which grants them access to subsistence and non-monetary resources” (UNDP 2014). While the expansion of markets and the cash economy, often associated with ‘development’, can of course create, and expand opportunities and choices, this process can also be highly unequal and exclusionary, and under some circumstances has led to the breakdown of informal, community, or traditional support systems. In this process, the nature and experience of poverty may change.

Economic growth during the recent decades of hyper-globalization, together with severe climate and environmental shocks, has thus contributed to the emergence of different forms of poverty and exclusion across the region—forms that resonate more closely with the concepts and measures of the international community. Incorporation into a globalized and financialized economic system, including through aid flows and remittances, has led to a rapid monetization of economies and greater dependence on cash for meeting basic needs such as food, energy, healthcare, and education. This heightened dependence on cash, alongside population growth and greater pressure on land, has driven processes of migration, rapid urbanization (albeit from a low base), and in turn the rise of informal, precarious, or risky settlements and employment. International (particularly regional) migration has also increased, with reliance on remittances from overseas workers becoming the mainstay of some small island economies (Box 14.1) (AUSTRAC 2017). Traditional mechanisms of reciprocity that previously provided social support in relatively equal societies have been weakened (Connell 2017).

Box 14.1 Migration, overseas employment, and remittances

The migration of youth and adults overseas, especially from some of the more developed Polynesian nations, is driven by lack of jobs and the pursuit of education or opportunities, but often leaves behind the elderly in rural areas with the additional responsibility of taking care of young children (UNDP 2014; Connell 2017). Polynesian PICTs are now among the most dependent countries on personal remittances in the world. Countries like Tonga (40% of GDP from remittances) and Samoa (18%) are particularly exposed to international economic volatility as remittance flows to the Pacific are linked to the strength of economies and labour schemes of host countries, and the ability to travel.

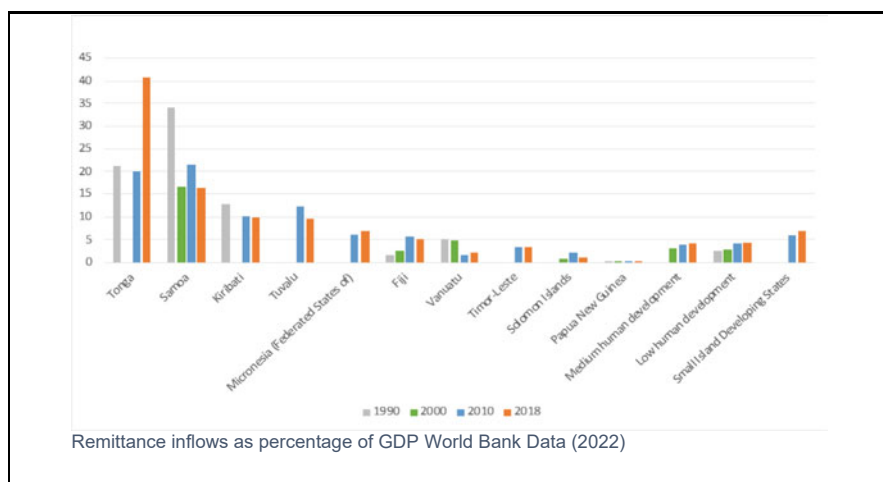











14.2.1 Population Change and Patterns of Poverty

Population growth, distribution, and mobility play a key role in shaping the nature and patterns of poverty in the Pacific. Many PICTs are sparsely populated ocean states with vast distances between communities on remote islands. While small, they vary considerably in population, ranging from a state such as Tuvalu with around 12,000 people to Papua New Guinea (PNG) which is home to around 9 million people, scattered in hundreds of often remote communities, from coastal to mountainous rainforest areas, with varying water, food, and energy resources and deficits.

The population has grown rapidly in the Pacific since the 1960s. While population growth is not necessarily a driver of poverty, pressure on resources and land, in contexts of limited employment and income opportunities, may exacerbate poverty and insecurity. As Table 14.1 illustrates, population growth has been rapid, though rates have slowed in some countries since around 1990.

Rapid population growth in largely rural subsistence economies creates pressures for migration to urban areas. Overall, across the Pacific, the share of population that is urban remains low, largely below 30% (exceptions being Fiji, Kiribati, and Tuvalu at about 60% of the population) (Table 14.2). Deprivation takes very different forms from that experienced by, for example, remote rural populations. Rapid urbanization with limited employment opportunities has given rise to informal settlements with poor infrastructure or services, often located in coastal areas and vulnerable to natural hazards; it has also taken people away from their traditional kinship or community support networks (UNDP 2014).

Table 14.1 Total estimated population through from 1960 of select PICTs¹

	1960	1970	1980	1990	2000	2010	2019	Trend	Annual average growth	
									1961-1989	1990-2019
Fiji	393,481	520,562	635,307	728,573	811,006	859,818	889,953		2.1%	0.7%
Kiribati	41,202	51,151	59,301	72,400	84,396	102,927	117,606		1.9%	1.7%
FSM	44,514	61,417	72,930	96,301	107,402	102,911	113,815		2.6%	0.6%
PNG	2,255,859	2,783,121	3,571,205	4,615,839	5,847,586	7,310,507	8,776,109		2.4%	2.2%
Samoa	108,629	143,149	155,525	162,803	174,454	185,949	197,097		1.4%	0.7%
Solomon Islands	117,849	160,250	230,546	311,866	412,660	527,861	669,823		3.3%	2.6%
Timor-Leste	474,532	571,565	599,905	737,814	884,366	1,093,523	1,293,119		1.4%	2.0%
Tonga	61,577	84,351	92,971	95,069	97,973	103,986	104,494		1.5%	0.3%
Tuvalu	5,323	5,735	7,637	8,913	9,394	10,530	11,646		1.7%	0.9%
Vanuatu	63,689	85,377	115,597	146,573	184,972	236,211	299,882		2.8%	2.5%

Source World Bank Data (2022)

Table 14.2 Proportion of Pacific peoples living in rural or urban areas

Pacific Island countries	Rural/urban population (% of total)
Papua New Guinea	86.8/13.2
Samoa	81.9/18.1
Federated States of Micronesia (FSM)	77.2/22.8
Tonga	76.9/23.1
Solomon Islands	75.8/24.2
Vanuatu	74.6/25.4
Timor-Leste	69.1/30.9
Kiribati	45.2/54.8
Fiji	43.3/56.8
Tuvalu	36.8/63.2

Source World Bank Data (2022; data from 2019)

Patterns of poverty vary among PICTS, reflected also in variation in levels of income and human development (Table 14.3). According to the UN, three PICTS (Kiribati, Tuvalu, and the Solomon Islands) and Timor-Leste fall into its 'least developed countries' group, a classification which combines indicators of income, human

¹ The PICTs selected for analysis throughout this chapter are dependent on data availability. The authors also tried to maintain selection continuity where possible.

assets, and economic and environmental vulnerability (UNDESA 2021). Most countries in the Pacific are classified as middle-income,² but also have relatively high levels of income inequality as measured by the Gini Coefficient. Fiji (a country of high urbanization), and Samoa and Tonga (low urbanization) are in the upper middle-income category and also have a high level of human development as measured by the UN's Human Development Index,³ whereas most others, including PNG and until recently Solomon Islands, fall into the category of low human development.

14.2.2 Income or Monetary Poverty

The most recent Pacific-wide data for the share of population living below the international extreme poverty line of \$1.90 per person per day (using 2011 purchasing power parity) comes from the SDG baseline report (UNESCAP 2017) and World Bank Data (2022), although much of the data pre-dates 2010. UNESCAP has recently calculated new estimates (Fig. 14.1). The Melanesian countries of Solomon Islands and Vanuatu have poverty rates of 18.7 and 10.8% respectively; while over 30% of people in Timor-Leste lived below this poverty line—higher than the rate in any other country in Southeast Asia (where the average rate was 16.1%). PNG has a comparable rate, and importantly, has a much larger population. While those living below the extreme poverty threshold in most other PICTs is low, a significant number of people live on less than \$5.50 per day PPP. This income group is unlikely to have significant savings, assets, or insurance, leaving them vulnerable to shocks (whether manmade or natural hazards, with the COVID-19 pandemic and the Tongan volcanic eruption and associated tsunami as the latest examples) and thus at risk of being pushed deeper into poverty.

14.2.3 Energy Poverty

Income or monetary poverty measures often conceal the multi-dimensional nature of poverty including access to essential goods and services. 'Energy poverty' is a critical element of poverty for many Pacific Island peoples. Limited sources of energy and geographical challenges in providing affordable, clean, and reliable energy to dispersed populations contribute to widespread energy poverty, including PNG despite it being a petroleum exporting nation. The proportion of people without electricity in PNG (59%), Solomon Islands (66.7%), and Vanuatu (61.9%) is high

² The World Bank assigns the world's economies to four income groups based on Gross National Income per capita in current USD: low (<1,036), lower-middle (1,036–4,045), upper-middle (4,046–12,535), and high-income (>12,535) countries (Serajuddin and Hamadeh 2020).

³ The UNDP's Human Development Index is a measure of development focused on people's well-being, and their opportunities and choices (UNDP 2020).

Table 14.3 Overview of key development indicators

Pacific Island Countries	GNP per capita (current int'l \$, PPP) ⁴	Income status (2020)	Inequality (Gini index) ⁵	Human Development Index (0.0–1.0) and category (High/Med/Low) (2018)
Fiji	13,260 (2019)	Upper middle	0.37 (2013)	0.724 High
Tonga	6,510 (2018)	Upper middle	0.38 (2015)	0.717 High
Samoa	6,490 (2019)	Upper middle	0.39 (2013)	0.707 High
Tuvalu	6,170 (2019)	Upper middle	0.39 (2010)	N/A
Timor-Leste	4,730 (2019)	Lower Middle	0.29 (2014)	0.626 Medium
Kiribati	4,650 (2019)	Lower middle	0.37 (2006)	0.623 Medium
PNG	4,470 (2019)	Lower middle	0.42 (2009)	0.543 Low
FSM	3,640 (2018)	Lower middle	0.40 (2013)	0.61 Medium
Vanuatu	3,310 (2019)	Lower middle	0.38 (2010)	0.597 Medium
Solomon Islands	2,350 (2019)	Lower middle	0.37 (2013)	0.557 Medium

Source Human Development Index (2020)

⁴ Economic data is converted into a common currency (often 2011 international dollars) for comparison between countries using Purchasing Power Parities (PPPs). PPPs attempt to equalise the purchasing power of different currencies to eliminate price level differences between countries (UNDP 2021).

⁵ Gini index measures the extent to which the distribution of income (or, in some cases, consumption expenditure) among individuals or households within an economy deviates from a perfectly equal distribution: a score between 0 and 1 where closer to 1 implies higher inequality (World Bank Data 2022).

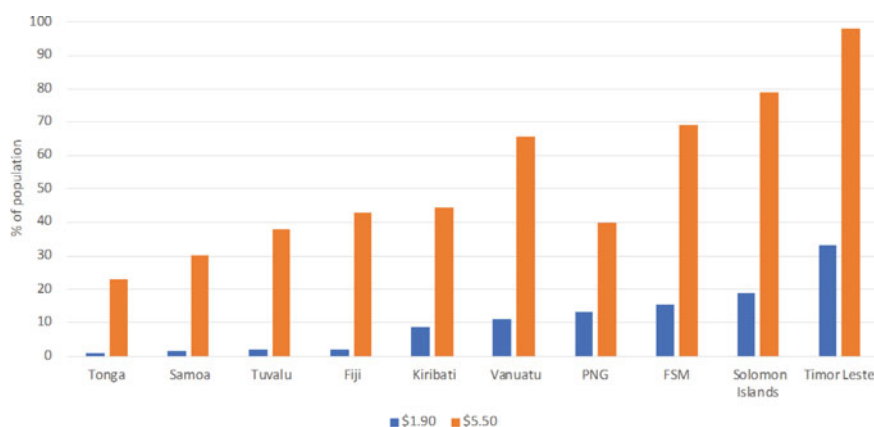

Fig. 14.1 Estimated share of the population living below the \$1.90 and 5.50 per day poverty thresholds in 2019 (UNESCAP 2021)⁶

by global standards, as is the proportion of people without improved cooking fuels and technologies (with implications also for health and nutrition) across the region (Table 14.4). These numbers are comparable to or below the low-income country average (despite higher income levels in much of the Pacific). Many communities are dependent on expensive imported fuel (petroleum products) for local and household level power (Dornan 2014), exposing them to high shipping costs, as well as international oil price fluctuations (UNDP 2015). Chapters 3 and 12 provide further detail on drivers of Pacific energy poverty. High costs or inadequate supply of energy and fuels have wide-reaching implications: from transport and access to markets or services (health and education), to cooking and hygiene, in turn affecting health and nutrition.

14.2.4 Human Development

The Human Development Index (HDI) provides a multi-dimensional ranking of wellbeing within nations based on indicators including health, education, and dimensions of equality including gender (see Chap. 13: Gender, Equity, and Inclusion in the Pacific). The HDI has shown steady improvement across the Pacific, with Fiji, Samoa, and Tonga exceeding the developing country average, while most other PICTs are below this level (Fig. 14.2).

⁶ The \$1.90 per day poverty threshold (PPP 2011) describes absolute poverty, whereas the \$5.50 per day threshold describes poverty rates relative to the upper-middle income country average.

Table 14.4 Access to energy in the Pacific

	Access to electricity (% of pop.) (2018)	Access to clean fuels and technologies for cooking (% of pop.) (2016)
Fiji	99.6	39.6
Tonga	98.9	59.2
Tuvalu	100.0	50.4
Upper middle-income country average	99.4	72.0
Samoa	100.0	32.3
Timor-Leste	85.6	6.9
Kiribati	100.0	5.5
Papua New Guinea	59.0	13.4
FSM	82.1	12.0
Vanuatu	61.9	12.6
Solomon Islands	66.7	8.5
Lower middle-income country average	86.3	40.8
Low-income country average	41.9	14.0

Source World Bank Data (2022)

14.2.5 Education

Education is widely recognized as a critical factor for long-term poverty reduction and for breaking inter-generational cycles of poverty. Extracting the education component of the HDI, we see a similar pattern to the index overall. Indicators of schooling have improved across the region, with Fiji, Samoa, and Tonga ranking high on the education component of HDI, whereas other PICTs are making slower progress (Human Development Index 2020) (Fig. 14.3).

14.2.6 Health, Food, and Nutrition

Ill-health is a key correlate of poverty and may be both a cause, as ill-health reduces productivity and the ability to work, or a consequence, due to poor diets or lack of access to health care. Life expectancy at birth and Infant Mortality Rates proxy for the general well-being of populations: in only two Pacific countries (Samoa and Solomon Islands) are people on average expected to live longer than the middle-income country average (Fig. 14.4). In four PICTs life expectancy is currently at or below even the lower middle-income country average.

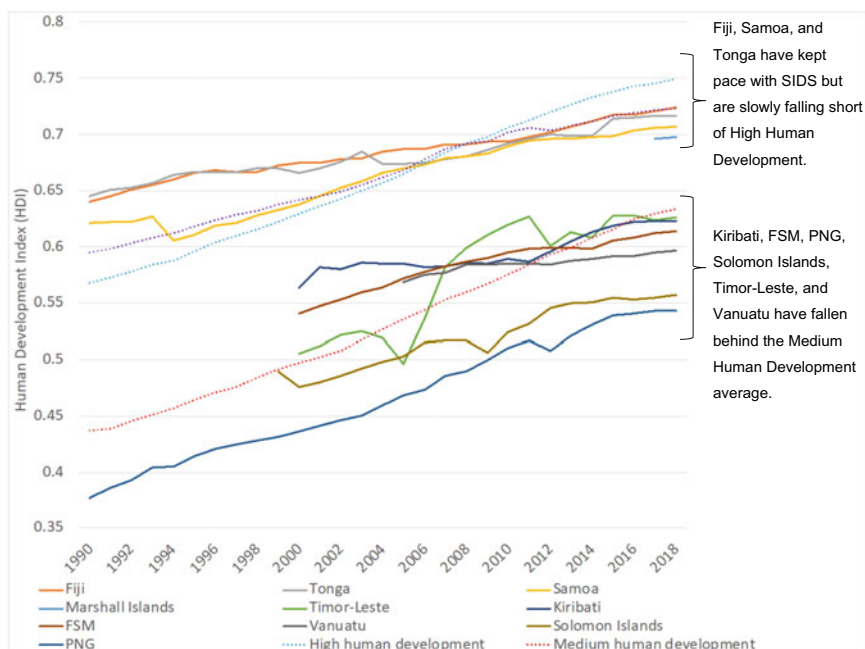

Fig. 14.2 HDI in the Pacific from 1990 to 2018 (Source Human Development Index 2020)

For Infant Mortality, most PICTs have seen significant progress in reducing the national rate and perform better than global and middle-income country averages (Fig. 14.5). This may in part be explained by improvements in health service delivery via community or village health workers (WHO 2018); however, PNG, Kiribati, and Timor-Leste still have rates of nearly 40 per 1,000 live births which is comparable to the lower-middle income average (36.6) and higher than the global average (28.2), and far above high-income countries such as Australia (3.6).

Child stunting (low height for age) and wasting (low weight for height) are key measures of poor nutrition and child development, with serious consequences for the physical and cognitive development of children that may affect their learning and life chances and lessen their productivity in local economies for the duration of their lives (Samson 2016). Stunting remains a serious issue in many PICTs: approximately half of children under age 5 in PNG (49.4%) and Timor-Leste (51.7%), and one-third of children under age 5 in the Solomon Islands (31.7%) and Vanuatu (28.0%) are stunted (Fig. 14.6). The incidence of wasting (a measure of more acute malnutrition) also remains a concern, demanding significant attention to food, nutrition, clean water, and sanitation if outcomes are to improve to ensure all children are adequately nourished and can reach their potential. Simultaneously the share of children who are overweight has risen.

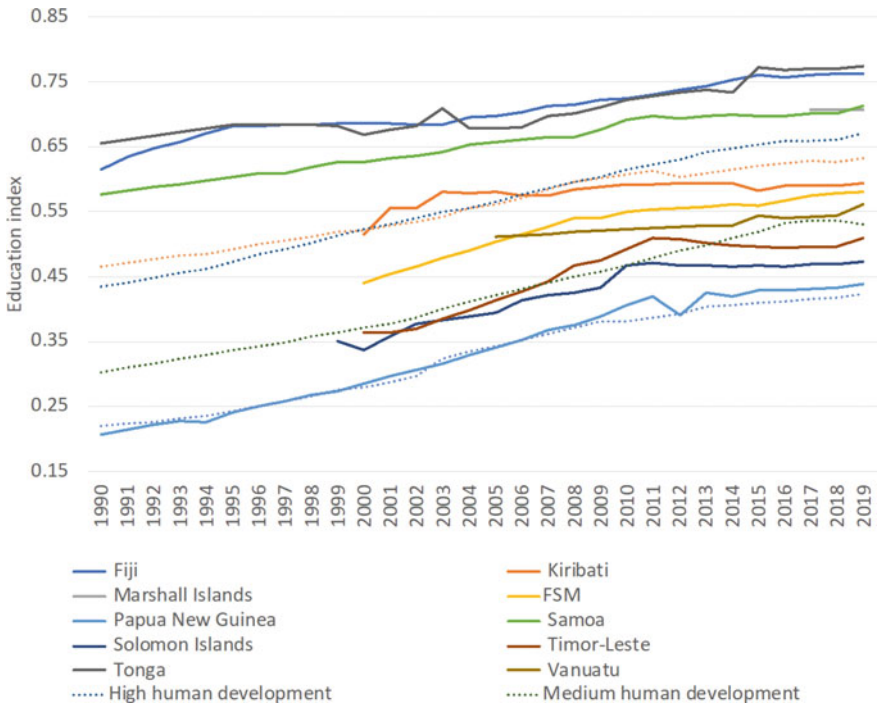

Fig. 14.3 Education index extracted from the HDI is achieved by combining (1) expected years of schooling and (2) mean years of schooling (Human Development Index 2020)

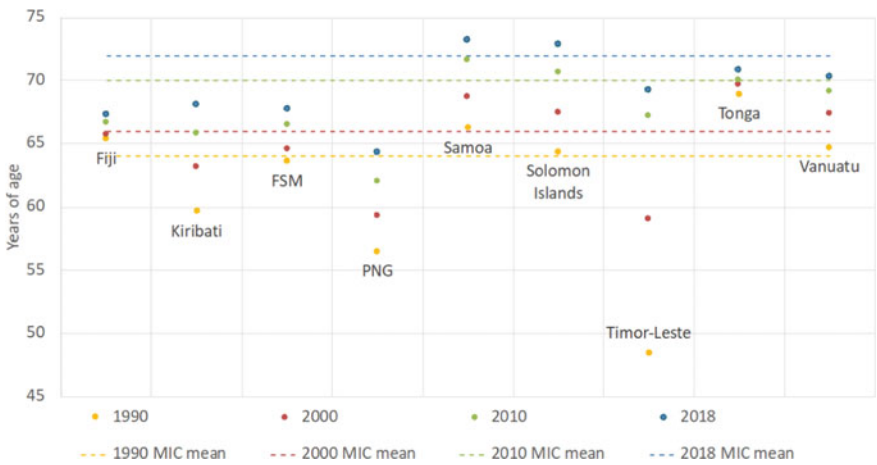

Fig. 14.4 Life expectancy at birth (years), both sexes in 1990, 2000, 2010 and 2018. Middle Income Country (MICs) means are provided (Source World Bank Data 2022)

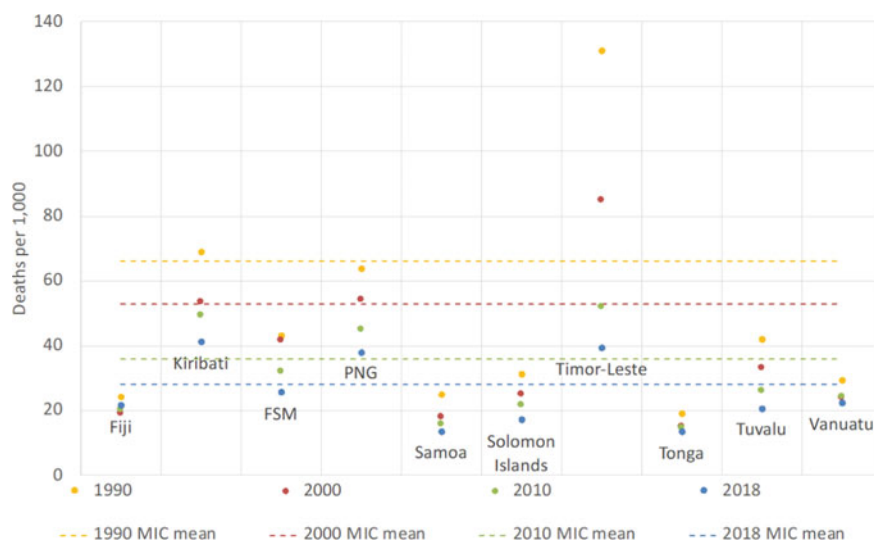

Fig. 14.5 Infant mortality rate is the number of infants dying before reaching one year of age per 1,000 live births in a given year. Middle Income Country (MICs) means are provided (*Source* World Bank Data 2022)

An increase in childhood obesity is of concern given that the Pacific has among the highest levels of adult overweight and obesity⁷ in the world, conditions which are associated with a range of non-communicable diseases (NCDs) that in turn affect productivity and incomes as well as placing severe financial and social pressures on households and states (World Bank 2014). PICTs now account for the top ten states for obesity prevalence in adults worldwide (Fig. 14.7). A range of factors has changed diets in Pacific countries, including the move away from subsistence agriculture (linked in part to population pressure on land and urbanization) and closer integration with the global economy enabling an increased dependence on ‘cheap’ imported foods—away from traditional staples and towards imported energy-dense, processed foods that are suitable for long-distance transport but often have high fat, sugar, and salt content (see Chap. 4: The State of Food and Nutrition Security in the Pacific for further detail). Low-income households are more likely to depend on such food sources, making them also vulnerable to price rises associated with the cost of imports (such as those associated with global marine fuel markets). These dietary changes, alongside a tendency to less physically active lifestyles has driven the rapid rise in overweight and obesity, and in turn the rise in NCDs, including cardiovascular disease and diabetes, which account for the highest mortality burden in the region (Nanditha et al. 2016).

⁷ Overweight and obesity, as measured by Body Mass Index (25–29.9 and >30 respectively), are now leading forms of malnutrition with severe health consequences particularly in relation to non-communicable diseases (WHO 2021).

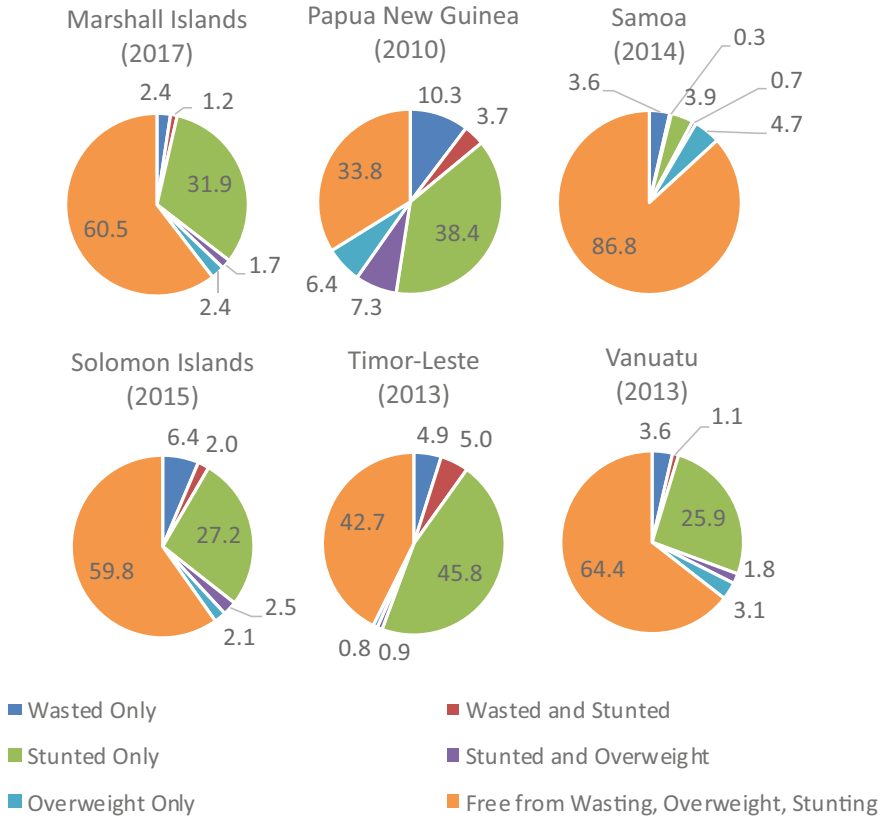

Fig. 14.6 Overlapping malnutrition estimates in children (% of total) (Source UNICEF Data 2020)

The high burden of NCDs is a major challenge for health systems. According to the World Bank, the cost of treating obesity and associated NCDs exceeds 50% of the health budget for many PICTs and is projected to rise rapidly in coming years (World Bank 2012, 2016). At the same time, communicable diseases (often associated with poverty) remain a major challenge, with infectious and waterborne diseases still the leading cause of preventable death amongst children under five: poor infrastructure, unsafe water supplies, and unfit sanitation systems, coupled with poor hygiene practices, remain barriers to reducing child mortality (see Chap. 2: State of Freshwater Resources in the Pacific for further detail) (UNDP 2014). A sustainable reduction in poverty in many of the PICTS will thus require attention to key health indicators and their food, water, and energy-related drivers.

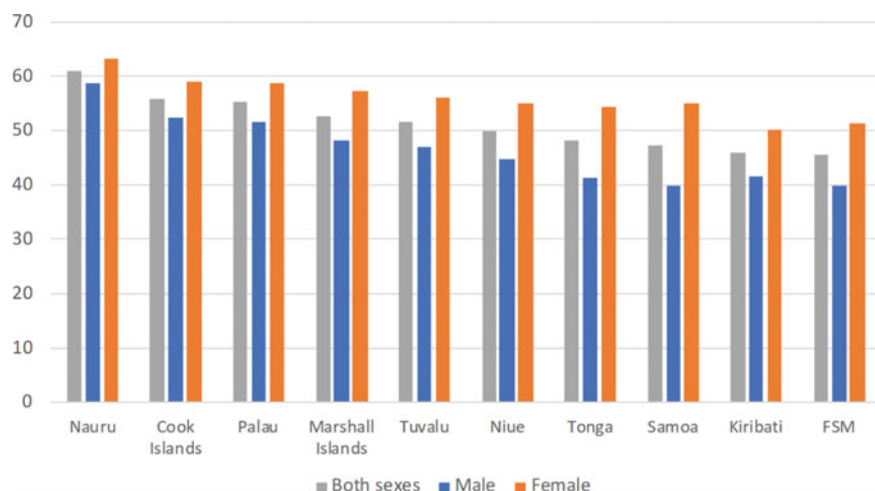













Fig. 14.7 Prevalence of adult (18+) obesity rates (% of population) among counties and territories ranked in the top ten, all of which are PICTs (2016 data) (Source WHO Data 2020)

14.3 Challenging Geographies and Volatility—Accounting for and Responding to Patterns and Trends of Poverty in the Pacific

The Pacific region faces a variety of geographical and structural conditions that have significant consequences for peoples' wellbeing and livelihoods, including their secure and reliable access to water, energy, and food, and for patterns of poverty and deprivation. The unique ocean and island geography of many tropical Pacific states, despite many advantages, also presents development challenges. The small size of most nations, with often remote or isolated communities dispersed over great distances raises costs and creates constraints for reliably and affordably transporting goods, delivering services, or accessing markets (UNDP 2014; Ware 2005). A narrow range of exportable primary commodities and few mineral resources (with the exception of the Melanesian states) limits options for industrialization. While its natural wealth lends itself to tourism, this along with income sources from overseas remittances and a heavy reliance on aid, means that these economies are highly externally dependent. Increasing evidence points to the region being increasingly impacted by ocean biodiversity loss, environmental pollution, and climate hazards (Wairiu 2017). As a result, economic growth is, as Rajah et al. (2019) describe it, 'more volatile than fast' (Table 14.5). Exposure to such volatility—whether driven by economic, manmade, natural, or environmental forces—is a feature of Pacific economies and a reality in the lives of its peoples.

Table 14.5 The economic growth of PICTs tends to fluctuate year-to-year such that the standard deviation of annual growth exceeds the average over the past 20 years

Country	Average annual GDP growth (%) (2000-2020)	Annual standard deviation (2000-2020)	Year-to-year GDP change (2000-2020)
Fiji	1.29	4.74	
Kiribati	1.63	3.32	
Marshall Islands	1.91	3.75	
FSM	0.49	2.46	
Palau	0.53	4.66	
Papua New Guinea	3.72	4.15	
Samoa	2.84	3.30	
Solomon Islands	2.42	5.63	
Tonga	1.54	2.81	
Tuvalu	2.07	5.57	
Vanuatu	2.50	3.56	

Source World Bank Data (2022)

14.3.1 Natural Hazards and Disasters

As described in Chap. 5, the location and unique island geography of many tropical Pacific states exposes them to natural hydrometeorological volatility, also increasingly associated with climate change. Pacific communities are already experiencing land and marine temperature extremes that place a burden on energy availability for cooling and stimulate higher water demand for domestic, agricultural, and industrial uses (CSIRO et al. 2015; Australian Bureau of Meteorology and CSIRO 2011). Climate projections also indicate an increase in both the number and intensity of extreme rain events, even in areas where average rainfall may decrease, possibly leading to more instances of flooding (IPCC 2021; CSIRO et al. 2015; Australian Bureau of Meteorology and CSIRO 2011). Sea levels are modelled to rise, affecting agricultural production, food, and potable water security, especially on low lying atolls (IPCC 2021; Australian Bureau of Meteorology and CSIRO 2011; Barnett 2011). Acidification of oceans will also likely continue to negatively impact reef biodiversity, reef tourism, and may cause fisheries to decline by as much as 20% directly affecting seafood supply, livelihoods, and the wellbeing of coastal communities across the Pacific (Dutra et al. 2018; CSIRO et al. 2015; Barnett 2011).

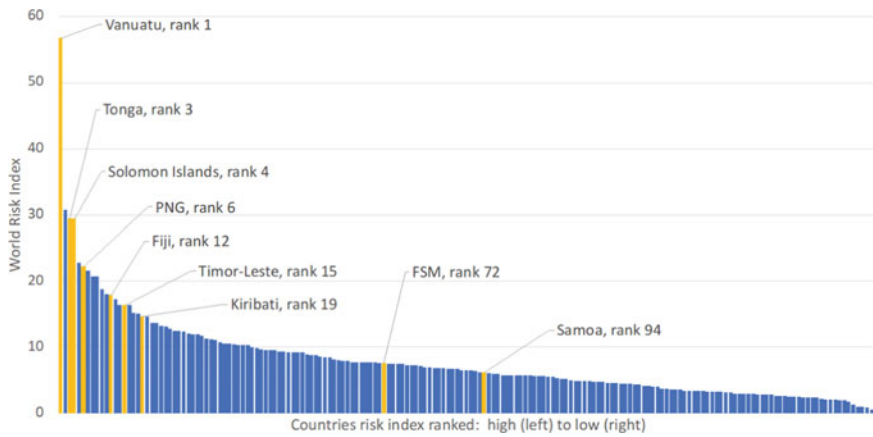

Fig. 14.8 Country disaster risk index with PICTs identified in yellow (Created using World Risk Index 2019 data provided in the World Risk Report 2019 (Bündnis Entwicklung Hilft 2019))

Tropical cyclone modelling is less certain. Most models project a decrease in frequency but signal an increase in the proportion of the most intense South Pacific tropical cyclones (Australian Bureau of Meteorology and CSIRO 2011). Since infrastructure damage increases exponentially with windspeed, most locations in the Pacific will have a higher chance of experiencing damage from category 4 and 5 cyclones this century (CSIRO et al. 2015). As crude indicators of the damage they already cause: the destruction, loss of life, and loss of livelihoods caused by Tropical Cyclone Pam in Vanuatu in 2015 amounted to 64% of GDP, Tropical Cyclone Winston cost 31% of Fiji's GDP in 2016, and Tropical Cyclone Gita 35% of Tonga's GDP in 2018 (WTO 2019).

The increased frequency and severity of extreme events may also reduce the ability of populations or states to adapt and cope. These risks to PICTs, both in terms of their high exposure to natural hazards and their limited capacities or resources to respond or adapt, are highlighted by the World Risk Report (Bündnis Entwicklung Hilft 2019). The report creates a general disaster risk index, ranking countries by their exposure and capacity to cope with natural hazards.⁸ Seven PICTs (including Timor-Leste) rank in the top twenty for disaster risk worldwide: Vanuatu (1st), Tonga (3rd), Solomon Islands (4th), PNG (6th), Fiji (12th), Timor-Leste (15th), and Kiribati (19th) (Fig. 14.8). The 2019 Index reveals that most PICTs fall into the categories of high or very high vulnerability, with severe consequences and limited coping capacity (Bündnis Entwicklung Hilft 2019).

Destruction and disruption resulting from natural hazards (such as tropical storms) are often associated with poverty. Such events may lead directly to the loss of assets

⁸ The index is a composite of five indices: Exposure, Vulnerability, Susceptibility, Lack of Coping Capacities, and Lack of Adaptive Capacities.

and livelihoods (housing, animals, fisheries, crops, resources, and infrastructure) or the injury or death of a family member, potentially pushing people into poverty, or creating further deprivation for already vulnerable, low-income households. Households may be forced to sell remaining assets to cope with the immediate losses or costs (such as health care or rebuilding homes). Even those not classified as poor may be vulnerable to losses. The significant proportion of people in the Pacific living around the \$5.50 per day poverty threshold, but lacking capital, savings, or insurance to help recovery, are prone to fall deeper into poverty post-disaster. This is likely to be compounded by consequences at a community, regional, or national level (see Chap. 10), including the disruption of roads and transport, water and energy supply infrastructure, destruction of crops (especially banana) and productive land (e.g., coastal taro production areas), markets, schools, and healthcare centres that result in inaccessibility of food, water, energy, education, healthcare, and other critical goods and services.

Poverty across the region is also exacerbated by human activity that affects land and marine environments and natural resources on which island populations depend for livelihoods, food and water security, and good health, as illustrated in Table 14.6.

Table 14.6 Sources of environmental degradation in the Pacific

Environmental degradation	Estimate of impact on the region, particularly as it links to poverty and vulnerability
Constrained resources	Population growth places pressure on finite and typically already constrained natural resources, including land and water, threatening food security and livelihoods (PIF 2018)
Climate Change	Rising sea levels, particularly noticeable during instances of storm surge, causes sea water inundation affecting infrastructure, agriculture, and fresh water especially on marginal lands where informal settlements tend to be concentrated in the Pacific (Connell 2017)
Pollution	Poor waste management, a lack of recycling, and limited landfill sites results in non-degradable solid and hazardous chemical waste threatening ecosystems, food, and water supplies (Connell 2017)
Over-fishing	The combination of marine pollution, climate change, and overfishing threatens the supply of fish, and with it, household nutrition, many livelihoods, and Pacific economies (PIF 2018)
Deforestation	Unsustainable logging and land clearing for agriculture has deforested swathes of natural forest, especially in Melanesia, resulting in soil compaction and erosion leading to decreased agricultural productivity (Wairiu 2017) and increased nutrient and sediment loads in waterways negatively impacting important food producing reef and coastal ecosystems
Urban development	Urban growth and associated environmental degradation occurs exclusively on the coast in PICTs (except in PNG), where cities and towns occupy prime land for agriculture, tourism, and fisheries (Connell 2017)

14.3.2 Government Responses and Challenges

The geographic dispersion of populations and frequent natural hazards contribute to the difficulty and raise the costs of delivering basic services and infrastructure to remote Pacific communities (Ware 2005). Such costs account for a relatively high share of GDP relative to countries at similar income levels (Figs. 14.9 and 14.10). The result is at times the under-provision of essential services such as primary health care to many communities (WHO 2018). Infrastructure, transport, and services where provided are hard to maintain, often of poor quality, and easily disrupted (ADB 2017; UNDP 2014), while the supply of trained teachers or health workers to remote locations is often difficult, as is the delivery of humanitarian assistance when needed.

Government expenditure on education (as share of GDP) is higher than the average for middle-income countries in several states (FSM, Kiribati, Solomon Islands, and Tuvalu), and is roughly comparable in others (Fig. 14.10). Only PNG's expenditure on education (1.9% in 2018) is below the low-income country average, although the proportion of primary school age children out of school (7.3% in 2016) is relatively low, even relative to other PICTs (Fig. 14.10).

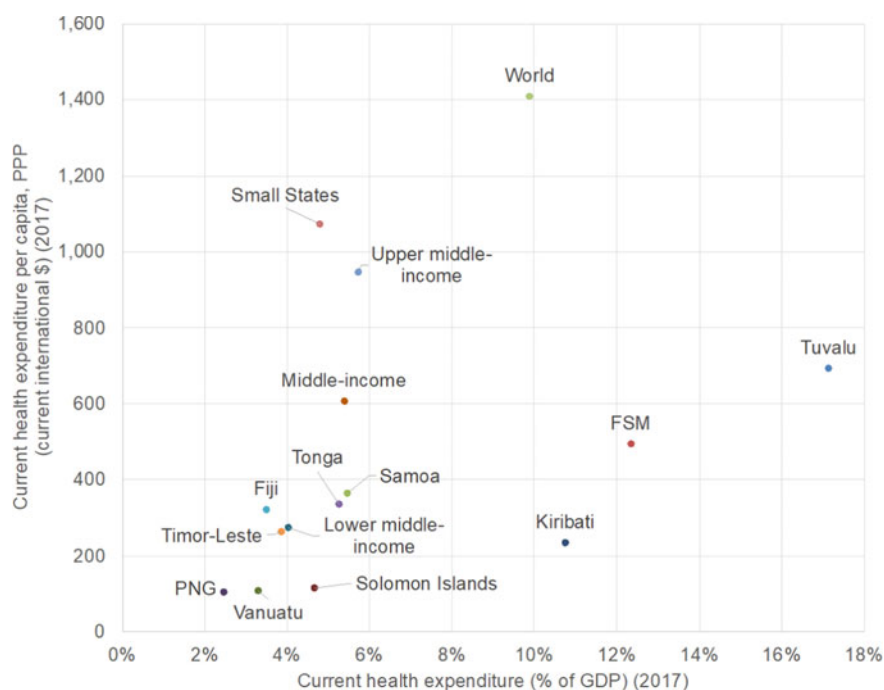

Fig. 14.9 Health expenditure per capita and as % of GDP (Source World Bank Data 2022)



Fig. 14.10 Government expenditure on education and enrolment outcomes (Source World Bank Data 2022)⁹

14.3.3 Migration, Informality, and Employment

As noted in Sect. 14.2, while urbanization remains low, it is increasing rapidly with migration from rural areas. Drivers for urbanization are not necessarily new: colonial authorities and religious missions encouraged traditional communities living inland on larger islands to move to emerging urban trade centres on the coast (Barnett and Campbell 2010). Recently, especially in Melanesia and Micronesia, urbanization has been accelerated by the internal migration particularly of young people moving from rural areas (including remote islands) in search of work and opportunities, resulting in a ‘youth bulge’ in Pacific urban and peri-urban areas (Connell 2017). While the share of the population living in urban areas is low in PNG (13.3%), Solomon Islands (24.2%), and Vanuatu (25.4%), these countries have the fastest growing cities, and their capitals are home to large informal settlements (Table 14.7) (Connell 2017).

⁹ Note: Some of the available data is antiquated. Date for Government expenditure on ed./Children out of school respectively: FSM 2015/2015, Kiribati 2000/2017, Solomon Islands 2010/2018, Tuvalu 1990/2016, Tonga 2000/2015, Vanuatu 2017/2015, Timor-Leste 2018/2018, Samoa 2016/2018, Fiji 2013/2016, PNG 2018/2016, Upper middle-income 2013/2018, Middle-income 2017/2018, Lower middle-income 2018/2018, Low-income 2018.

Table 14.7 Estimates of people living in urban informal settlements in Pacific Island capital cities

Country and capital city	Estimated population of capital town or city	Urban residents living in informal and squatter settlements in capital towns or cities (%)	Estimated Settlement Population in capital town or city
Suva, Fiji	178,000	20	35,600
Tarawa, Kiribati	119,700	40	47,880
Port Moresby, PNG	367,000	50	183,500
Honiara, Solomon Islands	81,800	33	26,994
Nuku'alofa, Tonga	106,000	10	10,600
Funafuti, Tuvalu	12,000	3	360
Port Vila, Vanuatu	52,690	30	15,807

Source World Bank Data (2022)

Port Moresby is home to approximately two in five of all Pacific urban residents, with half of them living in informal settlements.

Most of this urbanization is unplanned and poorly managed, with informal settlements often established on marginal or coastal lands, where they are exposed to natural hazards such as storm surge and cyclonic events, as is the case in Port Moresby, Honiara, Port Vila, and Suva (Thomas and Keen 2017; Connell 2017). Such settlements often lack basic infrastructure and amenities including electricity, water, or sanitation (Connell 2017), creating challenges for new settlers in accessing water, cooking fuel, and food, as well as adversely affecting health. Compounding these challenges, migrants may lose their village, kinship, or community systems of support. This loss is particularly acute in the wake of a disaster when the absence of informal support systems and social or familial safety nets may dramatically reduce resilience and the ability to recover (UNDP 2014). Most recently, COVID-19 has revealed key gaps in social protection, with those in informal low-income employment often falling outside any government safety net (Alfers et al. 2020).

Limited employment opportunities in PICTs create a high dependency on overseas employment. In most Pacific urban locations, the number of graduates exceeds the number of new job opportunities created annually; thus, cities are neither the engine for opportunity that many new migrants anticipate, nor are they the driver for inclusive and sustainable development to combat poverty (Connell 2017). Migration (typically to Australia and New Zealand) is one remedy for high underemployment and a major source of income through remittances (Box 14.1); recent evidence also suggests this may reduce population growth (Howes et al. 2020). Fiji, Samoa, and Tonga have large diaspora relative to their population (25, 60, and 70% respectively). Howes et al. (2020) argue that without migration, Samoa, Tonga, and Fiji would have higher population growth, along with higher rates of un-/underemployment, and more poverty. Conversely, Kiribati, PNG, Solomon Islands, Vanuatu, and Timor-Leste have

lower rates of migration and remittances alongside higher population growth (Table 14.1) (Howes et al. 2020).

14.3.4 COVID-19 and Poverty in the Pacific

The COVID-19 pandemic, as one more shock to hit the region, illustrates the multifaceted forms of vulnerability and volatility of the PICTs. In the initial phase of the pandemic, Pacific governments responded with strong measures to isolate their populations and were spared much of the public health impact seen elsewhere. However, as of early 2022, with the emergence of the Omicron variant alongside the gradual relaxation of travel, the virus is now sweeping through several islands (Carreon et al. 2022). This puts pressure on already fragile or over-stretched health systems, in a context where high rates of obesity significantly raise the risk of hospitalization from COVID-19 (ADB 2021). While most PICTs are progressing well with vaccinations, having benefitted from the COVAX initiative to share and coordinate international resources to low-to-middle-income countries, numerous concerns remain. Firstly, PNG, Solomon Islands, and Vanuatu are on track to be amongst the last in the world to reach high levels of vaccination (Lowy Institute 2021); and secondly, like many low-to-middle-income countries, most PICTs do not have access to combination vaccine therapies that provide improved protection against the infectious Omicron variant (Dolgin 2022).

While the health impacts are only now beginning to unfold, the consequences of restrictions on travel have been particularly severe for a region heavily reliant on tourism, trade, and overseas employment. Effective travel bans to combat the pandemic mean that both national and household budgets are being stretched to a breaking point, seriously affecting people's living standards (Hoy 2020). This is particularly true in tourism-dependent nations such as Cook Islands, Palau, Fiji, Samoa, Tonga, and Vanuatu, while commodity exporters such as PNG and Solomon Islands were also heavily affected (ADB 2021) (Fig. 14.11). The economic repercussions of COVID-19 have caused a decline in government taxation and other revenues in many PICTs, although aid-dependent countries (such as Tonga and Samoa) have been somewhat protected. While many PICTs entered the pandemic in a reasonably good fiscal state, COVID-19 related support programmes and reduced revenues have, in most cases, led to increased debt levels and thus decreased fiscal space for ongoing recovery efforts and other critical government spending (DFAT 2020; ADB 2021). Inflationary pressures linked to global supply chains will also particularly impact heavily trade dependent small island states.

There is little doubt that the pandemic and its broader consequences will stall or reverse many gains in poverty reduction and progress towards the SDGs more generally. As Hoy (2020) noted: "Even in our most conservative scenario of a 5% contraction in household consumption, the rate of extreme poverty may increase to over 30% of the population in PNG and Timor-Leste, 27% in Solomon Islands, and

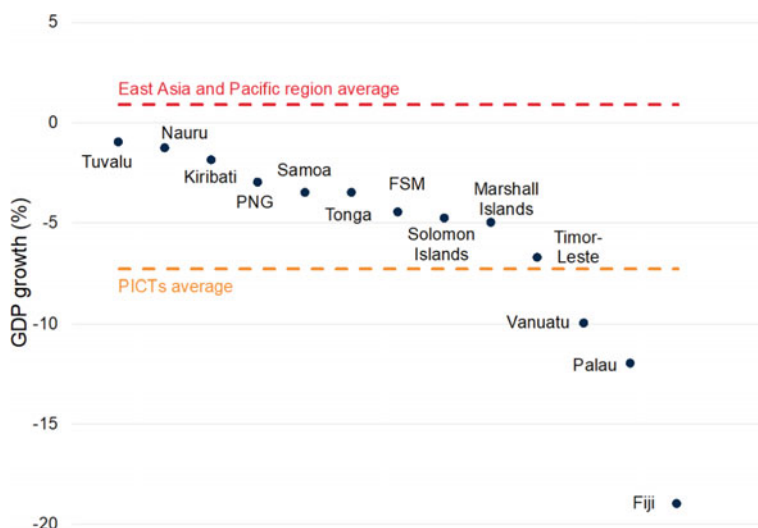

Fig. 14.11 GDP growth in 2020 (Adapted from World Bank 2021)

17% in Vanuatu. Our severe scenario of a 20% contraction [in household consumption] would result in an additional 1.2 million people in the region being pushed into extreme poverty, an increase of over 40% on pre-COVID-19 levels” (Hoy 2020). The extended nature of the pandemic and associated economic disruptions makes these scenarios increasingly likely.

14.4 Poverty Reduction Policies and Development Assistance in the Pacific

Given the distinct and varied contexts, geographies, and constraints of Pacific Island states, do standard approaches to poverty reduction adequately address the drivers, nature, or consequences of poverty? As demonstrated in the data above, the MDG period up to 2015 saw significant improvements in some human development indicators. This progress appears to have plateaued in more recent years, while opportunities for sustainable livelihoods and employment remain challenging. Structural constraints to growth and employment creation, the high costs of expanding infrastructure and services, and geographic or weather-related drivers of insecurity, vulnerability, or deprivation often remain untouched by poverty reduction interventions targeted at poor individuals or families. Limited growth opportunities and frequent shocks, including from natural hazards, mean that many PICTs are heavily aid dependent.

14.4.1 Aid and Development Assistance to the Pacific

Although the total amounts are comparatively small, Pacific nations receive among the highest rates of Official Development Assistance (ODA) per capita or as a share of Gross National Income (GNI) (World Bank Data 2022). As a share of GNI, Tuvalu receives 45.6% (2016–2017), followed by Marshall Islands (26.9%), and FSM (25.1%) (Fig. 14.12). Given its size, PNG receives by far the largest total aid in the region (Fig. 14.13). However, together with Fiji, it receives the lowest rate per capita—2.5 and 3.0% respectively (in 2017). Some PICTs also have access to labour migration schemes (particularly with Australia) as potentially important poverty reduction instruments. As illustrated in Fig. 14.14, significant variability in ODA is driven by humanitarian assistance for natural hazard induced disasters and emergencies, including climate-related events in addition to regular development assistance.

Australia and New Zealand provide over half of the Official Development Assistance (ODA) to the Pacific. Chinese ODA has trended upward over the last ten years, as has that provided by the Multilateral Development Banks and the United Nations, whereas ODA provided to the region by the United States and Australia has declined slightly (Table 14.8). China now provides more ODA to the region than the United States.

While new sources of finance may become increasingly available, for example through climate-related financing or through new donors or investments (particularly with China’s growing engagement in the region), there is still relatively little evidence of the impacts of such funds in relation to poverty reduction.

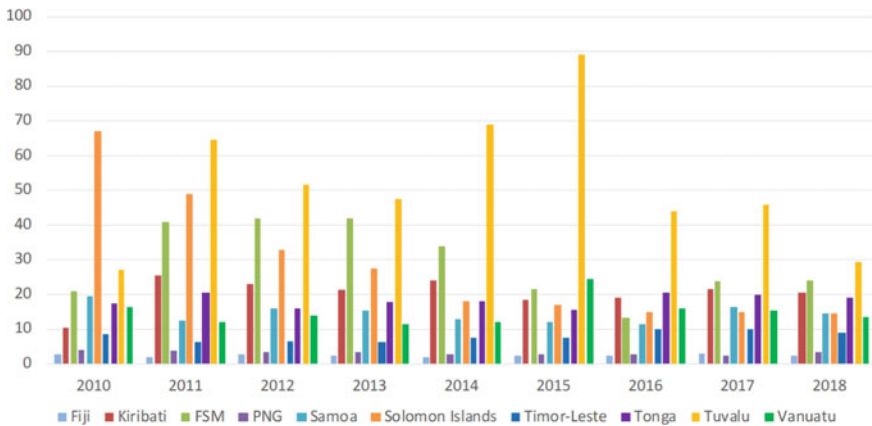

Fig. 14.12 Net Official Development Assistance received as a percentage of GNI (Source World Bank Data 2022)

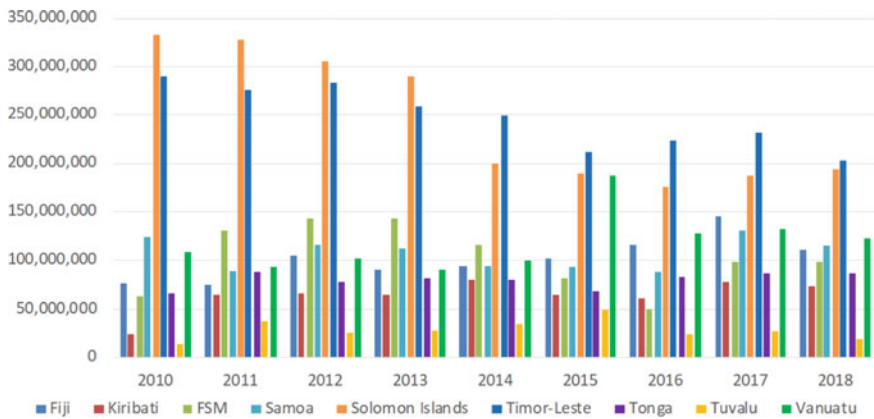

Fig. 14.13 Net Official Development Assistance received (current USD). PNG is excluded due to the comparatively large ODA receipts which, during this time series, fluctuated between \$514 m (2010) and \$786 m (2018) (Source World Bank Data 2022)

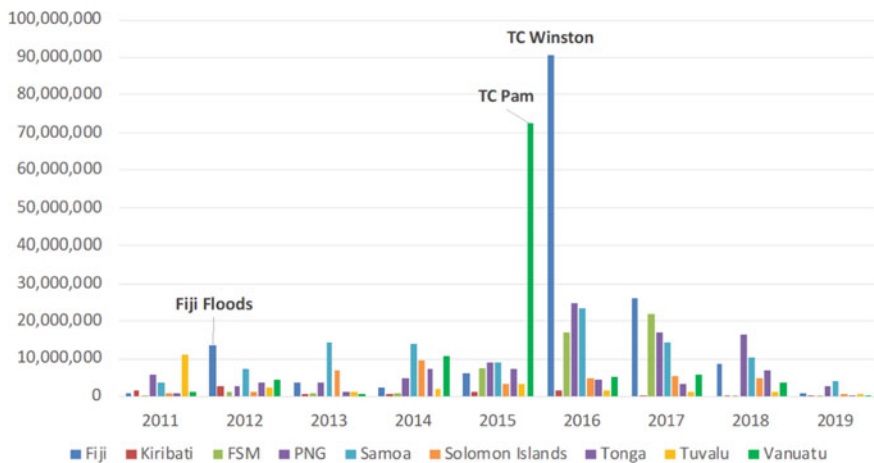

Fig. 14.14 Humanitarian aid committed to select Pacific countries (created using Lowy Institute 2020 data provided in the Lowy Institute Pacific Aid Map 2021)

14.4.2 Social Protection

Globally, the early twenty-first century has seen a dramatic shift in approaches to reducing poverty, with an emphasis on expanding systems of social protection as safety nets or assistance for people affected by shocks, as well as supporting those in chronic poverty. Cash transfers have become the main non-contributory social protection mechanism, with or without conditionalities attached; other programs include food or in-kind transfers and employment guarantee schemes. Instruments

Table 14.8 The top ten donors of Official Development Assistance (grants and loans) to the Pacific (in USD millions)

	2009	2010	2011	2012	2013	2014	2015	2016	2017	2018	2019	Trend
Australia	703	921	1,213	1,145	1,004	972	923	810	861	921	865	
New Zealand	116	145	168	197	184	231	204	201	194	265	254	
Japan	130	197	185	152	141	128	129	181	188	219	221	
China	64	95	117	127	177	200	234	287	229	246	170	
Asian Development Bank	112	70	62	105	150	82	91	102	151	239	168	
World Bank	5	6	13	37	75	75	88	92	107	314	159	
United States	216	117	233	205	216	181	131	66	158	186	140	
United Nations	19	39	37	22	28	36	52	87	76	111	116	
European Union	65	105	103	72	87	93	102	66	96	123	99	
Taiwan	22	22	47	50	38	59	61	37	39	35	41	
Annual total	1,452	1,717	2,178	2,112	2,101	2,058	2,015	1,929	2,099	2,659	2,231	

Source Lowy Institute (2020)

are designed to protect vulnerable individuals or families, and to invest in livelihoods and human capital in order to support sustainable movements out of poverty. As noted above, monetization and other forces have challenged the traditional community and kinship systems of reciprocity and collective support prevalent in many Pacific societies (UNDP 2014). As these systems have weakened, governments have developed or expanded both contributory and non-contributory programs of social protection, but coverage in the region remains low and uneven. Globally, the COVID-19 pandemic has shed a light on the gaps in social protection and challenges for expanding protection to affected groups, including the informally employed working poor.

With low shares of formal employment and high levels of informality, contributory social security coverage is likely to remain limited. Data reported in the ILO's Social Protection Report in 2017 indicates that most of the region either has limited legal social security coverage or the information is lacking. Only Fiji is classified as 'intermediate' in terms of coverage. The most common contributory programs cover old age pensions, with some disability or employment injury schemes. Limited provisions exist in areas of unemployment, sickness, maternity, and child benefits (ILO 2017). The elderly is the only group covered by programs in most countries, with a number introducing non-contributory social pensions to complement Provident Funds or employment related social insurance. However, effective coverage is often limited to under 10% of the elderly population while benefits may be very low (ILO 2017).

A number of non-contributory schemes have been introduced by governments to meet the needs of specific groups, and to respond to crises or disasters. Some of these are highlighted in Table 14.9. The key focus appears generally to be on the elderly, and on children, through education fee waivers or expansion of universal free education. Health care schemes, poverty targeted cash transfers, or support for the disabled have been introduced by some states but remain limited. In the context of COVID-19, several countries have introduced new, or scaled up existing, social protection programs. Timor-Leste, for example, is providing cash transfers to the poor (Magalhães 2020). Overall levels of spending on non-contributory social assistance or ‘safety net’ programs across the Pacific are low—generally below regional or global averages (World Bank 2018). Public spending on health, education, and social protection as a share of total public spending may even have decreased between 2000–2004 and 2014–2016 across a number of countries for which data is available (Timor-Leste, Kiribati, Samoa) (UNESCAP 2018). The latest ILO World Social Protection Report 2020–2022 shows expenditures on social protection (excluding health) ranged from 0.1% of GDP in PNG to 10.8 in Kiribati, with most Pacific countries below the lower middle country average of 2.5% and comparing poorly with the Southeast Asia and Pacific average of 8.2% (ILO 2021). This translates into low effective coverage with the share of population covered by at least one social protection (SDG indicator 1.3.1) ranging from 9.6% in PNG (below the LIC average of 13.4) to 86.3% in Kiribati (ILO 2021). Most PICTs approximate the Lower-Middle Income Country range (24.9%), well below the Southeast Asia and Pacific average of 61.5% (ILO 2021).

Data is limited on the specific social protection response to COVID-19 in PICTs. Most countries introduced some fiscal stimulus, increasing health expenditures and income support or social assistance.¹⁰ Howes and Surandiran (2020) report on a number of PICTs with expenditures ranging from under 1% in fiscally constrained states (Fiji, PNG) to 8.3 and 6% in Timor-Leste and Tonga respectively. They note that on average safety nets take up the largest share of new spending (22%) (compared to 21% for health) but also draw attention to the significant variation among states. What is clear is that pressure on government budgets has been severely exacerbated by the economic impacts of COVID-19. Government revenues have fallen, and with limited options for financing increased spending or providing fiscal stimulus, levels of debt in many PICTs have increased (IMF 2020). The risk is that this situation creates pressure for cuts in government spending, austerity measures, and efforts to raise taxation, likely slowing the recovery from COVID-19 and hindering progress towards the reduction of poverty and other key development goals.

¹⁰ The ADB policy tracker identifies the COVID-19 responses of countries in the region: <https://COVID19policy.adb.org/policy-measures>.

Table 14.9 Select non-contributory social protection schemes in the Pacific

Country	Program and purpose	Date started	Other details
FIJI	Food Voucher for Rural Pregnant Women: To improve maternal health and provide basic nutrition needs during pregnancy and childbirth	2104	Coverage: 4,221 (2015) Expenditure: FJD 1 million (2015)
	Care and Protection: Conditional cash transfer and food subsidy for children from households in difficult circumstances to ensure health, education, and basic needs	2008	Coverage: 4,696 children (2017) Expenditure: FJD 6,807,589 (2017/2018)
	Poverty Benefit Scheme: Conditional cash transfer, food subsidy, and training to improve the welfare of poor households	2013	Coverage: 25,259 people (2017) Expenditure: FJD 38.1 million (2017–2018)
	Social Pension Scheme: Cash transfer to assist elderly citizens who do not receive any other form of government assistance or pension support	2013	Coverage: 34,002 people (2017) Expenditure: FJD 37.2 million (2017–2018)
	Bus Fare Subsidy: To assist the elderly and people living with disabilities with their mobility	2011	Coverage: 46,750 (44,784 elderly persons and 1,966 persons with disabilities) in 2015 Expenditure: FJD 150,000 (2015)
KIRIBATI	Elderly Fund Scheme: Unconditional cash transfer to support elderly persons in line with traditional Kiribati kinship systems	2004	Coverage: 4,720, 53 per cent of whom were women (2016) Expenditure: AUD 2.9 million in 2016
	Copra Fund Subsidy: To support copra smallholder farmers and mitigate the rural–urban migration through provision of a minimum purchase price to copra farmers	Mid-1990s	Coverage: Working-age population: copra producers in the outer islands Expenditure: AUD 4.54 million or 2.8% of GDP (2009)

(continued)

Table 14.9 (continued)

Country	Program and purpose	Date started	Other details
	Education Fee waiver	2016	Expenditure: Approximately AUD 2.3 million per year
SAMOA	School Fee Grant Scheme: Educational fee waiver to improve access to basic schooling for students of Year 1 to Year 11, aiming to achieve universal free education	2010	Coverage: Students grades 1–11; 163 schools Expenditure: SAT 5.7 million (2015–2016)
	Senior Citizens Benefit Fund: Unconditional cash transfer to provide universal pensions to elderly Samoan residents	1990	Coverage: Elderly persons aged 65 years and above; 8,700 beneficiaries Expenditure: SAT 14,094,000 per year or 0.9% of GDP
SOLOMON ISLANDS	Free Basic Education: Provide free primary and junior secondary education to all school-age children	2009	Coverage: school age children Expenditure: SBD 55,841,350.00 (2018)
TIMOR-LESTE	Universal old age and disability pension: Cash transfer to meet needs of most vulnerable <i>(Other programs include cash transfer for poor female headed households with children)</i>	2006	Groups: Universal for individuals with disability and those over 60 Coverage: 7313 disabled and 86,974 elderly (2015)
	Free health and education	2002	All Timorese citizens
TONGA	Aged-care Service for the Elderly: To provide social support services to vulnerable elderly persons	2012	Groups: Vulnerable elderly persons without family support Coverage: 151 (as of March 2014) Expenditure: NA
	Social Welfare Scheme: Unconditional cash transfer to elderly to reduce high poverty risks	2012	Coverage: Total eligible elderly: 3,973; 2,161 women and 1,812 men (2014) Expenditure: If all eligible beneficiaries claim: TOP 3.1 (2014–15); expected 60 per cent take-up rate, TOP 1.86 million

(continued)

Table 14.9 (continued)

Country	Program and purpose	Date started	Other details
	Disability Welfare Scheme (A'uki ai cash assistance): Cash transfer and social services to support persons with severe disabilities	2015	Coverage: 576 (287 men and 289 women) (2016) Expenditure: TOP 677,040 (2016)
	Early Intervention Services: To provide support services to children born with a disability or developmental delay	2012	Groups: Children aged 0–3 years living with disabilities Coverage: 55 Children (2014) Expenditure: NA
TUVALU	Educational fee waiver: Primary education is free. Secondary education fees may be waived in case of financial need	NA	Groups: Children Coverage: NA Expenditure: NA
	Medical Treatment Schemes: Free medical services with serious cases referred to other locations (such as Fiji and New Zealand)	NA	Groups: Universal Coverage: NA Expenditure: AUD 3,700,000 (2017 budget)
VANUATU	Schools Grants Scheme: Educational fee waiver for primary and secondary school students	NA	School age children Coverage/expenditure: NA

Sources IPC-IG and UNICEF (2019), Slatter (2020), Timor-Leste: World Bank/ILO (2016)

14.4.3 Poverty Reduction and Sustainable Development

The 2030 Sustainable Development agenda added environmental, climate, and ‘blue economy’ goals to the poverty reduction agenda of the MDGs, thus linking the ‘social’ goals of the MDGs with economic and environmental processes that underpin or constrain well-being for individuals and communities. In no small part due to efforts of Small Island States and organizations such as the Pacific Island Forum, climate risks, natural hazards, environmental degradation, and the undervaluation or overexploitation of natural resources are explicitly addressed by the SDGs, while the inclusion of Goal 14 on ‘blue economy’¹¹ pays particular attention to the vulnerabilities and potential of island nations.

¹¹ SDG 14 on Life Below Water aims to ‘Conserve and sustainably use the oceans, seas and marine resources for sustainable development’, while SDG 13 focuses on urgent action to combat climate change and its impacts, and SDG 15 on protecting biodiversity and reversing land degradation.

The promise of the SDGs in terms of a greater focus on alternative development strategies and livelihood opportunities linked to ocean economies, sustainable resource use, renewable energy sources, and ecosystem services requires major financial and technical support from the global community—something that looks increasingly challenging in a post-COVID-19 economic downturn. In recent years, significant ODA (along with other investments) has been directed to infrastructure, technical assistance, and capacity building to support the Sustainable Development Goals (Lowy Institute 2020). While many projects, such as investments in transport or green energy, have potential to benefit the poor as well as the economy and environment, there is less evidence to date on how these investments perform in terms of poverty reduction or social goals. Globally, few instruments have as yet been popularized that explicitly link environmental or climate actions to poverty reduction.

In terms of progress, the UN's Asia-Pacific SDG report shows that over half the targets for the Pacific sub-region are not measurable, while the Pacific lags in key areas related to resilience and adaptive capacity, eco-systems, and biodiversity, as well as hunger, water, and sanitation (UNESCAP 2020). The Pacific Island Forum's First Quadrennial Pacific Sustainable Development Report (2018) highlights priority areas for accelerating progress, including enhancing social protection and gender equity (particularly addressing high levels of violence against women), and increasing employment in the oceans, fisheries, and sustainable tourism sectors, alongside efforts on climate change and disaster risk reduction (PIF 2018). It draws attention to the need for financial investments, regional institutions and capacity strengthening, and improved data for monitoring. While the leadership and commitments are strong, the question remains as to whether, even with sufficient investment, the region can foster a shift away from a traditional, carbon intensive growth model that often fosters inequality, towards a trajectory of sustainable and equitable development based on the ocean economy and its resources that can reduce poverty and lessen the region's external dependence.

14.5 Conclusions

This chapter has made the case that the lives of populations across the Pacific are marked less by extreme income poverty, except in particular contexts, but more by volatility of livelihoods and income sources and vulnerability, whether to natural hazards, the impacts of environmental degradation and climate change, or ill-health (particularly linked to inadequate diets and poor nutrition). The current global COVID-19 pandemic both illustrates and severely exacerbates this situation. Strengthening access to services and social protection that could help individuals and communities cope with short term shocks and income insecurity can be a key component in responding to such volatility. This chapter has shown that poor health linked to inadequate nutrition is a key feature of poverty in the region. To ensure

the availability, quality, and affordability of essential commodities to all by tackling problems at the intersection of water, energy, and food would be an important contribution to alleviating poverty and improving livelihoods of low-income households. Ensuring equitable access will require enhanced social protection measures that address the specific needs of vulnerable population groups.

The chapter has also illustrated the structural and geographic challenges that many Pacific Island communities and nations face, whether in strengthening short-term coping mechanisms, building ‘resilience’, or addressing the long-term underlying causes of vulnerability and persistent poverty. These include dimensions of remoteness that elevate the dependence on external relations, raise the costs of goods and services particularly in reaching isolated communities, and reduce opportunities for employment. Meeting the needs of growing populations, while building capacities for resilience and adaptation in the face of frequent shocks, resource scarcity, and long term environmental and climate change requires systems of support and investments in infrastructure that are particularly costly given geographic conditions. Policy efforts in the social and environment sectors are expanding albeit within tight fiscal constraints but limited employment opportunities remain a key barrier to more sustainable livelihoods and healthy lives for the poor.

Given the specific context and characteristics of the Pacific Islands, addressing the needs of vulnerable communities and individuals will require community-based and locally led initiatives and solutions. Ultimately however, to generate employment and sustained development, structural issues will need to be resolved through wider regional or global change. A promising area involves recognizing the value produced by ocean states through ‘ocean accounting’, a process that better accounts for the value of ocean ecosystems and marine resources. Ocean accounting has huge potential as a tool for recognizing and valuing the role of Pacific Islands in areas such as marine protection and sustainable exploitation of ocean resources including fisheries. It can support strategic and spatial planning of the ocean and coasts, regulation of ocean-based economic activities and sectors, adaptive management to keep pace with policy cycles, and attract associated investment (GOAP 2022). It may also have potential to provide sources of income and employment including through eco-system service payment schemes, as well as high protein food (Stuchtey et al. 2020).

Finally, data limitations remain a serious constraint to comparative analysis and monitoring of poverty, vulnerability, and inequality across the region, with limited information available, particularly disaggregated by gender or for other groups. Where data do exist, they are rarely comparative and often dated; small countries often become hidden in regional averages, particularly alongside their much larger Asian, and richer Oceania, neighbours. Support to improve institutional capacity for data collection, collation, and innovation in sparsely populated and remote island locations will be essential to closing data gaps and to provide a more nuanced understanding of drivers and changes in poverty, inequality, and wellbeing in these contexts. Such understandings may in turn enable better informed poverty reduction measures, as well as more equitable and sustainable development policies over the course of the twenty-first century.

References

- Abbott D, Pollard S (2004) Hardship and poverty in the Pacific. Pacific Studies Series. Asian Development Bank, Manila. <https://www.adb.org/sites/default/files/publication/28800/hardship-poverty.pdf>
- ADB (2017) Meeting Asia's Infrastructure Needs. Asian Development Bank, Manila. <https://www.adb.org/sites/default/files/publication/227496/special-report-infrastructure.pdf>
- ADB (2021) Pacific Economic Monitor, December, 2021. Asian Development Bank, Mandaluyong City, Philippines. <https://www.adb.org/sites/default/files/publication/757271/pem-december-2021.pdf>
- Alfers L, Ghida I, Marcela V (2020) Informal workers and the social protection response to COVID-19: who got relief? How? Did it make a difference? COVID-19 Impact Study Policy Insights #2. WIEGO. <https://bit.ly/3dIHrD>
- Australian Bureau of Meteorology and CSIRO (2011) Climate change in the Pacific: scientific assessment and new research. Volume 1: Regional Overview. https://www.pacificclimatechange.net/sites/default/files/documents/PCCSP_CCIP_Volume-1_Regional-Overview-complete.pdf
- AUSTRAC (2017) Remittance corridors: Australia to Pacific Islands. Australian Government, Canberra. <https://www.austrac.gov.au/sites/default/files/2019-06/remittance-corridors-risk-assessment.pdf>
- Barnett J (2011) Dangerous climate change in the Pacific Islands: food production and food security. *Reg Environ Change* 11:229–237. <https://doi.org/10.1007/s10113-010-0160-2>
- Barnett J, Campbell J (2010) Climate change and Small Island States power, knowledge and the South Pacific. Earthscan, London
- Bündnis Entwicklung Hilft (2019) World Risk Report 2019. Bündnis Entwicklung Hilft and Ruhr University Bochum—Institute for International Law of Peace and Armed Conflict, Berlin. https://reliefweb.int/sites/reliefweb.int/files/resources/WorldRiskReport-2019_Online_english.pdf
- Carreon B, Jackson LC, Rimon R, Wickham D (2022) Fear and dread: COVID-free for two years, Pacific islands experience explosion in case numbers. *The Guardian Australia*. 29 January. <https://www.theguardian.com/world/2022/jan/29/fear-and-dread-COVID-free-for-two-years-pacific-islands-experience-explosion-in-case-numbers>
- Connell J (2017) The urban Pacific: a tale of new cities. *Development Bulletin*, No.78. Special Edition: Urban Development in the Pacific. Crawford School of Public Policy, Australian National University, Canberra pp 5–10
- CSIRO, Australian Bureau of Meteorology and SPREP (2015) Climate in the Pacific: a regional summary of new science and management tools, Pacific-Australia Climate Change Science and Adaptation Planning Program Summary Report. Melbourne, Australia: CSIRO
- Department of Foreign Affairs and Trade (DFAT) (2020) Partnerships for recovery: Australia's COVID-19 development response. Australian Government, Canberra. <https://www.dfat.gov.au/publications/aid/partnerships-recovery-australias-COVID-19-development-response>
- Dolgin E (2022) Omicron thwarts some of the world's most-used COVID vaccines. *Nature* 601:311. <https://doi.org/10.1038/d41586-022-00079-6>
- Dornan M (2014) Energy poverty and access to electricity in the Pacific: heading in the wrong direction? In: DevPolicy Blog. Development Policy Centre, Australian National University, Canberra. 10 February 2014. <https://devpolicy.org/energy-poverty-and-access-to-electricity-in-the-pacific-heading-in-the-wrong-direction-20140210/#:~:text=Energy%20poverty%20is%20widespread%20in,to%20clean%20cooking%20energy%20technology>
- Dutra L, Haywood M, Singh S, Piovano S, Ferreira M, Johnson J, et al. (2018) Effects of climate change on corals relevant to the Pacific Islands. In: *Science Review 2018. Pacific Marine Climate Change Report Card*, Commonwealth Marine Economies Programme. pp 132–158
- GOAP (2022) Technical guidance on Ocean accounting for sustainable development, UNESCAP and Global Ocean Accounts Partnership, Version 1.0. <https://www.oceanaccounts.org/technical-guidance-on-ocean-accounting-2/>

- Howes S, Orton B, Surandiran S (2020) In the Pacific, migration and population growth are inversely related. In: DevPolicy Blog. Development Policy Centre, ANU, Canberra. 6 November 2020. <https://devpolicy.org/in-the-pacific-migration-and-population-growth-are-inversely-related-20201106-1/>. Accessed 24 Feb 2021
- Howes S, Surandiran S (2020) What are Pacific governments spending on in response to COVID-19? In: DevPolicy Blog. Development Policy Centre, ANU, Canberra. 24 August 2020. <https://devpolicy.org/what-are-pacific-governments-spending-on-in-response-to-COVID-19-20200824/>. Accessed 11 Feb 2022
- Hoy C (2020) Poverty and the pandemic in the Pacific. In: DevPolicy Blog. Development Policy Centre, ANU, Canberra. 15 June 2020. <https://devpolicy.org/poverty-and-teh-pandemic-in-the-pacific-20200615-2/>
- Human Development Index (HDI) (2020), UNDP, New York <http://hdr.undp.org/en/content/human-development-index-hdi>
- International Labour Organization (ILO) (2017) World Social Protection Report 2017–2019: Universal Social Protection to Achieved the Sustainable Development Goals. International Labour Office, Geneva. https://www.ilo.org/wcmsp5/groups/public/---dgreports/---dcomm/---publ/documents/publication/wcms_604882.pdf
- International Labour Organization (ILO) (2021) World Social Protection Report 2020–2022: social protection at the crossroads—in pursuit of a better future. International Labour Office, Geneva. https://www.ilo.org/wcmsp5/groups/public/@dgreports/@dcomm/@publ/documents/publication/wcms_817572.pdf
- International Monetary Fund (IMF) (2020) Pacific Islands Threatened by COVID-19. In: IMF News. International Monetary Fund. 27 May 2020. <https://www.imf.org/en/News/Articles/2020/05/27/na-05272020-pacific-islands-threatened-by-COVID-19>. Accessed 4 Aug 2020
- International Policy Centre for Inclusive Growth (IPC-IG) and United Nations Children’s Fund (UNICEF) (2019) Social protection in Asia and the Pacific: inventory of non-contributory programmes. International Policy Centre for Inclusive Growth, Brasília https://ipcig.org/pub/eng/RR29_Executive_Summary_Social_Protection_in_Asia_and_the_Pacific.pdf
- IPCC (2021) Summary for policymakers. In: Masson-Delmotte V, Zhai P, Pirani A, Connors SL, Péan C, Berger S et al (eds) Climate change 2021: the physical science basis. Contribution of working group I to the sixth assessment report of the intergovernmental panel on climate change. Cambridge University Press. In Press
- Lowy Institute (2020) Pacific aid map. Lowy Institute, Sydney. <https://pacificaidmap.lowyinstitute.org/>. Accessed 20 Aug 2020
- Lowy Institute (2021) Vaccinating the Pacific. Lowy Institute, Sydney. <https://pacificvaccination.lowyinstitute.org/>. Accessed 9 Feb 2022
- Magalhães F (2020) Timor-Leste’s coronavirus response. In: The Diplomat, May 4. <https://thediplomat.com/2020/05/timor-lestes-coronavirus-response/>. Accessed 4 June 2020
- Nanditha A, Ma RCW, Ramachandran A, Snehalatha C, Chan JCN, Chia KS et al (2016) Diabetes in Asia and the Pacific: implications for the global epidemic. *Diabetes Care* 39(3):472–485. <https://doi.org/10.2337/dc15-1536>
- Pacific Islands Forum Secretariat (PIF) (2015) Pacific regional MDGs tracking report. Pacific Islands Forum Secretariat, Suva, Fiji. https://rrrt.spc.int/sites/default/files/resources/2019-01/2015_Pacific_Regional_MDGs_Tracking_Report.pdf
- Pacific Islands Forum Secretariat (PIF) (2018) First Quadrennial Pacific Sustainable Development Report (executive summary). Pacific Islands Forum Countries with the support of the CROP and UN Agencies in the Pacific. Suva, Fiji: Council of Regional Organisations in the Pacific, UN Agencies in the Pacific. <https://www.sprep.org/attachments/VirLib/Global/quadrennial-pacific-sustainable-development-report-2018.pdf>. Accessed 24 Feb 2021
- Rajah R, Dayant A, Pryke J (2019) Ocean of debt? Belt and road and debt diplomacy in the Pacific. Lowy Institute, Sydney. <https://www.lowyinstitute.org/publications/ocean-debt-belt-and-road-and-debt-diplomacy-pacific>

- Ratuva S (2005) Traditional social protection systems in the Pacific—culture, customs and safety nets. In: International Labour Organization (ed) Social protection of all men and women: a sourcebook for extending social security coverage in Fiji: options and plans. International Labour Organization, Fiji, 2006. https://www.ilo.org/wcmsp5/groups/public/---asia/---ro-bangkok/---ilo-suva/documents/publication/wcms_156319.pdf
- Samson M (2016) Cognitive capital—investing in children to generate sustainable growth. In: Background paper for the Third High Level Meeting on Cooperation and Child Rights in the East Asia and Pacific Region. <https://www.unicef.org/eap/media/911/file/Cognitive%20Capital:%20Investing%20in%20Children%20to%20Generate%20Sustainable%20Growth.pdf>
- Serajuddin U, Hamdeh N (2020) New World Bank country classifications by income level: 2020–2021. World Bank Blogs, July 1. <https://blogs.worldbank.org/opendata/new-world-bank-country-classifications-income-level-2020-2021>. Accessed 23 Feb 2021
- Slatter C (2020) Social protection and ending poverty in Pacific Island States: a new fad or a real solution? In: DAWN Informs, Development Alternatives with Women for a New Era, pp 14–17, January. https://dawnnet.org/wp-content/uploads/2020/01/20200403_DI-Social-Protection-Final.pdf. Accessed 6 June 2020
- Stuchtey M, Vincent A, Merkl A, Bucher M, Haugan PM, Lubchenco J et al (2020) Ocean solutions that benefit people, nature and the economy. World Resources Institute, Washington, DC. <https://www.oceanpanel.org/ocean-action/people-nature-economy-report.html>
- Thomas P, Keen M (2017) Urban development in the Pacific. pp 1–3 Development Bulletin 78. Development Bulletin, No. 78. Special Edition: Urban Development in the Pacific. Crawford School of Public Policy, Australian National University, Canberra
- UNICEF Data (2020) United Nations International Children’s Emergency Fund, New York. <https://data.unicef.org/resources/dataset/malnutrition-data/>
- United Nations Department of Economic and Social Affairs (UNDESA) (2021) List of least developed countries (as of 24 November 2021). United Nations Department of Economic and Social Affairs’ Committee for Development Policy, New York. https://www.un.org/development/desa/dpad/wp-content/uploads/sites/45/publication/ldc_list.pdf
- United Nations Development Programme (UNDP) (2014) The state of human development in the Pacific: a report on vulnerability and exclusion in a time of rapid change. United Nations Development Programme, Suva. <https://www.unescap.org/sites/default/files/The%20State%20of%20Human%20Development%20in%20the%20Pacific%28LORes%29.pdf>
- United Nations Development Programme (UNDP) (2015) Overcoming vulnerability to rising oil prices: options for Asia and the Pacific. United Nations Development Programme, Bangkok. <https://www.asia-pacific.undp.org/content/rbap/en/home/library/climate-and-disaster-resilience/overcoming-vulnerability-to-rising-oil-prices.html>
- United Nations Development Programme (UNDP) (2020) About human development. United Nations Development Programme, Bangkok. <http://hdr.undp.org/en/humandev>. Accessed 1 Sept 2020
- United Nations Development Programme (UNDP) (2021) Why is it important to express GNI per capita in purchasing power parity (PPP) international dollars? United Nations Development Programme, Bangkok. <http://hdr.undp.org/en/content/why-it-important-express-gni-capita-purchasing-power-parity-ppp-international-dollars>. Accessed 24 Feb 2021
- United Nations Economic and Social Commission for Asia and the Pacific (UNESCAP) (2017) Statistical yearbook for Asia and the Pacific 2016: SDG baseline report. United Nations Economic and Social Commission for Asia and the Pacific, Bangkok. https://www.unescap.org/sites/default/files/ESCAP_SYB2016_SDG_baseline_report.pdf
- United Nations Economic and Social Commission for Asia and the Pacific (UNESCAP) (2018) Social outlook for Asia and the Pacific poorly protected. United Nations Economic and Social Commission for Asia and the Pacific, Bangkok. <https://www.unescap.org/sites/default/files/publications/SDD-SP-Social-Outlook-v14-1-E.pdf>
- United Nations Economic and Social Commission for Asia and the Pacific (UNESCAP) (2020) Asia and the Pacific SDG progress report. United Nations Economic and Social Commission

- for Asia and the Pacific, Bangkok. <https://www.unescap.org/publications/asia-and-pacific-sdg-progress-report-2020>
- United Nations Economic and Social Commission for Asia and the Pacific (UNESCAP) (2021). Assessing the impact of COVID-19 in Asia and the Pacific and designing policy responses: an Excel-based Model. United Nations Economic and Social Commission for Asia and the Pacific, Bangkok. <https://www.unescap.org/resources/assessing-impact-COVID-19-asia-and-pacific-and-designing-policy-responses-excel-based>
- Wairiu M (2017) Land degradation and sustainable land management practices in Pacific Island Countries. *Reg Environ Change* 17(4):1053–1064
- Ware H (2005) Demography, migration and conflict in the Pacific. *J Peace Res* 42:435–454
- WHO (2018) https://apps.who.int/iris/handle/10665/275483?search-result=true&query=universal+health+coverage+on+the+journey&scope=%2F&rpp=10&sort_by=score&order=desc
- World Bank (2012) The economic costs on non-communicable diseases in the Pacific Islands. World Bank Group, Washington DC. <https://www.worldbank.org/content/dam/Worldbank/document/the-economic-costs-of-noncommunicable-diseases-in-the-pacific-islands.pdf>
- World Bank (2014) Hardship and vulnerability in the Pacific Island Countries. World Bank Group, Washington DC. <http://documents1.worldbank.org/curated/en/649891468098658407/pdf/85557-REVISED-WP-P144446-PUBLIC-Box391432B-1502066-Pacific-Hardship-Web-PUBLIC.pdf>
- World Bank (2016) Health and non-communicable diseases. In: Pacific Possible. World Bank Group, Washington DC. <http://pubdocs.worldbank.org/en/942781466064200339/pacific-possible-health.pdf>
- World Bank (2018) The state of social safety nets 2018. World Bank Group, Washington DC. <https://openknowledge.worldbank.org/bitstream/handle/10986/29115/9781464812545.pdf?sequence=5&isAllowed=y>
- World Bank (2020) COVID-19 crisis through a migration lens. In: Migration and Development Brief. World Bank Group, Washington DC. <http://documents1.worldbank.org/curated/en/989721587512418006/pdf/COVID-19-Crisis-Through-a-Migration-Lens.pdf>
- World Bank (2021) Global economic prospects. World Bank Group, Washington DC. <https://www.worldbank.org/en/publication/global-economic-prospects>
- World Bank and International Labour Organization (WB/ILO) (2016) Universal social protection country cases. In: Global partnership for universal social protection report. World Bank Group. <https://www.social-protection.org/gimi/gess/RessourcePDF.action?id=55072>
- World Bank Data (2022) World Bank Group, Washington DC. <https://data.worldbank.org>
- World Health Organization (WHO) (2018) Universal health coverage on the journey towards healthy islands in the Pacific. World Health Organization Regional Office for the Western Pacific, Manila. <https://iris.wpro.who.int/handle/10665.1/14233>
- World Health Organization (WHO) (2020) World Health Organization Data. Geneva. <https://apps.who.int/gho/data/view.main.REGION2480A?lang=en>
- World Health Organization (WHO) (2021) Obesity. World Health Organization, Geneva. https://www.who.int/health-topics/obesity#tab=tab_1. Accessed 23 Feb 2021
- World Trade Organization (WTO) (2019) Natural disasters and trade. World Trade Organization, Geneva. https://www.wto.org/english/tratop_e/devel_e/study1_symptaturaldisaster29112019_e.pdf

The opinions expressed in this chapter are those of the author(s) and do not necessarily reflect the views of the UNESCO: United Nations Educational, Scientific and Cultural Organization, its Board of Directors, or the countries they represent.

Open Access This chapter is licensed under the terms of the Creative Commons Attribution-ShareAlike 3.0 IGO License (<https://creativecommons.org/licenses/by-sa/3.0/igo/>), which permits use, sharing, adaptation, distribution, and reproduction in any medium or format, as long as you give appropriate credit to the UNESCO: United Nations Educational, Scientific and Cultural Organization, provide a link to the Creative Commons licence and indicate if changes were made. If you remix, transform, or build upon this book or a part thereof, you must distribute your contributions under the same licence as the original.

The use of the UNESCO: United Nations Educational, Scientific and Cultural Organization's name, and the use of the UNESCO: United Nations Educational, Scientific and Cultural Organization's logo, shall be subject to a separate written licence agreement between the UNESCO: United Nations Educational, Scientific and Cultural Organization and the user and is not authorized as part of this CC-IGO licence. Note that the link provided above includes additional terms and conditions of the licence.

The images or other third party material in this chapter are included in the chapter's Creative Commons licence, unless indicated otherwise in a credit line to the material. If material is not included in the chapter's Creative Commons licence and your intended use is not permitted by statutory regulation or exceeds the permitted use, you will need to obtain permission directly from the copyright holder.



Chapter 15

Living in Oceania



Amit Singh, Atishma Lal, and Janez Susnik

Abstract The ever-increasing impacts of climate change have once again reignited the growing debate on natural resource scarcity in the Pacific Island Countries and Territories (PICTs). New scientific findings repeatedly suggest the situation is grave as we continue to push planetary boundaries for the sustainable use of natural resources, threatening natural systems and our own existence. In the PICTs the situation is especially critical, given the current and forecast impacts of climate change (Chap. 5) on these island nations. In an island setting where resources may be limited and vulnerable the issue of security requires appropriately scaled attention. Confounding this is a multitude of pressures presenting a complex problem of demand. Key pressures faced on many PICT resources are increasing human populations; competing demands; the emergence of new opportunities, markets, and consumers; the fragmented nature of resource governance; and climate change. These illustrate the new realism of physical and economic scarcity of resources we face in the era of globalization, even across the geographically vast region of Oceania. Amongst this, water, energy, and food (WEF), are most critical to the region. These three resources are critical for human sustenance, essential separately but intrinsically connected in their use and management needs. This resource and policy nexus must be actively managed as its mismanagement and insecurity impede social stability and economic growth for the region. This chapter aims to understand the applicability of the WEF nexus in the PICT context. This considers both nexus experience in the PICTs to date and the opportunities and challenges the WEF nexus presents in its operationalization specifically in a PICT context.

A. Singh (✉)
Ministry of Waterways and Environment, Suva, Fiji
e-mail: ameet7486@gmail.com

A. Lal
Water Authority of Fiji, Suva, Fiji
e-mail: atishma.lal@waf.com.fj; lal3@un-ihe.org

A. Lal · J. Susnik
IHE Delft, Delft, The Netherlands
e-mail: j.susnik@un-ihe.org

© UNESCO 2024

A. Dansie et al. (eds.), *The Water, Energy, and Food Security Nexus in Asia and the Pacific*, Water Security in a New World,
https://doi.org/10.1007/978-3-031-25463-5_15

335

Keywords Atoll · PICTs · Resource scarcity · Groundwater · Climate change · Freshwater · Agriculture · Energy · WEF nexus · Sustainability

15.1 Introduction

The Pacific region consists of twenty-two Pacific Island Countries and Territories (PICTs) and is home to 12.3 million people, which is 0.15% of the global population (Fig. 15.1). The PICTs constitute the largest ecosystem in the world, covering almost half the globe’s sea surface (Seidel and Lal 2010). For the 12 million Pacific Islanders, the Pacific Ocean is their major economic, social, and cultural lifeline (Charlton et al. 2016; Seidel and Lal 2010).

The Pacific region is characterized by scattered nations composed of numerous islands of varying size, geological and hydrologic characteristics, and includes a

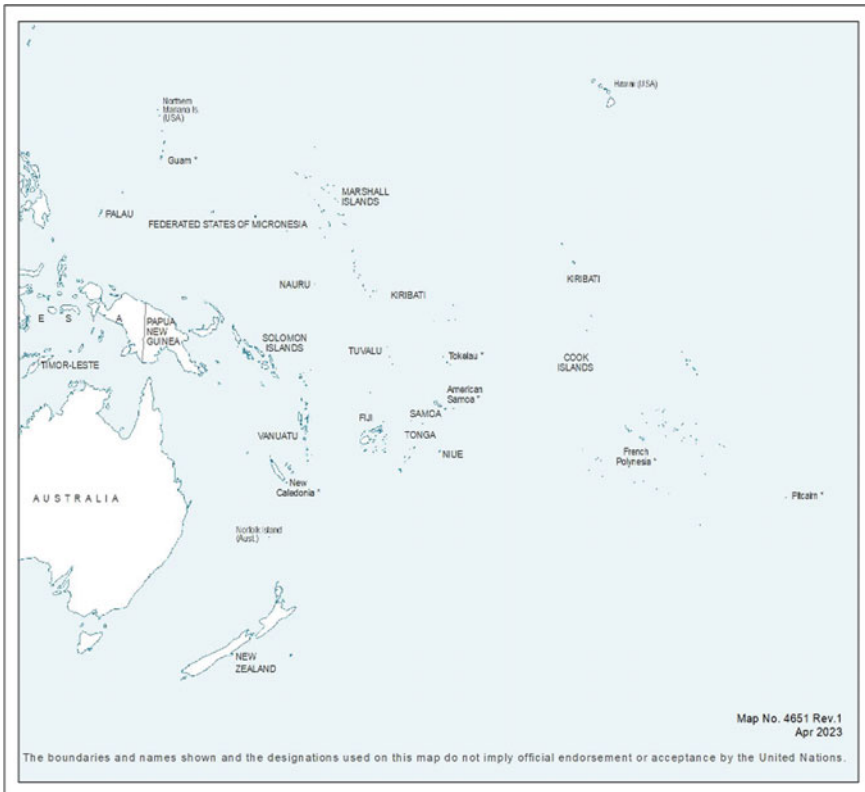

Fig. 15.1 Pacific regional map, adapted from UN Geospatial (2023)

variety of island types, ranging from the large, high volcanic islands to the tiny low-lying coral atolls; from the island with abundant surface water and groundwater to those that have no natural surface water systems, or very limited groundwater and are completely dependent upon rainwater catchments such as Niue and Tuvalu (Carpenter and Jones 2004; Dixon-Jain et al. 2014; Duncan 2011). Also see Chap. 2.

Globally, water, energy, and food are the most vital resources for societies, and these are key to human survival, wellbeing, and growth. While these resources may be considered renewable and readily available, demands for these resources has increased rapidly due to increasing population, uncertain climatic future and climate change impacts, and a shift towards increasingly urbanized lifestyles (Endo et al. 2017; Taniguchi et al. 2017). The increased demands are causing unsustainable pressures globally on water, energy, and food resources, presenting communities with an increasing number of trade-offs (Endo et al. 2017), potential conflicts over competing uses of these resources (Fader et al. 2018), and an urgent need for its safeguard and management (da Silva and de Moraes 2018). The situation in the Pacific is no different and given the geophysical characteristics of islands and its size, the trade-offs and conflicts amongst these resources are rather real and apparent.

To manage these trade-offs, it is essential to manage water, energy, and food through a nexus approach, a paradigm that has existed for some time now. However, a WEF approach uptake and practice are fairly new to the Pacific region. The WEF nexus illustrates debates around 'resource scarcity' and promotes an integrated approach in resource management, which accounts for co-benefits and trade-offs in policies related to energy, agricultural, and water sectors (Karatayev et al. 2017). It demonstrates the inter-linkages between the three resources calling for a policy nexus for its management.

PICTs are heavily dependent on natural resources for their economic development and likely to remain so for the near future, making resource management an issue of critical importance for economic development (Bell, Matthews et al. 2016; Bell, Taylor et al. 2016; Chand 2001). It is the scarcity of the resources and management into an uncertain climatic future (Chap. 11), that makes the WEF nexus approach in PICTs an important consideration in current and future resource planning and decision making.

Historically, PICTs contribution to global greenhouse gas emissions has been considered insignificant compared to large global polluters (Bogner et al. 2008), nonetheless, PICTs have been the planet's most vulnerable nations to the effects of climate change (Althor et al. 2016; Mcleod et al. 2019; Salem 2020) PICTs have historically been reliant on fossil fuel sources to attain energy requirements (Bijay et al. 2013; Michalena and Hills 2018), which is having an enormous impact on their economies (Mani et al. 2020; Michalena et al. 2018). The transport sector in the region uses approximately 75% of fossil fuel consumption and is the largest contributor to the regions GHG emissions (Holland et al. 2014; Newell et al. 2017; Nuttall et al. 2014). An analysis of the Second National Communication to the United Nations Framework Convention on Climate Change of PICTs illustrates that most of the emissions from PICTs are from the transport and energy sector (Mani et al. 2020) with many PICTs opting to focus on emission reduction in these two sectors by 2030

as the core of their Intended Nationally Determined Contributions (Goundar et al. 2017; Holland et al. 2014; Mani 2020; Michalena et al. 2018; Newell et al. 2017). The PICTs have demonstrated a willingness to transition to a low carbon economy for overall sustainable development. The security of water, energy, and food resources has been a long, where studied, deliberation in isolation and it is critical now these three resources need to be studied together in a nexus approach in PICTs context.

15.2 Characteristics of the Pacific Region—“*Islandness*”

PICTs have traditionally been classified as “high” or “low,” with further classification into volcanic islands, atolls, and raised limestone islands (Carpenter and Jones 2004). The high islands primarily consist of rugged volcanic mountains surrounded by fringing or barrier reefs. Some islands also exhibit a fringe of low-lying coastal plains surrounding the mountainous interior (Forbes et al. 2013). Atolls consist of limestone reef deposits laid down on an underlying volcanic cone. In most cases, the portion of atolls above sea level is usually not more than a few meters high and have an area of a few square kilometres, for example, Kiribati and Tuvalu. It is the challenges associated with island size, remoteness, extreme vulnerability, and associated resource constraints that further contributes to “islandness” context of PICTs (Campbell, 2009; Kelman 2018, Malua and UNCTAD 2003). The PICTs smallness constitutes a major constraint on its resource management use of limited land for various resources—water, food, and energy.

The vulnerabilities associated with uncertain climate futures are real in PICTs. Almost 97% of Pacific people (excluding Papua New Guinea) live within ten kilometers from the coast, more than half of it live within one kilometers of the coast, and more than 90% of Pacific Islanders live within five kilometers of the coast (Andrew et al. 2019). All the population in the coral atoll nations of Kiribati, Tokelau and Tuvalu live within a kilometre of the ocean (Andrew et al. 2019). The coastal zones of PICTs are incredibly important areas for human habitation and economic endeavour, encompassing all the opportunities and risks that are associated with it. The “islandness” of PICTs are further illustrated in Table 15.1. It is within this 10 km coastal zone where most of the economic activities take place, resources are constantly exploited, and where the WEF nexus could be most applicable.

Four of the PICTs, Vanuatu, Tonga, Solomon Islands, and Papua New Guinea (PNG) are among the world’s most disaster-prone nations (Radtke 2020). A further four PICTs even include the undesirable classification as being among the most vulnerable nations in the world to climate change. These are the low-lying coral atolls and reef islands, Kiribati, Tuvalu, Tokelau, and the Marshall Islands. As Pacific societies adjusts, responds, and adapts to the increasing vulnerabilities posed by the changing climatic future, the WEF nexus provides the complex opportunity to build resilience and mitigate threats.

The PICTs face unique and yet similar challenges in managing water, energy, and food security. Water, however, has featured most prominently as a challenge to

Table 15.1 Geographical, population, and risk characteristics of selected PICTs

Country or territory	Land area [km ²]	Sea area/EEZ [km ²]	Population	Ratio of the sea to land area	Island type	% living within 1 km from the Coast	World risk index
American Samoa (US)	199	390,000	56,813	1,960	High islands	61	–
Northern Marianas (US)	457	1,823,000	56,608	3,989	High islands	100	–
Cook Islands	237	1,830,000	15,281	7,722	High islands and atolls	91	–
Fiji	18,272	1,290,000	894,961	71	High island with a few minor atolls	41	12
French Polynesia (Fr)	3,521	5,030,000	278,908	1,429	High islands	100	–
FSM	701	2,980,000	105,503	4,251	High islands and atolls	100	–
Guam (US)	541	218,000	176,664	403	Uplifted ophiolite	30	–
Kiribati	811	3,550,000	118,744	4,377	Predominantly atolls	100	19
Marshall Islands	181	2,131,000	54,590	11,773	Atolls	100	–
Nauru	21	320,000	11,690	15,238	Raised coral island	93	–
New Caledonia (Fr)	18,576	1,740,000	273,015	94	High island	57	–
Niue	259	390,000	1,562	1,506	Raised coral island	25	–
Palau	444	629,000	17,930	1,417	High islands and atolls	93	–
PNG	462,840	3,120,000	8,934,475	7	High island with a few small atolls	8	6
Samoa	2,935	120,000	198,646	41	High islands	61	94
Solomon Islands	28,370	1,340,000	712,071	47	High island with a few atolls	65	4

(continued)

Table 15.1 (continued)

Country or territory	Land area [km ²]	Sea area/EEZ [km ²]	Population	Ratio of the sea to land area	Island type	% living within 1 km from the Coast	World risk index
Tokelau (NZ)	12	290,000	1,506	24,167	Atolls	100	–
Tonga	650	700,000	99,780	1,077	High island with a few small atolls	84	3
Tuvalu	26	900,000	10,580	34,615	Atolls	100	–
Vanuatu	12,190	680,000	294,688	56	High island with a few small atolls	64	1
Wallis and Futuna (Fr)	142	300,000	11,441	2,113	High islands	92	–
TOTAL	551,390	30,571,000	12,325,506	55/310*	–		

Sources Population data is from Statistics for Development Division <https://sdd.spc.int/topic/population>
Percent of population living within 1 km of coast from Andrew et al. (2019)
World risk index data from Radtke (2019)

be addressed throughout the PICTs. PICTs are often subject to water extremes; too little or too much water. To address this requires long-term commitment. It requires both political support and local and innovative approaches to chart a course through a turbulent future by drawing from experience globally and tailoring it to suit the regional and national context. The WEF nexus approach attempts to provide such a pathway enticing PICTs to adopt an integrated approach in resource management, which accounts for co-benefits and trade-offs in policies related to energy, agricultural, and water sectors. Limitation due to “islandness” and also resource ownership regimes in PICTs means access to the natural resource is hotly contested.

15.3 The Resource Challenge in the Pacific

“We have a young and fast-growing population. This means many mouths to feed and bodies to clothe and take to the clinic. We have only so much land for food gardens and our forests are declining from over-logging. We can choose to prepare for the future, or we can try to go back to the old ways that led to falling prosperity and violence and destruction of the ethnic tensions”. Peter Boyers, Solomon Islands Finance Minister, Radio SIBC, 28 November 2005.

The PICTs have natural disadvantages imposed by their small sizes and remoteness. This has been rightly put by Peter Boyers, Solomon Islands Finance Minister (2005–2006). As dealt with in detail in Chaps. 5 and 10, climate change and extreme weather events are impacting the hydrological cycle in the Pacific. These events, such as irregular rainfall (with resulting floods and droughts), changing weather patterns, storm overtopping (Fig. 15.2), saltwater intrusion, and increased storm intensities, all have significant impacts on water availability and agriculture production and food security in the region. Moreover, energy continues to be a key priority in the region, given that almost all PICTs remain highly dependent on imported fossil fuels.

Like most countries in world, securing future food availability is a top priority in most of the Pacific Island Countries (ESCAP, 2013). The region is highly dependent on imported food, with agriculture still catching up to be a significant part of the formal economy in many PICTs. Agriculture accounts for less than 30% of GDP in all PICTs, and for most, it accounts for less than 20% (Barnett 2020, Piesse n.d.). As discussed by (Campbell 2015), food security in PICTs varies from country to country and is largely dependent on geo-physical characteristics of islands; ranging from raised volcanic island (Melanesia) with fertile lands, to low-lying atolls (Polynesia and Micronesia) (McGregor et al. 2009).

Both the Boe Declaration on Regional Security, signed at the Pacific Islands Forum in 2018, and the Pacific Islands Forum Summit Kainaki II Statement in 2019, reiterate ‘climate change remains the single greatest threat to the livelihoods, security, and

Fig. 15.2 Sea level rise and overtopping are a ubiquitous risk throughout the Pacific (©Amit Singh)



wellbeing of the peoples of the Pacific' (Piesse, n.d.). The situation is critical for low atoll islands, many of which are only two to five metres above sea level at their highest point and are threatened by rising sea levels that are likely to weaken food and water security (Barnett 2011, 2020; Piesse n.d.).

15.3.1 Water Challenges

“The challenges facing the region in terms of freshwater resources are immense. Many of these islands have limited water resources, not to mention human, financial and management resources. It is imperative that we improve water use efficiency to meet the basic human needs and to support sustainable development,” Dr. Park Young-Woo, Regional Director of UNEP Regional Office for Asia and the Pacific—April 22nd, 2012.

Water resources are crucial for human, environmental sustenance, and ecosystem well-being (White and Falkland 2010). Atoll PICTs are most vulnerable in terms of availability of water resources (Oberle et al. 2017; White and Falkland 2010), continual impacts of climate change (Falkland and White 2020) and human activities (Falkland and White 2020). The vulnerability of water resources and associated socio-economic and environmental stresses in the Pacific is closely related to the availability of water (Duncan 2011), in terms of both quantity and quality. Climate change will further exacerbate water stress in PICTs, particularly small island states that rely on seasonal rain for their freshwater needs. The spatial and temporal variability of water further adds to water stress in larger islands in the Pacific. As population growth and urbanization rates in the region rise, the stress on PICTs water resources rapidly deepens with the need for investment in centralized systems and changing lifestyle demands.

The most water stressed PICTs are atoll nations (see examples in Table 15.2). They exhibit a spectrum of issues emanating from reliance on shallow freshwater lenses, most of which are less than 15 m deep (Oberle et al. 2017). Their susceptibility to pollution and contamination, resource degradation, over-exploitation, salinization, and drought-induced water scarcity make water security especially fragile. In such a landscape the competition over scarce available land area for groundwater protection, recharge and use, food production, and renewable energy installations are in constant conflict. The need to adopt water and resource management policies that promote and foster the sustainable use of water resources, while promoting economic growth is increasingly an important issue. In such a setting, the WEF nexus offers an integrated approach and sets a platform to analyze the synergies, trade-offs, and competing interest for a particular resource between the different sectors to maximize

the efficiency of the resource use. This then allows appropriate policies to be developed and adopted and institutional arrangements made to benefit from cross-sector synergies.

During the last two decades, there have been multiple attempts led by development partners, including GEF, EU, ADB, and World Bank for PICTs to adopt and follow Integrated Water Resources Management (IWRM) for water resources management and governance. Supported by multiple donors including the Global Environmental Facility (GEF) the United Nations Development Programme (UNDP), there was an attempt to formulate national water strategies and action plans and implement water policies grounded in IWRM principles, through the Sustainable Integrated Water Resources Management in the Pacific Project implemented by SOPAC in (2004–2008) and the EU-funded Pacific IWRM National Planning Programme (2008–2013). However, despite this regional effort in most countries, a significant gap remains in the implementation of the institutional framework, a vital pre-requisite for IWRM. There are multiple reasons for such delays, the most prominent ones include the sectorial-based approach to water management, leading to fragmentation of water sector management in many PICTs. It is quite evident that the water agenda in the region is set by concepts emanating out of the global discourse on water management, whether it be IWRM, water security, blue economy, etc. Water development and environmental management in the region is heavily contested with multiple international and regional agencies running parallel programs, aimed at providing water and climate related interventions. This includes the promotion of water and sanitation, water security, and groundwater management as distinct priority areas. This illustrates that there is to some extent a “niche” approach by agencies who work in the water sector in the region with water security seen through varying institutional lenses. These agencies have established a specialization in the broad water discourse and pursue them through projects implemented in the region. Critical analysis of projects implemented in the water sector in PICTs during the last decade (2008–2018), illustrate an investment of approximately USD 600 million in water sector (Lowy Institute 2019) including multiple projects in water sanitation and hygiene (WASH), water security, and groundwater. While this illustrates continuous development support to address water stress in the region, support in addressing water extreme events like floods, water efficiency, and irrigation efficiency are still yet to be tapped.

To support effective governance of water resources in the region there is an urgent need for an institutional and legislative enabling environment to be in place, before large infrastructure-based water projects could be implemented. There are very few countries (PNG, Palau Samoa, and American Samoa) (Mirti and Davies 2005) in the region that have water-related legislation. As such, it is critical to create modern water legislative instruments for integrated water management and governance. Moreover, greater efforts are required to revise and modernize archaic and existing laws and to strengthen the institutional capacity necessary for water management in the region.

Table 15.2 PICTs water, energy, and food information

Country or territory	Main water resources	% Population access to water	Renewable water resources $\text{Mm}^3 \cdot \text{yr}^{-1}$	Expenditure on imported food	Agriculture, forestry, and fishing, value added (% of GDP)	Electrification level % (2015)	Fuel import % of GDP
American Samoa (US)	SW, GW (limited)	93	–	–	–	–	–
Northern Marianas (US)	GW, SW	96	–	–	–	–	–
Cook Islands	SW, GW, RW	59	56	–	–	99	5.9
Fiji	SW, GW, RW, D (tourist resort only)	95	28,600	–	11.8	92	11.2
French Polynesia (Fr)	SW, GW, D	33	–	–	4.7	–	–
FSM	SW, GW, RW	37	2,034	–	22.5	65	12.9
Guam (US)	GW, SW	68	–	–	–	–	–
Kiribati	GW, RW, D (limited)	32	21	53	28.6	65	10.3
Marshall Islands	RW (from airport catchment and buildings), GW, D (emergency)	32	1.6	–	15.2	90	11.9
Nauru	D (regular use), RW, GW (limited)	119	–	–	4.2	99	9.6
New Caledonia (Fr)	SW, GW, RW	70	–	–	3.7	–	–

(continued)

Table 15.2 (continued)

Country or territory	Main water resources	% Population access to water	Renewable water resources Mm ³ .yr ⁻¹	Expenditure on imported food	Agriculture, forestry, and fishing, value added (% of GDP)	Electrification level % (2015)	Fuel import % of GDP
Niue	GW, RW	–	132	–	–	100	11.8
Palau	SW, GW, RW	67	1,160	–	3.2	98	12.9
PNG	SW, GW, RW	11	801,000	–	17.0	20	6.6
Samoa	SW, GW, RW	92	1,328	40	9.8	98	6.4
Solomon Islands	SW, GW, RW	10	44,700	30	29.7	43	7.1
Tokelau (NZ)	RW	–	–	–	–	–	–
Tonga	GW, RW	60	401	52	17.1	96	11.2
Tuvalu	RW (primary), GW (limited), D (emergency)	49	1	–	16.5	98	16.3
Vanuatu	SW, RW, GW	20	9,970	30	25.8	33	5.3
Wallis and Futuna (Fr)	SW	32	–	–	–	–	–

Notes: SW = Surface water, GW = groundwater, RW = rainwater; D = desalination

Sources: Main water resources from SOPAC (2004); Percent population access to water from PWVA (2020); Renewable water resources from SOPAC (2011); Expenditure on imported food from Estimé et al. (2014); Agriculture, forestry, and fishing, value added (% of GDP) from World Bank (2020); Fuel import % of GDP from SPC (2017)

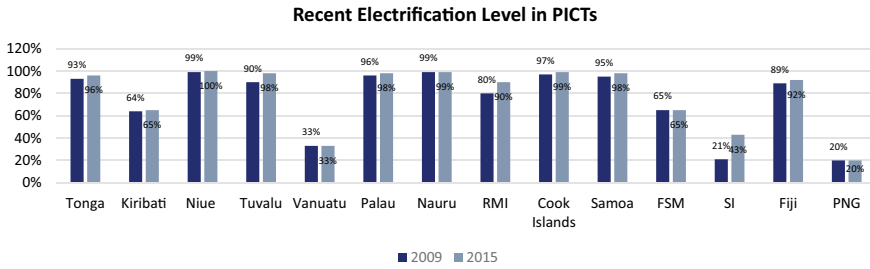

Fig. 15.3 Electrification levels in PICTs (population) (Source SPC [2017])

15.3.2 Energy Challenges

PICTs have one of the highest dependencies on imported petroleum fuel anywhere in the world (Table 15.2). See also Chaps. 3 and 12. Oil price volatility therefore often significantly challenges the energy and economic security of PICTs. Changes in global oil prices disproportionately affects PICTs by undercutting socio-economic stability (Jayaraman and Choong 2009; Narayan et al. 2008), operational costs of power utilities (Jayaraman and Choong 2009; Levantis 2019), and eventually household disposable income (Dornan 2015; Prasad et al. 2007). Despite PICTs importing a large amount of fossil fuels, energy access remains alarming low in most of the Melanesian countries, Vanuatu, Solomon Islands and Papua New Guinea, compared to other PICTs (see Fig. 15.3).

With almost all PICTs being highly dependent on imported fossil fuels, energy security continues to be a key regional priority. As PICTs continues their economic development, the energy demand will increase, whether it is provided through fossil fuel or renewable sources is at the hands of policy implementation and not just aspiration. Many PICTs through the National Determined Contributions (NDCs) as part of the Paris Agreement (Michalena and Hills 2018) have demonstrated the desire to move to renewables and have set an ambitious target for 2030, see Fig. 15.4, below. Resources constraints that allow effective and affordable policy implementation whether it be finance, technology, capacity or land and water (in atolls) will determine the future of renewable energy in the region. This is covered in detail in Chaps. 3 and 12.

15.3.3 Food Challenges

...climate change will adversely affect food systems in the region, including the supply of food from agriculture and fisheries, the ability of countries to import food, systems for the distribution of food, and the ability of households to purchase and utilize food. (Barnett 2011)

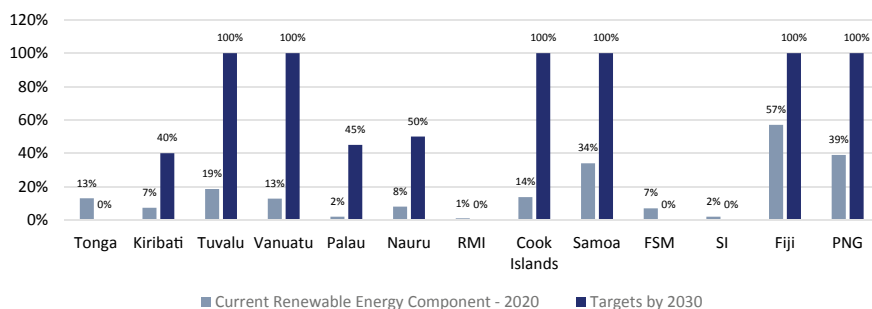

Fig. 15.4 PICTs renewable energy component (*Source* PPA Presentation during Pacific Resilience Meeting)

While PICTs have been identified as highly vulnerable in numerous discourses, food security has been key to many traditional Pacific Island societies, whether it be inland or coastal communities on large islands with considerable natural assets, or those that are on extremely small, low-lying atolls with little to no soil and limited water resources (Campbell 2020; Charlton et al. 2016). Food security in PICTs has been sustained through agroecological biodiversity (Iese et al. 2018), the production of surpluses, and food preservation and storage that has seen them through important times of hardship, such as extreme natural events, including the use of resilient crops and ‘famine’ foods (Campbell 2020). This however has changed with colonization (Chap. 11), and continuing urbanization, with many of above practices in decline (Chap. 4). Crop diversity and resilient crop strains have been sacrificed (Allen 2015; Campbell 2020) to make way for high priced export commodities. Resultingly, food import reliance has increased throughout the region especially in the low atoll islands of Micronesia (Connell 2015; McGregor et al. 2009).

The traditional food system in PICTs is designed such that traditional staple crops such as breadfruit, wild nuts, yams, taro, and fish and dried fish products provide an all-year-round supply of food (Allen 2015; Charlton et al. 2016; Iese et al. 2018); however, this is under threat by climate change induced water availability (Barnett 2011; Iese et al. 2018). This has led to transition in food in PICTs (Popkin 2006), inducing a shift in dietary patterns from typically complex carbohydrates, fresh fish and meat, and leafy greens, to increasingly modern diets, based on refined starch, oils, processed meats and confectionary (Charlton et al. 2016).

In the PICTs agriculture and tropical fruits grown in home gardens and commercially are vitally important; they determine food security and makes a huge contribution to the “livelihood of the populace and gross domestic product” (Rosegrant et al. 2015).

Climate change poses real and irreversible risks to the food security of individuals and PICT communities (Barnett 2020), and will affect both the agriculture and marine resources of the region. Given the proximity of farms to coasts, and the fact that almost 90% of Pacific islanders live within 10 km of the sea (Andrew et al. 2019), changes in sea level will exacerbate coastal inundation, soil salinization, and seawater intrusion

into arable farmlands, thereby affecting the sustainability of coastal agriculture and associated livelihood (Chaps. 2 and 4).

The discussion above illustrates that the Pacific region is largely a resource-stressed region. Confronting this stress requires radical re-thinking of current business as usual practice and charting a course to navigate through a turbulent and uncertain climatic future.

15.4 Understanding of the Nexus—Pacific Context

Human Right to Water

The Food and Agriculture Organization (FAO) projects that 60% more food and 80% more energy will be required by 2050 to meet global demand; an increase in total global water withdrawals by 50% in developing countries and 18% in developed countries by 2025 is projected. This situation is aggravated by a number of factors, for example, the increasing number of people adding meat to their diets, which is energy and water intensive. The inter-linkages between water, energy, and food are affecting the development of each of these sectors.

The nexus approach focuses on the interdependence of water, energy, and food; the understanding of challenges and opportunities; and provides motivation on new approaches for managing water, energy, and food resources (Liu et al. 2017). The versatile utilization of water, energy, and food from multiple sources is a reality in many of the PICTs. Addressing water, energy, and food uncertainties are prerequisites for social stability and economic growth. Yet in the region, management and governance of water, energy, and food are still sectorial with minimal interaction between the three, despite widespread and evident interdependence (Taniguchi et al. 2017). This fragmentation is typical and has been greatly discussed by (Weitz et al. 2017), when considering the governance around a WEF nexus approach.

Despite advances in WEF nexus research and understanding (including inter-relations, data integration, modelling, governance, and policy aspects) and the increased awareness of the close relationship of water, energy, and food there remain many challenges in operationalizing WEF nexus in PICTs. This is largely because in today's world water, energy, and food are sectorial managed and funding, policy-making, and oversight of these resources are sectorial based. This “silo” often leads to negative trade-offs impacting policy and technological choices. Observations that water, energy, and food are too often managed in various, and often very different spatial and temporal scales (Liu et al. 2017; Weitz et al. 2017) are very relevant and applicable in PICTs, given the current fragmented resource management paradigm in PICTs. A more holistic approach to resource management is required, whereby planning and policy making considers all three WEF sectors together, along with

their drivers and pressures (e.g., climate change, socio-economic development), in order to develop policies that consider cross-sectoral impacts and attempt to harness synergies while minimizing trade-offs.

15.5 Water, Energy, And Food Nexus Challenges in PICTs

The WEF nexus has inspired many discussions on new approaches for managing water, energy, and food resources led by agencies such as ESCAP and FAO at regional and international conferences such as 2nd Asia-Pacific Water Summit and the International Conference on Water, Energy and Food Nexus for Sustainable Development, 2014. In many ways, the WEF nexus approach and terminology has not enjoyed the same prominence and popularity as other paradigms such as “blue economy” and/or “green economy”, certainly not in PICTs and the region. One of the reasons is that for the WEF nexus there were no PICT advocates to push the concept. It is interesting to note that though both “blue-green economy” and “WEF nexus” are foreign to the region and despite both stressing the complementarities between economic, environmental, resource objectives, and trade-offs, the uptake on “blue economy” is far greater than that of WEF nexus in the PICTs. Historically, international aid agencies, non-state actors, multilateral institutions, and regional organizations too often promote such discourse in the region, yet with WEF nexus this has not been the case.

It is not surprising that the regional natural resources policy space is heavily contested, PICT national governments adopt global discourse based on the relevance to their national agenda which determines their alignment and support for particular discourse. Given such observations, it becomes critical to explore the reasons for the lack of traction of WEF nexus in the region, of which there could be several. Three notable reasons are: (1) the challenge of incorporating and enhancing the components of this multi-centric nexus, especially in a fragmented resource governance architecture within most of PICTs, (2) as novel the WEF approach may be, it lacks concise narrative outlining mandate and affiliation to global commitments, such as the SDG's, and as such it is simply seen as repackaging of an existing framework, e.g., IWRM, around water, food, and energy. The WEF nexus is multi-faceted and is too often seen as either an analytical tool or a governance approach; however, the WEF nexus could also be realized as an emerging discourse (Liu et al. 2017) and provide a platform to start regional discussions on resource scarcity, trade-offs, and resource sustainability in PICTs. Such discussions are important in PICTs as apart from addressing national resources scarcity, it also provides the opportunity to combine efforts for realization of Agenda 2030, as water, energy, and food are present individually and in combination in most, if not all of the SDGs, although nexus approaches per se are not included in the goals. What this means for PICTs is that WEF nexus has not been able to mobilize any regional initiatives or projects. This in itself demonstrates the lack of prominence WEF nexus had at national, regional, and development space in PICTs. (3) the understanding and usage of the term WEF

nexus is “plural, fragmented, and ambiguous” as discussed by (Simpson and Jewitt 2019), and hence an energy sector speaks of the energy-water-food (EWF) nexus, a hydrologists and water engineers call it the water-energy-food (WEF) nexus, while those in the agricultural use the term, the food-energy-water (FEW) nexus (Liu et al. 2017). This variance in terminology illustrates that that the conceptual approach to the WEF nexus is generally dependent upon the perspective of the particular researcher, policy-maker, or agency, and different groupings embracing the WEF nexus with contrasting foci, e.g., sustainability, the green economy, trade-offs, livelihoods, climate, resource optimization, or scarcity (Simpson and Jewitt 2019). As such, driving such concept in a region becomes difficult.

The *water perspective* is still dominant in the WEF nexus discourse (Endo et al. 2017); however, as a nexus approach, there is a need to promote equal participation of all involved sectors (Nauditt 2018). In a resource-constrained low lying atoll environment, water is prioritized, so in such case “water for agriculture for food” does not take precedence nor does it make sense to push the agenda.

The *trade-off between water, energy, and food* is more drastic in PICTs compared to other parts of the world. One of the reasons is that there is no large-scale agriculture (Griswold 2021) or large dams in the region (Singh 2019), minimizing a need to quantify and address tangible large-scale trade-offs via a nexus approach. As with much of the international development agenda the WEF nexus approach is also seen as a neoliberal idea, with economic ties and pushing for rapid growth (Bell, Matthews et al. 2016; Bell, Taylor et al. 2016; Müller-Mahn and Gebreyes 2019; Wiegleb and Bruns 2018) and “development” rather than an interdisciplinary nexus approach for resource management.

It is too often seen that in the context of WEF nexus that *some components of each are included more often than others* and, in some cases, certain aspects are left out. For instance, looking at energy, electricity generation through hydropower dams often take key precedence, and more often water quality or environmental flow requirements are left out. Examples include dam operations of major dams around the world including Cahora Bassa in Mozambique and impacts of its operations on natural flooding and geomorphology in Zambezi delta (Singh 2017). This is a considerable trade-off in importance of what is prioritized, particularly when talking about agriculture and water interactions.

In PICTs most of the population live within 10 kms of the coast (Andrew et al. 2019) and marine-food sources. The WEF nexus may seem out of context in such a situation, as most of these dwellers largely depend on coastal fisheries for their sustenance (Chap. 4). The goal then is to re-imagine the Western WEF nexus and tailor it for the specificities of the PICT region, refocussing it to place the prominent issues of water supply, sustainable energy generation, and a shift to traditional food production at the centre of nexus analyses.

PICTs ability to untangle and uptake the WEF nexus as a policy consideration is also limited by the lack of systematic tools, information, and awareness on the trade-offs involved in the nexus, meaning the adoption and implementation of WEF nexus becomes extremely challenging. In this regard, the recently developed WEF

Nexus Index (<https://wefnexusindex.org/>) could play an important role in facilitating new WEF related discussions in the region.

15.6 Water, Energy, and Food Nexus Opportunities in PICTs

Understanding the opportunities that the WEF nexus presents for the management of water, energy, and food systems is becoming increasingly important and is critical to a sustainable and secure future for all PICTs. The Bonn 2011 Nexus Conference held in preparation for the United Nations (UN) Rio +20 Conference, further highlighted the need to address sustainability issues in the closely related sectors of water, energy, and food security.

“The old ways of growing our economy, of developing our nation, are no longer adequate or acceptable. We need to reshape our development strategies away from the conventional growth model of exploiting particular resources for our own use in the here and now. We need to refine our existing approaches and forge a new development model—one that is more holistic, integrated, inclusive and above all sustainable ... this Green Growth Framework will be one that is truly home grown, truly Fijian. And it will benefit not only Fijians but be ready to serve as a model for our island neighbours, who look to us for leadership on this issue as they do on other things relating to their own development”—Fiji’s Prime Minister, Josia Voreqe Bainimarama.

Nexus Opportunity Areas: The water, energy, and food sectors have numerous interlinked policy concerns ranging from sustainability, access, climate change adaptation/mitigation, and environmental impacts. These issues manifest in very distinct ways in each of the three sectors but often the impacts are closely related, as such, it becomes important to identify these interrelationships and maximize synergies and to resolve current, and avoid any potential conflicts (Hamdy et al. 2014). WEF Nexus opportunities present themselves by cutting across interlinked decision spaces and facilitating the identification of win–win solutions. Such opportunities include:

Synergy and trade-off awareness in resource management: The WEF Nexus provides the opportunity for policy coherence, ensuring that synergies and trade-offs among water, energy, and food are identified both in design and implementation policies, plans, and projects (Hamdy et al. 2014). This is where nexus approaches such as casual loop diagrams, developed with stakeholders via group model building exercises, can prove very useful (Purwanto et al. 2019). Excessive exploitation, non-sustainable management, and increasing demand have caused severe degradation of the natural resources in PICTs. Climate change and competition for land especially

in atolls have further exacerbated the issue and caused land degradation and reduced water and land productivity, in turn having an impact on biodiversity and a wide range of ecosystem services. The WEF nexus provides a pathway to maximize the use of scarce coastal agricultural land available in the region, allowing for water and energy infrastructure (e.g., solar farms) to compliment agricultural lands, maximizing the arable land use.

Integration of efforts: The WEF nexus, through its synergistic linkages of water, energy, and climate policy, allows policymakers to develop integrated policies and frameworks and explore and exploit synergies when dealing with water, energy, and food security. A WEF nexus approach can link a range of policy options to balance national and regional development and achieve a more comprehensive, resilient, and sustainable future. It also provides opportunities for sustainable economic, social, and environmentally responsible benefits for the people of the Pacific. A nexus approach further provides a paradigm shift away from conventional sectoral policy and decision making and gives way to an integrated approach that reduces trade-offs and builds synergies across water, energy, and food sectors through a nexus approach.

Transitioning towards a blue-green economy: To succeed, a blue-green economy must go beyond sectorial solutions and actively address the water, energy, and food security in line with human rights-based approaches. The terms “green growth” and, “blue-green economy,” have gained considerable traction in the PICTs and informs national and regional policies (Dornan et al. 2018). The PICTs, through each country’s national sustainable development strategies aspire to achieve greener and more inclusive economic growth, and a WEF Nexus approach can provide this. The nexus approach can support the transition to a green economy which aims among other things, at resource use efficiency and greater policy coherence between WEF sectors, to establish policy frameworks, and enhance the economy inclusive and positive to environmental sustainability. Indeed, the green economy itself is the nexus approach par excellence.

Moving forward, the WEF Nexus is still yet to be fully realized in the PICTs. There is an urgent need for institutional set-ups and procedures to support the mainstreaming of the WEF nexus approach into national policies, strategies, and activities of the PICTs. Integration of and deliberations on the WEF nexus at national and regional levels may provide opportunities to analytically analyze the nexus in respect to natural disasters and climate change, and in doing so improve and enhance the overall resilience of the country and the society.

While some PICTs may be more self-sufficient in food production than others, all PICTs are very much not self-sufficient in energy production. The production of energy from the renewable source has to the potential to positively impact most of the PICTs GDP, given agriculture, forestry, and fishery contributions to GDP has been on a decline in most of the PICTs (McGregor et al. 2016; Stewart 2006). Disparity in security for different parts of the nexus is observed in many relationships between water, energy, and food self-sufficiency and diversity in the region. Strengthening of WEF Nexus in the region requires a set of interventions to strengthen the awareness, information, institutional capacities, and the intra-regional dialogue, to enhance data collection and management, as well as to implement economic instruments and

integrated economic approaches to measure the impact of Nexus into the economy and employment.

The WEF nexus approach has the potential to greatly inform discussions on achieving interconnected SDG targets and subsequent monitoring of the SDGs. There is an opportunity to promote the WEF nexus as a conceptual tool for achieving sustainable development goals in the PICTs. WEF implementation has for too long been seen as nirvana concept (Molle 2008), and has failed to explicitly or adequately incorporate sustainable livelihoods perspectives (Biggs et al. 2015). However, there are clear synergies (socio-ecological pressures, governance, the environment, environmental and economic security) between the SDG's and WEF Nexus approaches. For successful implementation of a WEF Nexus approach in the region, moving forward the nexus framings need to consider key issues in food, water, and energy security through a sustainability lens in order to predict and mitigate against risks of future insecurity. Applying the WEF nexus approach in such a way would streamline its integration into national development plans and national adaptation plans, via regional instruments such as Framework for Resilient Development (FRDP).

References

- Allen MG (2015) Framing food security in the Pacific Islands: empirical evidence from an island in the Western Pacific. *Reg Environ Change* 15(7):1341–1353
- Althor G, Watson JEM, Fuller RA (2016) Global mismatch between greenhouse gas emissions and the burden of climate change. *Sci Rep* 6(1):1–6
- Andrew NL, Bright P, Rua de la L, Teoh SJ, Vickers M (2019) Coastal proximity of populations in 22 Pacific Island countries and territories. *PLoS ONE* 14(9):e0223249
- Barnett J (2011) Dangerous climate change in the Pacific Islands: food production and food security. *Reg Environ Change* 11(1):229–237
- Barnett J (2020) Climate change and food security in the Pacific Islands. In: Connell J, Lowitt K (eds) *Food security in small island states*. Springer, Singapore, pp 25–38
- Bell A, Matthews N, Zhang W (2016) Opportunities for improved promotion of ecosystem services in agriculture under the Water-Energy-Food Nexus. *J Environ Sci Stud* 6(1):183–191
- Bell JD, Taylor MFP, Amos M, Andrew NL (2016) Climate change and Pacific Island food systems the future of food, farming and fishing in the Pacific Islands under a changing climate. CCAFS and CTA. Copenhagen, Denmark and Wageningen, the Netherlands.
- Biggs EM, Bruce E, Boruff B, Duncan JMA, Horsley J, Pauli N et al (2015) Sustainable development and the water–energy–food nexus: a perspective on livelihoods. *Environ Sci Policy* 54:389–397
- Bijay P, Schulte V, Prasad S (2013) An overview of climate-smart technologies in the Pacific Region. Climate-smart technologies-integrating renewable energy and energy efficiency in mitigation and adaptation responses. *Climate change management*. Springer-Verlag, Berlin Heidelberg, Germany, pp 3–18
- Bogner J, Pipatti R, Hashimoto S, Diaz C, Mareckova K, Diaz L et al (2008) Mitigation of global greenhouse gas emissions from waste: conclusions and strategies from the Intergovernmental Panel on Climate Change (IPCC) fourth assessment report. Working group III (Mitigation). *Waste Manag Res* 26(1):11–32
- Campbell J (2009) Islandness: vulnerability and resilience in Oceania. *Shima Int J Res Island Cult* 3:85–97

- Campbell JR (2015) Development, global change and traditional food security in Pacific Island countries. *Reg Environ Change* 15(7):1313–1324
- Campbell JR (2020) Development, global change and food security in Pacific Island countries. In: Connell J, Lowitt K (eds) *Food security in small island states*. Springer, Singapore, p 39–56.
- Carpenter C, Jones P (2004) An overview of integrated water resources management in Pacific Island countries: a national and regional assessment. SOPAC Miscellaneous Report 554, p 37.
- Chand S (2001) Managing natural resources in the Pacific Islands. Resource management in Asia Pacific developing countries. http://www.crawford.anu.edu.au/degrees/idec/working_papers/IDEC01-6.pdf
- Charlton KE, Russell J, Gorman E, Hanich Q, Delisle A, Campbell B et al (2016) Fish, food security and health in Pacific Island countries and territories: a systematic literature review. *BMC Public Health* 16(1):1–26
- Connell J (2015) Food security in the island Pacific: is Micronesia as far away as ever? *Reg Environ Change* 15(7):1299–1311
- da Silva GNS, de Moraes MMGA (2018) Economic water management decisions: trade-offs between conflicting objectives in the sub-middle region of the São Francisco watershed. *Reg Environ Change* 18(7):1957–1967
- Dixon-Jain P, Flannery E, Sundaram B, Walker K, Fontaine K, Stewart G et al (2014) Pacific Island groundwater and future climates: first-pass regional vulnerability assessment. *Geoscience Australia Record* 2014/43. Geoscience Australia, Canberra. <https://doi.org/10.11636/Record.2014.043>
- Dornan M (2015) Renewable energy development in small island developing states of the Pacific. *Resources* 4(3):490–506
- Dornan M, Morgan W, Newton Cain T, Tarte S (2018) What’s in a term? “Green growth” and the “blue-green economy” in the Pacific islands. *Asia Pac Policy Stud* 5(3):408–425
- Duncan D (2011) Freshwater under threat. Pacific Islands vulnerability assessment of freshwater resources to environmental change. United Nations Environment Programme, Bangkok, Thailand
- Endo A, Tsurita I, Burnett K, Orencio PM (2017) A review of the current state of research on the water, energy, and food nexus. *J Hydrol Reg Stud* 11:20–30
- ESCAP UN (2013) Water-food-energy nexus in Asia and the Pacific. United Nations. Bangkok, Thailand
- Estimé MS, Lutz B, Strobel F (2014) Trade as a structural driver of dietary risk factors for noncommunicable diseases in the Pacific: an analysis of household income and expenditure survey data. *Glob Health* 10(1):1–15
- Fader M, Cranmer C, Lawford R, Engel-Cox J (2018) Toward an understanding of synergies and trade-offs between water, energy, and food SDG targets. *Front Environ Sci* 6:112
- Falkland T, White I (2020) Freshwater availability under climate change. In: Kumar L (ed) *Climate change and impacts in the Pacific*. Springer, Cham, p 403–448.
- Forbes DL, James TS, Sutherland M, Nichols SE (2013) Physical basis of coastal adaptation on tropical small islands. *Sustain Sci* 8(3):327–344
- Goundar A, Newell A, Nuttall P, Rojon I, Samuwai J (2017) King Canute muses in the South Seas: why aren’t Pacific Islands transitioning to low carbon sea transport futures? *Mar Policy* 81:80–90
- Griswold D (2021) Growing hope: island agriculture and refusing catastrophe in climate change adaptation in Fiji. *Isl Stud J* 16(2):136–155
- Hamdy A, Driouech N, Hmid A (2014) The water-energy-food security nexus in the mediterranean: challenges and opportunities. 5th International Scientific Agricultural Symposium, Agrosym, pp 23–26
- Holland E, Nuttall P, Newell A, Prasad B, Veitayaki J, Bola A et al (2014) Connecting the dots: policy connections between Pacific Island shipping and global CO2 and pollutant emission reduction. *Carbon Manag* 5(1):93–105
- Iese V, Holland E, Wairiu M, Havea R, Patolo S, Nishi M et al (2018) Facing food security risks: the rise and rise of the sweet potato in the Pacific Islands. *Glob Food Sec* 18:48–56

- Jayaraman TK, Choong C-K (2009) Growth and oil price: a study of causal relationships in small Pacific Island countries. *Energy Policy* 37(6):2182–2189
- Karatayev M, Rivotti P, Mourão ZS, Konadu DD, Shah N, Clarke M (2017) The water-energy-food nexus in Kazakhstan: challenges and opportunities. *Energy Procedia* 125:63–70
- Kelman I (2018) Islandness within climate change narratives of small island developing states (SIDS). *Isl Stud J* 13(1):149–166
- Levantis T (2019) Oil price vulnerability in the Pacific. *Pacific Econ Rev* 23(2):214–225
- Liu J, Yang H, Cudennec C, Gain AK, Hoff H, Lawford R et al (2017) Challenges in operationalizing the water–energy–food nexus. *Hydrol Sci J* 62(11):1714–1720
- Lowy Institute (2019) Pacific aid map. <https://pacificaidmap.lowyinstitute.org>
- Malua M, UNCTAD (2003) The Pacific Islands. UNCTAD: turning losses into gains: SIDS and Multilateral Trade Liberalisation in Agriculture. United Nations, New York and Geneva, pp 171–204
- Mani FS (2020) Estimating greenhouse gas emissions in the Pacific Island Countries. In: Singh A (ed) *Translating the Paris Agreement into action in the Pacific*. Springer, Cham, p 3–27.
- Mani SA, Mani FS, Kumar A, Shah S, Peltier RE (2020) Traffic related PM2.5 air quality: policy options for developing Pacific Island countries. *Transp Res D Transp Environ* 87:102519
- McGregor A, Bourke RM, Manley M, Tubuna S, Deo R (2009) Pacific island food security: situation, challenges and opportunities. *Pacific Econ Rev* 24(2):24–42
- McGregor A, Fink A, Dawson B (2016) Implications of climate change for contributions by agriculture and forestry to Pacific Island economies and communities. In: Taylor M, McGregor A, Dawson B (eds) *Vulnerability of Pacific Island agriculture and forestry to climate change*. Pacific Community (SPC), pp 447–482
- McLeod E, Bruton-Adams M, Förster J, Franco C, Gaines G, Gorong B et al (2019) Lessons from the Pacific Islands—adapting to climate change by supporting social and ecological resilience. *Front Mar Sci* 6:289
- Michalena E, Hills JM (2018) Paths of renewable energy development in small island developing states of the South Pacific. *Renew Sust Energy Rev* 82:343–352
- Michalena E, Kouloumpis V, Hills JM (2018) Challenges for Pacific Small Island developing states in achieving their nationally determined contributions (NDC). *Energy Policy* 114:508–518
- Mirti AV, Davies S (2005) Drinking water quality in the Pacific Island countries: situation analysis and needs assessment. Pacific Data Hub
- Molle F (2008) Nirvana concepts, narratives and policy models: insights from the water sector. *Water Altern* 1(1):131–156
- Müller-Mahn D, Gebreyes M (2019) Controversial connections: the water-energy-food nexus in the Blue Nile basin of Ethiopia. *Land* 8(9):135
- Narayan PK, Narayan S, Prasad A (2008) Understanding the oil price-exchange rate nexus for the Fiji islands. *Energy Econ* 30(5):2686–2696
- Nauditt A (2018) Discussion of “Challenges in operationalizing the water–energy–food nexus.” *Hydrol Sci J* 63(12):1866–1867
- Newell A, Nuttall P, Prasad B, Veitayaki J (2017) Turning the tide: the need for sustainable sea transport in the Pacific. *Mar Policy* 75:249–259
- Nuttall P, Newell A, Prasad B, Veitayaki J, Holland E (2014) A review of sustainable sea-transport for Oceania: providing context for renewable energy shipping for the Pacific. *Mar Policy* 43:283–287
- Oberler FKJ, Swarzenski PW, Storlazzi CD (2017) Atoll groundwater movement and its response to climatic and sea-level fluctuations. *Water* 9(9):650
- Piessé M (n.d.) Climate change threats to food and water security on Pacific atolls. *Future Dir Int Popkin BM* (2006) Global nutrition dynamics: the world is shifting rapidly toward a diet linked with noncommunicable diseases. *Am J Clin Nutr* 84(2):289–298
- Prasad A, Narayan PK, Narayan J (2007) Exploring the oil price and real GDP nexus for a small island economy, the Fiji Islands. *Energy Policy* 35(12):6506–6513

- Purwanto A, Sušnik J, Suryadi FX, de Fraiture C (2019) Using group model building to develop a causal loop mapping of the water-energy-food security nexus in Karawang Regency, Indonesia. *J Clean Prod* 240:118170
- PWWA (2020) Benchmarking report 2020: Pacific Water and Wastewater Association 10 years of performance improvement recorded (2009–2019)
- Radtke K (2019) World risk report 2019. In: Bündnis Entwicklung Hilft/IFHV (eds). https://weltrisikobericht.de/wp-content/uploads/2019/09/WorldRiskReport-2019_Online_english.pdf
- Radtke K (2020) World risk report 2020. https://weltrisikobericht.de/wp-content/uploads/2020/12/WRR_2020_online_.pdf
- Rosegrant M, Valmonte-Santos RA, Thomas T (2015) Climate change, food security, and socioeconomic livelihood in Pacific Islands. Asian Development Bank
- Salem S (2020) Climate change and the sinking island states in the Pacific. *E-International Relations*
- Seidel H, Lal PN (2010) Economic value of the Pacific Ocean to the Pacific Island countries and territories. IUCN, Gland, Switzerland, p 74
- Simpson GB, Jewitt GPW (2019) The development of the water-energy-food nexus as a framework for achieving resource security: a review. *Front Environ Sci* 7(8)
- Singh A (2017) Historical analysis of change in rainfall, flow regime and river morphology [Case study: Zambezi Delta]. UNESCO-IHE Institute for Water Education, Delft
- Singh A (2019) The sustainable development of Fiji's energy infrastructure: a status report. *Pacific Econ Rev*
- SOPAC (2004) An overview of integrated water resources management in Pacific Island Countries: a National and Regional Assessment SOPAC miscellaneous report 554
- SOPAC (2011) Freshwater under threat—Pacific Islands Report
- SPC (2017) Pacific fuel imports
- Stewart R (2006) An economic survey of developing countries in the Pacific region. *Economic Round-Up*, Spring 2006, 91–115
- Taniguchi M, Endo A, Gurdak JJ, Swarzenski P (2017) Water-energy-food nexus in the Asia-Pacific region. *J Hydrol Reg Stud* 11:1–8
- UN Geospatial (2023) Map of the World. Copyright United Nations. <https://www.un.org/geospatial/content/map-world-1>
- Weitz N, Strambo C, Kemp-Benedict E, Nilsson M (2017) Closing the governance gaps in the water-energy-food nexus: insights from integrative governance. *Glob Environ Change* 45:165–173
- White I, Falkland T (2010) Management of freshwater lenses on small Pacific islands. *Hydrogeol J* 18(1):227–246
- Wiegleb V, Bruns A (2018) What is driving the water-energy-food nexus? Discourses, knowledge, and politics of an emerging resource governance concept. *Front Environ Sci* 6(128). <https://doi.org/10.3389/fenvs.2018.00128>
- World Bank (2020) World development indicators. <https://data.worldbank.org/indicator/>

The opinions expressed in this chapter are those of the author(s) and do not necessarily reflect the views of the UNESCO: United Nations Educational, Scientific and Cultural Organization, its Board of Directors, or the countries they represent.

Open Access This chapter is licensed under the terms of the Creative Commons Attribution-ShareAlike 3.0 IGO License (<https://creativecommons.org/licenses/by-sa/3.0/igo/>), which permits use, sharing, adaptation, distribution, and reproduction in any medium or format, as long as you give appropriate credit to the UNESCO: United Nations Educational, Scientific and Cultural Organization, provide a link to the Creative Commons licence and indicate if changes were made. If you remix, transform, or build upon this book or a part thereof, you must distribute your contributions under the same licence as the original.

The use of the UNESCO: United Nations Educational, Scientific and Cultural Organization's name, and the use of the UNESCO: United Nations Educational, Scientific and Cultural Organization's logo, shall be subject to a separate written licence agreement between the UNESCO: United Nations Educational, Scientific and Cultural Organization and the user and is not authorized as part of this CC-IGO licence. Note that the link provided above includes additional terms and conditions of the licence.

The images or other third party material in this chapter are included in the chapter's Creative Commons licence, unless indicated otherwise in a credit line to the material. If material is not included in the chapter's Creative Commons licence and your intended use is not permitted by statutory regulation or exceeds the permitted use, you will need to obtain permission directly from the copyright holder.



Part IV
An Integrated Approach

Chapter 16

Nexus as a Lens for SDG Implementation



Natalie Degger, Christian Severin, and Vladimir Mamaev

Tackling the food-water-energy and ecosystem nexus in the Pacific through an ecosystem-based approach known as Ridge to Reef.

Abstract Water is profoundly linked to the development and sustainability of all nations. It forms a natural connection across the Sustainable Development Goals, all sectors of the nexus, and even between countries. The Global Environment Facility (GEF) International Waters focal area realizes that the water, energy, and food nexus can be both a source of tension and an entry point for cooperation. The GEF works with island countries to tackle the nexus through an ecosystem-based approach known as Ridge to Reef (R2R). This chapter highlights some of the practical on-the-ground solutions demonstrated by national projects and how the GEF-UNDP Pacific Ridge to Reef Programme is creating entry points for enabling the water, energy, and food nexus that are aligned with the Sustainable Development Goal outcomes.

Keywords International Waters · IWRM · Transboundary · Ridge to Reef · Nexus · SDGs · Global Environment Facility

N. Degger (✉)

International Waters Learning Exchange And Resources Network (IW:LEARN),
Intergovernmental Oceanographic Commission of UNESCO (IOC-UNESCO),
Marine Policy and Regional Coordination Section, 7 Place de Fontenoy, 75352 Paris, France
e-mail: natalie@iwlearn.org

C. Severin

Global Environment Facility (GEF), Washington, DC, USA

V. Mamaev

United Nations Development Programme (UNDP), Istanbul, Turkey

© UNESCO 2024

A. Dansie et al. (eds.), *The Water, Energy, and Food Security Nexus in Asia and the Pacific*, Water Security in a New World,
https://doi.org/10.1007/978-3-031-25463-5_16

361

16.1 Introduction

16.1.1 Water-Energy-Food-Ecosystem Nexus And the Sustainable Development Goals

Adopted by Member States in 2015, the 2030 Agenda for Sustainable Development provides a shared blueprint for peace and prosperity for people and the planet. At its core are the 17 Sustainable Development Goals (SDGs) which are an urgent call for action for a global partnership to end poverty, improve health and education, reduce inequality, and stimulate economic growth while simultaneously tackling climate change and preserving our natural environment (United Nations 2014). Achieving the SDGs requires all relevant stakeholders to work together and manage the synergies and trade-offs among different management or governance sectors including food, health, water, and energy (Rockström 2016). Balancing the trade-offs between immediate human needs and preserving ecosystems which provide critical functions requires integrated approaches and tools to achieve the SDGs successfully. Furthermore, for governments to manage these resources sustainably there needs to be a greater understanding and control of the dynamics linking policy decisions at the basin, local, regional, and national levels (Roidt and Strasser 2015). Ecosystem-based management, valuation of ecosystem services, natural capital, and integrated water resources management are approaches that have been developed to address these issues and can assist in the achievement of the SDGs (Liu et al. 2018). By emphasizing the importance of understanding synergies, connections, and trade-offs the concept of the water-food-energy-ecosystem nexus builds on and compliments these approaches (Liu et al. 2018).

Water is essential for all life and forms a natural connection across all sectors of the nexus and even between countries. It provides stability to ecosystems, is the underlying resource for the production of energy and food and is critical to peace and security (Roidt and Strasser 2015). Food as a component of the nexus includes the agricultural sector with sectoral priorities such as sustainable and climate smart value chains, sustainable and efficient water use, management of competing land usage, and sustainably meeting the sectors energy needs (Roidt and Strasser 2015). Sustainable development of energy sources could address trade-offs and should result in environmental benefits such as reduction of greenhouse gas emissions, mitigation of climate change, and reduced water demand (Roidt and Strasser 2015). Water, energy, and food are dependent on proper ecosystem functioning. Without this, the various sectors cannot attain freshwater for use, exploit valuable sources of energy, use them as sinks for pollution, and profit from them in agriculture (Roidt and Strasser 2015). While nexus efforts have mainly focused on terrestrial and freshwater ecosystems, marine ecosystems are also pivotal in providing food, energy, and other ecosystem services. While the trade-offs and synergies are still emerging, marine ecosystems play a vital role in contributing towards food security (fisheries and aquaculture), freshwater security (desalination), energy production (wave, tidal, and wind energy; offshore oil

and gas), and ecosystem services (weather and climate regulation, cultural services, economic activity, primary production) (Liu et al. 2018).

By their very nature, the SDGs have been designed to be interconnected such that action taken with regard to one of these goals is likely to have implications on one or more of the other goals. Thus, increasing evidence suggests that the water-food-energy-ecosystem nexus approach can influence the achievement of the SDGs both directly and indirectly (Fig. 16.1).

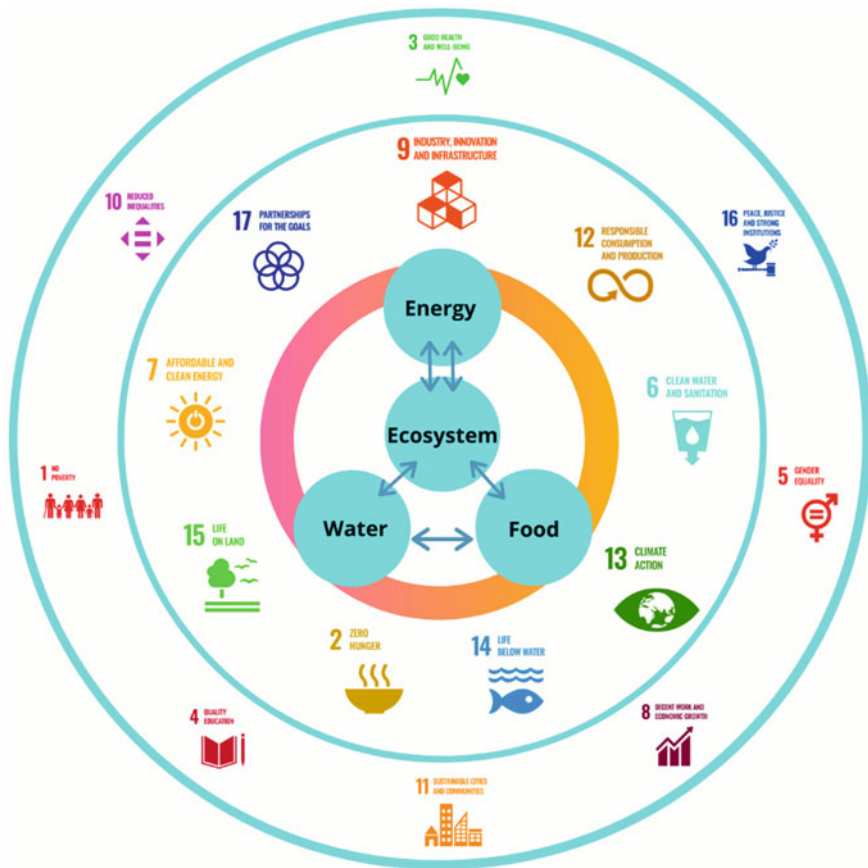

Fig. 16.1 The sustainable development goals are directly or indirectly influenced by the water-food-energy-ecosystem nexus approach. Image adapted from Liu et al. (2018) and the UNECE Water Convention “A nexus approach to transboundary cooperation: The experience of the Water Convention” publication (2018)

16.1.2 Financing Nexus Solutions: The Global Environment Facility

The Global Environment Facility (GEF) emerged from the 1992 United Nations Conference on Environment and Development (Rio Earth Summit) as the key financial mechanism for the global environment. The GEF's first operational strategy would establish partnerships among United Nations Agencies, the international environment conventions, and the participating countries, which were necessary to tackle urgent global environmental concerns. This strategy also placed priority on development of monitoring and evaluation approaches to support the capture and sharing of lessons learned from investments. This initially involved definition of overarching objectives and result areas for focal areas including biological diversity, climate change, and international waters. These were further elaborated in a suite of related operational programs. Fundamental to this was the recognition that success of the GEF mandate required the application of innovative and experimental approaches to efforts aimed at reversing global environmental degradation trends.

16.1.2.1 Overview of the GEF International Waters (IW) Focal Area

The GEF is the largest funding mechanism for multi-country collaboration on water and oceans with 156 GEF recipient countries and 24 non-recipient countries working together to manage their transboundary water resources. The GEF International Waters (IW) focal area has a unique mandate to support transboundary cooperation in shared water bodies including rivers, lakes, aquifers, and large marine ecosystems (for Small Island Developing States (SIDS), the specific GEF IW approach is elaborated on in Sect. 16.2.1.1). Actions of this support include the conduct of a Transboundary Diagnostic Analysis to identify environmental concerns for shared water bodies; the formulation of a Strategic Action Programme to address priority transboundary concerns; and technical assistance, capacity building, and demonstration and pilot activities. This focus on transboundary concerns naturally leads to emphasis on multi-country projects, often in areas characterized by significant geo-political tensions. Such projects have invested considerably in efforts to build trust and capacity to manage shared resources among the participating countries in working together to plan and implement actions aimed at reversing environmental degradation trends. Success has largely been measured on the effectiveness of investments in securing the highest levels of political commitment and financial support for the required policy and legal reforms and actions to address a diverse range of transboundary issues associated with habitat degradation and loss, over-exploitation of fish stocks, land-based pollution, and securing shared freshwater resources.

16.1.2.2 The GEF Strategy And Nexus

In shared basins, cooperation can assure greater water, energy, food, and ecosystems security compared to unilateral development options. Enhanced economic ties and multi-level interactions among countries sharing a basin/sub-region lessen the likelihood of conflict. The GEF IW focal area realizes that the water-energy-food-ecosystems nexus dimensions can be both a source of tension and an entry point for cooperation. The GEF-7 Investment (2018–2022) specifically addresses the inclusion of the ecosystem dimension into the GEF Topic “Water, Energy, Land, and Ecosystem Nexus” (hereafter the water-energy-food-ecosystem nexus) and increasing environmental security. GEF-7 Investments in the water, energy, land, and ecosystem nexus supports supply chain approaches, water efficiency, de-risk innovation, nature-based approaches, protecting and rehabilitating aquatic ecosystems, establishing minimum environmental flows, sustaining freshwater fisheries and aquaculture, and supporting fragile/conflict affected countries. The business of water is complex as it cuts across multiple economic sectors (Global Environment Facility 2020a). Both the quality and quantity of water resources have to be addressed taking into account the entire water-energy-food-ecosystem nexus to ensure that sustainability is achieved across the whole system from the source to the ocean (Global Environment Facility 2020b). These “Source-to-Sea” linkages are engrained in the GEF IW portfolio, as surface water eventually impacts the integrity of coastal habitats with knock-on effects in spawning grounds, livelihoods of coastal populations, and ultimately the wider ocean that captures all the impacts from land-based activities (Global Environment Facility 2020b).

Realizing the increase in demand on water, food, energy, and ecosystem services, the GEF engages in integrated approaches across sectoral and focal area dimensions to help achieve the SDGs and sustainable use of resources on a global, regional, national, and local scale.

16.2 The Nexus Approach Through the GEF IW Portfolio: Global Perspective

The GEF in partnership with the United Nations Industrial Development Organization (UNIDO) and the International Institute for Applied Systems Analysis (IIASA) have been engaging in the Integrated Solutions for Water, Energy, and Land (ISWEL) project that explored cost effective solutions to jointly meet water, land, and energy demands under different development and climate pathways. While this project zooms in on two large transboundary basins (the Zambezi and Indus), it also took a global approach where tools and methodologies have been developed which are transferrable to other regions, potentially including SIDS.

The economic, social, and environmental systems of SIDS are highly vulnerable due to their characteristically small size, high population density, remoteness,

vulnerability to external effects, narrow resource base, and exposure to global environmental challenges such as climate change (UNEP 2014). Given these tremendous challenges, the water-energy-food-ecosystems nexus approach could be particularly beneficial for achieving and embedding sustainability in SIDS.

16.2.1 The Nexus Approach Through the GEF IW Portfolio: Regional Small Island Developing States Perspectives



16.2.1.1 GEF IW and Small Island Developing States

Small Island Developing States settings differ widely from the large transboundary water systems in which the majority of GEF investments are focused. Water related issues in SIDS are rarely what are widely understood to be ‘transboundary’ in nature. The GEF strategy captured these differences by building on the 1994 Barbados Programme of Action which recognized that SIDS share common water and coastal management problems. GEF international waters projects in SIDS have therefore focused on addressing common problems shared by small island communities in the Caribbean, Pacific, and Africa. Most aspects of environmental management in SIDS are directly dependent on, or influenced by, the planning and utilization of land resources, which in turn are closely linked to coastal zone management and protection. The GEF is working with island countries to tackle the food-water-energy-ecosystem nexus through an ecosystem-based approach known as Ridge to Reef (Global Environment Facility 2017a, b). This approach is designed to reverse the degradation of coastal resources by finding ways to reduce the flow of untreated wastewater, chemicals, nutrients and sediments from land-based agriculture, forestry, and development into catchment areas. Consequently, under a Ridge to Reef approach, Integrated Water Resource Management (IWRM) and Integrated Coastal Management (ICM) plans come together to inform long-term sustainable use of the natural resources while limiting the impact on the fragile environment which is further described in Table 16.1 (Global Environment Facility 2017a, b).

In total, the GEF has provided more than USD 578 million to SIDS in country allocated finance across all focal areas. In addition, SIDS participated in a significant number of regional and global projects and programs that overall totalled an additional USD 810 million.¹ GEF finance has leveraged several times that amount in additional resources for sustainable development (Global Environment Facility 2018). The current GEF 7 funding cycle (2018–2022) continues to provide strong support and an emphasis on the needs of SIDS and Least Developed Countries (LDCs). Major international conferences and agreements have supported SIDS, and their collective cooperation provides them with a powerful voice to engage at the



¹ Figures reflected in the text are derived from 2018 as observed in the Global Environment Facility publication “Small Island Developing States and the Global Environment Facility: Building Lasting Partnerships”.

Table 16.1 The GEF Pacific Ridge to Reef approach entry points for enabling the water-energy-food-ecosystem (WEFE) nexus via integrated water resources management (IWRM). Table adapted from The Pacific Integrated Water Resources Management Programme Brochure (2008)

Sector	Entry point for enabling a WEFE Nexus approach	Related SDGs
Industry	<ul style="list-style-type: none"> • Balance industrial and public water resources demands • Ensure effective industrial water use, reuse (intra- and inter-sectorial) and avoid wastage • Regulate industrial pollution to protect water resources 	
Utilities and Energy	<ul style="list-style-type: none"> • Install and maintain infrastructure for water supply and sewerage to ensure that water gets from source to intended use in good quality and sufficient quantity, and to prevent pollution from wastewater • Monitor water availability and use in order to match water supply to demand • Mitigate effects from hydropower installations on ecosystems and communities through integrated watershed management, and balance water demands for energy generation and public supply 	

(continued)

Table 16.1 (continued)

Sector	Entry point for enabling a WEF Nexus approach	Related SDGs
Fisheries and Marine	<ul style="list-style-type: none"> • Monitor effects from run-off and land-based activities on coastal ecosystem health and fisheries production • Protect important fisheries spawning and nursery areas in coastal waters and rivers 	
Agriculture and Forestry	<ul style="list-style-type: none"> • Adapt agricultural and forestry practices (species, land-use practices, and agrochemicals) to rainfall, land features, soil quality and water availability, in order to ensure efficient water use, soil conservation and reduction of run-off of sediment, nutrients, pesticides, etc 	
Environment and Planning	<ul style="list-style-type: none"> • Regulate impacts of developments on water resources (e.g., in Environmental Impact Assessments) • Consider water resources in urban, rural, and land-use planning, and minimise flooding • Include water harvesting and wastewater standards in building codes • Monitor and protect the health of water environments and create protection areas where necessary 	

global level (GEF LME:LEARN 2020). A common trait shared by SIDS are their increasing vulnerability to environmental and economic disasters. Recognizing their collective strength, SIDS have developed innovative regional management mechanisms such as the Caribbean Community, Indian Ocean Commission, and Pacific Islands Forum which are helping to address the high impact of climate change and foster resilience (GEF LME:LEARN 2020). In the Pacific, the world's largest stocks of tuna and related pelagic species falls within the national jurisdiction of 22 SIDS and overseas territories, making them the custodians of a major international waters ecosystem (Degger et al. 2021). Their strong cooperation, with support of the GEF funded Pacific Islands Oceanic Fisheries Management Project implemented by the United Nations Development Programme (UNDP) and managed by the Pacific Island Forum Fisheries Agency (FFA), led to the negotiation of the Western and Central Pacific Fisheries Convention and a Commission for the sustainable use and long-term conservation of these significant fish stocks (GEF PIOFMP 2022).

16.2.1.2 Water, Energy, and Food Nexus: A Caribbean Perspective

If necessity is the mother of invention, then the Caribbean should be way ahead of the curve when it comes to the WEF Nexus (Cashman personal communication). Electricity generation has relied on fossil fuel imports that have placed a heavy demand on foreign currency reserves and prices have been high. The Caribbean is a net importer of food, some 80% is imported and in most countries, agriculture's contribution to economies continues to decline. Water too is becoming problematic with seemingly increasing frequency of drought conditions affecting water supplies (Cashman personal communication). However, the use of renewable energy has doubled in the last five years; some are developing geothermal power whilst others, solar power with the aim of transitioning to 100% renewables. This is good news for the water sector, which is one of the biggest users of power (Cashman personal communication). Lower power costs will benefit both energy and water consumers including the ability to provide for those with affordability or access difficulties. Indeed, some water utilities are looking to become power producers themselves, cutting their electricity costs and reinvesting the savings in upgrading their infrastructure to reduce water losses. Another example is the use of thin film solar panels as greenhouse covering and the harvesting of rainwater off the panels (Cashman personal communication). The rainwater is used to water plants whilst the power generated is used to cool the greenhouse and runs the computerized irrigation system, producing high value crops for the local market, which would otherwise have to be imported. Such developments are opening up new markets and opportunities and attracting youth into agriculture (Cashman personal communication).

16.2.1.3 Water, Energy, and Food Nexus: A Pacific Perspective

In SIDS the land, water, and coastal ecological systems are closely inter-connected. Pacific Island Countries have uniquely fragile water resources due to their small size, lack of natural storage, competing land use, and vulnerability to natural hazards. In most Pacific countries, even small variations in water supply can have a significant impact on health, quality of life, and economic development. Recognizing this connectivity is key to fostering effective cross-sectoral coordination in the planning and management of land, water, forest, and coastal uses by integrating freshwater watershed management with coastal area management. This integrated approach to freshwater and coastal area management have been termed ‘Ridge to Reef’ to emphasize the inter-connections between the natural and social systems from the mountain ‘ridges’ of volcanic islands, through coastal watersheds and habitats, and across coastal lagoons to the fringing ‘reef’ environments. For low-lying atolls and islands, the same concept of Ridge to Reef is the entire land-sea interface and with specific connectivity across land, water, and coastal areas. Inherent in the approach is the philosophy of cross-sectoral coordination in the planning and management of freshwater use, sanitation, wastewater treatment and pollution control, sustainable land use and forestry practices, balancing coastal livelihoods and biodiversity conservation, hazard risk reduction, and climate variability and change. Similarly, the integration of communities, stakeholders, and national governments within such a cross-sectoral planning framework is described by Pacific SIDS as a ‘Community to Cabinet’ approach.

Water resource and wastewater management is a key element of efforts to fashion sustainable futures for Pacific SIDS (Paterson personal communication). Generally, limited surface and groundwater water resources (see Chap. 2) and a reliance on rain fed agriculture results in island livelihoods and economies being highly dependent on rainfall (Paterson personal communication). In addition to the reliance of Pacific SIDS on the effective use and management of rainwater, coastal, and marine habitats² resources are also critically important to islands (Paterson personal communication). Pacific SIDS, however, face considerable challenges in guiding the sustainable use of these resources and achieving interlinked SDG target due to the close linkages between and among land, water, and coastal systems on small islands (Paterson personal communication).

16.2.1.4 GEF Pacific Ridge to Reef Programme

The Heads of States of 13 Pacific SIDS developed and, in 1997, endorsed a GEF International Waters Strategic Action Programme (SAP) for Pacific Island Countries. The document identified priority areas for action in the international waters

² Coastal coral reefs, seagrass, and mangrove forests are hereafter referred to collectively as ‘blue forests’.

focal area as improved management of ocean and coastal fisheries, integrated watershed and coastal management, and water supply protection. On the basis of the Pacific SAP, the GEF International Waters focal area has subsequently invested in a series of regional initiatives. The first was the UNDP implemented project titled “*Implementation of the Strategic Action Program for the International Waters of the Pacific Small Island Developing States*” initiated between 2000 and 2006. GEF support in the years following the conclusion of the IW project has been targeted at improved coordination and planning of water resource and wastewater management to balance overuse and conflicting uses of scarce freshwater resources through the GEF Pacific IWRM Project. The latter was financed by the GEF, implemented by UNDP and United Nations Environment Programme (UNEP), and executed regionally by the Geoscience Division of the Pacific Community (SPC) in partnership with 14 Pacific Island Countries (GEF Pacific Ridge to Reef Programme 2020).

The experience and local capacity in integrated environmental and natural resource management generated through the GEF Pacific IWRM project has been recognized both regionally and within the 14 participating Pacific Island Countries as an appropriate entry point for the testing of innovative approaches and measures to integrate land, forest, water, and coastal management, including climate change adaptation in Pacific SIDS. The GEF Pacific IWRM Project built on achievements of the International Waters Project (IWP) via a focus on national IWRM demonstration projects aimed at providing an opportunity to participating countries to implement, and experiment with, new management models and methods. The national projects built local experience and capacity in project implementation, cross-sectoral coordination, and the conduct of water resource and socio-economic assessments and studies needed to contribute to more sustainable management of water resources. From this, the knowledge, experiences and best practices generated through project execution were captured, shared, and used to guide the development of national water and sanitation policies and IWRM plans. The practical on-the-ground solutions to water and sanitation issues demonstrated by the national IWRM projects acted to simulate support at both community and national government levels for policy reform and the mainstreaming of an IWRM approach as part of national development planning. Key anticipated outputs of this process are national IWRM Plans to guide full-scale IWRM (Paterson personal communication).

As a result, the GEF multi-focal area, multi-GEF agency \$90 million programme titled “*Pacific Islands Ridge-to-Reef National Priorities – Integrated Water, Land, Forest and Coastal Management to Preserve Biodiversity, Ecosystem Services, Store Carbon, Improve Climate Resilience and Sustain Livelihoods*” or GEF Pacific R2R Programme, was developed (Fig. 16.2). This programme provides an opportunity for Pacific SIDS to develop and implement truly integrated approaches for the sustainable development of island economies and communities (GEF Pacific Ridge to Reef Programme 2020). A “whole of ecosystem” and “whole of island” approach ensures that policy, multiple sectors, agencies, and community interests are properly considered and integrated in the planning and management of resources. This also includes increasing attention to gender perspectives and ensuring that measures are taken so

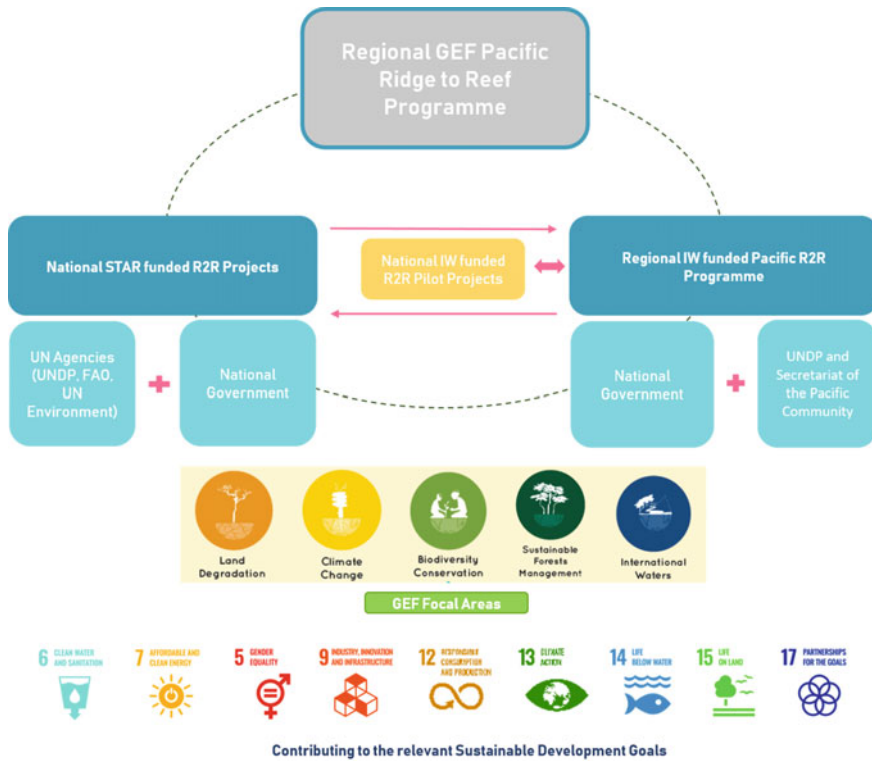

Fig. 16.2 The programmatic approach of the Regional GEF funded Pacific Ridge to Reef programme. Image adapted from the Pacific Ridge to Reef “How we operate” infographic (Pacific Ridge to Reef 2020)

that decision-making is reached through the participation of men and women as per the GEF Policy on Gender Equality Global Environment Facility (2017b).

As part of the project, participating countries have the opportunity to strengthen their capacity to successfully demonstrate and transfer technology to support targeted vulnerable areas, improve livelihoods and public health, and upscale their effective mainstreaming efforts to support countries in achieving their sustainable development goals.

In this programme, the Pacific Island Countries emphasize the need to focus on their own priority national activities as they utilize System for Transparent Allocation of Resources (STAR) resources. Experience has shown that an integrated approach from ridge to reef is necessary for poverty reduction, sustainability, and capacity enhancement for small countries with few human resources to undertake projects. The national demonstration projects have produced direct local environmental results and benefits, and health co-benefits, from changes in practice. The examples below highlight the results of the approach.

Federated States of Micronesia (FSM): National Perspective

The Federated States of Micronesia (FSM) consist of four major island groups with over 600 islands in the northern Pacific. These vary geographically from high mountainous islands to low lying coral atoll and volcanic outcroppings on Pohnpei, Kosrae, and Chuuk (Federated States of Micronesia National R2R Programme 2020). About 60% of water resources in FSM exist as surface water in the form of small, intermittent streams that drain catchment areas of limited aerial extent and are dry for about 20% of the year. The topography in the stream basins is not conducive to the construction of economical dams and requires extensive and costly treatment. The remaining 40% of the islands' water resources exist as groundwater. Many households use roof catchments, which are particularly prevalent in the outer islands where there is no piped water (Federated States of Micronesia National R2R Programme 2020). All of the four focal islands have coastal mangrove fringes and development is largely focused on the coast with minimal interior development. The natural vegetative cover is dense on all islands and has not generally been disrupted for intensive agriculture use (Federated States of Micronesia National R2R Programme 2020).

The objective of the first GEF IWRM demonstration project in FSM (operational 2009–2014) was the improvement of drinking water quality and significant reduction in pollutants entering fresh and marine water around Pohnpei and Chuuk States. Significant progress in strengthening national coordination between the water and sanitation sector and development of a National Water and Sanitation Policy and IWRM Plan was achieved through the project. This was in part enabled via the conduct of a FSM National Water Summit during which the FSM President, State Governors, and a representative of the Nation's traditional leaders signed a joint resolution establishing a National Water Task Force and endorsing a Framework National Water and Sanitation Policy. The project further supported this effort to develop an FSM National Water, Sanitation, and Climate Outlook aimed at informing national policy development and IWRM Planning. The First National Water Task Force Meeting was convened from 23 to 24 May 2012, and in addition to review and agreement on the Task Force Terms of Reference, a program for development of the National Water Policy and IWRM was discussed and agreed. This has been followed up by several State based working group meetings to consider and develop inputs to the broader National process (Shed 2014).

Under the current national GEF IWRM Micronesia project (operational 2015-present), the focus is on supporting expansion of both marine and terrestrial protected areas in all four Micronesian states, complemented by support to integrated ecosystem management and restoration outside protected areas to enhance ridge to reef connectivity. For example, Kosrae's coastal environment provides its best and most effective defence against climate related hazards. The wellbeing of coastal environment is dependent upon the degree that anthropogenic activities affect the area from Ridge through to Reef. Preservation of catchments and in particular upland areas is vital to the maintenance of quality surface and groundwater inflows to the coastal areas. Likewise, the maintenance of a quality coastal environment

offers improved sustainability for lagoonal and reef resources vital to food security (Federated States of Micronesia National R2R Programme 2020). The need to preserve and protect Kosrae's Coastal Environment has resulted in the development of a comprehensive Shoreline Management Plan, which has been endorsed by the Kosrae Government (Federated States of Micronesia National R2R Programme 2020). Some of the above issues have begun to be addressed through the cross-sectoral planning and management initiatives of the GEF Pacific IWRM Project. These include improving land use practices, reducing pathogen and nutrient contamination of ground and coastal waters, assessing Kosrae's freshwater resources, establishing community-based management of waterways and enhancing community and national level awareness of best practice in sustainable management (Federated States of Micronesia National R2R Programme 2020).

Currently the GEF STAR Ridge to Reef project (operational 2016-present) is supporting the implementation of the Pohnpei State Water Policy, which was endorsed in 2018 (Yatilman personal communication). According to the first Voluntary National Review (FSM Voluntary National Review 2019), the Federated States of Micronesia has committed to implementing Agenda 2030 at the national level and within the four island states of Kosrae, Pohnpei, Chuuk, and Yap. The country has identified 89 SDG targets, with an accompanying 90 SDG indicators, linked to the FSM Strategic Development Plan 2004–2023 (SDP). This national strategy seeks to achieve sustainable economic growth and self-reliance by prioritizing sustainable development through the sectors of health, education, agriculture, fisheries, private sector development, transportation, communication, and the cross-cutting sector of energy, many having their own policies that align to the SDP and SDGs (FSM Voluntary National Review 2019).

Fiji: National Perspective

Fiji's ecosystem services are provided by the country's diverse natural resources, ranging from terrestrial to coastal and marine ecosystems. Like many Pacific Island Countries, Fiji represents a microcosm of some of the most significant development and environmental challenges facing the world. It comprises more than 332 islands, about one-third of which are inhabited, with a total land area of 18,333 km² in a vast 1.6 million km² marine Exclusive Economic Zone (EEZ). Fiji's environment has been in a bad state, particularly for domestic water due to wastewater releases, poorly sited toilets and/or overuse of fertilizer in upstream communities and farms that pollute coastal waters, create outbreaks of disease, and contaminate sensitive groundwater supplies. The GEF has compounded its financial support to the government through the Ridge to Reef Programme in the GEF 5 STAR allocation to address some of these concerns.

The objective of the first GEF IWRM Nadi Demonstration Project was to improve flood preparedness and integrate land and water management planning within the Nadi Basin using an integrated flood risk management approach (Kumar 2012). Prior to the project inception there was no existing mechanism that could embrace

a holistic approach to address issues within the Nadi Basin. Though the political climate of Fiji made some provision under its ‘People’s Charter’, there was no basis to bring people to one table. Hence, the GEF IWRM project initiated the process of getting agencies together into a formal group (Kumar 2012). A catchment Management Committee was established and endorsed by the cabinet. Through a periodic participatory consultation process, the project activities were refined, and a monitoring and evaluation plan was endorsed. Furthermore, the process of developing an Integrated Flood Management Plan saw progress in capacity building, development and strengthening of a number of institutions in itself (Kumar 2012). Key achievements include the establishment of the Nadi Basin Catchment Committee with its four subcommittees, development of Standard Operating Procedures for Nadi Flood Warning, the establishment of 14 Community-Based Disaster Management Committees, and the development of community disaster response plans (Kumar 2012).

Currently, the GEF Operational Focal Point Portfolio for Fiji has six National Projects being implemented by UNDP in close conjunction with the Ministry of Local Government, Housing and Environment. Fiji’s GEF R2R project (operational 2015-present) focuses on enhancing integrated management of a series of forested watersheds to protect land, water, forest, and biodiversity resources, maintain carbon stocks, and protect coastal mangrove and coral reef Marine Protected Areas (MPAs).

As a nation, Fiji has adopted a ‘whole-of-Government’ approach and has utilized national development planning as the primary instrument to drive forward implementation of the SDGs (Fiji Voluntary National Review 2019). In 2017, The Fijian Government launched its National Development Plan (NDP), the outcome of a nationwide consultation process that involved the private sector, civil society, community groups, government, and the general public reflecting the aspirations of the Fijian people and their government’s commitment for a transformed Fiji (Fiji Voluntary National Review 2019). At the sector level, the SDGs have already been integrated into sectoral strategic plans and policies in many sectors including but not limited to education, health, and agriculture (Fiji Voluntary National Review 2019). Fiji also recognizes that, while government holds the important responsibility for achieving the SDGs, it is in everyone’s interest and everyone’s responsibility including private individuals, private enterprises, NGOs, and CSOs to advance the sustainable development agenda (Fiji Voluntary National Review 2019).

Samoa: National Perspective

Samoa consists of two main islands, Upolu and Savaii, and seven islets. Of the population of 180,000 people, approximately two thirds live on Upolu, and of them approximately 40,000 live in the capital Apia. Not surprisingly the land use in and around Apia is greatly modified from its natural state, with urban development in the coastal plain and low foothills, and peri-urban development and commercial agriculture in the watersheds.

The objective of the GEF IWRM national project (operational 2009–2014) in Samoa was to rehabilitate and manage the Apia Catchment in a sustainable manner in order to improve the quality and quantity of the water resources for enhanced water supply, hydropower generation, social-economic advancement and reduced environmental adverse impacts. The focus of the project was on identifying and rehabilitating vulnerable areas upstream of rivers and it is enforced by the endorsement of catchment Watershed Management Plans as directed by the Water Resources Act (Semisi 2014). The IWRM Stakeholders consultation process developed by the project brought benefits for water resource and catchment management with continuous attendance from many stakeholders, each contributing feedback on, and suggestions for the project activities (Semisi 2014). Participation of stakeholders in planning and monitoring has increased ownership over IWRM concepts and activities. An important result of this was agreement on the Watershed Safety plan for Fuluasou, and actions for dealing with the many issues around its intake and supply had been identified and prioritized for implementation (Semisi 2014). This is significant as Fuluasou Treatment Plan supplies 70,000 people and suffers from many problems such as overcapacity, shortage of chlorine, pump failure, and high non-revenue water (NRW) rates. Watershed Management Plans (WMPs) for Loimata o Apaula, Gasegase, and Fuluasou catchments (3 of the 4 catchments in the Apia Catchment) were also drafted for management approval (Semisi 2014). The WMPs give authority to the Water Resources Division to enforce specified directives and prosecute any illegal activities. These efforts were supported by awareness and education activities on World Water Day annually and have been successful in raising the profile and visibility of GEF Pacific IWRM Samoa (Semisi 2014). Led by the GEF IWRM project, the Watershed Conservation Policy (where the top 600 m of the country land are excluded from any developments) brought positive feedback from some sectors especially the Water Authority who were struggling to accommodate for the water demands of people living on the highland (Semisi 2014).

For the current GEF IWRM project (operational 2015-present), a consultative Hot Spot Analysis identified the Apia Catchment as the demonstration site because of the severe degradation and serious water quality issues. Water and energy demand is increasing with population wealth, and despite considerable effort in water demand management measures, including metering, leakage detection and repair, tariff incentives and conservation awareness campaigns, per capita consumption of water and power are predicted to rise (Samoa National R2R Programme 2020).

Samoa has undertaken their second Voluntary National Review (VNR) to assess the progress on implementation of the SDGs. Since the first report, Samoa has improved integration of the SDGs into national processes for better data collection, monitoring and evaluation, development assistance and other international obligations (Samoa 2nd Voluntary National Review 2020). The second VNR reports near universal access of the population to safe drinking water, sanitation, and electricity services; however, the challenge is to maintain and improve the quality of water and sanitation and ensure more clean energy consumption. Overall, there is low level of extreme hunger and undernourishment, but nutrition security is a concern. One in five people are considered moderately food insecure with 2.4%

of people considered severely food insecure. The challenge in Samoa is access to and affordability of locally produced healthy foods especially when there is ready access to cheaper processed food-imports often of lower nutritional value (Samoa 2nd Voluntary National Review 2020).

16.3 Conclusion

With the completion of the first GEF Pacific IWRM project in 2015, a foundation was built which paved the way for Pacific Island Countries to address their environmental issues more holistically by employing the Ridge to Reef approach that facilitates a water, energy, and food nexus framework at a basin level. Significant emphasis is placed on national demonstration projects with the aim of providing an opportunity for participating countries to implement and experiment with management models and methods. When considering the inter-relationships between water, food, energy, and the environment, the Ridge to Reef approach starts with the water resource. While the nexus approach seeks to look at all the elements as an interrelated system, when confronted with data, modelling, governance, and capacity constraints this becomes a hugely challenging task for developing countries to undertake. The practical on-the-ground solutions demonstrated by the national projects have galvanized support at both the community and national government levels for policy reform and mainstreaming the Ridge to Reef approach as part of national development planning. This has created valuable entry points for strengthening cross-cutting, cross-sectoral, integrated approaches to resource management across the Pacific SIDS which are aligned to the SDG outcomes.

References

- Cook Islands National R2R Programme (2020) Cook Islands National R2R Programme Document. Accessed July 2020 from <https://www.pacific-r2r.org/sites/default/files/2020-03/Cook%20Islands.pdf>
- Degger N, Hudson A, Mamaev V, Hamid M, Trumbic T (2021) Navigating the complexity of regional ocean governance through the large marine ecosystems approach. *Front Mar Sci* 8. <https://doi.org/10.3389/fmars.2021.645668>
- Federated States of Micronesia National R2R Programme (2020) Federated States of Micronesia National R2R Programme Document. Accessed July 2020 from <https://www.pacific-r2r.org/sites/default/files/2020-03/FSM.pdf>
- Fiji Voluntary National Review (2019). Accessed July 2020 from <https://sustainabledevelopment.un.org/index.php?page=view&type=30022&nr=1162&menu=3170>
- FSM Voluntary National Review (2020). Accessed July 2020 from https://sustainabledevelopment.un.org/content/documents/26668VNR_2020_Micronesia_Report.pdf
- GEF LME:LEARN (2020) Small island developing states: addressing SIDS vulnerabilities through regional cooperation. Accessed 7 Feb 2022 from <https://iwlearn.net/resolveuid/a18fce43-4aa7-48be-beb6-790f8fa20339>

- GEF Pacific Ridge to Reef Programme (2020) History of R2R. Accessed July 2020 from <https://www.pacific-r2r.org/history-r2r>
- GEF PIOFMP (2022) Pacific Islands oceanic fisheries management project. Accessed 8 Feb 2022 from <https://iwlearn.net/documents/33502>
- Global Environment Facility (2017a) Small island developing states and the global environment facility: building lasting partnerships. Accessed Aug 2020 from <https://www.thegef.org/sites/default/files/publications/GEF%20and%20SIDS%202017a.pdf>
- Global Environment Facility (2017b) Policy on gender equality. Accessed 7 Feb 2022 from https://www.thegef.org/sites/default/files/council-meeting-documents/EN_GEF.C.53.04_Gender_Policy.pdf
- Global Environment Facility (2018) Small island developing states and the global environment facility: building lasting partnerships. Accessed July 2020 from <https://www.thegef.org/publications/small-island-developing-states-and-gef-building-lasting-partnerships>
- Global Environment Facility (2020a) Energy, food, water and ecosystem nexus. Accessed July 2020a from <https://www.thegef.org/topics/energy-food-water-and-ecosystem-nexus>
- Global Environment Facility (2020b) From source to sea: embracing the complexity of international waters work. Accessed August 2020b from <https://www.thegef.org/news/source-sea-embracing-complexity-international-waters-work>
- Kumar V (2012) Integrated flood risk management in the Nadi River Basin: a GEF IW results note. Accessed August 2020 from <https://iwlearn.net/resolveuid/5b99cb7b71d077d9b1cc5256722d5166>
- Liu J, Hull V, Godfray HCJ, Tilman D, Gleick P, Hoff H et al (2018) Nexus approaches to global sustainable development. *Nat Sustain* 1(9):466–476. <https://doi.org/10.1038/s41893-018-0135-8>
- Pacific Ridge to Reef (2020) How we operate. Accessed August 2020 from <https://www.pacific-r2r.org/how-we-operate>
- Rockström J (2016) Future earth. *Science* 351:319. <https://doi.org/10.1126/science.aaf2138>
- Roidt M, Strasser L (2015) Methodology for assessing the water-food-energy-ecosystem nexus in transboundary basins and experiences from its applications. United Nations Economic Commission for Europe, pp 8–10
- Samoa National R2R Programme 2020, Samoa National R2R Programme Document. Accessed July 2020b from <https://www.pacific-r2r.org/partners/member-countries/samoa>
- Samoa 2nd voluntary national review report for implementation of sustainable development goals. Accessed July 2020 from <https://sustainabledevelopment.un.org/index.php?page=view&type=30022&nr=2085&menu=3170>
- Semisi ST (2014) Rehabilitation and sustainable management of the Apia catchment. A GEF IW results note. Accessed August 2020 from <https://iwlearn.net/resolveuid/a123caf0c0857653469b0e9916191b34>
- Shed PK (2014) Ridge to reef. Protecting water quality from source to sea-FSM. A GEF IW results note. Accessed August 2020 from <https://iwlearn.net/resolveuid/178b65d6486d8f605d054ebe03265f88>
- The Pacific Integrated Water Resources Management Programme (2008) brochure. Accessed August 2020 from <https://iwlearn.net/documents/32908https://iwlearn.net/resolveuid/aa05911f-48d6-4c1d-a12d-acc0d1c46765>
- United Nations Economic Commission for Europe (UNECE) (2018) A nexus approach to transboundary cooperation: the experience of the Water Convention. Accessed July 2020 from https://unece.org/sites/default/files/2021-01/ece_mp.wat_none_12_Summary_Brochure_Nexus_Final-rev2_forWEB.pdf
- United Nations Environment Programme (UNEP) (2014) Emerging issues for small island developing states. Results of the UNEP/UN DESA foresight process. United Nations Environment Programme, Nairobi, Kenya
- United Nations (2014) Introduction and proposed goals and targets on sustainable development for the post 2015 development agenda. Accessed July 2020 from <http://sustainabledevelopment.un.org/content/documents/4528zerodraft12OWG.pdf>

The opinions expressed in this chapter are those of the author(s) and do not necessarily reflect the views of the UNESCO: United Nations Educational, Scientific and Cultural Organization, its Board of Directors, or the countries they represent.

Open Access This chapter is licensed under the terms of the Creative Commons Attribution-ShareAlike 3.0 IGO licence (<https://creativecommons.org/licenses/by-sa/3.0/igo/>), which permits use, sharing, adaptation, distribution, and reproduction in any medium or format, as long as you give appropriate credit to the UNESCO: United Nations Educational, Scientific and Cultural Organization, provide a link to the Creative Commons licence and indicate if changes were made. If you remix, transform, or build upon this book or a part thereof, you must distribute your contributions under the same licence as the original.

The use of the UNESCO: United Nations Educational, Scientific and Cultural Organization's name, and the use of the UNESCO: United Nations Educational, Scientific and Cultural Organization's logo, shall be subject to a separate written licence agreement between the UNESCO: United Nations Educational, Scientific and Cultural Organization and the user and is not authorized as part of this CC-IGO licence. Note that the link provided above includes additional terms and conditions of the licence.

The images or other third party material in this chapter are included in the chapter's Creative Commons licence, unless indicated otherwise in a credit line to the material. If material is not included in the chapter's Creative Commons licence and your intended use is not permitted by statutory regulation or exceeds the permitted use, you will need to obtain permission directly from the copyright holder.



Chapter 17

UNESCO-Designated Sites in the Pacific



Hans Dencker Thulstrup

UNESCO-designated sites serve as models for sustainable human living and nature conservation.

Abstract UNESCO-designated sites—Biosphere Reserves, World Heritage sites, and UNESCO Global Geoparks—represent a multi-tier commitment by UNESCO, national governments, local authorities, and communities towards the protection of natural and cultural heritage as well as to the development and sharing of innovative approaches to sustainable development. In the Pacific, the establishment of UNESCO-designated sites over the past two decades has intersected in multiple ways with the vast array of local and indigenous knowledge systems and practices governing and guiding the relationship between people and their environment. With specific reference to water, energy, and food, this chapter examines the role and functions of UNESCO-designated sites in Pacific Island Countries and Territories (PICTs), their engagement with local and indigenous knowledge and practices, as well as with existing protected area initiatives.

Keywords Biosphere Reserves · World Heritage sites · UNESCO Global Geoparks · UNESCO · Pacific Island · UNESCO-designated sites · Local and indigenous knowledge

17.1 Introduction

Along with other small island regions, the Pacific contributes only very modestly to global greenhouse gas emissions yet faces the prospect of severe climate change impacts. However, while low-lying atoll countries and islands are particularly at risk from factors such as sea level rise, the vulnerability of Pacific Island societies is diverse and complex.

H. D. Thulstrup (✉)

Division of Ecological and Earth Sciences, UNESCO, 7 Place de Fontenoy, 75352 Paris, France
e-mail: h.thulstrup@unesco.org

© UNESCO 2024

A. Dansie et al. (eds.), *The Water, Energy, and Food Security Nexus in Asia and the Pacific*, Water Security in a New World,
https://doi.org/10.1007/978-3-031-25463-5_17

381

Having settled and subsequently inhabited marginal locations subject to significant and drastic environmental variation and change for generations, Pacific societies have over time developed a highly diverse range of local and indigenous knowledge systems and associated practices that serve to mitigate risk and support sustainability and livelihoods across a wide range of often small, isolated, and natural disaster-prone localities. This has resulted in the emergence of a robust tradition of site governance and sustainable management practices, including sacred natural sites and tabu systems.

While it has been widely acknowledged that these sets of knowledge and practice at present make a notable contribution to the sustainability of Pacific societies (IPCC 2014), local and indigenous knowledge and practice has not translated easily into conventional site designations such as protected areas. There are a number of reasons for this. Traditional and indigenous knowledge and practice is frequently locally rather than nationally governed, relies on oral rather than written transmission, and is often not immediately compatible with the conventional scientific analyses applied in ecosystem assessments.

While historically and to some degree conceptually associated with conventional protected area categories, UNESCO-designated sites as presently applied have the potential to accord visibility, recognition, and support to local and indigenous knowledge and practice relating to the management of natural resources in the Pacific. These sites thereby have the potential to make a significant contribution to the 2030 Agenda and the long-term sustainability of the region.

UNESCO designations in the Pacific remain limited both in terms of number and in the degree to which this potential has been realized. However, the experiences made to date offer both lessons learned and hint at further potential made possible by gradual changes within the UNESCO site-based programmes themselves. They demonstrate how stronger recognition of local and indigenous management knowledge and practice has the potential to enhance the resilience of Pacific Island societies, while at the same time making clear some of the key challenges in this regard. In turn, the potential contribution of local and indigenous knowledge and practice towards ensuring greater resilience in the Pacific is a significant consideration in the treatment of the water-energy-food nexus in the subregion and its long-term sustainability.

17.2 A Brief Overview of UNESCO-Designated Sites

UNESCO-designated sites are areas recognized by UNESCO and its member states as belonging to one or several of three distinct categories: (1) Biosphere Reserves, (2) World Heritage sites, and (3) Global Geoparks. All UNESCO-designated sites are nominated by the member state (or states in the case of transboundary sites) to which the nominated territories belong and remain under the sovereign jurisdiction of the nominating member state after recognition. The decision to accept a given site as a UNESCO designation is made by elected bodies composed of UNESCO member state representatives, in accordance with the distinct rules and procedures of each of

the three programmes. World Heritage sites are recognized under the World Heritage Convention of 1972 and are subject to related governance and legal arrangements.

While each addresses a distinct set of issues and conforming to a distinct set of criteria, the three designations are today all explicitly associated with the contribution of each designated site towards sustainable development in and around the site itself, and through the commitment made to the programme by the nominating member state, in society at large. In spite of the currently explicit association with sustainable development, each programme was established with a distinct purpose. The first UNESCO-designated sites—Biosphere Reserves and World Heritage sites—were established in the mid-1970s with specific reference to their role in global environmental monitoring and assessment (for Biosphere Reserves) and the conservation and protection of cultural and natural heritage of “outstanding universal value” (for World Heritage sites). The most recent addition, UNESCO Global Geoparks, evolved from a non-governmental network attaining UNESCO designation in 2015.

17.2.1 *Biosphere Reserves*

While their name may invoke the term “nature reserve”, implying an area that is reserved or set aside for conservation purposes, the impact of human activity on the environment has been at the core of the Biosphere Reserve since the UNESCO’s Man and the Biosphere (MAB) programme was first conceived in the late 1960s. Biosphere Reserves are today defined as “*learning places for sustainable development*’. *They are sites for testing interdisciplinary approaches to understanding and managing changes and interactions between social and ecological systems, including conflict prevention and management of biodiversity. They are places that provide local solutions to global challenges.*”¹ Today, there are 738 biosphere reserves in 134 countries, including 22 transboundary sites jointly nominated by two or more countries.

The first Biosphere Reserves, established in 1975 as an offshoot of the intergovernmental scientific programme Man and the Biosphere (itself created in 1971), were envisioned as representative samples of the world’s biomes. The primary objective of the establishment of a *World Network of Biosphere Reserves* was to ensure that adequate examples of all important and representative biomes and ecosystems were protected (UNESCO 1973). It was envisioned that countries would nominate “representative biome subdivisions” not yet under protection under conventional protected area criteria. The resulting Biosphere Reserves would in turn serve as “a standard against which to judge the result of human use of modification elsewhere in that biome”. To complement this type of Biosphere Reserve, it was envisioned that environments that had undergone substantial modification by human activity would also be included among areas identified for Biosphere Reserve status (Thulstrup 2016). It was hoped that this approach—by which the areas under protection would be identified on the basis of their representativeness of a given biome rather than by

¹ <https://en.unesco.org/biosphere/about>, Accessed on 27 September 2020.

other criteria, such particularly outstanding biodiversity or the presence of flagship species, would yield protection for plants and animals about which knowledge was still considered limited.

In this way, Biosphere Reserves would secure in-situ conservation of genetic resources; known and unknown, as well as a baseline against which to assess human impact on the global environment (UNESCO 1973). While a tracing of the extensive trajectory of the MAB programme's history is beyond the scope of this paper, it should be noted that the programme has contributed significantly to the global discourse on issues such as sacred natural sites, detailed in the joint IUCN-UNESCO publication "*Sacred Natural Sites: Guidelines for Protected Area Managers*" (Wild and McLeod 2008).

17.2.2 World Heritage Sites

The predominantly scientific purpose underlying the establishment of the early Biosphere Reserves is distinct from the early drivers for the World Heritage Convention of 1972, which was established with a highly tangible purpose in mind; to protect the world's cultural and natural places of outstanding universal value, and with an initial close association with cultural heritage rather than nature conservation.

Significantly, early mobilization of support for the convention in the late 1950s and 1960s occurred in response to a direct, specific, and clearly identifiable threat to the Abu Simbel temple complex in Egypt and the threat it faced from the construction of the Aswan High Dam. This early focus on tangible, iconic properties, eventually also including sites of natural heritage significance, allowed the World Heritage Convention to convey a clear and simple message to its constituency as well as to the general public: global support is needed to protect places that are of such extraordinary value that their preservation concerns all of humanity (Thulstrup 2016).

Recognition of interactions between people and nature within the World Heritage Convention has received increasing attention as the World Heritage List has grown, and the Convention today recognizes not only cultural, natural, and mixed World Heritage properties, but also cultural landscapes: sites that explicitly recognize the interaction between people and nature. In the Pacific, Papua New Guinea's Kuk Early Agricultural site² is an example of a World Heritage listed cultural landscape.

Today, the notion of sustainable development is firmly integrated into the principal guiding document for implementation of World Heritage at all levels, the World Heritage Convention's Operational Guidelines. The 2019 edition of the Guidelines (which are continuously updated to ensure guidance for implementation of the Convention that takes into account current international commitments, priorities, and complementary programmes) encourage States Parties:

to mainstream into their programmes and activities related to the World Heritage Convention the principles of the relevant policies adopted by the World Heritage Committee, the General

² <https://whc.unesco.org/en/list/887>.

Assembly of States Parties to the Convention and the UNESCO Governing Bodies, such as the Policy Document for the Integration of a Sustainable Development Perspective into the Processes of the World Heritage Convention and the UNESCO policy on engaging with indigenous peoples, as well as other related policies and documents, including the 2030 Agenda. (UNESCO 2019)

There are today 1,174 World Heritage sites, including 43 transboundary sites. Of the total number of World Heritage sites, 900 recognize cultural heritage, 218 natural heritage, while 39 are mixed properties featuring both cultural and natural properties.

17.2.3 UNESCO Global Geoparks

UNESCO's work with the concept of geoparks began in 2001. In 2004, representatives of seventeen European and eight Chinese sites identifying as geoparks came together at UNESCO Headquarters in Paris to form the Global Geoparks Network (GGN) where national geological heritage initiatives contribute to and benefit from their membership of a global network of exchange and cooperation. During the Organization's 38th General Conference in 2015, UNESCO's 195 member states ratified the creation of a new UNESCO site designation, *UNESCO Global Geoparks*. Four decades after the establishment of the first Biosphere Reserves and World Heritage sites, the adoption of the concept as a UNESCO designation accorded governmental recognition to the importance of managing outstanding geological sites and landscapes in a holistic manner.

UNESCO Global Geoparks are defined as single, unified geographical areas where sites and landscapes of international geological significance are managed with a holistic concept of protection, education, and sustainable development. The programme advocates a bottom-up approach that combines conservation with sustainable development, while involving local communities and is becoming increasingly popular. At present, there are 177 UNESCO Global Geoparks in 46 countries.³

17.3 Vulnerability, Resilience, Local and Indigenous Knowledge and UNESCO-Designated Sites in the Pacific Context

As outlined in the above, guiding documents for UNESCO site designations (notably the World Heritage Convention's Operational Guidelines) have over time made more

³ A webpage of each UNESCO Global Geopark is available, with detailed information on each site (<http://www.unesco.org/new/en/natural-sciences/environment/earth-sciences/unesco-global-geoparks/>, Accessed 10 February 2022).

explicit reference to the validity and significance of local and indigenous management arrangements at the site level, as well as advocated for management authorities to respect, and where appropriate, build upon local and indigenous knowledge and management principles. However, there is little doubt that considerable variation exists in the degree to which existing UNESCO-designated sites live up to the standards advocated by the programmes. UNESCO programmes are intergovernmental in nature and as such are not always ideally suited to ensure the full reflection of local and indigenous systems that are local in nature and may not be aligned with, or even recognized by the national authorities responsible for their submission to UNESCO.

The conferral of a UNESCO designation that builds upon local and indigenous Pacific management principles does, however, bring with it the potential to raise the visibility and international profile of viability, value, and relevance of local and indigenous management systems in reducing vulnerability and enhancing resilience of small islands to climate change. This visibility has the potential to leverage a positive impact at the local, national, and international level, even though this potential may yet to be fully realized in the existing Pacific designations.

In the global climate change discourse, small islands have conventionally been considered as particularly vulnerable to the impacts of climate change (Chaps. 2, 3 and 10) due to their limited landmass, low elevation and exposure to sea level rise, relative isolation, and susceptibility to natural disasters such as tropical storms, flood, and drought, as well as—in the Pacific case—earthquakes, tsunamis, and volcanic hazards. While treatment of small island vulnerability in research literature has grown more nuanced in recent years with increasing recognition that considerable heterogeneity exists among and within different small island nations and regions, the overall assessment of small islands as vulnerable has been continuously reaffirmed.

In an example here of, the IPCC's 5th assessment report published in 2014 confirms with “high confidence; robust evidence, and high agreement” the [...] high level of vulnerability of small islands to multiple stressors, both climate and non-climate given the inherent physical characteristics of small islands” (IPCC 2014).

The report, however, also notes with high confidence that “small islands do not have uniform climate change risk profiles [...] Rather, their high diversity in both physical and human attributes and their response to climate-related drivers means that climate change impacts, vulnerability, and adaptation will be variable from one island region to another and between countries in the same region.” (IPCC 2014). The report further identifies the “need to acknowledge the heterogeneity and complexity of small island states and territories” as a data and research gap.

The IPCC takes note of an increasing appreciation that not all small islands even within the same country share the same vulnerability profile. Related hereto, the IPCC notes that the research base for assessing the degree to which local and indigenous knowledge and management systems (Chap. 11) play a significant role in the generation and maintenance of this heterogeneity has yet to be extensively populated.

In this regard, the IPCC recognizes the importance of local and indigenous knowledge systems and their potential in strengthening resilience to climate change: “...there is continuing strong support for the incorporation of indigenous knowledge into adaptation planning. However, this is moderated by the recognition that

current practices alone may not be adequate to cope with future climate extremes or trend changes. The ability of a small island population to deal with current climate risks may be positively correlated with the ability to adapt to future climate change, but evidence confirming this remains limited” (IPCC 2014), thus indirectly identifying the relationship between present-day resilience climate risk among small island societies and their ability to address future climate change as yet another research gap.

While further research to build the evidence base through which to better assess this potential correlation is required, examinations of the ability of Pacific societies to manage environmental change has been examined in the recent past. In 2012, UNESCO and the United Nations University published “Weathering Uncertainty”, a comprehensive overview of the scientific literature, primarily peer-reviewed, but also grey, relating to the contribution of local and indigenous knowledge to our understanding of global climate change. A special report on small islands contained in the review and drawing extensively on Pacific sources concluded that:

Small island societies have lived for generations with considerable and often sudden environmental change. The traditional knowledge and related practice with which small island societies have adapted to such change are of global relevance. Areas in which small island societies have developed adaptation-relevant traditional knowledge include natural disaster preparedness, risk reduction, food production systems and weather forecasting. In many small island contexts, the transmission and application of traditional knowledge is under threat from changes in consumption and migration patterns, as well as from the lack of recognition of traditional knowledge in the formal educational system. (Nakashima et al. 2012)

Significantly, the review found local and indigenous knowledge and practice to be a significant factor in reducing vulnerability and adapting to often drastic environmental change, while at the same time acknowledging the erosion of the associated knowledge transmission caused by its gradual replacement as Pacific societies become more integrated into globally determined consumption, migration, and knowledge production patterns. This erosion in turn is considered a detrimental factor in maintaining resilience in the face of climate change.

The review notes a number of examples of sophisticated small island local and indigenous resource management regimes from the Pacific that have provided (and continue to provide) for the social and ecological regulation of resource production, access, harvesting, storage, and distribution. Several examples are provided of how Pacific local and indigenous knowledge and practice relating to the water-food-energy nexus have served to maintain resilience. A striking example of this is provided from the Vanuatu northern outlier of the Torres Islands:

The Torres Islands are situated in a very highly active seismic region that provokes constant, violent shifts in shoreline ecologies and hydrodynamics. Distributing environmental risk is a central element in traditional small island vulnerability mitigation strategies, such as the scattering of food production sites. The authors argue that overall changes to the local shoreline, especially in relation to soil quality, vegetation growth and hydrodynamics, as provoked by extreme seismic uplift and downlift, offer a unique and informative example of the longterm adaptability that is present in both the human population and the observed coastal milieu of these islands, and is applicable to climate change adaptation. Adapted

from the paper 'Seasonal environmental practices and climate fluctuations in Melanesia. An assessment of small island societies in Papua New Guinea and Vanuatu.' (Damon and Mondragon 2011)

The example highlights how local and indigenous food production in the Torres Islands has mitigated the threat posed by constant and often violent shifts in local ecological conditions caused by frequent extreme seismic shifts. This constant threat of drastic change helped shape a complex system of kinship relations and associated food production strategies that ensure the distribution and buffering of risk among members of the community to ensure an overall enhancement of the community's resilience when drastic change occurs.

The Torres Islands case is significant in that it provides a tangible demonstration of the ability of Pacific local and indigenous knowledge and practice to mitigate even drastic environmental change. At the same time, it provides a good example of an approach that seeks to understand and manage changes and interactions between social and ecological systems, including conflict prevention and management of biodiversity, as well as provide local solutions to global challenges. This role dovetails entirely with the contemporary definition of a UNESCO Biosphere Reserve given in Sect. 17.2.1. Two additional examples are worthy of mention here, providing a further illustration of the contributions towards resilience made by local and indigenous knowledge and management systems, and the principles advocated by UNESCO's site-based programmes.

17.4 Local And Indigenous Management And UNESCO-Designated Sites in the Pacific

17.4.1 Ngaremeduu Biosphere Reserve, Palau

Pacific customary marine tenure, comprising a range of local and indigenous fisheries management practices, is based on control mechanisms that may be temporal or spatial in nature or a combination of the two. These include limited access, closed seasons, no-catch zones, and species-specific prohibitions and are exemplified by no-fishing or *tabu* areas of Fiji, Vanuatu, and Kiribati; the *ra'ui* in the Cook Islands; the *masalai* in Papua New Guinea; and *bul* in Palau. In Palau, the *bul* can be put in place to close an area of reef to harvesting on a short-term basis, for example, during periods of fish spawning (Vierros et al. 2010).

In the nomination of the Ngaremeduu Biosphere Reserve in Palau, which was approved in 2005 as one of the first two Biosphere Reserves in the independent Pacific Island countries, the *bul* was referred as a guiding principle in development of the site's zonation scheme. In this sense, temporal as well as spatial local and indigenous fisheries management elements were directly incorporated into the justification for the creation of a UNESCO-designated site in the Pacific. The Biosphere Reserve's

acceptance by UNESCO member states served to highlight the visibility and drew global attention to the use of *bul* in the management of protected areas in Palau.

However, the case of Ngaremeduu also serves to highlight the difficulty in maintaining and advancing implementation of a UNESCO-designation over the long term. Thulstrup (2016) notes that the limited presence in Palau and other small island states of well-established national scientific institutions and scientific research traditions and capacities to some degree plays a role in undermining their ability to engage actively with the Man and the Biosphere (MAB) programme, a programme anchored in international science networks, and to derive the full potential benefits from it.

In small developing countries, the established scientific institutions that in larger countries traditionally play a key role in shaping the national infrastructure of the MAB programme are often not present. This leaves the designated government department or individual alone with a facilitation and management task normally shared between several larger institutions, and without the networks and resources to draw upon for representation in and engagement with MAB's governing and advisory bodies, joint MAB-affiliated research projects, and other international cooperation.

In the years following the approval of the site in Palau as a Biosphere Reserve, this led to the a relative decline in terms of active implementation, caused both by the challenges in maintaining a viable focal point and by the complexities of managing a Biosphere Reserve straddling three traditional communities and states. Efforts are currently under way to reassess and reinvigorate the management of the site in line with the interests and priorities of the communities it encompasses.

These challenges are directly related to one of the key principles of UNESCO's site-based programmes: the nomination of terrestrial and marine areas for conservation through a government-led process. This does not immediately integrate well into the Pacific traditions of a high degree of local-level autonomy and local and indigenous management of natural resources (Chap. 11). Even where national designations are based upon and closely associated with local and indigenous management systems, the conferral of an international designation through an intergovernmental process carries with it an implicit validation of these systems inherent in the process of nomination and assessment of any property. Local and indigenous norms, values, and knowledges may be referenced in the submission dossier, however the very process of committing these norms to paper in accordance with an internationally sanctioned standard in itself may compromise the principles of local and indigenous management, which tends to be locally grounded, oral, and non-static in nature.

While such compromises in the recognition of Pacific UNESCO-designated sites most certainly fail to capture essential elements of how water and biodiversity is managed and sustains life in the Pacific, they have served to shift the global perceptions of how sites are selected, assessed, and documented. Several examples from the Pacific help illustrate this.

17.4.2 East Rennell, Solomon Islands

The nomination of East Rennell by the Solomon Islands for consideration as a natural World Heritage site in 1998 helped cause a shift in the understanding of local and indigenous management of natural heritage recognized under the Convention. The report of the 22nd meeting of the World Heritage Committee notes that:

The Committee had a considerable debate on customary protection and agreed that customary management should be supported [...] A number of delegates welcomed the nomination and noted that a site protected by customary law is breaking new ground, and that the inclusion of this type of property is in line with the Global Strategy. Sites from other States Parties, which are under traditional management and customary law, may provide examples for general principles. The Delegate of Thailand stated that although he had no doubt about the World Heritage values of the site, he could not support the nomination at this stage, as it did not comply with the requirements of the Operational Guidelines. He noted that customary land tenure does not automatically guarantee effective customary management and that there are no legislative provisions to protect the site from rapid changes such as tourism, which may affect it. He therefore dissociated himself from the Committee's decision.⁴

As the quote highlights, the recognition of local and indigenous management principles as reflective of the established standards to ensure long-term protection of Outstanding Universal Value was not uniformly accepted at the time.

As discussed above, subsequent iterations of the Operational Guidelines of the World Heritage Convention have reflected the validity of local and indigenous management authorities, approaches, and governance systems. While the nomination of East Rennell as a natural World Heritage site may have served as a watershed in the recognition of Pacific local and indigenous management, the subsequent performance of the site in the eyes of the Committee demonstrates, as with the Ngaremeduu Biosphere Reserve, the complexities inherent in aligning local and indigenous management with World Heritage expectations for the management of and conservation of Outstanding Universal Value.

After years of concern over threats to the integrity of the site, by 2013 East Rennell was placed on the “World Heritage in Danger” list due to persistent threats to the integrity of the site stemming from a range of factors, including among others, commercial hunting, fishing/collecting aquatic resources, forestry and wood production, invasive and alien terrestrial species, as well as the state of the legal and management framework.

The discussion by the World Heritage Committee of a reactive monitoring report prepared and submitted to the Committee by the IUCN in 2019 shows the persistence and considerable complexity of the challenges facing the site today:

Continued efforts by customary landowners and local communities of East Rennell and by the State Party to keep the Outstanding Universal Value (OUV) of the property intact by banning commercial logging and mining within the property are welcomed. However, it is regrettable that a new logging concession was recently granted by the State Party, which

⁴ United Nations Educational Scientific and Cultural Organization, Convention Concerning the Protection of the World Cultural and Natural Heritage WHC-98/CONF.203/18, p. 26.

allows commercial logging up to 200 meters from the boundary of the property, while no information is made available regarding its potential impact on the property's OUV. [...]

The clarification that the letter allegedly sent on behalf of the Tuhunui tribe, requesting to withdraw its customary land from the property, was made without mandatory consultation with tribal chiefs and subsequently revoked, is welcomed. The 2019 Reactive Monitoring mission also verified this particular issue with the Paramount Chief, Council of Chiefs and LTWHSA, and it is clear that competing and contested claims of customary rights among tribes and individual households remain a challenge for the customary management. [...]

The on-going dialogue between the State Party and local communities to consider application of the Protected Area status to the property and to finalize the Management Plan is welcomed but needs to be concluded. Defining and adopting an adequate legal mechanism to continue protecting the property from commercial logging and mining while safeguarding customary rights to land and natural resources for sustainable use, in line with Paragraph 119 of the Operational Guidelines, is critical to ensure long-term mutual benefits to the property and the local communities, who are custodians of the property. The mission notes that the establishment of an IUCN category VI protected area could be a good tool to achieve this.⁵

As the text above shows, East Rennell is beset by a set of complex and interacting challenges relating to the balancing of the integrity of the site and its ability to protect the outstanding universal value for which it was recognized, the interests of communities and individuals in pursuing livelihoods and representation in decision-making and governance, and the legal status of the site and its recognition at the local versus the national level.

The East Rennell case provides a demonstration of the impact that local and indigenous Pacific management of terrestrial and marine natural resources has had on the perception of local and indigenous management in the global World Heritage context, while also making visible the significant challenges in merging such management systems with global recognition according to conventional conservation standards.

17.4.3 Utwe Biosphere Reserve, Federated States of Micronesia

Along with Ngaremeduu in Palau (discussed above) and And Atoll in the neighboring state of Pohnpei, the recognition of Utwe as a Biosphere Reserve in 2005 broke new ground in terms of its small size (1,773 hectares) and associated concentric spatial organization within a very limited geographical area. The nomination of Utwe as a Biosphere Reserve was also notable in that the process was driven almost entirely on the basis of a local community initiative. The Utwe community, supported by the Utwe-based non-government organization Kosrae Conservation and Safety Organization (KCSO), initiated, organized consultations for, drafted and worked with the federal government to ensure the submission of the nomination dossier to UNESCO.

⁵ Accessed from <http://whc.unesco.org/en/soc/3838>.

Utwe is located on the island of Kosrae in the central Pacific Ocean, one of the four states of the Federated States of Micronesia. The site comprises marine areas, mangroves, upland tropical forest, as well as the Utwe community itself. As was the case with the nomination dossier, the reserve's management arrangements and spatial organization were devised, implemented, and monitored by community authorities supported by KSCO.

While Utwe ranks among the world's smaller Biosphere Reserves, its size and close association with the local community has allowed for the integration of Biosphere Reserve planning and development with that of the community as a whole. While Utwe's zonation follows a conventional concentric pattern with the core area at the center of the Biosphere Reserve, it is set apart by its small size and by the close proximity of the population center of Utwe to its core area, which was defined with the specific objective of establishing and maintaining a locally protected area that in turn would help minimize and eventually completely halt illegal fishing and associated practices in Utwe's marine areas in accordance with local and indigenous management practices.

The successful recognition of Ngaremeduu, Utwe, and Atoll helped influence conventional norms applied to Biosphere Reserves in terms of size (being smaller than conventionally recommended), spatial organization (core areas were clearly defined, but on the understanding that local communities would be able to access and manage them in accordance with established local/community practice), as well as in terms of the driving forces behind the nominations (Thulstrup 2016).

The impact of the first Pacific Biosphere Reserve nominations by Palau and the Federated States of Micronesia's were highlighted through the participation by a delegate from Palau in the 2008 Madrid World Congress of Biosphere Reserves. Discussions at this global forum of Biosphere Reserves served as confirmation that the new approaches taken to Biosphere Reserve nomination and development by Pacific Island countries were not only being tolerated, as evidenced by the approval of their nomination dossiers, but were listened to and recognized by the global biosphere reserve community (Thulstrup 2016).

17.5 Conclusion

This chapter has outlined some of the challenges inherent in seeking, obtaining, and maintaining the recognition of local and indigenous Pacific natural resource management governance in the context of UNESCO site designations, and has argued that such designations have the potential to enhance sustainability and resilience to climate change in the subregion.

While there is little doubt that considerable work remains to be done towards improving the articulation between Pacific local and indigenous knowledge and practice and UNESCO's site-based programmes, the experiences made in the Pacific to date, of which this chapter has addressed only very limited subset, have demonstrated

that such articulation is possible, with potential benefits to both the Pacific peoples impacted by their designation and to the programmes themselves.

The concepts of World Heritage sites and Biosphere Reserves were not initially established with the recognition or integration of local and indigenous knowledge systems in mind. However, aided and informed by the engagement of Pacific communities and governments, these concepts have increasingly found their way into the documents guiding the programmes. In the case of UNESCO Global Geoparks, their incorporation as a UNESCO designation in 2015 allowed for a stronger reflection of traditional, local, and indigenous knowledge, to the extent that “local and indigenous knowledge” is recognized as one of ten focus areas for UNESCO Global Geoparks. In helping bring about the conditions for this recognition, Pacific engagement with the programmes have made a lasting impact with potential benefits beyond the Pacific itself.

Beyond the scope UNESCO-designated sites, recent years have seen further attention to, and recognition of conservation measures beyond the conventional definition of the term. An example hereof is the formal definition of other effective area-based conservation measures (OECMs), applied as a designation for areas that are achieving the effective biodiversity conservation outside conventional protected areas. Referenced in the Convention of Biological Diversity’s (CBD) Aichi Target 11, OECMs were defined at CBD’s 14th Conference of Parties as “*a geographically defined area other than a Protected Area, which is governed and managed in ways that achieve positive and sustained long-term outcomes for the in situ conservation of biodiversity, with associated ecosystem functions and services and where applicable, cultural, spiritual, socio-economic, and other locally relevant values*” (Conference to the Parties to the Convention on Biological Diversity 2018).

With reinforced focus on long-term sustainability, better integration of relevant management and planning concepts, and the recognition local autonomy, future UNESCO-designated sites in the Pacific have the potential as demonstrated by the efforts outlined in this chapter and in so doing, deliver a tangible contribution to the long-term sustainability of natural resource management grounded in the knowledge and practice that made the successful settlement of the region possible.

References

- Conference of the Parties to the Convention on Biological Diversity (2018) Fourteenth meeting Sharm El-Sheikh, Egypt, 17–29 November 2018. Decision CBD/COP/DEC/14/8 on protected areas and other effective area-based conservation measures
- Damon F and Mondragon C (2011) Seasonal environmental practices and climate fluctuations in Melanesia. An assessment of small island societies in Papua New Guinea and Vanuatu. Presentation at the international expert meeting on indigenous peoples, marginalized populations and climate change: vulnerability, adaptation and traditional knowledge (IPMCC), 19–21 July 2011, Mexico City, Mexico

- IPCC (2014) Climate change 2014: impacts, adaptation, and vulnerability. Part B: regional aspects. Contribution of working group II to the fifth assessment report of the intergovernmental panel on climate change. Barros VR, Field CB, Dokken DJ, Mastrandrea MD, Mach KJ, Bilir TE et al. (eds.). Cambridge University Press, Cambridge, United Kingdom and New York, NY, USA
- Nakashima DJ, Galloway McLean K, Thulstrup HD, Ramos Castillo A, Rubis JT (2012) Weathering uncertainty: traditional knowledge for climate change assessment and adaptation. UNESCO, Paris and UNU, Darwin
- Thulstrup HD (2016) Islands of good sense: communicating UNESCO's man and the biosphere programme. Australian National University, Canberra, Australia, pp 61, 134, 162
- UNESCO (1973) Programme on man and the biosphere (MAB). Expert panel on project 8: conservation of natural areas and of the genetic material they contain, MAB Report Series No. 12. UNESCO, Paris, p 5
- UNESCO (2019) Operational guidelines for the implementation of the World Heritage Convention UNESCO, Paris, France, p 11
- Vierros M, Tawake A, Hickey F, Tiraa A, Noa R (2010) Traditional marine management areas of the Pacific in the context of national and international law and policy. Darwin, Australia, United Nations University—Traditional knowledge initiative
- Wild R, McLeod C (eds) (2008) Sacred natural sites: guidelines for protected area managers. IUCN, Gland, Switzerland

The opinions expressed in this chapter are those of the author(s) and do not necessarily reflect the views of the UNESCO: United Nations Educational, Scientific and Cultural Organization, its Board of Directors, or the countries they represent.

Open Access This chapter is licensed under the terms of the Creative Commons Attribution-ShareAlike 3.0 IGO License (<https://creativecommons.org/licenses/by-sa/3.0/igo/>), which permits use, sharing, adaptation, distribution, and reproduction in any medium or format, as long as you give appropriate credit to the UNESCO: United Nations Educational, Scientific and Cultural Organization, provide a link to the Creative Commons licence and indicate if changes were made. If you remix, transform, or build upon this book or a part thereof, you must distribute your contributions under the same licence as the original.

The use of the UNESCO: United Nations Educational, Scientific and Cultural Organization's name, and the use of the UNESCO: United Nations Educational, Scientific and Cultural Organization's logo, shall be subject to a separate written licence agreement between the UNESCO: United Nations Educational, Scientific and Cultural Organization and the user and is not authorized as part of this CC-IGO licence. Note that the link provided above includes additional terms and conditions of the licence.

The images or other third party material in this chapter are included in the chapter's Creative Commons licence, unless indicated otherwise in a credit line to the material. If material is not included in the chapter's Creative Commons licence and your intended use is not permitted by statutory regulation or exceeds the permitted use, you will need to obtain permission directly from the copyright holder.



Chapter 18

Clean Energy Options for the Future



Emma Lovell, Rahman Daiyan, Jason Scott, and Rose Amal

Decentralized renewable Power-to-X technologies have the potential to facilitate the energy transition in Pacific Island Countries and Territories.

Abstract While the transition to a cleaner energy sector is underway in Pacific Island Countries and Territories (PICTs), there are still many challenges that need to be overcome from demand, energy, chemical, and technological perspectives. The composition of the Pacific region makes it highly compatible with the movement towards small-scale, decentralized, and on-demand production of chemicals (for direct use as well as acting as an energy storage vector). Power-to-X, being the conversion of electricity into a range of different chemicals and fuels, has immense potential to offset reliance on imports, fossil fuels, as well as decrease transportation requirements. The emerging Power-to-X technologies have potential to address many of the struggles in transforming to a renewable sector. This chapter examines the transition to clean energy generation technologies, focusing on those emerging technologies which are close-to-market level implementation and have the potential to transform the Pacific region. The prospects and limitations, including the diversity of the region from both a generation and storage perspective, as well as the chemical demand, and its reliance on fossil fuel-based derivatives and imports are discussed.

Keywords Power-to-X · Hydrogen · Battery storage · Clean energy · Ammonia · Hydrocarbons · Waste-to-X

E. Lovell (✉) · R. Daiyan · J. Scott · R. Amal

Particles and Catalysis (PartCat) Research Group, School of Chemical Engineering, Tyree Energy Technologies Building, University of New South Wales, Sydney 2052, Australia
e-mail: e.lovell@unsw.edu.au

© UNESCO 2024

A. Dansie et al. (eds.), *The Water, Energy, and Food Security Nexus in Asia and the Pacific*, Water Security in a New World,
https://doi.org/10.1007/978-3-031-25463-5_18

395

18.1 Introduction

The energy transition within the Pacific is well underway. Many Pacific Island Countries and Territories (PICTs) have plans and roadmaps to increase access to electricity, as well as transition towards renewable energy-based systems. These roadmaps are framed toward the transition to (1) increasing electrification, (2) decreased reliance on fossil fuels, thus reducing greenhouse gas emissions, and (3) a more autonomous, lower-cost and more resilient energy sector. The framework as PICTs transition to a more sustainable and equitable society has been discussed extensively in Chaps. 3 and 12. However, as aptly posed by the International Energy Agency (IEA), “more than just renewables and efficiency will be required to put the world on track to meet climate goals and other sustainability objectives” (IEA 2020a).

Across PICTs there remain significant barriers to achieving energy sustainability and autonomy. These were outlined in detail by the UN Economic and Social Commission for Asia and the Pacific and include (Johnston 2013):

- The lack of energy resources in PICTs, as well as the limited range of resources.
- The population distribution, with many in remote areas, and the high cost of developing new energy resources.
- The lack of energy data, including the trends associated with end-use.
- The lack of local knowledge and skills.
- The weak bargaining positions with petroleum suppliers.
- The historical dependence on international agencies for infrastructure.
- The low electricity cost and subsidies which have been below cost price meaning there are limited funds for maintenance and upgrading.

While there is a significant push by governments and development partners and agencies to increase electrification, this increased electrification requires ongoing consideration such as grid connectivity, environmental footprint, capital investment, and specific energy and feedstock requirements. Particularly in the rural regions of the Pacific, connection to the grid is not the most economically viable option. The establishment of a more diverse range of off-grid solutions, tailored to the environment and needs of specific areas is essential.

Globally, new technology developments, increased consideration on environmental impacts and sustainability, as well as increasingly empowered consumers and communities are all spurring a shift toward distributed, decentralized energy production. This means a greater number of energy generation centres, more competition and a more diverse range of generation and storage approaches. The advantages of this shift are significant. The increased competition, reduced infrastructure and transportation costs, the lower barriers to entry and the more tailored approach, means more efficient usage of resources.

This global shift has potential to be hugely beneficial in the Pacific region. In step with global shifts, the decentralized, off-grid production of energy, in particular for the Least Developed Countries and Small Island Developing States (LDCs and SIDS), has significant potential to transform the region.

The LDCs and SIDS face unique barriers toward the successful implementation of renewable energy projects. These include the isolated market with small sizes and small population base resulting in low economies of scale, the narrow range of resources, remote locations, and economical and ecological vulnerability (Lomaloma, n.d.).

For the transformation of the Pacific region, as outlined in this volume (Chaps. 3 and 12), the shift toward renewable energy (such as wind, solar, and geothermal), as well as enhancements in energy efficiency are a great starting point. The employment opportunities, low environmental footprint, and increased energy autonomy and security are particularly advantageous.

This chapter focuses on emerging technologies which are not quite at deployment stage yet, however if implemented, hold the potential to transform the PICTs transition to a clean energy future. Power-to-X is an increasingly common term in the emerging research technologies space. Power-to-X is the conversion of electricity, particularly renewably produced electricity such as through photovoltaics (PV), hydro, and geothermal energy, to a range of different chemicals and fuels.

While the inherent nature of PICTs provide barriers to a transition to a more sustainable, reliable and accessible energy future, the region is uniquely situated to transition to the small scale, decentralized production of electricity and chemicals in an on-demand manner. The emerging technology in this space has potential to transform the region.

18.2 Energy Generation Technologies

The Pacific region is diverse. PICTs exist along a large spectrum of development levels, from the most developed, Australia and New Zealand, to the LDCs. Further, the natural resources, in particular with respect to fossil fuels and land mass, geothermal/wind power suitability, vary drastically across the region. Australia, Timor Leste, and Papua New Guinea all have fossil fuel reserves whereas many of the other nations do not.

The Melanesian countries can be characterized by large, mountainous islands with considerable natural resources in the form of fertile soils, mineral deposits, and large forests. In the Polynesian and Micronesian countries, the mid-sized island states have limited land resources and low amounts of tradable natural resources. The small and low island states of Micronesia have very limited land and oil with their resources mostly limited to the ocean. Given this vast variability across the region, an in-depth review of the scope of energy generation throughout the region is difficult. However, the focus of this chapter is on near-to-market technologies which can be exploited across the region, in particular those that are capable of transforming energy into applications which are suited to diverse applications throughout the Pacific.

The transformation to renewable electricity generation is well underway throughout the Pacific region (Chap. 12). There has been a significant increase in solar and wind power plants over the 2000 to 2018 timeframe (UNESCAP 2019).

Renewable energy generation throughout PICTs is on an upward trajectory (Norjono et al. 2018) with some nations having a 100% renewable penetration target by 2030. As outlined in Chaps. 3 and 12, solar, wind, geothermal, bioenergy and hydro are all playing significant roles in the generation of energy throughout the Pacific. While this generation of electricity through variable renewable energy has many advantages, including energy autonomy, reduced emissions, reduced reliance on imports, and increased compatibility with off-grid energy solutions, it come with its limitations. These limitations include intermittency of renewables (specifically for solar PV) and typically higher capital investment requirements that may make the adoption of renewable electricity unfeasible.

Section 18.3 will address the near-to-market technologies that have the ability of overcome the variable renewable energy generation.

18.3 Emerging Technologies for Transformation and Storage

This volume has aptly demonstrated that energy poverty throughout PICTs, in particular within the LDCs and SIDS, is widespread. It has been estimated that approximately 70% of households throughout the Pacific region do not have access to electricity. Further, 85% of households are also estimated to have limited access to clean cooking technologies.

Both the population distribution and the geography of the Pacific region, in particular SIDS, make the transition towards decentralized solutions a potential driver for economic development. For example, in areas throughout PICTs of low population density, the cost of establishing off-grid systems is lower than extending the grid to households. In Fiji, it was determined that the cost of grid extension was close to four times higher than installing an off-grid diesel generator (Matakiviti and Pham 2003). Thus, for SIDS, the cost of installing off-grid systems is likely to be lower than if grids were extended.

Variable renewable energy refers to renewable energy that is inherently fluctuating in nature, such as wind and solar as opposed to dispatchable power such as hydro-electricity. While electricity generation through variable renewable energy sources may be increasingly feasible, the direct use of this electricity presents unique issues due to its intermittency. Further, the storage of this energy can be difficult and costly, particularly over timescales longer than the minute to hour. The storage of electricity, particularly variable renewable energy to load balance for production and demand, requires significant planning and investment (European Commission 2017). Power-to-X, being the conversion of electricity (and in this case power trapped within

resources such as plastics and biodegradable waste) has potential to overcome the intermittency, load balance, and produce valuable chemicals and fuels.

This section will focus on new close-to-market technologies for the transformation, storage, and usage of variable renewable energy, which are well-suited for the Pacific region. This suitability includes being relatively low cost, or with low capital requirements, compatible with small scale, off-grid, decentralized production, as well as exploiting key waste products for the region.

18.3.1 Batteries

While the generation of electricity through variable renewable energy is established and the transition to a variable renewable energy system is well underway throughout PICTs, there remains significant issues in terms of energy storage and balancing supply and demand. Energy storage is often needed to manage short-term peaks as well as load balancing.

Many islands and off-grid regions in PICTs are powered by diesel generation, and thus the integration of variable renewable energy/battery storage presents a unique opportunity. These diesel generators are often oversized, operate below 30% capacity, and are emission intensive. However, diesel generators have the benefit of flexibility and rapid responses to variable energy demand that can fluctuate dramatically on an hour-to-day time scale as well as seasonally. Battery storage systems have been shown to be capable of delivering reliable power at approximately 30% of the cost of diesel generators (Stock et al. 2015). Additional, battery power is not hindered by oil price supply chain issues like diesel supply is (Puliti and Bazilian 2019). Beyond this, the use of variable renewable energy/battery systems overcomes the inherent pollution and health impacts associated with diesel combustion. If capital expenditure is included, it is estimated that diesel generators cost approximately 0.352 USD/kWh. In contrast, renewable power generation has been estimated at a leveled cost of $0.15 + / 0.10$ USD/kWh.

Consequently, PICTS present a unique and promising opportunity for battery storage. The technology can help to integrate renewable energy (Balza et al. 2014), reduce reliance on fossil fuels generation, and has been postulated to be capable of lowering costs in some cases. Given their technological maturity, and the limited requirement for infrastructure, safety issues, and upskilling, batteries are likely to dominate as the key energy storage approach in the Pacific region. This transition is expected to begin as separate stand-alone storage in small scale decentralized systems, then to minigrid systems, and finally in grid connection.

To date, the high costs associated with battery energy storage has been the key deterrent to the implementation of variable renewable energy sources. However, costs of storage systems are rapidly declining thanks to both technological advancements and scaling benefits.

The progress of battery technology, in particular with respect to costing, is more advanced than that of electrolyzers (see Sect. 18.3.2). The cost of lithium-ion batteries

in particular has decreased (from USD1000/kWh from 2009 to USD200/kWh in 2019) as a consequence of increased production rather than major technological advancements (IRENA 2017). This is expected to decrease to USD90/kWh by 2030 due to technology improvements and fierce competition among major manufacturers. The Cook Islands have approximately half of their islands under the process of being converted from mostly diesel power to solar and battery storage only. For example, Rarotonga, the Cook Islands largest island, has a 1 MW Te Mana Ra solar farm installed by NSW-based MPower and is in the process of incorporating a 5.6 MWh battery system (Vorrath 2018). This example illustrates the increasing deployment of renewable coupled battery microgrids in PICTs.

18.3.2 Hydrogen

Hydrogen is widely considered as “the fuel of the future”. As shown in Fig. 18.1, hydrogen is increasingly being utilized as a clean energy carrier as well as feedstock for various chemical manufacturing. Hydrogen has vast benefits over carbon-based fossil fuels, including its ease in production and its zero-emission nature when utilized. Hydrogen can be produced through a number of pathways, such as by reacting fossil fuels with steam or oxygen using Steam Methane Reforming (SMR) or coal gasification (CG) to generate grey hydrogen or through renewable energy driven water electrolysis to generate green hydrogen.

The global hydrogen demand is growing (Fig. 18.1). As of 2018, demand was around 73 million tonnes and is projected to increase to 300 million tonnes by 2050 (Deloitte 2019). Much of this demand is currently met via SMR. At present, industrial hydrogen production accounts for approximately 6% of global natural gas consumption and 2% of coal consumption, and thereby is a major contributor of global carbon emissions, emitting over 830 million tonnes in 2018 (IEA 2019a, b). As a result, there is a concerted effort to produce renewable hydrogen, which can facilitate decarbonization and sustainable economic development (Saeedmanesh et al. 2018). It is expected that with future declining cost of generating renewable hydrogen, the alternate clean fuel will see more adoption as an energy vector in sectors such as transportation, heat and electricity generation, and in steel manufacturing (Staffell et al. 2019). This viewpoint is echoed by the Australian government and the country’s National Hydrogen Roadmap has proposed that “clean hydrogen is a versatile energy carrier and feedstock that can enable deep decarbonization across the energy and industrial sectors.” One of the key benefits of green hydrogen production and storage is its ability to overcome the intermittency in energy from the renewable sector, providing a longer term storage solution compared to battery storage systems.

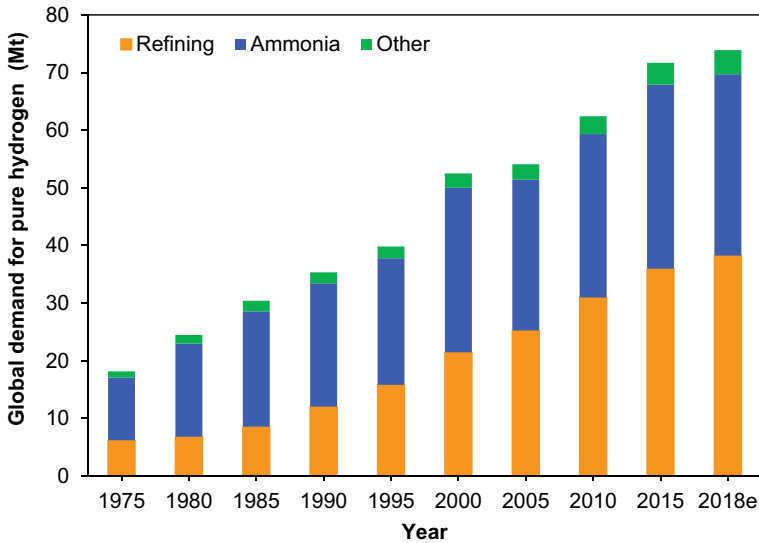

Fig. 18.1 Global demand for pure hydrogen as a function of end usage across time (IEA 2019a, b)

18.3.2.1 Production

The production of grey hydrogen generates significant carbon emissions, and both blue and grey hydrogen require typically large infrastructure and upkeep. Aside from the conventional, thermochemical route to hydrogen production, electrochemical hydrogen production through water splitting is being increasingly considered a viable route. Currently, a much smaller proportion of hydrogen is produced via electrolysis of water owing to higher production costs. Nevertheless, this approach has various benefits as it is both sustainable and highly compatible with small scale delocalized production of hydrogen. Electrocatalytic hydrogen production provides a flexible storage solution which can be built for purpose, and that can be scaled according to demand (IEA 2020a). Hydrogen production through electrolysis offers opportunities to load balance renewable energy technologies such as solar and wind, and offset the intermittency challenge.

Electrochemical hydrogen production uses an electrical current to split water to produce hydrogen and oxygen. For the pathway to be viable from a low carbon perspective, it requires low/zero emission electricity. It is inevitable that the ramping of hydrogen electrolyser value chain is leading to a reduction in their costs and allowing greater application of delocalized hydrogen production in emerging markets.

Of the electrolyser technologies, both alkaline electrolyzers (AE) and polymer electrolyte membranes (PEM) are commercially available while the solid oxide electrolyser (SOE) is still under lab-scale development. AE is reported to be economically

more viable (due to its low capital costs), although recent developments in PEM technology illustrate its potential to compete with AE within a few years. Ultimately, the cost of hydrogen production from both AEs and PEMs is predicted to be significantly reduced as the technology develops, plants scale-up from 1 to 100 MW and with declining electricity pricing. Thus, with the greater uptake of these technologies and with any sort of incentive for reduced emission electricity, renewable hydrogen is anticipated to become increasingly competitive with production costs predicted to reach \$2.29–2.79/kg by 2025 (CSIRO 2019).

PEM and AE require a catalyst, electrolyser and, importantly, a pure (fresh) water feed (with pH adjustment) to produce hydrogen. Producing hydrogen from neutral electrolytes, in particular seawater, without the need to add strong acids or bases, provides a promising route from an implementation perspective. Further, the requirement and use of fresh water poses problems. Fresh water is a scarce and precious commodity throughout the Pacific (see Chap. 2), with complimentary and inter-linked priorities between water, energy, and food needed. Exploiting this necessary commodity for energy therefore poses a difficult ethical and resource allocation dilemma. The ability to exploit seawater to produce hydrogen, however, will have direct benefits to PICTs given their proximity to the ocean (Fig. 18.2) and with the majority of households located in close coastal proximity.

There are significant challenges associated with utilizing seawater to directly produce hydrogen. Material development for direct seawater use has been difficult, leading to low hydrogen production. In addition, seawater contains numerous impurities that will hinder stability. While this technology is not yet at a commercial deployment stage, it is clear the potential benefits, specifically for PICTs, are promising. Further, by recombining the hydrogen and oxygen to produce electricity, purified water can also be produced, offering additional benefits.

18.3.2.2 Storage

One of the key benefits of exploiting hydrogen is its ability for long-term storage of renewable power. This storage lifetime has the potential to be longer than batteries, albeit there are safety and engineering challenges. The highly explosive and low-density nature of hydrogen storage presents significant technical barriers which needs to be overcome before renewable hydrogen can penetrate the market as an alternative to battery storage. At present, hydrogen can be stored through four approaches: (1) compression, (2) liquefaction, (3) transformation, and (4) solid-state storage. While experiencing ongoing research, the ideal approach to large-scale hydrogen storage is yet to be determined.

Of the different storage routes, the most common storage approach for hydrogen is compression via pressurization and storage within carbon/steel composites. Compression storage can also include underground storage and line-packing. Despite its popularity, hydrogen compression is restricted by low volumetric density. Line packing has potential in regions with already established natural gas infrastructure, which is promising in New Zealand and Australia, but is inherently limited throughout

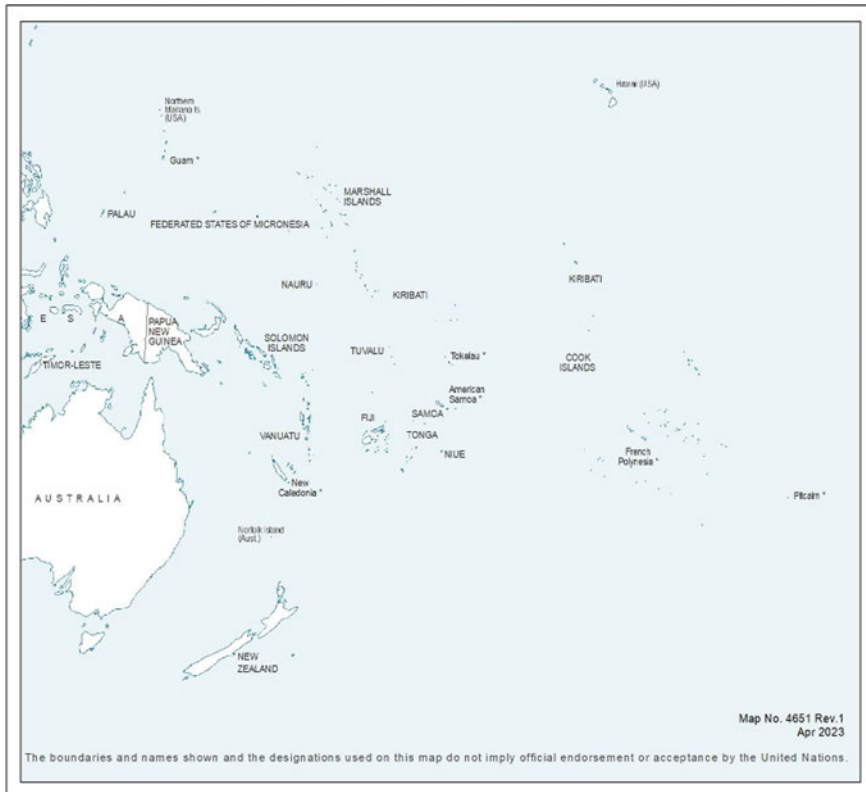

Fig. 18.2 Pacific regional map, adapted from UN Geospatial (2023)

the rest of the Pacific region. Papua New Guinea may also present a unique case as pipeline supply of natural gas to major centres might be feasible if natural gas infrastructure is established from the well-head or via a branch line from the existing pipeline to Port Moresby.

Liquefaction can be done through both cryogenic and cryo-compressed tanks, in both these cases hydrogen is cooled to $-253\text{ }^{\circ}\text{C}$, resulting in low evaporative losses with a high volumetric storage capacity. While both these technologies are promising, they are costly and require expensive storage materials and infrastructure.

Transformation covers the conversion and storage of hydrogen as other carriers such as ammonia and methane. The difficulty associated with these transformations mostly arises from the back conversion to hydrogen and the need for considerable infrastructure. However, if they can be utilized directly (such as through methane for cooking or ammonia for fertilizer), there is potential for significant economic benefit. It should be noted that the conversion to methane will result in carbon emissions when utilized. There is also potential to blend hydrogen into existing natural gas infrastructure to lower the overall carbon output.

Solid-state storage involves the use of metal composites such as metal hydrides to store hydrogen and is gaining increasing research interest. While they are yet to be proven for large-scale commercial applications, recent results and costing reveal that metal hydrides can cost below 0.02 AUD per kW. This amounts to one-tenth the cost of lithium storage competitors and buying power from the grid, making solid-state storage highly competitive (Hannam 2020).

18.3.2.3 Transport and Utilization

Hydrogen can be utilized in a range of ways, some which require extensive infrastructure, others that need no/little adjustments to current infrastructure. In its simplest form, hydrogen can be recombined with oxygen to release energy (and produce water as the only by product). This stationary use of hydrogen, through fuel cells and gas turbine supplementation, can be used to produce electricity, thus balancing the production/demand curves for intermittent renewables. Hydrogen can also be used in portable applications, such as in transportation through fuel cell vehicles for material transport, as well as for passenger cars. Figure 18.3 displays the IEA’s data surrounding policy support and incentives for hydrogen deployment as a function of use type around the world. It is clear that most countries are focusing on hydrogen deployment to decarbonize the transportation sector. With the exception of Australia, land masses and the need for extensive land-based transport of energy in PICTs are limited, with delocalized hydrogen generation more suited in this instance.

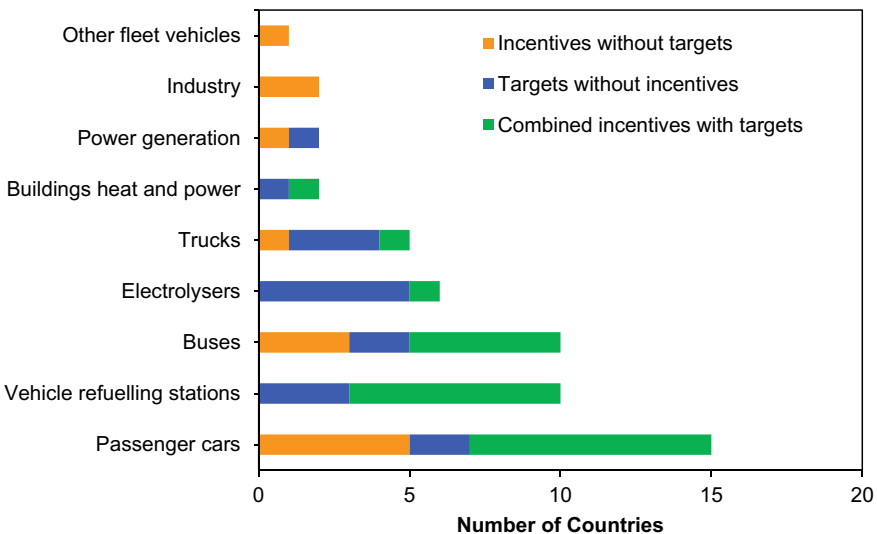

Fig. 18.3 Current policy support for hydrogen deployment. It is seen that a number of countries have developed favourable policies to encourage hydrogen fuel cell driven transportation (IEA 2018)

18.3.2.4 Summary and Applicability

Exploiting clean hydrogen can assist in decarbonizing a range of sectors and aid PICTs in improving their energy security. Hydrogen holds the ability to support the integration of renewables into the sector, allowing the storage of energy in week to month timeframes. Ultimately, continued research efforts and scaling-up systems will see the costs of technologies for producing, storing, and utilizing clean hydrogen drastically reduced.

The world is increasingly looking toward hydrogen as a potential fuel for the future. Global North nations, such as Japan and Germany, are playing instrumental roles in driving this transition. For example, as part of the 3E+S (energy security, economic efficiency, and environmental protection, plus safety) strategy, Japan plans to establish a “hydrogen economy” by 2050. While Global North countries are driving the change, countries in the Global South (such as the LDC and SIDS) have potential to “be the big winners” in the shift toward the hydrogen economy (Zhai 2019). On both the supply side as well as export potential, Global South countries have the ability to exploit renewable energy resources to produce hydrogen.

Island nations have been proposed as ideal demonstration sites for the realization of the hydrogen economy, including emerging hydrogen technologies. This is because hydrogen has the potential to promote energy autonomy, be used at scales ideal for island nations, and its low emission nature means it can aid in preserving the pristine environments across PICTs (Barbir 2010). In 2011, a demonstration unit of renewable power-driven hydrogen generation, storage and utilization system was established in the remote Aegean Island of Bozcaada, Turkey by a consortium of United Nations Industrial Development Organization (UNIDO), and the International Centre for Hydrogen Energy Technologies (ICHET) (Hydrogenics 2011). The system comprised a 20 kW solar photovoltaic array, a 30 kW array of wind turbines and a 50 kW electrolyser with a hydrogen storage system. The system is capable of subsequently converting hydrogen back to electricity using a 20 kW fuel cell and a genset engine (3 kW). The system was designed to supply 20 households (or equivalent) with uninterrupted electricity for up to 24 h (Barbir 2010).

Currently the uptake of hydrogen as an energy vector within PICTs is low. With the exception of both Australia and New Zealand, who have comprehensive and ambitious hydrogen plans, the smaller PICTs as well as the LDCs and SIDS have no established plans. In fact, many of the “Energy Roadmaps” for the LDCs and SIDS do not even mention hydrogen (Government of the Republic of the Marshall Islands 2018). In 2010, a joint venture between the Cook Islands and UNIDO-ICHET proposed a \$3.38 million hydrogen plant on Aitutaki in the Cook Islands. The proposed project was planned to account for less than 10% of the island’s energy demand. However, the proposed project was postponed on grounds of excess capital expenditure which outweighed the benefits to the island (Cook Island News 2011).

On continuing to advance the knowledge, capability, reduce the cost, and increase the safety of renewable/hydrogen systems, their ability to make real impact within PICTs exists. Ultimately, reducing the capital costs of electrolyser systems, as well as increasing the infrastructure surrounding hydrogen use, can advance the use of

hydrogen as an energy vector in the Pacific. One particular technological advancement, the use of direct seawater electrolysis, has potential to transform the energy makeup on PICTs.

18.3.3 Hydrocarbons as a Vector

Methane (CH₄) is the primary component of natural gas and arguably is the cleanest combusting fossil fuel. Natural gas is often liquified for transportation and storage, as liquid natural gas (LNG). Liquid petroleum gas (LPG) consists mostly of propane and butane. All PICTs already use LPG, mainly for household cooking (Oil and Gas Today 2019).

The combustion of fossil fuels for cooking and heating produces CO₂ emissions, however in comparison to alternative approaches (burning biomass or kerosene), using LPG and LNG is a cleaner alternative offering significantly lower environmental and health impacts. Honourable David Day Pacha (the Minister of Energy, Mines and Rural Electrification) in the Solomon Islands, addressed a conference in 2016 stating that the transition to LPG would have “benefits to communities [that] are significant as it enables activities to be performed at night including education, avoiding time spent collecting traditional fuels and removing the risks associated with open fires such as respiratory diseases” (Posts 2020).

For over 50 years, LPG has been supplied to the Pacific, through Origin Energy, for use in domestic, commercial, and industrial applications. Fiji is currently the largest LPG market in the Pacific, consuming around 13,000 tonnes of LPG per annum. There are two LPG carriers operated by Origin Energy, which are capable of supplying 28,000 tonnes per annum to 19 ports within the Pacific region (16 of which are serviced by Origin) (Oil and Gas Today 2019).

The use of LNG and LPG within PICTs sees the region rely on their import and is impacted by fluctuating prices associated with fossil fuels. As a result, local decentralized production of hydrocarbons may improve the security and stability of energy production in the region. As discussed in Chap. 12, biofuels and waste-to-energy approaches are currently being utilized in the PICT. Section 18.3.4.1 will focus on near-to-market technologies for these approaches which have the potential to hold significant benefit, particularly in the Pacific.

18.3.3.1 Onsite Hydrocarbon Production

The production of methane as a fuel (biogas) from waste is becoming increasingly popular, particularly in Global South countries. Biogas consists mostly of biomethane (50–70%), along with carbon dioxide (25–45%) and traces of other gases including hydrogen sulphide, water vapor, and ammonia. From biogas, purification can be used to produce biomethane by removing the other components.

Globally in 2018, 35 million tonnes of oil equivalent (Mtoe) of biogas and biomethane was produced where their assistance in transforming the energy sector worldwide is a strong prospect. In PICTs the use of biodigesters has been mostly restricted to small demonstration sites, majorly focused on piggeries. Thus, current utilization rates in PICTs represent only a small fraction of their potential.

Biogas is typically produced by anaerobic digestion (microorganisms breakdown biodegradable feedstocks in the absence of oxygen). The digestion produces biogas and digestate. The digestate is a solid, sludge like material rich in nutrients that can be used as a fertilizer, as an alternative to chemical fertilizers—helping to secure agricultural food sources and reduce commercial fertiliser purchase and import costs.

A wide range of feedstocks can be exploited for biogas production (IEA 2020b). This allows significant versatility, as site-dependent feedstocks can be exploited in PICTs. The most common feedstocks are animal waste and crop residue. However, municipal solid waste and industrial waste can also be utilized. Smaller, decentralized facilities can be utilized for individual homes while larger facilities can be used across multiple homes as a cooperative project. Another significant benefit is, once established, digesters have minimal cost and upkeep requirements.

If properly established, digesters can aid in reducing environmental footprints through the prevention of greenhouse gas emissions. It has been estimated that biomethane can suppress the emission of ~ 1,000 million tonnes of greenhouse gases by 2040 (IEA 2020b).

To maximize biogas production, research has examined pre-treating the feedstock. Pre-treatments include physical milling, extrusion, heat treatments, microwave treatment, and acid/base treatments. (Achinas et al. 2017) The treatments have been shown to significantly (5–20%) increase methane yield by increasing the biomass surface area and breaking down ligands, aiding in digestion. The pre-treatment technologies can enhance yield; however, they add cost and complexity to the process. There remains a current gap between the research and how it translates into commercialization.

18.3.3.2 Onsite Hydrocarbon Utilization as an Emerging Fuel Source

The biogas can be stored and used directly, this being a particularly feasible route in the LDCs. It is becoming increasingly common to upgrade the produced biogas. The direct utilization of biogas is typically accompanied with a simple pre-treatment to remove hydrogen sulphide by passing the gas through water. The gas can then be combusted directly. The biogas can be used for power, heating, or as a clean alternative to the solid biomass used in cooking in LDCs. Depending on the feedstock and digestion conditions, this can result in significant carbon dioxide emissions.

18.3.3.3 Barriers to Entry for Hydrocarbons as a Vector

According to the IEA (2020b), the Asia/Pacific region holds the greatest opportunities for utilizing biogas. This can be attributed to the decentralized nature of the PICTs, as well as rising natural gas/LPG import and consumption.

One of the biggest inhibitors to the implementation of this technology is the lack of knowledge and knowhow. In particular, the lack of knowledge on the attainable biogas levels and optimum digester conditions for a given feedstock is a significant deterrent (Ward 2013). It has been estimated that the quantity of biogas that can be attained from taro crop residues throughout Samoa is approximately 18 million cubic meters per annum.

18.3.4 Ammonia

Globally, approximately \$60 billion worth of ammonia is produced every year for utilization, mostly in the form of fertilizers. Recently, ammonia has been gaining attention as a hydrogen carrier for the hydrogen economy. Ammonia stores close to double the energy of liquid hydrogen (on a volume basis) and is simpler to transport and distribute compared to hydrogen.

The commercial Haber–Bosch process for producing ammonia was developed in the early Twentieth Century. The process necessitates high pressures (150–250 atmospheres) and temperatures (400–500 °C). Additionally, relatively high purity hydrogen and nitrogen feeds are required. Consequently, the process consumes a significant amount of energy and is fundamentally incompatible with small scale, decentralized ammonia production and accommodating renewable energy is unfeasible. PICTs have limited ammonia production capacity via this route and thus limited potential. However, as technology develops and ammonia production moves away from large scale, high capital requirements, LDCs within PICTs will have an increasing role to play. The potential options for ammonia use as an energy vector include in transport (particularly for heavy vehicles), directly in power generation, and as distributed energy storage. Within PICTs, beyond a potential energy vector, ammonia has the ability to enhance food security. Sweet potato is an important crop for the food security, particularly in the island countries in the South Pacific (Hartemink et al. 2000). In Papua New Guinea approximately 60% of the total dietary energy requirements is met by the consumption of sweet potato tubers. Further, cocoa is a significant export vector in Papua New Guinea as well as many countries throughout PICTs (Fidelis and Rajashekhar Rao 2017). These demonstrate that much of the food, and export within the LDCs in the PICTs rely heavily on agriculture, where the ready availability of fertilizer can play a significant role.

18.3.4.1 Ammonia Generation and Utilization

In recent years, technology development towards renewably powered small-scale delocalized production of ammonia rapidly evolved. While the direct synthesis of ammonia electrocatalytically is far from at a stage of commercialization, there remains promise in the emerging technologies, such as the Li-intermediary approach.

As previously discussed, throughout PICTs, diesel generators are key energy sources, supplemented by variable renewable energy (solar and wind). It has been proposed that small to medium scale generators can run effectively on ammonia that is produced and stored locally, in a decentralized on-site and on-demand manner. The direct use of ammonia, as a fuel to substitute diesel can already be seen in small-scale engine demonstrations. For example, a 3.5 kW power generator has been adapted to run in a dual-fuel mode coupled with (and substituting ammonia) for diesel with an ammonia content of up to 80% (Macfarlane et al. 2020). While this has not been directly employed in PICTs to date, the potential to substitute diesel with green ammonia remains an emerging opportunity.

Alternately, ammonia can be produced as a feedstock for hydrogen storage. New technology, developed by CSIRO, can extract hydrogen from ammonia, allowing the ammonia, which is simpler and cheaper to store and transport, to be used as an energy vector (Dolan 2017). The CSIRO technology has the potential to produce hydrogen from ammonia at 5 kg/day (Dolan 2017).

18.4 Energy Production from Waste Plastic

PICTs have a significant issue in dealing with plastic waste. While plastic waste is recycled in many developing countries, landfill and open disposal is common practice in PICTs (Mamad et al. 2018). Over 300,000 tonnes of waste plastic is generated by PICTs per annum, with much of it ending up in coastal water (Australian Government 2020). Plastic is essentially unavoidable in today's society, however the impact the waste has on PICTs is amplified by the regions reliance on fishing and tourism (Lebreton et al. 2018). Thus, there exists an avenue to exploit this waste as a resource.

Plastics are comprised of petrochemical-based hydrocarbons with stabilizing additives, thus making them difficult to degrade. The plastics can be utilized as raw materials, where the pyrolysis of waste plastics into fuels has potential use as a resource for the decentralized electricity production throughout the region while simultaneously reducing plastic waste.

The pyrolysis of plastic waste involves its thermal degradation into fuels (solid, gas and liquid) where it is heated at high temperatures (300–900 °C) in the absence of oxygen (Miandad et al. 2019). The plastic breaks down and produces a range of gases (hydrogen, methane, carbon dioxide, carbon monoxide, etc.), as well as liquid oil products with different chain lengths (Dayana et al. 2016).



Fig. 18.4 Nufuels Ltd demonstration plant for plastic pyrolysis to produce energy in the Solomon Islands (©Nufuels 2020)

Demonstration plants for waste plastic pyrolysis are beginning to be built throughout PICTs, including the Solomon Islands. The technology reduces both plastic waste and emissions associated with direct combustion of plastic waste while producing fuels for direct use in cooking and electricity generation.

Nufuels have built an integrated system which uses pyrolytic conversion to produce energy for cooking, as well as electricity from waste plastic bags and bottles. The system has potential to be extended to biomass conversion in a similar manner discussed above (in Sect. 18.3.3). The Nufuels integrated system, shown in Fig. 18.4, is simple to use and can be operated and maintained by locals.

New technology developed by the University of Sydney, Cat-HTR, has potential to improve yields for plastic pyrolysis. Cat-HTR uses water, high pressure, and high temperature to convert plastic into gases for cooking, as well as liquid fuels. In 2019, the Government of Timor-Leste began preparing a memorandum of understanding with Mura Technology to begin developing the use of Cat-HTR technology in the region (Government of Timor-Leste 2019). The proposed plant will be capable of processing 20,000 tonnes of plastic waste annually, while producing 17,000 tonnes of synthetic fuels. The process will include a pay-for-plastic system where the people of Timor-Leste will contribute to “safe and clean drinking water in schools and improve sanitation, provide essential resources for education, and provide low-cost energy from renewable energy sources in rural areas” (Government of Timor-Lest 2019).

18.5 Conclusions and Outlook

This chapter has outlined emerging technologies that have potential to aid in the transition to a clean energy future in the Pacific region. The current global trend driving movement away from centralized, fossil fuel-driven electricity production is being driven by increased environmental awareness, desire for national independence from fluctuating fossil fuel supplies and prices, as well as a decreasing supplies of finite fossil fuels. This has led to a substantial increase in research toward (1) renewable electricity generation and (2) conversion of energy (both renewable electricity, known as Power-to-X, as well as energy held within plastics and biodegradable waste, Waste-to-X) into a range of energy carriers for use and storage.

While the growth of research toward these decentralized energy generation, distribution, and utilization approaches is being driven from a global approach, the potential implications for the Pacific region are vast. As identified in Chap. 12, a transition to renewable energy in the Pacific region is evident, although there remains a continued reliance on fossil fuels to satisfy growing energy demand. Significant scope exists for newly developed, near-to-market technologies to expedite the transition in this region. The nature of PICTs is characterized by a large degree of variability in terms of development; energy, food, and water security; and resources. The low energy security, and lack of access to electricity and clean cooking technologies, which defines the SIDS and LDCs throughout the region also indicates that rapid change is needed. The nature of the region presents barriers to the transformation of the sector as well as a range of advantages, such that the sector is uniquely positioned to drive the transformation.

Battery technology is arguably the closest to market technology for load balancing in the use of variable renewable energy in PICTs. The increase in battery research, novel material engineering approaches, as well as the impact of scaling from increased production means prices are becoming more competitive. Unfortunately, the limitation in terms of short storage timescales, high capital costs, and required “knowhow” hampers direct implementation. The development of hydrogen technologies, in particular, the further-from-market hydrogen production directly from seawater has a unique opportunity in the Pacific region. While there are limitations from a technological development perspective, as well as barriers to entry from a capital expenditure perspective, there remains promise for implementation.

The conversion of waste (biodegradable and plastic) into solid, liquid, and gaseous fuels, has significant potential within the Pacific region as well. This technology is rapidly developing and cheap to install with low maintenance costs. New developments in catalyst incorporation to tune the ratio of the products, post-treatment technologies (to upgrade the gases produced), and the incorporation of water in high pressure pyrolytic upgrading has been shown to increase yields significantly.

Ultimately, the Pacific region is uniquely positioned to aid in the transformation to delocalized, sustainable, tailored energy generation, storage, and utilization. As the technologies continue to develop, the suitability for their implementation in the

region follows. With the appropriate policy and incentive frameworks there is much optimism for energy security in the Pacific.

References

- Achinas S, Achinas V, Jan G, Euverink W (2017) A technological overview of biogas production from biowaste. *Engineering* 3(3):299–307. <https://doi.org/10.1016/J.ENG.2017.03.002>
- Andrew NL, Bright P, de la Rua L, Teoh SJ, Vickers M (2019) Coastal proximity of populations in 22 Pacific Island Countries and Territories. *PLoS ONE* 14(9):1–15. <https://doi.org/10.1371/journal.pone.0223249>
- Australian Government (2020) Pacific Ocean Litter Project What's the problem we're working on? What is Australia doing? Department of Agriculture, Water and the Environment
- Balza L, Gischler C, Janson N, Miller SJ, Servetti G (2014) Potential for energy storage in combination with renewable energy in Latin America and the Caribbean (February)
- Barbir F (2010) UNIDO-ICHET's hydrogen islands initiative projects update
- CSIRO (2019) National hydrogen roadmap, pp 1–116
- Cook Island News (2011) Puna stops Aitutaki hydrogen plant. *Cook Island News*, Rarotonga, Cook Islands
- Dayana S, Sharuddin A, Abnisa F, Mohd W, Wan A (2016) A review on pyrolysis of plastic wastes. *Energy Convers Manag* 115:308–326. <https://doi.org/10.1016/j.enconman.2016.02.037>
- Deloitte (2019) Australian and Global Hydrogen Demand Growth Scenario Analysis COAG Energy Council – National Hydrogen Strategy Taskforce. (November)
- Dolan M (2017) Delivering clean hydrogen fuel from ammonia using metal membranes. 2017 AIChE Annual Meeting, Minneapolis
- European Commission (2017) Energy storage – the role of electricity. 1–25. Brussels
- Fidelis C, Rajashekhar Rao BK (2017) Enriched cocoa pod composts and their fertilizing effects on hybrid cocoa seedlings. *J Recycl Org Waste Agric* 6(2):99–106. <https://doi.org/10.1007/s4093-017-0156-8>
- Government of Timor-Leste (2019) Government prepares partnership for plastic transformation. Government of Timor-Leste
- Government of the Republic of the Marshall Islands (2018) Navigating our energy future: Marshall islands electricity roadmap
- Hannam P (2020) Alchemy of energy: breakthrough offers mass hydrogen storage options. *The Sydney Morning Herald*
- Hartemink AE, Poloma S, Maino M, Powell KS, Egenae J, O'Sullivan JN (2000) Yield decline of sweet potato in the humid lowlands of Papua New Guinea. *Agric Ecosyst Environ* 79(2–3):259–269. [https://doi.org/10.1016/S0167-8809\(00\)00139-0](https://doi.org/10.1016/S0167-8809(00)00139-0)
- Hydrogenics (2011) Hydrogenics contract for first hydrogen fuel station in Turkey. *Fuel Cells Bull* 2011(2):8. [https://doi.org/10.1016/s1464-2859\(11\)70088-8](https://doi.org/10.1016/s1464-2859(11)70088-8)
- IEA (2018) Current policy support for hydrogen deployment. In: International Energy Agency. Paris
- IEA (2019a) Global demand for pure hydrogen. 1975–2018. IEA, Paris <https://www.iea.org/data-and-statistics/charts/global-demand-for-pure-hydrogen>
- IEA (2019b) The future of hydrogen. In: International Energy Agency. Paris
- IEA (2020a) Batteries and hydrogen technology: keys for a clean energy future, IEA
- IEA (2020b) Outlook for biogas and biomethane: Prospects for organic growth. International Energy Agency: World Energy Outlook Special Report
- IRENA (2017) Electricity storage and renewables: costs and markets To 2030. <https://www.irena.org/Publications/2017/Oct/Electricity-Storage-and-Renewables-Costs-and-Markets> (October)

- Johnston P (2013) Pacific perspectives on the challenges to energy security and the sustainable use of energy. UN Economic and Social Commission for Asia and the Pacific (ESCAP) (October 2012)
- Lebreton L, Slat B, Ferrari F, Aitken J, Marthouse R, Hajbane S (2018) Evidence that the Great Pacific Garbage Patch is rapidly accumulating plastic. *Sci Rep* 8:1–15. <https://doi.org/10.1038/s41598-018-22939-w>
- Lomaloma MDDS of the PCC (n.d.) Regional Overview of Energy Situation in the Pacific Island Countries (PICs). Economic Development Division Secretariat of the Pacific Community
- Macfarlane DR, Cherepanov PV, Choi J, Suryanto BHRR, Hodgetts RY, Bakker JM et al (2020) A Roadmap to the Ammonia Economy. *Joule* 4:1–20. <https://doi.org/10.1016/j.joule.2020.04.004>
- Mamad I, Susila MD, Mustofa A, Agung N (2018) Thermal – catalytic cracking of real MSW into bio-crude oil. *J Energy Inst* 91(2):304–310. <https://doi.org/10.1016/j.joei.2016.11.005>
- Matakiviti A, Pham T (2003) Review Of The Fiji Government 1993 rural electrification policy. The Fiji Department Of Energy Review Of The 1993 Rural Electrification Policy Review Report – Final. UN/ESCAP Project for the Fiji Department of Energy: SOPAC Technical Report. p 368 (December)
- Miandad R, Rehan M, Barakat MA, Aburiazaiza AS, Khan AS, Ismail IMI et al (2019) Catalytic pyrolysis of plastic waste: moving toward pyrolysis based biorefineries. *Front Energy Res* 7(March):1–17. <https://doi.org/10.3389/fenrg.2019.00027>
- Norojono O, Maxwell A, Trainor JM, Lee WY, Haider SH, Ramos F (2018) Pacific energy update. Transport, Energy and Natural Resources Division, Pacific Department, Asian Development Bank
- Nufuels (2020) Small scale waste to fuels in the Pacific Islands. Nufuels, New Zealand
- Oil and Gas Today (2019) LPG – providing the Pacific Islands with a cleaner fuel alternative. *Oil and Gas Today*. Victoria, Australia. pp 8–10
- Posts R (2020) LPG and natural gas as alternative energy sources for the Pacific, pp 8–9
- Puliti R, Bazilian MD (2019) How a key energy technology can help developing countries. *Scientific American*. Accessed from <https://blogs.scientificamerican.com/observations/how-a-key-energy-technology-can-help-developing-countries/>
- Saeedmanesh A, MacKinnon MA, Brouwer J (2018) Hydrogen is essential for sustainability. *Curr Opin Electrochem* 12:166–181 <https://doi.org/10.1016/j.coelec.2018.11.009>
- Staffell I, Scamman D, Velazquez Abad A, Balcombe P, Dodds PE, Ekins P et al (2019) The role of hydrogen and fuel cells in the global energy system. *Energy Environ Sci* 12(2):463–491. <https://doi.org/10.1039/C8EE01157E>
- Stock A, Stock P, Sahajwalla V (2015) Powerful potential: battery storage for renewable energy and electric cars. Climate Council of Australia Limited
- UN Geospatial (2023) Map of the World. Copyright United Nations. <https://www.un.org/geospatial/content/map-world-1>
- UNESCAP (2019) Sustainable Energy in Asia and the Pacific: a statistical overview of energy and development. Statistical Perspectives Retrieved from: <https://hdl.handle.net/20.500.12870/3071>
- Vorrath S (2018) One down, five to go: cook Islands begins shift to 100% solar and storage. *Reneweconomy*
- Ward M (2013) Feasibility study for the production of biogas and organic fertiliser in the agriculture and food management sectors in Samoa. UN Food and Agriculture Organisation Sub-Regional Office for the Pacific Apia, Samoa (May)
- Zhai Y (2019) It's clean, powerful and available: are you ready for hydrogen energy? *Asian Development Blog: Straight Talk from Development Experts*, pp 1–4

The opinions expressed in this chapter are those of the author(s) and do not necessarily reflect the views of the UNESCO: United Nations Educational, Scientific and Cultural Organization, its Board of Directors, or the countries they represent.

Open Access This chapter is licensed under the terms of the Creative Commons Attribution-ShareAlike 3.0 IGO License (<https://creativecommons.org/licenses/by-sa/3.0/igo/>), which permits use, sharing, adaptation, distribution, and reproduction in any medium or format, as long as you give appropriate credit to the UNESCO: United Nations Educational, Scientific and Cultural Organization, provide a link to the Creative Commons licence and indicate if changes were made. If you remix, transform, or build upon this book or a part thereof, you must distribute your contributions under the same licence as the original.

The use of the UNESCO: United Nations Educational, Scientific and Cultural Organization's name, and the use of the UNESCO: United Nations Educational, Scientific and Cultural Organization's logo, shall be subject to a separate written licence agreement between the UNESCO: United Nations Educational, Scientific and Cultural Organization and the user and is not authorized as part of this CC-IGO licence. Note that the link provided above includes additional terms and conditions of the licence.

The images or other third party material in this chapter are included in the chapter's Creative Commons licence, unless indicated otherwise in a credit line to the material. If material is not included in the chapter's Creative Commons licence and your intended use is not permitted by statutory regulation or exceeds the permitted use, you will need to obtain permission directly from the copyright holder.



Chapter 19

Geothermal Energy for PICTs



Edoardo Santagata, Klaus Regenauer-Lieb, and Richard Corkish

A geothermal approach to combine renewable energy and alternative design principles.

Abstract The following chapter explores the utilization of geothermal resources to provide energy, food, and water solutions in both urban and rural populations in the Pacific—several of which have vast geothermal reservoirs. A variety of geothermal-based technologies are presented providing alternative approaches to essential services such as electricity, food drying, refrigeration, and desalination. A set of design principles for geothermal solutions in the Pacific is also outlined and explored in further detail via a brief pre-feasibility case study for a geothermal village development on Tanna Island, Vanuatu. Finally, the opportunities of direct heat using underground geothermal implementations are discussed, indicating that these may well be an excellent means to provide low-cost solutions to rural areas, reduce investment risks associated with deeper geothermal well drills, and recycle waste heat to provide a wide range of services.

Keywords Geothermal · Heat · Refrigeration · Renewable · Energy · Sustainable · Development · Cascade · Nature · Vanuatu

E. Santagata (✉) · R. Corkish
School of Photovoltaic and Renewable Energy Engineering, University of New South Wales,
Sydney, Australia
e-mail: edoardo.santagata@unsw.edu.au

E. Santagata
Collaboration On Energy and Environmental Markets, University of New South Wales, Sydney,
Australia

K. Regenauer-Lieb
Energy Transition Institute, WA School of Mines: Minerals, Energy and Chemical Engineering,
Perth, Australia

Minerals and Energy Resources Engineering, UNSW, Sydney, Australia

© UNESCO 2024

415

A. Dansie et al. (eds.), *The Water, Energy, and Food Security Nexus in Asia and the Pacific*, Water Security in a New World,
https://doi.org/10.1007/978-3-031-25463-5_19

19.1 Introduction

Electricity requirements in rural Pacific communities are usually low, attributable to low levels of lighting, cooling loads, and phone charging (Sen and Ganguly 2017). Such requirements may be met with relatively small-scale systems. Photovoltaic installations have been extensively explored but have historically experienced vast challenges in terms of environmental durability (especially in the case of high levels of cyclone incidence), implementation programs, technical training, operation and maintenance, and replacement costs (Lefale and Lloyd 1993; Urmee and Harries 2009).

In terms of renewable sources at large, hydropower is a reliable and mature technology and constitutes a significant portion of total energy production in countries like Fiji, where it displays roughly 134 MW of capacity (or ~52% of total capacity) (IRENA 2015; Weir 2018). It is also an excellent option in its micro-hydro form to meet rural energy requirements (Kuang et al. 2016). However, it requires high rainfall, favourable land conformations, and a large initial investment (Weir 2018). Wind is an excellent solution given its maturity and resource abundance but is still in its early stages of monitoring and assessment in the Pacific (Mofor et al. 2013). Biomass is also traditionally used to meet cooking needs (Connell 2006) and can act as a diesel substitute or additive (Cloin 2007), but presents challenges associated with purpose-grown fuel (timber) displacing agriculture on limited cultivable land. More details on the challenges in the electrification of the Pacific may be found in Chap. 12 of this work and its references.

The Pacific rim is richly endowed in geothermal energy (Oppenheimer 2011). Most prominently, Papua New Guinea, Solomon Islands, Vanuatu, Fiji, Samoa, and Tonga could benefit from this natural underground power (Tawake, 2017). Utilization of this renewable resource can address many of the challenges related to energy access, renewable energy intermittency, rural poverty, fresh food, and clean water sources, thus addressing several of the Sustainable Development Goals (SDGs) set forth by the United Nations (SDGs 17 and 13 especially, but also supporting many others, including SDG 1, 2, 3, 6, and 11).

Geothermal energy, as a baseload power source where large energy storage capacity does not exist, is an ideal complement to other renewable energies such as solar, wind, tidal, and concentrated solar in particular. The longevity of geothermal power installations is also unparalleled in the energy landscape, allowing much of the early technology from the 1960s to still be used today (Fig. 19.1), while the reliable continuous heat supply pays off the initial high upfront investments many times over. Although geothermal energy is a highly competitive and important energy source in volcanic regions, raising enough capital is a major problem. Deep pockets are needed for upfront investment into exploration and drilling to ascertain viability. Consequently, there is an underappreciation of the vast geothermal resources present in several PICTs, with very few projects having been implemented (Lucas et al. 2017).



Fig. 19.1 The Black Current Generator currently in the Ohaaki Geothermal Power Station, New Zealand showcases the robustness of the technology where many early generators from the 1960s are still operable today (©Klaus Regenauer-Lieb)

At the appropriate scale, locally generated geothermal energy may be particularly attractive for small island communities in the Pacific due to their high dependency on imported diesel (which incurs high ongoing fuel costs) and the fixed costs of extending energy access to disperse and isolated settlements. The average cost of electricity paid by small domestic consumers across the Pacific varies dramatically depending on international diesel prices, electricity tariff subsidies, utility regulatory fees, and government taxes (Utilities Regulatory Authority of Vanuatu 2019). In general, the average electricity price in the Pacific is roughly 0.21 USD/kWh—or roughly on the same level as France, but with the Pacific having only 11% of its GDP per capita (Utilities Regulatory Authority of Vanuatu 2019; Statista 2021). This has placed a burden on island communities and is an immense barrier to rural electrification, as income in these areas is insufficient to bear energy costs (Dornan 2014).

Most geothermal power stations are large, costly, and can sometimes function as a nucleus for large subsidiary industries based around waste heat from the power plant. Pioneering installations in Iceland and New Zealand provide testimony of the economic and environmental success of subsidiary industries, displaying a plethora of waste heat uses including timber drying, food drying, aquaculture, greenhouses, and thermal spas (Dell et al. 2013; Kelly 2011).

However, there also exist plentiful small-scale geothermal solutions (Lund et al. 2005, 2011) which may be more aligned with the technological and financial capacity, and traditional modalities of living, of rural communities across the Pacific (Dornan 2014, Rousseau and Taylor 2012). Until large development banks provide investment capital and local land disputes are resolved, these small-scale systems provide a low capital entry into geothermal energy, mostly involving direct heat use rather than electricity generation. This greatly reduces the upfront capital needed and the risks associated with failed exploration drilling, environmental damages, and community project failures.

This chapter looks at alternative energy pathways to enable a transition from either a substantial diesel dependency or complete absence of modern energy services to geothermal developments. An extensive array of small-scale geothermal technologies are explored as meaningful solutions to secure water, energy, and food security in PICTs. Discussion of some larger scale systems is also included, although these are dependent on greater financial resources. A set of design principles centred around a bottom-up community approach and efficiency maximization is presented. A pre-feasibility case study for a remote community on Tanna Island in Vanuatu, conducted in partnership with University of New South Wales (UNSW), is also presented in support of the geothermal technologies and design principles hereby explored.

19.2 Geothermal Resource Assessment

South-western PICTs are located in an area with prominent seismic and volcanic activity. This activity is mainly driven by subduction zones formed between various oceanic plates (Fig. 19.2), or by deep mantle plumes interacting with surface plates (Pettersen 2016). As a result, vast geothermal resources are present. Table 19.1 summarizes these as per McCoy-West et al. (2011). The countries with the highest number of thermal areas are Fiji, Papua New Guinea, and Vanuatu, with hot springs temperatures ranging from 30 °C to 200 °C. Other countries listed in Table 19.1 are either yet to be assessed in terms of geothermal potential or do not present any viable heat sources.

19.2.1 Geothermal Energy in Fiji

The Fijian Department of Energy, in collaboration with the International Renewable Energy Agency (IRENA), commissioned a Renewables Readiness Assessment (IRENA 2015). The report, which identifies a wide variety of opportunities for renewable developments in the country, features an overview of the geothermal potential in Fiji (Fig. 19.3). The currently known total geothermal capacity is reported as 42 MW for Vanua Levu (twice the island's current needs) and 28 MW for Viti Levu. Although hot spring activity is widespread and several development proposals have been put

Fig. 19.2 Ocean bathymetry of South-West Pacific. The Solomon Island Arc (SIA) is highlighted as a zone with high convergence between the Indo-Australian and Pacific plates (©Tapster et al. 2014 Geological Society of America. Gold Open Access. This paper is published under the terms of the CC-BY license. Figure created with GeoMapApp (www.geomapapp.org) / CC BY)

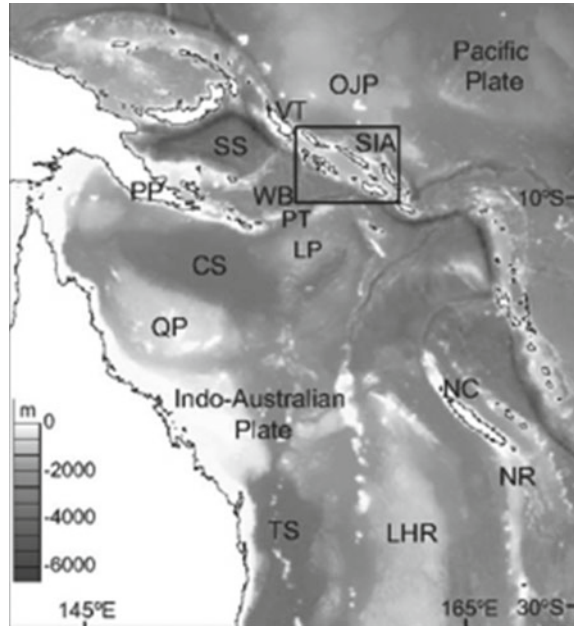

forward, there has been no exploratory drilling at the time of the publication of this book.

A suitable area for geothermal applications is the Savusavu hot spring area, in Vanua Levu. The boiling springs are currently used for cooking purposes (Fig. 19.4) and were described by early European explorers as displaying an intermittent geyser behaviour with hot water ejections at 12–18 m of height (Guppy 1903; Cox 1980), although these have now ceased. Ásmundsson (2008) provides the most recent publicly available scientific report on the South Pacific’s hot spring activity, reporting at least eight thermal springs near Savusavu.

Key information from a Japanese Government report to the Fiji Government in 2009 was released stating that there is “a potential for 23 MW of geothermal-based electricity generation in Vanua Levu, at least 20 MW of which is near to the urban centres of Savusavu and Labasa (10 MW is near to each grid)” (IRENA 2015).

In the medium to long term, the Fijian Government proposes to build a new USD 600 m (excluding exploration costs) geothermal installation with a 150 MW_e geothermal capacity (Fiji Ministry of Economy 2018). Although geothermal energy is a highly competitive and an important energy source in volcanic regions, raising sufficient capital to cover the high upfront costs of exploration to ascertain viability is a major barrier to its implementation (Richter 2017).

Table 19.1 Summary of geothermal resources in PICTs, including indication of temperatures recorded at various hot spring locations, the state of geothermal developments, and volcanic activity.

	Youngest volcanism	Heat source	Geothermal locations	Hot Spring temperature range (°C)	Development barriers	Development potential
Fiji	Last 50 ka	Excellent	53 thermal areas	31–102	–	High
Papua New Guinea	Last 500 a	Excellent	41 thermal areas	36–101	Rugged Terrain	High
Vanuatu	Last 500 a	Good	20 thermal areas	30–200	Active Volcanism	High to moderate
Tonga	Last 500 a	Good	Hot springs	–	Distance to population	Moderate
N. Marianas Islands	Last 500 a	Excellent	Submarine only	–	Active Volcanism	High to moderate
Samoa	Last 500 a	Good	Prospective rift valley	–	–	Moderate
Solomon Islands	Last 500 a	Good	8 thermal areas	57–99	–	High to moderate
New Caledonia	Unknown	Unknown	2 thermal areas	22–43	–	Moderate
French Polynesia	Last 50 ka	Possible	Submarine?	–	–	Low to moderate
American Samoa	~1 Ma	Possible	None	–	–	Low
Cook Islands	1.5 Ma	Possible	None	–	–	Low
Pitcairn	0.45 Ma	Possible	None	–	–	Low
Palau	~20 Ma	None	None	–	–	Extremely low
Guam	~32 Ma	None	None	–	–	Extremely low
Niue	>20 Ma	None	None	–	–	Extremely low
Kiribati	~80 Ma	None	None	–	–	Extremely low
Marshall Islands	~80 Ma	None	None	–	–	Extremely low
Micronesia	Unknown	None	None	–	–	Extremely low
Nauru	Unknown	None	None	–	–	Extremely low

(continued)

Table 19.1 (continued)

	Youngest volcanism	Heat source	Geothermal locations	Hot Spring temperature range (°C)	Development barriers	Development potential
Tuvalu	Unknown	None	None	–	–	Extremely low

(Adapted from McCoy-West et al. 2011)

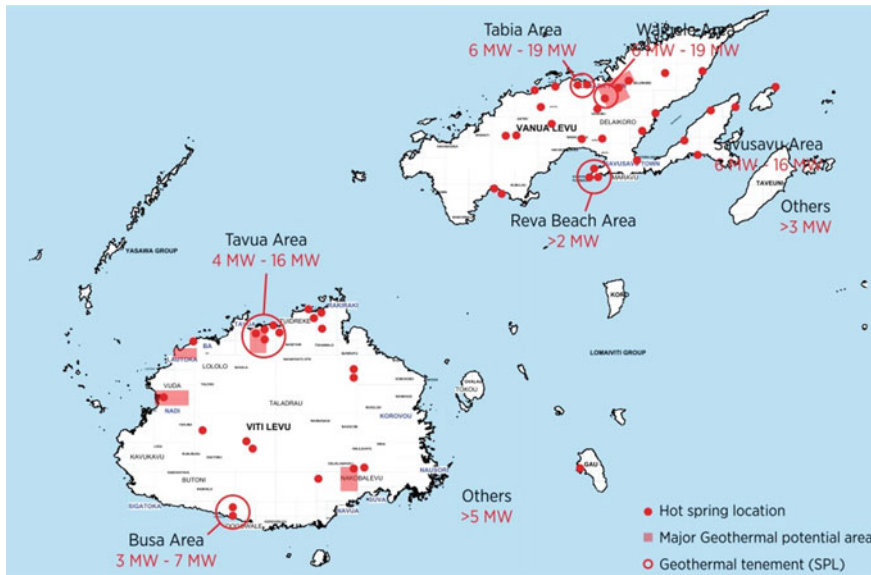

Fig. 19.3 Geothermal potential of Fiji compiled by the Government of Fiji, Rapid Assessment and Gap Analysis February 2014 (©IRENA 2015)

19.2.2 Geothermal Energy in Papua New Guinea

Geothermal resources in Papua New Guinea (PNG) may be of either volcanic or radiogenic nature due to the geological makeup of the area, which is also rich in copper and gold deposits (Berhane and Mosusu 1997; Williamson and Hancock 2005; Kawagle 2005). Several reconnaissance studies, some of which are associated with mining interests, have been conducted, especially in New Britain in the Islands Region of PNG (McCoy-West et al. 2011; Williamson and Hancock 2005). However, there is a lack of geochemical and geophysical data in the public domain for many areas. Figure 19.5 provides an overview of the country’s geothermal areas.

The sole geothermal electricity development in PNG is a 68 MW plant located at Newcrest’s Lihir epithermal gold mine in New Ireland in the Islands Region of PNG, accessing a 240–300 °C hydrothermal reservoir (Australian Geothermal

Fig. 19.4 Near-boiling temperature hot spring in Savusavu used for cooking. Chemical analysis of the hot spring water suggests 170 °C at depth in this area—although slim holes drilled to a depth of at least 800 m are recommended for confirmation (Ásmundsson 2008), © Klaus Regenauer-Lieb

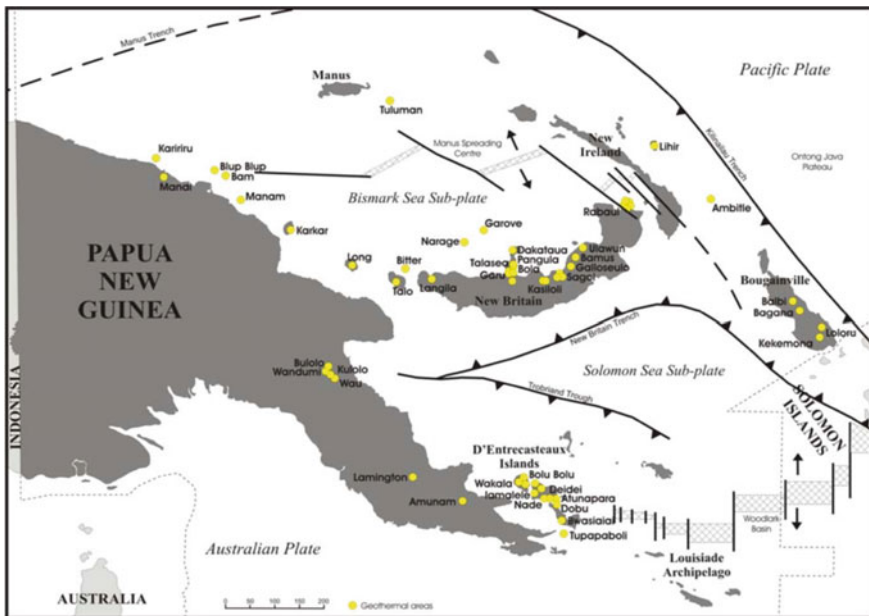

Fig. 19.5 Overview of geothermal areas in PNG (Source McCoy-West et al. 2011)

Association 2020). There are two main reservoirs on-site: a shallow reservoir (5–600 m, 240–250 °C) and a deep reservoir (>1000 m, 250–300 °C). Several drillings were carried out to depressurize the geothermal aquifers to allow for on-site mining. The geothermal plant was initially developed in 2003 with a 6 MW_e capacity, with successive developments in study phase.

Strong interest has been expressed in geothermal energy due to the region's high fossil fuel prices (maximum retail diesel price around USD 0.94/L [Vukikomoala and Wainibalagi 2019]) and the haphazard nature of the hydrological cycles for the country's hydropower plants (Kuna and Zehner 2015). It was also suggested that small-scale geothermal systems may prove to be beneficial for the development of rapidly growing communities across the country (McCoy-West et al. 2011).

On August 18, 2020, a PNG government press release introduced the country's novel Geothermal Resource Policy. Under the policy, all explorations and developments related to geothermal resources are allowed under governance of the Mineral Resources Authority (via the Mining Act 1992), thus providing a dedicated legislative and regulatory framework for developers. Previously, permit applications for developments of this kind were submitted as mineral exploration campaigns or under various mining legislations, resulting in only two applications having been submitted historically (Australian Geothermal Association 2020).

19.2.3 Geothermal Energy in Vanuatu

The volcanic island group of Vanuatu features many geothermal areas (Fig. 19.6) associated with the New Hebrides Trench—a 1200 km long volcanic arc generated by the eastward subduction of the Australian plate beneath the Pacific plate (Brothelande et al. 2016a). There are nine active volcanoes across the country. The main island, Efate, has 21 known hot springs, 15 on Vanua Lava, 12 on Tanna and 10 on Gaua (Brooks 2015). Other islands are also richly endowed in geothermal activity, providing ample local energy resources.

An Australian geothermal company KUTh (now ReNu Energy), obtained prospecting licenses in 2009 and upon completion of initial geophysical and geochemical explorations proposed to construct a 4 MW geothermal power plant on Efate (at site C in Fig. 19.7) in close proximity to the Takara hot spring (KuTh Energy 2010). Environmental and social impact studies have been completed, highlighting a 'medium' residual risk factor for all impacts and a few potential long-term impacts in the social space—mainly relating to perceived inequalities and the marginalization of vulnerable groups (Geodynamics 2014). However, exploration drilling has not yet commenced due to the high cost of drilling (Richter 2017).

Fig. 19.6 Geothermal areas and active volcanoes in Vanuatu (Source McCoy-West et al. 2011)

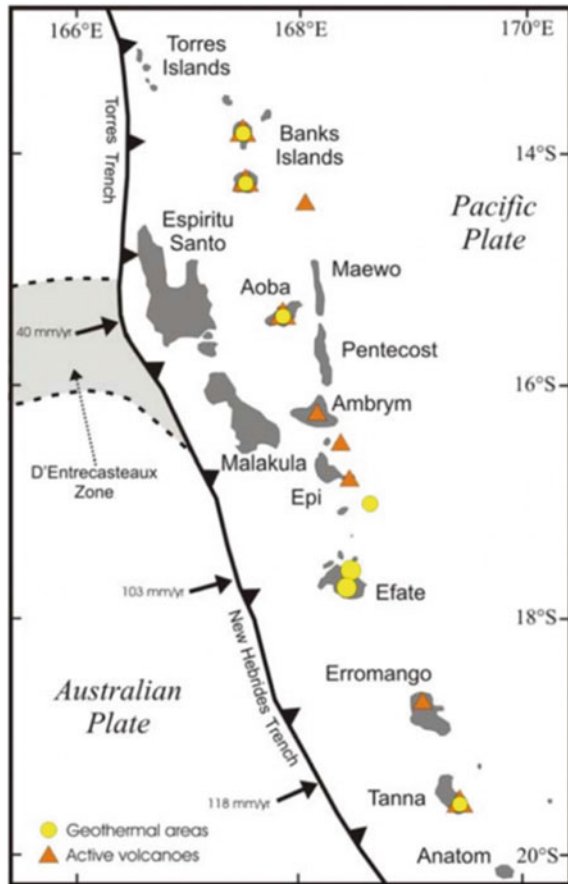

19.2.3.1 Case Study: Tanna Island

Tanna Island is an excellent example of abundant unexploited heat sources suitable for geothermal developments. Some preliminary resource assessments for Tanna Island have been conducted by the Vanuatu governmental Geology Mines Unit in conjunction with several international laboratories and independent researchers (Bloomberg and Leodoro 2016). These include water sampling studies and the development of hydrothermal models for the region, which describe the behaviour of the geothermal reservoirs. However, more comprehensive geophysical, chemical, and remote sensing assessments are required to understand the exploitability of this resource.

On Tanna all geothermal activities are associated with resurgence processes of the underlying Siwi caldera; a large volcanic crater area formed by a previous major eruption. A study by Brothelande et al. (2016b) has suggested that the high degassing rates of sulphur dioxide in the area may signify high associated levels of basaltic magma intrusion. This process is directly related to the substantial uplifting of important

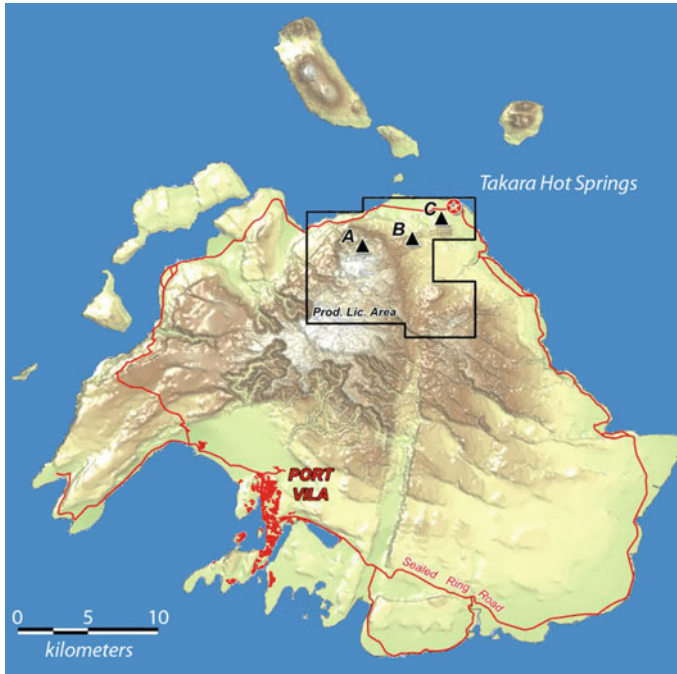

Fig. 19.7 Proposed site of the geothermal power plant near Takara Hot Springs in Efate Vanuatu, at site C. A and B indicate alternative sites for the proposed geothermal installation (Source Brooks 2015)

geological features and thus a frequent seismic activity (with first activities recorded by western researchers in 1878 [Patton 1894]).

The caldera zone (Fig. 19.8) also displays an active volcano, Mount Yasur (361 m above sea level). Its continuous eruptions may indicate high-temperature magma-hydrothermal systems (Merle et al. 2013), which are optimal for larger geothermal power plants. These eruptions have also shaped the geological landscape of the area, forming large lava and ash plains with mounds several meters deep.

Ancient magma-driven geological processes have also allowed for the development of the island's rich coral reef terraces, indicating a stark link between its geothermal resources and rich ecological features (Métrich et al. 2011). A study by Merle et al. (2013) has also analyzed various geological features of the area to provide insights on how the caldera zone may change in the long-term through magmatic migration.

As per a study of Bloomberg and Leodoro (2016) water samples from four different geothermal sources in this area indicate high acidic contents and a mix of meteoric and seawater signatures, suggesting various modes of hydrothermal spring recharge. Geothermometry measurements suggest that underground reservoir waters

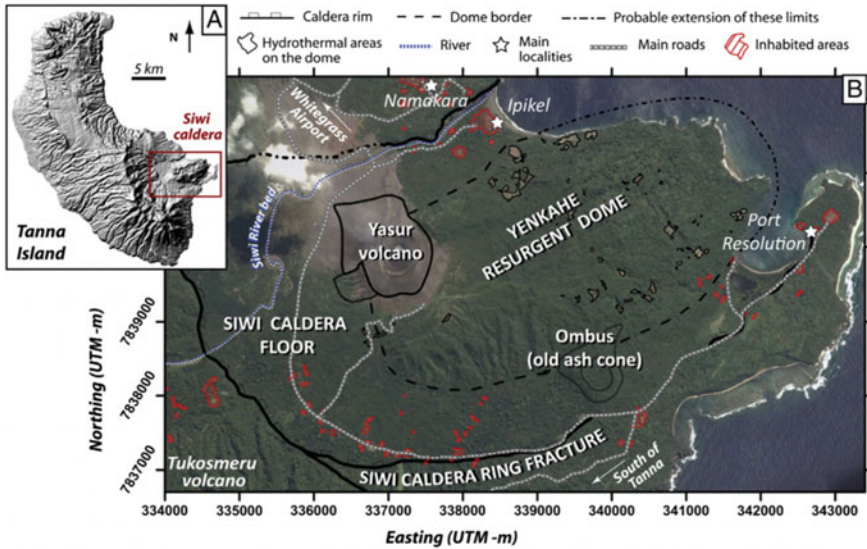

Fig. 19.8 Map of the Siwi caldera area with important surveying features, such as waterways and inhabited areas. Unvegetated areas are marked as surface geothermal features (Source Brothelande et al. 2016a)

boil during ascent and some surface hot springs have recorded discharge temperatures of up to 200 °C, thus suggesting the presence of a low-depth high-temperature heat source. This low depth simplifies drilling endeavours and opens up to a wide variety of geothermal applications including Organic Rankine Cycle plants.

Hydrothermal models of Tanna were also developed (Figs. 19.9 and 19.10) in accordance with an electrical conductivity mapping study conducted by Brothelande et al. (2016a) which had previously indicated potential geological facilitators of fluid flow, such as underground faults. The model includes seawater intrusions, meteoric recharge pathways, ascension/descension patterns, fracture zones, and surface spring manifestations. Overall, the understanding of this geothermal source's behaviour, and others that are similar, is crucial to effectively install technologies to provide energy, food, and water services, as explored in the following section.

19.3 Geothermal Solutions

Technologies that employ geothermal heat to provide a wide range of services, including power generation, refrigeration, and desalination, offer opportunity to improve water, energy, and food security. This section provides the reader with an extensive coverage of geothermal approaches to the energy, food, and water nexus, suitable for implementation in the Pacific.

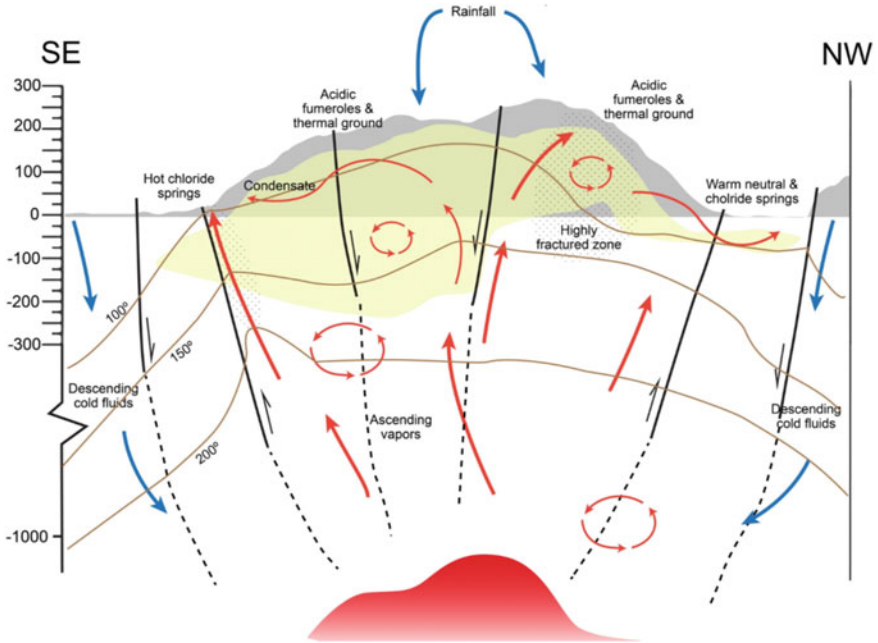

Fig. 19.9 Lateral section of the Siwi caldera (Source Bloomberg and Leodoro 2016)

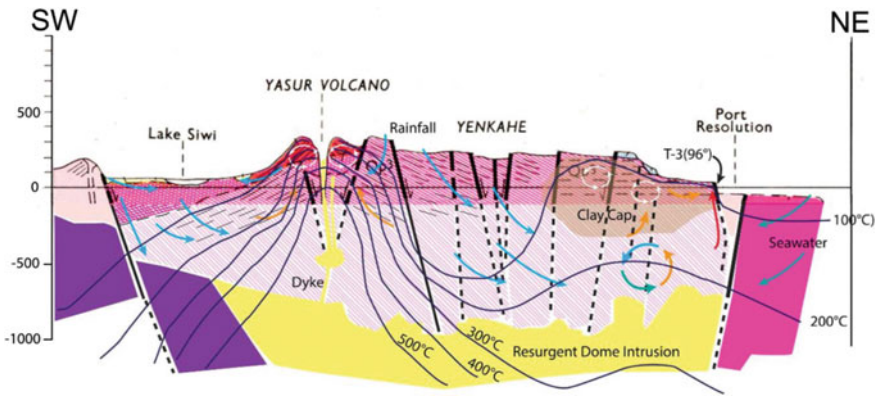

Fig. 19.10 Longitudinal section of the Siwi caldera (Source Bloomberg and Leodoro 2016)

19.3.1 Energy

19.3.1.1 Thermosyphons

Thermosyphons are passive thermal management systems based on the natural convection of the working fluid between a hot and a cold source and thus are ideal to displace heat from one location to another. Thermosyphon systems are used in solar hot water units and are also considered for efficient next-generation superconducting machine designs which have cooling loads in excess of the MW range (Yamaguchi et al. 2019). Thermosyphon systems have also been proposed for electricity generation from low-temperature geothermal heat (Li and Liu 2011; Teimouri and Behzadmehr 2019; Eavor 2021). Thermosyphons could be used in PICTs to harvest heat from shallow geothermal reservoirs for either direct-use applications or power generation in small communities, thus being an important technology to enable access to heat and electricity. However, their usefulness has not yet been demonstrated in practical applications in the Pacific.

19.3.1.2 Electricity

Geothermal power plants vary in scope accordingly to their scale and temperature (DiPippo 2015; Bertani 2016). Large high-temperature systems require deep wells and are the most efficient (direct steam flash). These are usually intended for baseload power in widely interconnected electricity grids as they foresee low energy costs. Small low-to-medium temperature systems are less efficient but foresee smaller capital costs and shallower wells. This makes them more suitable for rural communities which may not have access to an electricity grid.

Organic Rankine Cycle (ORC) power plants (Fig. 19.11) operate on an organic working fluid which vaporizes at reasonably low temperatures (low-to-medium enthalpy). These plants accommodate a wide range of temperatures for the geothermal fluid (90–150 °C) and are therefore highly flexible. Alternatively, smaller power solutions could involve the use of underground thermopiles using the Seebeck Effect to convert a temperature gradient into an electric voltage, or nearshore thermosyphon-turbine-generator systems installed in low-tide conditions to exploit the temperature difference between an underground geothermal reservoir and the cooler, overlying seawater.

Fig. 19.11 Configuration of an Organic Rankine Cycle plant (©2017 Franco and Vaccaro, CC BY 3.0)

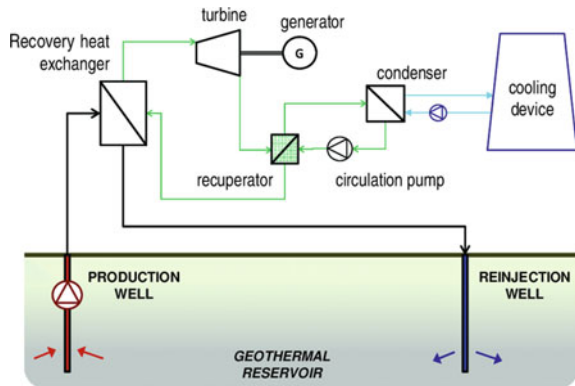

19.3.2 Food

19.3.2.1 Food drying

Food drying is an excellent means of enhancing food product value and creating alternative pathways for food preservation (Chua and Chou 2003). In the Pacific, drying is also used for copra production and the preservation and export of kava, a plant which is used as a beverage with depressant effects utilized in many traditional ceremonies (Lebot et al. 1997). Geothermal drying setups for produce have already been invented in communities living in off-grid areas in both Fiji and Vanuatu. The designs range from gravity-fed geothermal water in between two corrugated iron sheets to dry copra on the top heated surface, to simply exposing the food product to heat from volcanic vents. The latter can contaminate food with sulphur, arsenic, and other noxious compounds present in volcanic gases.

Extrapolating from these local implementations, Fig. 19.12 displays a conceptual design of a low-cost food drying system. This design foresees natural air flow and a multi-tier drying chamber made of bamboo, selected for its versatility, natural abundance in the Pacific, and the augmentation of its structural properties with prolonged heat exposure (McNamara and Prasad 2014; Shangguan et al. 2016). It also presents a variety of node-based construction techniques which render it highly suitable in low-resource environments, where nails and adhesives may be scarce (Schröder 2021). Soil, rock, and ash (perhaps collected by nearby volcanic ash mounds, provided low levels of biotoxicity are ascertained) may be used to fill the interface between the geothermal heat reservoir and the food drying environment to achieve optimal temperatures within the drying chamber. Support structures may also be optimized to facilitate drying of typical products. For example, low-level drainage systems may be integrated in the base heat plate to remove excess water from coconut kernels, thus ensuring optimal dryness within the chamber and minimizing pre-treatment.

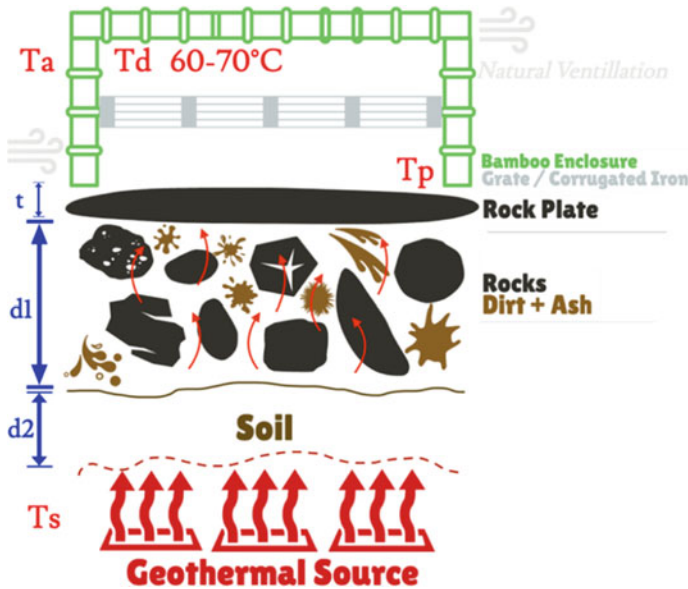

Fig. 19.12 Schematic of a conceptual design for a direct heat use geothermal passive food dryer based on conduction through a dirt, ash, and rock mesh. Uncomplicated architectures and material layouts make the implementation of this design straightforward and within local capacities for rural PICT areas. Relevant material thicknesses (t , d_1 , d_2) may be optimized to achieve a drying temperature (T_d) of 60–70 °C and an optimally associate plate temperature (T_p). This optimization depends on the geothermal source temperature (T_s) and ambient temperature (T_a), as well as average ventilation speeds and the thermal properties of the materials involved. Diffusion-based or heat-and-mass-transfer models may be used to model the system's behaviour (Jay et al. 2005; Kumar et al. 2012) to ensure moisture is reduced to below 25% (©Eduardo Santagata)

19.3.2.2 Refrigeration

Remote communities in PICTs have limited means to store food, although customary ways have long been practised for traditional staple crops, such as drying, fermentation, and storage in dedicated huts (Malolo et al. 1999). The proposed geothermal cooling solution is based on replacing electrically driven vapour compression chillers with heat driven sorption chillers (refrigerator/freezer). The technology is highly scalable so that it may service cooling needs for large commercial buildings, including universities, hospitals, hotels, airports, server rooms, and shopping centres. Hot geothermal water as the principal power source is the most energy efficient means of heating and, counterintuitively, cooling. Ab(d)sorption chillers (for high and low temperatures respectively) have so far only found a niche market for camping and off-grid uses. However, they could also be scaled to use the waste heat from large-scale energy applications, such as an ORC plant, to service an adherent cooling load.

This refrigeration technology (Fig. 19.13) is similar to the ubiquitous electrically driven technology, with the main difference consisting of the use of a thermochemical

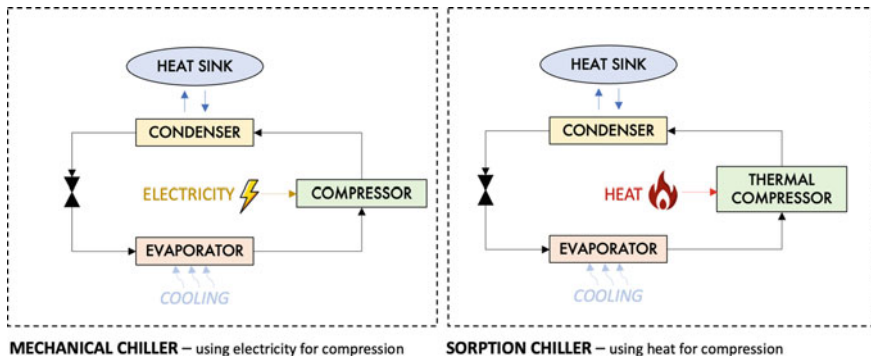

Fig. 19.13 Mechanical chillers versus Sorption chillers (©Edoardo Santagata)

compressor instead of an electric compressor. A small source of electricity is still required for circulating the working fluid, but the pumping power is minor and can be provided by an off-grid photovoltaic (PV) system or a small generator.

Sorption chillers have fewer moving parts and are quieter and more robust than mechanical compressors. This is another reason making them an ideal fit for installation in remote communities, since the need for technical maintenance is reduced. The use of thermal chillers is widespread in tri-generation facilities which supply electricity and use waste heat from a generator to drive absorption chillers for air conditioning settlements in hot climates (Eveloy et al. 2014). Even in cold climates the cooling technology has been used with great effect (Holdmann 2016; Yifru Woldemariam 2019).

19.3.2.3 Greenhouses and Fish Farming

Self-subsistent agriculture and fishing are some of the core foundations of life in many Pacific rural communities. Techniques to enhance these practices via geothermal heat may be beneficial to ensure food security, augment production, and refocus resource utilization practices to facilitate natural resource regeneration (Goldburg and Naylor 2005).

Geothermal heat may be used to ensure stable temperatures for both vegetation and fish; both of which thrive in a range of preferred temperatures. This temperature preferentiality may be used advantageously to farm high-value and high-nutrition species which would otherwise perish in the local environment. This provides new opportunities for both nutrition and small-scale commercial farming and prevents infestations on behalf of non-native species; to which Pacific ecosystems are particularly sensitive due to their condensed nature (Hay and Bells 2007).

Greenhouse heating/cooling may be provided by ground-coupled dual-loop heat pump systems (Fig. 19.14). Cooling occurs by allowing refrigerants in a primary heat pump-driven loop to transfer heat to a secondary underground recirculating

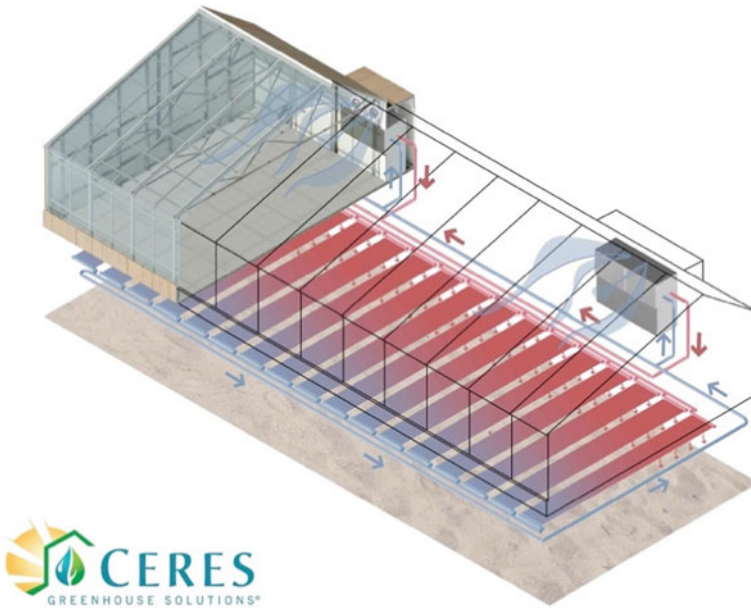

Fig. 19.14 EcoLoop™ design by the company Ceres to provide heating and cooling to greenhouses (Source Ceres 2020)

water loop. Conversely, heating on cold days occurs by absorbing heat stored in the underground loop. In colder climates (e.g., New Zealand), a simpler solution may be adopted by excavating 1–3 m trenches to insert earth tubes, which draw air from the external environment, heat it up using the geothermal source, and carry it inside the greenhouse. Geothermal boreholes for soil heating have also successfully been used to improve agricultural outputs in cold climates (Dell et al. 2011). Similar principles may be implemented for the pond bottom of aquaculture facilities with heat transfer via thermosyphons or direct contact with the geothermal reservoir.

19.3.3 Water

19.3.3.1 Desalination

Although most PICTs receive ample rain, water scarcity is still prevalent due to unfavourable groundwater recharge layouts for small islands, rain shadow areas formed by mountains, and insufficient landmass for rainwater capture (as detailed in Chaps. 2 and 5). As such, water is still being shipped to many small islands during drought (Falkland 2002; SPC 2007). Infrastructure to capture rainfall and clean local water supplies is also insufficient, especially on low lying atoll islands (Falkland

2002). Obtaining clean water is therefore one of the highest priorities to improve the standard of living in the region (UN 2021).

Geothermal desalination involves the use of geothermal heat to evaporate salt water to remove the salt and render it potable. This process does not require electricity and therefore can operate safely in off-grid communities. Basic daily potable water access per capita is defined to be 20 L, within a 1 km or 30 min round-trip, and optimal water access is 100–200 L, via multiple taps in each household (WHO 2017).

Thermal distillation can function with a low-temperature heat source and is highly robust. Aristotle (384–322 BC) reported Greek sailors harvesting freshwater from ocean water by thermal distillation (Ross 1931). It constitutes a significant proportion of current freshwater generation through modern Multi-Effect-Distillation (MED) and Multi-Stage Flash (MSF) facilities that use waste heat from power generation as a convenient energy source. In small-scale operations, the most frequent heat source is a wood-fired oven. Modern MED facilities (Fig. 19.15) can run down to a temperature of 55°C and produce freshwater from natural hot groundwater systems at a competitive price, even where geothermal surface manifestations are absent (Christ et al. 2017).

The design specifications for industrial scale freshwater generation are ideal for town water supply and ships, but for remote communities, a single-effect desalination unit would be sufficient as it produces 1000 L/day (Fig. 19.16). This device has very compact dimensions and is based on a plate-type heat exchanger. Many similar devices are available commercially. Commercially available emergency freshwater generators that do not require electricity are also available. These rely on heat to evaporate and recondense water to remove pathogens. A design of this sort may be more suitable for Pacific rural communities with no electricity.

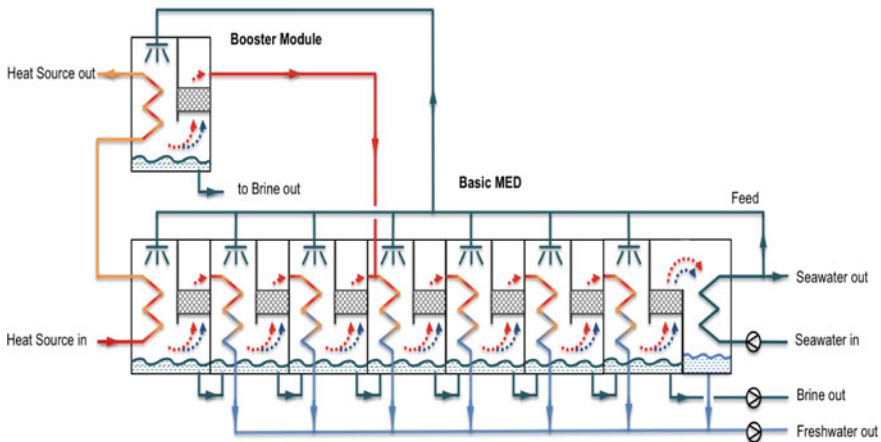

Fig. 19.15 A compact Multi-Effect-Distillation (MED) design uses a cascade of evaporation and condensation chambers where the latent heat of the condensers is used as a heat input for the next distillation step operating at lower temperatures and lower pressures. A patented compact design is shown where a steam booster increases the freshwater yield (©Christ et al. 2015)

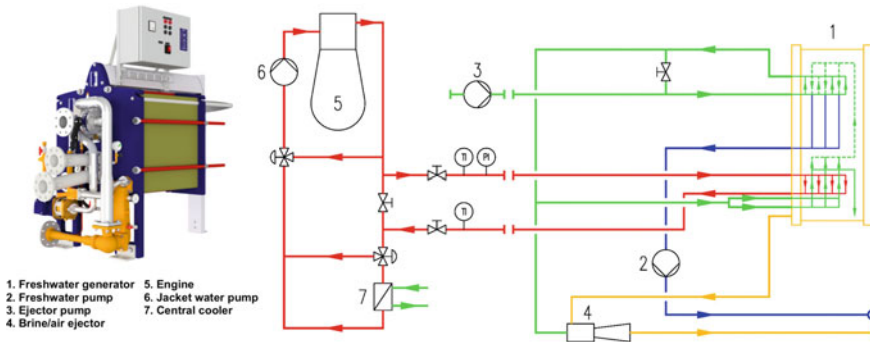

Fig. 19.16 Single effect desalination unit developed by the company Alfa Laval. The plate-type heat exchanger design is titanium-coated and is easy to clean in the event of fouling. A small source of electricity is still required to drive the vacuum and circulation pumps (©Alfa Laval, 2015–2023)

19.3.3.2 Ecotourism

Ecotourism provides the means of establishing income streams which are reliant on the sustainable preservation of local natural resources (Su et al. 2014; Wall 1997). The construction of non-invasive low-cost tourist facilities may help well-placed communities to gain revenue by providing access to natural geothermal baths, saunas, and balneotherapy centres. The use of geothermal water for bathing and curing ailments has also been part of some traditional Maori cultures in New Zealand (Neilson et al. 2010), thus demonstrating a linkage to culture and traditional living practices.

19.3.4 Nexus

The use of indigenous geothermal resources provides the opportunity to achieve interconnected developments which are conducive to water, energy, and food security in the Pacific. The common reliance on geothermal heat to desalinate water, produce energy, and assist with food processing/preservation is at the forefront of achieving the nexus ideal—providing each necessity in a harmonious and interconnected fashion. The robust nature of the presented solutions allows for the integration of processes which improve efficiency (such as geothermal cascading, explored in Sect. 19.4.2) and ensures that PICTs with geothermal resources may maintain the nexus' functionality with more financial and technical independence. The elimination of external dependence for fuel, water, and food imports allows for significant import savings and shields PICTs against the economic and resource stressors experienced by the disruption of shipping supply chains, such as in the case of the COVID-19 pandemic (Kim et al. 2020; Richardson and Hitchins 2021).

19.4 Design Principles for Geothermal Developments

Two key design principles suggested for geothermal developments are integration with nature and society and geothermal cascading. These focus on the establishment of self-sufficient development support cycles (for low levels of development) and efficiency maximization (for higher levels of development).

19.4.1 *Integration with Natural and Social Systems*

The viability of geothermal projects in PICTs, especially in rural areas, can be greatly enhanced by designing appropriate and sustainable heat-based services as part of a nature-integrated and socially coherent system that focus on robustness, autarky (i.e., self-reliance at a national level), and low social and environmental impacts. Basic requirements to satisfy day-to-day needs, such as food drying to preserve food and desalination to provide potable water, are best met with techniques that draw inspiration from traditional indigenous practices and natural systems. This approach ensures that the resources, materials, and skills required to assemble most projects are readily available (as they are locally sourced and familiar) and independent of the typical developmental project barriers associated with unsuitable financial structures and limited technical capacity (Dornan 2014; Surroop et al. 2018).

Where possible, designing and building using locally grown products (such as bamboo or palms—which can also be dried with geothermal heat to avoid shrinkage, swelling, and contamination), native rocks and minerals, and traditional engineering architectures reduces costs, ensures minimal dependence on external participants, and relieves projects of all problems relevant to the import and installation of replacement parts. In most cases, technologies developed in this manner are also more consistent with the existing technical aptitudes and traditional modes of living of local residents. The additional technical, social, political, and financial complexity introduced by high-tech solutions may result in outcomes in direct contrast with the advocations of energy development projects (Banks 1993; Tisdell 2002; Karekezi et al. 2006).

There is also ample evidence supporting the inclusion of sustainable and culturally relevant approaches within energy project conceptions and operational mechanisms for rural developments, in both an environmental and financial sense (Ferrer-Martí et al. 2012; Ramani 2004; Rehman et al. 2010; Xiaohua and Zhenmin 2002). Traditional economic dynamics, prominent in many PICTs (Rosseau and Taylor 2012), may also be embedded in project cycles to render justice to traditional modes of living and ensure local participation. These take the form of rethinking project operation in the local sociocultural framework as opposed to traditional business-oriented frameworks.

19.4.2 Geothermal Cascading

The concept of cascading thermal recovery in low-to-medium enthalpy geothermal applications has been plentifully discussed in literature and industry (Lindal 1973; Regenauer-Lieb 2011b; Rubio-Maya et al. 2015). The sequencing of cascaded heat systems (Fig. 19.17) is designed to obtain maximum utilization of the harvested geothermal heat to meet a variety of services with optimal efficiency. As such, warmer processes are encountered by the geothermal fluid first and cooler processes last. Services which may function in this regime include electricity production (via the integration of power plants, such as ORC plants), heating, cooling, refrigeration, cattle breeding, incubators, milk pasteurization, greenhouses, fish farming, food processing, industrial drying (including timber drying), water desalination, bathing areas, and saunas.

A few practical examples of these implementations exist, including the famous Unterhaching community network in Germany (38 MWth, 3 MWe). Many development proposals in this fashion also exist, including ones for the Eburru and Barrier communities in Kenya, the Sabalan geothermal region in Iran, the Kozani-8 geothermal well in Albania, and Alkimos city in Western Australia (discontinued due to an unsuccessful bid) (Regenauer-Lieb 2011a; Newton et al. 2012; Rubio-Maya et al. 2015).

There are various technical and economic barriers to the implementation of these cascading systems, such as high upfront costs, few demonstration projects, and high retrofitting expenses, which are usually more substantial than ones incurred from building interconnected heat systems anew. To some degree, undeveloped rural areas provide an advantage in this case, as little-to-no pre-existing infrastructure exists. Cascading interconnections require extensive planning and well-defined maintenance and fault identification protocols to ensure system functionality, efficiency,

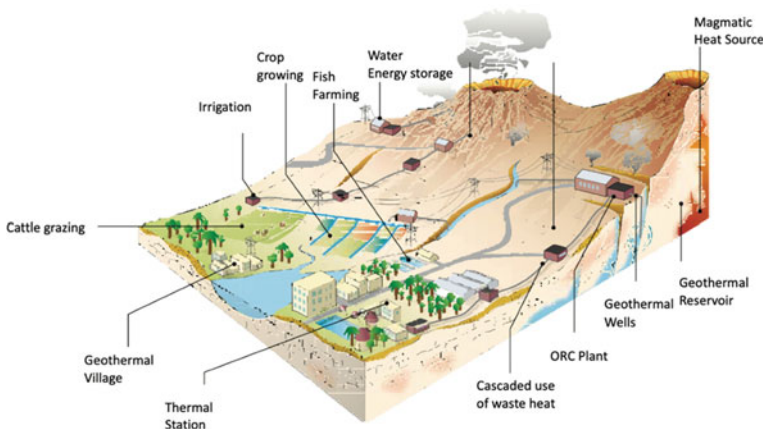

Fig. 19.17 Conceptual diagram of a geothermal village concept (Modified from Varet et al. 2014)

and reliability. If properly arranged, their large upfront cost may provide plentiful returns as well as economic and social benefits in terms of improving water, energy, and food security.

19.5 Application: Geothermal Villages

The following section briefly discusses the idea of a geothermal village and elucidates on a few important sociocultural and technical considerations for geothermal implementations in PICTs. The Tanna Island case study (Sect. 19.2.3.1) is here briefly explored as a proxy for rural PICT developments. While the viability of developments in Tanna in the long-term is still to be assessed, geothermal solutions for energy, food, and water are a clear opportunity given the local context.

19.5.1 Case Study: Tanna Island

The idea of a geothermal village is to establish an integrated communal system of energy and material flows, where societal activities take place in harmony with naturally present geothermal resources. The interconnected nexus approach of water, energy, and food security is highly suited to this. In Tanna, this has a particular significance given the need to provide services such as desalination and sufficiently high temperature cooking systems (with 73 °C being a good target to extinguish most microbial agents [Kawabata et al. 1983]). Given the limited technical capacity present on the island, these systems would foresee low levels of sophistication and minimal intrusion, as per the first design principle introduced in this chapter. This ensures that communities with little technical background residing in isolated regions can operate and maintain them. All systems within a geothermal village should be designed and arranged from a holistic perspective, taking into account all the particularities of the local people, resources, and environment to prevent cultural and environmental spoilsages. Some examples of robust designs have already been presented throughout Sect. 19.3, such as conduction-based food dryers.

In Tanna, various communities with separate forms of governance are spread across the caldera area, from Port Resolution to Sulphur Bay, with an estimated population of roughly 1500 people. These communities display some limited infrastructure (small schools, dispensaries, aid posts) and have reasonable road accessibility. Energy poverty is widespread and typically small lighting loads and smartphone charging are serviced by small diesel or petrol generators or PV systems.

Most locals live subsistence-based lifestyles centred on fishing and agriculture (with main cultures involving coconut, kava, breadfruit, and cassava), which would greatly benefit from geothermal implementations. Most communities share similar sociocultural elements, such as the use of the *Kastom Ekonomi* (a cashless traditional economy based on hierarchies, relationships, and trade, but does not apply for the

payment of school fees, kerosene, and other products such as tea and sugar) and the respect of Tabu Land (i.e., sacred areas, burial grounds) (MacClancy 1981; Rousseau and Taylor 2012). Another common cultural aspect is the presence of cargo cults, a millenarian belief system centred around the fetishization of western technologies as a result of interactions with military forces during the Second World War (Sherry 2017; Lindstrom 2019).

Geothermal resources in this area are abundant (Sect. 19.2.3.1). However, they are not entirely riskless, as these communities have suffered health impacts due to the volcanic fluorine content in surface waters (Cronin and Sharp 2002). Agriculture and PV system performance have also suffered due to frequent toxic ash rains, killing crops and soiling solar panels (VGMD 2021).

As per the National Energy Road Map (NERM) outlined by the Vanuatu government, there is an ongoing national effort to provide energy solutions to off-grid communities (Republic of Vanuatu 2016). Funding sources employed to achieve this are typically utilities, private companies, NGOs, the world bank, local governmental funds, and international development partners. Opportunities for project proposals in the geothermal space are present (Dornan 2015, Wolf et al. 2016, Keeley and Keeley 2017).

19.5.2 Other PICTs

To ensure the applicability of geothermal solutions to other PICTs, sociocultural and economic contexts need to be explored in depth. For example, cargo cults in particular are widespread throughout the rural Pacific, and in PNG infrastructure vandalism and psychosomatic health detriments have been recorded as a response to development (Bettison 1978). Countries like Fiji also amortize the costs of diesel to the population via extensive subsidy programs (Chap. 3) which cover up the high cost of importing fuel to the region, thus potentially restricting funding to other economic sectors and affecting the financial superiority of geothermal solutions (ITP 2014).

19.6 Conclusions

Geothermal energy derived from natural hot springs or deep hot aquifers has an enormous potential to provide energy, food, and water solutions, often in an interconnected or nexus approach. It can provide a clean and reliable baseload energy capacity, represents a state-of-the-art renewable approach that has not yet reached its potential in the Pacific, and provides a wide variety of food and water security improvements. Its natural abundance in the Pacific also renders it a resilient and convenient option to expand energy systems and provide sustainable and appropriate development options to many PICTs. This is especially the case for isolated and rural communities with abundant heat sources. Furthermore, the implementation of

geothermal facilities in a nature-integrated fashion supports a culture that embraces heat as a valuable commodity. This follows the example of other Pacific cultures where its use has been historically beneficial and central to daily life (Neilson et al. 2010).

In some Pacific countries, like Vanuatu, geothermal energy may present a cheap solution for electricity generation due to the high fuel cost of diesel gensets (Castle-rock Consulting 2011). However, the core innovation in terms of extending energy, food, and water access in a riskless and cost-effective fashion lies in direct heat use facilities. The advantages of these facilities are threefold. Firstly, they allow comparatively low-cost demonstrations of the use of geothermal power for hot spring areas that are too low in temperature to be suitable (without deep drilling) for electricity production. This is especially important in PICTs where financial capabilities are limited. Secondly, they can be used to explore and test reservoirs further in order to reduce the financial risk of drilling deeper. This is important to support the larger capital investment of intermediate-to-large power plants. Thirdly, they provide a wide range of options in terms of waste heat use, which may be cascaded to other services such as chilling and desalination, as per the ideal geothermal village architectures (Varet et al. 2014). Providing reliable and clean geothermal energy with cascading benefits for water and food security is truly an exciting prospect for development in the Pacific.

Acknowledgements The authors would like to thank the UNSW Institute for Global Development for past support for engagement with the PICTS.

References

- Alfa Laval (2023) AQUA Blue E1 C-type – Single Stage Fresh Water Generator
- Ásmundsson RK (2008) South Pacific Islands geothermal energy for electricity production. Icelandic International Development Agency
- Australian Geothermal Association (2020) Papua New Guinea an emerging Geothermal energy market.
- Banks G (1993) Mining multinationals and developing countries: theory and practice in Papua New Guinea. *Appl Geogr* 13(4):313–327
- Berhane D, Mosusu N (1997) A review of the geothermal resources of Papua New Guinea. In: *Proceedings of PNG Geology, Exploration, and Mining Conference*
- Bertani R (2016) Geothermal power generation in the world 2010–2014 update report. *Geothermics* 60:31–43
- Bettison DG (1978) ‘The Vailala Madness’ and other essays. *Pac Aff* 51(2):344–346
- Bloomberg S, Leodoro M (2016) Baseline geothermal survey of Vanuatu: recent results from Ambrym and Tanna Islands. In: *Proceedings 38th New Zealand Geothermal Workshop November 23–25, 2016*
- Brooks RA (2015) Summary of geothermal development in Vanuatu. Vanuatu Geology and Mines Unit
- Brothelande E, Lénat JF, Chaput M, Gailler L, Finizola A, Dumont S et al (2016a) Structure and evolution of an active resurgent dome evidenced by geophysical investigations: The Yenkahe dome-Yasur volcano system (Siwi caldera, Vanuatu). *J Volcanol Geotherm Res* 322:241–262

- Brothelande E, Lénat JF, Normier A, Bacri C, Peltier A, Paris R et al (2016b) Insights into the evolution of the Yenkahe resurgent dome (Siwi caldera, Tanna Island, Vanuatu) inferred from aerial high-resolution photogrammetry. *J Volcanol Geotherm Res* 322:212–224
- Castlerock Consulting (2011) Vanuatu: Efate geothermal power and island-ring grid development framework
- Ceres (2020) Introducing the EcoLoop™: Ceres most energy-efficient heating and cooling system yet
- Christ A, Rahimi B, Regenauer-Lieb K, Chua HT (2017) Techno-economic analysis of geothermal desalination using hot sedimentary aquifers: a pre-feasibility study for Western Australia. *Desalination* 404:167–181
- Chua KJ, Chou SK (2003) Low-cost drying methods for developing countries. *Trends Food Sci Technol* 14(12):519–528
- Christ A, Regenauer-Lieb K, Chua HT (2015) Application of the Boosted MED process for low-grade heat sources—A pilot plant. *Desalination* 366:47–58
- Cloin J (2007) Coconut oil as a fuel in the Pacific Islands. *Nat Resour for* 31(2):119–127
- Connell J (2006) “I can’t eat that, it’s purple”: a geography field course in Vanuatu and Fiji. *Geogr Res* 44(1):17–27
- Cox KG (1980) A model for flood basalt vulcanism. *J Petrol* 21(4):629–650
- Cronin SJ, Sharp DS (2002) Environmental impacts on health from continuous volcanic activity at Yasur (Tanna) and Ambrym. *Int J Environ Health Res* 12(2):109–123
- Dell R, Unnthorsson R, Wei CS, Foley W (2013) Waste geothermal hot water for enhanced outdoor agricultural production. ASME Power Conference 56062, V002T09A013. <https://doi.org/10.1115/POWER2013-98172>
- Dell R, Wei CS, Sidebotham G, Guido V, Cataldo J, Unnþórsson R, et al. 2011 Geothermal heat in agriculture: preliminary results of an energy intensive system in Iceland. *Geothermal Resources Council Transactions* 35
- DiPippo R (2015) *Geothermal power plants: principles, applications, case studies and environmental impact*, 4th edn. Elsevier
- Dornan M (2014) Access to electricity in Small Island Developing States of the Pacific: issues and challenges. *Renew Sust Energy Rev* 31:726–735
- Dornan M (2015) Renewable energy development in small island developing states of the Pacific. *Resources* 4(3):490–506
- Eavor (2021) Eavor-Lite™ – The First Truly Scalable Form of Clean Baseload Power
- Eveloy V, Rodgers P, Popli S (2014) Trigeneration scheme for a natural gas liquids extraction plant in the Middle East. *Energy Convers Manag* 78:204–218
- Falkland T (2002) Synopsis of information on freshwater and watershed management in Pacific Islands Region. *International Waters Programme*
- Ferrer-Martí L, Garwood A, Chiroque J, Ramirez B, Marcelo O, Garfí M, Velo E (2012) Evaluating and comparing three community small-scale wind electrification projects. *Renew Sust Energy Rev* 16(7):5379–5390
- Fiji Ministry of Economy (2018) Fiji low emission development strategy 2018–2050
- Franco A, Vaccaro M (2017) Recent trends in the development of heat exchangers for geothermal systems. 35th UIT Heat Transfer Conference (UIT2017)26–28 June 2017, Ancona, Italy. *J Phys Conf Ser* 923(1):012044
- Geodynamics (2014) Takara Geothermal Power Project: draft environmental and social impact assessment
- Goldburg R, Naylor R (2005) *Ocean farming*. John Wiley & Sons
- Guppy HB (1903) Observations of a naturalist in the Pacific between 1896 and 1899
- Hay JE, Bells GM (2007) Regional: mainstreaming environmental considerations in economic and development planning processes in selected Pacific developing member countries. *Asian Development Bank*
- Holdmann G (2016) Absorption chiller for the Chena Hot Springs Aurora Ice Museum. *Geo-Heat Center*, Oregon Institute of Technology, Klamath Falls, USA

- IRENA (2015) Unless otherwise stated, this publication and material featured herein are the property of the International Renewable Agency (IRENA) and are subject to copyright by IRENA. Material in this publication may be freely used, shared, copied, reproduced, printed and/or stored, provided that all such material is clearly attributed to IRENA and bears a notation that it is subject to copyright (©IRENA 2015). Material contained in this publication attributed to third parties may be subject to third-party copyright and separate terms of use and restrictions, including restrictions in relation to any commercial use.
- ITP (2014) Review of Existing Subsidy and Incentive Schemes – Fiji
- Jay J, Loessner M, Golden DA (2005) Protection of foods by drying. In: *Modern Food Microbiology* 443–456
- Karekezi S, Meyers S, Majoro L, Kimani J, Wambille A (2006) Energy access working group global network on energy for sustainable development. In: *Final Synthesis/Compilation Report for the Policy Implementation Phase*
- Kawabata N, Hayashi T, Matsumoto T (1983) Removal of bacteria from water by adhesion to cross-linked poly (Vinylpyridinium Halide). *Appl Environ Microbiol* 46(1):203–210
- Kawagle SA (2005) The mineral resources of Papua New Guinea. *Resour Geo* 55(3):285–288
- Keeley AR, Keeley TD (2017) Perceived market risk of the renewable energy industry in the United States
- Kelly G (2011) History and potential of renewable energy development in New Zealand. *Renew Sust Energy Rev* 15(5):2501–2509
- Kim K, Kim S, Park CY (2020) Food security in Asia and the Pacific amid the COVID-19 pandemic. Asian Development Bank
- Kuang Y, Zhang Y, Zhou, B, Li C, Cao Y, Li L, et al. (2016) A review of renewable energy utilization in islands. *Renew Sust Energy Rev* 59: 504–513
- Kumar C, Karim A, Saha S, Joardder MUH, Brown R, Biswas D (2012) Multiphysics modelling of convective drying of food materials. *Proc Global Eng Sci Technol Conf* 2012:1–13
- Kuna I, Zehner R (2015) Papua New Guinea country update. *Proceedings World Geothermal Congress*
- KuTh Energy (2010) Statement of estimated geothermal resources: Takara Geothermal Project, Vanuatu
- Lebot V, Merlin M, Lindstrom L (1997) Kava: The Pacific elixir: the definitive guide to its ethnobotany, history, and chemistry. *Inner Traditions/Bear & Co*
- Lefale PF, Lloyd CR (1993) Photovoltaics for household energy use in Pacific Island nations (Fiji study). *Renew Energy* 3(2–3):153–163
- Li P, Liu J (2011) Harvesting low grade heat to generate electricity with thermosyphon effect of room temperature liquid metal. *Appl Phys Lett* 99(9):094106
- Lindal B (1973) Industrial and other applications of geothermal energy. *Geotherm Energy* 135–148
- Lindstrom L (2019) *Cargo cult: strange stories of desire from Melanesia and beyond*. University of Hawaii Press
- Lucas H, Fifita S, Talab I, Marschel C, Cabeza LF (2017) Critical challenges and capacity building needs for renewable energy deployment in Pacific Small Island Developing States (Pacific SIDS). Elsevier, vol. 107(C), pp. 42–52
- Lund JW, Freeston DH, Boyd TL (2005) Direct application of geothermal energy: 2005 worldwide review. *Geothermics* 34(6):691–727
- Lund JW, Freeston DH, Boyd TL (2011) Direct utilization of geothermal energy 2010 worldwide review. *Geothermics* 40(3):159–180
- MacClancy J (1981) To kill a bird with two stones: a short history of Vanuatu. *Vanuatu Cultural Centre*
- Malolo M, Matenga-Smith T, Hughes R (1999) Pacific foods: the staples we eat. *SPC*
- McCoy-West AJ, Milicich S, Robinson T, Bignall G, Harvey CC (2011) Geothermal resources in the Pacific Islands: the potential of power generation to benefit Indigenous communities. In: *Proceedings of the Thirty-Sixth Workshop on Geothermal Reservoir Engineering*

- McNamara KE, Prasad SS (2014) Coping with extreme weather: Communities in Fiji and Vanuatu share their experiences and knowledge. *Clim Change* 123(2):121–132
- Merle O, Brothelande E, Lénat JF, Bachèlery P, Garaébiti E (2013) A structural outline of the Yenkahe volcanic resurgent dome (Tanna Island, Vanuatu Arc, South Pacific). *J Volcanol Geotherm Res* 268:64–72
- Métrich N, Allard P, Aiuppa A, Bani P, Bertagnini A, Shinohara H, et al. (2011) Magma and volatile supply to post-collapse volcanism and block resurgence in Siwi Caldera (Tanna Island, Vanuatu Arc). *J Petrol* 52(6):1077–1105
- Mofor L, Isaka M, Wade H, Soakai A (2013) Pacific lighthouses: renewable energy road mapping for islands. IRENA
- Neilson G, Bignall G, Bradshaw D (2010) Whakarewarewa a living thermal village—Rotorua, New Zealand. *Proceedings World Geothermal Congress* 1–7
- Nevton K, Aida B, Nevina K, Esmeralda Z, Borana M (2012) Designing of the integral, cascade and hybrid use scheme, for the Kozani-8 Geothermal water; some thermal and economical calculations. *AASRI Procedia* 3:291–298
- Oppenheimer C (2011) *Eruptions that shook the world*. Cambridge University Press
- Patton MW (1894) *Letters and sketches from the New Hebrides*: Hodder and Stroughton
- Petterson M (2016) Geothermal energy prospects in selected Pacific Island Countries and Territories. In *CCOP 50th Anniversary Conference Proceedings, Bangkok*
- Ramani KV (2004) Challenges for Asia and the Pacific and lessons from UNDP projects in the region. *Energy for Sustainable Development* 1
- Regenauer-Lieb K (2011a) *Alkimos report: Geothermal development opportunities*. Western Australian Geothermal Centre
- Regenauer-Lieb K (2011b) *Geothermal Cities*. Western Australian Geothermal Centre
- Rehman IH, Kar A, Raven R, Singh D, Tiwari J, Jha R et al (2010) Rural energy transitions in developing countries: a case of the Uttam Urja initiative in India. *Environ Sci Policy* 13(4):303–311
- Republic of Vanuatu (2016) *Updated Vanuatu national electricity road map 2016–2030*
- Richardson R, Hitchins R (2021) *Disruptions to global shipping: regional impacts*. Development Policy Centre
- Richter A (2017) *Developing geothermal energy on Vanuatu, Pacific - key areas of interest*. Think Geoenergy
- Ross W (1931) *The works of Aristotle*. Clarendon Press
- Rousseau B, Taylor J (2012) *Kastom ekonomi and the subject of self-reliance. Differentiating Development: beyond an Anthropology of Critique* 169:184–186
- Rubio-Maya C, Ambríz Díaz VM, Pastor Martínez E, Belman-Flores JM (2015) Cascade utilization of low and medium enthalpy geothermal resources – a review. *Renew Sust Energy Rev* 52:689–716
- Schröder S (2021) *Bamboo joints and joinery techniques*. Guadua Bamboo
- Sen S, Ganguly S (2017) Opportunities, barriers and issues with renewable energy development – a discussion. *Renew Sust Energy Rev* 69:1170–1181
- Shangguan W, Gong Y, Zhao R, Ren H (2016) Effects of heat treatment on the properties of bamboo scrimber. *J Wood Sci* 62(5):383–391
- Sherry J (2017) *Waiting for John*. Alita Films
- SPC (2007) *National Integrated Water Resource Management Diagnostic Report Kiribati*
- Statista (2021) *Global GDP 2014–2024- Gross Domestic Product*
- Su MM, Wall G, Ma Z (2014) *Assessing Ecotourism from a Multi-stakeholder Perspective: Xing kai Lake National Nature Reserve, China*. *Environ Manage* 54:1190–1207
- Surroop D, Ragho P, Wolf F, Shah KU, Jeetah P (2018) Energy access in Small Island Developing States: Status, barriers and policy measures. *Environ Dev* 27:58–69
- Tapster S, Roberts NMW, Petterson MG, Saunders AD, Naden J (2014) From continent to intra-oceanic arc: Zircon xenocrysts record the crustal evolution of the Solomon Island arc. *Geology* 42(12):1087–1090

- Tawake A (2017) SPC promotes geothermal energy as a catalyst for sustainable economic development in the Pacific. SPC
- Teimouri H, Behzadmehr A (2019) Numerical investigation of a thermosyphon MHD electrical power generator. *Energy Convers Manag* 187:378–397
- Tisdell C (2002) Globalisation, development and poverty in the Pacific Islands: The situation of the least developed nations. *Int J Soc Econ* 29(12):902–922
- UN (2021) Goal 6: Ensure access to water and sanitation for all
- Urmee T, Harries D (2009) A survey of solar PV program implementers in Asia and the Pacific regions. *Energy Sustain Dev* 13(1):24–32
- Utilities Regulatory Authority of Vanuatu (2019) Comparative Report Pacific Region Electricity Bills
- Varet J, Omenda P, Achieng J, Onyango S (2014) The “Geothermal Village” Concept: a new approach to geothermal development in rural Africa. Proceedings 5th African Rift Geothermal Conference, Arusha, Tanzania 29–31. <http://www.geo2d.com/images/actualites/2014-ArgeoC5-GeothermalVillage.pdf>
- VGMD (2021) Vanuatu Volcano Alert Bulletin n°3 – Tanna Activity
- Vukikomoala F, Wainibalagi T (2019) Pacific fuel price monitor - January-March 2019 (Quarter 1, 2019) SPC
- Wall G (1997) Is ecotourism sustainable? *Environ Manage* 21(4):483–491(4)
- Weir T (2018) Renewable energy in the Pacific Islands: Its role and status. *Renew Sust Energ Rev* 94:762–771
- WHO (2017) Guidelines for drinking-water quality (4th Edition)
- Williamson A, Hancock G (2005) The geology and mineral potential of Papua New Guinea. Department of Mining
- Wolf F, Surroop D, Singh A, Leal W (2016) Energy access and security strategies in Small Island Developing States. *Energy Policy* 98:663–673
- Xiaohua W, Zhenmin F (2002) Sustainable development of rural energy and its appraising system in China. *Renew Sust Energ Rev* 6(4):395–404
- Yamaguchi K, Miki M, Shaanika E, Izumi M, Murase Y, Oryu T (2019) Study of neon heat flux in thermosyphon cooling system for high-temperature superconducting machinery. *Int J Therm Sci* 142:58–265
- Yifru Woldemariam B (2019) Optimization of distributed cooling and cold storage in Sweden: case study-Norrenergi AB

The opinions expressed in this chapter are those of the author(s) and do not necessarily reflect the views of the UNESCO: United Nations Educational, Scientific and Cultural Organization, its Board of Directors, or the countries they represent.

Open Access This chapter is licensed under the terms of the Creative Commons Attribution-ShareAlike 3.0 IGO License (<https://creativecommons.org/licenses/by-sa/3.0/igo/>), which permits use, sharing, adaptation, distribution, and reproduction in any medium or format, as long as you give appropriate credit to the UNESCO: United Nations Educational, Scientific and Cultural Organization, provide a link to the Creative Commons licence and indicate if changes were made. If you remix, transform, or build upon this book or a part thereof, you must distribute your contributions under the same licence as the original.

The use of the UNESCO: United Nations Educational, Scientific and Cultural Organization's name, and the use of the UNESCO: United Nations Educational, Scientific and Cultural Organization's logo, shall be subject to a separate written licence agreement between the UNESCO: United Nations Educational, Scientific and Cultural Organization and the user and is not authorized as part of this CC-IGO licence. Note that the link provided above includes additional terms and conditions of the licence.

The images or other third party material in this chapter are included in the chapter's Creative Commons licence, unless indicated otherwise in a credit line to the material. If material is not included in the chapter's Creative Commons licence and your intended use is not permitted by statutory regulation or exceeds the permitted use, you will need to obtain permission directly from the copyright holder.



Chapter 20

Towards Food, Nutrition and Income Security in Papua New Guinea Through Inland Fish Farming



Jesmond Sammut, Havini Vira, Shanice Tong, Matthew Nicholl, Joshua Noiney, Debashish Mazumder, Jacob Wani, Kiros Hiruy, and Sue Mei Lau

Abstract Malnourishment and undernourishment are prevalent in Papua New Guinea, leading to disease, lower quality of life and less opportunity. Protein deficiency in diets is a pervasive problem in PNG. Inland fish farming was introduced as a means of increasing access to locally produced protein, particularly for rural people who are poor and most impacted by diet-related health problems. Over the last decade there has been rapid growth of fish farming attributed to development interventions that facilitate adoption of better farming practices. The high cost of feed, poor supply of quality fingerlings, lack of infrastructure, and limited access to technical knowledge are bottlenecks to fish farming that are being tackled by Government, NGOs and donor funded programs. Inland fish farming has also generated social benefits such as reduced crime and tribal fighting, introduced a second income for families, and increased access to better education and health services.

Keywords Genetically improved farmed tilapia · Fish farming · Human nutrition · Aquaculture · Protein

J. Sammut (✉) · H. Vira · S. Tong · M. Nicholl · D. Mazumder
Centre for Ecosystem Science, The School of Biological,
Earth and Environmental Sciences, The University of New South Wales, Sydney, Australia
e-mail: j.sammut@unsw.edu.au

J. Sammut · D. Mazumder
The Australian Nuclear Science and Technology Organisation, Sydney, Australia

H. Vira
The Ok Tedi Development Foundation, Kiunga, Papua New Guinea

J. Noiney · J. Wani
The National Fisheries Authority of Papua New Guinea, Port Moresby, Papua New Guinea

K. Hiruy
Faculty of Business and Law, Swinburne University of Technology, Melbourne, Australia

S. M. Lau
Prince of Wales Clinical School, The University of New South Wales, Sydney, Australia
Department of Diabetes and Endocrinology, The Prince of Wales Hospital, Randwick, Australia

20.1 Introduction

Papua New Guinea (PNG) is one of the oldest agricultural societies in the world. More than 87% of the population relies on subsistence farming, mainly vegetable growing, for food, (FAO 2017). Papua New Guinea is rich in natural resources such as minerals, fresh water, and fertile soils, yet more than 33% of the population earns less than \$1.25 per day (FAO 2017). Fresh fruit and vegetables are readily accessible to most people in rural areas, with tubers a dominant component of diets. In contrast to subsistence vegetable farming, there is limited livestock culture except for small-scale chicken and pig farming which are widespread. Retail prices for fresh meat and fish are high for rural households. Pigs, although common, are usually eaten at ceremonies or used as ‘bride price’ in some communities (Anderson 2006). Consequently, consumption of protein is limited and affects the health of PNG’s largely rural-based population (Asian Development Bank 2012; Gibson et al. 1991). High feed and transport costs also inflate poultry prices (Glatz et al. 2013), which is a disincentive to farm chickens at a scale that could help address protein shortages. The remoteness of many traditional communities in PNG, particularly in the highlands and small islands, and low per capita income (FAO 2017), limits access to retail sources of protein (Vira 2015).

Despite an increase in PNG’s GDP, child stunting rates have increased since 2005 (Hou 2015). The prevalence of wasting (low weight for height- reflective of acute malnutrition) and nutrient deficiencies, such as iron, zinc, iodine, and vitamin A, are also high (Hou 2015). Paradoxically, although stunting of infants is common, particularly in the highlands of PNG, obesity becomes an issue for adults (see Chap. 4 for further details on a regional level of this paradox). The rising prevalence of obesity, diabetes, heart disease, and stroke threatens to encumber an already poorly resourced health system and will continue to have increasing impact on the morbidity and mortality of the people of PNG unless solutions can be found to provide adequate nutrition to all sectors of the community.

Having sufficient dietary protein is very relevant to a nation where the majority of adults are either overweight or obese. Insufficient dietary protein results in the overconsumption of fats and carbohydrates, as is the case in PNG. The problem with current staple foods in PNG is that they are low in protein and important micronutrients such as iron, zinc, iodine, and vitamin A (Hou 2015). Alternative food sources need to be found that provide higher amounts of these macro—and micronutrients on a per calorie basis without increasing the dietary content of saturated fat. This issue was recognized by Food and Agriculture Organization (FAO) in the 1950s during which a number of introduced fish species were stocked in rivers to create a wild fishery, followed by attempts to establish aquaculture.

Wild-sourced and farmed fish are now widely considered socially, economically, and environmentally sustainable options to increase protein in diets in PNG (Vira 2015). Fish farming, although not a traditional practice, has parallels to vegetable farming thus attracting interest (Hiruy and Sammut 2019; Tong 2018; Vira 2015). Unlike in Asia, where fish farming has a long history, fish farming in PNG has only

been practiced since the mid 1950s, and until the turn of the century was considered a small, fringe activity (Vira 2015). Although fish farming in PNG is increasingly adding protein to diets (Hiruy and Sammut 2019; Vira 2015), the inland aquaculture industry still faces the challenges of reducing production costs, improving farming skills in remote communities most in need of protein, and achieving similar production levels to farms in other parts of the world to enable farmers to generate income. For many farmers in PNG, low financial capital and a lack of knowledge on fish farming has stymied their efforts to maximize yields (Hiruy and Sammut 2019; Smith 2007; Tong 2018; Vira 2015).

This water, energy, and food nexus case study chapter focuses on a program of inland fish farming research and extension, primarily involving the authors, comprising a series of interlinked research for development (R4D) projects funded by the National Fisheries Authority (NFA) in PNG and the Australian Centre for International Agricultural Research (ACIAR). The research and extension program has concentrated on improving fish production through research on better fish feeding strategies, improved fingerling production and broodstock management, education of farmers, and creating information networks using established social systems to facilitate knowledge transfer. This chapter focuses on the impacts of extending research findings to farmers rather than outlining the details of research into the technological aspects of the program.

Firstly, the human health challenges that have underpinned the program's effort to increase fish in the diets of people in PNG are outlined. This chapter also provides an overview of strengths, weakness, opportunities, and threats to sustainable fish farming in PNG and how the R4D interventions, through partnerships with NGOs, farmer groups and government agencies, have increased access to protein and generated a number of positive social impacts beyond meeting the nutritional requirements of people (Wani et al. 2012). We use selected examples from the program's outreach and extension activities in both the highlands (Hiruy and Sammut 2019; Vira 2015; Wani et al. 2012) and coastal communities of PNG (Hiruy and Sammut 2019; Tong 2018) to demonstrate how fish farming can change lives by addressing protein deficiencies in diets, creating a source of income and improving the lifestyles of rural people.

20.2 The Human Nutrition Problem in PNG

There is a very high prevalence of nutritional disorders in PNG. PNG has the fourth highest rate of stunting (low height for age-reflective of chronic malnutrition) in the world, affecting almost one in two children under the age of 5 (International Food Policy Research Institute 2016). Despite an increase in its GDP, stunting rates have increased since 2005 (Hou 2015). The prevalence of wasting (low weight for height-reflective of acute malnutrition) and nutrient deficiencies, such as iron, zinc, iodine, and vitamin A, is also high (Hou 2015). Undernutrition in early childhood bestows an increased risk of rapid weight gain in middle childhood and obesity in adulthood (Gillespie and Haddad 2001). Thus, as individuals enter adulthood, the health burden shifts to one of overnutrition, with rates of obesity and type 2 diabetes rising rapidly in both men and women (ODE Review UNICEF 2013; Office of Development Effectiveness 2015). Nevertheless, while overnutrition is a problem, so too is the ratio of macronutrients in diets, with protein often too low to meet the daily requirement for adults.

The problems of under- and overnutrition are at great cost to PNG. Child undernutrition alone was estimated to cost \$USD 508 million in the financial year 2015–2016, or 2.81% of its annual GDP, through its effects on child mortality, lost income and productivity, and the cost of treating diseases associated with childhood undernutrition (Hurney 2017). The rising prevalence of obesity, diabetes, heart disease, and stroke threatens to encumber an already poorly resourced health system and will continue to have increasing impacts on the morbidity and mortality of the people of PNG unless rapid solutions can be found to provide adequate nutrition to all sectors of the community.

20.2.1 *Prevalence of Stunting and Wasting in Children Under Five*

The prevalence of under-five stunting is extremely high in PNG at 49.5% in 2015—more than twice the world average. This represents an increase from 43.9% in 2005 (Global Nutrition Report 2020). Stunting rates are higher in rural versus urban populations, with the highest rates in the Highlands Region (61.5%) and the lowest in the Islands Region (38.1%) (Hurney 2017). Stunting affects boys more than girls and increases rapidly in both sexes from six months to 24 months of age before plateauing between the ages of two and five (Hurney 2017). While stunting rates decrease with increasing wealth, the rate is still very high in the highest wealth quintile (35% in 2009–2010), indicating significant non-fiscal influences on childhood nutrition.

The prevalence of wasting in PNG was reported as 14.1% in 2015. In contrast to stunting, the wasting rate was highest in the Islands Region at 29.2% (Hurney 2017).

Stunting and wasting are distinct conditions, reflecting chronic and acute undernutrition respectively. There is a stronger association between protein deficiency and stunting, whereas wasting represents a more general caloric deficit or a high incidence of infectious diseases, especially diarrhea (Bourke et al. 2016).

20.2.2 Effects of Childhood Undernutrition

There is a strong association between childhood malnutrition and mortality. Undernutrition results in a weakened immune system and increased susceptibility to infectious diseases such as diarrheal disease, intestinal parasites, and malaria (Bourke et al. 2016). Wasting is associated with a nine-fold increase in mortality (UNICEF 2013). Undernutrition has been reported to have caused or contributed to one third of child deaths in hospital (PNG Department of Health 2015) with estimates as high as 76% for childhood deaths under age five in community and health centres (Schmidt et al. 2019).

The first 1,000 days of life are believed to be crucial in determining the structure and function of a child's brain. Stunting impairs cognitive development and school performance. Cognitive damage is permanent and cannot be reversed with weight gain after the age of two (Martorell et al. 2010). Importantly, stunting has long-term effects on adult health. As stunted children enter middle childhood, a programmed metabolic shift occurs, resulting in propensity for rapid weight gain and the development of conditions such as obesity, hypertension, diabetes, heart disease, and stroke (Barker 1997; Gillespie and Haddad 2001).

The prevalence of metabolic diseases in adulthood is high in PNG (World Health Organization 2020). In 2016, 25.8% of women were obese and 58.1% were either overweight or obese. In men, 16.6% were obese and 47.4% were either overweight or obese. This represents an approximately 60% increase in the prevalence of obesity since 2005 (Global Nutrition Report 2020). Correspondingly, the rate of type 2 diabetes has dramatically increased. In 2016, diabetes affected 15.4% of men and 14.3% of women, representing an approximate 50% increase from 2005 (Global Nutrition Report 2020). Given the low rates of diabetes screening in PNG, this figure is likely to be a gross underestimation of the true prevalence of diabetes.

One in four adults have hypertension in PNG (Global Nutrition Report 2020). Whilst the prevalence of cardiovascular disease is not known, ischemic heart disease is the leading cause of death in adults (death rate 562 per 100,000 people), followed by stroke (198 per 100,000), with diabetes as the eighth leading cause of death (Global Health Index Data Exchange 2020; Centres for Disease Control and Prevention 2019) As obesity and diabetes rates continue to escalate, the burden of disease from metabolic non-communicable is expected to increase over the next decade.

20.2.3 *Dietary Patterns in PNG*

The traditional diet in PNG is low in protein and high in carbohydrates, with tubers or cereals, rather than meat or fish, providing most of the protein intake (Schmidt et al. 2019). Even today, locally grown plant food provides 76% of total food energy and 57% of total protein intake, whereas imported rice and wheat provide just 14% of total food energy and 17% of total protein intake (Bourke et al. 2016).

The staple foods of PNG are root and tuber crops, sago, and banana, the latter two being more common on the coast. The most commonly grown crop is banana, followed by yam, taro, and sweet potato. Other commonly consumed starches include cereal such as rice or maize, Chinese taro, sago, and cassava (Schmidt et al. 2019). Coconuts, nuts, and green vegetables provide a smaller portion of energy intake, but a relatively greater contribution to protein intake (Bourke et al. 2009). The main staple consumed is dependent on the region. For example, in coastal or riverine areas, there is greater consumption of sago, with limited vegetables (Hurney 2017). In urban areas, the staple foods are rice and wheat in the form of instant noodles and bread. More processed foods, such as tinned meat and fish, are consumed compared to rural areas, and over 90% of food is purchased from stores or markets (Government of PNG 2016). Nevertheless, the urban diet is still high in carbohydrates and low in protein (Bourke et al. 2009).

Meat and fish only contribute 6% of food energy but 25% of protein intake in PNG (Bourke et al. 2009). The most common animal products consumed are fish, shellfish, pigs (usually eaten at ceremonies), chickens, and cattle, although the cost of beef is often too high to enable regular consumption. Often, unhealthy forms of meat, such as fatty lamb flaps, are consumed (Muntwile and Shelton 2000). The type of protein consumed is dependent on local production and cost. Approximately half of rural households own livestock or have a fish pond (Schmidt et al. 2019). Pigs and poultry are the most commonly owned livestock, but in the absence of refrigeration, slaughtered livestock has to be consumed quickly (Vira 2015). However, in areas on the coast or near rivers or lakes, fish is the main source of protein (Schmidt et al. 2019) albeit not eaten often due to the high market prices or lack of fishing gear. On average, the people of PNG consume considerably less fish per person than in many other Pacific and Asian countries (Bourke et al. 2009) despite the abundance of water to farm fish, and in the case of coastal communities, access to many edible marine species.

20.3 Fish Farming in PNG

The abovementioned health issues have been a driver to increase access to protein in diets in PNG through inland fish farming. Inland fish farming is a commonly used aquaculture term for freshwater fish farming, whether conducted inland or in freshwater ponds close to the coast. Inland fish farming was introduced to PNG with the establishment of the Highlands Agriculture Experimental Station at Aiyura in the Eastern Highlands Province (EHP) in 1954, by the former Department of Agriculture, Stock and Fisheries (DASF) (Wani 2004). Initially, the focus was to farm common carp (*Cyprinus carpio*) using sweet potatoes and supplementary pelletized feed (Vira 2015). At the time, fertilization of ponds to drive natural food production was promoted as a suitable approach to feed carp, which are omnivorous, (La'a and Glucksman 1972; Reynolds 1970; Toneba 1980) as this was a low input farming practice thought to be suitable for poor farmers (Vira 2015). However, interest in fish farming was limited due to a lack of political support, higher than expected production costs and a lack of investment (Kan 1981). Government policy at the time also prioritized investment in production of plant-based protein (Wani 2004). A lack of traditional knowledge and expertise in fish husbandry (Glucksman and West 1963) also limited uptake of fish farming which was, at the time, a new farming practice (Wani 2004) and prone to failure.

A shift towards higher value trout farming occurred in the 1980s but this practice was limited to the colder waters of the highlands and considered an income generating venture (Vira 2015). However, trout farming, although still undertaken in PNG, never expanded with some farms closing due to community conflicts and farm mismanagement (Masuda et al. 1994). A small number of farms have persisted, but the production levels do not address food or nutrition security needs of PNG (Vira 2015).

Fish farming remained largely a low-input practice for decades that was not widely adopted. The lack of uptake of fish farming and unremarkable farm yields, due to a lack of fish farming skills, eventually resulted in the Aiyura station ceasing all fingerling production in 1985. The Japan International Cooperation Agency (JICA) interventions at Aiyura in the 1990s restored interest and support for aquaculture in the highlands. A JICA project was initiated in collaboration with the Department of Fisheries and Marine Resources (DFMR) to restore fish production at Aiyura. The department subsequently transferred the facility to the EHP government in 1998 when the DFMR became the National Fisheries Authority (NFA). The centre at Aiyura was renamed the Highlands Aquaculture Development Centre (HAQDEC) and although managed by EHP, research at the centre is mainly funded by NFA and operated by its staff, an arrangement that has continued. With fingerling supply at HAQDEC renewed under the JICA project, and increased extension and training, fish farming began to expand (Smith 2007). However, it was JICA's 1999 importation of the late-maturing and faster-growing Genetically Improved Farmed Tilapia (GIFT) (*Oreochromis niloticus*) (Gupta and Acosta 2004a) that accelerated the growth of



Fig. 20.1 Genetically Improved Farmed Tilapia (GIFT) is widely farmed in PNG. Households harvest fish as needed and excess fish are shared or sold with others thus increasing protein consumption in communities. Income from fish farming is invested in expanding farms, school fees, medical care, and household items (© J. Sammut)

aquaculture (Wani 2004) (Fig. 20.1). The species was easy to breed, tolerant of poor water quality, and could survive short periods of neglect by farmers.

The JICA project at HAQDEC ended in 2000. However, research and development continued through a series of collaborative projects funded by ACIAR and NFA. Through partnerships with Australian agencies, a long-term program of research and extension developed, driven by NFA and the University of New South Wales (UNSW) since 2009 (Vira 2015), and previously by the University of Western Sydney (Smith 2007). There are now over 60,000 farms in PNG mainly operating small ponds integrated into vegetable gardens, and most culturing GIFT, although carp farming still occurs as a monoculture or mixed culture with GIFT (Vira 2015). This case study focuses on GIFT production as it is the dominant farmed species in PNG (Hiruy and Sammut 2019).

20.3.1 *Pond-Based Farming*

Farming of fish in earthen ponds (Fig. 20.2) is the dominant culture system in PNG, mainly due to the lower technology requirements of farming fish in earthen ponds, and land availability (Hiruy and Sammut 2019; Smith 2007; Vira 2015; Tong 2018).



Fig. 20.2 A typical earthen pond system in Eastern Highlands Province constructed by a lead farmer. Most ponds are small and are integrated into vegetable or flower gardens (© J. Sammut)

The ponds provide a regular source of protein to households. Currently, there are two broad categories for pond-based farming based on level of intensity and farmer skills (Table 20.1, Sect. 20.3.2). Small-scale fishponds are constructed within or adjacent to vegetable gardens to utilize water that has been routed to irrigate crops. Integrating fish farming into the overall vegetable growing area helps to retain nutrients generated by the farms; pond effluent is discharged into the vegetable gardens, where it benefits crops.

The majority of farms in PNG can be classified as ‘improved extensive’ because farmers use only small amounts of formulated feed, mainly because of the high cost of fish feed, and do not use any mechanical aeration to maintain dissolved oxygen, as occurs in the higher density systems in Asia (Gupta and Acosta 2004a, b). Narimbi et al. (2018) found that the common practice of irregular feeding with fish pellets (usually weekly) is more cost efficient than daily feeding for ponds with low stocking densities in PNG; fish were found to utilize natural food for growth, and daily feeding using pelleted feed led to wasted nutrients and poor feed conversion ratios. By contrast, intensive pond-based systems used in other countries depend on mechanical aeration of ponds, regular water exchanges to maintain water quality due to the higher stocking densities, and high-grade, formulated feeds to achieve their high yields (Gupta and Acosta 2004a, b). However, although improved extensive farming of fish usually depends on low stocking densities, most farmers in PNG do not effectively manage in-pond fish breeding due to a lack of husbandry knowledge or a lack of effort (Hiruy and Sammut 2019). Consequently, unmanaged ponds become overcrowded

with the progeny of earlier stocked fish. Once tilapia reach reproduction age they may continue to breed, and this leads to higher feed requirements to maintain the growth performance of the fish. Additionally, water quality can deteriorate because of overcrowding.

To tackle the issue of overcrowding of ponds, lead farmers trained by NFA and the ACIAR project team have helped train other farmers to manage stocking densities by sexing fish and only farming males, which grow faster. However, this is a laborious and unwanted task, and the sex of tilapia cannot be determined until reproductive age is reached. To overcome this issue, NFA has trained farmers to produce and distribute all-male quality fingerlings. More recently, HAQDEC staff that were trained in hatchery practices in Asia (funded by NFA and Secretariat of the Pacific Community [SPC]) have successfully produced monosex fish (sex-reversed by hormone treatment to create all-male fingerlings) initially to support the ACIAR project's research and then for distribution to farmers. The sex reversal methodology is now being adopted by satellite hatcheries established by NFA. Since 2019, all-male fingerlings have become available through NFA's interventions thus eliminating the need to separate fish to prevent overcrowding of ponds.

Participating advanced farmers (Table 20.1) are often entrepreneurial, have better education, and have access to financial and social assets that enable them to invest in fish husbandry and quality fingerling production (Hiruy and Sammut 2019; Vira 2015). Subsequently, their yields are higher than for small-scale farmers (Table 20.1), and income generation is a priority over food security. Nevertheless, many small-scale farmers are improving their practices as a result of training and are aspiring to produce fish for supplementary income (Vira 2015). The program, through NFA, is currently developing strategies to enable more small-scale farmers to transition to an advanced level of farming; these strategies include widening the extension and training program, building the technical capacity of the Provincial Fisheries Officers to improve access to technical information, and informing NFA's development of a roadmap for aquaculture development.

20.3.2 Cage-Based Farming

Cage-based fish farming of tilapia (Fig. 20.3) is widely practiced in Asia, and was introduced to Yonki Reservoir, in EHP in 1994, five years after the reservoir was built. Initially the activity was not well received as the surrounding community preferred to exploit the wild fishery. Nevertheless, the stocking of the reservoir helped to provide protein to the communities surrounding the lake, as well as travellers along the Highlands Highway.

By the early to mid-2000s, wild fish stocks started declining due to unregulated fishing mainly through the indiscriminate use of various size gill nets that caught most age classes of fish thus reducing population recruitment (Wani 2004). The declining wild catches renewed interest in cage-based fish farming. By this time, the earlier access to wild fish had established a market chain for fish and an acceptance of fish as



Fig. 20.3 Cage-based farmers at Yonki Reservoir. Farmers have been trained by the project team and also supported under a previous SPC project. Cage-based farming utilises the water resources of hydro-electric reservoirs. However, there is an urgent need to develop management guidelines and carrying capacity models to minimise environmental impacts (© J. Sammut)

an alternative source of protein in communities that traditionally consumed pork—usually only during ceremonies—or other village livestock, such as chickens. A lack of quality fingerlings and access to feed, along with poor knowledge of fish husbandry, slowed the growth of the industry until NFA and ACIAR project staff, along with projects funded by SPC facilitated access to technology, knowledge, feed, and farm infrastructure. More recently, NFA facilitated the establishment of a hatchery at Yonki specializing in production of all-male fingerlings, which has alleviated pressure on HAQDEC to provide fingerlings to cage-based farmers. The success of the NFA-funded fingerling production training of lead farmers and project staff sent to the Asian Institute for Technology in Thailand, along with subsidized imported feed and nets in 2018, led to an increase in production (Hiruy and Sammut 2019). There is now a total of 77 semi-commercial cage fish farmers at Yonki Reservoir.

Cage fish farming at Sirinumu Reservoir, located in Central Province approximately 45 km east of Port Moresby, was introduced by NFA in 2003 after the landowners requested NFA to stock the reservoir with barramundi fingerlings to establish recreational fishing opportunities at the reservoir to bolster tourism. At the time, the sustainability of a recreational fishery was unknown, but the viability of cage-based farming was considered high due to the optimal water temperatures

for tilapia growth compared to the colder water of Yonki Reservoir, thus enabling farmers to produce more crops each year. NFA proposed and supported cage fish farming rather than recreational fishing given that food security was a priority and income could still be generated from cage-based farming. As for Yonki Reservoir, accessibility to fingerlings and feed are still the main impediments to farming at this location. With the establishment of two satellite hatcheries for sex-reversed (all male) tilapia fingerlings and availability of NFA subsidized feed, semi-commercial tilapia farming on Sirinumu is accelerating and surrounding areas, and residents of Port Moresby have benefited from access to fish-based protein. There are now 100 full time semi-commercial fish farmers on the reservoir. Most of the farmed fish is either sold fresh at the farm site or cooked and sold in the nearby township of Sogeri.

20.4 Strengths, Weakness, Opportunities and Threats Analysis (SWOT) of Inland Aquaculture

The NFA-UNSW program of research has mainly focussed on clearing current bottlenecks to production, such as access to feed and quality fingerlings, and exploring the opportunities to grow the industry sustainably with food and nutrition security priorities over income generation. The program has utilized Sustainable Livelihoods and Lifestyle Analysis (SlifA) and several provincial and country-wide SWOT Analyses, along with various social impact assessment methods, to evaluate the status of the industry and to scope current and emerging issues to underpin NFA's strategic development processes. This section summarizes the findings of Vira (2015) and Tong (2018) and data from ACIAR Project FIS/2014/062 collected across eight fish farming provinces in PNG as a basis for strategic development of the industry by NFA (Table 20.1) and to inform the R4D program. Information from our active SlifA research (Hiruy and Sammut 2019) and data from interviews of lead farmers, farmer cooperatives, and staff of our project partners are also incorporated.

20.4.1 Strengths and Weaknesses

The strengths and weaknesses are largely internal factors that affect the sustainability of the industry. The tradition of farming is a key strength in PNG, despite the differences between growing fish and farming vegetables (Vira 2015). The concept of producing your own food is integral to subsistence farming in PNG and has helped farmers to adopt fish farming as a companion practice, mainly to address dietary protein deficiencies (Vira 2015). Although this is a strength, a related weakness is a poor understanding that fish, unlike vegetables, require a different skillset and more investment in husbandry to maximize yields (Tong 2018; Vira, 2015). Fish farming success depends on a supply of quality fingerlings, good fish feeding strategies,

Table 20.1 Tilapia farming categories and systems in PNG based on survey data collected by ACIAR Project FIS/2014/062

Farmer category	Goal	Average yield per ha per crop	Other characteristics
Small-scale (Subsistence farming)	Household protein needs followed by secondary income	< 50 kg/ha/crop	Usually dependent on fingerlings from others; low fish feeding frequency; vegetable garden waste as fish feed with limited supplementary commercial feed; pond fertilization to increase natural food Limited fish husbandry skills
Medium-scale (Advanced pond-based farmers)	Income then household protein needs	300 to 400 kg/ha/crop	Higher stocking and feed frequency; incorporate commercial feed or their own milled fish pellets; usually sell fish at markets; fingerling production has developed as a side business; better infrastructure and financial assets at outset
Cage-based farmers (Advanced)	Income then household protein needs	>1.5 tonnes/farm/crop	High stocking densities; entirely dependent on commercial feed; farmers have developed a short market chain; able to sell to retail sector but currently poor price negotiating power Currently practiced in Yonki Reservoir in Eastern Highlands Province and Sirinumu Reservoir in Central Province

managing stock to reduce in-pond breeding, and maintaining good water quality. Farmers with a poor understanding of fingerling quality are likely to stock their ponds with stunted adult fish purchased at markets and passed off as fingerlings by unscrupulous sellers. The causes of stunting in fish include poor nutrition as a result of low-quality or expired feed, poor feeding strategies, environmental stress affecting appetite, or increased competition for feed due to farmers not removing the progeny of adult fish in ponds. Farmers report that ponds are overcrowded with

progeny resulting from uncontrolled breeding (Hiruy and Sammut 2019; Vira 2015) but they are unable to distinguish which fish are stunted from recently stocked fingerlings. Stunting can also occur if fish divert energy away from muscle growth to meet reproductive energy demands.

The high cost and poor access to quality formulated feeds is a major bottleneck to growth of the industry and a cause for poor farm yields. Fish feed accounts for more than half the production cost (El-Sayed 1999) and in PNG can be upwards of 70% if farmers feed their stock daily due to higher feed costs compared to other countries (Hiruy and Sammut 2019). Interviewed farmers complained that fish feed, when available, was too expensive, or that they had no understanding of the feeding frequency required to maximize their yields. Many farmers also do not keep records to determine their input and production costs, thus being unable to determine if fish farming is profitable. For subsistence farmers, producing fish for the household is not problematic since many do not depend on a high fish feed input, and fish of any size are considered edible. Nevertheless, increasing the size of farmed fish and improving farming efficiency can enable farmers to also sell excess fish after household protein needs are met. Project survey data suggest that up to 40% of excess fish are shared with others in the community, thus making protein more accessible. However, farmers that produce fish primarily for income are impacted by the high cost and low availability of fish feed in PNG, and this can lead to farm abandonment (Vira 2015). This is particularly the case for cage-based farmers who depend entirely on formulated fish to grow their fish. By contrast, small-scale pond-based fish farmers utilize natural food (e.g., insects and algae), fertilizer to enhance primary production, and vegetables or crop waste to supplement the diets of farmed fish (Narimbi et al. 2018; Parata et al. 2020).

The lack of road infrastructure in PNG, along with limited cold storage facilities and cold transport services, limits the distribution of fish from farming areas to markets (Hiruy and Sammut 2019; Vira 2015). Consequently, farmers who are not located close to a major highway, or without access to cold storage, cannot sell fish to the more lucrative markets in urban areas. Regardless, transport costs in PNG are also high and a disincentive to small-scale farmers with low financial capital to distribute their fish more widely.

Support from members of the farmers' wantok system is a key strength given that the high cost of labour associated with constructing farms is addressed by kin contributing to pond building and construction of water supply infrastructure (Tong 2018; Vira 2015). The wantok system is based on reciprocity and has enabled our various projects to build knowledge chains with lead farmers as nodes where wantoks intersect. Wantok translates to 'one language' or applied to people who speak the same dialect' but can also be used to describe people of common kinship, social or religious groups, or ethnic identity (de Renzio 2000). Generally, it is a network of relationships and behaviours, and also a key source of social capital (Reilly 2001). Later in this chapter, more detail is provided on how working with lead farmers and utilizing the wantok system has enabled fish farming knowledge transfer in PNG.

Social capital under the wantok system enables farmers to reach agreements on water resource sharing, which is critical to farmers who do not own land adjacent to a permanent water supply. Under the wantok system, farmers have built pipelines to transfer water to their kin, and in keeping with the spirit of reciprocity, the beneficiaries of shared water provide labour and other support to their wantoks. Farmers have also reported that under the wantok system, excess fish are shared, often to honour informal debt for assistance with pond construction and water sharing. This has facilitated better access to protein to wantok members who do not farm fish or livestock and has also fostered interest to eat and farm fish (Joe Alois, NFA, personal communication, Hiruy and Sammut 2019).

20.4.2 Opportunities and Threats

Opportunities listed in Table 20.2 are currently being explored or have recently been integrated into NFA's strategic planning for inland aquaculture development. The growth of the industry has had a commensurate increased interest in farming as well as recognition, by government, of the value of fish farming to meeting the protein needs of people. This is reflected in the PNG Government's various development strategies (e.g., amendment for the Fisheries Management Act 2015 to include aquaculture in its objectives). NFA's Aquaculture and Inland Fisheries Unit is also investing more in the production of quality fingerlings and providing farmers with subsidized feed while efforts are underway to improve commercial supply of fish feed. For example, NFA is establishing satellite hatcheries through partnerships with provincial governments and farmers to overcome lack of fingerling supply that has, until recently, been limiting growth of the industry. Until this program was established, farmers relied on HAQDEC, which could not meet the demand for fingerlings, and advanced farmers, who are not always able to deliver fingerlings to other provinces. In partnership with ACIAR-funded projects, NFA is also investing more in farmer training programs for extension staff and farmers and transferring technical knowledge from research projects to formal training programs at universities, colleges, and training centres.

In recent years, advanced pond-based farmers and local entrepreneurs have been responsible for the surge in cage-based farming, utilizing the water resources of artificial reservoirs. With support from NFA and SPC projects, farmers have developed business plans and have been provided business start-up support. The ACIAR-funded program of research is expanding to tackle the bottlenecks for cage-based farming, mainly to address fish nutrition challenges, and to determine the carrying capacity of reservoirs and develop better management practices to meet economic and environmental goals. To date there are no guidelines for cage-based farming in the PNG context, thus the team is shifting some of the research focus towards developing better management practices that minimize environmental impacts and maximize fish production. Similarly, the project team is working with NFA to develop better decision-making processes so that the cage-based industry grows sustainably and does not cause environmental degradation, as has occurred elsewhere in the world.

A threat to food system security lies in that many of the raw ingredients for fish feed are utilized for other livestock (Glatz 2012; Glatz et al. 2013). The lack of affordable fish feed has been temporarily addressed by NFA importing feed from Vietnam and subsidizing the cost for farmers. This approach is considered a short-term intervention. Accordingly, NFA is developing strategies, in partnership with the NFA-UNSW ACIAR-funded projects, to facilitate local feed production and to reduce the cost of feed ingredients for commercial and farm-based milling of pellets. The program of research is entering a new phase that involves breaking the dependency on imported feeds and to utilize alternative, locally sourced feed ingredients for medium-scale, pond-based farming and cage-based production, and strategies to improve natural food production for small-scale farms.

Theft of fish is prevalent in PNG and a major reported threat. Farmers often report that entire fish crops are stolen usually as they near harvest size. Farmers are building new houses closer to their ponds to monitor their crops (Vira 2015) but fencing to secure farms is too expensive for small-scale farmers. Jealousy can often lead to sabotage, such as poisoning fish crops with plant-based toxins or chemicals. Early in the program, trout farms in EHP were affected by regular sabotage of stock to the point that some farms ceased operation. Such events are also blamed on sorcery leading to tribal fighting (Sister Pauline Kagl, Sisters of Notre Dame, personal communication). On one hand, tribal fighting, which is commonplace in PNG (Reilly 2008), can lead to destruction of farming infrastructure, prevent farmers from accessing their ponds and also impact technical support for farmers due to risk to extension staff. On the other hand, fish farming has also helped to reduce or end tribal conflicts in the highlands of PNG by bringing tribal fighters together to share resources and build ponds (Hiruy and Sammut 2019; Vira 2015).

The genetic robustness of tilapia in PNG is also a threat, but yet to be investigated (Vira 2015). GIFT is the most widely farmed tilapia strain in PNG and all GIFT can be sourced to nine fish that were imported in 1999 by the JICA project. The extent to which inbreeding has affected the genetic robustness and the growth and reproductive performance of GIFT is unknown but nonetheless considered a threat by NFA (Vira 2015). Interestingly, fast growing and larger GIFT are reported from the Fly River in Western Province, and it is postulated that tilapia farmed on the Indonesian side of New Guinea could have contributed to the genetic profile of fish in this system via escapes or translocation by fish farmers who regularly cross the border. Alternatively, accelerated natural selection of fast-growing GIFT may have occurred. Plans by NFA to introduce new GIFT broodstock from Asia are currently deferred due to the risk of introducing Tilapia Lake Virus (TiLV) which has devastated tilapia farming in other countries (Jansen et al. 2019). Nevertheless, there is risk of TiLV entering PNG from Indonesia (currently TiLV free), most likely via the Fly River in Western Province where a section of the river forms part of the border. There is currently no biosecurity plan to address this risk in PNG.

Table 20.2 Summary of SWOT Analysis findings for inland fish farming based on a synthesis of information from Hiruy and Sammut (2019), ACIAR Project FIS/2014/062, Vira (2015) and Tong (2018)

Strengths	Opportunities
<p>Tradition of growing food</p> <p>Ability to integrate fishponds into vegetable gardens</p> <p>High social capital to build ponds and share water resources via the wantok systems</p> <p>Good soils for earthen ponds</p> <p>Some provinces have consistent rainfall</p> <p>National Fisheries Authority commitment to developing the industry</p> <p>History of donor interventions</p> <p>Established knowledge networks and wantok system as a source of social capital</p>	<p>Growing demand for fish</p> <p>Utilization of reservoirs for cage-based farming</p> <p>Integration of fish farming into school and university programs</p> <p>Scaling up of advanced farmers to create demand for local feed production</p> <p>Creation of a local feed production industry to reduce feed costs</p> <p>Model farms in provinces to educate farmers</p> <p>Expansion of satellite hatcheries</p> <p>Farmers have developed trust through working with research and extension agencies</p> <p>Farmers demonstrated eagerness to learn better management practices</p> <p>Potential for a retail market and fish processing business</p> <p>Further development of knowledge networks using social systems and improved government support services</p>
Weaknesses	Threats
<p>Lack of financial assets to scale up production systems</p> <p>Lack of business acumen in farming community</p> <p>Poor access to fish feed and raw ingredients</p> <p>High cost of fish feed</p> <p>Poor fish husbandry skills</p> <p>Lack of a market chain</p> <p>Lack cold storage and cold transport in remote areas</p> <p>Inadequate road infrastructure to transport inputs and farm outputs</p> <p>Lack of postharvest skills</p> <p>Remote farmers have limited access to technical support</p> <p>Limited supply of aquaculture inputs</p> <p>Outdates development strategies for inland aquaculture</p> <p>Reduced funding to NFA due the 90/10 Act</p>	<p>Introduced fish diseases, particularly Tilapia Lake Virus</p> <p>Climate change</p> <p>Droughts and floods</p> <p>Theft of fish</p> <p>Sabotage due to rivalry and jealousy</p> <p>Competition for raw ingredients for fish feed</p> <p>Escalating feed costs</p> <p>Interruption to production and destruction of ponds and water supply due to tribal wars</p> <p>Genetic quality of GIFT in PNG</p> <p>Long-term reduced funding to NFA and other government agencies</p>

20.5 Generating Impact Through Fish Farming

This section discusses how the NFA-UNSW led program has generated impact in PNG using examples of our sub-programs and links to NGOs and other projects. The focus is on the social impacts from the extension programs rather than the scientific impact from the core research on fish nutrition and fish husbandry.

20.5.1 Utilizing Social Networks and Lead Farmers for Information Transfer

PNG has complex social networks (Baynes et al. 2017; Nanau 2011) that can be utilized to share knowledge on fish farming and nutrition. In PNG, the wantok system can often provide social welfare support utilizing well-established relationships, and trust and cooperation with other wantoks (de Renzio 2000). Accordingly, communities with a high level of social capital in PNG are likely to have greater capacity at collectively solving problems or facing new challenges largely through trust that facilitates sharing of time and effort (de Renzio 2000); thus, the social capital of a wantok can help new fish farmers to address the labour-intensive needs of establishing new ponds, as well as facilitating the sharing of new knowledge, fingerlings, and resources such as water needed to start farming fish (Vira 2015; Tong 2018; Hiruy and Sammut 2019).

With this understanding of wantoks, and the team and partner agency staff and NGOs belonging to various wantoks in the area of activity, it has been possible to promulgate new technologies and fish farming knowledge across PNG. Additionally, knowledge on the health benefits of consuming fish is shared. Earlier projects identified the importance of training and mentoring lead farmers (advanced farmers). These farmers were and continue to be identified and trained by NFA, the ACIAR Project team, other donor agencies and NGOs, to establish de facto fish farming trainers and advocates for better farming practices and promoting fish as a healthy source of protein. They also provide feedback from farmers on the partnerships' interventions, as well as helping to understand farmer needs. The selected lead farmers are often community leaders or have established a successful farming operation that has brought them status. Under the ACIAR projects, and through NFA's training interventions, advanced farmers are taught all aspects of fish farming, mainly site selection, fish husbandry, fish feed production, pond maintenance, harvest methods, and business management. As these projects produce new knowledge and technologies, the outputs are transferred to lead farmers who then disseminate the outputs more widely via their wantoks. Mentoring of lead farmers is undertaken by the project team and Provincial Fisheries Officers and facilitated by NFA's extension programs. Lead farmers are also trained and mentored by the project partners, for example, The Sisters of Notre Dame, a Catholic order of sisters who are embedded in the project. The Sisters of Notre Dame have combined fish farming training with their

missionary work in remote areas thus helping the umbrella program of extension, managed by NFA and the ACIAR project team, to extend its reach. The Sisters also promote the nutritional benefits of fish to children and adults. NFA also provides financial support and training to Provincial Fisheries Officers in major fish farming provinces, and also supports various NGOs that provide livelihoods training.

20.5.2 Formal Training

The Sisters of Notre Dame, at the Maria Kwin Training Centre in Jiwaka, also deliver certificate-level fish farming training to lead and other farmers, as well as training women ostracized from their community due to sorcery accusations or have fled because of domestic violence (Fig. 20.4). The Maria Kwin Centre also formally trains former drug addicts, single mothers, delinquent youths, gang members and people, who have faced financial hardship, to create a livelihood. The Sisters also use fish farming in their Personal Viability Training Program, a formal program that aims to build self-respect and self-esteem, improve gender relations, reduce violence against women, and develop positive social behaviour. The NFA National Fisheries College in Kavieng also provides certificate-level training with selected farmers sponsored by NFA to attend courses at the College. Selected lead farmers have also been trained by SPC projects, and some sent to Asia to receive training in specialized areas, such as hatchery production of fingerlings. The ACIAR project team also coordinates formal training programs for NGOs and farmer groups.

Through NFA, these project technologies and farming knowledge are also transferred to Provincial Fisheries Officers who provide further technical support to farmers. For example, trained Provincial Fisheries Officers, including staff embedded on the project, have established satellite hatcheries and fish farms in Morobe Province where they also coordinate training programs and are working with the local prison to establish fish ponds. However, the lack of resources and funding issues limits the ability of trained Provincial Fisheries Officers to undertake field activities (Hiruy and Sammut 2019; Tong 2018; Vira 2015); this issue is being tackled by the NFA through a roadmap for strategic development of inland aquaculture in which increased support for Provincial Fisheries Officers is flagged as a key intervention.

20.5.3 Fish for Schools Program

The Fish for Schools program was established by the National Fisheries Authority of PNG to develop an interest in fish farming as a future livelihood option in youths, to build fish farming skills for high school students unlikely to continue to tertiary-level study, and to enable teachers to use fish farming to support teaching. Teachers, for example, use the fishponds to teach human nutrition, ecology, biology, physics, mathematics, economics, agriculture, and physics. Technical information is provided



Fig. 20.4 A training day at Warala Village in Jiwaka Province. In partnership with local lead farmers, the Sisters of Notre Dame and the NFA team members conduct certificate level training enrolled at the Maria Kwin Centre as well as using locations like this to train farmer groups (© J. Sammut)

by the NFA staff and draws on training in fish husbandry developed under the ACIAR and NFA-funded projects. As farming technology from the research projects becomes available, it is transferred to the Fish for Schools program. Additionally, the program has provided access to fish in school canteens, raised awareness of the nutritional value of fish, and facilitated knowledge transfer to nearby communities, mainly through school children sharing knowledge with their parents and partly through the presence of the fish farms on school campuses; the fish farms have drawn interest in fish farming in the wider community.

20.5.4 Fish for Prisons Program

The Fish for Prisons program was initiated by NFA in partnership with the PNG Correctional Services. The primary goal of the program is to build skills in fish farming for prisoners to provide a livelihood option for their release. For many prisoners, re-entering the workforce is challenging due to the stigma associated with a criminal record and a lack of skills. Released prisoners lose status in their community and are often alienated. Without an opportunity to earn income or draw on the support of their community, the risk of re-offending is high. From the outset, it was

theorized by the founders of the program that skills in fish farming could break the cycle of crime and repeated incarceration. Furthermore, the program was designed to build self-esteem in prisoners, which is often already low before incarceration and made worse by being kept away from family and communities during their term. Through involvement in this NFA program, the project team has worked alongside prisoners through training activities and by mentoring them through all stages of fish production. This process has built trust between the NFA, the project team members, and the prisoners, facilitated information exchange, and built a rapport with prisoners that has been critical to improving their feelings of self-worth and restoring their dignity. Most released prisoners have also maintained communication with the project team, seeking technical advice and mentorship. The prisoners construct the ponds, manage the water supply, stock, feed fish, monitor the health of the stock, and conduct day-to-day pond maintenance such as clearing weeds, repairing pond walls and canals, and evaluating the condition of the fish. The prisoners also harvest their fish for the prison kitchen thus providing access to much needed protein. The themes of hope and restoring dignity are regularly communicated by the prisoners to the project team.

Gaius (surname withheld), serving a 28-year term, speaks of how fish farming has given him hope and will one day enable him to become 'somebody':

When I came to prison I thought I have no choice or I have no hope. I think I will just stay here in prison, and when I release (sic), I go back. I have no choice (future choices), because I am in prison and everything is gone, and I will just go and stay a poor person. I am happy that when I finish, when I release (sic) from prison, and I go back to my home, I'll do that job (fish farming). I'll try and look after fish because my area has many good rivers, many good creeks from the mountain to valley, so I can dig some fish ponds and look after fish, so I get some knowledge (from the training program), and then go back to my home, I'll become somebody.

In other interviews, Gaius and his peers mention aspirations to seek formal qualifications in fish farming from the NFA National Fisheries College in Kavieng or at the Maria Kwin Centre in Jiwaka Province. Other prisoners have shared similar stories of hope and wanting to be 'somebody' again, despite their long prison terms. Each prisoner's narrative describes fish farming and the associated training as a means of addressing idleness, improving their mental health, and setting goals for the future. "We have proven that we can grow fish. Fish is food now and tomorrow, and fish will become kina (local currency) when I am released. People see me again and now I am a good man again," (unnamed prisoner, Bihute Prison). Most significant is the reference to fish farming restoring dignity and having a skill to be proud of, often conveyed to our team with emotion. The change in the temperament of the prisoners is also voiced by the prison staff who consider the program to have reduced disruptive behaviour within the prison.

Prison Officers, who have worked alongside our team and the prisoners, have also built skills in fish farming and some have incorporated fish farming into their retirement planning. Under our previous project we also conducted similar training with retiring military staff to provide a livelihood post-government service. Currently, the Fish for Prisons program has involved men's prisons, but plans for extending

the program to women's prisons are under consideration by NFA and the PNG Correctional Services.

The project team has also mentored and monitored prisoners following their release from prison, including some who were released over a decade ago and who have now fully regained status in the community and become lead farmers. To the best of the project team's knowledge, and based on the records of participating prisons, former inmates who were trained under the program have not re-offended. Fish farming has provided an opportunity to demonstrate to their communities their capacity to apply themselves to a livelihood rather than to be seen as a probable re-offender. Over time, the success of fish farming draws interest from others, and sharing of knowledge and excess fingerlings have helped to restore dignity in ex-prisoners and elevate their status.

Moxy (surname withheld), is a long-term participant of the program. Trained by NFA at Bihute Prison during his prison term and released over a decade ago, Moxy is known locally as "Daddy Fish", which is not just a light-hearted nickname, but a name that reinforces his status as a lead farmer in his district. Moxy is both amused and proud of this nickname, with the pride clearly of more importance as he communicates to his mentors from our team of the significant positive impact of fish farming. Following his release from prison, Moxy built his own ponds in the shadow of scepticism from his community but with supervision from NFA staff based in nearby Goroka. At the time he was still seen as a criminal outside of his family and close friends thus having limited access to the community's social capital, principally labour to dig ponds and financial support. He was successful at establishing ponds and producing reliable crops, and this drew attention from other fish farmers and people interested in building fishponds. Within several years of establishing his own farm, Moxy's ponds became an unofficial demonstration site, and he became an advocate for fish farming, and a lead farmer and trainer under our program. His status was renewed, and in his opinion, it was higher than before his incarceration. His fish farm business, which also involves his wife and adult children, provides sufficient income to maintain the household, and to access better medical services and education for his school-age children. Moxy describes how his fish farm has enabled him to live an honest life:

Sometimes, when I feel could do wrong again, I come down to my fish farm and I look at what I have achieved. It brings me peace. It stops me from doing wrong. Working with fish calms me down and I feel proud of what I have created.

This feeling is sentimentally repeated to the project team by Moxy during site visits, and similar remarks are heard from former raskol gang members. Moxy's community peers also mention the transformation in Moxy since his release from prison and speak of the inspiration gained from seeing his success. Since his release from prison, Moxy has worked alongside the ACIAR project team at farmer field days and other events where the project team conduct extension support to farmers. His role as a communicator of knowledge and a champion for fish farming has led to more farmers adopting technologies and practices developed by the NFA and ACIAR-funded projects.

20.5.5 Working with Raskol Gangs and Tribal Fighters

Raskol is a PNG term for gang members who are known for violent crimes. Raskol gangs are usually active in impoverished areas, particularly in remote areas where police resources are limited. Raskol gangs are also active in and around the settlements in major urban areas such as Port Moresby and Lae. The NFA and ACIAR-funded projects include project partners that operate in areas where raskol gang activity is prevalent. Raskol gangs have participated in fish farming training delivered by the project team to farmers in the highlands, and also via the Sisters of Notre Dame who have outreach programs in remote areas. As a result of skill building, and the positive social interaction between the extension staff and gang members, Raskol gang members have developed a better appreciation of their worth to their community and society. The responsibility and rewards from fish farming have increased self-esteem and enabled former gang members to set goals and develop strategies to develop their farms.

Fish farming gives them purpose and helps them to redeem themselves and to atone, and this enables acceptance by the community. They don't want to be seen as gang members once they realize what they can achieve through fish farming. It is their ticket back to society.
(Sister Pauline Kagl, Sisters of Notre Dame)

Of note is the impact of fish farming training on crime reduction along the Highlands Highway, the only roadway that links the Highlands to the coast. In areas where fish farming has been adopted, villagers have reported a decline in crime committed by raskols, as well as reduced youth delinquency (Sister Pauline Kagl, Sisters of Notre Dame, personal communication). The 'Barola Hotspot', a short stretch of the highlands highway near the major township of Kainantu in EHP, was well known for carjacking, rapes, roadside robberies, and other violent crimes against travellers. Through fish farming training conducted by the project team, raskol gang members abandoned their criminal activities at this location. Their participation was uninited, but they were drawn in by curiosity and accepted into the training program. Within a year of training, the participants had cleared marijuana crops to construct ponds, contributed to the construction of ponds for the community, and also helped to establish a fish farming training centre in partnership with the local community and government. Joe Alois, staff of NFA and a trainer under our program noted:

At the launch of the aquaculture training centre at Barola, the former raskol gang burnt drugs and weapons to demonstrate a commitment to a new life. Since the training, the Barola Hotspot has been free of violent crimes. We mentor the former raskols, who we now treat as fish farmers and ensure they have the technical support to keep succeeding.

Similar reduction of crime along the Highlands Highway has been attributed to the training provided by the project partner, the Sisters of Notre Dame, and also by lead farmers trained under NFA and our extension program (Hiruy and Sammut, 2019). Interviewees reported that fish farmers depend on social networks and that raskols must work harder to be accepted back into a wantok; initially, this is a challenge for raskols, but their contribution to pond construction helps to foster acceptance

by the community (Sister Pauline Kagl, Sisters of Notre Dame, personal communication 2018). The responsibility and comradery needed to develop farms and share resources, reduces the idleness that underpins anti-social behaviour. Nevertheless, social problems such as jealousy and subsequent sabotage of farms, as well as theft of stock, remain a problem (Vira 2015) and are difficult to address.

20.6 Conclusion

Fish farming has had demonstrable positive social impacts in PNG. Although this research program has focussed on clearing technical bottlenecks for fish production to improve access to protein, the unexpected social impacts of working with lead farmers and farming communities have demonstrated the wider benefits of aquaculture in PNG. Investment in training and mentoring lead farmers, partnerships with NGOs, and utilizing wantoks as knowledge networks has not only enabled the spread of fish farming knowledge—it has led to broader access to protein, particularly in remote rural areas, and improved food security. The accelerated growth of fish farming and its social, health, and economic benefits, has revitalized government support for the industry as demonstrated by recent amendments to the PNG Fisheries Management Act (2015) to include aquaculture objectives. This collaborative program is expanding to develop new strategies for aquaculture in PNG based on the technological outputs and the now well-established knowledge networks and partnerships with stakeholders. The NFA Aquaculture and Inland Fisheries Unit, the major local partner, is now well positioned to develop strategies to help transition small-scale farmers to higher intensity practices, and to facilitate access to affordable protein in urban areas via fish supply from cage-based farmers. The described recent research breakthroughs on fish nutrition and the production of quality fingerlings, and NFA's success in establishing satellite hatcheries, have cleared significant bottlenecks. The greatest challenge is to resolve issues with the supply of cost-effective formulated feed to support the emerging cage-based farming industry and the transition to higher intensity pond-based farming. If aquaculture production levels can reach those of nearby Asian countries, many of the health issues associated with low protein in diets can be alleviated.

Acknowledgements Our R4D inland aquaculture projects (ACIAR Projects FIS/2014/062, FIS/2008/023, FIS/2009/027) were funded by the Australian Centre for International Agricultural Research (ACIAR) and the National Fisheries Authority of PNG and led by the University of New South Wales in partnership with the NFA Aquaculture and Inland Fisheries Unit. We are grateful to our project partners, The PNG Correctional Services, The Sisters of Notre Dame, The PNG Department of Agriculture and Livestock (DAL) and the Australian Nuclear Science and Technology Organisation (ANSTO) for their contribution to research and extension. Our PNG-based team members, Sister Pauline Kagl, Joe Alois, Billy Kerowa and Micah Aranka are thanked for capturing impact stories during their engagement with the farming community, schools, and prisons. We thank our lead farmers, Provincial Fisheries Officers, prisoners and former prisoners, farming communities, and the various stakeholders who openly shared their stories on the challenges and benefits of fish farming in PNG.

References

- Anderson T (2006) On the economic value of customary land in Papua New Guinea. *Pacific Econ Bull* 21(1):138–152
- Asian Development Bank (2012) Asian Development Bank and Papua New Guinea: factsheet. Asian Development Bank <http://www.adb.org/publications/papua-new-guinea-fact-sheet>
- Barker D (1997) Maternal nutrition, fetal nutrition, and disease in later life. *Nutrition* 13(9):807–813
- Baynes J, Herbohn J, Unsworth W (2017) Reforesting the grasslands of Papua New Guinea: the importance of a family-based approach. *J Rural Stud* 56:124–131
- Bourke CD, Berkley JA, Prendergast AJ (2016) Immune dysfunction as a cause and consequence of malnutrition. *Trends Immunol* 37(6):386–398
- Bourke R, Gibson J, Quartermain A, Barclay K, Allen B, Kennedy J (2009) Food production, consumption and imports [in Papua New Guinea]
- Centres for Disease Control and Prevention (2019) CDC impact in Papua New Guinea. https://www.cdc.gov/globalhealth/countries/papua-new-guinea/pdf/Papau_New_Guinea_Factsheet.pdf
- de Renzio P (2000) Bigmen and Wantoks: social capital and group behaviour in Papua New Guinea. QEH working paper series, 27
- El-Sayed AFM (1999) Alternative dietary protein sources for farmed tilapia, *Oreochromis* spp. *Aquaculture* 179:149–168
- FAO (2017) Fishery and aquaculture country profiles independent state of Papua New Guinea. <http://www.fao.org/fishery/facp/PNG/en>
- Gibson RS, Heywood A, Yaman C, Sohlström A, Thompson LU, Heywood P (1991) Growth in children from the Wosera subdistrict, Papua New Guinea, in relation to energy and protein intakes and zinc status. *Am J Clin Nutr* 53(3):782–789
- Gillespie S, Haddad L (2001) Attacking the double burden of malnutrition in Asia and the Pacific. ADB nutrition and development series number 4
- Glatz P (2012) Enhancing role of small scale feed milling in the development of the monogastric industries in Papua New Guinea. Retrieved 2015 from ACIAR: <http://aciar.gov.au/project/ asem/2010/053>
- Glatz P, Workneh A, Black I, Pandi J, Deklin J, Mazi M et al (2013) Improving profitability of village broiler production in PNG. ACIAR, Canberra
- Global Health Index Data Exchange (2020) Papua New Guinea. <http://ghdx.healthdata.org/geography/papua-new-guinea>
- Global Nutrition Report (2020) Papua New Guinea Nutrition Profile. <https://globalnutritionreport.org/resources/nutrition-profiles/oceania/melanesia/papua-new-guinea/>
- Glucksman J, West G (1963) Freshwater fisheries. Department of Agriculture Stock & Fisheries (unpublished internal report–NFA archives), Port Moresby
- Government of PNG (2016) National Nutrition Policy, 2016–2026. Government of PNG, Port Moresby. Accessed from <https://www.unicef.org/png/media/1296/file/PNG-Reports-Nutrition-Policy.pdf>
- Gupta MV, Acosta BO (2004a) From drawing board to dining table: the success story of the GIFT project. *NAGA, WorldFish Center Quarterly* 27(3–4):4–14
- Gupta MV, Acosta BO (2004b) A review of global tilapia farming practices. *Aquaculture Asia* 9:7–12
- Hiruy K, Sammut J (2019) Preliminary assessment of the impact of inland aquaculture research for development in Papua New Guinea: a sustainable livelihood and lifestyle analysis (SLiFA). Report to the National Fisheries Authority of PNG, ACIAR Project FIS/2014/062, 30
- Hou X (2015) Stagnant stunting rate despite rapid economic growth in Papua New Guinea. Policy research working paper 7301. Health Nutrition and Public Practice Group. World Bank Group
- Hurney M (2017) Short changed: the human and economic cost of child undernutrition in Papua New Guinea. Save the children, Australia
- International Food Policy Research Institute (2016) Global Nutrition Report 2016: from promise to impact: ending malnutrition by 2030. Washington, DC

- Jansen MD, Dong TH, Mohan CV (2019) Tilapia lake virus: a threat to the global tilapia industry? *Rev Aquac* 11:725–739
- Kan TT (1981) Some aspects on the state of aquaculture in PNG. Conference on economic development and growth of Papua New Guinea (pp 1–19). University of Technology (NFA archives), Lae
- La'a K, Glucksman J (1972) Experimental fish ponds in the highlands. *Harvest* 2(2):71–73
- Martorell R et al (2010) Weight Gain in the First Two Years of Life is an Important Predictor of Schooling Outcomes in Pooled Analyses from Five Birth Cohorts from Low- and Middle-Income Countries *J Nutr* 140(2):348–354
- Masuda K, Vonole R, Sagom P (1994) Viability of trout farming in Papua New Guinea. Port Moresby: Department of Fisheries and Marine Resources (unpublished internal report)
- Muntwile M, Shelton RM (2000) Survey of nutrition and protein intake in rural families in Eastern Highlands Province. Papua New Guinea Food and Nutrition 2000 Conference Lae, Papua New Guinea, PNG University of Technology: 432–442
- Nanau G (2011) The Wantok System as a Socio-economic and Political Network in Melanesia. *J Multicul Soc* 2(1):31–55
- Narimbi J, Mazumder D, Sammut J (2018) Stable isotope analysis to quantify contributions of supplementary feed in Nile Tilapia *Oreochromis niloticus* (GIFT strain) aquaculture. *Aquac Resh* 49(5):1866–1874
- Parata L, Mazumder D, Sammut J, Egan S (2020) Diet type influences the gut microbiome and nutrient assimilation of Genetically Improved Farmed Tilapia (*Oreochromis niloticus*), *PLoS One* 15 e0237775
- PNG Department of Health (2015) Annual Report on Child Morbidity and Mortality for 2015 <http://pngpaediatricsociety.org/%20wp-content/uploads/2013/05/2015-Annual-Child-Morbidity-and-%20Mortality-Report.pdf>
- ODE Review UNICEF (2013) Improving Child Nutrition: The achievable imperative for global progress, April 2013, UNICEF
- Office of Development Effectiveness (2015) A window of Opportunity: Australian Aid and Child Undernutrition, April 2015 Commonwealth Government of Australia. Burnet Institute
- Reilly B (2001) Democracy, Ethnic Fragmentation, and Internal Conflict. *International security* 25(3):162–185
- Reilly B (2008) Ethnic conflict in Papua New Guinea. *Asia Pac Viewp* 49(1):12–22
- Reynolds LF (1970) Fish culture in fertilized ponds. Port Moresby: Department of Agriculture Stock & Fisheries (Unpublished internal report—NFA archives)
- Schmidt E, Gilbert R, Holtemeyer B, Rosenbarch G, Benson T (2019) Papua New Guinea Survey Report: Household Survey on Food Systems. IFPRI Discussion Paper 01801. International Food Policy Research Institute
- Smith PT (2007) Aquaculture in Papua New Guinea: status of freshwater fish farming, Australian Centre for International Agricultural Research (ACIAR)
- Toneba P (1980) Carp breeding and distribution. *Harvest* (6)3:145–148
- Tong S (2018) A sustainable livelihoods framework-based assessment of the social and economic benefits of fish farming in East New Britain province. Unpublished Masters Thesis, Faculty of Science, the University of New South Wales
- UNICEF (2013) Improving Child Nutrition: the achievable imperative for global progress
- Vira H (2015) An analysis of the aquaculture sector in Eastern Highlands Province, Papua New Guinea. Unpublished Master of Philosophy Thesis, Faculty of Science, University of New South Wales.
- Wani J (2004) The status of aquaculture development in Papua New Guinea: an information paper. National Fisheries Authority, Port Moresby
- Wani J, Solato W, Sammut J (2012) Farming fish for change. ACIAR Partners Magazine: <http://aciarc.gov.au/publication/pmg042>
- World Health Organization (2020) The impact of chronic disease in Papua New Guinea: facing the facts. https://www.who.int/chp/chronic_disease_report/papua.pdf?ua=1

The opinions expressed in this chapter are those of the author(s) and do not necessarily reflect the views of the UNESCO: United Nations Educational, Scientific and Cultural Organization, its Board of Directors, or the countries they represent.

Open Access This chapter is licensed under the terms of the Creative Commons Attribution-ShareAlike 3.0 IGO License (<https://creativecommons.org/licenses/by-sa/3.0/igo/>), which permits use, sharing, adaptation, distribution, and reproduction in any medium or format, as long as you give appropriate credit to the UNESCO: United Nations Educational, Scientific and Cultural Organization, provide a link to the Creative Commons licence and indicate if changes were made. If you remix, transform, or build upon this book or a part thereof, you must distribute your contributions under the same licence as the original.

The use of the UNESCO: United Nations Educational, Scientific and Cultural Organization's name, and the use of the UNESCO: United Nations Educational, Scientific and Cultural Organization's logo, shall be subject to a separate written licence agreement between the UNESCO: United Nations Educational, Scientific and Cultural Organization and the user and is not authorized as part of this CC-IGO licence. Note that the link provided above includes additional terms and conditions of the licence.

The images or other third party material in this chapter are included in the chapter's Creative Commons licence, unless indicated otherwise in a credit line to the material. If material is not included in the chapter's Creative Commons licence and your intended use is not permitted by statutory regulation or exceeds the permitted use, you will need to obtain permission directly from the copyright holder.

