



PR

6003

E47 G32

v.2

CORNELL  
UNIVERSITY  
LIBRARY



GIFT OF

Nixon    Griffis





## Cornell University Library

The original of this book is in  
the Cornell University Library.

There are no known copyright restrictions in  
the United States on the use of the text.

A GENERAL SKETCH OF THE  
EUROPEAN WAR





A  
GENERAL SKETCH  
OF THE  
EUROPEAN WAR

BY  
HILAIRE BELLOC

  
THE SECOND PHASE

THOMAS NELSON AND SONS, LTD.  
LONDON, EDINBURGH, PARIS, AND NEW YORK

*First Published July 1916.*

**900076**



# CONTENTS.

---

INTRODUCTION . . . . .	7
------------------------	---

## THE BATTLE OF THE MARNE.

### PART I.

THE BATTLE GENERALLY CONSIDERED . . . . .	23
(1) THE NUMBERS . . . . .	26
(2) THE GENERAL SHAPE OF THE GERMAN LINE BEFORE THE BATTLE, AND THE EFFECT OF THAT SHAPE . . . . .	44
(3) THE BATTLE OF THE MARNE WAS "AN ACTION OF DISLOCATION." WHAT IS "AN ACTION OF DIS- LOCATION"? . . . . .	67
(4) THE ELEMENTS OF THE BATTLE . . . . .	83
Criticism of this Theory . . . . .	100

## THE BATTLE OF THE MARNE.

### PART II.

THE DETAILS OF THE BATTLE . . . . .	111
(1) THE BATTLE OF THE "GRAND COURONNÉ". . . . .	120
(2) THE BATTLE OF THE OURCQ AND OF THE TWO MORINS . . . . .	157
The Real Composition of the French 6th Army . . . . .	178

## CONTENTS.

(3) THE BATTLE OF LA FÈRE CHAMPE-	
NOISE . . . . .	204
The Gap . . . . .	222
The Action . . . . .	227
(4) THE REST OF THE LINE . . . . .	251
The Rôle of the Left Centre:	
The 5th Army . . . . .	255
The Rôle of the Right Centre:	
The 4th Army . . . . .	270
(5) THE STATIONARY RIGHT WING . . . . .	283
The Rôle of the Third Army	
under Sarrail . . . . .	283

## THE AISNE AND AFTER.

THE AISNE . . . . .	303
Summary of the Sequel to the	
Marne . . . . .	361
CONCLUSION . . . . .	394

## INTRODUCTION.

**I**N “The First Phase” of the great war—the opening volume of this series—was described the general historical position when the shock came between the Germanic groups of Central Europe and the older civilization of the South and West, supported by the Slavs of the East.

The military portion of that book was concerned with the story of the initial Germanic success. It was pointed out how, together with the numerical superiority, the enemy enjoyed other advantages: first, that he had carefully prepared war for his own date, secretly, and over a period of three years; secondly, that his guesses at the probable nature of modern warfare, when it should take place upon a large scale, were more often right than wrong. With such advantages his victory should have been assured.

## 8 A GENERAL SKETCH OF

It was further pointed out that of its very nature this victory must be an immediate, brief, decisive thing. Delay, a check (improbable or impossible as that check seemed to be) would mar his chances of victory, because both of his forms of superiority would be affected by it.

His numbers, though at the origin of the campaign so immensely superior, were limited to a certain fixed maximum—that of his mobilizable efficient male population. This, at the rate of wastage he later established upon highly extended fronts, must necessarily decline in the field after eighteen months of war at the longest, and perhaps earlier. Among his opponents such limitation applied only to the French Republic. Great Britain and Russia entered the war with armies (including reserves) far below the total of their mobilizable population. They would therefore have between them recruiting fields far larger than those of France, Germany, and Austria in the later stages of the war, if time could be given for their equipment.

His better guesswork as to the nature

of modern war was again an advantage heavily in his favour at the outset of a campaign, but one which, during the course of a campaign, he would gradually lose. And that for two reasons: First, that his foemen would learn in practice which theories were right and which wrong, and would in time be able to supplement such branches of their armament as bad theory had rendered insufficient. Secondly, because, in the course of a campaign, novel discoveries would arise and novel situations, which would leave him as much in the dark as his opponent, and for the meeting of which both would stand level.

I say, then, that a check to his plan for an immediate and decisive victory would, upon the material side of his effort, be a serious thing for the enemy. Such a check seemed not credible in view of his immense initial advantages; but if by some miracle it should take place, it would have, on the material side, the character I have described.

Now it is well worthy of note—though a more difficult point to grasp—that such

a check, should it take place, would have an even greater effect upon the moral side. The point is somewhat subtle, but none the less important for that, since psychological facts such as this one are of the utmost effect in war. I would, therefore, beg the reader to follow it narrowly.

The enemy, when he suddenly forced war on France and Russia, proposed to do something enormous. He was undertaking a task which in magnitude was comparable to the task of the armed revolution of one hundred years ago in France, or of the Mohammedan conquest of twelve hundred years ago in Africa and Spain. He believed—and had good grounds for this belief—that on the material side his success was certain.

But such vast efforts in the past have always, where they have been successful, appealed to something in the soul of those attacked. Prussia, the leader of the Germanies, had no such platform. In undertaking a task of such dimensions the Prussian could not pretend to bring to the nations at war anything that other men could possibly desire.

He preached no religion conversion to which would reverse the mind of the foe from opposition to alliance. He brought with him no type of culture which any one foreign to him recognized as superior. No political creed, such as the social equality and simplicity in religion which were the fruits of Islam, or the democracy promised by the French armies of the Revolution, would flourish with a Prussian victory over Europe. He could promise no fruit to the conquered proceeding from the conqueror's genius. The victory Prussia designed for herself was a victory purely mechanical.

Therefore—and here is the kernel of the matter—Prussia, in attacking the nations she proposed to conquer, was threatening them with something which was for them mere disaster. She proposed to Great Britain loss of security, to France loss of all self-respect and a future of unbroken shame and increasing weakness, to Russia something of the same sort in a lesser degree, and the final subjugation of all the smaller Slav states as well.

As against these purely negative results

abroad Prussia had promised *herself* increased wealth and what the muddled German conception seems to have regarded as increased "face" or "name" at home.

This last point is very difficult to analyze, for the Germans themselves, under the leadership of Prussia (which has never produced a great thinker), were not quite certain what they wanted apart from an increase of material wealth. They saw Great Britain possessed, somewhat loosely, of tropical dependencies; France enjoying African colonies and an immense historical prestige; Russia, in the past at least, and still in some degree to-day, enjoying the power of suggestion over the lesser Slav states of the Near East. To obtain these fruits of national *character* without the corresponding national soul, and merely by victory in war, seems to have been the second part of the Prussian scheme in conquest. But at any rate the whole of the Prussian plan of conquest was marked by this sharp contrast between it and every other similar great effort in our history: *that while the Prussian scheme promised a*



*mechanical advantage of sorts to the victor, it promised nothing whatsoever to the vanquished.*

One might put the whole matter into a short metaphor, and say that Prussia was in the position of a man who sets out to burn down his neighbour's house, partly because he envies its antiquity and fame, partly because it inconveniences his approach to a neighbouring town, and partly because he hopes, when it is burnt down, to find a certain amount of valuable material in the ruins: but with no power to rebuild.

Now when the issue of any quarrel is as simple as this, it is quite clear that the psychological effect of time is increasingly against the aggressor.

The whole thing is so brutally stupid that if it is effected suddenly, it has something of the character of a natural cataclysm. The victim is stunned by the blow, and its full effect is already achieved before that victim has summoned to his aid a realization of its enormous issues.

Determination is in the mass of men a character of slow growth, and if some

overwhelming disaster catches a man before his will has had time to turn and fix itself against the approaching danger, his mind almost instinctively takes the misfortune in that same stoical but unproductive mood with which mankind is compelled to accept all inevitable suffering. He takes it as we take the death of friends or the loss of fortune in old age. Against such strokes mankind does indeed, and sometimes rightly, remedy itself by distant visions of compensation. It invokes the mystical conception of an ultimate divine justice which cannot fail (but through ways never perceived, and in a lapse of time indefinite) to restore all things. But for immediate action in war that mood of resignation is valueless. It has bred great verse ; it has bred noble, if false, religions ; it has never bred victory in the field.

I say, then, that if the Prussian effort had at once succeeded (as it was designed in detail to succeed, and as it seemed certain to succeed) by an immediate and decisive blow, the results of that Germanic victory would have been reaped almost in full.

To compare great things with small, we may illuminate this vast adventure of 1914 by a consideration of 1870.

In that campaign Prussia had achieved all her desire in precisely this sudden and decisive way.

War was forced by a forgery of Bismarck's very comparable to the Prussian diplomacy in July 1914. It was forced on just after the harvest, and also when Prussia was at her maximum of preparedness. Within three weeks the shock of the armies had taken place to the advantage of Prussia. Within six weeks all the regular armies of the French were either in captivity or besieged, and the thing was done. It was a spring. For Prussia knew that she could only win by surprise.

We know the result in the particular case of the French people. Their whole national life was thrown into disarray after the defeat. A profoundly unpopular and grossly unnational parliamentary oligarchy arose from the ruins. French letters, the intense and constant religious speculation of the French, French art, French everything, reflected something not very differ-

ent from despair. There did, indeed, remain a sufficient basis for some reconstruction and for the distant hope of revenge. But our own generation will bear witness, or those of it that tell the truth, to the fact that the opportunities for such action were not seized. The French saw growing beside them a Prussia increasingly strong, and yet they did not move. At the end of the process, by the time the men who had seen 1870 were grown old, great areas of the national will in France had abandoned the fruitful vision of a re-creative war.

I say, then, that had the Prussian Staff in 1914—possessing with its present allies, dependents, material, and recruitment a power tenfold that which struck in 1870—had that command, I say, effected its purpose with as much suddenness as did the Prussian Staff of that day, then the modern opponents of this vast, swollen menace—the French, the British, the Russian—would have suffered more even than the paralysis the French suffered through 1870. More—because they would have been left without the possibility of further alliance with great neutral powers for the

restoration of their self-confidence and of their national souls.

All Christendom was involved, and the issue was, one way or the other, life or death for its most ancient traditions of culture. If the Prussian blow got home it was *death*.

But let the blow be parried, even though the strength for delivering it again should remain almost unimpaired for many months, and see what follows as a consequence in this spiritual field. The mere brutal effort has failed. The mind of the victim has had time to grasp—though with some it would come very slowly—the nature of the peril. The vision of the immediate consequences of defeat grows clearer and greater too. Those whom Prussia had proposed to destroy perceive under what necessity they are to save themselves. Those efforts which upon the enemy's side were the product of mere calculation begin to spring in his intended victims from instinct and from organic necessity. The determination to resist, and, as a necessary corollary to resistance, to *destroy* a mere murderer grows with every passing week of successful defence.

At last the initial failure of Prussia, her stumbling on the threshold, will breed—has bred—in those whom she has failed to overwhelm a moral basis for action so broad that all the physical effort based upon it is well founded, to whatever height it may reach.

There must come in the process of this defence at last (if it be sufficiently maintained) a situation in which every material advantage the enemy enjoyed at the outset will be gradually whittled down to par. The numbers on either side, in men as in munitionment, will tend to grow more equal. Superiority in these will at last pass to those who had at first suffered aggression. The mere fact of prolongation will turn the war more and more against those for whom victory and rapidity of action were synonymous. Meanwhile, that base temperament which relies entirely upon calculable things, and which is so exaggerated in the Prussian, will, under the effect of disappointment, turn to inhuman experiments. Poison will be used, terrorism over occupied territory, indiscriminate murder of civilians and even neutrals by the submarine. These

outrages will, in their turn, breed a stronger and a stronger determination upon the part of the opponent never to allow such inhuman powers an indefinite lease of life. At last, when a certain crisis has been passed, when the worst atrocities—however futile in a military sense—have been committed, and when, conversely, the destruction of their perpetrators is no longer in doubt, the whole mind of those who were to have been the victims of aggression is simply taken up with a task of execution; and the aggressive power is, before history, in the posture of a criminal awaiting the scaffold. Nothing can save him.

Such must be the consequence to the assassin who stumbles as he strikes his blow.

All this, then, must follow from the parrying of the first and only deadly stroke—if, indeed, such parrying be possible. For at first it seemed impossible (save by a miracle) that such a stroke should be parried at all.

As we know, the stroke *was* parried,

the check *was* administered, the overwhelming superiority of the enemy *was* pinned for a sufficient time to permit the defensive to develop. This amazing act is, without doubt, that upon which posterity will chiefly fix when it considers the story of the great war.

A book such as this, written during the course of a campaign, and forming no more than a contemporary commentary upon it, is necessarily tentative in many of its judgments. It is incapable of reciting the story as a whole. It betrays on its every page the fact that it was written during the progress of an event whose issue was still unknown, and most of whose developments could only be guessed at. It is peculiarly liable to weakness when it attempts to estimate the varying weight of varying episodes.

Nevertheless, I think one can write it down in this spring of 1916 with a fair measure of confidence that human history as a whole will see one of its great turning-points in the **BATTLE OF THE MARNE**.

It is the Battle of the Marne which is



the main subject of these pages. Round it, and in connection with it, only can we read the corresponding events in the Eastern field of war and upon the sea. It is the Battle of the Marne more than anything else in this war which presents that strange atmosphere of fate never absent from the grave decisions of history—an atmosphere which has persuaded mankind to its belief in Providence, or confirmed it therein. Therefore we must remember, as we read the mere military details of the fashion in which this vast action was determined, that these are not all the story.

Seen from some great height, and as a whole, the thing had in it a quality not quite explicable from material causes alone. At its root, as we shall see, there lay a curiously complete military blunder upon the part of the Prussians, without which so strange a sight as the turning back of a great and perfectly organized army by forces hopelessly inferior would have been impossible. But this blunder, in its turn, is so difficult of explanation, its commission by men who, though stupid, are yet methodical, is so extraordinary, that in

reading it the mind is insensibly-haunted by the conception of a superior Will, within whose action those of the opposed combatants were but parts of a whole.

# THE BATTLE OF THE MARNE.

## PART I.

### THE BATTLE GENERALLY CONSIDERED.

**I** APPROACH now the main subject of this book—THE BATTLE OF THE MARNE.

I cannot attempt the task under the conditions which even the most superficial historian would desire and the most easily contented reader accept.

For even the very elements necessary for the most general historical statement upon this vast matter are still imperfect. That co-ordination of detail which is the soul of history is still impossible, on account of the almost complete absence as yet of all officially recorded detail whatsoever. The position of bodies of men 40,000 strong is still in doubt. The number of corps in each enemy army is

often doubtful. The time-table of the critical hours is still debated. A wise and even necessary policy of silence, in which the French are the leaders, still withholds from the student all the material wherewith the picture might be filled in, much of the material necessary to its very outline. After more than a year and a half's delay information is still absent. It will remain absent for a long time to come, and will be available only in successive and probably tardy instalments well after peace shall have been signed.

The text of this book, revised in the spring of 1916, finds me with no more material than I should have possessed some months before, although, in the hope of obtaining such, I delayed completion. The whole subject is still one upon which the most careful inquirer remains much where he stood in the first weeks after the great action.

Nevertheless I shall attempt the task with the extremely imperfect means at my disposal, and that for two reasons. First, because, in a current commentary upon war, if it is to appear at all, difficulties of this kind are inevitable, and

must be met as best they can. Secondly, because, although we still know less of the Battle of the Marne than of any subsequent phase in the war (although, for instance, we can describe it with far less justice and precision than Lemberg or Tannenberg), yet it is possible, by piecing together things on which there is direct evidence, and by admitting doubt freely where such doubt exists—but showing in what direction the existing evidence points—to give at least the *nature* of this great battle, to establish its decisive features, and in particular to fix the mind of the reader upon the natural divisions into which it fell. Thus, when fuller detail is available, the picture so presented will appear in the form of a fairly *exact* though exceedingly *imperfect* foundation for future study.

I am the more inclined to accept the task because I believe that this—perhaps the chief military event of Christian times in the West—is, even in the minds of those who follow the war closely, still hopelessly involved.

My chief business will be to resolve as best I can the chaos of contemporary im-

pressions, and to show, in however general a fashion, first (by the simplest diagrams) what was the general type of the battle; next, the "elements" of its decision, the three movements which combined to the whole result. Lastly, the details of the affair so far as we know them, and a picture of the battle as a whole, will conclude and amplify the description.

While we cannot yet set down all the tactical parts which would make even a sketch consistent, we can already grasp the nature of the action, and even separate and define its great phases, and the reader will see, when he has concluded this description, how the ill co-ordination of the left, the centre, and the right of that enormous line worked together for the breakdown of the whole Prussian plan of campaign.

## I.

### THE NUMBERS.

The first element to be decided in the examination of any action is the numbers of men engaged in it, and their distribution.

First, then, what were the total numbers present upon either side ?

What were the forces opposed one to another at the opening of the Battle of the Marne and during its progress ?

That question, which is of such fundamental importance to history, it is still impossible to answer with accuracy. What we can do is to answer it approximately, and within such margins of error as will roughly satisfy us upon the main matter of *proportion*.

But first let me say a word to explain why a complete and accurate answer to the main question is as yet impossible, and why a rough estimate within a certain margin of error can alone be given.

One of the principal objects of a command in war—perhaps the object of its chief permanent activity—is numerical calculation : the establishment of its own forces (which it only needs industry and accuracy to possess in minute detail every twenty-four hours), and—what is much more difficult—the strength of its opponent.

Now it is equally the main object of

that opponent to prevent his enemy from knowing not only where he stands, but in what strength he stands, total and local. Therefore a command has, in making its estimate of the enemy, to arrive at that estimate by a number of separate avenues of calculation, which check and confirm each other, but each of which is, by itself, tentative and uncertain.

These main avenues are five in number, and are as follows :—

I. The indications of corps actually in contact with one during an action, or seen by one's patrols just before action is joined.

This kind of evidence suffers from four drawbacks. First : (*a*) Because you may identify the regimental number without being able always to discover to which category the regiment in question belongs, or what place it has in the enemy's organization as a whole. Different services have different ways of numbering. There is a French Territorial category, for instance ; there is a German reserve category ; in the new English armies a perpetual addition of battalions all on the top of one another, all attached to one regiment, as



recruitment proceeds ; in the Austrian service those " Bataillons de Marche " which so grievously confuse all calculation, permitting, as they do, one unit to be, let us say, upon the Isonzo, and another, let us say, in Galicia, both wearing identically numbered uniforms.

(b) Because, when you have established the presence of a unit from such and such a division or corps, it by no means follows that the whole division or corps is present. There may be only a fraction.

(c) Because it is obvious that the units that you spot are only a minimum. There *may* be others in almost any amount. You are only certain of those you identify.

(d) Because there is continual mutation and redispotion of forces in an army. For instance, the Germans would have reported elements of the 4th Corps in front of Verdun on the 4th of September, and also in front of Paris on the 7th, but they could not tell by this evidence alone whether the 4th Corps as a whole had been moved, or whether it was being used in two fractions, or whether a portion had been moved. As a matter of fact the whole of it was moved.

II. The second category of evidence is that obtained from spies, the interrogation of prisoners, the capture of documents, etc., and in general from the secret side of the Intelligence Bureaus. Its various parts differ enormously in value, from the vague indications a peasant may give you, to the precise information conveyed by an official document obtained. This category also suffers from inevitable delay. Certain spies serving Germany, for instance, may have noted the French 4th Corps present in its entirety with Sarrail on the 3rd of September 1914, but the news may not have reached the German Command until after the Battle of the Marne had been lost and won.

III. The third avenue of information is the very obvious one of consulting the peace organization of your opponent's army. You infer, for instance, that if all the Saxons are grouped under General von Hausen, he will have such and such corps under him wherever he appears. But the accidents of war are such, and the perpetual redistribution of forces is such, that this kind of evidence is very doubtful. It does furnish an indication, but no

more than an indication. It may confirm your judgment drawn from other sources, but it does not give you a sufficient basis by itself.

IV. Your scouting, especially through the air, and the impressions gathered in the course of an action, will give you a check upon the matter of mere numbers.

For instance, your Air Service discovers a column marching along a certain road against, let us say, Vaux, in front of Verdun. It reports that this column is the equivalent of a division. When the attack on Verdun is delivered and repulsed you identify elements of the 15th Division in the fighting. You conclude that the whole of a division, and that division the 15th, was in action against you, not only from what your Air Service has told you, but from your estimate of the numbers attacking you when the shock came.

V. Lastly, you can, a long time after the battle (if your enemy publishes casualty lists, and if those lists are complete and accurate, especially if they give the time and date of each casualty), piece together, with infinite labour and great

chances of error, the composition of your enemy's forces upon any particular date upon a particular fighting front.

But this, again, is a method subject to manifold inaccuracies. Apart from the fact that the lists are probably not complete (we know in the case of the Germans that they are not), and apart from the fact that only the Germans and the English publish such lists at all, there is the enormous business of estimating through such an indication exactly what each unit was doing. You would find not a few examples, for instance (if you knew the whole truth), of units present in a short action which suffered no casualties at all ; and you are puzzled sometimes by a small group of casualties attaching to a unit in one place, although from other indications you had been nearly certain that the bulk of the unit was in another.

The upshot of all these methods combined is that you can arrive at a *minimum*, and *only* at a minimum, of the forces engaged against you.

The French have communicated to several writers upon the Battle of the

Marne a complete list of the forces engaged from the beginning to the end of the action upon *their* side, and most of the *indications* with regard to the enemy's forces. But as these writers have dealt with the battle from various aspects, and as none of them are infallibly accurate, there is a discrepancy here also. For instance, two divisions of the German XIth \* Corps—possibly three—seem to have been in full retreat upon Châlons at the end of the Battle of the Marne. But most of the descriptions of the German centre and of its shock against the French centre, from the 6th to the 10th September, make no mention of this XIth Corps, and we are still in doubt as to whether it ever made actual contact or not. Probably it was coming up from the rear, and was too late to join in anything but the retreat. But quite possibly it was present as a reserve, and, therefore, lending great weight to the central army which so nearly broke round and through Foch's right upon the critical day.

\* I shall throughout adopt, for the sake of clearness, Babin's method of distinguishing German units by Roman, French by Arabic, numerals.

## 34 A GENERAL SKETCH OF

I can only give here the most general estimate, giving a maximum for the French side and a minimum for the Germans, allowing full corrections due to mutations during the battle.

So far as we can gather there were present, including, of course, the large masses the Germans had collected against the eastern front beyond Verdun, where they erroneously believed the French to be in special force, a certain minimum of sixty-six divisions, with at least seven independent divisions of cavalry. But that is not allowing for the XIth Corps, nor allowing for the presence of a certain number of extra divisions, hardly less than half a dozen (third divisions attached to not a few of the German corps) taking part in the invasion.\* It does not allow, for instance, for the reserve troops which came in from the north towards the end of the Battle of the Ourcq, and which are not counted in this minimum. It only includes there the five corps which were actually present with Kluck, the IVth

\* Normally a French or German corps consists of two divisions. But in the invasion of France the Germans often had a third reserve division attached to a corps.

Reserve, north of Meaux, the three south of the Marne at the beginning of the action, and the corps of cavalry.\*

Neither does such a minimum allow for two divisions which we know were summoned to the eastern part of the field before the end of the battle, and which we shall see later appearing (too late) upon the Meuse behind Sarrail at its close.

We thus add certainly seven — more probably nine — divisions to that first minimum. It is possible that there were one or two more from Maubeuge after that place fell.

To call the German force as a whole, therefore, the equivalent of **seventy-five** divisions, apart from its independent cavalry, is not to exaggerate.

So much for the estimate of the German forces deployed for action during the Battle of the Marne from the Vosges to Meaux, and of the forces arriving during the battle. It is necessarily *less* than the total—perhaps much less. And the full number is not yet known.

\* For the various lists upon which this estimate is based, the reader who desires to follow the matter in detail may turn to the note at the end of this volume.

## 36 A GENERAL SKETCH OF

With the French numbers it is otherwise.

Upon that Allied side we have, of course, a much more accurate estimate. We know that, apart from some six or seven independent divisions of cavalry, the French divisions which took part in the action, or remained watching the eastern frontier during the action, from first to last amounted to **fifty-one**.

Roughly, therefore, so far as mere counting of units goes, we are quite safe and well within a wide margin of error, if we say that *the German effectives present upon the whole line stood to the Allied effectives which defeated them as less than **eight** but more than **seven** to **five***.

It is a matter of the greatest importance to seize this general proportion, if we are to understand what the battle will look like in history ; for never before did such superiority of force fully deployed, and enjoying similar or superior armament to its inferior enemy, suffer defeat from numbers so much smaller than its own. It is true that a very great factor in the result was the error of the enemy in



wasting great masses upon the East, and lacking them, therefore, at the decisive points west of Verdun, where the battle was won. In other words, upon the field where the fighting was active between Verdun and Paris, the forces were nearly equal, and the great disproportion arose in the field south and east of Verdun, where the Germans had kept men massed to no purpose. But whenever a superior force is defeated by an inferior force, it is due to an error of this kind, and the Germans paid the price of such an error.

We must further remember that the mere counting of units weights the scales against ourselves and in favour of the enemy. For the Allies had lost very much more heavily in the great retreat than had the Germans during their advance.

If we put the whole thing diagrammatically, so as to represent the disproportion of forces to the eye, it would look something like that upon the sketch overpage.

In this diagrammatic form we see the way in which the issue of the Marne depended upon the false grouping of the

## 38 A GENERAL SKETCH OF

Germans against the east of the whole line between B and C. The Battle of the Marne proper was fought on the curve between A and B, and it was because of the false grouping of the Germans between B and C that the opponents between A and B were so

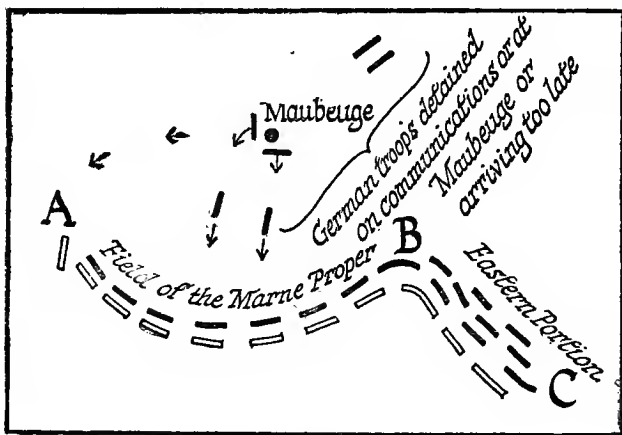

Sketch 1.

nearly equal, although the total German force was so much larger than the Allied force. We also see in this diagram, general and rough as it is, that element which is always present when a force by its strategic retreat before inferior numbers draws on its enemy and lengthens

his communications. That element is the weakening of the advancing opponent's front as its communications lengthen. He has to leave men behind to guard those communications in some degree. He has to use up increasing numbers of men moving up and down the communications as they lengthen. If his advance is rapid, he is bound to have a certain amount of stragglers and of bodies that do not quite come up in time, and if he has left a fortress behind him, he must further detach a certain number to contain that fortress.

All these elements were present after the strategic retreat of Joffre and the corresponding advance of the Germans when the moment came for the French counter-offensive. One had fragments of the German force not yet quite got into line because the advance had been so rapid ; one had at least two, and perhaps four divisions kept back until at least the second day of the battle, containing the besieged garrison in Maubeuge ; one had the men upon the lengthening communications right away up through Northern France and Belgium to the bases in Ger-

many, and one had the men who had to be left behind to keep down Belgium itself.

At this point there enters a most interesting discussion which was only fully developed at the opening of the Battle of Verdun in February 1916, and to which I would draw the reader's particular attention, because the problem has been so well put by one of the ablest continental students of the war, the neutral Swiss Colonel Feyler, whose name will be familiar, perhaps, to most of those now reading this page.

Colonel Feyler, in an article of the highest importance and value, has debated whether the Germans were not, after all, wrong in trying to turn the French position through Belgium instead of boldly attacking upon the fortified frontier of the east.

It is clear that *if* the Germans had, without too much delay, mastered the fortified French line between Verdun and Belfort, their efforts after that would have had very short and easy communications behind them. They might have mastered it by concentrating on the one fortress of

Verdun while it was still in its old state, a ring fortress defended only by limited, known, and permanent works. Once they had the northern end of the fortified line at their mercy, the Germans

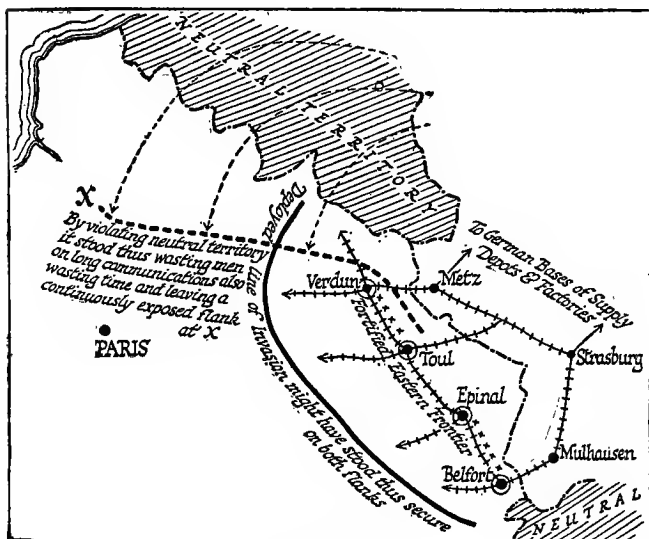

Sketch 2.

would have been able to turn the whole of it. Their progress would then have been uninterrupted, they would have had very rapid and immediate supply just behind them, and would have had to detach but a minimum of men for the

short communications through friendly territory in the rear of their advance. Their overwhelming numbers would have assured them continuous success in such an advance, and, above all, they would not have had the wasted effort, which has bled them right through the war, of keeping down the neutral population of Belgium, whose territory, in the plan they actually pursued, was wantonly violated.

Against this idea of a direct attack on Verdun at the beginning there was, of course, the French conception, which the war proved erroneous, that the permanent works of the ring fortresses upon the east would hold out for a lengthy period of time.

But the enemy had guessed rightly in this matter. He had judged that his siege train would be the master of any restricted permanent works in a few days, and we know as a fact that not only the Belgian forts went down at once, not only those of Maubeuge, but that Camp des Romains fell after a three days' bombardment; that Troyon, though not taken, was silenced in five, and only just

relieved in time, and that the same was true of Liouville. If, therefore, the Germans had struck the whole line of these permanent works or any part of it, but particularly its northern end at Verdun, with their siege train at the very opening of a war, they could have counted upon a similar success. The French would not have had time to learn the lesson of pushing field fortifications out beyond the old rings, and taking the heavy guns away from the permanent forts, and putting them under mobile conditions into these exterior field works. Verdun would have fallen, the eastern wall would have been turned, and the gate of a direct advance opened—an advance with no unprotected flank.

Obviously another consideration affecting the Germans was the fact that the eastern frontier gave but a short line upon which to deploy their great forces. This is true; but, seeing the masses in which they attacked, and the immediate success that should have attended them, it would surely have been possible to strike with at any rate the main part of their army of invasion at the

barrier, and, once it was broken down, to have extended their line up northwards. It is the opinion of the eminent military authority I have quoted that if they had acted thus they might have won the war.

## II.

### THE GENERAL SHAPE OF THE GERMAN LINE BEFORE THE BATTLE, AND THE EFFECT OF THAT SHAPE.

Let us return to the fundamental statement of all. German armies of invasion, outnumbering the whole of their opponents much as 15 outnumbers 10, had reached, in the first days of September 1914 (say by the 2nd or 3rd of that month), a position sinuous in outline, the fronts of which were in shape that of a flattish sickle with a long handle, and in direct extent, from extreme to extreme,\* rather more than two hundred miles.

How had they reached that shape? What was their object in marching to that formation? How far had they failed to reach the situation they had ex-

\* From Senlis, north of Paris, to St. Dié, in the Vosges.



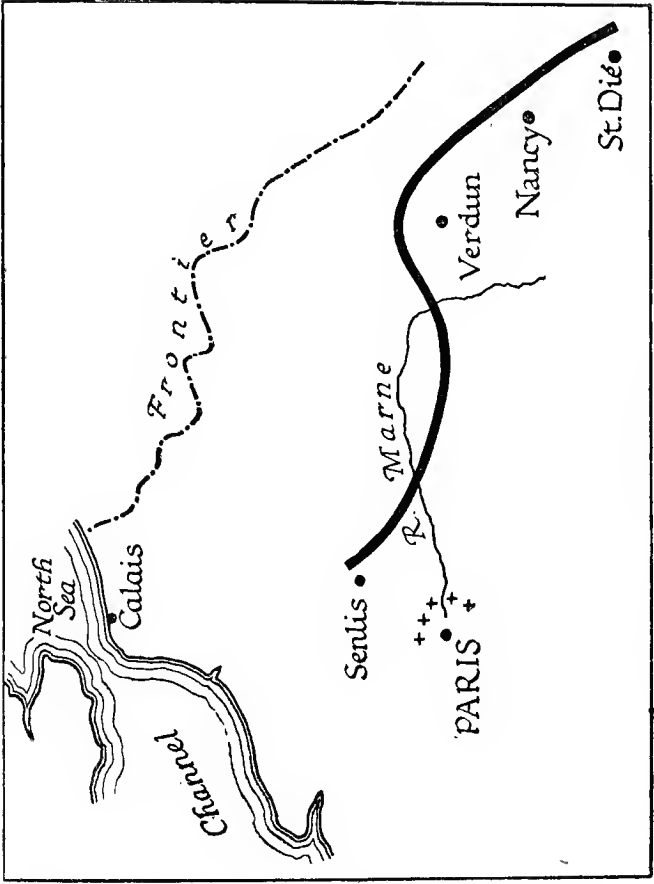

Sketch 3.

pected? *How, once in this sickle shape, were they balked entirely of their goal, thrust back, and pinned?*

It is with the answers to these questions, and especially the last, that I am here concerned.

First, then, how had the enemy reached that "sickle shape" in his line which we shall find to be the point of departure whence all his defeat proceeded? And what was his intention in marching to that formation?

In order to answer this question we have only to put upon the map the various stages of his advance.

When the invasion began, when the first contact was established between the French Army and the German (which was the beginning of serious warfare), the German armies from Alsace to Mons (and beyond), in Belgium, stood as do the black dashes in Fig. 4. The French Army (with its British contingent upon the extreme left) stood as do the dotted dashes upon the same. The German Army was to the French Army immediately before it—counting the British contingent—as about *two to one*. The total numbers

ultimately opposed when the great shock came were more like  $7\frac{1}{2}$  to 5. The difference was due to that strategy of "the open square" described in my first volume, whereby the French armies actually in touch with the enemy were supported at some distance by large reserves. These reserves—the "Mass of Manœuvre"—

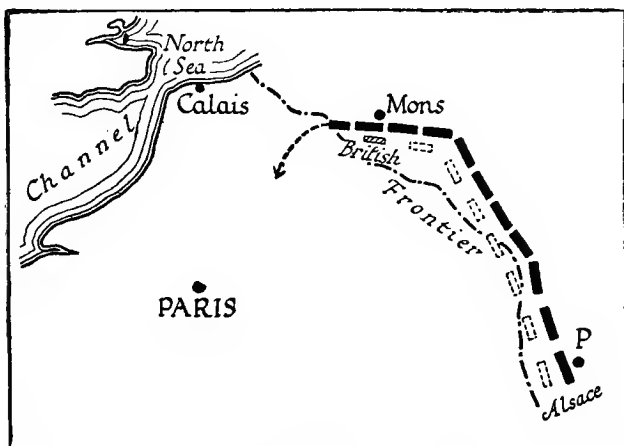

Sketch 4.

swung up on the eve of the Marne in a fashion shortly to be described, and changed the proportion from a bare half to nearly five-eighths of the enemy. Five-eighths is an inferiority sufficiently disquieting. But it won.

## 48 A GENERAL SKETCH OF

Note upon this Fig. 4 the position of the town of Paris.

It is a cardinal principle, not only in war but in every form of struggle, that you must not only make your plan (if you have the initiative in your hands, and are sure of some superiority over the enemy), but that you must also be provided with *derived alternatives* to that plan.

You can never be sure that your enemy will be forced by your action to exactly the next move that you would choose. You must always have in your mind the formula: "If my opponent does not do this thing—the most obvious under the circumstances—but *that* thing (a less obvious course), or *that other*, then I must have ready ways of dealing with him in the second and third case as well as in the first." Examples of this plain rule of combat abound in every game, from chess to fencing, and from fencing to war.

Now the plan of the German General Staff contained such alternative sets of ideas.

The obvious thing when you immensely outnumber your enemy on a deployed line is to outflank—that is, to get round him—and coop him up, and so destroy him.

If the French Army, being so small compared to its opponent, kept well together, it seemed fated to be outflanked by its superior enemy, and the original German plan would be accomplished.

But there was an alternative possible. It might be that the French Army would be so affected by the political danger of losing Paris, with all that it meant to France, that it would as it retreated spread out more and more, so as to cover Paris, and try to save it. But the French Army by this action would necessarily become at last too thinly spread out to hold, and be at last somewhere dislocated. It might attempt in some bewildered way, inferior though it was in numbers, to save Paris at all costs. In that case it would spread out by the left until it was too thin, and till gaps would appear in its line. Then the Germans could use their immense numerical superiority to break through with a *certainty* of success.

Supposing the French were so far governed by purely military considerations—in other words, supposing the financiers and the politicians were so bound to obey

the soldiers—that Paris would be left to its fate rather than imperil the army in the field, then the German superiority in numbers could be used to curl round the left of the French Army between its extremity and Paris, and to envelop the whole.

The disposition of the invading German Army was well designed to hold both these alternatives in view, and it would be able to act upon either of them. For it was swinging round in the direction of the arrow upon Fig. 4, and more or less pivoting upon the point P at the other end of its line. Its rapidly marching largest force was directed along the arrow straight at Paris for ten days—a march calculated to produce the maximum of political effect. Should the French refuse to be moved by that threat, should they refuse to weaken their line, or to risk gaps in it for the sake of saving Paris, *then* (I am speaking only of the German point of view) the arrow could be curled round, leaving Paris for the moment, and involving the French Army as a whole. The German entry into Paris could wait until the German victory in the field was assured.

One may put the thing graphically in the following diagrams.

Either at the end of the movement the French, in their terror for Paris, and the confusion produced thereby, would spread out their inferior numbers westward to

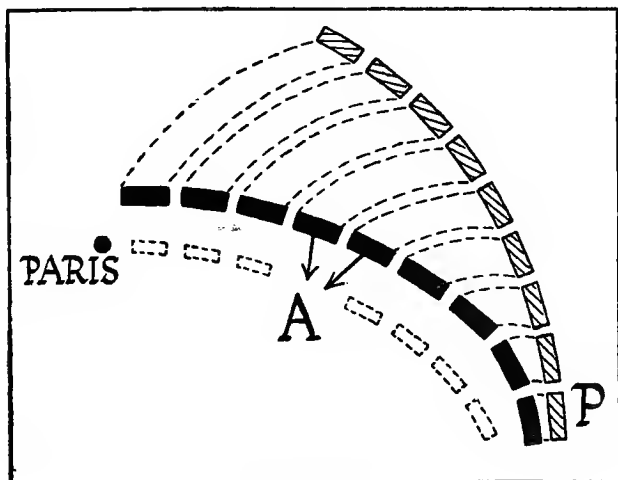

Sketch 5.

cover Paris, in which case a gap would certainly appear somewhere or other (as at A in Fig. 5); or they would have the strength of mind to keep their line full and intact to the end of the movement, leaving Paris to its fate.

In the first case the Germans would

## 52 A GENERAL SKETCH OF

break the French utterly at the gap A with their superior numbers. In the second case the extreme left of the superior German line would be free to curl round, as in Fig. 6, and begin the envelopment of the whole French Army. One or the other of these fates seemed certain, *unless* the French could in some way wear down

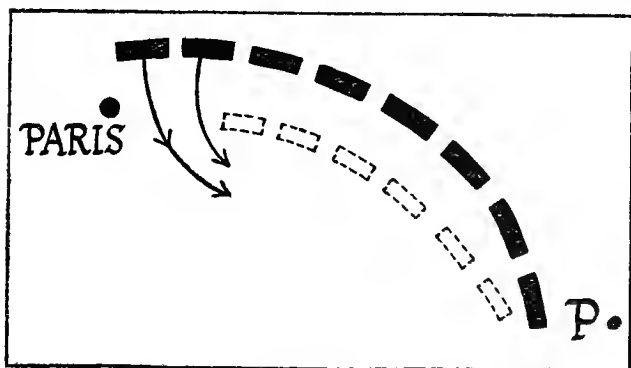

Sketch 6.

the enemy's numbers before suffering defeat, or in some way increase their own.

At this point the reader of the first volume in this series will naturally ask: Since the Germans knew very well that the French depended upon the theory of the "Mass of Manœuvre"—that is, upon keeping reserves well behind the line,



which should strike in when opportunity offered—was not the German General Staff aware that the forces retiring before them as the German Army advanced were but a *portion* of the whole French Army? Were they not naturally anxious for what the *other*, reserved portion, which had not yet come into play, might do? And would not they, therefore, first make quite certain of *where* that reserve portion was, how large it was, and in what fashion it was likely to strike, before they committed themselves to the last manœuvre of curling round the Allied line, supposing Paris to be thus neglected?

The answer to these obvious questions would seem to be that the German General Staff were, of course, familiar with the French strategic theories of the “Mass of Manœuvre,” but, as the event will show, that they made a triple error—all dependent on one original error. They began by greatly overestimating the actual numbers of the French who retreated before them from the Sambre. They thought the retirement of a vastly outnumbered fraction was the rout of the whole. Consequently (1) they had no

idea of the largeness of the reserve that might still come into play; (2) they could therefore not guess where it was, nor (3) how it would act.

This German error was highly characteristic.

You are deceived as to the strength of a force in front of you when you underestimate its fighting quality. If you think that such and such a power of resistance can only be put up by your enemy when he has 100 men, whereas as a fact your enemy is of a calibre to put up a fight of that kind with only 80 men, you are leaving out of account, and erroneously believing to be non-existent, a margin of 20 men, who may appear suddenly where you least expect them, and make all the difference to the result.

It would seem that this was the main type of miscalculation into which the Prussians fell.

They fell into many others in the course of the great decisive action we are about to study; but that prime error of misunderstanding the French temperament, the French military quality, and, consequently, the numbers they really had in

front of them—particularly, as we shall see, on the eastern end of the line—was the chief cause of their ruin. In all the course of the war, even up to the moment of writing, the German Higher Command has not got over this fault of misunderstanding the quality of its opponents.

It is satisfactory to note that the consequence here was a moral consequence following upon a German moral failing, and a French advantage in the same sphere. For it was the combination of Prussian mechanical calculation and French rapidity in judgment which produced between them the tremendous effect called the Battle of the Marne.

The first thing that developed in the sweep of the invasion was a sort of check or crook in the simple German plan of a clean sweep forward. This check or crook, which bent what was intended to be a plain curve into the sickle formation, took place upon the left centre of the German line in front of the right centre of the French line. Its capital feature was the defence of Nancy, an open town covered by an army in the field, and depending only upon rapidly made field works thrown

## 56 A GENERAL SKETCH OF

up in the open. Those works were mainly thrown up along the crest of hills lying to the east and north of Nancy, and called *Le Grand Couronné*.

But to this check there also powerfully

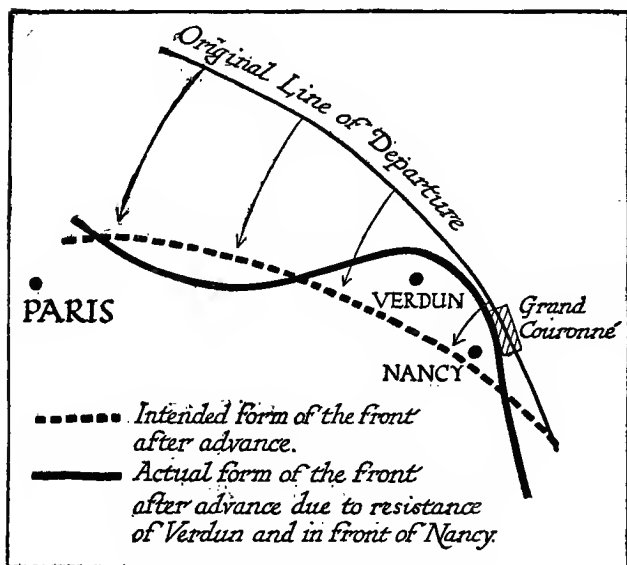

Sketch 7.

contributed the resistance of the new field works round Verdun.

The French had learnt the lesson of Namur and Liège with amazing rapidity.

Their whole theory of war had been

based for more than a generation upon the conception that a fortress defended by isolated permanent works could hold out for months against the modern siege train. That conception, sound before the development of aircraft, had by 1914 become wholly erroneous. Liège and Namur had proved that the modern siege train, its fire corrected by aerial observation, could get the better of restricted permanent works in a few days. The materials for writing a history of what happened at Verdun are not yet available, but the practical proof of what happened is evident to all. During the very few days between the fall of the Belgian fortresses and the appearance of the German troops before Verdun the heavy guns of the latter fortress had been moved out into temporary batteries, concealed far forward of the old circle of forts, and thus held up the Germans in front of them just as the troops in the open held up the Germans in front of Nancy.

We shall see later how this resistance before Verdun and Nancy deceived the enemy into believing that very much

## 58 A GENERAL SKETCH OF

larger forces were here opposed to them than was actually the case.

Meanwhile, farther west, the French forces and the British contingent on their extreme left fell back rapidly. The German armies, pushing forwards by order as fast as they possibly could, got into a convex position, stretching from the Ar-

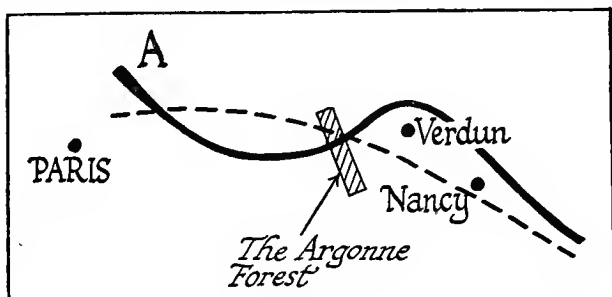

Sketch 8.

gonne to in front of Paris, and by the first days of September, what with the Germans ever pressing on as rapidly as possible when the French retreated, and getting awkwardly held up when the French stood, there had thus been produced that "sickle" formation to which I have alluded.

In the days 2nd to 5th September, the German armies stretched from Senlis to

the Argonne forest, the curve bending forward, and everywhere prepared to advance. But from the point where that line curled round Verdun on past Nancy and down to St. Dié and the Vosges they were held.

Now observe the result of such a for-

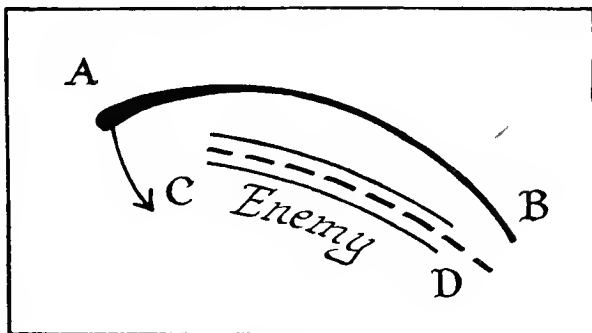

Sketch 9.

mation. The Germans had intended to stand in a great general sweep like that of the dotted line in Fig. 8. They were standing, as a fact, like that of the thick line in the shape of the sickle on the same sketch. The result was that their chief marching body, the extremity of their line which had the task of enveloping the French at A, had more work to do in proportion than it would have

## 60 A GENERAL SKETCH OF

had to do if everything had worked smoothly.

When you are enveloping your inferior enemy the ideal thing is, lie towards him in such a shape as the black line AB is to the dotted line CD in Fig. 9. Your free extreme marching wing at A curls round with the arrow and envelops.

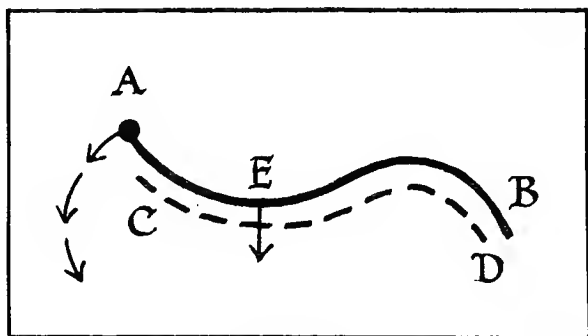

Sketch 10.

If from any cause your general sweep, AB, is distorted into such a shape as AEB in Fig. 10, your marching wing, A, is a good deal handicapped. Either the people at E must stand still while A comes round at a good expense of time, or, more probably, the formation will tempt the Higher Command to order the people at E to go forward and try to break



the inferior enemy in front of them. More probably still there will be a combination of the two. The people at A will be told to try to curl round, according to the original plan, in spite of the long distance they have to go. The people at E will be told to try their luck anyhow, and see whether they cannot break the enemy's line on their own account, while A is threatening his flank.

That was the first result of the sickle formation into which the Germans had been twisted against their will by the resistance of Nancy and Verdun: their extreme left was condemned to an excessive effort; their centre was tempted to a local and ill co-ordinated one.

There was a second result.

A general who has been trying to envelop will almost certainly conclude, if he has been badly held up at one point of his line, that *there* the largest forces of his enemy have been opposed to him. The Germans, having thus been held up on "the handle of the sickle" before Verdun and Nancy, were convinced that the greatest strength the French could put forward had been put forward in that

quarter. They exaggerated the French numbers in front of Nancy and Verdun. Consequently they believed that the forces towards the left of the French (the west that is, near Paris—the German right) were much weaker than was really the case. As a further consequence they concluded that both a direct attack by their own centre on the supposed weak French centre at the middle of the curve, *and* a sweeping round the extremity of the supposedly attenuated French line, were both easy matters, and could be undertaken simultaneously. Such would seem to be the answer to the first questions—how the Germans got into the “sickle formation,” and what they intended to do with it.

We are now in a position to answer the second question: how this attitude into which the German line had fallen just before the Battle of the Marne conduced to its defeat.

That question will be answered in much more detail in the later pages of this book. We are for the moment only concerned with the first elements—the bare outline.

The Germans, exaggerating the strength

of the French to the east, and underestimating the strength of the French to the west, and further believing that the French had not really been able to keep back a large reserve, or "Mass of Manœuvre," at all—believing that such resistance as they had met could only mean that the mass of the French Army was already engaged—undertook light-heartedly what would otherwise have been a very risky operation. They attempted to envelop the Allied line, confident that its extremity was weak, and that they could march round it *without peril of attack against their exposed extremity*. For they thought that the French had hardly any one left to bring up against that exposed extremity. They further thought they were strong enough at the same time to try to pierce the centre of the French line, or threaten to pierce it, while the outflanking movement was taking place.

One may put the whole thing very simply in the following two diagrams. The German Higher Command, finding its army in the sickle formation AEB, the handle of that sickle from E to B

## 64 A GENERAL SKETCH OF

having been forged by the French resistance, took it for granted that the Allied forces were in proportionate strength to various parts of the line, something like the unshaded area XY in Fig. 11, and that there was very little else threatening them. They also thought the extremity at X, where the British were, to be not

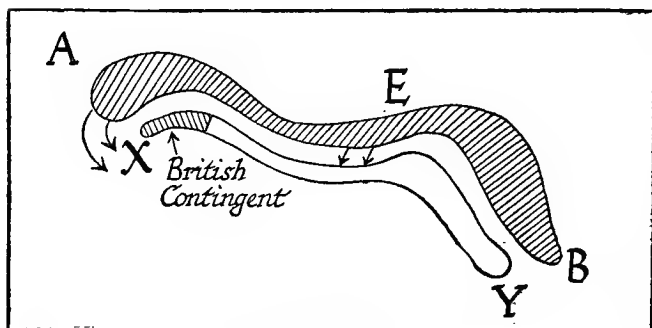

Sketch 11.

only thin but quite exhausted by the retreat. They therefore were quite prepared to swing round their big mass at A in the direction of the arrow, so as to encircle the Allied armies, and at the same time to move forward the great mass at E, with the object of threatening or piercing the centre.

As a matter of fact, the real disposition

was not what the Germans imagined. It was not like Fig. 11, with the French mass on the right, depleted French forces on the left, and no reserve.

It was, on the contrary, much more like Fig. 12, with a fairly even distribution all along the line, and also large reserve bodies, as at F and G.

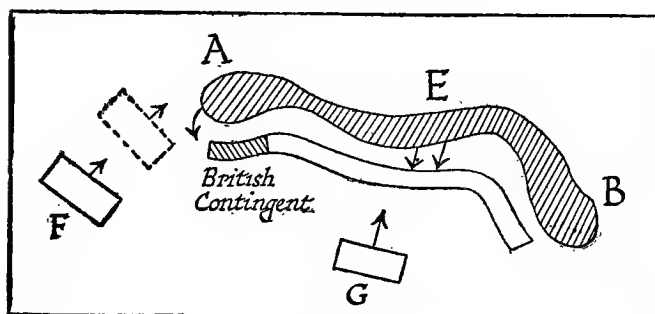

Sketch 12.

So when A began his turning movement, and E his piercing as well, A found himself badly threatened by the unexpected appearance of F on his flank, as well as by the unexpected elasticity of the British contingent in front of him. A, threatened with a local defeat, called up his men towards his right, bunching them up more and more against F to save defeat. This drew the whole German line

## 66 A GENERAL SKETCH OF

to the right, thinning it towards the centre at E ; E, at the centre, saw the line to his right getting perilously thin, tried to save the situation by striking hard in front of him, but lost his head in so unexpected a development, and left a bad gap, H, in his line. The situation at this moment was that of Fig. 13. The French took imme-

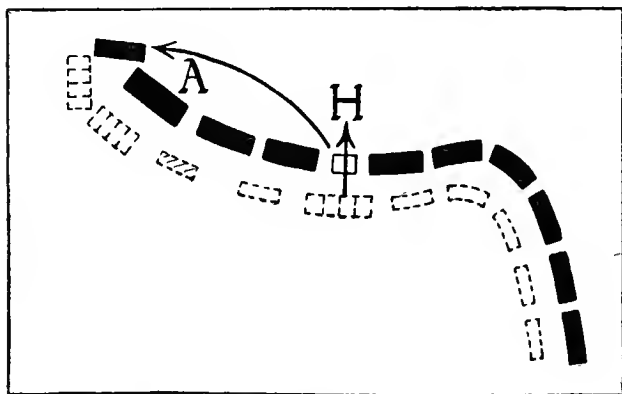

Sketch 13.

diately advantage of the gap which the Germans had thus opened at H, and broke into it.

The German line was "*dislocated*" by German blundering. The Allies beat the Germans by taking immediate advantage of this "*dislocation*" in the enemy's line. And the whole victory turns out, upon a

general examination, when its vast complexity has been analyzed and resolved, to be essentially an example of that rare type of action, a defeat suffered by a greatly superior force at the hands of a greatly inferior force, not through surprise nor through the sudden massing of men against a weak spot, but from a spontaneous dismemberment of the superior force, of which dismemberment the inferior force at once takes advantage.

The Battle of the Marne was, in one phrase, "*An Action of Dislocation.*"

This fundamental proposition I shall first define before proceeding to a closer examination of that tremendous event which—in what delay of time I cannot pretend to say—will prove to have determined all the future of the modern world.

### III.

THE BATTLE OF THE MARNE WAS "AN ACTION OF DISLOCATION." WHAT IS "AN ACTION OF DISLOCATION" ?

The Battle of the Marne, I say, was in type one of those general actions which

## 68 A GENERAL SKETCH OF

may be called "*A Defeat suffered from a Dislocation of the Line,*" or, more briefly, "*An Action of Dislocation.*"

Let me define and explain this term.

It is clear that, even where superior forces are face to face with inferior, the cohesion or continuity of the superior line—unless its numerical superiority be quite overwhelming—is essential to success.

I have here (Fig. 14) six Black units

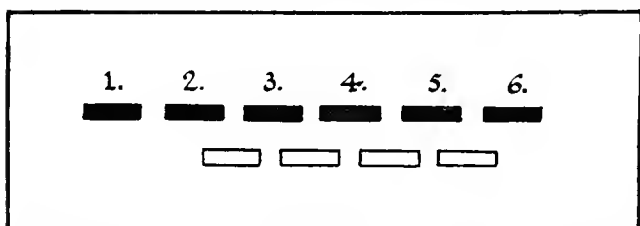

Sketch 14.

opposed to four White units. That is a marked superiority. But if by any accident, or folly, or misfortune, a large gap opens between two sections of my Black units, and if White takes immediate advantage of this, though I am superior in number, White will defeat me.

Suppose (as in Fig. 15) a broad gap is allowed to intervene between two halves of my six Black units, the left-hand



half and the right-hand half, and White takes immediate advantage of this by stepping into the gap, it is clear that he will have got upon the flank of unit No. 4 and unit No. 3, as well as holding them from in front; and we know that troops deployed for battle when thus struck in flank are doomed, if the stroke can be delivered with sufficient force. For upon an unprotected flank a line is vulnerable

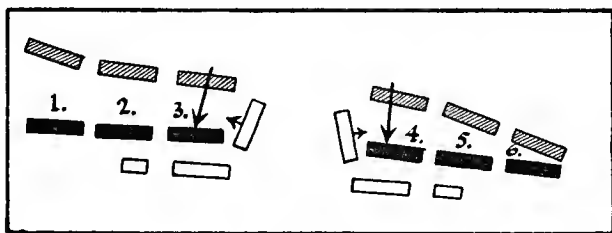

Sketch 15.

in the extreme. It is there "blind," weak in men, and with no organization for suddenly turning to fight at right angles to its original facing. White is further immediately threatening the communications of the Black units 3 and 4, represented by the arrows. Such a situation compels the Black units 3 and 4 to fall back at once to positions indicated by the shaded oblongs on Fig. 15. If they

did not so fall back they would be destroyed. But that leaves 5 and 2 similarly exposed, so they in their turn must fall back towards the shaded positions behind them. But this would leave 6 and 1 also exposed, so they also have to fall back.

In practice, of course, when such a gap opens, and advantage is taken of it by the enemy, the line thus imperilled does not wait to fall back gradually bit by bit, but receives the order to fall back at once and altogether. It has lost its offensive power. It is lucky if it can stop somewhere and stand on the defensive before suffering total defeat.

All this is elementary, and is summed up in the simple phrase that "The line which allows itself to be broken is defeated."

In the greater part of actions known to history, where victory has thus followed upon the breaking of a line, such a breach has been due to the deliberately offensive action of the enemy. The commander of the line which was ultimately broken knew perfectly well that his enemy wanted to break it, and, when it broke, it broke not through his ignorance so much as through

the superior weight of the blow which the enemy was able to deliver. In other words, the term "break" is, in most such actions, an accurate metaphor. A line was drawn up, and was intended to stand a shock. The shock was delivered; the line failed to stand, and was violently, and against its will, disjoined by the hammer stroke of its enemy. Blenheim is the classical example.

You have a line (Fig. 16), as AB,

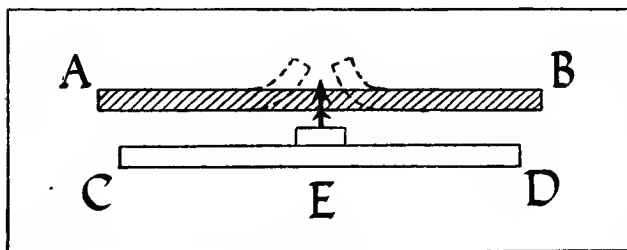

Sketch 16.

which intends to stand. You have another line, CD, at one central portion of which, E, a specially strong force is mustered—in the case of Marlborough at Blenheim, his cavalry towards the close of the action. This concentration strikes as hard as it can at the opposing point of the line, and if the line breaks under the blow AB is defeated.

Napoleon was trying nothing else against Wellington's line during all the afternoon hours of Sunday, June 18, 1815, on the field of Waterloo.

But that type of action to which the Marne belongs, and which I have called "The Action of Dislocation," though equally an example of the disruption of the line, is not, properly speaking, a "breach" of that line, but rather what I have called it, a "dislocation." The gap is not produced by the enemy's blow, but is created by some fault of the Higher Command *before* the enemy strikes and takes advantage of it. The line which is ultimately pierced originally stood intact, then was divided, and showed a hole somewhere in its trace on account of the mishandling of troops, and only *after* that, and *taking advantage* of that, did the enemy pour through the opening so formed to his advantage, but not by his own direct effort.

In other words, of those battles which are decided by the penetration of a line and not by envelopment, there are two categories.

In the *first* category, where the line may

be said to be broken, the three stages of the action are those in Fig. 17. (a) When both lines are intact and facing each other; (b) When both are intact, but one has concentrated for a blow upon a particular section of the other; and (c) The state of affairs when this blow has been delivered and has been successful.

The *second* kind of action, which I have called "The Action of Dislocation,"

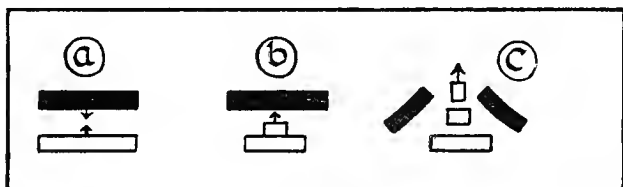

Sketch 17.

has also three stages, rather resembling those of Fig. 18: (a) Where the two lines are intact and facing one another; (b) Where the one line, through the fault of its own commanders, has suffered dislocation, and only *after* that; (c) The gap formed by the dislocation taken advantage of by the opponent, who, finding the way open for him, pours through.

It is clear from the above that what I have called "A Defeat through the Dis-

## 74 A GENERAL SKETCH OF

location of the Line " can only be produced by some very grave blunder upon the part of the defeated general.

The discovery upon the part of the victor that the gap has opened, and the rapidity of the decision which enables him to take immediate advantage of that situation, are, of course, equally necessary to the result. It is none the less true that the main cause of that result is not the positive action of the victor, but

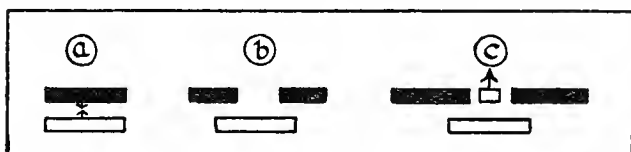

Sketch 18.

the negative action of the vanquished. It is upon *his* blunder that the affair really turns.

An immediate consequence of this truth is that a blunder so momentous, though arguing, of course, incompetence upon the part of those who commit it, will only appear under conditions of some complexity. The command which allows a gap to develop in its line apart from the pressure of the enemy is rightly con-

demned as inferior, and the German Higher Command, which lost the Battle of the Marne to an enemy about two-thirds of its own numbers, will always appear before history as singularly deficient upon that occasion.

None the less no command, not even one hide-bound by that mixture of short-sightedness and routine which its admirers call "efficiency and organization," would be guilty of so crass and obvious a fault as opening a gap in its line under no temptation, and without special unexpected happenings to bewilder it.

The gap only opens thus because the Higher Command loses its head, gets flurried, is unable to think rapidly in the presence of a new situation, calls troops hurriedly from one part of the field to another, and does not with sufficient promptitude rearrange its units.

A general who lets a gap thus develop in his line may be compared to the bad chess player who allows his queen to be taken early in the game. It is a gross mark of incompetence to allow it; but no one is so incompetent as to allow it deliberately. It only happened because

his attention was diverted to some other part of the board, and his mind could not grasp the whole situation.

To take an elementary example.

The Higher Command of Black in Fig. 19, awaiting the attack of White, wrongly imagines that White has been heavily reinforced upon his right at A. Almost simultaneously he accepts the wrong information of a second concentration upon

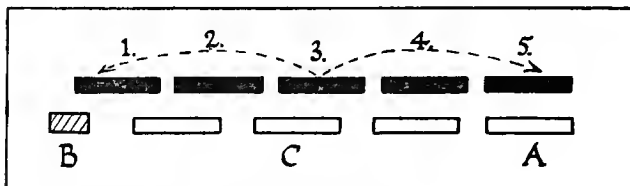

Sketch 19.

White's left at B. He hurriedly draws men right and left, as along the dotted lines, gradually depleting his central unit 3 as he reinforces 1 and 5. He has no intention of leaving a gap in his centre, but unless he spreads out 2 and 4, and coordinates their extension rapidly with the depletion of 3, he is in danger of finding himself in some such situation as that in Fig. 20, with his two wings reinforced at the expense of his centre, a gap for



the moment appearing in this centre, and unable to prevent White's unit C taking immediate advantage of the temporary dislocation and pouring through.

That is exactly what happened at the Battle of the Marne.

The German Higher Command first of all arrived at an exaggerated estimate of the French right wing in front of Nancy.

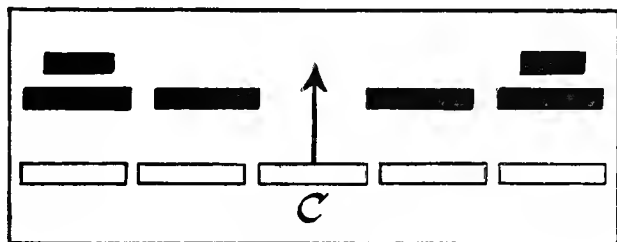

Sketch 20.

While still under this illusion, they were surprised by the actual appearance of unexpected new forces upon the French left wing in front of Paris. They began hurriedly and confusedly leaning their strength westward to reinforce the bodies at the right end of their line. They did not spread out with sufficient rapidity the remainder of their central bodies, nor hold them on the defensive as they grew perilously thin

at one point ; a gap appeared ; the French centre commander, Foch, took immediate advantage of that gap, and struck through.

It must further be noted that, as the very rare cases of a battle lost " through dislocation " always depend upon the confusion and bewilderment of the Higher Command, through some complexity in the situation which it has not the talent to grasp, therefore there is a peculiar likelihood of such a type of battle developing under conditions monstrous or novel, or both. There is also an added likelihood of their occurring when the mind of the defeated party is not quick in character, nor apt at grasping unexpected conditions. It is further true that a blunder of this kind is especially likely to be made by men underrating from an illusion of vanity the fighting power of their enemy.

All these three predisposing conditions were present in the Battle of the Marne.

(1.) The German body of officers as a whole, and even its Higher Command (who in early youth had belonged to a wiser and more sober Germany), was all at sea upon the French character in general and the character of the French

Army in particular. It had such a conviction (based upon printed matter, not upon the senses) that the French human material and social organization had rotted, and that the German forces were in all moral elements superior, that when the great retreat from the Sambre developed, the Germans vastly exaggerated the numbers actually present in front of them, and consequently underestimated the reserves that would appear for a counter-offensive. To this same fault of pride, which is often the mark of an inferior intelligence, one must ascribe their miscalculation of French strength at the points where the French Higher Command chose to stand and not to retreat. We shall see later of what capital importance this was in the matter of the extreme right under Castelnau.

(2.) The German mind—it is, perhaps, the most permanent characteristic of that historically unstable thing—works slowly. There is no disadvantage in this characteristic where prolonged and detailed work upon set lines has to be performed—rather the reverse. A slow mind suffers less from weariness and

from disgust than a quick. It will therefore often excel at long-laid plans, and especially at the co-ordination of details which can be worked out undisturbed. But it is obviously handicapped as against the quicker mind when a quite unexpected decision is thrust upon it, and problems unknown to its tedious calculations press for immediate solution. No mind is less agitated, but none is more confused (and, therefore, in a human struggle more at the mercy of a quick and lucid opponent) than the mind of the North German under conditions of unexpected accident.

Now the conditions of the Marne were conditions peculiarly trying to this temperament. An exceedingly detailed plan of action, worked out for years in its most minute elements, and thoroughly co-ordinated, the labour of a generation and more, was broken upon September 6, 1914. The huge tear which began to spread in that elaborate mechanical fabric had to be remedied somehow by a stroke of vision at very short notice. Already in forty-eight hours, by the 8th of September, things were doubtful. Before the

dawn of the 10th the whole scheme was in ruins.

(3.) But the last condition of the affair was the most important. I have said that the blunder of "dislocation" is more likely to occur in proportion as the problem of readjustment is novel and monstrous.

Now the conditions of the Marne were essentially both. You had to consider the regroupment of units not upon a field of a few hundred yards, but over 120 miles of country. As you were drawing your men towards the wings, your imperilled centre was informed not by its own eyes, nor even by sending off a dispatch rider a mile or two, but by a series of telephone messages which had to be clearly framed and as clearly understood, and which were the expression not of a council nor of one man, but of several commanders necessarily separated one from another by great spaces. Your readjustment of force was not the borrowing of a battalion or even a division from one part of the field, which you thought more secure, for another which you believed to be threatened. It was the regrouping of whole armies.

The Marne was in essence a battle of dislocation as truly as the smallest such example taking place in the pettiest of antique sword play between two village states. But the enormity of its scale changed, for the human agents, the very stuff of the thing. There was demanded of men a new grasp of things a hundred-fold more complex than their studies of the past could teach them, and it was upon this account, more, I think, than upon any other, that the great action became one of that rare type which, on a smaller scale, would have been due to crude blundering, but which, upon this scale, was a peril to be feared by any general, the "battle of dislocation."

It might even be tentatively proposed that great national actions of the future will show examples in this kind commonly; and that a defeat through "dislocation," a rarity in the past, will, under the vast complexity of modern conditions, become the chief anxiety of general officers in the future.

Having said so much on the most elementary and fundamental point in the diagrammatic aspect of the great battle,

let us turn next to a simple statement by further diagrams of its three determining phases. After this, and after the corresponding comprehension of the mould in which the thing was cast, we can conclude with the detailed narrative of it.

#### IV.

##### THE ELEMENTS OF THE BATTLE.

The Battle of the Marne is so extremely complex an action, one fought upon so vast a scale, and one the evidence on which is still so vague and scanty, that no grasp of it is possible unless one treats it step by step, beginning with the most elementary and general plans.

I have already in the IIIrd Part of this chapter characterized the general nature of the action as one of "dislocation," and attempted to define that phrase, and to render clear the nature of this somewhat rare type of battle.

I now proceed, before giving in any detail the story of the Marne, to establish what may be called in the study of any action its "elements."

## 84 A GENERAL SKETCH OF

The plan of any general action, its varying phases, and the final disposition of troops which led to its result, can always be expressed briefly in the form of diagrams. The idea underlying the moves on both sides is thus best rendered in its simplest form, and such an oversimplicity of description is necessary as a prelude if one is to go on to the comprehension of the fight in all its details.

The elements of the Battle of the Marne were as follows :—

The “sickle” formation of the German invading forces, which has already been described at some length, was composed of *seven* distinct groups, each called an army, and each consisting of several army corps, united under one “army commander.” Of these *seven* corps, *five* formed the blade of the sickle and the attachment of the blade to the handle ; the remaining *two* formed the handle itself. These armies were numbered from the German right to the German left in regular order—that is, from west to east ; in a diagrammatic expression of them, we have the succession apparent upon Sketch 21. The 1st Army is that on the



extreme right, the IInd next to it, then the IIIrd, IVth, Vth, in their order up to and curling round Verdun, and then the VIth and VIIth, which stood checked along the eastern frontier in front of Nancy and the Vosges. The commanders of these armies, with their numbers and

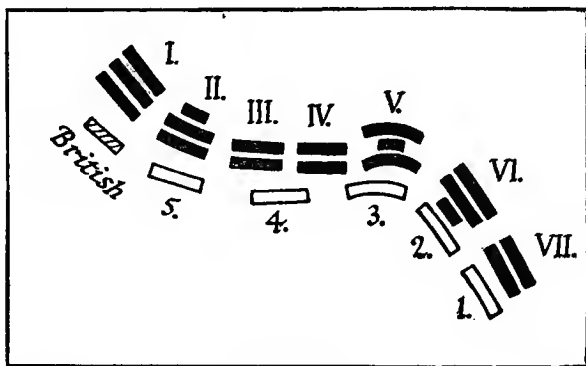

Sketch 21.

the nature of their troops, need only be given when we proceed to the full story of the battle.

In order to seize the elements of the action, it is sufficient to grasp this arrangement of seven armies forming the great sickle 200 miles long, as shown upon Sketch 21.

Such was the order and numeration of

the armies of invasion at the moment when that invasion had reached its extreme development just before the French counter-offensive of the 5th of September.

As against this line, note the Allied line, which is marked upon Sketch 21 in white, as opposed to the German black.

This Allied line I have roughly represented by white oblongs, save in the case of the British contingent, which I have shaded. Each of these oblongs stands for an army composed of several army corps: the British of three, the French of from three to four. It will be noted that the French system of numeration, like that of the Germans, goes up from right to left, and that the French armies, five in number, end with the 5th upon the extreme left or west, and go back by the 4th, 3rd, 2nd, and 1st to the eastern end of the line.

These five French armies, with the British contingent, represent the original force of which a portion (1 and 2) had stood against the shock of the German VIth and VIIth on the eastern frontier; while the remainder, the 3rd, 4th, and 5th, and

the British contingent, had fallen back during the great retreat from Belgium.

Those who are familiar with the thesis set forth in the first volume of this series, will remember that the strategic theory of the French—the plan upon which they hoped to meet, though with difficulty, the immense numerical superiority of their opponent—was “the open strategic square.”

Without repeating all the description of that plan, it is sufficient to recall here that it consists essentially in the dividing of one's forces into two parts. The first part takes contact with the enemy, and, if necessary, retreats before him. The second part, which is often called the “Mass of Manœuvre,” is kept back in reserve, and only called into play when, in the judgment of the general-in-chief, the retirement of the first part has gone on long enough, and has drawn the enemy into a position where there is a favourable opportunity for launching forward this reserved second part, and beginning the counter-offensive.

In the enumeration of the original French forces and the British contingent,

## 88 A GENERAL SKETCH OF

which had thus been in contact with the enemy from the first days of the war, we are dealing only with the first of these two portions. Its right had held the enemy upon the east, its left had retreated before him upon the west. In its entirety it had not numbered half the invasion which it proposed to stem.

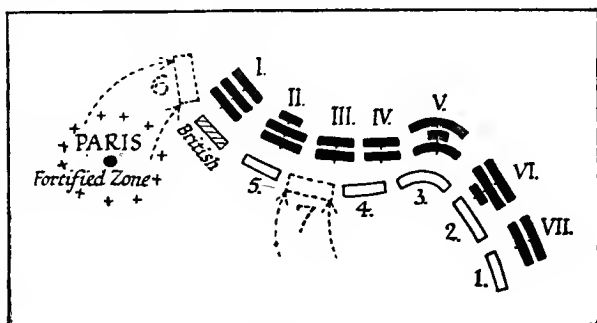

Sketch 22.

Where, meanwhile, was the “ Mass of Manœuvre ” ?

The “ Mass of Manœuvre ” was gathering in two separate groups, which we may now add to the elements of the battle, and which had been brought up into line exactly in time for that great counter-offensive of the French which was to begin upon the 5th or 6th of September.

I have marked these two groups of the "Mass of Manœuvre" by two dotted oblongs on Sketch 22, numbered in dotted figures respectively 6 and 7. The 6th Army was formed in, and proceeded from, the fortified zone of Paris, together with troops rapidly swung round by train from the east during the battle, on the extreme left beyond the British contingent. The 7th Army\* was formed behind the centre of the main line, and brought up into that centre between the 5th and the 4th.

The French line, therefore, just before the great counter-offensive was undertaken, consisted of eight elements, the irregularity of whose enumeration was due to the fact that they consisted of two portions: an original portion regularly numbered; a new additional portion, the "Mass of Manœuvre," which had swung up to fall into line just before the blow should be delivered. And these elements, from left to right—that is, from west to east—were the 6th French Army,

\* Also called the 9th. This confusion of titles will be discussed later. See the long note at the end of this part.

the British contingent, the 5th French Army, the 7th (or 9th), the 4th, the 3rd, the 2nd, and 1st. In this final form the Allied forces were no longer less than half their opponents; they counted between five-sevenths and five-eighths of their opponents.

The numerical odds, therefore, were still enormously against them, but the essence of using a "Mass of Manœuvre" is that you hope with it to be able to effect a surprise. If your enemy misjudges your numbers, though you are weaker than him, that surprise may be his undoing.

With these preliminaries, which establish the positions just before the great struggle began, we can proceed to those main changes in the course of that struggle which between them decided its result.

First, let it be clearly grasped that the German commanders were in a great measure ignorant both of the *strength* and of the *position* of these "Masses of Manœuvre" that had swung up. Indeed, had there not been this element of surprise in the Allied action, there could

have been no chance of the Allied success, considering the numerical superiority of the enemy.

The enemy, as we have already seen, misjudged the density of the Allied line. He thought—on account of the way he had been stopped before Nancy—that the bulk of the French troops was bunched up in the 1st and 2nd French Armies in the east; as a fact, the French line was nearly evenly distributed.

Next, he misjudged its total strength. He thought the forces which had retired before him were larger than they really were. He knew, indeed, that the French originally meant to use a "Mass of Manœuvre," but he thought that they had already used a great part of it, or perhaps all, in the desperation of a retreat which he, the enemy, thought to have nothing calculated about it, but to be something like a rout.

Lastly, he miscalculated the moral condition of the troops opposed to him at the end of this retreat, and particularly the remaining vigour of the French 5th Army and the British contingent, which had suffered more severely in casualties

than the rest, and also in fatigue ; for, being at the end of the line, they had had to march greater distances to avoid envelopment.

The result of these three miscalculations was that when the French " Masses of Manœuvre " swung up, although portions of them (especially of the 6th Army) had given the enemy evidence of their existence before, he had no idea of the *size* of the new bodies that were just going to surprise him. The enemy's first false move was directly connected with this miscalculation.

The Ist German Army—that on the extreme German right or west—acting as though it had nothing in front of it save the weary British contingent and the badly fatigued and mauled French 5th Army, both of which had just gone through the terrible ordeal of the retreat, proceeded to attempt the envelopment of the whole Allied line.

This Ist German Army had been facing, after the fashion we have seen in the last two sketches, south-west. It proceeded upon the 3rd, 4th, and 5th of September to swing round after the fash-



ion of the dotted arrows upon Sketch 23. In doing this it would have to march right along the front of the British contingent; but it thought that small force too exhausted to endanger it even in so perilous a manœuvre. It ignored the gathering, right on its flank, of the French 6th Army.

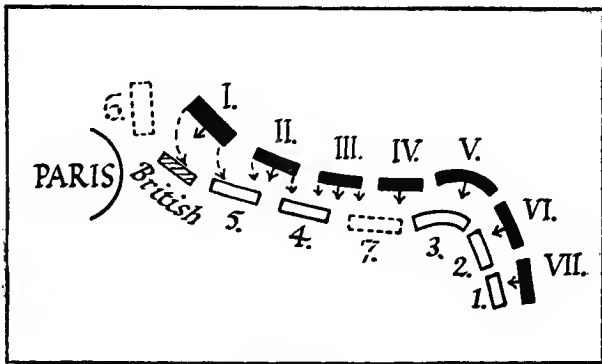

Sketch 23.

When the Ist German Army should have completed this turning march, and, from facing south-west, should be facing south-east and threatening the whole flank of the French line, all the rest of the German line was to strike together. The VIth and VIIth German Armies were to push back the 1st and 2nd French

## 94 A GENERAL SKETCH OF

Armies; the II<sup>nd</sup>, III<sup>rd</sup>, and IV<sup>th</sup> were to attack the French troops in front of them, and prevent their lending aid to the wings. In this way, with the great superiority of German numbers, the battle should in two or three days have developed into some such shape as that upon Sketch 24: the French line already

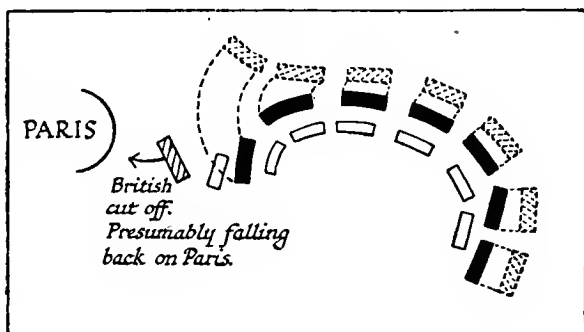

Sketch 24.

bent back by its superior enemies, and obviously doomed to envelopment, and therefore to destruction.

What happened, in point of fact, was very different from this. By the time the German I<sup>st</sup> Army had curled well round and was just about to strike between the British and the French 5<sup>th</sup> Army, the French 6<sup>th</sup> Army appeared upon its flank.

The position of the Germans now, and particularly of their extreme marching right wing, the Ist Army, was that of Sketch 25.

To the British contingent and the 5th French Army was disclosed the addition of the 6th French Army, and in this opening phase of the battle it was obvious

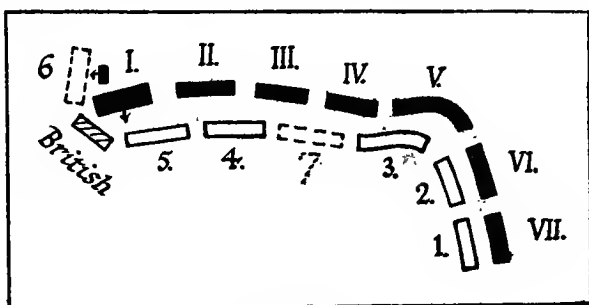

Sketch 25.

that the first German army (I.) was in peril of being caught in flank and destroyed. It had a small flank guard on the spot—one corps (as is marked on Sketch 25). But it was for the moment in jeopardy. It had been surprised by the size of this unexpected new body upon its right.

Unfortunately, either the 6th French Army came into play a little too early,

or the British a little too late. The commander of the 1st German Army, therefore, had time just before he had got too far on, and just before his position had become hopeless, to bring back his troops which were marching past the British, and to throw them against the new menace on his flank. But in executing that hurried movement he naturally compelled the German troops beyond him to conform and lean to the right also; this at once perilously stretched the central bodies of the German Army, and at last allowed a gap to appear among them.

That fact is the central fact of all the Battle of the Marne.

This it was which made that battle a "Battle of Dislocation."

The whole thing may be compared to a piece of elastic which one pulls up towards one end until, in the centre, it snaps.

There was just one moment in the third day of the action when the whole position was that of Sketch 26.

The whole mass of the German forces leant towards their right, as along the arrows on Sketch 26. The 6th French

Army was by that manœuvre itself outflanked and outnumbered, and for a moment in some peril. But the Germans had so blundered in their haste as to leave a dangerous thinness in their line at the point marked A upon Sketch 26.

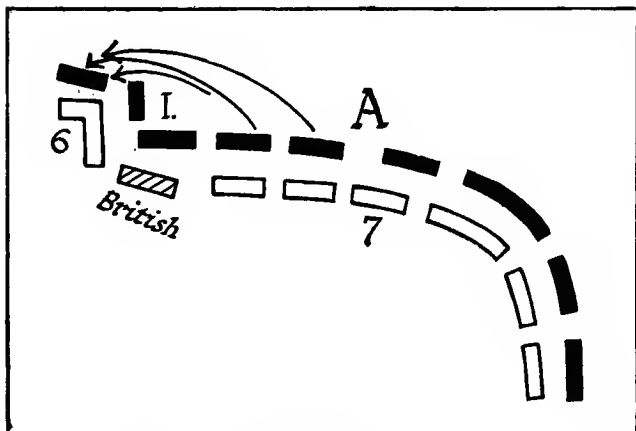

Sketch 26.

There happened to be opposite this gap the newly-formed and arrived "Mass of Manœuvre," the French 7th (or 9th\*) Army. It was under the ablest of the French commanders, Foch. He discovered the gap opening in the afternoon of the 9th of September, the fifth and most critical day

\* See page 89.

## 98 A GENERAL SKETCH OF

of the battle. He pushed at once through. And the situation became that of Sketch 27, the continuation of which would obviously have been ruin to the German armies.

They fell back with the utmost expedition, re-formed their line as along the dots of Sketch 27 (where they had

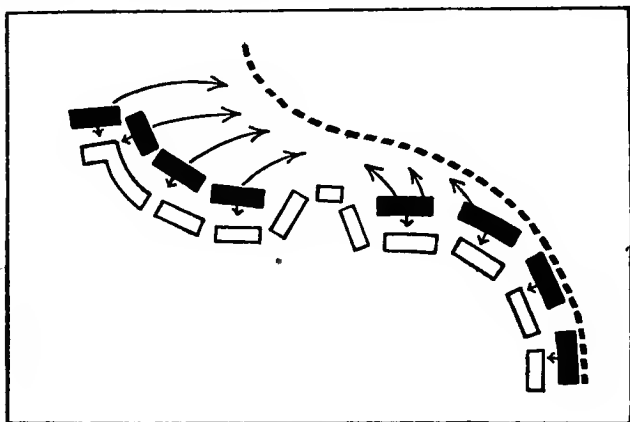

Sketch 27.

already prepared trenches), there dug themselves in, and were pinned. They had lost their mobility in the West. The invasion was ended.

The invader was thrown down. He was held, and the whole face of the war and of history had changed.

Such were the elements of the Battle

of the Marne. It would have been impossible had not the French not only discovered the gap, but also, in every part of the line where the superior numbers struck them, stood their ground. It was an action quite as much determined by this unexpected value of the sorely tried Allies and their power to take a counter-offensive, as by the enemy's blunder or Foch's genius in taking immediate advantage of that blunder, in discovering it from the vaguest indices by a flash of intuition, and in striking precisely where the blow would tell with most effect. Above all, the Marne, as the disparity of numbers proves, was a battle wherein the moral qualities of endurance, rapid intelligence, and wide survey had the better of mechanical routine and excess of detail, though these were at the service of an overwhelming majority. The moral element, indeed, cannot be exaggerated, but the comprehension of the battle as a matter of diagram depends upon the three phases just described.

First, the surprise of the German right at its danger of being outflanked by new and unexpected forces.

Secondly, the movement of Germans westward to meet this danger, a movement so ill accomplished that their centre was thinned until a gap appeared.

Thirdly, the discovery and immediate advantage taken of that gap by the French 7th (or 9th) Army of Foch.

In those three stages consists the Battle of the Marne.

### *Criticism of this Theory.*

Such is the statement in the briefest and most general form of the strategy and tactics which produced and decided the Battle of the Marne. Upon that statement this study is based, and my book is but an expansion of this fundamental conception.

But I should be misleading the reader if I were to present this theory of the great battle as one already universally accepted, and as one against which no one would make a criticism.

There cannot exactly be said to be two conflicting accounts of the Battle of the Marne. Nor is it an action upon which history will have a great, unexplained movement to account for, as it has, for



instance, Erlon's counter-march to account for in the Waterloo campaign. But there are two *ways* of stating the fashion in which the battle was won, and these two ways, though they are not contradictory, sufficiently differ in character to merit, each of them, statement and explanation. The one I have just put forward at length. I must, in justice to the reader, state the other also, and contrast the two.

The thing is rather subtle, but necessary to a full comprehension of the campaign, for it is by the failure to elucidate such points that military history so often confuses the reader.

Let me explain the difficulty by a simile. A man wrestling with another of superior weight and strength to himself proposes to trip him up by putting his right foot behind the other's heels, and pressing at the same time upon the other's shoulders. His opponent reels and nearly falls; but the tripping-up movement having been slightly mistimed, he does not actually fall. He recovers himself for an instant, and there is a moment in which he is actually pressing down the lighter

man in his turn—though the reeling back and the counter-thrust forward are really all part of one movement, which would never have taken place had not the tripping been undertaken. Meanwhile the lighter man, in this immediately succeeding second phase of the wrestle though in peril of falling, sees the opportunity of taking a new hold ; takes that hold, and finally throws his heavier opponent, and wins the match.

The whole succession of three phases has been so rapid and so closely connected that one may put them together and call them in a lump an attempt to trip up which failed in its first effect, but was the real cause of the final throw. Or one may emphasize the final movement ; point out the failure of the first trip, and ascribe the result mainly to the last hold and throw.

The Battle of the Marne was exactly of that nature.

It is clear that in the last few seconds of a wrestling match such as has just been described, a discussion might arise as to whether it was the initial tripping up of the heavier man or the last catch suc-

cessfully clinched which really decided the match.

It would depend upon the extent to which, in the judgment of each, the heavier man had rallied for a moment. One man describing such a wrestling match might say : " Though the heavier man rallied just for a second, his fall was obviously due to the first tripping, which was the cause of everything that followed."

Another one describing the match might say : " The heavier man had quite turned the tables, and if the lighter man had not taken the opportunity of the second hold he would have been beaten."

In the Battle of the Marne, when we come to look into its details, we shall see the possibility of just such a debate, and those who describe the battle will unconsciously be biassed by their desire to ascribe a greater effect to one general rather than to another.

Already in the few accounts of the Marne that have appeared, the two ways of looking at the thing have been presented. There is no contradiction, but there is a difference of emphasis.

In one set of studies \* the battle is shown as essentially decided by the last action of Foch in the centre, and that is the view deliberately adopted after many months of close consideration, including a personal visit to all the main sites of the battle, and hearing the evidence of the best witnesses, by the present writer. In another set the Marne is put forward as dependent mainly upon Maunoury's surprise attack with the 6th Army on the extreme western flank.

In the first and, as I believe, the better view, you are particularly directed to the undoubted fact that if the Germans had broken the French centre Maunoury's effort would have been wasted. It is equally an undoubted fact that what prevented the breaking of the French centre was Foch's lightning move of the afternoon of 9th September.

In the second, alternative, view your

\* A remarkable example is the book *Germany in Defeat*, by Count Charles de Souza and Major Haldane M'Fall, published by Kegan Paul, which has appeared in this country and shows a very close grasp of the main thesis presented in the present work. Upon the other side, Babin's precise but not theoretic study emphasizes the alternative view.

attention is specially directed to the fact—which is not disputed, of course—that the whole battle takes the form of successive steps or movements, retirements by the Germans, advances by the Allies, up northwards. It is pointed out that the first of these is due to Maunoury's surprise attack, and that all the others only follow in due succession as effects of that cause.

Thus, the German Ist Army, on the extreme west, began to retire in order to meet Maunoury on the 6th of September. The next army, the IIInd, was in retirement upon its western end as early as the 7th of September; its eastern end was not pressed until the 8th of September. The next army along the line, the IIIrd Army in front of Foch, showed no sign of retiring, and was not even considering it late in the 9th of September, when it received its unexpected blow, and its retirement proper did not take place until the 10th.

The fact that all these movements from west to east follow one after the other in time, and that the retreat began upon the west, and continued successively later

and later, until it came latest of all upon the centre—nay, the added fact that the last army of all to the east, that of the Crown Prince, did not seriously fall back until the 12th—lends colour to all this view of the battle.

But I must still maintain that this view, though the mere statement of fact in it is accurate, is mechanical and misjudges the vital moment in the battle. It is not retirement or advance which is the essential of victory or defeat, though these are usually the concomitants of either. Before you can say "Here was such and such an army defeated," you must discover not where, nor even when, any portion of it began to retire, but what portion, and at what time and place, suffered the particular stroke which was decisive of the whole. Now I take it that the stroke delivered by Foch in the afternoon of Wednesday, 9th September, corresponds to that test. The Guard was the fraction of the German Army which received the decisive blow. The place was La Fère Champenoise. The time was between five and six in the evening on Wednesday, September 9, 1914.

If further support be required for the maintenance of such a thesis, the following point, I think, is sufficient :—

Supposing Foch had not perceived his opportunity, nor taken it, what would have happened ? How would history then have looked at the surprise effected by the 6th Army on the west, its partial—and what would later have been its complete—failure ?

Supposing the Germans had broken through in the centre—what, then, would have been the Battle of the Marne ?

Clearly the historian would have had to say : “ The French, with the contingent of their British allies, attempted to redress the desperate situation due to their inferiority of number by a surprise attack with insufficient force upon the German right flank. But the 1st German Army parried this effort in time, enveloped the Allied left wing in their turn, and meanwhile broke the Allied centre, thereby deciding the whole issue in their favour. The Allied army was cut in two fragments, one of which was pushed back upon Paris and contained, the other enveloped towards the eastern frontier and destroyed.

Upon the western remnant thus contained, after the destruction of the eastern half, the whole mass of the invaders next turned in numbers three to one, and this amazing campaign of three weeks was at an end. The effect upon the history of the world," etc., etc.

That the future historian will not have to present such a record is due to the fact that Foch met and outwitted the enormous pressure upon the centre.



THE BATTLE OF THE MARNE.

---

PART II.



# THE BATTLE OF THE MARNE.

## PART II.

### THE DETAILS OF THE BATTLE.

**T**HE details of the great action which determined the enemy's invasion of the West fall, as the reader will see from what has already been described, into three great groups.

(1.) You have first the resistance offered upon the French right wing in front of Nancy, and you have this resistance producing the following effects :—

It makes the German Higher Command believe that the weight of the French Army and its chief masses of men are here upon the eastern frontier. Consequently upon this error it persuades the German Higher Command to order their own extreme right, when it got to the neighbourhood of Paris, to swerve round

## 112 A GENERAL SKETCH OF

against, push back, and envelop the supposedly weak French left, neglecting the supposedly exhausted British contingent beyond.

This eastern fighting is the preliminary to the whole affair, without a comprehen-

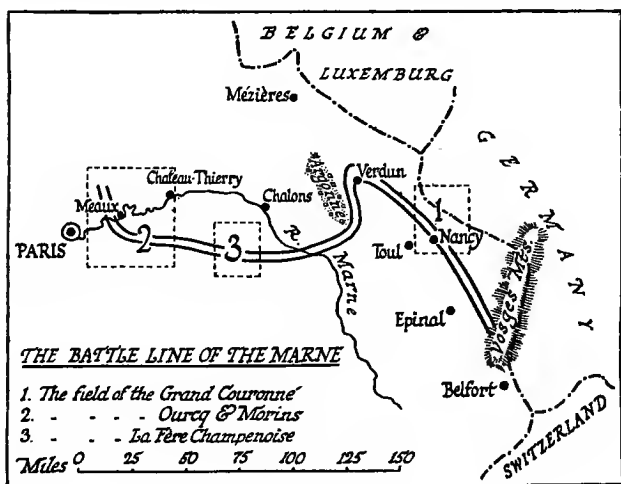

Sketch 28.

sion of which we cannot understand what follows. It took place just before that dramatic moment when Joffre ordered the counter-offensive all along the line of the Marne. It filled the week before the Battle of the Marne proper, and in its last stages only just overlapped the first

stages of the successful series of actions to the west. But it is the foundation of the whole, and must first be clearly understood if we are to understand its consequences in Champagne and in the neighbourhood of Paris.

It is not easy to give to modern actions particular names such as attached to those of the older warfare. The numbers engaged and the very great areas involved make the use of a town or village name misleading. The best plan is to distinguish them by some striking but extended natural feature of the terrain over which they were fought.

This eastern resistance which laid the foundations of the Battle of the Marne we will call, then, the action of *Le Grand Couronné*, from the military name of that range of hills in defence of which it was fought.\*

The whole action was spread out in front of the town of Nancy for more than

\* The term "Grand Couronné de Nancy" is not a local place-name. It is the modern invention of the French Staff; a title given to this position as covering Nancy, and derived by a metaphor from the technical term "couronné" in French fortification—a term applied to an advanced earthwork thrown out in front of and covering the main line.

ten miles, and covered that town. It has, therefore, also been called the "Battle of Nancy." But the term seems to me improper, not only from the fact given above that any one town or village name rarely sufficiently defines the terrain of a modern action, but also because it implies that the French Higher Command was concerned to save the geographical area called "Nancy." No such consideration was in its mind. No town however rich, no mere space however politically important, would have been allowed to interfere with the great plan which was already in process of execution. And the reason that the enemy was checked where he was is not to be found in the fact that this particular choice of position saved Nancy from invasion, but in the advantages afforded by the Grand Couronné, which is a well-defined range of wooded heights standing before that town, and separating the valley of the Moselle from that of the Seille.

The action of the Grand Couronné covers the first seven days of September. Its first beginnings are traceable to the last two days of August.

(2.) You have next in time the battle which took place at the other extreme end of the line in the region of Paris, and which concerned the defeat of Kluck's and Buelow's commands, the Ist and IInd German Armies. The entire movements connected with this field cover more than ten days. They are already developing by the 3rd of September. They are not quite ended by the 13th. But their acute phase falls upon the 6th, 7th, and 8th of September, which saw the ruin of the German turning movement, the surprise of the German right wing by the unexpected appearance of the French 6th Army on the extreme French left, the consequent leaning back and up of forces westward all along the German line from its centre onward to meet that surprise, and at the same time the beginning of the German right wing's retreat before the British contingent and the French 5th Army.

To this series of actions, though they form a very distinct second group in the development of the victory, it is not easy to give a name, and none has hitherto been affixed.

It might very generally be called the Battle before Paris.

Its most central point geographically was the town of Meaux; but, for the reasons given above, a town name is invalid. The most conspicuous feature in the field is the river Ourcq; and the French have already tentatively called it "the Battle of the Ourcq." But to give the battle the title of the "Battle of the Ourcq" alone is confusing. There *was*, as a *part* of the whole, a very definite "Battle of the Ourcq," but that action did not cover the whole Allied left, nor alone decide the movement of the enemy's right. Only one of the great units engaged on the Allied side fought along the banks of the Ourcq—to wit, the French 6th Army. The British contingent and the French 5th Army were away on the other side of the Marne. These fought along, and advanced over, the Lesser and the Greater Morin, two streams which flow into the Marne from the south as does the Ourcq from the north.

Our term may be a trifle clumsy, but it will be at least accurate, if we call this second group of the movements which



decided the issue of the Marne the actions of *The Ourcq and the Morins*.

(3.) The first phase, the defence of the Grand Couronné, having, by misleading the German Higher Command as to the strength of the French left, produced the second phase—the attempt of the Germans to turn that French left in their ignorance of the French strength there, and their consequent overthrow in the actions of the Ourcq and the Morins—the third and decisive phase appeared in the *centre*, where the point of dislocation which settled the whole affair was allowed, by a blunder of the enemy, to develop.

This third phase of the Marne, then, concerns the opening of that gap in the middle of the German line, the immediate advantage taken of that opportunity by the French 7th (or 9th) Army in front of it, and the consequent breakdown of the whole German plan.

This third and decisive phase of the Marne covers in time five days—the 5th, 6th, 7th, 8th, and 9th of September. By the 10th the Battle of the Marne was won. There followed, of course, in the case of the German right wing, and indeed

the whole of the line, further fighting before the final result of the action was accomplished in pinning the invader to a line of trenches from which he resisted all further pressure.

But in its essentials the decisive move in the centre taken by the 7th (or 9th) Army covered those five days, and is the last of the three great movements which settled the business.

It is impossible to give a general name to this action, because it lay astraddle of the plateau, the escarpment, and the plain where the high land of Sézanne falls on to the level of the Champagne. Any name, including the plateau of Sézanne, the marshes of St. Gond, the escarpment of the Champagne, and the Western Champagne itself, would be far too clumsy. Any name taken from some two of these features only would be inaccurate. It is necessary here to break our rule, and to take the name of the village or small town whence the centre of the drive proceeded, and to speak of Foch's action as the battle of *La Fère Champenoise*. This is the name also to which, if I am not mistaken, the

French official records are now committed.

We are about, then, to study separately (1) the actions of the Grand Couronné, say the 1st to the 7th September; (2) the actions of the Ourcq-Morins and their consequence, say from the 5th to the 10th September; and (3) the action of La Fère Champenoise, the last and decisive one, say the 6th, 7th, 8th, 9th, and 10th of the same month.

Material for such description is still exceedingly meagre, but it is possible to present a coherent view to the reader. When each action has been presented, I will attempt to co-ordinate the whole, and to sum up the nature of the victory.

## I.

### THE BATTLE OF THE "GRAND COURONNÉ."

All along the frontier common to France and Germany by the Treaty signed after the Prussian victory of 1871 the French had erected, at a cost equivalent to at least three years of the national revenue, a chain of fortresses of the strongest sort.

Nothing surpassed them in the science of their time. There were, as we have seen on a former page, four great rings—those of Belfort, Épinal, Toul, and Verdun—each ring protecting vast supplies, and forming a great entrenched camp. Along the southern half of this line, which is mountainous and coincides with the range of the Vosges, a string of forts linked up the system. Along the northern part, the line of the Upper Meuse, a further chain of forts linked up Toul with Verdun.

The invention of aircraft (which enables the exact fall of a shell to be spotted at whatever length of range the projectile be shot from) suddenly changed this state of affairs; the invention of the petrol engine (which gives mobility to very heavy siege guns), the development of high explosives—all these three novelties between them rendered the old limited fort, whose position upon the map was exactly known, and which afforded a known and fixed target for a siege train, impotent. The modern siege train, with its large, high-explosive shells, its aim corrected by aircraft, could make absolutely certain of demolishing limited fixed works of this kind in a very few days. The Austrian Higher Command had been the first to appreciate this truth. It was they who produced the new siege train on which their German Allies mainly relied. Meanwhile the Central Powers as a whole were confident that the permanent fortifications upon which the French and others had depended for a generation were obsolete. Their confidence was well founded; their judgment in this particular was perfectly right.

They had already proved it at Liége and Namur before their advance approached Verdun, the northernmost stronghold in the French fortified line of the eastern frontier.

At this point it is important to understand what their objects were in advancing against this place, and what they thought would follow in a few days from the certain fall of the permanent works defending it.

The general German plan was, as we all know, to sweep round through Belgium, so that the French Army should be caught as in a net by the advance of superior numbers round it by the north and the west. They envisaged a whole state of affairs that has already been described, but may be repeated here to explain why the Grand Couronné was so important. The German General Staff intended the invasion to begin with a full German line, AB, against the dotted French line within it, and to end with a full German line, BC, curling round, cutting off, and so destroying the lesser dotted line within it : a Sedan on a very large scale.

For such a plan no great movement was necessary on the German left at B, the old eastern frontier common to France and Germany. It was part of the German plan only to hold the French here; to mass them there while the extreme German right from A (Flanders) curled

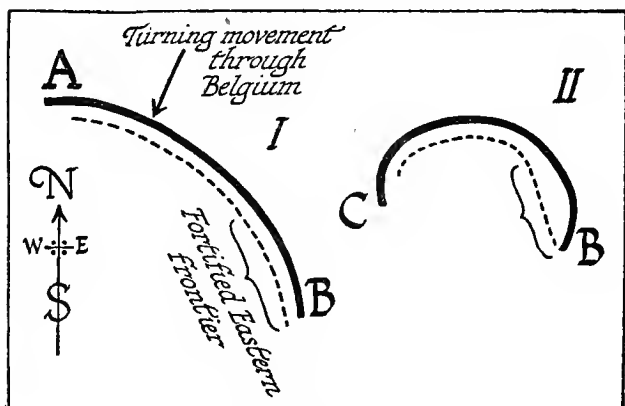

Sketch 29.

round the French to C (near Paris) and enveloped them.

But somewhat adverse to this plan was the presence of the fortified eastern frontier if it was allowed to stand unbroken, and that for two reasons. First, that if the French found they could stand behind their fortifications in the east, they

would leave there a bare minimum of men, would mass towards their left upon the west, and would meet with the bulk of their numbers the German attempt at envelopment. You could only hold the French on their right near the old frontier on condition of making them anxious there for their security.

The other reason, which was of great importance, was this : the rings of forts round Verdun and Toul covered not only entrenched camps and supplies, but railway junctions, the capture of which alone would permit of a really rapid supply from Germany to the armies operating in France.

We have seen how all the autumn of 1914 and the winter of 1915 German concentration of effort has been upon the northern part of this line. That had been because *there* only had the Germans, through Luxembourg and Belgium, a short and direct route from their arsenals and bases of supply at home to their front. First, if they could have got Verdun and Toul everything would have been changed. Much shorter lines of communication would have led them



directly into the heart of the enemy's country. An elementary diagram of the main railway lines will show what I mean. From Cologne and the West-

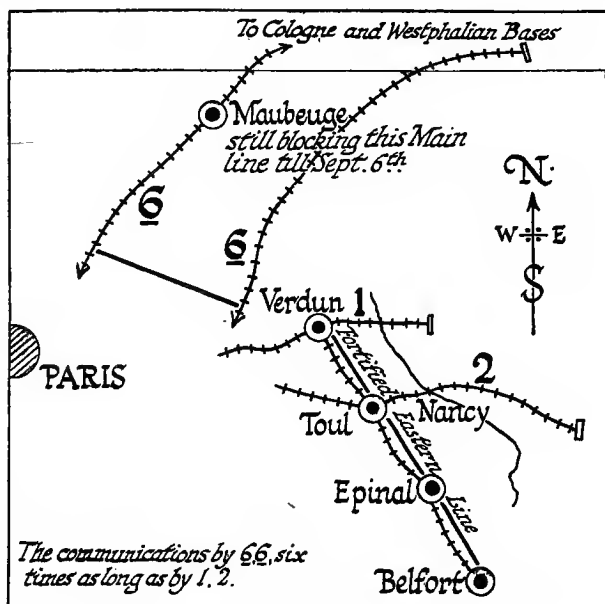

Sketch 30.

phalian bases (6, 6) the railway communication to the German front at the moment of the Marne was six times as long as from Metz and from Strasburg, (1) and (2). Further, the longer lines went

through a now hostile Belgium, which it required many men to hold down.

Length of communication is not so very important when the front is stationary, and when there is plenty of time to bring up munitions and supplies. But while the front is mobile, to have short communications is to increase your advantage in a much greater ratio than the mere mileage. We must not forget that in this first stage of the war the enemy's political object was not to survive (as it is to-day), but to *conquer*. Conquest was his political object, and the whole of the strategical plan which he had prepared depended upon rapid and exceedingly mobile action upon French soil.

With so much said, it should be clear what end the enemy had in view in forcing the line of the eastern fortifications. He did indeed propose to do no more than hold the French on that end of their line while he curled round the other end of it, but it was essential to hold them *beyond* the fortified railway junctions, and with these fortified railway junctions in *his* power. In other words, he must not only sweep down through Belgium; he

must also, in a fairly short time, get past or through the fortified eastern line.

Now there were four reasons which made him attempt this feat—an easy one if Liége, Namur, and Maubeuge were any guides—in a direction from north to south—that is, from Verdun down towards Toul.

The first of these reasons was the fact that the mass of his troops were working round by the north, and his whole organization depended upon this northern agglomeration. He could always borrow troops from the north to be used southwards; he could not so easily borrow them from the south to be used northwards.

The second reason was a matter of ground. The southern part of the French barrier, by Epinal and Belfort, was mountainous and deeply wooded; the northern, by Verdun and Toul, was open.

The third reason was that the French movement on Mulhouse into Alsace, which had been a strictly strategic movement, was taken by the enemy for a political movement. They argued that the French had massed troops rather to the south of

the line, and that therefore he had better himself strike to the north of it.

But the fourth reason was much more important than any of these. It was the fact that Toul and Verdun, the northern part of the line, would give him far better railway facilities than the southern, and railway facilities which it was vital to him to use at once if he was to bring his full force into play against the French Army, and destroy it as rapidly as might be.

It must be remembered in this connection that Maubeuge had not yet fallen, and Maubeuge protected another junction seriously handicapping the supplies through Belgium. If the enemy could take Verdun quickly, a flood of supplies would be loosed across the Rhine bridges and through Metz and Luxembourg for use in the eastern plains of France.

Against Verdun, therefore, the number of no less than six army corps moved under the nominal command of the Crown Prince of Prussia. As a soldier this young man was, of course, negligible, and the traditions of the enemy, though weakened by respect for birth in the highly

technical matter of command, did not go so far as to give him any real authority. It is an error to ascribe the failure of the Germans before Verdun to the personal incompetence of a man quite insignificant apart from his social position. Verdun was saved by the astonishing rapidity with which the French learnt the lesson that their old theory of permanent fortification was now wrong. General Sarrail, in command of the French 3rd Army, had moved in hours rather than days the heavy guns of the fortress—or at least a great proportion of them—from their old permanent positions to new field works concealed upon a much wider perimeter. The new works were hidden wherever the ground gave the least advantage. The wooded nature of that district helped the scheme, and the original German idea that Verdun would suffer the fate of the Belgian fortresses came to nothing the moment the Germans found that fire had been opened against their advancing troops by guns of large calibre, not from the old permanent forts, but from the new batteries.

It is from this discovery that the Battle

of the Grand Couronné develops. The German Higher Command determined to do no more at the best than isolate Verdun—attacking the forts to the south, maintaining there strong forces against the northern and eastern new outer works, but concentrating their principal effort farther south, with the object of forcing the line by the gap south of Toul, and particularly in front of and through the open town of Nancy. They had ready for this effort all the great force mustered under the nominal command of the Prince Regent of Bavaria, the army based upon Metz. In front of this, as an obstacle which the French could defend, was the position of the Grand Couronné.

Let me describe that position. Rising from the deep trench of the Moselle valley upon the west, and separating it from the wider and more broken valley of the Seille upon the east, there runs by way of watershed a range of hills clothed here and there with forests of considerable area, and dominating the water level in summits some six hundred feet above the valleys. It was an obstacle which the Germans could not avoid without stretching so far round

south as to leave a gap, or at least a weakness, in their line. It was an obstacle which they must carry at all costs if they were to compel the French to keep what the Germans believed to be the mass of the French Army in these eastern positions, and ultimately to secure the great

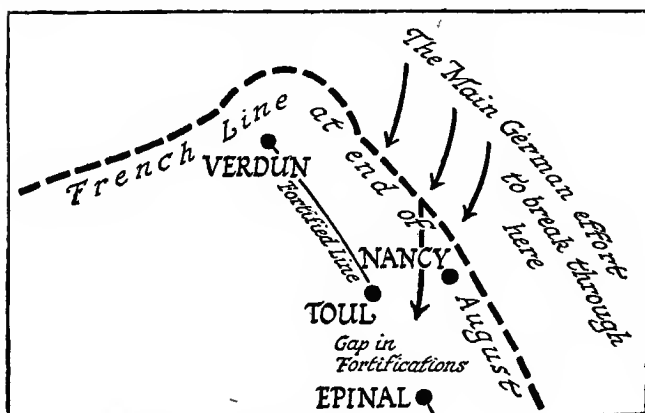

Sketch 31.

railway junctions that lay immediately behind.

In its mere elements, then, the situation was this: A force already large, say five army corps, or perhaps six, had to carry and cross a sort of wall of hills possessed of a certain amount of wooded cover, and the test of their success would be the

## 132 A GENERAL SKETCH OF

retirement of the beaten French forces from the crest of those hills to the next

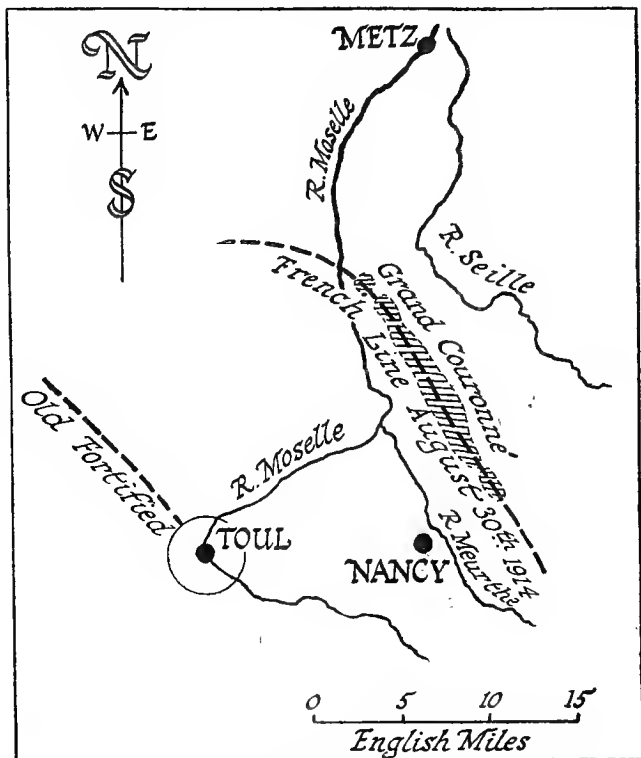

Sketch 32.

parallel crest behind—that is, to beyond the Moselle.

But such success would involve the French abandonment of Nancy. That is



why Nancy, an open town, was, so to speak, the symbol and guerdon of the whole effort. A triumphant entry into Nancy would mean that the French field defensive in the east had been forced, and that the occupation of the railway junctions was only a matter of time. A failure to force the Grand Couronné, and to enter Nancy behind it—a failure to do this within the limits of time imposed by the enveloping movement taking place 120 miles to the west—would mean that the French had made good their effort to check the enemy upon this eastern line. The enemy, though he should be foiled at the Grand Couronné, would still believe that he had caused the largest individual mass of the French Army to stand in front of him there, and had thus weakened the western portions, and subserved his distant western enveloping movement. But he would not have achieved a complete success if he had merely attacked this position—probably at great expense in men—without carrying it.

All this must be stated in order that one may understand the German point of view, erroneous though it was. Other-

wise we shall not understand why the Germans went on throwing away unit after unit in the desperate and ultimately futile attempt to force the Grand Couronné and enter Nancy.

But from the French point of view—from the point of view of those who were privy to the French plan—a successful resistance upon the Grand Couronné was of far more sharply defined importance.

*They* knew that the better they held the more the Germans would be deceived into exaggerating their numbers, and the more consequently would the Germans exaggerate their error with regard to the weakening of the distant French western extremity; the less would the Germans guess that large French forces were gathering in reinforcement of that western extremity 120 miles away, and the more thoroughly would the strategy so subtly conceived, whereby five men were to defeat eight, achieve its end.

The ideal or diagrammatic form of such a position as the Grand Couronné is one unbroken glacis. If you could get a crest, say, from ten to fifteen miles long (as in Sketch 33), with plenty of cover from woods

and what not to conceal batteries on the shaded side ABCD, and a fine open field of fire on the unshaded side AB $\bar{E}$ F, ending upon either flank in the sharp, round declivity at G and H, that would be a

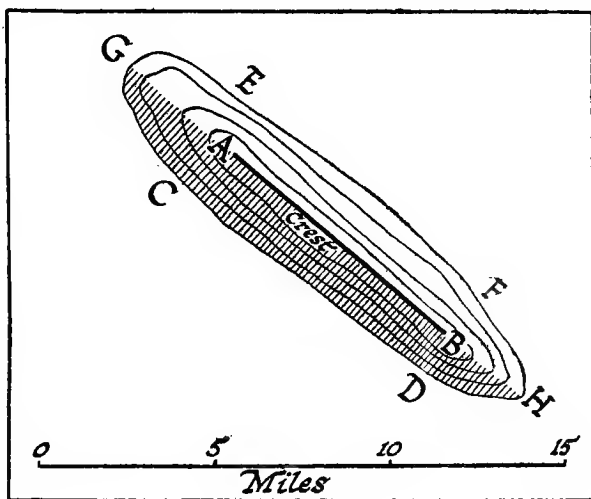

Sketch 33.

Grand Couronné of the sergeant-instructor type, a Grand Couronné to dream of.

Real positions are never like that, especially when they extend over so great an amount of country as ten or fifteen miles ; and the ridge of the Grand Couronné is, like all such bodies of hills, deeply indented with combes, only occasionally

covered with wood—and not always on the right side—full of patches which offer a special opportunity for assault. Its actual contours the reader may follow in the next sketch ; but from that map the reader will also appreciate that, in spite of its diversity, the position is essentially a wall, and a wall with plenty of cover for guns. In spite of the unevenness of the summit and the complex arrangement of the dales running in deeply from the Moselle and Meurthe on the one side, and of the undulating slopes falling to the Seille on the other, it could be treated by one with a skilful eye for ground as one ridge ; and temporary works and entrenched infantry positions could be discovered everywhere, so that the enemy's attack upon them would have to come up over some considerable field of fire from the Seille valley below.

The real problem was how to protect the northern flank.

At the southern end the Grand Couronné was fairly safe, although it was the closest point to the town of Nancy itself (a mere geographical point so far as tactics were concerned). Here stands the plateau

of Amance, the strongest position in the whole line, a partly isolated hill overlook-

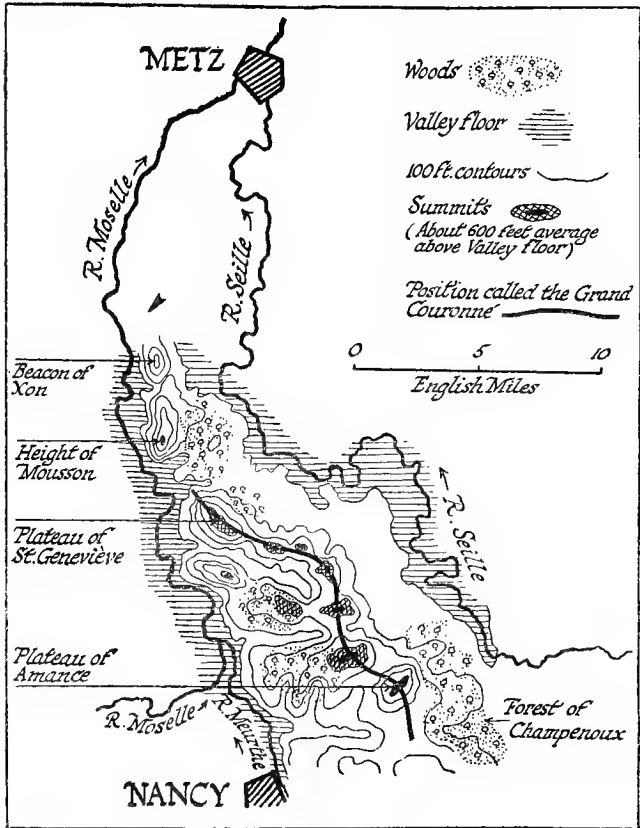

Sketch 34.

ing the Forest of Champenoux in the plain below. It is true that the enemy

were in considerable strength at this end of the line, but they actually moved men up from in front of it towards the north, in order to make their attack upon the northern end. They had just been badly checked south of the plateau of Amance in an attempt to go forward after their action at Saarbours (to the east, out of the map). The farther they got south the nearer they were to the difficult Vosges country, and the less their chance of getting hold of Toul and the railway junction; and again, if they began the action towards the south and massed most of their men there, there would be the danger of leaving a gap or too thin a line upon the north. Again, the enemy's chief strength was towards the north. From the north alone could he borrow men, and it was the north which lay closest to the supplies of Metz. Moreover, he did not even weaken his line at any point, because he greatly overestimated the numbers of the French in front of him.

Now this *northern* flank of the Grand Couronné was far from secure. The hills of Lorraine, of which the Grand Cou-

ronné is but a particular range, lie in broken groups, diversified by occasional quite isolated summits. There is at the end of the Grand Couronné position, as will have been seen upon the last sketch map, the village of St. Geneviève, standing right up on a high hill which to the east, north, and west, falls sharply down in bare, open fields towards the Seille upon one side, and the Moselle upon the other. Upon the south the height of St. Geneviève is connected by a low, long saddle with the general ridge of the Grand Couronné. Immediately north, beyond the low valley, rises the perfectly isolated peak, on the top of which is the village of Mousson, one of those prehistoric fortresses which still keep a sparse population. Beyond this, to the north again, is the isolated peak of the signal or beacon of Xon, and so to the fortified heights round Metz, twelve miles away.

All this northern end of the Grand Couronné lacks that complete differentiation between a position and the plain below it which would make its tenure secure. It is at modern ranges faced by one position after another in a chain.

If you hold St. Geneviève the true end of the ridge, Mousson, as high as you and over against you at 5,000 yards range, is a peril. If you occupy Mousson, Xon is behind you again. If, at great risk of thinning your line, you try to hold Xon, you are under the guns of Metz.

Castelnau, commanding all this sector and in particular the 2nd Army, which had for its task the holding of the Grand Couronné (or, as it was popularly and erroneously called, "The Defence of Nancy"), took up positions upon the Grand Couronné proper.

On the northern flank, for which he was most anxious, he did not dispose either his best or his more numerous troops, but he seems to have strengthened it heavily with artillery, and he relied upon its being, if attacked, at least not turned, from the fact that the ground beyond to the west of the Moselle was strongly held. Of the forces at his disposal, two-thirds held the slopes of the middle and southern end of the Grand Couronné proper over the Seille, while the 20th Corps, which is the pride of the French service, either lay at the be-



ginning of the action upon, or was moved before the end of it on to, the plateau of Amance—a disposition which argues the wisdom of the commander who foresaw that when the German effort had been checked upon the north it would automatically work down southwards, and try to get round at last by the very flank which it had at first rightly refused to attempt.

Those who are interested in the analogy of past history will be curious to note that the Grand Couronné not a little resembled the positions occupied by the Austrians before the Battle of Wattignies, which also in its time had helped to decide the fate of the French Republic. Such positions are imperilled when any part of the crest is forced and held by the assault coming from below. It is like the piercing of a line. Wattignies was won because upon the long, wooded crest in front of Maubeuge the French managed upon the third day (120 odd years ago) to carry one summit of the crest near the village of Wattignies itself. The Battle of the Grand Couronné was lost by the Germans because they nowhere succeeded during a

full week's fighting in establishing themselves permanently upon any point upon the heights between St. Geneviève to the north and the plateau of Amance to the south.

The first signs that the enemy intended to attack in great force, no longer Verdun but this position covering Nancy, were discovered when two contemporary movements showed the nature of their plans.

First, a violent artillery duel to the south, begun by the Germans, covered the concentration of troops up northward towards the Grand Couronné from the garrison of Strasburg and the plain of Saarbourg.

Next, Strantz, in command of the Vth German Army Corps, was on the march due west from Metz to attack the line of the Meuse—that is, to support the general design against Verdun, when, upon the 30th of August, he received orders to wheel round suddenly by more than ninety degrees, and march on Pont-à-Mousson, the large market town and bridge under the isolated peak of Mousson.

Here it may be asked why the enemy

did not try to turn the position of the Grand Couronné round by the west and north at AB. There was here an open plain, the Woëvre, and though it is sometimes (especially in winter) very bad going, with clay soil, the weather was at this moment exceedingly dry, it was the

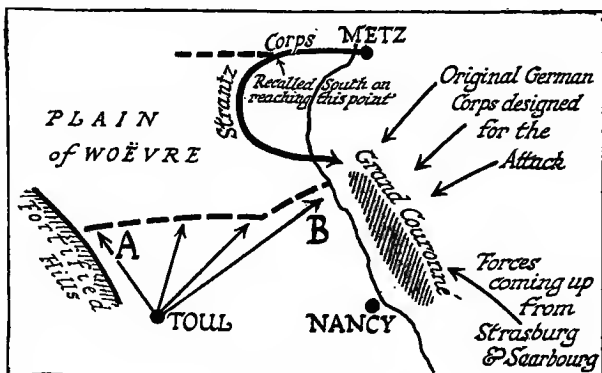

Sketch 35.

height of summer, and no difficulty was to be expected on that score.

The reason that Strantz was ordered thus to turn sharp round on his march from Metz instead of attacking the line AB was, that the line AB reposed upon Toul with very short and ample communications, and with the prodigious armament of that fortress now pushed well

out into the plain. It is more accurate to regard the attack on the Grand Couronné as an attempt to turn the positions of Toul than the proposal to attack those positions as in any way a feasible turning of the position of the Grand Couronné.

The German troops were coming up from the south to concentrate against the Grand Couronné, and Strantz's additional corps had been borrowed from the Verdun business to menace the perilous northern flank of the Grand Couronné.

On the 31st of August, or, perhaps, the evening of the day before, the enemy began that form of attack upon which he confidently relied—the preparation with very heavy mobile artillery. He had gambled deep in his preparation for this war upon the value of large guns in the field. The French had held the opposite view, that heavy artillery in the field tied one—that is, destroyed one's mobility so much as not to be worth while. The French have proved absolutely right so far as mobile war is concerned. But the very error which the Germans had made by laying their money upon heavy artillery in the field, stood them in very good

stead, as we shall see later in this book, when it came to the immobile trench warfare of later months, and the unexpected and enormous increase in heavy munitionment which this required.

This heavy artillery preparation was conducted by about four hundred pieces, drawn principally from Metz. It had far less effect than the German theorists of the period before the war would have assigned to it.

For one thing, it was of short duration. The enemy had not yet learned what the French taught them in Champagne five months later—the necessity of positively drowning even field defence with heavy artillery fire before an attack. The great masses of heavy shell, twenty to fifty times what any one had thought necessary hitherto, were not yet produced, and therefore, after only a comparatively short preparation of this sort, the first infantry attacks were launched against the northern end of the Grand Couronné upon the 31st of August.

The expense in men was startling. When the history of the war can be written from official documents, I think

it will be found that the Germans particularly blundered in their conception of what the "75" gun could do, and that the execution effected by this arm was the foundation of all that followed. But the dense massed attacks also, of course, reached the range of the machine gun and the rifle, and at point after point on the slopes rising up from the Seille, were thrown back, the last wave of them at the point of the bayonet.

For a whole week this amazing spectacle (and what a war this is, that not even a brief picture of such a battle should have been presented yet to Europe, under the discipline of silence which the French have enforced upon themselves!) went on. Charge upon charge of units drawn from every part of Germany, each charge preceded by the inevitable heavy artillery preparation, each repelled, and the dead accumulating in heaps upon the slopes that lead up from the valley of the Seille.

There was a moment in the tremendous struggle when the firm French position seemed in some peril. A small flanking force holding the isolated height of Mousson was forced from that peak by Strantz,

whose artillery, corrected by observation posts placed there, answered, and seemed at the time to command the opposing position of St. Geneviève. But this peril did not develop. The ground in front of St. Geneviève was too well prepared, and after each effort of the pieces on the Mousson Hill the following charge of infantry below failed.

It is curious to note that the chief work in throwing back this attack fell upon *a single battalion*, and that a Territorial unit of reserve, the 324th. It held the trenches just north of St. Geneviève village, looking towards Mousson hill, and would surely have been swept back if the enemy had had the least idea of how small were the forces here opposed to him. Also the effect produced on him was mainly the work of field pieces.

As this awful week proceeded the tide of effort crept southward, grew, perhaps, fiercest round the forest of Champenoux, threatened the plateau of Amance; but the losses had been too severe, and the remaining power to attack, both moral and material, was waning. It is said, and it is credible, that the French after

the action recovered or noted in German dead alone losses which in those six days stood for an average of perhaps 5,000 a day.

The climax of the business was nearly reached, so far as its local anxieties and local duties were concerned, when there arrived at this army upon the evening of 5th September the famous general order distributed to all the troops from Paris to Alsace. The tenacity of the 2nd Army had borne its fruit. The great retreat proceeding behind it upon the west had reached its term. The counter-offensive was to be undertaken upon the morrow.

Upon that morrow, the 6th of September, the last and, so far as the eye was concerned, the greatest effort of the Germans, was made. News was beginning to come in of the counter-offensive now just beginning along the whole French line from Verdun to Paris, and the necessity of succeeding then or never, so far as the Nancy sector was concerned, was imperative.

It often happens in the history of war that the most striking development of an action—to the eye—does not appear until



the affair is really decided, and that a sort of desperation in the last moments produces the most dramatic aspects of the struggle.

There was something of this in the last tremendous assault of the 6th of September. But in spite of his incredible losses, the enemy still hoped upon that day to decide the issue. He could not but believe that the French forces, far inferior to him in number as he knew, and yet, as he believed, the chief group of his opponent, had suffered under the strain more than he. The nervous instability of the French was a dogma with the enemy's Staff. They had seen it proved in books. They believed it and reasoned on it *a priori*.

This last grand assault was directed against the plateau of Amance. It was watched, as I shall repeat in a moment, by the Emperor himself, who had arrived for this decisive day from his headquarters at Metz. It cleared the French out of the Forest of Champenoux, and reached the open slopes of the hill; but that hill it never carried. It utterly failed, and with its failure the Battle of the Grand Couronné was at an end.

Already by the evening of that day the full news of the counter-offensive against the rest of the line was common to both sides ; Castelnau had heard in full of Maunoury's appearance upon the Ourcq ; of Kluck caught in flank ; of French's launching of the British contingent against the enemy from the forest of Crécy ; of the halt in the Allied retreat, and the return of the wave all along the line from Paris to Verdun.

The German Emperor and his Staff had also heard the news. Kluck must have telegraphed his surprise at the appearance of Maunoury upon his right, and his hurried need for men. The centre must have apprised their Commander-in-Chief of the call made upon them for men, though not, perhaps, of the peril it was to involve : that was to appear later. The whole face of the campaign had changed.

The next day, the 7th and the 8th, the German assaults on the hills were continued, but with no hope of victory. By the 9th the thing had become like the sullen wash of diminished waves three tides after a storm. The German

attack died away in spasms, like those of an animal stricken. After sunset on the 9th a few shells were dropped at long range, unaimed—a moral sign of defeat—on to Nancy itself. Two days later, on the 11th, came the last jerk. One single division on the extreme south, with Heaven knows what object—perhaps with none—debouched from Einville towards Dombasle, and was wiped out. In dead alone it left upon the ground a fifth of its total effectives.

Any detailed consideration of the battle or analysis of it beyond the very general outline here completed is as yet (at the moment of writing) impossible, but we can draw certain conclusions from it even after this space of time, which guide us to an understanding both of the enemy's error in the matter and of its effects.

The importance of the forces with which this great effort was being made proves all those points connected with it which we have emphasized in speaking of the French plan as a whole, and of the German error in meeting that plan. No less than eight German corps—over

a third of a million men—were from first to last occupied in the attempt to force the Grand Couronné. No such mass was to be discovered upon such a front in any other part of the line.

The employment of these very great numbers, portions of which elsewhere might have prevented in time the general disaster, proves at once that the German Higher Command believed Castelnau to have very much larger forces than he really possessed.\* It proves the importance they attached to keeping those supposedly large forces occupied in front of them, and preventing the loan by Castelnau of men to reinforce the French left wing, which Kluck was supposed at that moment to be turning ; and it proves the belief of the German Higher Command that, in spite of the supposedly great numbers in front of them, they could drive the French right back behind the Moselle and the Meuse, isolate Verdun,

\* We do not yet know the details of Castelnau's force. But it seems to have been no more than the equivalent of five divisions. All the 20th Corps was there, a part of the 9th, and several detached units, among which were the defenders of St. Geneviève and the Forest of Champenoux, for both of these were held by Territorials.

and before the end of the week enclose all the French armies in the field within the ring of a new Sedan.

To these strategical considerations, which, had not the German Higher Command been in grave error, would have been sound enough in themselves, it is not unjust to add a certain weakness which has always been present in modern German war, and has been conspicuously present throughout the current campaign. I mean an eye to dramatic effect. There is no doubt at all that a sort of triumphant entry into Nancy had been planned for the Emperor. It is curious to note the paradox of such very unprofessional considerations accompanying the detailed and thorough professional work of the German service. But similar paradoxes are to be observed in many other forms of human activity, and in the particular case of the enemy's army the giving of command to men of mere birth, the multiplicity and phantasy of uniforms in time of peace, the pompous language of the orders of the day, and the very illusions under which it suffers with regard to the enemy's psychology

and its own are part of the same business.

On the critical day of the action, the forenoon of 6th September, the little, aged figure of that unfortunate man whose physical disabilities were, perhaps, in part responsible for the war, was to be seen from the French lines watching the battle from the ground behind. He was distant from the nearest observers by more than the common range of a field piece; he was caught only by the careful scanning of glasses; but the figure and its surroundings were unmistakable. Grouped about him was the "brilliant staff" of the newspapers and the stage; and the White Cuirassiers, which were to be the escort of his triumph, were massed to the left and behind. He had also put on for that day the white uniform of that corps and the silver helmet. It was pathetic, and a little grotesque.

The total of the enemy's losses we shall never know, for the simple reason that the German casualty lists are never complete, and in this disastrous and intensive week were particularly chaotic—and no wonder. But the dead counted by the

French upon the ground at the end of the long action must mean a total loss or general casualty list of not less than a quarter, and much more—probably a third—of the men employed in the assaults. A higher proportion has been named, and that upon competent authority; but the tendency in war is always to exaggerate the enemy's losses. It is wiser to base them in this case upon the accurately ascertained number of German dead left behind upon the ground, and to multiply this by not more than four, considering the murderous character of the fighting at close range, and the repetition of the assaults over so many days. By that reckoning the Grand Couronné cost Germany over 120,000 men. None can deny the praise due to the German system of discipline in making possible a continued effort of the sort, nor can any one deny the lack of judgment which permitted that effort to continue after the fourth day.

The Battle of the Grand Couronné exemplified a point which will undoubtedly stand out from the whole of the war as one of the chief characters in the enemy's

bid for victory—a sort of routine incapable of correcting itself in time; the momentum, as it were, of a huge engine working smoothly, enormous in design, but lacking elasticity altogether.

The complete success of the Battle of the Grand Couronné was the foundation, as I have said, of all that we next must follow. The German conclusion that the French were in far larger numbers than they really were (their losses alone were small compared to the enemy's) had persuaded the Higher Command to order Kluck's famous move under the walls of Paris. That move was in full progress in the very days which saw the climax of the French resistance in front of Nancy. The disastrous effect of that move upon the German fortunes as a whole began to appear just in those hours when the German Emperor returned to Metz from before Nancy, defeated.

To that move of Kluck's, then, and its results, we will next turn.



## II.

### THE BATTLE OF THE OURCQ AND OF THE TWO MORINS.

We have just seen in what fashion was fought out the first of the three enchainéd actions which between them determined the result of the Marne.

That first action we have called the "Grand Couronné." Its venue lay upon the extreme right, or east, of the French line. Its issue was decided by the 6th of September. But long before that date—by the 2nd, at least—the German armies had here received such a check as had convinced them that the mass of the French forces was gathered before them upon these eastern hills.

I have maintained that this error in the German judgment, produced by the unexpectedly strong resistance offered by Castelnau upon the Grand Couronné, is the first step in all that followed. If it

did not cause, it seemed to render more secure the left wheel of the 1st German Army on the extreme opposite end of the line, and the conversion of its direction upon the 2nd and 3rd of September from south-west to south-east.

Once that conversion of direction was effected by the extreme eastern or right wing of the German line, an open flank was presented by it towards the south-west—that is, from the direction of Paris. Its commander, Kluck, presented this open flank (which he guarded but slightly with one-fifth of his total force) because he did not believe that any serious blow could come from that quarter. And he did not believe that any serious blow could come from that quarter because he believed that the French had already put into line all their forces available, and that their mass increased as it gathered towards the east 120 miles away, and was at its least here in the west. He knew that some few and demoralized troops were on his new flank. He did not dream that four divisions, capable in a few days of growing to six, and even eight, were in reach.

For, as a matter of fact, the French had reserved a "Mass of Manœuvre." They had not yet brought forward all their men. Still less had they principally concentrated on the east, in front of Nancy. Part of this "Mass of Manœuvre" was available for use on the extreme west. It suddenly appeared upon the exposed flank of Kluck and his 1st German Army in numbers far superior to anything he had expected.

What followed we shall see in the next few pages. He halted his march towards the south-east. He brought back his forces to meet this threat upon his flank. He in turn outnumbered and proceeded to envelop the new force which had threatened him. This withdrawal of forces to protect his flank meant, of course, a local retreat of some few miles, and a "leaning" of his whole weight westward. It involved a corresponding falling back and "leaning westward" of the II<sup>nd</sup> Army immediately to the east of him, and that retreat was followed up by the Allied forces in front of it.

The combined operations on the west end of the line covered the afternoon of

the 5th of September, and all the 6th, 7th, 8th, and 9th of that month. In their entirety, up to the evening of the 9th, they form what is called "The Battle of the Ourcq," or, more accurately, "The Battle of the Ourcq and the Two Morins."

But though the new dispositions undertaken by General von Kluck to parry the unexpected danger upon his flank involved a local retirement of a few miles, both for his army and for part of the II<sup>nd</sup> German Army upon his left, or east, such a check would of itself alone in no way have been decisive of the great action as a whole, nor would it have resulted in what is called the victory of the Marne. Simultaneously with it was being delivered a violent effort by the Germans in the centre of the whole line, who were there principally met by the French 9th Army, under Foch. Had their efforts succeeded, had the French line broken in the centre, the Battle of the Marne would have been won by the enemy. Everything depended upon the action of the French centre under Foch. As we shall see, it was the action of that army in the course of 9th September, the

last day of the Battle of the Ourcq, which decided victory for the Allies. The falling back of Kluck, and his inevitable "gathering westward" against the threat to his flank, compelled Buelow to the east of him to lean westward too. The German centre was unnaturally thinned. A "gap of dislocation" began to appear. Foch, fifty miles away to east, found this "gap of dislocation" opening in front of him, took immediate advantage of it, routed the German centre, and compelled the rapid retreat of the whole German line. The campaign in France was transformed; the "strategic balance" was reversed: the enemy was put upon the defensive, and the whole nature of the war was changed from an immediate German triumph to what we know.

The thing may be put diagrammatically as in Sketch 36.

The west of the German line, with the Ist, IInd, IIIrd, and IVth Armies, stood before Kluck's conversion of direction as do the dotted lines upon Sketch 36, upon 2nd September, with the Ist Army advancing south-west towards Paris, and the IInd, IIIrd, and IVth advancing south-

ward. After the conversion of direction it stood as do the full lines, with the bulk of Kluck's army, the Ist German Army, pointing as Ib, leaving to protect its flank only one-fifth of its forces at Ia. It was faced, and knew itself to be faced on that flank, by a small French force X; while in front of it it had Y, the British contingent, and Z, the 5th French Army.

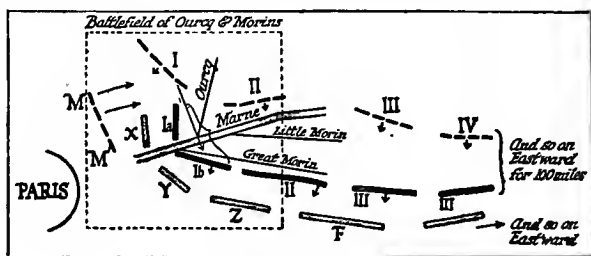

Sketch 36.

Beyond Z was F, the French central army, the army of Foch. In addition to the small known French force X were reinforcements which Kluck had not suspected, marked as a dotted line MM. On the discovery of this new force Kluck withdrew his advanced forces right round back over the Marne to protect his flank, and produced the situation described in the following sketch, 37 :—



September, and compelled the whole German line to fall back, including the Ist German Army, although it had already seriously imperilled the French left at X.

It is clear that if the IIIrd German Army had succeeded, and after pushing back (as it did) the French at F, had also quite turned or broken them, all the left wing of the Allies, X, Y, and Z, would have been isolated and forced back upon Paris, and Germany would have won the Battle of the Marne. The victory of Foch at F, where he took advantage of the gap at B, reversed all these conditions; and after his success the position was that of Sketch 38, with the German Armies, Ist, IInd, and IIIrd, in full retreat, and the Allies everywhere pursuing them northwards.

What we are about to follow separately for the moment is the series of operations on the extreme left within the boundaries of the square frame upon each of these sketches, within which area the action of the Ourcq and the Two Morins may be confined. But we must continually bear in mind, as we follow the details of those operations, that their ultimate result de-



pended not upon the movements within this frame, but upon what was going on to the east of them in the struggle between the IIIrd German Army and the forces of Foch in the Allied centre.

We begin the recital of the Battle of the

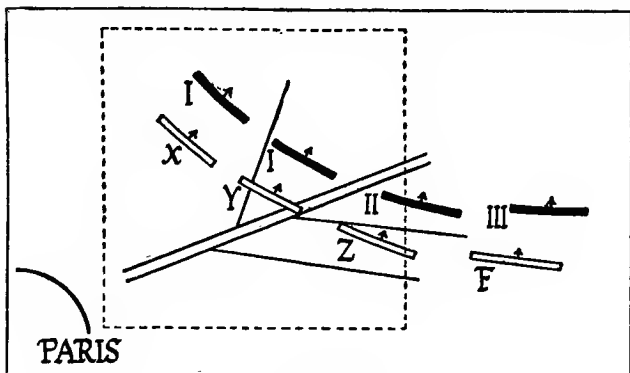

Sketch 38.

Ourcq with Wednesday, 2nd September, the anniversary of Sedan.

On that day Kluck's army was stretched out in the region of Compiègne and Senlis, with cavalry watching far in front of its main line, and the whole force still pointing south-eastward toward Paris. But already the news had come of the successful French resistance on the Grand

## 166 A GENERAL SKETCH OF

Couronné, and—perhaps long before—the order to turn the German extreme right wing round by ninety degrees, and attempt the envelopment of the Allied left. That order was to be executed upon the morrow.\*

Upon Thursday, the 3rd, news was obtained from the Allied air service that the 1st German Army was no longer facing south-west but south-east. It was clear that General von Kluck intended now to strike, not towards Paris, but against the left wing of the Allies, and especially the point of junction between the British and the French south of the Marne.

The position upon that day, Friday, 4th September, may be appreciated in

\* It would be confusing to dilate here upon the question as to whether the German right wing under Kluck would in any case have swerved thus round to the left and turned south-eastward whether the Grand Couronné had held out or no. It is true that it was the business of the Germans to fight the Allied Army in the field, and not merely to menace Paris "a geographical area;" but it is certain that if Kluck had known what large forces could be gathered between him and the capital, he would not thus have turned and exposed his flank to the attack of those forces. In other words, the strength of the 6th Army upon that flank, both in numbers and in activity, was a surprise for him.

the sketch map 39. The 5th French Army was in the region marked 5 upon the map, the British Army in the region marked E. Kluck had hitherto been advancing (with the British retreating

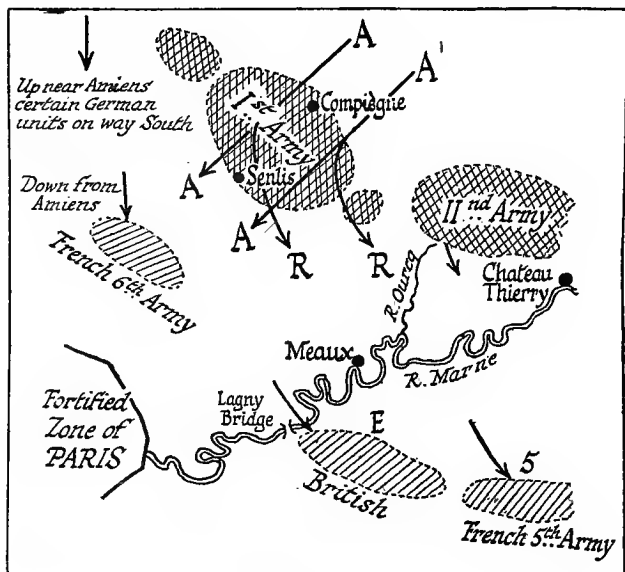

Sketch 39.

before him) in the direction of the arrows AA.

He knew that there were forces of some sort—the French 6th Army—between Paris and himself. For in the neigh-

bourhood of Amiens his extreme right, some days before, had come across those forces, and he knew that they had retired southward toward the capital. But he had no conception either of their strength or of their remaining fighting power ; for upon this Friday, the 4th, his whole movement was swerving round in the direction of the arrows RR, clearly intending to pass the Marne and to strike the British Army and the French 5th Army, and especially the point of their junction. Victorious in that region against what he believed to be the weak, attenuated extremity of the French line, and neglecting the British contingent, which he believed wholly exhausted, as well as the French 6th Army between Paris and himself (which he believed to be not an army but a detachment, insignificant in numbers and also exhausted), he would get right round the end of the whole French line, and a huge enveloping movement, a half circle with its wings 150 miles apart, from in front of Nancy to his own positions, would, like a great net, be curling round the French armies. He was the marching wing of what, as I have said,

was to be another Sedan, but a Sedan upon a gigantic scale not of six miles but two hundred.

The French, who knew both the extent and the remaining combative power of their 6th Army, perceived that with Kluck's swerve the opportunity had come for the counter-offensive.

Here was the whole 1st German Army marching right across the front of the French 6th Army. It would, of course, leave something to protect its flank, but that something would hardly be strong enough to withstand the shock which the 6th Army was prepared to deliver. If Kluck could be allowed to get right away southward beyond the Marne, the French 6th Army could strike in behind him, cut his communications, and envelop him, marching across the river Ourcq towards Château Thierry. In the mind of the French command the situation that should have developed about the 5th of the month would be something like that upon the accompanying sketch 40, with the mass of Kluck's Army (I.) and the mass of the 1st German Army (II.) well south of the Marne engaged by, and (to use the French



Château Thierry, and so get right across behind the two German armies, and cut their communications. The whole German right wing, the extremity of their line, would be destroyed.

Things did not turn out so favourably as that. That was only the fullest harvest of the victory conceivable. Part only was gathered.

It is clear that everything depended upon the surprise effected by the unexpected strength of the 6th Army.

But when one comes to see what the strength of that 6th Army was, though it was greater both in fighting power and in numbers than Kluck imagined, yet we find it hazardously weak for the work it had to undertake.

The French 6th Army on that day, Friday, 4th September, consisted as yet of a nucleus only. Its other component parts were still in the act of arriving while the battle was in progress. Its last units could not come up until the action was already decided.

What its size was, and how far it might be expected to accomplish its perilous task, even with the advantage of surprise,

what proportion it bore to the forces in front of it, etc., we shall see in a moment.

Upon this Friday, the 4th of September, General Galliéni, commanding the army of Paris, and entrusted with the defence of the city, summoned General Maunoury, commander of the 6th Army, and conferred with him the whole of that morning. The two generals went off after this conference, about a quarter-past noon, to the British headquarters at Melun, in order to discover what the dispositions of the British Army would be upon the morrow ; an essential point, of course, in the whole scheme. For unless the advancing forces of Kluck were engaged and held, they would return when they saw that their communications were being attacked in strength by the French 6th Army, and the plan might end disastrously.

There is at this point a matter of discussion which only the future historian, with ample material at his disposal, will be able to debate, let alone to settle, and which I only mention here because, were I to omit it, there could be no understanding of what followed.



It was evidently the judgment of the British command that the reorganization of their forces for the offensive, and the important work of getting into full touch on their right and left with the two French armies, the 5th and the 6th, which were their neighbours on either hand, would take so much time that the plan would not be mature for at least forty-eight hours. The French command of the army of Paris worked for the opening of the business not in forty-eight hours, but in twenty-four. From the one point of view the hitch which followed could be laid to delay; from the other, to premature action. Which party may have the advantage in this debate of detail only the future, I repeat, can show. It may even remain, as do so many details of military history, a matter of undetermined discussion.

At any rate, the French 6th Army, it was decided, should show its strength, and attack suddenly in force to envelop Kluck on the next day, Saturday, the 5th; though by the evening of that day the British forces would still be in the region of Rozoy, and not yet free to

engage and hold the much larger German forces in front of them.

The action of the Ourcq and the Morins begins, then, at midday of Saturday, September 5, 1914.

Our first business is to appreciate how the opposed armies stood at that precise moment. It is for the purpose of understanding this that I append the following plan, 41. In this plan I omit the IInd German Army (to the left of Kluck) for the moment, and the 5th French Army facing it, since all the critical work of the opening of the battle concerns the extreme west alone, and particularly the struggle between the 6th French Army and Kluck's original, and later rapidly reinforced, flank guard.

General von Kluck, then, on this Saturday, the 5th of September, at about midday, had already brought the great mass of his forces well south of the Marne, prepared to deliver his great blow upon the morrow. This great mass of his forces consisted of three army corps, some of them perhaps strengthened by an extra third division. These three army corps were, in their order, the IInd Active,

the IVth Active, and the IIIrd Active. To these we must add the IXth Active, as to which we are not actually certain yet whether it was under Kluck or under

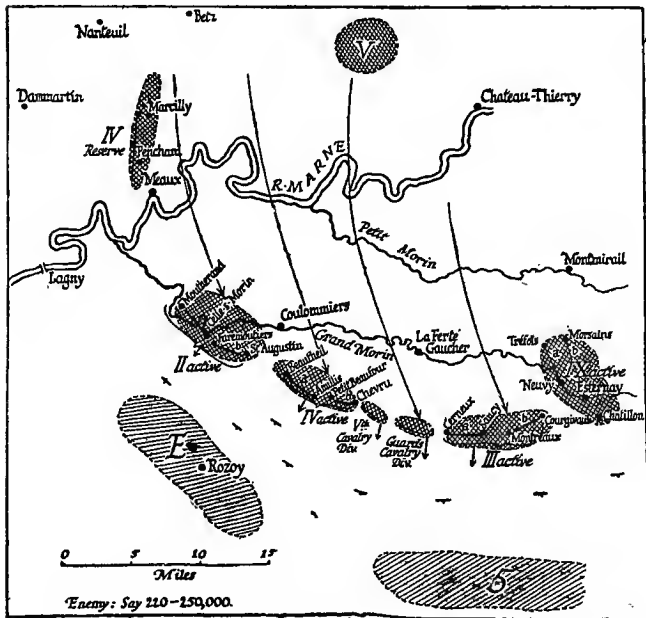

Sketch 41.

his neighbour Buelow, to the east, and we must also add, in a gap between the IIIrd Active and the IVth Active, two cavalry divisions, the Vth Cavalry Division on the left wing of the IVth Active

Corps, and the Cavalry Division of the Guard on the right wing of the IIIrd Active Corps. We must, of course, conceive of this great force (not far short of 200,000 men) as screened for a long way in front by bodies of cavalry, some of which are said to have extended almost to the Seine, fifteen miles away from its main front.

Opposed to this great army were the little British force at E, in the region of Rozoy, and (after a certain interval, to the east of it) the western portion of the French 5th Army.

It will be seen that this host of Kluck's roughly corresponded in its arrangement with the valley of the Great Morin, a stream which flows down through, and profoundly cuts, the plateau of this region, and joins the Marne a little below Meaux.

Kluck, in effecting this rapid march southward for the destruction of the Allied left wing (a march directed along the lines of the arrows on Sketch 41), knew, as we have seen, that there was a certain force (though he believed it to be a very small and thoroughly exhausted one) behind him, and upon his flank in the region

of Dammartin. Greatly as he underestimated it, it was none the less necessary to prevent the attack of even such a body upon his communications. He had, therefore, left behind him rather less than a fifth of his forces in the shape of the IVth Reserve Corps spread out in the region of Penchard, Marcilly and the neighbouring villages to the north of Meaux, parallel with, and some eight miles to the west of, the Ourcq River. This IVth Reserve Corps was to act as a screen, and to thrust back whatever the French might there bring up.

As we know, what the French were prepared to bring up there by way of surprise was their 6th Army, and that 6th Army they launched, as I have said (perhaps a little prematurely), at midday of that same Saturday, the 5th of September.

It next behoves us to consider in detail what strength that 6th Army could already summon, and then we shall be in a position to appreciate the extent of its task, the nature of the risk it ran, its peril two days later, its ultimate success, and the difficulties in the way of that success.

*The Real Composition of the French  
6th Army.*

The French 6th Army at this moment was not *yet* what so many accounts have described it to be in their relation of the Battle of the Marne.

We should suffer from a profound misconception, falsifying all our judgment of the battle, if we thought of it as a fresh and vigorous force, vastly outnumbering the German IVth Reserve Corps, and prepared to fall with unexpected and overwhelming strength upon the communications of Kluck. The German IVth Reserve Corps left to protect those communications consisted, it is believed, of only two divisions. But there may have been, as was so frequently the case with the German organization during the great advance, extra forces present with it. At the least, it consisted of a full army corps of two divisions which had enjoyed a triumphant though very rapid advance, had lost nothing to speak of in strength, and was a body carefully chosen for its excellence in the important task of protecting the flank and rear of the Ist German Army.

It lay, as we have said, north of Meaux, over a stretch of territory about six miles in extent.

On this midday of Saturday, the 5th, the French had ready for work against this excellent German body four divisions and a brigade ; on paper, the double of their opponent. In reality these four divisions and a brigade were very little superior in number to, and had been far more severely tried both in losses and fatigue than, the IVth German Reserve Corps, which they were just about to attack. These four divisions and a brigade consisted of two main groups. The first, under General Lamaze, were the 55th and 56th Division of Reserve, with, on their right, an infantry brigade from Morocco. The second, under General Vautier, were the 14th and the 63rd Division, grouped under the name of the 7th Army Corps.

This corps lay stretched in line on the morning of 5th September, from somewhat north of Dammartin to the plain north of the village of Claye. It had been separated the day before by about five miles from the mass of the German flank

## 180 A GENERAL SKETCH OF

guard, the IVth German Reserve ; but the cavalry had taken contact, and the IVth German Corps at the moment when the action began had come forward from

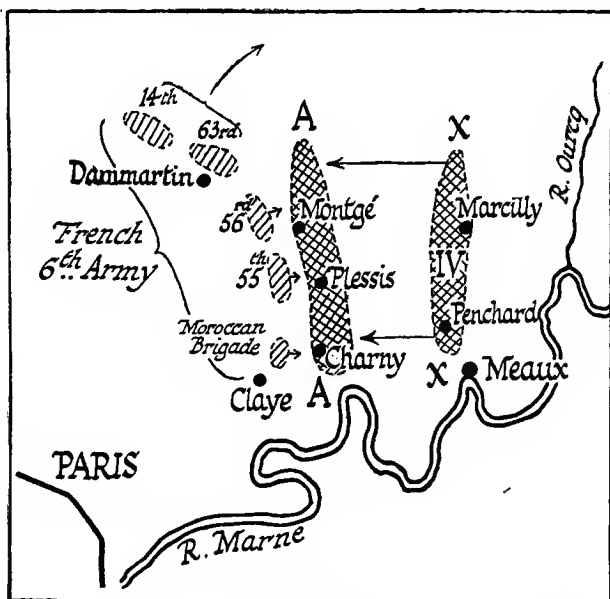

Sketch 42.

its old positions at XX to about the position marked AA upon Sketch 42.

We have just seen that the paper strength of the French 6th Army thus assembled to attack the German flank guard, and to get, if possible, upon the



communications of Kluck, was superior to the enemy in this region. You had nominally four divisions and a brigade (a Moroccan brigade) attacking a force of possibly more than two divisions, and certainly not the strength of three. But the French four divisions—the 14th, 63rd, 56th, and 55th—had had a very different experience in the last few days from that of the victorious German corps in front of them. They had all four been engaged in the eastern fighting; had suffered very heavy losses; had been sent round by rail to the neighbourhood of Amiens; had reached that neighbourhood in the last days of August only just in time to take the shock of the German flood, and to recoil from it. They had come down south by long marches, and had only just arrived in this region before Paris and north of Meaux in time for the counter-offensive that was now about to develop.

It may be asked why, with this insufficiency of force, so great a task as the envelopment of the whole of Kluck's army, and the cutting of his communications, should have been attempted.

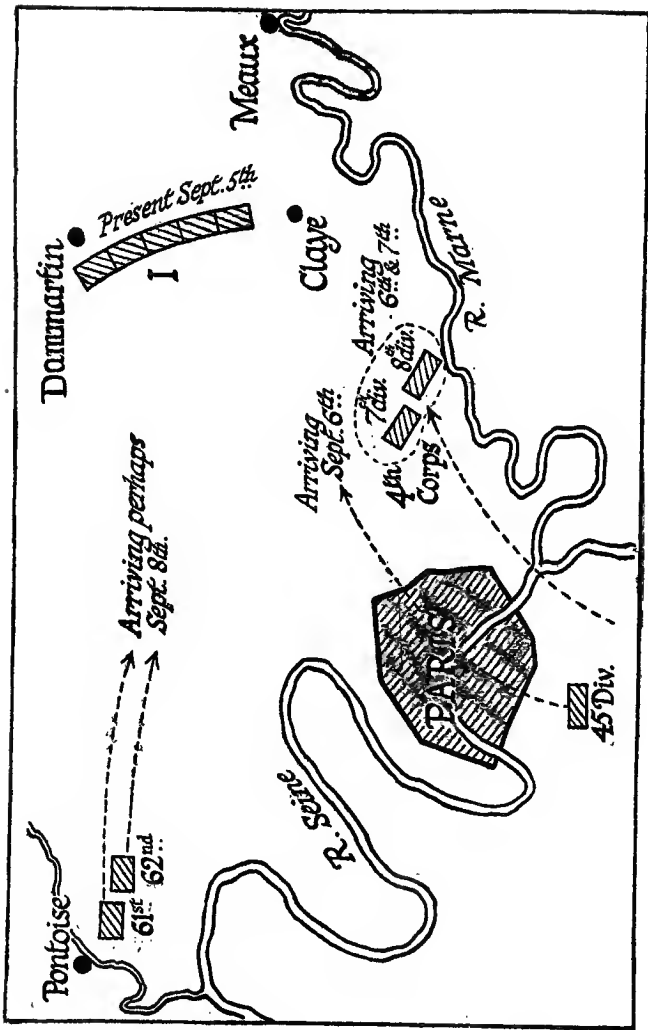

Sketch 43.

The answer is that, though not yet present upon this 5th of September, there would appear upon the battlefield at successive stages considerable reinforcements which, it was hoped, might in one day more—which did, as a fact, within three days—muster an imposing number upon these plains. That those forces were not yet actually present, but only in process of arrival, lends some colour to the thesis that the attack undertaken at midday of the 5th was premature.

In order to understand what these extra forces were, I must beg the reader to turn to a sketch here appended, 43, which will help to give some general conspectus of the situation.

We have, in this Sketch 43, the force actually existing between Dammartin and Claye at midday on the 5th of September. This force I have marked I. It consisted, as we know, of four divisions and a brigade.

Twenty miles away, round about Pontoise, there had arrived the day before two divisions, the 61st and 62nd of Reserve, coming back in full and hurried retreat from the extreme German forces which

had been pursuing them down from Amiens, but which had since rejoined, for the most part, the mass of Kluck's armies. These two divisions, the 61st and 62nd, were, by the French official report, in a very bad case, as might be imagined, broken with fatigue, vastly reduced in numbers, and perhaps suffering somewhat in essential organization as well. It might be hoped, however, that they would appear upon the field of battle north of Meaux before the action should close, though they certainly could not be there for three or four days.

Next, there was expected the 45th Division, which had been organized south of Paris, which crossed Paris during that day, the 5th, and might arrive upon the field of battle before the conclusion of the 6th.

Lastly (and much the most important reinforcement) was the 4th Army Corps, under the command of General Boëlle. It consisted of two divisions, the 7th and the 8th,\* in good condition, men of an

\* A French army corps is nominally composed of two divisions bearing numbers the highest of which is double that of the army corps. Thus the 1st Army Corps is composed of the 1st and 2nd Divisions; the 2nd Army Corps, of the 3rd and 4th Divisions. This

active corps and a firm support, to be thrown into the battle when it should have developed.

Unfortunately this fourth corps could not be present in the region of Meaux (where battle, as we have seen, had already been joined by midday of the 5th) until long after the strain had begun to tell. They also were being sent round from the east, from Lorraine, to complete the "Mass of Manœuvre." But it was impossible to deliver them in the neighbourhood of Paris much before the 7th, though the first units had begun to detrain a day's march west of Meaux just before the action began. If we add up all these reinforcements, we find that the original force with which the battle began between Dammartin and Claye is more than doubled. To four and a half divisions we add five. But of these five two (those from Pontoise) are in a bad way; while the other three

4th Army Corps was therefore composed of the 7th and 8th Divisions. We saw above that the 14th and 63rd Divisions were bracketed together as the 7th Army Corps under Vautier; but this anomaly was due to the fact that the 13th Division, normally part of the 7th Corps, had been kept in Lorraine and had been replaced by the 63rd Division of reserve.

can only arrive from a day to three days after the opening of the battle.

To these reinforcements ultimately available may be added a number of "frills," to be counted before the end under the command of the 6th Army, but affecting its action in little or nothing save in the case of the Zouaves. Two and a half battalions of this corps were thrown in at the very end of the battle, just in time to be of some effect.\*

There was a considerable mass of cavalry, but of little service both from the nature of the action and because it was exhausted at the end of the long retreat. It played no part. There were over thirty extra field pieces pushed in on the second day of the battle from some reserve, and there was a very remarkable body, a brigade of marines, which two months later acquired very great fame at Dixmude, but was as yet not sufficiently organized or trained to be put into the fighting line, was kept as a reserve only, and had no effect during the battle.

\* Roughly speaking, and on paper, one might count a division as nearly 20,000 men at this stage; a battalion at a thousand.

All that afternoon, the 5th of September, the four divisions and the brigade under Vautier and Lamaze, the whole commanded by Maunoury, were engaging the IVth Reserve Corps of the Germans.

The heaviest fighting was that undertaken by the 56th and 55th Divisions, and the brigade from Morocco. These three columns, attacking the mass of the Germans entrenched upon the heights from Montgé to Penchard, achieved but little before nightfall. They carried Montgé, on its hill, but in the plain below the heights reached no farther than Plessis aux Bois and Charny. It was the 56th Division which carried Montgé, the 55th which reached Plessis, and the Moroccans who established themselves at Charny that evening. Meanwhile Vautier's group, the 14th and 63rd Divisions, under the name of the 7th Army Corps, were occupied that afternoon against less obstruction in marching eastward across the plain, with the object of turning the German line of resistance by the north.

On this, then, the evening of the first day, the results were as follows:—

188 A GENERAL SKETCH OF

Lamaze's group of two divisions and a brigade had advanced with some difficulty over a belt of a few hundred yards

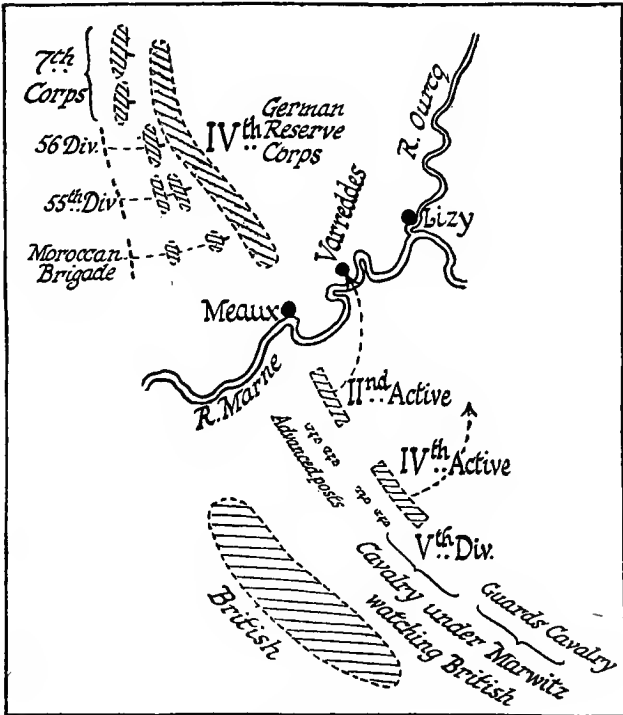

Sketch 44.

to a mile (see Sketch 44), and still had the main positions of the German IVth Reserve Corps to tackle.



But meanwhile Kluck had appreciated within a very few moments of the first attack at midday on that Saturday that the 6th French Army, under Maunoury, was stronger than he had imagined, both in numbers and in fighting power.

He at once began to recall his troops from south of the Marne, and to change the whole character of the battle.

It is here that the vital importance of the discussion between the delay south of the Marne or premature action north of it by the Allies comes in. If Maunoury had not attacked until the British force had been at grips with the German forces south of the Marne, or if the British could have attacked those German forces south of the Marne and held them contemporaneously with Maunoury's attack, the partial German success we are about to follow would have been impossible.

As it was, the mass of the German troops south of the Marne were disengaged, and free to return at a moment's notice, and Kluck, taking immediate advantage of this lack of synchrony upon the part of his enemy, and acting with a rapidity and decision worthy of

the highest admiration, left his two cavalry divisions to form a screen (under the unfortunate and stupid Marwitz), watching the approach of the British, and recalled his II<sup>nd</sup> Active Corps across the Marne to help the IV<sup>th</sup> Reserve Corps, which was at grips with the French 6<sup>th</sup> Army.

If the reader will turn back to Sketch 41 on page 175, he will see that this Active Corps II. was the nearest to the river northward of which the IV<sup>th</sup> Reserve Corps was with difficulty holding its own.

All the late hours of Saturday, the 5<sup>th</sup> of September, its columns poured northward towards the Marne, and by day-break of the 6<sup>th</sup> they were across the river, one division coming up through Varreddes, the other through Lizy.

All during that blazing Sunday Lamaze's two divisions and the Moroccan brigade, whom now the 45<sup>th</sup> Division had joined, pressed back the German IV<sup>th</sup> Reserve Corps, in spite of their favourable position upon the heights. They carried the heights in the course of the morning, and by night held a line running from Chambry to Acy, in the deep ravine of the

Gorgogne. While during that same morning Vautier, with the two divisions of the 7th Corps (the 13th and 63rd), was turn-

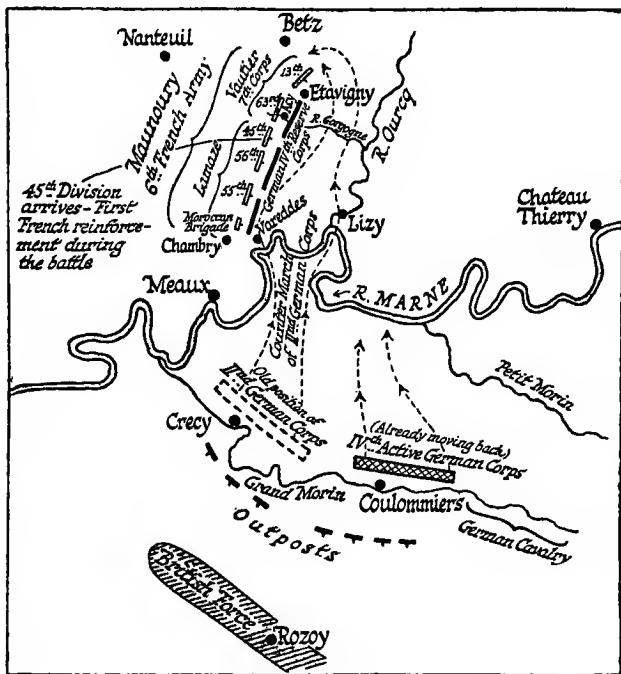

Sketch 45.

ing the German line with ease in the neighbourhood of Etavigny.

There seemed little to stop them. All the German IVth Reserve Corps together was, now that the French 45th Division

had come up, less than half its opponents. The Ourcq would have been crossed next day, and Kluck destroyed, *had it been possible for the British to engage and hold the Germans south of the Marne.*

As we have seen, this was not done. The IInd German Corps was recalled; and long before Maunoury's 6th Army had achieved anything decisive north of Meaux upon that Sunday, this same IInd German Corps had marched back its eight miles; it had crossed the Marne at Varreddes and at Lizy, and was appearing right upon the flank of Vautier.

So that Sunday ended. The French surprise was no longer a surprise. The French 6th Army no longer outnumbered its opponents, but was already beginning to be itself outflanked. Should Kluck be permitted the next day to bring up yet more troops from beyond the Marne; should his forces in that region be left unmolested for a few more hours; should, as was probable, the French reinforcement of the 6th Army be still somewhat delayed, it was well upon the cards that Kluck would have turned the tables. He might be enveloping Maunoury in his

turn, and become, though under circumstances not foreseen, the victor in front of Paris. . . . Meanwhile, far off to the east, in the centre of that hundred-mile line of millions, the tremendous attack had already been launched against Foch; and if Foch broke, the envelopment of the French 6th Army alone would be something more than a local disaster. It would be part of a vast movement isolating the whole western half of the Allies, and shutting them up in Paris.

The first phase of the Battle of the Ourcq we leave thus, with the fall of that Sunday night, the 6th of September.

Upon the 7th of September, Monday, the third day of the struggle, the three great elements deciding it appeared more clearly than ever. First, the German Army south of the Marne was not even yet engaged by the British, and was, therefore, free to get away northward and to help its comrades. Secondly, the French 6th Army, so far from being able to push the reinforced Germans back eastward, could barely hold its own. And thirdly, it was a sort of race between the

French and the Germans which could bring their reinforcements up quickest.

We have seen how, of the German reinforcements, the II<sup>nd</sup> Corps, that nearest the south of the Marne, had recrossed the river, and had appeared upon the north of the IV<sup>th</sup> German Reserve Corps the day before, the 6<sup>th</sup>. The corps next farthest along, the IV<sup>th</sup> Active Corps of the Germans, had also been on the move all that day, the 6<sup>th</sup>, and was crossing the Marne on the 7<sup>th</sup>. It would shortly appear in the field, bringing overwhelming superiority against Maunoury. It was urgent for the French command to reinforce that general. One of the tired and badly broken divisions from Pontoise—the 6<sup>1st</sup>—was got up on the evening of the 7<sup>th</sup> by train; and after dark there had also come in, partly by the curiously ingenious commandeering of motor cabs from Paris, partly by train, one division of the newly arrived 4<sup>th</sup> Army Corps—the 7<sup>th</sup> Division, which had disentrained that afternoon. None of these reinforcements, however, were available during the day of the 7<sup>th</sup> itself for the fighting. The result was that the original force of

Maunoury, having now fought for three days largely on the offensive, and against troops increasing in volume, was getting tired out, as well as suffering from very heavy losses. When morning dawned upon Tuesday, the 8th, it was clear that

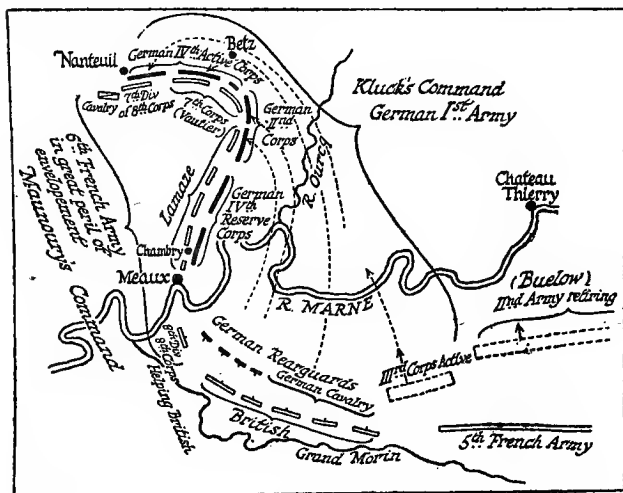

Sketch 46.

Maunoury's army was in increasing peril—for early that morning the German IVth Active Corps appeared upon the scene! The position at this moment, the morning of Tuesday, 8th September, the fourth day of the struggle, was that indicated upon the above sketch.

The French 7th Corps, under Vautier, was badly bent back in front of Betz. In the Lamaze group reinforcement had brought no greater strength to the fighting line, because the new divisions that had come up only relieved the exhausted 55th and Moroccan Divisions, which were at the end of their tether. While this Lamaze group was forcing its way painfully forward, and had carried Chambry, the IVth German Active Army came up that morning of the 8th, and all the German mass was now present, outnumbering and vigorously attempting to envelop Maunoury's command. Into the positions which the IInd German Army Corps and the IVth Active had abandoned south of the Marne, the British that day advanced across the Great Morin, still watched by the German screen of cavalry which fell back before them. But they had not yet reached the Marne, and were not yet, therefore, any appreciable menace to the flank and rear of Kluck's men, who were in process of enveloping Maunoury. The British advance, and that of the 5th French Army to its right, had for effect upon this day



the falling back of the one remaining German army corps which had stayed south of the Marne—to wit, the IIIrd Active, and had consequently caused the neighbouring wing of Buelow to fall back also. It was clear that when the British should reach the Marne and cross it, Kluck would have to make the troops just north of Meaux fall back eastward and northward, to avoid envelopment; but that need not prevent Kluck from accomplishing, in the time he still had before him, the ruin of Maunoury's army.

All that Tuesday, the 8th, the half-encircled French fought desperately from Chambry, right away round by the northwest to near Nanteuil; but they accomplished nothing save the bare maintenance of their positions. The German heavy artillery, under such circumstances of an almost unchanging line, was for once efficacious in the field, outranging, of course, the French field batteries; while, not having to move much, its chief defect, immobility, did not encumber it. When night fell upon the 8th, the French Army already thought it prudent to consider the possibility of retreat. Of the two

divisions from Pontoise, one had already come into the fighting, the second was brought up to stand in reserve for the covering of that retreat, and in general the prospects of the following day, the 9th, were less favourable to Maunoury than those of any period hitherto in the long-drawn action. The French had no more men to throw into the fighting line; the three German corps—more than six but less than nine divisions—had almost succeeded in turning them, and might succeed on the morrow. If the British could cross the Marne early upon that morrow, the 9th, they might conceivably catch Kluck's left wing. Even that was unlikely, because, should the British succeed in crossing the Marne as a whole body, Kluck would presumably withdraw his left wing in time, and would still be perfectly free to defeat Maunoury by the action of his right, and of the IVth German Active Corps.

On Wednesday, the 9th, the British did reach the Marne. Their right and their centre crossed to the northern bank of the river from midday onwards; but their left wing, which was the body essen-

tial to the threatening of Kluck's IVth Reserve Corps (and which, therefore, Kluck determined to delay as long as possible), was held up at La Ferté-sous-Jouarre, at the mouth of the Little Morin. That day, the fifth day of the fighting, was so critical for Maunoury, that when one obtains from eye-witnesses an impression of the French 6th Army at the moment, it is clearly an impression of approaching disaster.

Many of the officers and men had not eaten for two days, not from any breakdown of supply, but from the continued violence of the struggle. The losses had been very heavy indeed, and at the close of this most critical day certain German bodies, not of great military value, it is true, but threatening on account of their direction and position, appeared from the extreme north, where the last detachments of the great German march from Belgium had been lingering, and whence they had been summoned by Kluck to appear at this critical moment on the battlefield of the Ourcq.

The situation just after sunset of that Wednesday, 9th September—say, shortly

before seven o'clock in the evening—was that of the accompanying sketch map, 47.

The British were closing in, and had almost entirely crossed the Marne, even their last bodies, the left wing, being prepared to cross early on the morrow. The

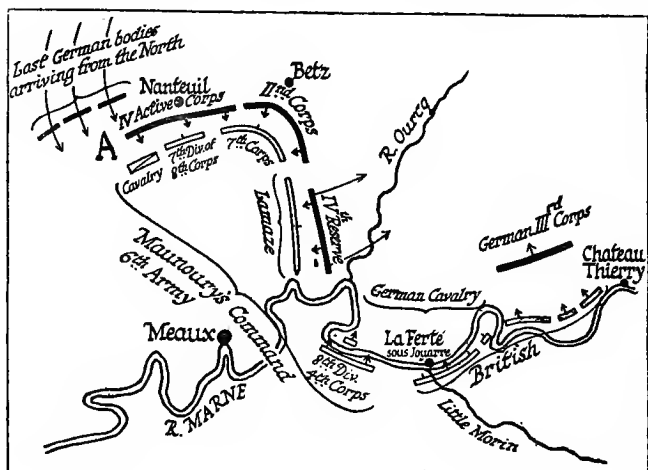

Sketch 47.

8th Division of the French 4th Corps, which continued the British line towards Meaux, was also crossing the river. The German IVth Reserve Corps would, therefore, certainly have to fall back on the morrow in the direction of the arrows. *But all this local retirement of the Germans*

*just east of Meaux would mean nothing to the result of the battle so long as the extreme German right at A still pressed, and was still able to turn, envelop, and push back the inferior and now bending French line.*

The morrow, the 10th, might bring disaster.

Yet when, with the first light of that morrow, Thursday, the 10th of September, the command of the French 6th Army made its first effort to discover how the enemy's line stood, it found with surprise that the right wing at A had disappeared. Nanteuil, from which the French had been thrust back in that great turning movement, was abandoned; not only the IVth Corps of Reserve, which would have had to fall back in any case, and whose retirement would not have affected the issue, but *all* Kluck's acting and fighting line, the IVth Reserve Corps, the IInd Active, and the IVth Active, were every one of them pounding off at top speed to the north, and the task remaining to Maunoury's army and to the British was simply that of pursuit.

What had happened to produce this revolution?

What had happened was the victory, the decisive action, of Foch in the centre, fifty miles away.

Upon that same day, the 9th, which had seen the extreme peril of the French left and the suffering of its chief strain, in the middle of the afternoon Foch had launched

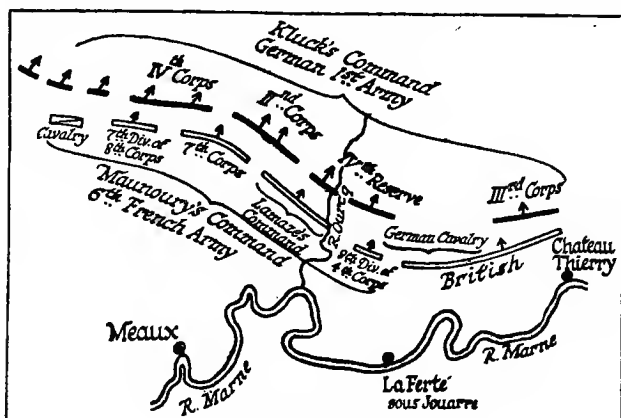

Sketch 48.

his decisive movement. Kluck had known by five o'clock that the hitherto victorious pressure of his colleague to the east was checked. By nightfall he knew that the German centre was routed, the line pierced, and an immediate and general retreat ordered. By the morning of the 10th his share in that retreat was already in full swing.

We will, therefore, next turn to the third and deciding factor in this enormous struggle, the action of Foch with the Central German Army, which may be called "The Battle of La Fère Champenoise;" omitting as incidental to the whole, and as more properly studied at the conclusion, the action of the intervening forces.

### III.

#### THE BATTLE OF LA FÈRE CHAMPENOISE.

The third of the three great factors deciding the Marne, the latest and the conclusive one, was the central Battle of La Fère Champenoise, delivered by Foch against the Prussian Guard and the Saxon army.

It is, of all the separate actions in this great campaign, the most important historically. It is, again, of all the great actions in the war, that one the general character of which is easiest to grasp; for it was decided by one single bold and successful manœuvre. Unfortunately, it is also, as we shall see later, that one of all the actions of the Marne most difficult to establish in detail.

The description which has just been laid before the reader of the Battle of the



Ourcq would leave a false impression upon his mind were it to stand alone.

He has just followed the story of a surprise French attack in flank upon the extreme German right, which rapidly became (either because the French attack

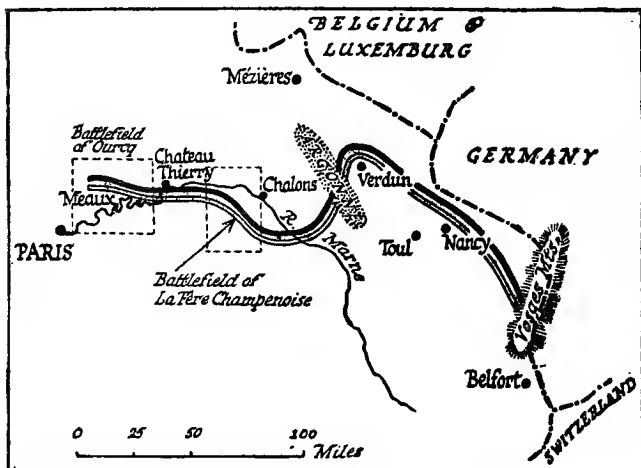

Sketch 49.

was premature, or because the British advance south of the Marne came too late) a battle in which the French under Maunoury, seeking to imperil the Germans under Kluck, were in their turn gravely imperilled, confronted by larger and larger forces as the four days of extreme strain

proceeded ; and at the end of these, upon the evening of the 9th, came within an ace of serious defeat.

We have also seen how, just in the most hazardous moment, the army of Kluck, which had till then only drawn in its left while actually extending and pushing forward its right, suddenly retired as a whole ; so suddenly that the movement might be called precipitate ; so suddenly that it was surely the result of some unexpected news received and acted upon in a moment.

The story, read thus isolated, might suggest that the Battle of the Ourcq was a blunder, or at any rate a failure, of the Allies, only set right by other action of theirs elsewhere. Such a conclusion would be the exact opposite of the truth.

The Battle of the Ourcq, even if history should prove (which is doubtful enough) that it was launched prematurely, was but a fragment of one general plan, all of which worked out to a sufficient conclusion. Those who fought at such hazards north of Meaux under Maunoury upon the 5th, 6th, 7th, 8th, and 9th of September, 1914, played the part which the trigger

plays to the discharge of a weapon. It was their action which made possible all that ensued, and without running the risk they did the Battle of the Marne could not have been won.

For had not the Ourcq been fought in the fashion we have seen, that disarray of the German centre twenty leagues away would not have taken place, and the genius of Foch would have found no ground for action.

As it was, the Ourcq acted, to use the French metaphor, "like a leech." The 6th Army, drawing towards it as it did back and right westward five-sixths of Kluck's forces, drew also westward in retreat to save a gap all the right wing of the IIInd Army, Buelow's, which lay to the east or left of Kluck's. Such a retreat in such a direction further called after it, or at any rate loosened and weakened, the structure of Buelow's left; and therefore it was that beyond Buelow's left, in a region fifty miles away from the Ourcq, where the plateau of Sezanne falls sharply upon the vast stretch of Champagne, the German commanders of the centre were confused in decision.

Whether they ought to bear also by the left, and secure, above all things, the unbroken continuity of their line of battle, or whether, at the risk of opening a gap, they were to attempt by concentration to win through at their own central point—this divergence of objects clearly confused and bewildered the central commanders of the enemy.

Hausen, in command of the German Saxon Army, at the centre (or possibly the commander of the Guard with whom he acted), decided, as we shall see, for the second alternative. He, or they, decided, perhaps, a little too late, and certainly in a fashion hurried and confused. We shall see that the blow struck was heavy. We shall see that it nearly succeeded. We shall see that had it succeeded, the Marne would have been a final and immediate victory for the enemy. But we shall also see that the decision so taken was fatal ; that it threw open a gap in the German line ; that the calm but very rapid vision of Foch at once detected its opportunity, and that his lightning swing round into that gap from the left, acting upon the German central army as a blow upon

the temple will act upon a man, stunned it, and broke it. That blow delivered, the Battle of the Marne was won.

One may here usefully repeat and emphasize a diagrammatic illustration with which the reader is already familiar. Here, from A to B, is the German line of the

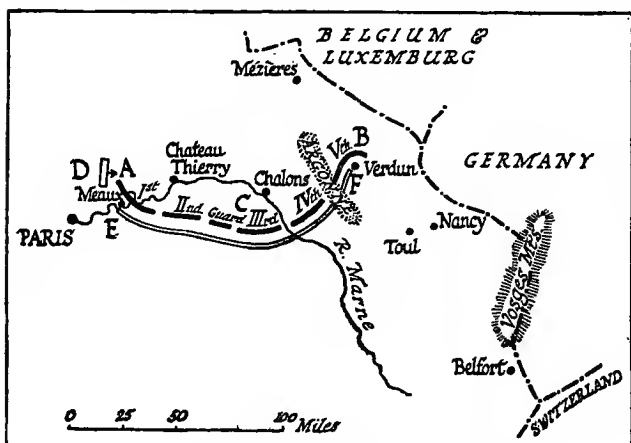

Sketch 50.

Marne, 120 miles long, from Meaux to Verdun, organized in its five armies, numbered from left to right, with the Guard and the IIIrd Army at its centre, C. There stretches in front of it from E to F a known enemy force. There, suddenly and unexpectedly, strikes upon

## 210 A GENERAL SKETCH OF

the flank guard of the 1st German Army at D the force under Maunoury along the direction of the arrow. As a result, the extremity of the German line near A takes on, with the object of enveloping and defeating Maunoury, the form

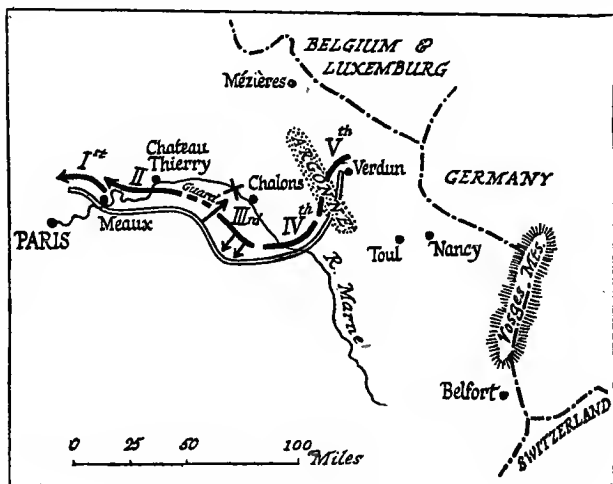

Sketch 51.

it shows in this next sketch, 51. Army I. has not only changed its shape, but inclined heavily to the left. Army II. has itself to fall back to the left, lest a gap should appear. Army III. and the Guard at the centre, left thus forward, and with a dangerous thinning appear-

ing between it and Army II., had to decide whether also to bear up to the left, extending its line and, therefore, weakening itself, or to concentrate (at the risk of leaving a gap) and to strike a heavy blow in the direction of the arrows, hoping thereby to break the centre of the opposing line. It does force that centre back, but its opponent takes advantage of the increasing breach at X, strikes in there, and achieves an immediate local victory. The German Army III., the central army at C, has no choice but to fall hurriedly back with heavy loss if it is to escape destruction, and the whole line beyond it, Army II. and Army I., has no choice either but to retire or be isolated. The whole line, therefore, retires, its offensive power is broken, and the Battle of the Marne is won.

Having thus set down the main principle of the central battle, called after the name of La Fère Champenoise, we will now turn to its fuller history. Before undertaking which, however, I must again repeat that, while we have a clear grasp of what happened—that is, of how the

victory was won—the details of the units, especially upon the enemy's side, their actual movements, the extent of their confusion, are all singularly obscure. No official sifting of documents and evidence has yet been given to the world. No one has yet been allowed to consult the notes, the examination of prisoners, the captured enemy documents, the military correspondence, etc., on which alone could be based a clear account of the battle. No competent authority has yet dealt with it as General Bonnal, for instance, has dealt with the Battle of the Ourcq ; and even upon such elementary points as the names and numbers of the corps in Hausen's command, let alone their movements, there is still, after eighteen months, a tangle of conflicting statement.

The movements upon the French side are, of course, better known. We must, as best we may, combine these with the observed, implied, or supposed movements upon the enemy's side, and so attempt a fairly consecutive description of the action.

First, then, for the line of battle in the French centre. The French centre con-



sisted, as we have seen, of a new army, part of that "Mass of Manœuvre" upon which the French strategical theory relies. It was first grouped about a week before it came into action at the Marne, and was given, as we know, to General Foch, whose work upon the principles of modern war had already rendered his name familiar to the enemy.

General Foch had under his command the equivalent of three corps only. He had the two divisions of the 9th Corps and the two of the 11th Corps, and he had a heterogeneous body composed of the admirable and famous 42nd Division, with a Moroccan Division added to it.

With these six divisions alone—the equivalent, as I have said, of three corps—he had to fight his battle. There were at his disposition, it is true, two reserve divisions, the 52nd and the 60th, not part of the active formation, and kept almost throughout behind the line. He had also a division of cavalry on the right which kept up the link between himself and the 4th Army east of him. But the fighting had to be done with the six divisions alone which I have mentioned.

These six divisions were spread out, counting from left to right—that is, from west to east—as follows :—

The 42nd Division stood on the extreme left, next to and within hail of the extreme right of the French 5th Army. It is important for the purposes of the battle to remember what this extreme right of the 5th French Army was composed of. It was composed of the 1st Army Corps. In the course of the battle we are about to follow it played a dual rôle, sometimes acting entirely with the 5th Army, at other times appearing rather as a support for General Foch. At any rate, it is important to remember both its number and its position ; for although it was a part of Esperey's 5th Army, it enters more and more, as the battle develops, into the fate of the Central Army of Foch, which we are about to follow.

Next to this 1st Corps, then—the extreme of the neighbouring army—came the extreme left of Foch's line—the 42nd Division ; and, closely united with it, a Moroccan Division ; and these two divisions lay, before the battle opened (say, on the evening of the 5th of September, when

Maunoury had already begun his attack fifty miles away to the west), on all those heights which overlook the upper valley of the Little Morin, where it leaves the marshes of St. Gond, which are its source. Charleville and Villeneuve were occupied by these troops, who also stretched astraddle of the great highroad marked on Sketch 52. They reached to the neighbourhood of the country house called the Château of Mondemont, which stands on a hill overlooking the marshes, and is a very important point both for observation and as a strong position to hold.

Next in order, and forming the middle of Foch's line, stood the two divisions of the 9th Corps. These two divisions lay that evening of the 5th along the south of the eastern end of the marshes of St. Gond, in front of La Fère Champenoise, and so on to a point somewhat north-east of that market town.

Lastly, the 11th Corps (principally composed of Bretons, I believe) continued the line about up to the railway, which runs northward from the junction of Sommesous, and perhaps a little beyond it.

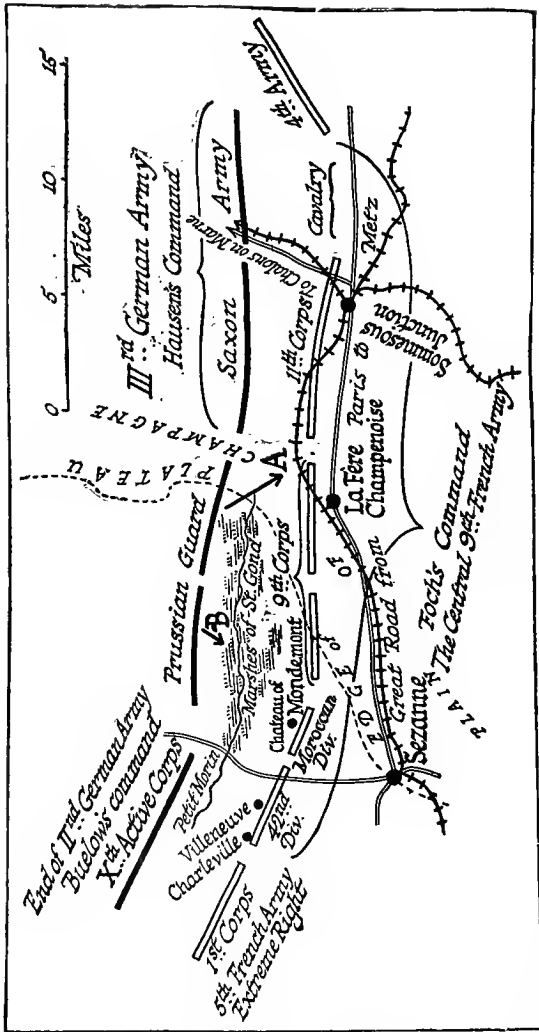

Sketch 52.

To the east of that line of Foch's we get his cavalry division watching and linking up a small gap. Beyond them is the 4th Army, with which we are not for the moment concerned.

What forces were marching against these six divisions? What was the strength of that German centre whose function it was to bear with the utmost weight against the French centre, and whose rôle, when the unexpected attack upon Kluck's flank developed, became of such capital importance?

We have seen that the breaking of the French centre or the driving of it thoroughly back, would, in combination with Kluck's rapid counter-envelopment of Maunoury, have decided the issue. It would have cut off the whole Allied left, and put it between converging forces at each end.

Foch had to meet this blow with the smallest of all the French armies. It was part, indeed, as has been said, of that "Mass of Manœuvre," the bringing up of which was the essential of French strategy; but still it was insufficient. It was going to be attacked with superior

numbers, of course, but with what superiority of number ?

This, the answer without which all our story necessarily lacks precision, cannot, unfortunately, be fully given. Our knowledge of the composition of the German central force is still very imperfect. But we can state what we *know* to have been present opposed to Foch, and thus give a minimum. We also know the nature of the Higher Command at this point.

There were marching against Foch on that afternoon of the 5th of September two distinct bodies : (1) the Prussian Guard,\* (2) the Saxon Army. So much is certain.

The Prussian Guard consists of an army corps in itself. Its active body, two full divisions, were present upon this occasion. The Saxon Army certainly consisted of three, and may have consisted of

\* In a curious way, which the superstitious may note, the Imperial Guard has done badly all through the war. When all the rest were triumphing in the rapid advance from Belgium, it got the only bad blow received—that at Guise. It was the chief victim of Foch at La Fère Champenoise, and so was chiefly responsible for the Marne. It got the worst set back of all the masses brought up against the British at Ypres.

four, army corps. There were certainly present the XIIth Army Corps Active, the XIXth Army Corps Active, the XIXth Army Corps Reserve. There may have been present the XIIth Army Corps Reserve, and in one of the most detailed and at the same time most vivid of all the accounts of the action so far available, the XIth Army Corps is mentioned as having come up in some rather confused fashion before the end of the action from the rear, not having room to deploy, or having been delayed upon the march. In one account of inferior value I have seen mention of a Bavarian corps. Whether any of these corps or all of them boasted a third division present, as was so often the case with the original German force of invasion is not, I think, known. There was, of course, a division of cavalry present, and we know that the general command of these forces, which *must* have been more than eight divisions, and *may* have been eleven, was under the command of General von Hausen, whose disgrace after the battle is one of our clearest pieces of evidence that the responsibility for their defeat at the Marne is laid by the Ger-

mans not on Kluck and the right wing, but upon the centre.\*

To the Guard and the Saxon Army, whose advance against Foch's inferior army of the centre we are about to follow, we must add in our general view one more corps of at least two divisions to the west—the extreme left—of Buelow's II<sup>nd</sup> German Army, the X<sup>th</sup> Active German Corps, which was facing the extreme right of the French 5<sup>th</sup> Army. This X<sup>th</sup> German Corps does not properly enter into the battle against Foch, but its weakness and retirement during Foch's battle largely affected the issue, as we shall see.

We have, then, the German line stretching roughly thus all along the north of the marshes of St. Gond, and eastward

\* It will emphasize for the reader the difficulty one has, *after eighteen months*, in establishing this force, to learn that the 10<sup>th</sup> edition of a summary—very accurate, though not official—published last summer, counts a reserve corps of the XII<sup>th</sup> as being present, but *not* a reserve corps of the XIX<sup>th</sup>, while three accounts of equal authority give a reserve corps of the XIX<sup>th</sup>, but *not* of the XII<sup>th</sup>. I am inclined to believe that both were present. A very valuable and conclusive source of information upon the numbers and constitution of the enemy's forces at any moment is the analysis of the early casualty lists of the enemy, which give not only date and unit, but place. But this work, though in existence, is not yet open to the public.



to beyond the Sommesous railway, facing the French central body.

In spite of our uncertainty with regard to these enemy forces, we shall be able to understand the battle clearly enough if we seize at the outset the following two capital points, both of which concern the Imperial German Guard.

First, the Guard must be regarded as an independent force. We shall only introduce an unnecessary and profitless confusion if we bother about the question whether it was commanded by Buelow or by Hausen. It was acting in reality almost as though it were an independent army between these two German forces.

Secondly, the Guard, when it came into the action, clearly yielded to the temptation of acting in two separate fields—(1) the Marshes of St. Gond, (2) the Plain of Champagne below. It did not maintain its unity of movement. *This temptation to "split" to which the Guard yielded was caused by the lack of forces just in that neighbourhood; this lack was caused in its turn by the inflection westward of all the German right when once Maunoury's "leech" effect began to tell.*

It is exceedingly important to grasp this, the gradual separation of the Guard into two groups during the battle of La Fère Champenoise, for it is the explanation of that "gap," which, opening in the German centre, decided the issue. Upon that point I will here, with the reader's leave, admit a digression which is essential to our comprehension of the affair.

### *The Gap.*

I have throughout this study emphasized, I fear to the weariness of the reader, the fundamental character of this feature. It was a gap opening in the German line here at the centre which decided the Marne.

But now that we are looking at the matter closely and in detail, I must warn the reader against a misconception.

The "gap" was not simply a large hole left in the line by forgetfulness, delay, or mismanagement.

Armies in movement do not fight in strict cords or "sticks." They are not arranged in those exact oblongs by which we conventionally represent them upon

our maps. They are dispersed over wide regions of country ; a group of men thickly gathered in one village ; thinner outposts ; smaller groups to the right or to the left, then a denser group again ; large bodies out of the firing line behind, etc.

If we were to plot down in red dots upon a large scale map the position of every single man before and during an action of movement, where neither party is permanently entrenched, the impression the map would give would be a confused one of scattered thousands of red dots, very dense in some places, very rare in others, showing roughly areas of concentration, and roughly also a general line of action, but no more.

So true is this that the modern French teaching of war no longer represents to students the old conventional oblongs upon the map, but only great "blobs," roughly oval, and marked with such signs as "2nd Corps in this region." No greater definition is attempted. The enormously detailed and painstaking huge volumes, for instance, published by the historical section of the French War

Office upon the campaign of 1793, show the movements of such actions as Tourcoing or Hondschoote in this fashion. So does General Bonnal's minute study of the Ourcq in the present campaign.

It follows from such a view of the way in which armies actually occupy country, that "a gap" in any part of a line hardly ever means the total absence of men in that part. It may do so. There have been such things in war as the complete neglect of an important section of territory, its complete degarnishment of men, and a consequent opportunity for perfectly unimpeded progress by any enemy opposed to it. But in the case of the famous gap which opened on the last day of Foch's action in front of the French, the solution of continuity was not as absolute as that.

The "gap" opened, as we shall see later, between the two sections into which the Guards Corps had gradually got separated; but the very error their commander committed is evidence of its own incomplete character. He would have seen and repaired at once a complete break. He tolerated a more and more

risky "thinning out," until he just overreached himself. You would probably have found, if you had been able to plot down the position of every man or of every small group of men in the Prussian Guard and the German forces at the critical moment of the battle—the early afternoon

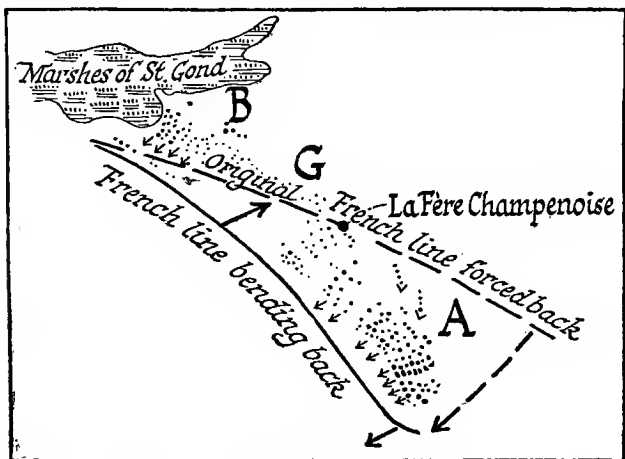

Sketch 53.

of the 9th of September—something like the accompanying sketch, where the eye clearly seizes alternative concentrations and thinning out of men, but no complete denuding of any part, and the "gap" upon and through which Foch's left-hand swing worked with such terrible

effect at G, was no more than a section in which the link between two portions of the Guard had been allowed to get excessively thin. In the heat of the violent attack against and through La Fère Champenoise there had developed far too great a concentration upon the east at A, when there seemed such a great and powerful chance of breaking the French line which the mass of the Guard were forcing back ; there had remained (on account of the nature of the fighting) too many men round B, and the "elastic," so to speak, between the two had been stretched to the utmost.

We shall see clearly upon a later page the effect of all this upon the action, but it is important at the beginning of our description to appreciate the true nature of the dislocation, and not to visualize the extreme and unreal picture of a stretch of country wholly denuded of men, through which French columns might be imagined to be penetrating on the last day of the action without opposition. The real situation was that when the time came to act in flank, the French, swinging round along the arrow, could treat the very troops

at G as though they were not there, because they were so few as to be warded off, so to speak, with one hand, and as impotent to interfere with the French flank movement as though they had not been there at all.

To this extreme weakness of what I have called the Gap must further be added the fact that the few men in that gap were not deliberately left as a minimum force sufficient to menace any French movement in front of them. They were rather men who, for the most part, were looking eastward and westward, concerned with and attached to in almost every case either the great operating mass at A, or the mass remaining at B, and were probably actually in movement towards those two masses at the decisive moment.

With so much said—the value of which cannot appear until we have seen how the action developed—we will proceed to a detailed examination of that action.

### *The Action.*

The headquarters of Foch upon the 6th of September (before his men had actually

begun the fighting, but when Maunoury had already been pressing Kluck's flank guard for nearly twenty-four hours) was at Pleurs, a mile and a half behind, or south, of the great Châlons road. From this centre the orders went out to his three groups of combat—the 42nd Division, with its Moroccan Division in aid, upon the left; the 9th Corps in the centre, and the 11th upon the right.

In the plan of the Generalissimo it was Foch's rôle during all the first part of the action to stand only upon the defensive. Since the French plan was to envelop Kluck upon the left of the line with Maunoury's army, it was important to let the German centre sag as much as possible southward in front of Foch, and for Foch to hold it there while the envelopment upon the left proceeded.

That envelopment, as we have seen in the account of the Ourcq, miscarried; because the English and Germans south of the Marne were not engaged. It rapidly developed upon the 7th, 8th, and 9th of September into a counter-envelopment of Maunoury by Kluck. In such a pass merely to "hold on" in the centre



fifty miles away (retiring if necessary, but leading on the enemy) would be fatal. It would make the left French line bend more and more round until it was enveloped at both ends, and the centre pierced. It is clear that if you catch your enemy at fault along the line CD, and proceed to envelop him at A with

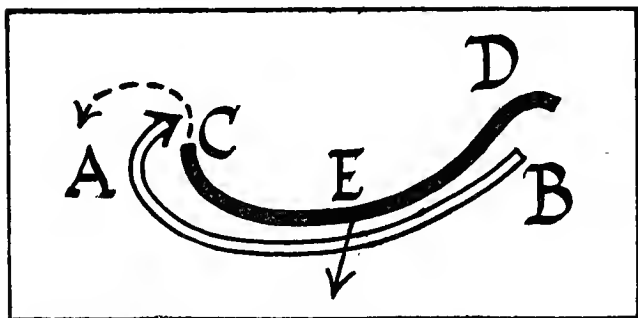

Sketch 54.

the left of your line AB, a deep bend of his forward at E is to your advantage. It gets him more "into a pocket." But if he finds out your move at A and counters (as along the dotted line), then a vigorous thrust of his at E may cut off all your left, and the sag is in his favour. Foch's rôle, therefore, once Maunoury, on the extreme left, had failed to envelop, be-

came not defensive but, so far as he could make it, offensive, as those days proceeded. He had not only to hold on, but, if possible, to break the German centre in front of him, lest the enemy should win the battle, the flank movement fifty miles away to the west having gone wrong. But to take the offensive when you are heavily outnumbered is not gay work.

At the opening of the battle, however, his original defensive function was not yet disturbed. The orders given out, therefore, by Foch upon the morning of the 6th of September were as follows :—

The left—that is, the 42nd Division and the Moroccan Division—were to attempt an advance, starting from the positions they occupied from Charleville to near Mondemont, and they were to lean a little westward or to their left, so as to keep in touch with the offensive advance that had been planned for the French 5th Army beyond them.

The 9th Corps (commanded by General Dubois) was ordered to stand upon the defensive, stretching from Oyes to beyond Bannes—in fact, standing behind the

marshes of St. Gond as behind a moat. When I say "moat" it must not be understood that the marshes are impassable. There are, as the map (page 233) shows, four regular roads across them, and after a long spell of dry weather such as was that of this day, the 6th of September (and many days preceding), the usually soggy meadows can be crossed even with wheeled vehicles in many places.

The 9th Corps was told to put strong outposts north of the marshes, holding bridge-heads, as it were, so that when the time might come for a general advance the mass of its effectives should be able to cross the marshes undisturbed, with its advance posts securely holding these bridge-heads. But for the moment General Dubois' two divisions, the 9th Corps, were to stand pat.

Exactly the same order was given to the two Breton divisions of the 11th Corps, under General Eydoux, which carried on the line. These two divisions lay upon the country road which runs from Morains to Sommesous, a road which passes through the little villages of Ecury, Normée, and Lenharré. These two Breton

divisions, which just covered the railway from La Fère Champenoise to Sommesous junction, had orders to hold the enemy and no more. Such dispositions, if we reflect, were exactly consonant to the general plan which the French Higher Command had in mind. They desired to get the mass of the Germans well down south, *then* to get round behind them with their 6th Army far off to the west, and so to cut the German communications and inflict a complete defeat. That plan was not, as we know, carried out. The Marne did not conclude the war, though it permanently decided its character. Its incompleteness was due to the nearly successful counter-envelopment of Maunoury by Kluck. But until this was apparent the obvious rôle of the various forces was to move less and less against the enemy the more east one got. The 6th Army to move most; the 5th considerably, but more on the left than on the right. The central army of Foch to go forward perhaps a little on its left, but the main part of it not at all.

The French line, then, on that day, Sunday, 6th September, was attempting

to act after the fashion of the accompanying sketch map.

To the left we see indicated the French 1st Corps, the extreme right of the 2nd Army. Next, the 42nd Division of the Moroccans, bunched on the high land just west of the marshes of St. Gond. Then, on the lower land behind the

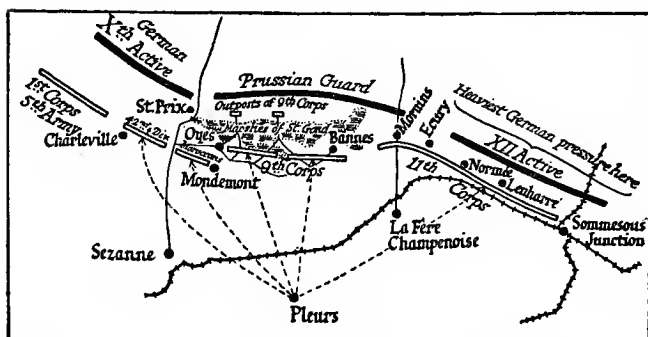

Sketch 55.

marshes the two divisions of the 9th Corps, with advanced posts holding bridge-heads, as it were, beyond the marshes. Lastly, the two divisions of the 11th Corps, with advanced posts outside the villages Morains, Ecury, Normée, and Lenharré; the post of command lying behind all this at Pleurs.

Contact was taken with the enemy on

the morning of that day, the Xth Active German Corps engaging with the 42nd Division before the 1st French Corps to the west—the extreme of the French 4th Army—could come into action. North of the marshes the German Imperial Guard drove in the bridge-heads which General Dubois had established. The German XIIth Active was the first of the Saxon Army to come into main contact with Foch. Before night it had pushed in the advanced guards of his 11th Corps (Eydoux's), and the line of the villages Morains, Normée, and Lenharré was carried. The flames of their burning houses illuminated that night.

At the end of the day, therefore, the left wing has not been able to progress. It is hard at work against the German Xth Active Corps, which has closed with it. The Imperial Prussian Guard has driven in the bridge-heads which the 9th French Corps had put in front of it in the centre, and solidly holds all the line of the marsh to the north. The XIIth Corps (Active) of the Germans has advanced seriously against the French 11th Corps upon the right.

Against Foch that day no other part of the Saxon Army had yet come into action, though their extreme left had already taken contact with a portion of the French 4th Army to the west. Indeed, the confused marching of the Saxons, and a sort of general hitch in their Staff work, helped, if we may credit German reports and views, towards the final disaster. But I cannot help remarking that there was hardly room for their whole great number to deploy (they were at least ten men to the yard), and even as it was they were so much superior in numbers to the French as to press the French back for three days in the fashion we are about to follow.

Already, in this first strain put upon Foch's three main bodies, the form the battle was to take began to show itself. The enemy pressure increased from west to east, from the German right to the German left, and only the extreme French left in front of the German right had been able fully to stand its ground.

As we shall see in a moment, the action continued to develop upon these lines, the French being forced back far southward upon their right, somewhat upon their

centre, but their left holding, and the line thus pivoting round its western extremity as it retired.

This was the moment—nightfall on the 6th—when Maunoury had already discovered that Kluck had been able to bring part of his troops back north of the Marne, and therefore the moment when it was already grasped that the French surprise attack in flank might fail.

On the next day, Monday, the 7th, the German pressure became much more violent, but did not greatly bend the French line. The French 1st Corps, on the extreme right of the French 5th Army to the west of Foch, had come into play, and relieved the intense pressure upon the 42nd Division and the Moroccans. But on the Tuesday, the 8th, the situation of Foch began to be very serious.

On that day the 42nd and the Moroccans, having full aid from the 1st Corps on their left, and therefore outnumbering the Germans in front of them, pushed forward. At a very heavy price they occupied St. Prix, and turned the Guard out of certain of its positions north of the marshes—not all of them; only those to



the west. The two divisions of the 9th Corps held, largely because the marshes still somewhat protected them, but also because the German determination to achieve their success upon the east of the line was now clearly apparent, and because *there* the mass of the attack was pressing hardest.

Upon that day, Tuesday, the 8th, the Imperial German Guard had already begun that separation into two fractions which was later to prove so fatal to it. Part of it remained holding on to those positions north of the marshes, but most of it was inclining eastward in aid of the Saxon Army; and this largest mass of the Guard, together with the whole of the XIIth Active German Corps, and the whole of the XIIth Reserve—the equivalent, certainly, of six divisions, possibly of seven—was driving back the two Breton divisions of the French 11th Army Corps. It was a tremendous drive, pushing the French right down on this one day past the railway, through La Fère Champenoise, and behind the high road from that town to Sommesous, and the French retirement could not call a halt until it

## 238 A GENERAL SKETCH OF

had got behind the little brook of Maurienne upon the line Connantre, Corroy, Gourgançon, Semoine.

By the evening of that day, then, Tuesday, the 8th, you had the French line as it is on the accompanying sketch map. The left, the 42nd Division and the

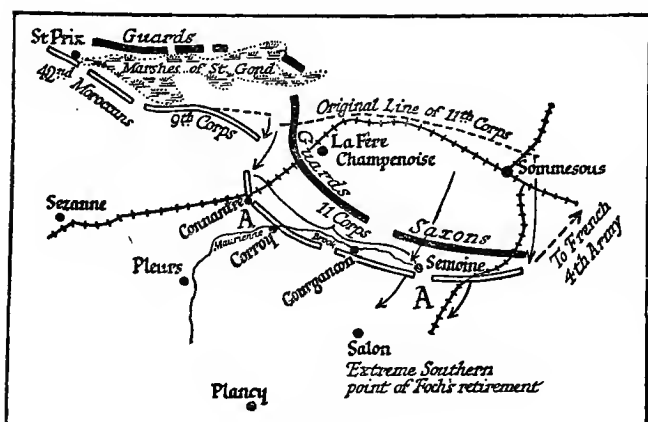

Sketch 56.

Moroccans, had gone forward somewhat. The two divisions of the 9th Corps were still holding, of course, but of little use ; for the marsh both covered and hampered them. But the 11th Corps had fallen with bad loss right back to the position AA, and the line continuing eastward into the French 4th Army was very badly dented

indeed. It was now quite clear what was the plan of the German commander here against Foch, and with our present knowledge of the action as a whole it is clear to us how nearly that German plan came to success.

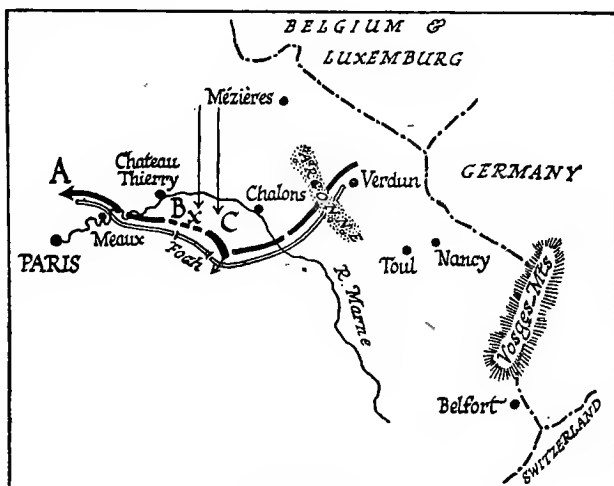

Sketch 57.

The Germans in the centre said to themselves (Sketch 57):—

“ Kluck on the far west, fifty miles away in the direction of the arrow A, has had to bring back his divisions from beyond the Marne, and has leant westward generally. Therefore Buelow next to him

has had to do the same thing lest the line should lose continuity. On this account everything beyond a certain point (B) is thinning off westward in the direction of the arrow. 'The elastic is being pulled,' *and there is bound to be rather a critical strain here at the centre (X)*. Well, we will for the moment risk that. We will for the moment neglect this strain. True, it leaves the two divisions of our Xth Corps to meet almost single-handed (save for a few elements of the Guard) the *four* divisions of the French 1st Army and of Foch's left. Our Xth Corps will doubtless have to retire. *But we will get a decision against Foch to the east, before this retirement of our Xth Corps becomes perilous. There will be a strain, but we will break the French centre opposite us before that strain reaches the breaking-point.* Most of the Guard and half the Saxons shall mass against Foch's right, the 11th French Corps, and drive it in. This will tear a hole in the French centre at C, cut off all the western half of the Allied line, and, coupled with the outflanking of Maunoury by Kluck, either drive it back on Paris, or annihilate it by a general envelopment."

Drive in the French 11th Corps they did, as we have seen. They forced it back across a belt of country which was at its widest a full ten miles in extent, and very nearly did they come thereby to their desired result of breaking the whole French line. Indeed, Eydoux, with his 11th Corps, only rallied at last with the help of a reserve division hurriedly lent him from the rear. Even then he was still outnumbered as 3 is to  $5\frac{1}{2}$ , and there was apparently no prospect of redressing the balance upon the morrow.

What that to-morrow, Wednesday, September the 9th, would bring, the French command could not determine. The genius of Foch was still at grips with an adverse problem. He only knew that so violent a concentration against himself must mean the desire to redress an enemy weakness elsewhere in the line. The most significant part, perhaps, of this bad day's retirement was the withdrawal of French headquarters by a distance of no less than ten miles from Pleurs, its original seat, right away to Plancy, upon the Aube.

Wednesday, the 9th, broke very hot and clear. It was everywhere to be the

decisive day. It was the day at the close of which Maunoury, with the 6th Army, was nearest to complete envelopment and disaster.

All the morning the perilous situation left by the fighting of the day before hung undecided. But the enemy, now confident that a few hours would decide the issue, called up everything that could be spared from the Guard north of the marshes, and threw it southward into the massed attack which was being delivered from Connantre to Gourgauçon, and he further launched all that the Saxon Army could crowd into such a space against the remainder of the French right, from Gourgauçon south-eastward to where the bend of the French extremity was getting more and more accentuated. At one moment it reached Salon.

He threw to the winds the fortunes of the Xth German Corps, now clearly giving way. All that could be attended to after his victory to the east. He held his few posts north of the marshes with less and less of his Guard. The "Gap" began to form and increase as he pressed the mass of the Guard more and more east-

ward with his weight and mass, determined to break through and round Foch's right. It would be time enough to think of the Xth German Corps and this ever-weakening western edge of the German centre when—as surely it would be before night—the victory was decided by the

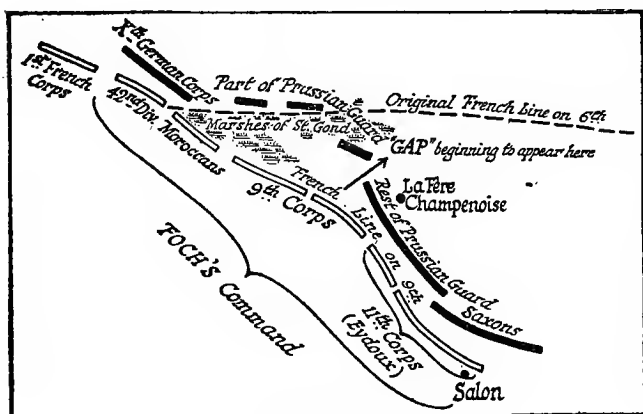

Sketch 58.

total crushing of Eydoux's 11th French Corps.

A little after midday of this blazing French September day, over the horizon of which great storm clouds were already gathered, Foch—his retirement now at its utmost limit, and the strain he was suffering at its maximum—delivered

that famous stroke which it is the object of all these pages to define and to fix. The precise details of that blow once it was struck will never be known. Such a *mêlée* blinded to time and space the men who, in the intense heat of the struggle, decided the fate of the country.

Even its outlines are obscured in places by our ignorance of the exact dispositions in the overwhelming German host upon the east, the Guards, and the bulk of Hausen's Saxon Army.

But the general lines can be clearly grasped. In order to grasp them, let us first mark how far the situation had developed by about midday of that 9th of September, since the morning.

On the left, or west, at A the German Xth Corps was still slowly falling back before the French 1st Corps. The Moroccans are struggling for, but cannot master, the height of Mondemont at M, whence one looks over all the marshes and the plain to the east. The two divisions of the French 9th Corps, which have stood so long, are now bent back to keep alignment with the unfortunate right wing, and that right wing, the two Breton divi-



sions of the 11th Corps under Eydoux, has curled right round to Salon, and there presses against it the mass of the Guard, and at least half of the armies of Hausen.

All this is but a slight further development of the situation at daybreak.

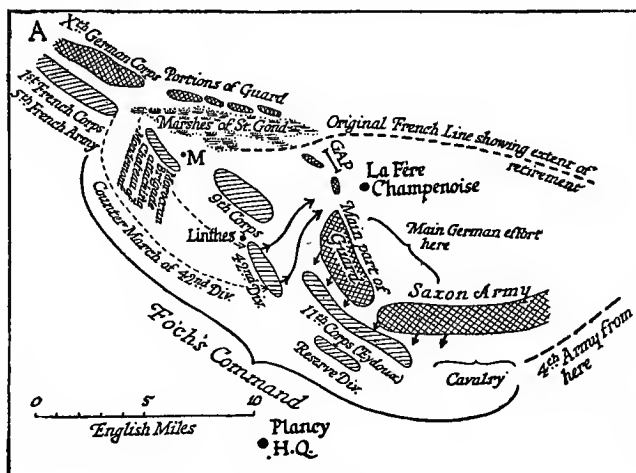

But there is one significant change in the line of battle. If we look for the 42nd Division next to the Moroccans we shall find it gone. Several hours before there had reached this best element of all Foch's troops, the 42nd Division, an order to fall back to the south and east, to the

neighbourhood of Linthes. There it was bid to lie behind the 9th Corps, awaiting further news.

I have met none of the private soldiers who took part in that counter-march under the rising clouds of the now threatening weather, but I know from the temper of soldiers with what bewilderment and in what mood the rank and file, and, indeed, all the command save the Staff of that division (if they) must have heard that they were ordered to leave what, in their restricted horizon, was a triumphant advance upon the beaten Xth German Army, and to fall back for all those miles.

They lay (knowing themselves by that pride of service which a *corps d'élite* so rapidly establishes, and which in their case was founded upon their position during the long tradition of the peace) useless in the open fields. They stood with piled arms idle, hearing the cannonade two miles away, learning from the rumours that had spread all over that field how the right was all but broken. They must have thought their march and its present halt the beginning of a disastrous retreat.

Foch, their General-in-chief, from headquarters at Plancy, twelve miles away, was even then dispatching the order which decided the history of his country. That order was delivered to the 42nd Division near Linthes at four o'clock in the afternoon. It bade them advance at once, straight before them eastward, down through the line of low pinewoods which here bounded the fields, out through these to the plain beyond, and so break out against the exposed flank of the German Guards before La Fère Champenoise. They had an hour's marching to cover before the shock.

It was not yet evening, it was between five and six o'clock when their columns, the heads deployed in shouting waves of men, struck suddenly upon the exposed flank of the Guard, and broke it altogether. Precisely at that moment came along the whole of the French line the order for an intense offensive. The stretched, thin, hardly-held gap between the marshes and La Fère Champenoise gave way, the two divisions of the 9th Corps poured in, and the right of the 9th Corps joined with the 42nd Division in

its thunder against the exposed vital flank of the Guards.

That too-famous corps was now quite broken into two ; its few units north of the marshes were abandoned and cut off ; its mass here to the south was trying to look both ways, fighting in front as before against the left of Eydoux's Bretons ; fighting for its life upon the wounded flank in hurriedly converted wheelings of men. Its side faced about as best it could in the confusion against the advancing and triumphant pressure of the 42nd Division and the right of the 9th Corps.

The huge, congested mass of the Saxon offensive farther beyond to the south and east learnt the peril of the Guard. A gap had opened. The French had seized it. The line had been broken to their right. They in their turn summoned all their energy to cover, as best they could before darkness, the necessity for retreat.

Before the fall of night the storm broke out of the sky, and it was under the most furious pelt of warm rain that the 9th Corps and the 42nd Brigade pushed hour after hour through the darkness northward, careless of sleep now that the battle

was won. The 11th, fighting hard against rearguards of the retiring Germans, achieved even in that night some progress. There ran even in such darkness and such weather the indescribable thrill of victory through all the six divisions.

By the morning La Fère Champenoise was already held and passed through. The midday meal, snatched hurriedly from the haversack while they still marched, found the army back again at its line of three days before, and all that day, Thursday, the 10th, as Foch's men went forward like a wave along a beach, they passed in the ruined villages and on the roads the litter of a confused and precipitate retreat. They picked up its stragglers and its wounded, and its lost and broken guns—thousands of men, fifty pieces, half the artillery of the Guard. Their progress was only halted by the fatigue of an almost uninterrupted twenty-four hours of success.

Upon that evening of the 10th the French headquarters, which the day before had stood at Plancy twenty-five miles away, established themselves in La Fère Champenoise itself, with the advanced

line far off to the north beyond, and the Battle of the Marne was won. During all that same day Kluck had been hurrying northward from before the British and Maunoury; Buelow had been hurrying northward from before the French 5th Army. The German plan, humanly certain of success at Charleroi three weeks before, was in ruins.

## IV.

### THE REST OF THE LINE.

So far we have followed in three separate divisions the three main actions upon which the Marne turned : first, the Grand Couronné ; next, the surprise attack of the French 6th Army on the west ; lastly, the decisive counter-stroke delivered in the centre by Foch, which determined the result.

We must, to complete our grasp of the battle, consider more generally the intermediate parts of the line as well as these three capital points of the two wings and the centre. With this object I will briefly recapitulate the actions of the left centre and right centre lying between Foch and the two wings, so that we may have a united view of what was taking place from the opening of the action to the moment when its turning-point was passed

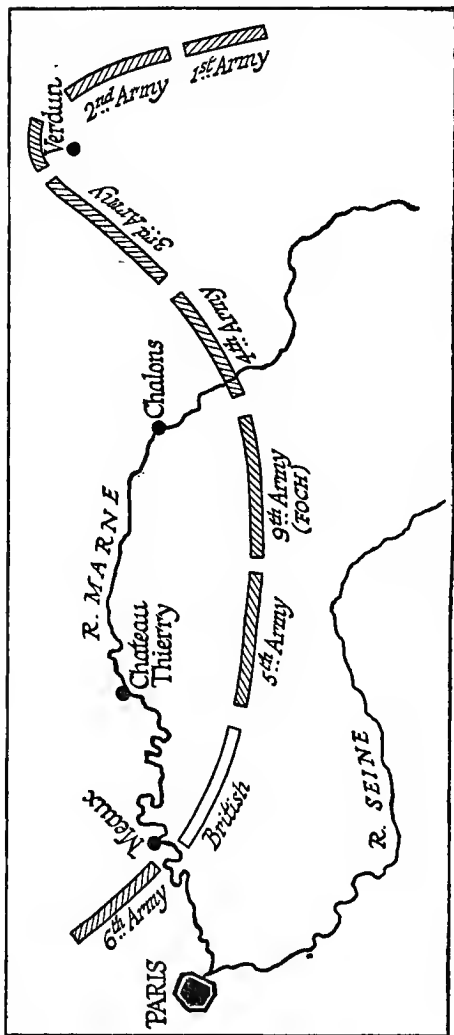

Sketch 60.



during the night between the 9th and 10th September.

As we have already seen, the line of battle as a whole was that of the sketch here appended. In order, from the left to the right, or from east to west, the 6th Army, the British, the 5th Army, Foch in the centre, which central army is now officially known as the 9th. (See Note at end of chapter.)

Beyond this, again, to the east, the 4th Army ; next, again to the east, forming a great horn round Verdun, the 3rd Army ; then, down in front of Nancy, running from north to south, the 2nd Army which had fought and won the Grand Couronné ; and, lastly, along the Lorraine and Alsatian border to the south of it again, and on to the Swiss frontier, the 1st Army.

These armies may also be remembered by the names of their commanders. The 1st Army, commanded at the moment of the Marne by Dubail ; the 2nd by Castelnau ; and the remaining armies, as one goes westward—those which took part in the main action of the Marne—the 3rd by Sarrail, the 4th by Langle de Cary,

the Central one (or 9th) by Foch, the 5th Army by Franchet d'Esperey, the British contingent by Field-Marshal Sir John French, and the 6th Army by Maunoury.

Now in this order of battle the various "subsidiary" policies, as I may call them, had different rôles, which we must carefully distinguish. The army of Sarrail, just to the west of Verdun, and covering Verdun, is obviously the pivot upon which the whole Battle of the Marne revolved. We shall find it going forward, indeed, after the battle has been fought, but not over any considerable belt of country, as it is nearest to the centre of the revolving movement.

Sarrail's 3rd Army plays, indeed, a very important part, but it is not a part of great movement, nor one which we have to follow in much detail in order to grasp the development of the general action. Up to the 9th of September Sarrail hardly moved.

There remain only the 4th Army and the 5th, which may be called the left centre and the right centre of the battle on either side of Foch, and I shall deal

with these separately before talking of the rôle played by Verdun, and Sarrail's army neighbouring it, during the Battle of the Marne.

*The Rôle of the Left Centre :  
the 5th Army.*

The 5th Army, under Franchet d'Esperey, was a very strong one. Though we do not find it playing the great rôle which belongs to Maunoury's surprise attack and Foch's decisive central play, yet its strength was a very important part of the whole French scheme, for it will be remembered that this scheme largely consisted in deceiving the enemy as to the sectors on which he was to expect the strongest resistance. The enemy was led to believe, as I have repeatedly pointed out, that very large forces were gathered by the French on the east, in front of Nancy, and upon the frontier, and that there would be a corresponding weakness upon the west. The strength of Franchet d'Esperey's 5th Army, therefore, was one of the several elements of surprise from which the Germans suf-

ferred, and which between them all led to the result of the Marne.

The 5th Army was composed of no less than the equivalent of nearly six army corps. There were exactly eleven full divisions under the command of its general, and a spare brigade as well, together with three divisions of cavalry.

Franchet d'Esperey's command, in order from west to east, was as follows: the two divisions of the 18th Corps (under Maud'huy), the two divisions of the 3rd Corps, the two divisions of the 10th, and the two divisions of the 1st. That is eight divisions. He had also three more reserve divisions behind his first line, numbered the 51st, the 53rd, and the 69th, and further a separate brigade of light infantry over and above these units drawn from the 2nd Corps in Lorraine. These very considerable forces stretched thus from in front of Esternay westward, or to the left, right away eastward to Sezanne, on the right. Between the 5th French Army and the British to the left was the cavalry force under Conneau.

We shall see in what follows how the superabundant strength of the 5th Army

had its effect upon the fortunes of Foch's, to the right.

From what we have already read of the surprise attack upon the German flank in the west (and the way in which the enemy met this by a rapid retirement and re-

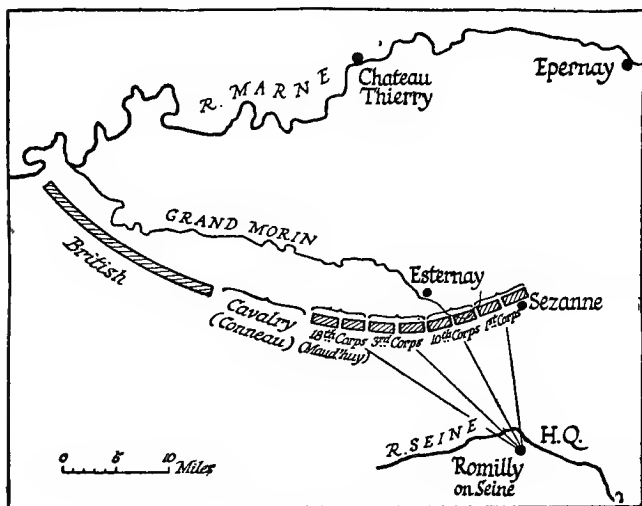

Sketch 6r.

concentration north of Meaux), and of the simultaneous attempt of the German centre to push southward and break the French line, we could guess without further evidence that the French 5th Army during the four critical days, the 6th, 7th, 8th, and 9th of September,

would probably be continually advancing its left, while compelled to fight hard and to advance but little with its right. As the whole line of battle under the effect of Maunoury's unexpected attack (and of Kluck's rapid meeting thereof) swung more or less westward and northward, one might expect the 5th French Army to swing similarly up by its left or western end. And that is more or less what actually takes place, when we follow its movements during those four days.

Buelow, with the II<sup>nd</sup> German Army, has got to retire and to lean westward (at least so far as his right wing is concerned), in order to conform with Kluck's concentration against and attempt to envelop Maunoury. The French 5th Army can therefore advance upon its left opposite Buelow's right, and does so in the following fashion :—

On the first day of the battle, Sunday, the 6th of September, the French 5th Army, with its headquarters at Romilly, upon the Seine, moves forward before dawn. At about seven o'clock in the morning its left wing enters Monceau and Courgivaux, these successes being

obtained by the 18th Corps and the 3rd Corps, opposite Buelow's retiring right wing. But on the right a similar progress cannot be made. The 10th Corps is held up by all the fighting in front of Chatillon, only disengaging itself by riskily sending one of its divisions right round by the

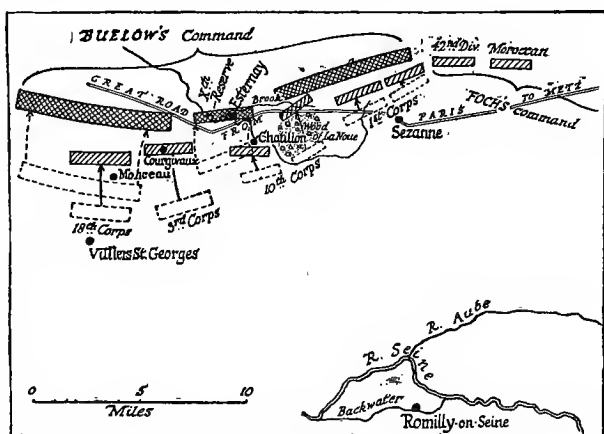

Sketch 62.

east through the woods to La Noue. It came down out of these woods on to the open fields, which are crossed here by the great road down on to the brook of Noue, and striking thus at the left flank of the German Xth Reserve Corps, routing the latter body, and allowing the

French troops to enter Esternay before night. Farther to the east again, the last of Franchet d'Esperey's fighting line made no progress. As we have seen, the 1st Corps, which was there in action, simply helped the left of Foch's army (the 42nd Division and the Moroccans) to hold their ground.

The next day, Monday, the 7th of September, while Maunoury was beginning to feel the pressure of Kluck's counter-concentration, and while this counter-concentration was compelling Kluck to call back troops from beyond the Marne, and compelling Buelow further to conform to that movement, the 5th Army had fortunes exactly corresponding to such changes of position on the part of the enemy.

In front of its left it was held up by nothing more than strong German rear-guards and cavalry screens, which it was able to push back. All that morning, therefore, Franchet d'Esperey's left was working up towards the Little Morin.

But about midday the General got news of the very heavy pressure to which Foch was already being subjected. On his right



the German effort to break the French centre (now that they had parried and held the surprise attack of Maunoury upon the west) was developing. That part of Foch's army which was closest to Franchet d'Esperey—the 42nd Division and the Moroccans—was just at that moment receiving the violent pressure of the German troops debouching from St. Prix. Franchet d'Esperey, still pushing forward with his 1st Corps, told the 1st Corps, on his extreme right, to help Foch's left wing as much as they could, so as to relieve the pressure upon it.

The 1st Corps, with that object, inclined towards the east instead of going due north. But it met there (since it was now in touch with the strong German central effort) with an unexpectedly powerful resistance, and Franchet d'Esperey had, perhaps a little reluctantly, to check the regular forward progress of his 10th Corps just to the left, and direct it also to help the 1st Corps. So strong was the German resistance here that it was not until about sunset, between six and seven o'clock in the evening, that the German Xth Reserve Corps, which im-

mediately faced the French 10th Corps, began again to retire. There was some bad liaison work in connection with this retirement, and this German corps lost in the woods a whole battalion which got itself cut off, and a very large amount of motor transport, especially of munitions.

But taking the 7th of September all in all, in spite of this local success, it was not very much more than a conforming with the German retirement northward and westward, and a struggle against the German strength to the east.

On the next day, Tuesday, the 8th, this swerving of the line more and more up towards the north-east regularly continued. The 18th Corps, under the able command of General Maud'huy (who later was given the command of a whole army in the campaign), forced the passage of the Little Morin, and before night had carried the village of Marchais—where the good cheese comes from—up on the height of the plateau, and quite close to the great road. It was thus past the lonely town of Montmirail, a place which the Germans would soon have to abandon, and which had been at the beginning of the

battle the German headquarters of Buelow. It was also on that historic ground, famous for every Frenchman, where Napoleon had won his most amazing (fruitless) victory against the invader in 1814.

To the right of the 18th Corps, therefore, the 3rd Corps, not without a heavy loss and a very sharp struggle, carried Montmirail itself. But again, as on the preceding day, as one goes towards the right, the difficulty of advance is more marked. The 10th Corps did get on to the heights beyond the river at X, but no farther, and the 1st Corps, on the extreme right, was still hammering, when night fell, at the flank of the Germans, who still pressed hard on Foch's left wing. This 1st Corps was facing, before dark, almost due east, trying to reach, and failing to reach, Bannay, the pressure upon which point would have compelled the Germans—who were pressing the French 42nd Division in front of St. Prix—to loose their hold.

All that day, as we have seen, Foch was suffering the tremendous series of blows which forced back his right by something like ten miles, and even in

264 A GENERAL SKETCH OF

the advancing and successful 5th Army news of the very critical state of affairs developing to the east of them was spreading. To their General, of course, it had long been known.

The headquarters of the 5th Army

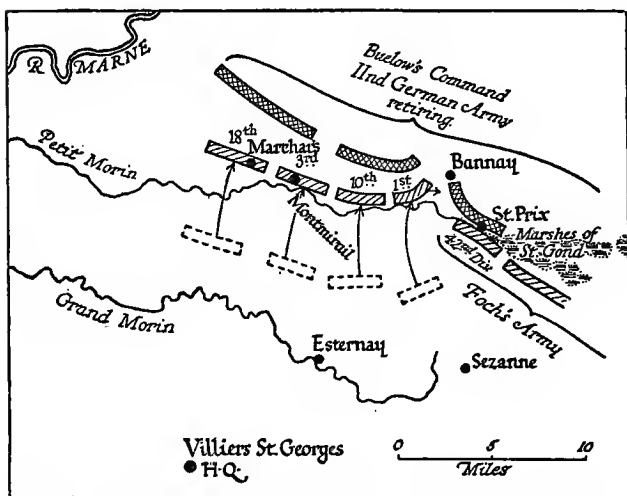

Sketch 63.

moved upon the evening of that day, the 8th of September, to Villiers St. Georges, and the whole battle stood thus :—

The 9th of September, the critical day of the battle, opened for the French 5th Army in the following fashion :—

The 18th Corps, on the left, with Buelow's right in full retreat before it, could march, not unimpeded, but with a certainty of advance, right up towards the Marne at Château Thierry, and so it did. As all these days of advance upon Franchet d'Esperey's left had not been undertaken without loss, the reserve divisions were in part called up to the front line. The 18th Corps, with its reserve divisions just behind it, went rapidly that day, under Maud'huy's command, across the bare plateau, the great portion of it marching in column along the straight high road (Roman in origin) which points straight at Château Thierry. It is a singular proof of how rapidly Buelow had effected his retreat upon his right, that so long a day's march should have been possible, in the very midst of a great action, to this one French corps. From Marchais, where it had found itself on the evening of the 8th, to Château Thierry, is a fair day's march—twelve miles—even for troops in manœuvre or on a route march in peace.

The head columns of Maud'huy's 18th Corps seized Château Thierry, and were

across the Marne by night time, holding the bridge-head beyond.

This was a little more than the German retreat at this point had bargained for. It was all very well to retire in conformity with the necessity of supporting Kluck's big western move against Maunoury, but they did not mean to lose the crossings of the Marne so rapidly. The German general, Richthofen, with a great mass of cavalry, came up just too late to save the situation there, and by night, as I have said, the French were across the river. The British, it will be remembered, had been crossing on that same day (the 9th of September) by all the lower reaches as far down as La Ferté sous Jouarre, though at this last point they had been unable to effect a crossing against the very heavy resistance which Kluck had put up there if he was to complete his plan, and prevent the British appearing upon his rear.

The 3rd French Corps next in order towards the east marched on either side of and along the deep ravine of the Bray, and reached a point a little south

of Condé before night. The 10th Corps, to the east again, got before evening just west of Fromentières.

The general alignment of the mass of the 5th Army, therefore, upon this critical late afternoon of the 9th, just when Foch was on the turn of his fortunes, was that of the accompanying map. There had

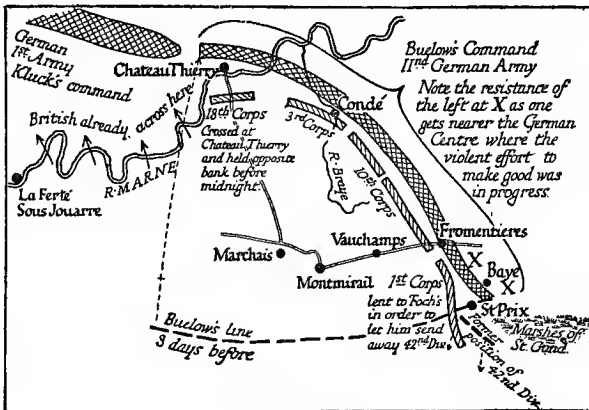

Sketch 64.

been, as on the preceding day, a rapid advance of the left, a less rapid advance of the centre, and a very difficult and slight advance of the right against extremely heavy pressure.

When we look at what happened here, to the extreme right of Franchet d'Esperey,

in those decisive hours, it helps us to understand Foch's success.

In the first place, Franchet d'Esperey sent orders to the 10th Corps during the afternoon to wheel quite sharply to the east, and even to a little south of east, threatening Baye. *And he had already lent the 1st Corps beyond to Foch—that is, he had given over to Foch the right to command the movements of this corps.*

This flank attack of the 10th Corps in the course of 9th September, coupled with the power of direct command now exercised by Foch over the 1st Corps, permitted Foch to send that memorable order to the 42nd Division upon which such emphasis was laid in a preceding page. As we have seen, the order to the 42nd Division came early in the morning, for it was early in the morning that Foch had been made acquainted with the intention of his colleague d'Esperey to wheel round the 1st Corps, and also to hand him over the command of the 10th Corps. Foch knew early in the morning of 9th September that he would have the 10th Corps to use on his left, and at the same time the pressure upon that left would be



relieved by the 1st Corps being swung round to the east, threatening the Germans in Baye. But remember that all this was only rendered possible by the depletion of the German strength near Baye, in itself the result of the general "leaning westward" of the whole German line to meet Maunoury's surprise attack.

That same evening—the evening of 9th September—news must have reached the general commanding the 5th Army that Foch, thanks largely to his aid, had been able to bring off his coup; that the 42nd Division in particular, and the 9th Army as a whole, had triumphantly achieved what we saw in our description of La Fère Champenoise; and that the battle, though still in progress, was won.

Hence we can understand the order of the day which General Franchet d'Esperey issued to the troops upon that nightfall: how "upon the famous fields of Montmirail and Vauchamps, they had, like their sires, broken the enemy." But there was this great difference between the modern triumph and the old, that not even Napoleon's miracle of 1814 could save the campaign; his great

victory of Montmirail, tactically marvelous, remained strategically barren. But the Marne—— !

The Marne, now essentially decided in this night between the 9th and 10th of September (for during all those hours Foch's 9th Corps and 42nd Division were pouring through the "gap"), was a strategic decision of such vast importance as perhaps only the remotely future historian will be able to grasp entirely, but which, in a manner still difficult and confused, Europe has already begun to realize.

*The Rôle of the Right Centre :  
the 4th Army.*

The action of the 4th Army upon Foch's right during those four great days is peculiar. It refused to move in successive conformation to the fortunes of Foch immediately to its left, or east. It stood <sup>west</sup> while all the rest of the line was in movement. It held while all near it were retiring ; and we must follow that strange story of stubborn immobility if we are clearly to see the whole line of battle.

The 4th Army was commanded, as we

have said, by Langle de Cary. It was of normal size, consisting of seven divisions : two divisions of the 17th, one division (barely one in *size*, two in number) of the 12th Corps (which last was commanded by General Roques, afterwards Minister of War), two divisions of Colonial troops—professional soldiers, re-enlisted from the conscript army for the most part—and the two divisions of the 2nd Corps under General Jerard (all but one brigade). It continued eastward the line which Foch had originally occupied at the beginning of his great action of La Fère Champenoise.

It stretched behind, and parallel to, the course of, and half astraddle of, the river Ornain. Facing the 4th Army were partly the eastern or left wing of the Saxons, and partly the right or western wing of the Wurtembergers—that is, portions of the IIIrd and IVth German Armies.

The Germans held Vitry, and were in front of Sermaize, where they were soon to be guilty of some of their most bestial crimes. This book is not the place to speak of these matters ; but when the war is concluded the foul story of Ser-

272 A GENERAL SKETCH OF

maize will weigh more heavily upon the German service, and prove more typical of its character, than anything else, I think, done upon French or Belgian soil. For the purposes of strategical study we

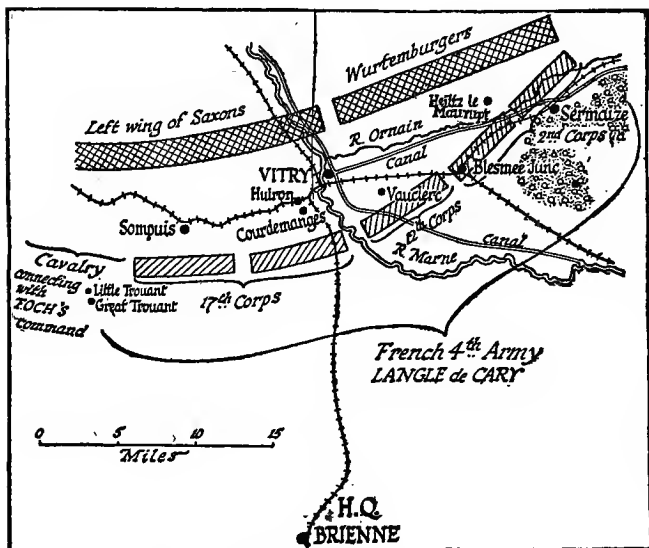

Sketch 65.

must be content to remember that this heap of ruins, filled with its innocent dead, and still reeking with the worst and most perverted of human actions, formed the eastern extremity of the sector under our observation in these pages.

During Sunday, the 6th of September, when the action opened here, the French line lay from left to right as follows. The 17th Corps, with its two divisions, was in the region of Huiron, and at Courdemange, west of the Marne, and just south of Vitry, continuing beyond it to the left towards Foch's army, a division of cavalry. The 12th Corps, under General Roques, which had been very badly hit during the retreat, and was not of the strength of a full division, lay south of the railway and east of the Marne, running through Vauclerc, and crossing the junction of Blemee. And the 2nd Corps stretched up to Heiltz-le-Maurupt, a very lovely village deep in orchards and fruitful. It was a stage upon the march (in peace times) for the young soldiers of the frontier whenever they went to their firing-schools at the camp of Châlons, and well remembered by many thousands from the time of their youth. For it was the pleasantest of the halting-stages on that long road.

The headquarters of this 4th Army were at Brienne when the action began.

Before following the movements of that

action we must remember that this army had upon the Meuse done best, perhaps, of all the covering armies that had taken original contact with the enemy. It was actually victorious at the moment when it received the order to take part in the great retreat, and it is said that its commander, seeing the temper of his troops, asked whether it were not possible for him to remain upon the north-east and form the pivot that was actually afforded later by Verdun. But the general plan of the French Commander-in-chief demanded his retirement, and it was during this retirement that General Roques' corps, acting as rearguard, had suffered such heavy loss.

On this Sunday, the 6th of September, General Langle de Cary received, on the defensive, like all the rest of the French armies, the shock of the enemy. The whole line stood that shock easily, the 17th Corps, its left wing, so far exceeding the general plan as to thrust back the XIXth Saxon Corps opposed to it, and pursue it for some little distance.

But upon the next day, Monday, the 7th of September, very much larger forces

came up against Langle de Cary, and these, combined with the beginning of Foch's retirement upon his right, compelled a slight displacement of the line. No less than fourteen divisions struck between Sermaize and the far side of Vitry, the whole attack inclining towards the south-west, just as the blow against

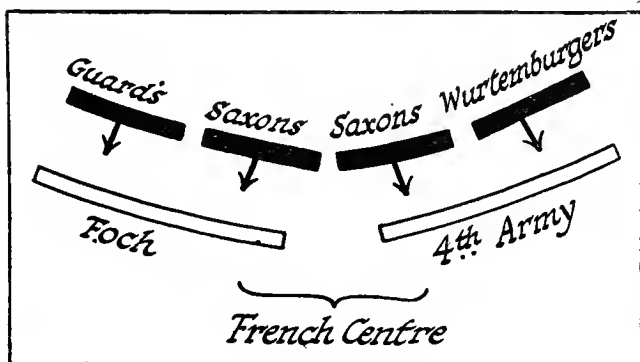

Sketch 66.

Foch inclined towards the south-east, both being designed to break the French centre, between La Fère Champenoise and Vitry.

It was at this moment that Kluck was at last sure of being able to meet Maunoury and perhaps to envelop him; it was at this moment that the German commanders had decided that an assault on

the French centre was the master-stroke dominating all the action; and it was at this moment, late in the same day, the 7th, that the famous order was delivered from *Vitry-le-François itself, telling the German soldiers in the centre that everything depended upon the action of the morrow.*

These fourteen divisions, acting thus upon the equivalent of no more than seven divisions, compelled the 4th Army to fall back. The Germans carried Sermaize, crossing the canal and the railway, and forcing the right of Langle de Cary back into the woods. All along the rest of the line there was either just the power to hold or the beginning of a retirement.

The next day, Tuesday, the 8th, that upon which Foch first felt the last pressure beginning upon him, but had not yet begun the last very serious retirement, Langle de Cary still rather dangerously maintained his line.

I say "rather dangerously," because he must have feared that Foch would have to retire next day, and then there would open between his left and Foch's right a



bad hole right in the centre, and in face of the strongest forces of the enemy. Nevertheless, all the evening of that day, Tuesday, the 8th of September, Langle de Cary was still far forward, not much south of the railway, only a mile or two south of Sompuis. His men on the left were actually *advancing* somewhat when night fell, and on the right and the centre he held his ground.

But the error of thus attempting to stand forward while his neighbour was certainly condemned to retire appeared before dark. Just about sunset news came of very considerable German columns striking down upon the left of Langle de Cary towards the two Trouant villages, the Great and the Little Trouant—unhappy hamlets in a deserted land. And the cavalry forming the line between Langle de Cary and Foch saw, from the heights of the ridge and the camp of Mailly, very heavy forces coming up towards them from the north-west. Even then Langle de Cary did not withdraw his left, but brought two divisions, one of the Colonials and one from the 2nd Corps, up from his right to his left, bade

## 278 A GENERAL SKETCH OF

them cross the Marne and march westward to parry this coming stroke.

The situation at this moment was that of this sketch :—

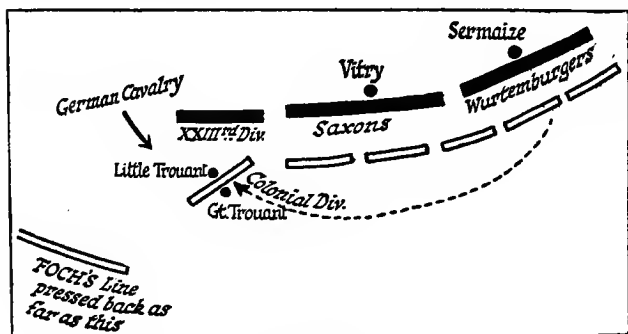

Sketch 67.

Next day, the 9th, the critical day of the battle, still saw Langle de Cary holding his positions. I do not know what would have been said by the historian of the commander of this singular disposition if things had gone ill in the centre, and if the Battle of the Marne had fallen to the enemy. But war is a game in which hazard often passes for calculation, and calculation for hazard, and no true appreciation of so exceptional an attitude as that of the 4th Army will be possible until we have much more evidence before us.

At any rate, during the early hours of that same 9th of September, at the very moment when Foch's right was bent right back eastward of Semoine, and when, therefore, so dangerous a dent was appearing in the general French alignment, Langle de Cary's left not only held its own, but actually continued to force back the Saxons in front of it. The tremendous concentration of forces against the 4th Army, so far from achieving its end, was already—probably because that concentration had involved congestion and mismanagement—leading to some confusion. But the centre in front of Vitry, and the line to the east of that town, were firmly held by the Germans, and the battle still swung even when, in the late afternoon, just before sunset, *the XXIIIrd German Division, just in front of the extreme left of Langle de Cary's army, began to show signs of anxiety and disorder.* Before evening it was in full retreat. Why was there this change?

We know what had happened. Ten miles off, to the west, Foch's stroke had come off. These late afternoon hours of the 9th had been filled with his murder-

ous flank attack upon the Prussian Guard. The effect of La Fère Champenoise had run along the line, and hence it was that the Saxons opposite Langle de Cary were now, at nightfall of Wednesday, 9th September, in confusion and beginning to retire. It was Foch's stroke which had affected the enemy's troops in front of the extreme left of Langle de Cary, and that night rout was confounded with the break-up of the Guard and of the remaining Saxons to the west.

Such, briefly, is the singular history of the 4th Army during those days: difficult to explain as part of the general action; hazardous, apparently, and almost a gamble if we consider what Foch was risking upon the left, and by how narrow a margin his stroke of genius achieved its end. But, as events turned out, the 4th Army, claiming as it did so great a record, refusing to retire, took part in what was now to be a triumphant advance, with the boast that during the Marne it alone had "conformed to no situation, but had fought its own hand." Rightly or wrongly, it had pinned a vastly superior but vastly worse-managed enemy, and, as Foch was

on its left, it suffered no permanent isolation. But it was a great hazard.

## NOTE.

It is a curious thing that even to this day one cannot be absolutely certain upon so simple a point as the numbering of Foch's army, and it is typical of all the official reticence which the French are determined to maintain upon their military affairs until the campaign is decided.

There is no doubt about the official name, which appears in innumerable dispatches and documents, private and public: Foch's army was called the 9th and *hardly ever* anything but the 9th.

But these words "hardly ever" are in themselves a curious phrase to have to put down upon such a matter. Now and then, even in documents really official, you find Foch's army called the 7th: you very often get the expression "the 7th army" in private letters, and in non-official descriptions of the battle. I have before me as I write, amongst other documents, one most interesting little jotted note, the writer of which (a man personally acquainted with the whole campaign and furnishing a private memoir upon it) even hints that the expression "the 9th" is a mere slip of the pen. The words he uses are: "The 7th Army, which General Sir John French, the Field-Marshal, alludes to in his dispatches as the 9th." The writer of that note apparently imagines that General Sir John French wrote a 9 for a 7, or mistook a French 7 for a 9, or even that he himself wrote the figure 7 and that it was transcribed 9. In support of this use of the denomination the "7th Army" for Foch's you have the obvious truth that this army *was* in order of time of formation the 7th, and that, equally in order of time, you could not get more than seven armies in. There is no room for a 9th, and no trace apparently anywhere (as yet) of an 8th. After all, we know the French order. There was (1) the

Covering Body, or "Operating Forward Mass," which took the first shock of the invasion ; and (2) the "Mass of Manœuvre." The covering body which was engaged in the first shocks against the Germans, and which suffered the great strategic retreat, consisted of the 1st, 2nd, 3rd, 4th, and 5th French Armies ; all duly aligned from the Swiss frontier to the extreme left ; all numbered exactly in order from south to north and continued by the British contingent, which is the last of the series.

Then, when the French Commander-in-Chief formed his first *new* army out of the "Mass of Manœuvre" it was logically enough called the 6th, and brought up, as we know, still farther to the left beyond the British contingent. At very nearly the same time another army is made up out of the "Mass of Manœuvre," and put under the command of Foch ; this, therefore, should logically be the 7th. With this organization the French line was complete. Its formations had reached (for the moment) their maximum.

Where, then, do we get the figure 9? If there was no 8th Army, how can one get a 9th? Still more, how can one get a 9th if we can only get it at the expense of presupposing not only an 8th which does not exist, but also supposes a hypothetical 7th, which is in reality the 9th?

It is a puzzle I shall not pretend to solve. I may be making some elementary error of ignorance, and perhaps I shall receive information which will enable me to delete this note before my book goes to press. The denomination "9th Army" may have been settled with the deliberate object of deceiving the enemy, or it may be due to something more simple and more obvious which has escaped me. I only know at the moment of writing—after twenty months of puzzle—that the army is nearly always officially called the 9th, but is sometimes (even officially) called the 7th ; that by every indication of common sense and arithmetic it ought to be the 7th ; and there I must leave it.

## V.

### THE STATIONARY RIGHT WING.

#### *The Rôle of the Third Army under Sarrail.*

The last of the armies aligned between Paris and Verdun—that upon the east or Verdun end—was the 3rd Army, now (though not in the first days of the war) under the command of General Sarrail. It must be distinguished from the forces which were actually round Verdun itself, and were protecting that singular “horn” in the French dispositions—a resisting projection as necessary to the whole plan as was the resisting fortified zone of Paris at the other end of the line.

The army of Sarrail, though bound to keep in touch with the great horseshoe of field defences covering Verdun, was of independent action; and it looks a little as though it had been expected, when the action of the Marne developed, to come on in flank, press upon the Crown Prince's

army (the German Vth Army), which was opposed to it, and help to increase the confusion of the enemy when once he should be compelled to retire.

If this was the rôle set down for Sarrail's force, it was unable to play its full part. If, on the other hand, the 3rd Army was only expected to hold against the pressure of the Crown Prince while all the active work was being done elsewhere, then the 3rd Army amply fulfilled its function. It had already done something of capital importance when, during the retreat, it had covered and saved Verdun ; for by so doing it had compelled the German advance to take that curved, "sagging" form which gave half its value to Maunoury's unexpected onslaught in flank.

Sarrail's army during these four days, the 6th, 7th, 8th, and 9th of September, gained and lost such little ground, and had, though an important yet such a negative effect on the whole battle, that our examination of its movements can be brief.

It consisted, *two or three days before the battle opened*, of nine divisions—six



divisions in line (with a brigade added), and three divisions behind in reserve, using as well the regulation division of cavalry which accompanied each of these armies. These eight divisions were thus organized:—The six divisions were the 4th, 5th, and 6th Army Corps. Two of them formed the 4th Corps, two the 5th, and two the 6th. But it did not maintain that strength. *It was used as a reservoir for other fields to draw upon, because its position made movement on its own account immaterial to victory.*

The whole story of this army is a sort of little model of the strategy that won the Marne. During the great retreat it is the pivot, and therefore has the least distance to retire. It is therefore less fatigued, and forms a good “reservoir” from which to draw men, *just* before the battle, to swell the “Mass of Manœuvre.”

It is on the east, and its original strength will, therefore, deceive the enemy, increasing his erroneous idea that the French were massed on the east and would be weak on the west. But the west will be strengthened—among other ways—by the secret withdrawal thither just as the battle

opens, and even *during the battle*, of troops from the 3rd Army.

The forces secretly withdrawn from it are swung round by rail *behind* the retreating covering line to the centre and west with extraordinary rapidity and skill. The secrecy and speed with which the French used their railways was a mark of all this time.

Finally, the moment for ending the retreat and for taking the counter-offensive is so clearly foreseen that the forces borrowed from Sarrail for use by Maunoury and Foch when the counter-stroke is given are borrowed actually *during the retreat*, and while the enemy thinks that he is pursuing a mere flight. The 4th Corps is drawn off (to swell Maunoury's army) as early as the 4th of September, and so is the 42nd Division, which formed one-half of the 6th Corps, which we later find with Foch, and which, it will be remembered, decided La Fère Champenoise.

The three reserve divisions lying behind the line were the 65th, the 67th, and 75th; and the division of cavalry which Sarrail had available was the 7th division.

The line along which these forces were deployed is a simple one to follow upon the map. It ran straight from Revigny (which is called "Revigny of the Cows," and is a wealthy little market town) to Souilly. It faced, therefore, almost exactly north-west, and everywhere looked at the great bulk of the Argonne forest, the outskirts of which stretched up to its line.

In that Forest of the Argonne opposite Sarrail was the Crown Prince, having under his command no less than five corps, with a division of cavalry. This army of the Crown Prince, the Vth German Army, was composed of (at least) the Vth, XIIIth, and XVIth Active Corps, and the Vth and VIth Reserve Corps. So many were actually identified. It was very much more numerous, therefore, than the French 3rd Army opposed to it, numbering as it did at least ten divisions, with perhaps two extra divisions as well additional to the active corps. The reason that the Crown Prince's army was thus exaggeratedly strong was the German error as to the disposition of the French. The exaggeration proceeded from the error that the French had mainly massed towards the east—a fundamental

misjudgment which, as we have seen, largely explains the whole Battle of the Marne. This battle turning as it did upon the surprise in the west and the sharp tactical move of Foch in the centre, so huge a host right up here in the east under the Crown Prince was wasted.

Indeed, the Crown Prince's army was so large that it had not full room to deploy. His three active corps (the VIth, XIIIth, and XVIth) lay right in front of Sarrail: the VIth just on the boundary of the department, in front of the big Belval pond and through the Forest of Belloue; the XIIIth in front of Triaucourt; and the XVIth astraddle of the upper valley of the Aire, just out of the forest. The two other corps—the VIth Reserve and the Vth—were spread out in front of the defence of Verdun, and did not concern Sarrail's action.

I have said that we have in the 3rd French Army of Sarrail excellent proof (if history should demand such) of the fact that Joffre's great retreat was strategic and designed. Sarrail, before taking up these positions, and while in the act of retiring upon the extreme French right

of the retirement, did, I will not say "what he chose," but all that was needed to hold and shepherd the Crown Prince's

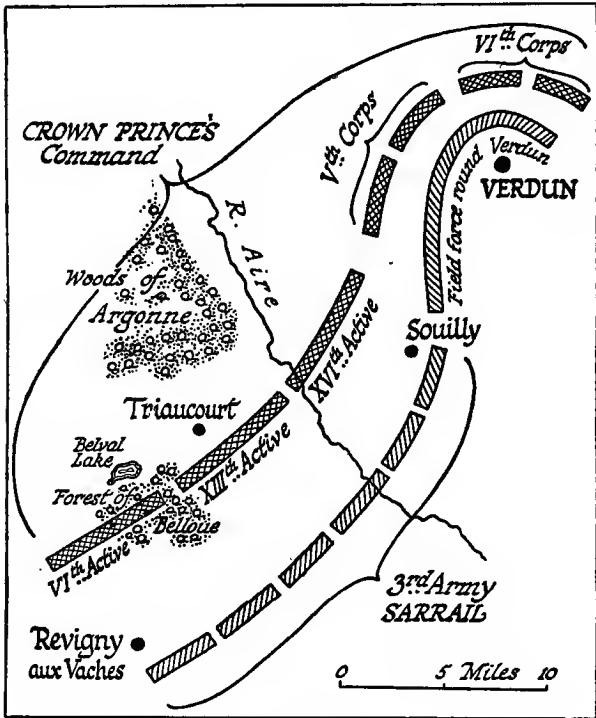

Sketch 68.

force. Thus in the early days of that same week, three or four days before the Marne, on the 1st and 2nd of September—at the very moment when the sixteen

German divisions under their Emperor's eye were in the thick of the Grand Couronné—the French 3rd Army, which had then retired to about the level of Montfaucon, had defeated at its leisure an attack of two of the Crown Prince's corps, and even pursued one of them back over the Meuse, giving the retreating army ample time to fall back unmolested. Sarrail himself had been put in command just at the end of its retirement ; and so secure did the French General-in-Chief feel with regard to his right wing here, in spite of the enormous masses the Crown Prince commanded, that he borrowed men from this 3rd Army not only to strengthen Foch before the Battle of the Marne, but even to strengthen the extreme left wing under Maunoury.

The reader is already acquainted with the fact that the 4th Corps of the French Army appeared upon the field of the Ourcq on the 7th of September. Just before the Battle of the Marne opened this 4th Corps was taken, as we have seen, from Sarrail's command, and sent by train right round westward for 120 miles, appearing after an interval of less

than forty-eight hours upon the extreme left wing.

At this point it may be well to admit a short digression upon the use made by the French of their railways in this campaign.

The public comprehension in this country—and, indeed, pretty nearly throughout the world—of all the campaign is largely affected by the contrasting policies of silence upon the one side and of often exaggerated publicity upon the other which distinguish the French and the German service respectively. The Germans never hesitate to tell us from what part of the empire troops come which achieve such and such a feat, whether that feat be real or imaginary. We were at once informed, in rather inflated language, that the troops which took the shock in Champagne in the early part of 1915 were “our valiant Rhinelanders.” A year later, in the attack on Verdun, the regiment that penetrated to the abandoned fort of Douaumont was given us by Berlin (in the curious telegram which claimed that act) as “a conquest of the armoured fort

which is the north-eastern corner-stone of the defence of the fortress by the brave 24th Brandenburg Regiment." The failure to carry the Mort Homme four weeks later was not only trumpeted as a success, but we were loudly informed that the supposed capture of that hill had been "the triumph of a Silesian division." The abandoned fort of Vaux, when it was not reached by the enemy, was similarly captured by them upon paper, and the glory duly accredited to the two reserve regiments from Posen. In general, throughout the campaign, it has been the German policy to hearten public opinion at home and to excite neutral imagination by this sort of picturesque detail.

The French, upon the other hand, maintain for months after any event a complete silence upon the units taking part in the action. Their profoundly rooted corporate discipline permits the public to remain in complete ignorance, and the soldiers to defer the fame which in older wars would have been their immediate reward.

These contrasting characters are apparent in every other matter. Thus the



Germans publish lists of casualties incomplete, indeed, but detailed. They even went so far, in the earlier part of the campaign, as to tell us where and when each casualty noted occurred ; so that we could, with the greatest ease, identify the various units and their movements. This piece of folly they later abandoned ; but that they should ever have committed it at all, is a singular proof of the strength of routine in the Prussian service, and of the political necessities to which its commanders must conform.

Now, the same contrast is observable with regard to the use of railways in war.

The Germans throughout the whole of the great campaign have published broadcast, and with the strongest expressions of self-satisfaction, their use of the railway in transforming the modern mobility of men. American journalists in particular have been favoured with I know not what extravagances, designed for repetition in their neutral press ; and one unfortunate scribe—common so far as his work goes to this country and to the United States—has written wildly of Prussia's moving one million men in forty-eight hours from

the Eastern to the Western frontiers of the enemy!

The effect of this sort of boasting and publicity is not negligible. It has had upon the opinion of neutrals and of civilians, after more than a year of war, the result that most neutrals, and even many civilians in belligerent countries, have come to imagine a special aptitude in the Germans for this very straightforward business of moving troops by rail.

In point of fact, the Germans have in this as in every other matter been methodical, painstaking, and either rather slow, or, when pressed, confused. Their movements of men by rail, measured in units, mileage, and time, have been very well worked out, but have shown no special efficiency—certainly no special speed—and have been a little less developed than those of the Italians and the French. They have had a great deal more of such business, because they were fighting upon two fronts. But each individual example of it has been at a rate never superior to, and usually slightly inferior to, that of their rivals. No move-

ment of German troops which we can trace is comparable for exactitude and rapidity to the transference of the whole British contingent from the Aisne to Flanders in the autumn of 1914. And there has not been one example of any large transference of German troops during the course of an action and behind the front of it comparable to this swinging of 160 French troop trains from the extreme east to the extreme west of the line just before and *actually during* the Battle of the Marne.

It is well to bear these rather simple and obvious points in mind, lest we should find ourselves asking, as so many bewildered men have asked in the course of this great war, how it is that the enemy—if to the advantage of immensely superior numbers be added superior technical efficiency in organization and handling of machines—managed to get beaten at the very outset by the greatly inferior forces opposed to him, and driven to entrenchments after less than a month of open war in France.

From this digression upon a point not unimportant, I will return to the situa-

296 A GENERAL SKETCH OF

tion of Sarrail's army at the moment when the battle opened.

Deprived of half the 6th Corps (the 42nd Division, which had gone to Foch) and of the whole of the 4th, Sarrail's

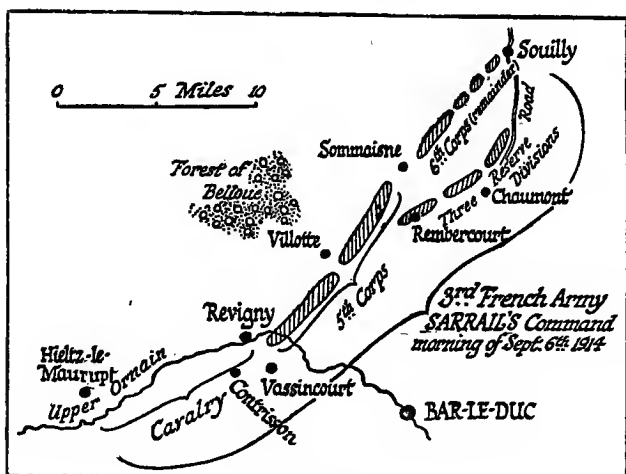

Sketch 69.

diminished army was deployed as we see it on Sketch 69.

His division of cavalry was used, like all the others in the long line, to fill the gap and form a link between his left and his neighbour's right. It was spread out along the railway between Revigny and

Maurupt, in the fertile meadows that here bound the upper stream of the Ornain.

Next came all along in front of the Forest of Belloue the two divisions of the 5th Corps to beyond Villotte. What was left of the 6th Corps, now the 42nd Division, had gone over to Foch—to wit, one division and a brigade—and lay very thinly spread from near Sommaisne (the village at the sources of the Aisne River) to near Souilly. The three divisions of reserve were spread out behind this front line occupied by the 6th Corps, passing through Rembercourt and Chaumont, and so up the Souilly road.

In the night before the opening of the battle—that is, in the evening of Saturday, the 5th of September—the Crown Prince, who believed the French retreat to be still in full swing, issued orders for a general advance upon the morrow; in which orders were included the singular phrase, that his troops were not “to advance towards” but to “take” Barle-Duc. At about seven o’clock of the morning of Sunday, the 6th, the Germans advanced with that object in view.

The shock struck the French army in line, Sarrail having received, with all the other generals, Joffre's famous message that the morrow was to see the end of the retirement and the beginning of the counter-offensive. The pressure of the Crown Prince's army during the whole of that Sunday, 6th September, was held all along the northern part of the French line, and was successful only upon the extreme left, where the Germans entered Revigny before darkness fell.

By that night the French line passed through Vassincourt up to Villotte on its left—that is, the two divisions of the 5th Corps had fallen back over a sector three miles broad at its extremity, and pivoting upon Villotte. It had yielded to the pressure of the VIth German Corps, and Bar-le-Duc was no more than about six miles behind its line. Beyond Villotte, all the way from that village northward, it either maintained its original positions or slightly advanced, the last units up to the north being three or four miles in front of Souilly.

The next day, Monday, the 7th, saw no further German successes. There did,

indeed, begin upon that day a very important movement of the Germans far away eastward in the Woëvre behind Sarrail, which I will deal with in its place, and which I will beg the reader to bear in mind until the time for describing it shall come.

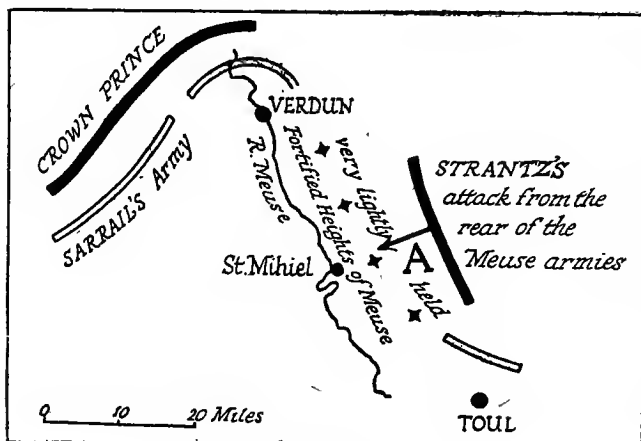

Sketch 70.

Seeing how the horn of Verdun was thrust northward, a German force from Lorraine was making an attempt to force the Meuse behind Sarrail at A, and, as we shall see later, they very nearly succeeded. But the main front, facing the Crown Prince, stood firm, in spite of a

certain accession of strength to the enemy's already greatly superior forces, which accession of strength was due to the arrival upon the line of certain units hitherto to the rear of the German march. Sarrail, though thus still holding his own, was very weak in men for such an effort ; and it was of great service to him when, just before dark upon that Monday, the 7th, the 15th Corps began to disentrain in his neighbourhood, having been sent up to reinforce him. I have never been able to find from what direction it was drawn, but it was essentially a part of that " Mass of Manœuvre," the flinging of which into the action when it was developed was, as we have seen, the essential of French strategy.

This reinforcement on the morning of the 8th was massed for the greater part against the weakening and imperilled left wing in front of Revigny, and lined up round Contrisson along the canal. By the night of the 8th this reinforcement had recovered the greater part of the ground lost upon the day before round Revigny ; but they found in that unhappy little town marks of deliberate



savagery—less abominable than the crimes of Sermaize, but yet of a sort unknown hitherto in modern war.

The last of the four days, the 9th, the critical day for all the other armies—its close the moment of victory for Foch—had not for Sarrail and the 3rd Army any great development. The rout of the German centre had not by night time affected the Crown Prince's army, and the only place where this large German force showed any sensible weakness was in the centre, where there seems to have been a hitch in munitionment; for the German fire became singularly weak at one moment of the action.

But while Sarrail thus held upon his front, his rear—the farther side of the horn of Verdun, the defence of which was the Meuse and the forts upon the heights beyond it—had been in increasing peril.

It had occurred to the enemy—too late, of course—that if he could not break the main front of Sarrail, he could at least threaten him in the rear. The singular conformation of the line lent itself to such a threat. Sarrail's rear was guarded only

by the line of forts along the Meuse. There would be few troops present. The permanent works would fall to the new siege train—all the last three weeks had shown that. The attempt was made. Troyon Fort was bombarded, and nearly succumbed. But the stroke was delivered as a German afterthought four days too late; and before it had succeeded, the retreat from the Marne had begun, and the attempt was abandoned. Troyon was relieved upon the 11th.

## THE AISNE AND AFTER.

WE have seen that the 10th of September (Thursday) was filled with the general retreat of all the German line from the Argonne to the Ourcq. The morrow, the 11th, saw that retreat continued. Its first rally appeared at the close of the third day.

Upon the evening of Saturday, the 12th, the end of the third day of the pursuit, Maunoury's right had already come in front of Soissons ; his left was in the Forest of Compiègne.

It was a day of cold, fine rain throughout the morning, turning to a regular downpour in the afternoon, and as the sun declined a strong wind began to blow. In such weather the German troops in Compiègne itself defiled endlessly out through the northern gate.

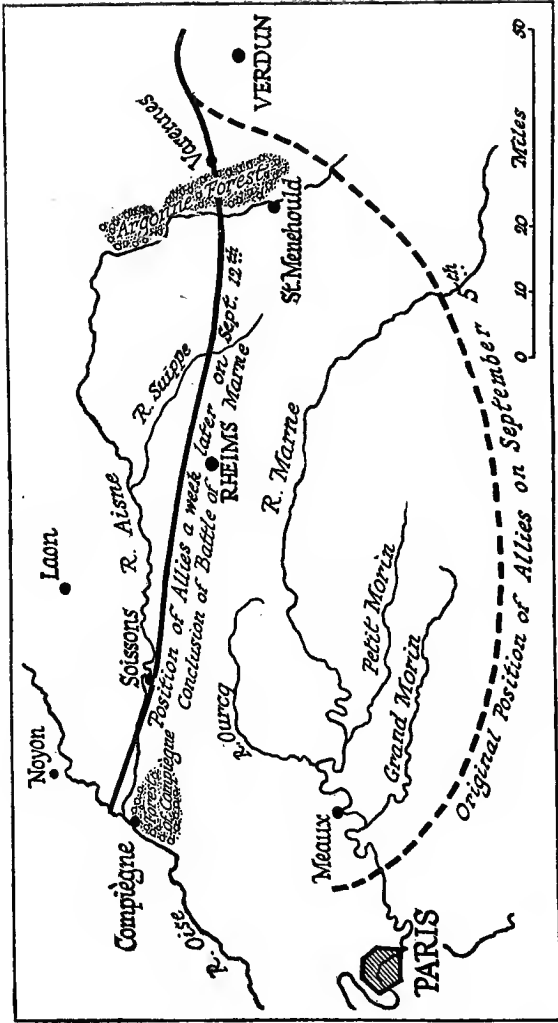

Sketch 71.

We have a vivid picture from an eyewitness of that nightly procession: The guardians of the palace watching through the steaming panes file upon file of gray figures tramping off in the retreat. On into the night that procession continued endlessly. It was nine o'clock when the last officer, appearing suddenly before the curator, threw down upon the floor the great keys which had been handed to him so recently, cried angrily, "There are your keys," and departed. It was ten o'clock when a formidable explosion east and north of the city announced the destruction of the temporary bridge which the enemy had thrown across the river, and the complete evacuation of the district. Far off to the east and to the right that same afternoon and evening the guns were answering each other upon the hill south of Soissons. With the first light of the morrow, the Sunday, the crossing of the Aisne began. The bridges had, of course, all fallen, and the larger German pieces lining the heights beyond deluged the valley with shell. It was the beginning of that war of positions which was so rapidly to develop in the next few days.

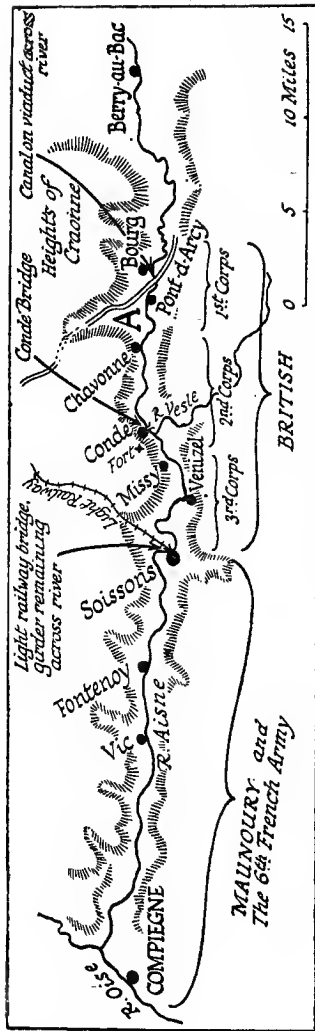

Sketch 72.

The extremity of the German line stood in a singularly united landscape of a simple type. The Aisne, a narrow but deep river, slow in stream, flows through a flat valley from Berry-au-Bac to Compiègne, which has upon either side similar heights, plateaus descending sharply in escarpments on to the level of the river meadows. It was upon the farther northern heights that the enemy had prepared to stand.

At Vic, at Fontenoy, and at other points the French threw across their pontoons, and one detachment precariously bridged the water in front of Soissons, crossing upon the ruined girders of the narrow gauge railway, and, once the crossing was effected, confirming the rapidly-constructed wooden bridge behind them. Perhaps half of Maunoury's force was on the northern bank before the end of that Sunday, 13th September, and preparing for the assault of the northern heights upon the morrow.

Unfortunately, a swift and exactly synchronized advance, which alone (as was later discovered) offered any hope of preventing the Germans from digging in

thoroughly upon the heights, was not achieved. For to the right of Maunoury the Aisne held up the British contingent.

Field-Marshal Sir John French's command stretched from the immediate neighbourhood of Soissons eastward as far as Bourg, beyond Pont d'Arcy. Its right, therefore, had before it the considerable flat indentation or ravine at A which runs up north into the hills from Pont d'Arcy and Bourg, and is the depression used by the canal. Its left immediately faced a point where the northern escarpment comes down close to the stream of the Aisne. Its centre, at the point where the Vesle falls into that river facing Condé, had that escarpment rising abruptly from the very banks and ground by the work called the Fort of Condé.

The command was deployed in numerical order from east to west, the 3rd Corps nearest Soissons, the 2nd in the centre, opposite Condé, the 1st on the extreme right, and all three found upon that Sunday the obstacle of the Aisne extremely serious. The river was in flood after these two days of continuous rain, and all day the attempts to cross near Soissons failed.



At Venizel, however, the road bridge was not completely destroyed. It was partly mended, sufficient to carry guns. A pontoon bridge was constructed side by side with it, and the 4th Division got over. The centre, in front of Condé, was in a worse case. Its left effected crossings by means of rafts in the neighbourhood of Missy, but the bridge of Condé under its strong work continued firmly held by the enemy. It was held, indeed, for some days further, and they could not be driven out. One battalion of the Guards effected a crossing at Chavonne. The right got over partly along the ruined but remaining girders of the bridge at Pont d'Arcy, partly by the viaduct which carries the canal east of this point across the Aisne.

The position, therefore, by that Sunday evening was that the left of the whole line, the French 6th Army, was fairly well established beyond the Aisne; but the more difficult task of the British contingent had not been entirely accomplished. Roughly, the two wings were across, while the centre was held back by the continued German occupation of Condé and its bridge.

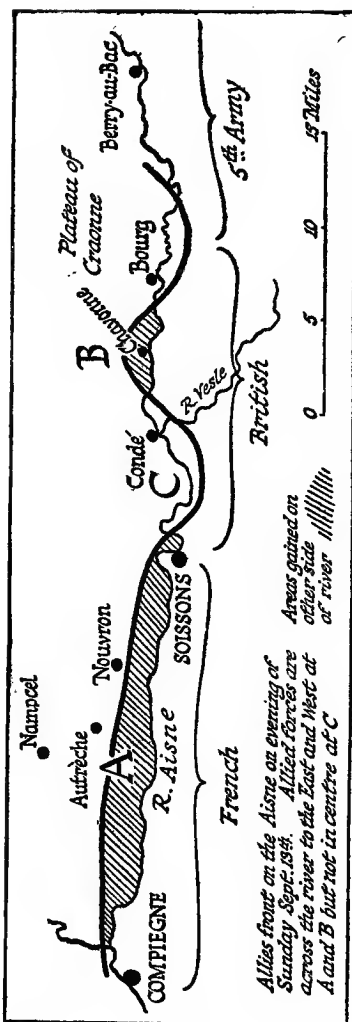

Sketch 73.

It was upon the next day, Monday, the 14th, that, so far as this imperfect alignment permitted, the assault upon the German entrenched line upon the heights north of the Aisne was delivered; and upon that same day the whole of the German positions from Compiègne right away eastward to the Argonne, close upon one hundred miles, were attacked by all those bodies which four or five days before had triumphed at the Marne.

Maunoury was pushing up and carrying Autrèche and Nouvron in his centre, and had nearly reached Nampcel, to the left. The British had reached many advance points upon the ridge in front of them, and, at their farthest limit, Troyon, almost on the height of the ridge.

Farther east Esperey and the 5th Army, having crossed the Aisne above the English, were striking at the bold cape of Craonne; and in all the open, mournful country of the Champagne the 9th Army under Foch, the 4th under Langle, had touched and been checked by the German entrenched line. That line ran from the Aisne parallel with the Suippe in such fashion as to cover the lateral communi-

cation afforded by the railway from Bazancourt to the Argonne, an artery essential to the linking up of the German centre with the Crown Prince's army. To reach that railway was the object of all the central French advance. It was not attained. Twenty months were to pass, and still to see that line in the hands of the enemy. The 4th Army went no farther than Souain. Foch and the 5th Army, linked up north of Rheims, did not reach that railway.

The whole of that Monday, the 14th, the German line across the Champagne received and checked the advance of the French centre opposed to it; and before night it was apparent that even upon the left, where Maunoury had achieved so considerable an advance, the main German defensive position was still in front of him upon the height of the ridge, and that what had been a general retirement and a general pursuit was changing in character.

It was upon the 15th and the 16th that this modification of the campaign—the true conclusion to the Battle of the Marne—became apparent, first upon the left,

and gradually along the line eastward to the Argonne. For upon the 15th, the Tuesday, the Germans developed against Maunoury a sustained and vigorous counter-offensive, which drove him back towards the river; upon the 16th Esperey, with his 5th Army, had found it impossible to storm the height of Craonne. Foch was back nearer to Rheims, and had lost the

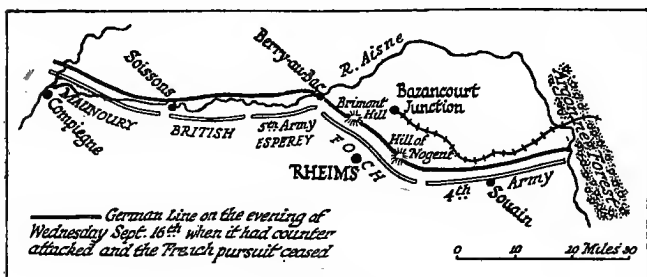

Sketch 74.

height of Brimont. What was worse, he was losing the heights of Nogent l'Abbesse, just east of Rheims, at a range of only 7,000 yards from the centre of the town, whence the accurate delivery of heavy shell laid the city and the capital at the mercy of the German guns. The 4th Army, to the east beyond, could move no farther. The German line securely covered the Bazancourt-Argonne railway,

and the whole of that immense movement between the Oise and the Argonne had come to a halt.

It was upon the evening of this Wednesday, 16th September, that the French Commander-in-Chief began to change the plan of the attack. The hope of continuing a war of movement could no longer be held. For many days to come, especially on the heights above the Aisne, attack was to succeed attack against the entrenched German line. But the continued enemy retreat, actively pursued, which the first days had promised, was at an end, and there had appeared for the first time in history that phenomenon only possible to millions in arms, and those arms the arms of a modern defensive—*the entrenched position covering half a Continent, and forming a wall not to be turned upon either flank.*

Here I must beg the reader to pause and consider the new character the war was to take for so many months.

From this moment, the 16th of September, when the Allies discovered that the enemy's digging himself in destroyed

all chance of direct forward movement in the field, and when this discovery had begun to produce the attempts to turn the enemy's line, there begins that system of immobile *trench warfare* which for many months characterized all the war in the West.

Its chief effect upon opinion is the false conception of a "stalemate." The profound action of delay upon the psychology especially of the civilian public among the Allies is, perhaps, the chief point of interest connected with it, and will chiefly occupy the future historian who shall analyze the consequences of this long check to movement in the West. But it is not germane to this book, which is only concerned with the history of the Marne and its immediate sequel.

What does concern me here is the dissipation of a very general error into which the present writer fell, in common with most others, when this novel development first appeared.

That error is the conception that this new phase was part of a deliberate plan already established in the enemy's mind.

## 316 A GENERAL SKETCH OF

To entertain such an error would be, as subsequent study and evidence have proved, to misunderstand the nature of the war and the psychology of the opposing belligerents.

To speak in the most general terms, there are two great departments of error to which military history is prone.

The combatant, vividly recollecting the violence and chaos around him, within the narrow horizon of his individual view, belittles plan, organization, and foresight upon the part of commanders.

The student of war, writing his account of an action or a campaign long completed, and surveying it as a whole, and with the aid of documents and maps, tends, equally inevitably, to exaggerate the element of foresight, intelligence, and plan, and to underestimate that chance which is a function of the confusion of human struggle. The greatest of the French commanders, to whom we owe the triumph of the Marne, is reported to have replied to one who asked him what his action had been upon a critical occasion: "Hazards often pass for calculation." The irony of such a criticism



applied to one's own success is very typical of the French mind.

Each of these errors needs correction. The combatant, even he of the highest grade and the most comprehensive view, will always lay stress upon the enormous element of chance, of the unexpected and of the unlooked-for development ; and if you consider the isolated epigrams, the *obiter dicta* of the great commanders, you will find them repeatedly hinting at or declaring that their very victories were thus achieved in spite of them. Their defeats they will nearly always ascribe to this factor of uncalculated disturbance.

The immortal work of Napier, perhaps the greatest of military histories, and, moreover, the study of a campaign proceeding from the pen of one who fought throughout its progress, is visibly anxious throughout to guard against an exaggeration upon this side ; but even so Napier, who saw with his own eye and felt with his own body the crash and rush of battle, does not entirely escape the error. Read, for example, his marvellous synthesis of Corunna, that miracle of the British infantry, and you will hardly dis-

cover how much was due to Moore's typically national and English eye for a defensive position.\*

But that other error which the student makes is far more formidable, and of a far worse effect upon history, because for one combatant who has related a military event we have a dozen writers who have presented it without active experience, and whose minds have been over-influenced by the tendency of the intelligence to exaggerate its own effect upon human affairs.

The trench warfare was certainly not foreseen by the Allies. *As certainly it was not foreseen by the enemy.* He had prepared nothing for it. His just appreciation of the value of machine guns, and his initial overwhelming superiority therein, was based, as we know well from his manœuvres and from many years of his orders, upon the idea that the machine gun would be invaluable in the

\* I say "typically national and English," and I could support this phrase with a hundred examples. Consider any one of Wellington's positions from Talavera to Waterloo; hundreds of years before there is the example of Crécy, and between the two innumerable subjects supporting such a thesis.

check of local counter-offensives, and even in the prosecution of rapid attack. Its value for permanent defence he seized when he was constrained to that permanent defence. It is greatly to his credit that he should so rapidly have appreciated the new conditions. But he did not plan them. The German was the superior of the Frenchman and of the Englishman in the first design of trenches. The Allies learnt from, copied, and ultimately surpassed the German in this art. But that he had foreseen the necessity of such a vast system, that he had imagined the war ever capable of turning to a clinch of immobile positions, 500 miles in length from the Swiss mountains to the sea, there is not only no evidence to show, but conclusive evidence against. All his plan was for a rapid offensive, in which he was morally certain of immediate and overwhelming success. Accident and circumstance external to his design were his tutors in this matter. The lesson was not learnt before 1914. It only began to be learnt in the autumn of that year, and during the actual progress of the campaign. His vast accumu-

lation of heavy artillery he had prepared wisely for the reduction of limited permanent works, which he rightly judged would fall to the modern siege train, but *unwisely* for use in active operations of movement wherein he *wrongly* conceived that this superiority would, under modern conditions, outweigh the comparative immobility of forces designed to reliance upon heavy guns.

When trench warfare was established his position of a superiority in this arm was invaluable to him during all the early period in which the Allies could not deliver one shell of large calibre to his twenty. But he had prepared his great pieces and their munitionment for no such object. He had prepared them for use in the field, and believed them consonant to a rapid advance. How wrong he was here, his failure to surround any one of the Russian armies during the great Eastern offensive in 1915, and his earlier failure at the Grand Couronné, his failure at the centre of the Marne and with the Ist Army, and later at Verdun, sufficiently prove. His great pieces were, indeed, far more mobile than

they could have been before the advent of petrol traction, but they still cramped his movements. The bringing up of the pieces themselves, and still more the bringing up of their exceedingly heavy munitionment, imposed upon him time after time delays which prevented the carrying through of an offensive.

The trench warfare which was established in this third week of September 1914, and which rapidly developed until it became for months the normal type upon all the Western front, was imposed upon the Germans by their defeat, and, so far from being a complete system, organized and thought out before the outbreak of war, nearly all its features developed as novelties in the course of the winter 1914-15, while continual additions and further novelties were imposed upon the enemy by necessity as the campaign proceeded. We must, therefore, conceive of the new conditions as something of a surprise to either party in the conflict: an unexpected development more quickly appreciated by the German because it was to his advantage to study and extend a defensive system to which

he found himself reluctantly constrained ; less rapidly grasped by the Allies because they still continued, though the thing was now beyond their power, to desire a prolongation of that successful counter-offensive initiated by the victory of the Marne.

That almost inevitable tendency by which we see the difficulties of our own side in war, and forget the corresponding difficulties of the opponent, led opinion among the Allies to a serious over-estimate of the enemy's calculations in the matter of defensive war. Armies flushed with victory, and proceeding rapidly from the Marne-to the Aisne in pursuit of a partly disorganized and thoroughly defeated opponent who was still greatly their superior in numbers, were checked. The check bewildered and disappointed the expectant victors, and it was natural and fatal that such a disappointment should conjure up visions of yet another superiority in foresight upon the part of the foe.

But if we put ourselves in the position of the German Higher Command we shall see things in a very different light.

Here was a General Staff which had for forty years planned and perfected aggressive war. It knew that it could fall upon the West—where its opponents had long been concerned with a thousand civic activities apart from military organization, and had of late years even neglected this department of the State—with every moral and material advantage. It knew that in the supreme factor of numbers this opponent was not comparable to itself. It took for granted—and there was no violent exaggeration in such a view—that complete victory would be achieved immediately. Every order given to the German troops during the advance amply and conclusively proves this. The whole nature of the advance proves it. The last commands, so shockingly ironical in the light of what followed, prove it, if it were necessary, still better. Remember that naïve and simple order from the Crown Prince's Staff issued upon the evening of the 5th of September, presupposing an immediate entry into Bar-le-Duc.

A command in this mood finds itself, and is stupefied to find itself, caught, held, hurled back, and at last pinned by

those inferior forces which, not a week before, it had regarded as a mere prey. That the defeated party in such a catastrophe should produce and develop a tenacious defensive, should save what it could and should cling to the first opportunity for a halt, is no more than the crude necessity of its position. That it should have foreseen and prepared for it there is neither evidence nor probability.

Trenches were, indeed, dug upon the Aisne position by troops still in the rear after the first news of the Marne was appreciated by the German command—but not before. The defensive positions which checked the Allies were positions which had the advantage of three days' preparation. They were not positions prepared of long date in the bureaus of a War Office.

If yet more proof were required for what is now so clear, it would be afforded by the fact that much the greater part of the line between the plateau of Craonne and the Forest of Argonne, which stood unchanged by even so much as a few yards for nearly twelve months up to the great French offensive in September 1915,



was *not* the line established immediately after the Marne, but a new line established by a slight German offensive undertaken after the first rally.

It is even more conclusive to note that the long, sinuous line from the corner by Noyon to the North Sea was established in the mere accidents of combat, and did not settle down to a permanent form until months of undecided movement back and forth had elapsed. The French use for the whole affair an excellent metaphor. They speak of a line "crystallizing," comparing the fluid movements back and forth before there has been time to establish permanent defence to the state of a strong solution, and the final settlement of that line in solid form to the precipitation of the matter contained in solution, and to its organization in hard crystalline form. It is an excellent parallel. Another metaphor, which I have seen used by English writers, is that taken from the formation of ice in water. They speak of the line "freezing" into its final position, and that also expresses the same idea.

There is in connection with this establishment of permanent trench warfare, and

## 326 A GENERAL SKETCH OF

of a particular line which it follows from the foothills of the Jura to the dunes of Nieupoort, one aspect which has further misled opinion to some extent.

It is the fact that this line, as it came to be established, included a considerable portion of what is politically Allied territory, and, therefore, permitted the enemy to be fighting upon alien soil. That such a situation heavily handicaps the Allies and is heavily in favour of the enemy in some respects is obvious. It is none the less accidental, and, further, it contains elements adverse to the enemy, which, though obscure for so many months, may yet appear before the end of the campaign.

The series of points in the retreat where the Germans were able to "hook on," to rally and to dig themselves in, formed a chain which stretched across French territory, left them in a very complete occupation of Belgium, and continued their political mastery over portions of several French departments. What is more important, it gave them the use of at least three-quarters of the machinery, metal, and coal available in

France and Belgium for the purposes of war.

Such a situation also permitted (for what that is worth in war—and it is worth very little) the somewhat chaotic and sporadic anger of a defeated enemy to kill civilians subject to the alliance, and to ruin monuments and private wealth, the property of the Belgians and the French. It has caused the complete devastation, inevitable to the narrow trench zone, to affect not German but French cultivation and buildings. What is far more serious, it created at first a certain timidity and hesitation—happily now abandoned—in the action of the Allied artillery. The fact that every shell delivered at long range upon German communications and nodal points behind the lines risked the lives of Frenchmen and of Belgians somewhat hampered, especially at first, the use of the guns. Politically this accident has had a prodigious effect, for it has left the civilian population of the enemy until quite recently under a complete illusion of victory, and one can trace its results in an almost comic degree through the Press

of certain of the Allies, and of nearly all the neutrals.

An accident none the less it remains, and not a design. And it is an accident which may well have results ultimately contrary to those we have just been mentioning. The form into which the line crystallized has not proved favourable to the German defensive. It has been far too long, and, therefore, far too wasteful. It has led to a perpetual friction and a perpetual expense of men for the maintenance of what is a purely political and in no way a strategic position in Belgium. It has produced a great salient which on the map appears to be pointing at Paris, but which as a strategic situation is awkward in the extreme. So true is this that the shock under which the enemy reeled, and from which he did not wholly recover when he was struck by the incomplete Allied offensive of September 1915, was only made possible by the form of that salient; and when, six months later, the Germans, after gigantic preparation, delivered their counter-attack they were confined to one of few and difficult regions—the region

of Verdun—instead of having the choice of the whole line, as they would have had if that line had been straighter. They dared not, apparently, adventure into the advanced portion of the salient, a concentration the cutting off of which would be an irreparable disaster.

When, if ever, a retirement is necessary through a diminution of effectives, to fall back from a line of such a shape will be a very different matter from the withdrawing of a straightened and well-co-ordinated chain.

Lastly, the political bait or lure of Belgium attaches to the accident of the present line. Not that it stands as a necessity in the covering of Antwerp, the chief asset, but that it almost compels the forces holding it to cover the Belgian capital and the line of the Yser. The Germans have constructed behind that front, as we know, a secondary defensive position shorter and more logical. But the retirement to it from the extreme points of the salient, something which they have certainly now studied in every detail, would be a tremendous business, and it is to be presumed that the line, strategically awk-

ward though politically advantageous, will be maintained to the very end—to an inconclusive peace, if the enemy have the power or we the folly to admit such an anti-climax ; to the very last shreds of resistance if the war be pressed by European civilization to its just end, and to the destruction of its would-be murderers.

One last matter is, I think, quite conclusive of the thesis maintained in these pages, and I would particularly beg the English reader to direct his attention to it.

If the grotesque and impossible conception of the trench line established in the West being one of deliberate German choice were true, what of the Straits of Dover and of the two tremendous defeats of the enemy upon the Yser in his attempt to reach their shores ?

Dunkirk, Calais, Boulogne, the smaller ports of St. Valery and Etaples, even Dieppe, if you will, were at the enemy's mercy before the Battle of the Marne. He neglected them because a diversion towards them would have confused his simple, obvious, apparently indefeasible scheme of crushing at once the whole Allied force in the West. When that

scheme of his came tumbling to the ground upon the 9th of September, is it to be imagined that he abandoned of free will a second opportunity for the possession of the Channel ports? Is it conceivable that he ignored their value for the reduction of Great Britain, or that he merely woke up by a sort of afterthought to his crying necessity, and, acting upon that afterthought, threw away the best of his original forces and his irreplaceable trained officers in the futile massacres before Ypres?

The thing is quite inconceivable. He stands upon the line he now holds because he was condemned to stand there, because he had no chance of standing farther, and was yet under no necessity, unfortunately for us at this moment—fortunately, perhaps, in the ultimate issue—of falling farther back. Though the statement may still raise a smile in those whom a long war has fatigued and perhaps soured, though it would have appeared quite extravagant some few months ago, I will still maintain that the ultimate trace of the trench line in the West is as much an accident for the

enemy as for us, and an accident which may ultimately prove advantageous to the just issue of the war.

But as yet this thing was only beginning. As yet the entrenched position, though of such prodigious length (from Verdun to Compiègne as the crow flies, omitting all curves of the line, it is not far short of 140 miles), had an exposed flank which, with superior numbers, might be turned. The French, with gravely inferior numbers, attempted to turn it. The new German line reached only to the Oise. Between the Oise and the Channel was a very broad belt in which armies might yet manœuvre. And already before darkness set in upon that Wednesday, the 16th of September, Maunoury was beginning to work round up the Oise valley with certain of his units, and to threaten the exposed right of the enemy.

From that moment for a full month and more all the interest of the campaign turns upon the measure of success which this new development northward of the entrenched German line achieved. Turn that line, or even threaten its communi-



cations, it could not. Inferior numbers do not turn the positions of entrenched superior numbers, and the attempt to do so was the attempt to work a miracle. But the Allies *did* prevent those superior numbers from counter-enveloping in their turn, and, what is perhaps more remarkable, they prevented in this new development (which has been called "The Race to the Sea") the seizure of the Channel ports by the Germans—with what enormous consequences to the future of the war was then but dimly seen, but within a year was clearly apparent.

All the 17th and all the 18th of September, the Thursday and the Friday, the Allies, while holding the German left strongly by repeated attacks, were still working up painfully beyond the Oise. The advanced bodies of Maunoury's left which Joffre had reinforced had reached the neighbourhood of Lassigny, and I have heard, but not with sufficient evidence, that one body of daring cavalry made a dash at the main German line of communication far to the north and cut a bridge upon the great railway that follows down the Oise valley.

## 334 A GENERAL SKETCH OF

This line of communication was the very vital artery of the German position, and that the Allies, with inferior numbers, should have been allowed to threaten it even for a moment is one of those many

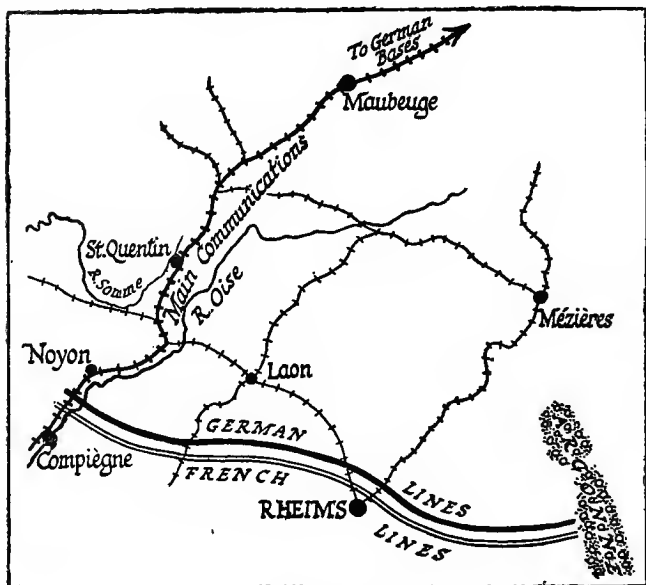

Sketch 75.

points in the history of the campaign which will puzzle or baffle the future historian.

Why, indeed, did the Germans, still enjoying such an excess of effectives com-

pared with their opponents, allow the turning movement to take place at all ?

To-day, because the " Race to the Sea " actually occurred, and was won by the Allies, we take it for granted. But the more one considers what the enemy's opportunities were, the more astonishing does that result appear. They were entrenched, and could presumably hold their entrenchments with less men than those required to attack them. They had masses of rolling stock and the chief centres of the French northern railway system at their mercy. They had this great superiority in numbers. They surely knew what the Channel ports would mean to them. They certainly were vitally concerned for their great railway down the Oise valley (which cut, they were lost). They indeed thoroughly saved this from attack, but they allowed it for a moment to be imperilled. They initiated no turning position against the French ; on the contrary, they allowed the French to take the initiative in this. They even failed at the end of the business to use the remaining rapidly closing space between the armies and the sea, and when—far too

late—they did mass a great bolt to strike the left of the Allied line at Ypres, it only so struck against a door locked and bolted against them.

Why did an army in such a situation, having achieved the initial advantage of securely holding this entrenched line from Compiègne to the Argonne, lose its last opportunities? It is far too early to provide the answer, and I should not presume even to suggest it. But we may usefully set down a list of factors in the position, all of which certainly existed, some or all of which combined may ultimately explain the mystery, but the relative weight of which among themselves we are as yet unable to determine.

1. The army which fled from the Marne and entrenched itself on the Aisne and the line of the Suipe across Champagne to the Argonne was, after all, a badly defeated army; and though you are superior in numbers, if you have recently suffered a severe blow you cannot act with the freedom and rapidity which was possible to you while you were in the tide of success. Your gaps must be replenished; your battered units reconstructed and con-

firmed. Your *cadres*, which in places will have been half obliterated, must be renewed. We have noted that it was five days (from the 12th to the 18th of September) between the rally of the enemy on his entrenched line and his first vigorous counter-offensive from the left.

2. From long before the Marne, and all during the Marne, there had been an excessive concentration upon the left or east of the German line, due to that original error in his conception, the idea given him by the Grand Couronné, that the French had also principally concentrated in the east. The Germans, with their detailed method, were not particularly rapid in their use of railways, and the bringing of considerable masses from east to west in sufficient time was beyond their power.

3. Though their railway gauge is the same as the French, it is possible that we overestimate the rolling stock at their disposal. You must set eighty trains at least to a division. They had had no time to double single lines or to construct new ones, and the French had naturally during the retreat withdrawn

as many wagons and locomotives as they could.

4. As their movements showed in the next few days, the Germans possibly or probably still relied more upon a counter-offensive against the French centre and the driving of a wedge between Foch and the 4th Army. This would be consonant with all we know of their attachment to routine, and their repetition not only of successful strokes, but of strokes that had nearly succeeded. All through their action in this war this character has been apparent. The whole plan of the war was but a vast repetition of 1870 in its initial stages. The victory they conceived was a sort of magnified Sedan, an envelopment of the French round by the left, their own right; and even in the details of the campaign we have continually seen the same tendency from that day onwards. The attack on the sector of Verdun, for instance, in process as I correct the proofs of this book, is but a large edition of precisely similar efforts which had proved successful nine months before in Galicia.

We may, therefore, conjecture for what

the conjecture is worth, that the Germans clung too long to the idea of a counter-offensive piercing the French centre near Rheims, just as they had attempted, and failed, to pierce the centre at La Fère Champenoise. It was not, as we shall see, until the 28th of September that this plan was wholly given up, and if they were wedded to it they clearly could not at the same time make their principal effort to the west.

5. We are the more prepared to believe that they hoped to retrieve their fortunes by this pushing of a wedge through the French centre, from the fact that they developed a corresponding and contemporary attack upon the heights of the Meuse, proposing to combine with their pressure against the 4th Army in Champagne the ruin of the 3rd Army under Sarrail in the Verdun district, by striking *again* at the forts upon the Upper Meuse, crossing that river, and appearing in Sarrail's rear. They did in fact, as we shall see, get as far as St. Mihiel, and actually occupied a bridge-head beyond the river at that point ; and as late as the 24th of September it looked as though they were

## 340 A GENERAL SKETCH OF

going to succeed in putting a great army over the Meuse. But such a concentration on the east prevented the use of men to the west along the Oise.

6. Lastly, there was the embarrassment of Belgium and of Antwerp. Facile as was the task of occupying little and

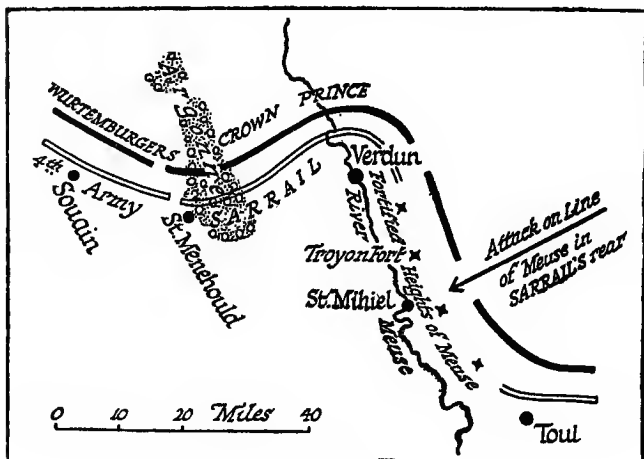

Sketch 76.

neutral Belgium and destroying its defence, they had from the beginning grossly underestimated the difficulties even of such a task. Right through the first year and a half of the war, up to the moment in which these lines are written, the mere occupation of Belgium has cost



them more men than they had dreamt would be necessary, and in these earlier days, the September and early October of 1914, they had not yet even accomplished the preliminaries of that task. The Belgian Army still in existence, sheltered behind the forts of Antwerp, was capable of offence against their communications, and was about to undertake that offence.

Whatever be the true proportion to be given to any one of these causes in the whole combination, the enemy did as a fact allow the French turning movement with inferior forces to get the start of him on the Oise near Noyon.

Already by the 16th General Joffre was withdrawing forces from all along the line to form two new armies, to which were given the titles 7th Army and 10th Army, and these once formed were sent up by rail, with that rapidity in the use of this communication which has been of such value to the French throughout the campaign, to positions north of Maunoury's turning movement.

It was upon Sunday, the 20th of September, that the 7th Army was in

## 342 A GENERAL SKETCH OF

line. Castelnau had been brought round from the east to command it; a wise choice of a man who had proved himself so thoroughly at the Grand Couronné. He was able to take a line up

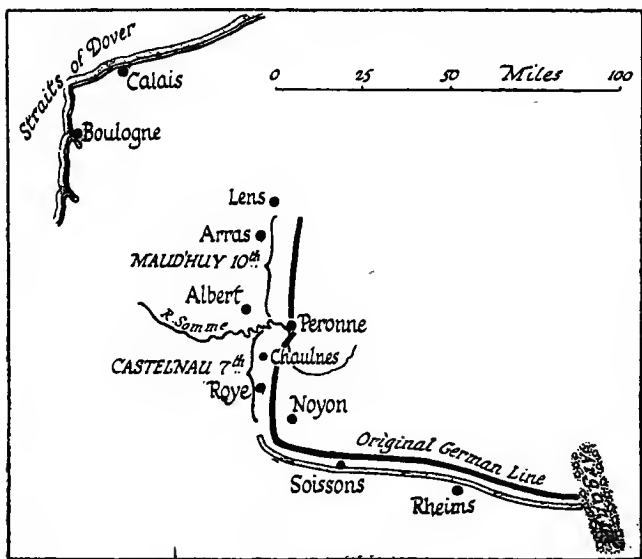

Sketch 77.

through Roye in front of Chaulnes to the Somme, near Peronne.

The 10th Army was concentrated in its turn during the next ten days, and by the 30th of September was pushed up north, continuing to Castelnau's line, and

covering Albert and Arras as far as towards the region of Lens.\*

This 10th Army was put under the command of General Maud'huy. His promotion had been very rapid and thoroughly deserved. At the beginning of the campaign he had held the rank of a general of brigade at the age of fifty-seven, fighting in Lorraine, his brigade being the 80th, and forming part of the

\* The numbering of these forces continues the puzzle we noted in an earlier page upon the numbering of the armies at the Marne. We saw there that in order of formation Foch's army should logically have been the 7th, and it is perplexing to find a force gathered so late as the 20th of September bearing this number long after the so-called 9th Army had been organized. It is still more perplexing to see the army in front of Albert, organized ten days later, bearing the number of 10, while, to complete the mystery, the 8th Army, the last of the series, does not appear until the very end of the movement in the extreme north. If the French, like the Germans, had had a very considerable excess of men whom they could bring forward at leisure we might imagine these forces to have been present somewhere behind the line, and only brought up as they were needed, but the French had no such advantage. The new armies did indeed contain certain rapidly trained and novel elements, especially the Marine contingents, but their nucleus, or rather their bulk, was composed of forces which had already been in the field and had been taken from other parts of the line. The problem, therefore, of this system of enumeration remains unsolved. We shall, I presume, be able to understand it after the war, but not until then.

40th Division in the 8th Corps. He had appeared in the retreat commanding a division, and in the Battle of the Marne commanding a corps—the 18th, in the 5th Army. He was now, in three weeks, arrived at the rank of an army commander controlling a whole group of corps, and with independent initiative entrusted to him in the Higher Command—a striking example of the flexibility which the French determination upon victory could impose upon the whole service.

With the formation of Maud'huy's army, the French line threatening to turn the German, and extending up northward to the sea, had almost reached the Belgian frontier only a fortnight after the first hints at such a movement had appeared. It was high time for the Germans to follow suit; not only in the disposition of their troops (for these had already, of course, met every French development northward by a counter-stroke and an attempt at counter-envelopment at each successive prolongation of the French line), but by changes also in the disposition of their mass and in the partition of their commands.

The attempt to destroy Sarrail and the French right had failed by the 24th of September. From that day onwards it was clear to the German commanders that they could not cross the Meuse in force at St. Mihiel, and so take Sarrail from behind. The attempt to drive a wedge in through the French centre had failed by the 28th, and the enemy awoke to the fact that the centre of gravity of the war had shifted northward. He began to move troops up from east to west and from south to north, and to change his generals. He left Alsace with probably no more than one army corps to guard it; gave over to Strantz (whose effort against the Meuse at St. Mihiel, just alluded to, I will presently describe) the guard of all that frontier. He began to send the Bavarians north to the plains of Flanders and of the Artois from the positions where they were still uselessly massed upon their old scene of defeat in Lorraine. He sent up the Duke of Wurtemberg, also, with many of his men from the neighbourhood of Argonne, filling the gap with older men, reserves arrived from Germany. He did the

same thing with Buelow's position between Rheims and the Aisne, moving that commander and his troops up to the west, and right beyond Kluck. Not less significant was the replacing of General von Moltke, hitherto Chief of the General Staff, by General von Falkenhayn, the Minister of War. And with the 6th of October the presence of great masses of German cavalry near Lille showed that the enemy was only waiting for the fall of Antwerp—the significance of which event must be appreciated upon a later page—to use the gap still remaining between the end of the extending Allied line and the sea.

Precisely at this moment was effected by the Allies a similar and most important redistribution of troops, consisting in the transference of the whole British Army upon the Aisne right northward to the sector of Ypres. But before dealing with this I will go back to describe in detail what those last efforts were in the centre and upon the Meuse, for the piercing of the French centre and the destruction of the French right, to which I have just been alluding, and the failure of which

we must understand if we are to grasp why the Germans delayed so long in attempting to win the race to the sea, and also how that delay was due to their disappointment at the other end of their line.

If we sketch out upon the map the whole German line from the Swiss frontier to Compiègne at the moment when the pursuit after the Battle of the Marne was checked by the entrenched German rally, we find it to be of this shape. In that alignment what I have called the effort in the German "centre" (that is, the centre of the new line between Verdun and Compiègne) was made just east of Rheims at A. It was upon the 17th of September that Foch, who lay in front of this German centre at A, lost the heights round Rheims, and all that day his army, from which units had already been taken for the new formations, decided upon by Joffre twenty-four hours earlier, had a very hard task. That same corps of the Guards which he had beaten so decisively at La Fère Champenoise the week before had received new guns and fresh drafts, and was pressing him hard. It was

## 348 A GENERAL SKETCH OF

Buelow who commanded this attack, and he relied not a little upon the difficulty which Langle, with the 4th Army, also felt to the right of Foch in holding his own against a similar counter-offensive there

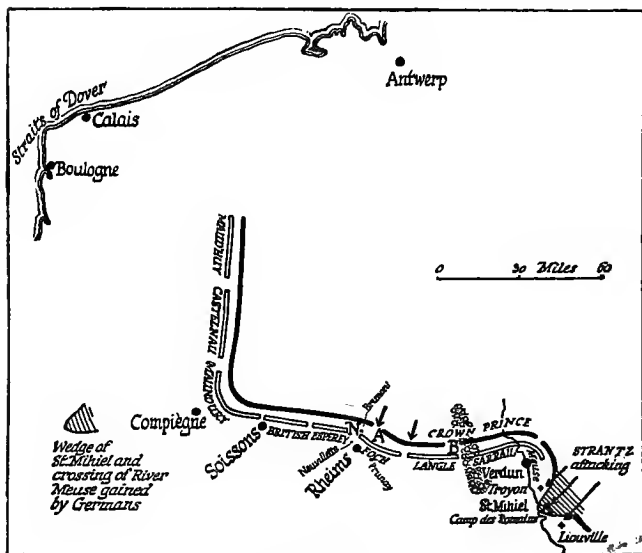

Sketch 78.

undertaken by the Germans between A and B. All the 18th this pressure continued. At one moment it actually reached the railway which runs across the Champagne eastward from Rheims, and the German advance at that moment had all



the appearance of forcing Foch's line. It was during that same Friday, the 18th, that the bombardment at Rheims began, following upon which came the first news of the attack upon the cathedral. It is an incident that has never been explained, and that remains to this day inexplicable save to those who can profess (as surely many should be able to do) a knowledge of German psychology.

The Cathedral of Rheims stands out an enormous mark at such a range of 7,000 yards. Whether that mark was chosen through the wantonness of a subaltern, or in obedience to the highest command of all, we do not know. Still more extraordinary was the bewilderment of the enemy upon finding the effect produced upon neutrals by this extraordinary act, and his subsequent belated apology and orders to spare the monument for the future. The whole thing is a riddle, the solution of which might be of value if it would lead us to understand the enemy's mind, and therefore, perhaps, his errors in strategy. For most men in the old civilization of Europe the act itself, but still more the sudden recantation of it

and the failure to continue on the same lines, make no sense at all. It was doing oneself the maximum of harm for the minimum of result. But to leave that side issue, which is of no military importance, and to continue the story of the German effort.

The pressure upon the centre continued for over a week, and at its maximum intensity the enemy reached down to the almost suburban village of Neuville, upon the other side of the town at N, upon the sketch map just given.

It was not until the 28th of September that, presumably owing to reinforcement, Foch could recover himself ; but on that day the recovery was complete. The station of Prunay was retaken, the railway line cleared, the main road just to the north crossed, and in the immediate neighbourhood of the city itself the enemy was driven back all the way to Brimont. The front as a whole was disengaged, and the attempt to break the French centre by a counter-offensive had failed.

We shall not, however, understand what the full scheme was, nor how near it came to success, unless we read in connection

with this attack upon the centre the contemporary attack upon the heights of the Meuse behind Sarrail.

The scheme was not only to break the French centre at A (in the same map), but at the same time to come round behind Sarrail (who was at the moment pressed by the Crown Prince's army) and destroy the French right wing. From Toul southward past Nancy stretched the mass of the French 2nd Army; but between Toul and Verdun the French relied mainly upon the fortified heights of the Meuse, and held them with very small forces. It was upon these heights of the Meuse that the new blow was struck.

We left Sarrail, after the victory of the Marne, it will be remembered, with a small force of less than six divisions, three of which were the older men of the Reserve. Against this and the garrison surrounding Verdun something like fifteen divisions were at work. The Crown Prince deployed against Sarrail four full corps of two divisions each, some of whom probably counted a reserve division as well; and while Sarrail was suffering this pres-

sure of superior numbers, just at the moment also when the German counter-attack upon the centre was developing, upon the 20th of September, a new army, consisting of some eleven divisions recently arrived from Germany, struck in against the forts of the Meuse, right behind Sarraill. It was commanded by that same Strantz whom we saw earlier wheeling round with his one corps to attack the northern flank of the Grand Couronné position, and it had been drawn from the dépôts in the south of Germany.

This attack depended for its success not only on those very greatly superior numbers unrolled against the thin line of troops opposed to it, but on the unbroken experience of this war—that permanent fortification would go down before the modern siege train. Such a train accompanied the new army, and the first great shells began to fall on Fort Troyon, the central part of the line, on this Sunday, 20th September. Troyon did not fall, but at the same time the guns opened on the Camp des Romains fort, and on the third of the forts in the centre, the fort of Liouville. All three works were sub-

jected to the same intensive bombardment for several days. Resistance was merely a question of time and of the quality of the troops. Troyon and Liouville, battered all to pieces, yet found it possible, the one to repel, the other to ward off an infantry attack after five days of the enemy's efforts. The Camp des Romains was rushed after three. With its fall the German advance occupied St. Mihiel on the river, crossed and held a bridge-head on the far side. At that moment it looked as though the French right wing under Sarrail was lost, and as though the full weight of forces, more than double his own, would now converge upon him from in front and from behind. But what followed was yet another proof of how throughout this war the German effort is dependent upon mere numbers.

There was no reinforcement from the rear possible for Sarrail. There were no reserves available. But, with some little aid from the depleted troops to the south, Sarrail just managed to relieve Troyon and Liouville, and to block all further progress of the enemy beyond the river. The German stands to this day, after

twenty months, where he stood then—just barely holding on to a bridge-head west of the Meuse, with the French trenches upon the hill above.

Here was shown what value still attached to permanent works, thoroughly though the war had exploded the old theory which relied upon them. It was the resistance of Liouville and of Troyon which had condemned the Germans to so very narrow a front at the point where they touched the Meuse, and it was the narrowness of this front which prevented their pressing forward and taking Sarrail in reverse.

Though this failure, coupled with the failure of the German centre a day or two later, had decided the security of the French right, the Crown Prince made one last effort against Sarrail from the north as late as the 3rd of October. It broke down altogether, and this curious subsidiary enemy scheme, which at one moment seemed not far from success, was at an end. He was now compelled to abandon all hope of advancing from the entrenchments where he had rallied, and to consider, somewhat hurriedly, the

necessity of meeting the rapidly-extending French line in the west, which had already reached beyond Arras, which his counter-moves had, indeed, prevented from menacing the main railway, but had not prevented from checking all opportunities of a general turning movement against the Allies by the west and north.

This was the moment when Antwerp was at last tackled by the enemy forces in Belgium. The task of its capture was so slight that the result was a foregone conclusion ; but its resistance had at least this value, that no great effort could be made to pass through the remaining gap between the end of the French line and the sea until Antwerp was disposed of.

The fall of the city, from its immense strategic and economic importance to the naval and commercial power of Great Britain, produced an effect upon opinion here upon which I need not linger. As a military event we must be content to deal with it very briefly, for it was but subsidiary to the general problem. The historian of the future will, I think, ask why the Germans attacked Antwerp so late. He may even ask whether the

## 356 A GENERAL SKETCH OF

enemy could not see what cried aloud to him upon the map—the remaining gap open between the French Army and the shore. That this gap did cry aloud to

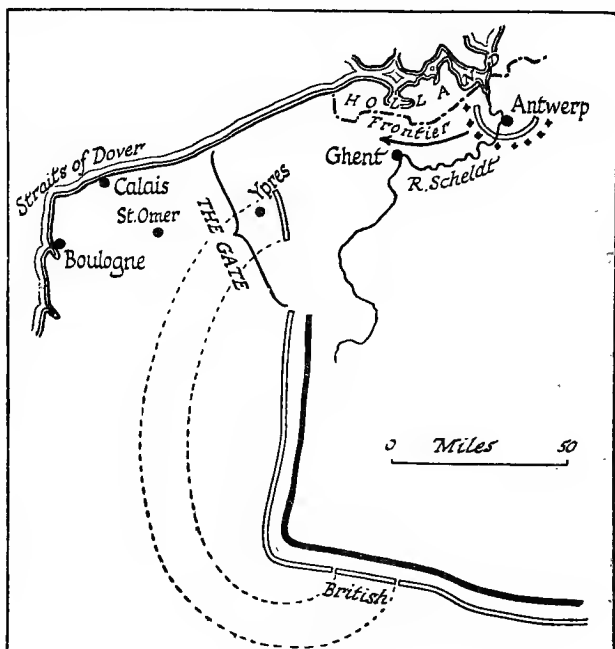

Sketch 79.

him we may make certain. Why he delayed so long in attacking Antwerp, only official documents, ultimately available and now not known, will inform us.

The first shells were not directed against



the outer forts of Antwerp until that same 28th of September which had seen the close and failure of the German attempt upon the French centre in Champagne. Three days later the southern forts had fallen, and the Belgian commanders and Government proposed the really obvious course of withdrawing the army while there was yet time. For it was clear that the organization of this little neutral Power, and the condition of its munitionment and guns of position, were quite inadequate to resisting the enemy's siege train. Their wise resolution was delayed, as we know, by the promise of aid from this country. We also know in this country the nature, the extent, and the value of what was promised. We know to the full its inadequacy, and I should mar my book if I were to admit here the adjectives proper to such a plan.

These reinforcements, 6,000 in number, arrived upon 4th October. The next two days were filled with a field battle, to enable the Germans to approach their heavy artillery towards the inner forts; the bombardment of the city itself was begun on the 7th. Upon the 9th, a little

after noon, the first German officers drove into the abandoned town, and signified to its remaining authorities that it was under their authority.

I call the town abandoned because the great bulk of its population had fled—some across the frontier into Holland, some westward by the road which had seen the successful retirement of the Belgian Army. For this retirement *was* successful, although considerable bodies, misdirected in the darkness, were lost to the war by crossing the Dutch frontier, where they suffered internment; and though a portion of the British contingent, through a misdirection of orders, were left too late, and fell into the hands of the enemy.\*

Here it may be asked how any retirement was possible at all. Antwerp lies cooped up within its forts against the Dutch frontier, as the foregoing sketch map has shown. The retirement was effected along the line of the arrow towards the west. Why did the Germans, advancing

\* The total number interned in Holland was not quite 20,000, of whom I understand that rather over 1,500 were British; 800 of the British contingent out of a total of 6,000 fell as prisoners of war to the enemy, 37 were, I believe, killed, 193 were wounded.

in such numbers against the city, leave that gap open ?

To this, as to a dozen other similar questions we might put in the course of the war with regard to the enemy's blunders, there is as yet no reply. We only know that he did, as a matter of fact, fail to cross the Scheldt. He made no serious attempt at it. He had not even occupied Ghent, which lay open to his hand. He had remained upon his own side of the stream, and that for no reason which the mind of man can conceive, or which he or any of his apologists have been able to put forward.

This belated attack upon Antwerp, coupled with the incredible omission to seal up issues from the town, was one of the factors in the closing of the northern issue for the German armies. Antwerp, as we have seen, was not occupied until the 9th of October, and already there had begun the last of those great movements for closing up the gap of which I spoke some pages back. The British Army had begun its famous and secret mutation from the banks of the Aisne to Ypres, the gap it left being filled, as unit after

unit left, by the older men of the French reserves. It was as early as the 3rd of October that the first British unit, General Gough's 2nd Cavalry Division, was moved. In a fortnight the whole mass of three army corps had been passed by rail right round the back of the armies without a hitch, and in a secrecy so complete that the enemy had no knowledge whatsoever of the movement. By the 19th of October, before the effect of Antwerp could be felt upon this front—or at any rate before the enemy had brought up his armies against it—the last units of the 1st British Corps were detraining at St. Omer. The great German mass which had hoped to pass between the end of the Allied line and the sea had long been in movement, but it was too late. The door was shut. The Race to the Sea had been won by the Allies.

There was to follow—now that it was too late—an enormous effort upon the part of the Germans to break out, which effort we call in this country “The Battle of Ypres,” though it included, of course, blows equally expensive and equally futile against the last northern sectors of the line

which the French and Belgians held between Ypres and the coast.

With that tremendous failure, in its own negative way a thing as decisive as the Battle of the Marne itself, I am not here concerned, and with its advent I terminate this part of my study.

I have dealt thus briefly and superficially with the Race to the Sea because I am considering it only as a sequel to the Marne, and only showing in the roughest and most general fashion how the extension of the line from Compiègne northward sealed the results of that great action. A fuller consideration of the Race to the Sea belongs rather to the story of Ypres, and the actions upon the Yser, than it does to the story of the Marne.

*Summary of the Sequel to the  
Marne.*

When we survey as a whole these apparently confused movements which filled the last weeks of September and the first days of October 1914, and which ultimately prolonged the line from the Aisne

## 362 A GENERAL SKETCH OF

to the Northern Sea, we shall, subject to the reserves inevitable in a general statement, be able to give it a diagrammatic form which is also an explanation of its nature. That form may be illustrated in the accompanying sketch.

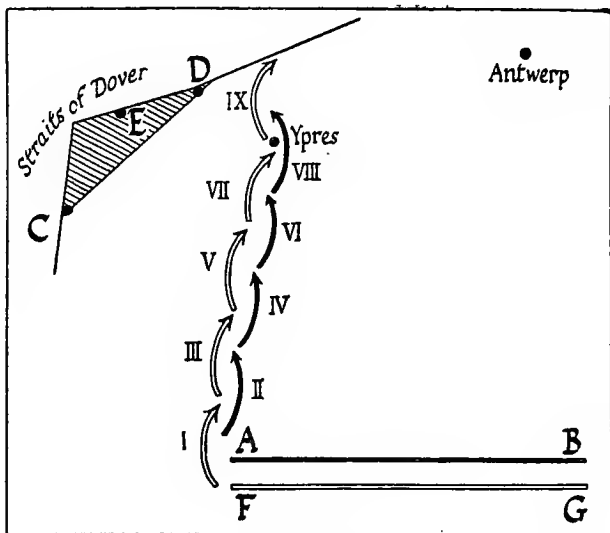

Sketch 80.

The original line of the Aisne (using that term for the whole line from in front of Noyon to in front of Verdun) we will represent by the full line AB upon the sketch. The coast of the Channel we will represent by the line CD, shading the

critical portion between Dunkirk at D and Boulogne at C, Calais at E. This critical portion commanded the Straits of Dover.

Then the progress northward may be compared to a series of clutches hand over hand made by one opponent against the other alternately, until the full extension of the line is reached, and no further progress is possible to armies having reached salt water.

You have the first attempted turning movement by the French at I.; the Germans check this, and produce a turning attempt of their own at II.; the Allies checking this, again, with a further attempted turning movement at III.; the Germans in turn producing *their* answer to this at IV., and so on throughout V., VI., VII., VIII., and IX., with which last the gate is finally closed and the German forces contained.

In this process I think that history will remark an almost inexplicable German failure.

It is true that the French, and later the British, were occupied in an effort to turn the enemy's line, and failed to

achieve that result. But, on the other hand, we must remember that the fundamental character underlying the whole war till many months after this date was the immense numerical superiority of our opponent in mere effectives, and his overwhelming superiority in machines. It might conceivably be maintained as a possibility that an inferior force should have succeeded by surprise and very great rapidity in turning the original German flank at A, supposing the Germans to have been abnormally slow in movement and abnormally—almost miraculously—blind to their danger. They were, of course, neither : they could move more quickly than we could, because their movements were on short lines from within ; ours on long lines from without. They had established a stronger defensive by far between A and B than were our corresponding newly entrenched lines in front of them from F to G. They could, therefore, hold from A to B with a less number of men than we needed to prevent their breaking out again from that front. On the top of this they had more men than we had wherewith to meet our



turning movement as it progressed ; and the marvel is, not that we failed to turn their line, but that *they* failed to prevent us from denying them the Straits of Dover ; and that they found themselves, in spite of their superior numbers and interior lines, pinned to a final trench position which forbade them the use of the Channel ports. In the result it was this which condemned them to the utterly unfruitful sacrifice to which they submitted themselves in front of Ypres later on.

Such is the first note we make upon the sequel to the Marne. The Germans had added to the enormous blunder which got their EIGHT driven back and pinned by the opposing FIVE the further blunder of letting those inferior opponents close the northern gate and complete their barring in and containing of a superior foe.

But while activity of intelligence was thus the great asset of the French, and had strategically triumphed, there was to appear in the immediate future another matter which neither side had foreseen—a thing novel, peculiar to this entrenched warfare (coupled with modern defensive power), and one which nearly redressed

the balance in favour of the Germans. I mean the new conditions which rendered *heavy artillery* the capital arm of the next few months ; and to that point I will turn before ending this book.

With the fixing of the enemy to a trench line, and his confrontation against a closed defensive line of our own, terminate the second phase of the great war and the immediate effects of the Battle of the Marne. Prussia and her allies and dependants had attempted conquest over the West with forces enormously superior, and, humanly speaking, certain of success. Prussia had allowed herself to be beaten, pinned, and driven to earth by armies only two-thirds of her own in size. She had made a belated and disordered effort to prevent the establishment of lines that now contained her right up to the sea, and she had failed.

Had there alone been present in the situation the factors already apparent in these first portions of the war, the conclusion of the campaign, though perhaps long postponed, would have maintained a similar character to the end. Succeeding

efforts to recover freedom of manœuvre would have followed, each a little less vigorous and a little less intense than the last, until in the conclusion of the affair Prussia and her allies would have yielded to exhaustion. Perhaps six months, perhaps twelve, would have decided such an issue.

But there was present another and novel element which was to prove of the utmost weight in the future of the campaign, to disturb many a calculation, to give the enemy a new lease of power, and in part to transform the character of the war.

This novel element was a wholly unexpected development in the rôle of artillery.

To mark the character of this transition, and to comprehend the cause of all that followed, it is essential that I should conclude this study of the second phase by presenting to my readers as clearly as I can the nature of this revolution.

At the moment when Prussia declared war upon civilization in the summer of 1914 it was the common opinion, or rather

## 368 A GENERAL SKETCH OF

certitude, of all the General Staffs—and of none more than the Prussian—that modern war would take the following form, and be determined by the following weapons:—

The victorious army, vigorously pursuing an offensive in the open field, would envelop or break its opponent; it would accomplish this by fire from its field guns, and perhaps by additional fire from heavy pieces rendered sufficiently mobile to take the field. Succeeding to such preparations, the attack of the infantry in succeeding lines, their fire power from rifles, and sometimes their actual shock, would be the ultimate and decisive blow that would bend round before it or drive in the opposing formation.

For a campaign of this kind it was possible to calculate the reserve of munitions necessary to its conduct for a certain length of time, and the rate of production per month or day necessary to supply any prolongation of such expenditure of shell.

Such reserves or stocks of shell the French, the Russians, the Austrians, and the Germans had alike prepared, and their arsenals were designed and organized to a

further rate of daily supply conceived to be normal to a great modern war.

The greater part of this supply must, in the nature of things, consist of munitions for the field guns, since the lighter pieces deliver immensely larger quantities of shell in a given time of action than the heavier; *and these munitions must for much the larger part be of shrapnel*. Even for the heavy guns shrapnel would be a considerable proportion of their munitionment if they were to be used in the field. For shrapnel delivered against troops in the field does execution of a totally different sort from the execution of a high-explosive shell.

A shrapnel shell is a case filled with bullets, and itself on explosion designed to burst into a great number of fragments. These fragments and the bullets, upon the expiry of the time to which the fuse is set, or upon concussion, are discharged over a wide area known as "the cone of dispersion," and within that area destroy, if the fire be accurate, the troops opposed.

The high-explosive shell, on the other hand—that is, a case filled not with many pieces of metal, but one charge of some

## 370 A GENERAL SKETCH OF

unstable chemical compound which on explosion produces a very powerful local effect—has some moral result upon troops in the open, the effect of which will be discussed in a moment; but its calculable material effect upon troops in the open is inconsiderable compared with that of shrapnel.

The high-explosive shell has a very violent effect confined to a comparatively small radius—that is, a radius small compared with the calibre of the missile. Where it falls the earth is all knocked to pieces, and a shallow conical hole, larger or smaller according to the size of the shell and the nature of the soil, is blasted into the surface, but the damage is confined to a small area.

The result is that firing high-explosive shell in the field at troops in the open, though the great noise shakes men, and the explosion will utterly destroy things in its immediate neighbourhood, is a waste of effort compared with the firing of shrapnel against troops in the open. To give a rough parallel, it is the difference between shooting at game with shot and shooting at them with an explosive bullet.

Quick-firing field batteries playing upon troops in the open would, in a given time, do fiftyfold the execution that a similar weight of gun-metal in the shape of heavy pieces attacking the same troops with high-explosive shell could hope to effect. Such was not only the obvious truth from *a priori* considerations, but the truth also arrived at by experience in the South African War, as well as in the great Manchurian campaign. These amply confirmed theories which no man could reasonably doubt, and which no one doubts to-day except, perhaps, a few politicians who have imperfectly learnt their briefs.

But though these truths are of the importance and certitude just described, though shrapnel was the missile determining all *open* war, and though its accumulation was ample for the work to be done in such a war, it is clear that the whole use of shrapnel and of its accumulation turns upon the conception of troops manœuvring in the field.

Now, by an accident which no one had foreseen, the great war within a few weeks of its inception turned into trench war-

fare. I say "an accident which no one had foreseen," using that phrase somewhat loosely, for individuals here and there had hazarded the guess that a great modern war would degenerate into trench warfare before it ended. But military opinion as a whole had not foreseen this, no more upon the enemy's side than upon our own. Trench warfare was possible because the enormous numbers mobilized permitted the trenches to extend over hundreds of miles, and to repose upon flanks that could not be turned. To hold a line of trenches the flanks of which are not secure is obviously to invite disaster. It is to destroy your mobility without obtaining any corresponding advantage; and if your enemy is so foolish as to dig himself into a limited line with open, unprotected spaces at either end, you can by either of these ends turn him, come round upon him, and destroy him. But the vast numbers put forward in this great war soon developed lines of trenches from the Carpathians to the Baltic, and from the Swiss mountains to the North Sea, which either had no gaps, or gaps nowhere so broad as to permit of the passage of troops in



great numbers, and the turning of the defence.

But once such trench warfare was established two things appeared, each unexpected, and each of them transforming the nature of the campaign. First, the high-explosive shell, not the shrapnel, became unexpectedly the essential missile. Secondly, the supply of shell needed was unexpectedly extended—multiplied enormously and beyond all previous calculation.

1. The first of these new developments, I say, was the elimination of the rôle which shrapnel plays in open war, and the substitution for it as the chief missile weapon of the high-explosive shell.

Shrapnel is useful in destroying entanglements in front of a trench. It has its uses for the "searching" of a trench, especially for the "searching" of communication trenches when troops are passing up and down them, and its fire can check at the outset the attempt of troops to leave their trenches and attack. But shrapnel cannot destroy a trench. The artillery preparation necessary for pounding earthworks of any sort—and trenches

in the field are nothing else—the turning upside down of such prepared lines, the confusing and dazing of their occupants, and the breaking up of their parapets and shelters, falls entirely upon the high-explosive shell, and upon the high-explosive shell of some calibre. Heavy guns larger than field-pieces, guns of 4, 5, 6, 8 inch, and even more, must be used in such work, and must supplant the field-piece.

The moment trench warfare breaks up, and mobile warfare takes its place, these conditions are again reversed. Shrapnel replaces the high-explosive shell, and the field-piece comes to its own again as against the heavy gun.

It is, of course, true that the heavy gun and the high-explosive shell used in very great numbers against troops that cannot reply, even though they be mobile troops in the open, do an immense amount of execution, and can blast a way through any resistance. They can fire from ranges where they are out of danger from the field batteries.

But an army reasonably well equipped with heavy guns as well as amply provided with field guns and their munitionment,

could always meet and defeat another equal army which relied only upon its heavy artillery. Roughly speaking, reliance upon heavy artillery destroys the power of rapid decision in the field.

We had, then, this situation with the late autumn and early winter of 1914 :—

Great nations were engaged in war, each possessing its great stock of munitions for artillery. But each had accumulated such a stock under the conception that the war would be fought in the open. Finding that the war turned, as a matter of fact, into trench warfare, and suddenly called upon to provide high-explosive shell principally instead of shrapnel principally, and discharge that shell from large guns 4 inches and upwards, instead of from field-pieces, all were taken aback. Each group of combatants had now to take part (from October 1914) in a sort of race to see which could ultimately out-produce the other in a type of shell which neither was fully prepared for.

Such was the first of the two new and unexpected things which transformed the nature of the campaign.

2. The second new and unexpected

thing we have also seen. It was this : Not only was the foundation, so to speak, of artillery work turned by the necessities of trench warfare from being mainly a shrapnel foundation to mainly a high-explosive foundation, and from being based mainly upon the 3-inch shell of the field batteries to being based mainly upon the 4, 5, 6, 8, 9, and even 11 inch shell and upwards of the heavy batteries, but at the same time it was discovered that the *amount* of such shell needed for trench work was not twice or thrice or tenfold the old calculated amount of shell needed for field work, but immensely more—one hundredfold and two hundredfold. The old stocks and reserves, the old calculations of what would be necessary for so many months of war, went utterly by the board. A mobile war, with troops manœuvring in the open, might, in addition to a number of minor actions, develop, say, five or six great battles at the most in the course of, say, three months. The rest of the time would be passed in the retreat, the pursuit, the manœuvring and counter-manœuvring of the various troops, and only on

the decisive days would there be a great expenditure of ammunition.

But when the war developed (to every one's surprise) into a mere siege work against trenches upon either side, the pounding against trenches which was necessary to wear down an opponent was a matter of ceaseless fire hour after hour and day after day for months, and that along a line of hundreds upon hundreds of miles.

The whole of this novel situation may be compared to the situation of two competing engineers, each engaged in cutting two neighbouring canals through soil of which each believes that he knows the resistance and the quantity. Shortly after the inception of their task the whole problem is transformed by an earthquake. The amount of soil to be cut away surpasses their original calculations one hundredfold and more. Neither has provided the instruments necessary to the new state of affairs ; each is at a loss, *but accident may have provided one of the engineers with a great temporary advantage.* He may—not because he foresaw that there would be an earthquake, but for

## 378 A GENERAL SKETCH OF

totally different reasons—be possessed of instruments which his competitor lacks, and which enable him to deal with the new conditions earlier and more readily than his competitor can.

Such was the position of the Austrians and the Germans when they found themselves faced by the unexpected conditions of the new trench warfare. For two reasons purely accidental to the new development, and in no way due to any foresight of theirs, the enemy enjoyed for months a great superiority over the Allies ; the Allies suffered a corresponding handicap against the enemy.

What these two conditions were I shall now proceed to describe.

The first was the enemy's possession, largely through the industry and cleverness of the Austrians, of a very large mobile siege-train.

This provision of heavy guns, with their munitionment, and, of course, with the plant behind them in the factories to produce more such munitionment, this store of large shells of high-explosive type was quite unconnected with the present trench warfare, or any foresight thereof. Never-

theless it came from one of the enemy's good guesses. The enemy had, as we have seen in a previous volume, differed from the French school in believing that isolated permanent works of small area could, now that distant fire was capable of regulation from the air, be overwhelmed by a large modern siege-train. This guess proved to be right in the earlier days of the war, though it had but little effect on the later campaign, because the lesson of Namur and Liége was learnt at once by the French, who threw out field works round their great fortresses, early ceased to rely upon the old permanent works, and thus saved Toul and Verdun, and in general the fortified line of the east. But though the enemy in providing this siege train, this store of large, high-explosive shell, and this vast plant for the continued production of the same, had done so in connection with work which the French did not allow them to perform, such a supply came in quite unexpectedly useful when trench warfare developed. There stood the great pieces already to hand, their mobility carefully planned and arranged for (that

is, the traction for them provided), their stock of munitions still very large, and the plant for continuing it enormous. There also stood the great stack of high explosive, the prime materials for which, and the plant for making which, the Western Allies lacked. The enemy had prepared such a plant for one use. To his surprise and pleasure it suddenly appeared of immediate and incalculable value in quite another.

The second cause of the enemy's initial advantage in trench warfare was not even the product of a right guess in a totally different field, but the product of a wrong guess altogether.

This sort of ironical result, whereby an error turns out to one's advantage in spite of oneself, is curiously common in the history of war.

The Germans, and the Austrians copying them, had guessed that in modern warfare large high-explosive shell used against troops in the open field would be of such great effect that it was worth while dragging the heavy cannon and the very heavy munitionment required, and tying the army down to such a weight.



In other words, they thought it worth while to sacrifice mobility to the presence of large pieces firing high-explosive shell upon the enemy's troops.

The French and English did not accept this theory, and they were right. The execution done against troops in the open by this kind of munitionment was not worth the delays and occasional stoppages it involved. The Manchurian War had proved this as had the South African. As against troops manœuvring in the open, shrapnel, once more, was the only really useful type of shell; and the tremendous series of actions called the Battle of the Marne proved this beyond all contradiction. It may even be said with some justice that the presence of very heavy pieces and their cumbersome train of supply was among the causes that led to Kluck's defeat in front of Paris. But when the war degenerated into trench warfare, beginning on the lines above the Aisne, and reaching up gradually to the North Sea, the enemy found himself unexpectedly advantaged by his very error. That error, which would have been fatal to him in the open field, now provided

him with just the weapon needed for the new form of fighting which neither he nor his opponent had expected, and which had developed blindly out of mere force of circumstance in the second month of the war. That error had given him a number of heavy pieces immensely superior to those of the Allies, munitionment for them, *and the plant and stock of materials at home for a new supply.*

I have said that there are not a few examples in the history of war of errors thus turning unexpectedly to the profit of the side that makes them. A classic instance is the capital error of the French in 1792 and 1793 with regard to the standing power of their raw if enthusiastic troops. They all believed, from Carnot downwards, that in time you could get the huge, hastily-trained levies of the Revolution to act in close formation, and suffer without breaking the great losses which the discipline of the eighteenth century had made possible to its very strict professional armies. They were utterly wrong. The young levies nearly always scattered when they met fire, and could only be got to advance in loose

formations which were the despair of their officers. Nevertheless, it was precisely out of this error on the part of the leaders, and this weakness on the part of the recruits, that there developed the famous "Tirailleur" formation which, in the next year, 1794, served as one of the principal causes of French victory, and was retained throughout the wars of the Empire.

The enemy, then, when trench warfare developed, found himself superior to the Allies in this matter of heavy artillery and its munitionment of high-explosive shell, and his superiority, which was overwhelming, was fourfold. (1) He had far more heavy guns. (2) He had a much larger stock of shell ready for them. (3) He had at home a considerable plant, though not yet a sufficient one, for the production of further munitionment of this kind. And (4) he had, both within his own territory and in the foreign territory he occupied in North France, Belgium, and Poland, much the greater part of the machines and mechanics of Europe at his disposal.

## 384 A GENERAL SKETCH OF

With the Allies it was far otherwise. The French had a somewhat better chance than the British, because their arsenals were designed for the supply of many great fortresses, and a certain amount of plant of the sort required for producing heavy guns and large shell was present upon her soil. But Britain was in a very bad case. Superficial observers wondered at the handicap against this country, of whose industrial resources they had heard so much. But they forgot that plant for the production of one kind of industrial product, though similar in species, would be very different in detail from the plant required for another. It is true that Britain had great numbers of skilled artisans, a great deal of machines which could ultimately be converted to the new purposes, but she had no stock of material corresponding to her new necessities. It would certainly be many months before she could produce upon anything like the scale already possible to the enemy. It would be at least six months or more before she could produce upon the scale (which the enemy himself was long in reaching) demanded by the new trench warfare.

The third member of the Great Alliance was in the worst case of all. France was badly handicapped, Great Britain still more so ; but with Russia the peril was far greater, and almost proved fatal to her chances in the whole campaign. Russia was not an industrial country. She was and is an agricultural country, very little developed upon the industrial side. She lacked metals, and she lacked the means of working them. She lacked the prime material for the production of heavy guns and high-explosive shell beyond the insufficient stocks which had been thought necessary to a modern war, and with a reserve of which she had, like all the other great countries, provided herself. Russia, therefore, when this wholly unexpected development appeared, suddenly demanding high-explosive shell of large calibre in one hundredfold the proportion which had been expected upon all sides before the war, was not only to prove a handicap as against the enemy's resources, but to be unable, when the crisis came, to overcome that handicap after the fashion happily possible to the older civilizations of France and Britain.

She would be compelled to depend upon munitionment from abroad, but this could only reach her doubtfully through Archangel during the warmer months, and even then over a thousand miles of railway, three hundred of which were narrow gauge, with little rolling stock ; or over a distance of 6,000 miles from the ports of the Far East, most of it single track, and none of it provided with any really large stock of wagons.

The result of the developments we have just been studying was in the main this :—

The German General Staff found they had failed altogether in their original offensive plan. They had completely lost the West, and had there been driven to earth, and were contained. Their Austrian ally had badly broken down in a more general fashion. The Austro-Hungarian armies had not been defeated by inferior numbers, as had the Germans at the Battle of the Marne, but they had shown a sort of looseness in plan, and a capacity for going to pieces in the field which made their independent and co-ordinated action less and less to be relied

upon, and the necessity of their ultimate control by Berlin more and more clear.

What with the Austro-Hungarian breakdown and the German defeat, there was but one loophole of escape for the enemy after he had failed in the Battle of Ypres to break out from the pressure which contained him in the West. That loophole was afforded by the unexpected revolution in the use of heavy artillery and large-calibre high-explosive shell, which the trench warfare had, to the surprise of all the Higher Commands, and none more than the enemy's, manifested. Austro-Germany was able to take advantage of the situation for the reasons given above, and took advantage of it at once. During the winter months it would be possible for the Central Empires to produce heavy munition at a vastly greater rate than it would be possible for the Allies to produce the same. It would be possible for the Central Empires, therefore, to appear in the ensuing spring ready with a formidable superiority in fire power of the only sort available against trenches. That superiority would not last very long. The Western Allies in particular would be

laying down plant as fast as they could, and would meanwhile, through their command of the seas, be able to obtain some—but very insufficient—munitionment from abroad. By the late autumn of 1915 at latest the balance would be restored in the West. It was, moreover, probable that the West could hold against any attack in the intervening period, even though the superiority of munitionment remained during that period with the enemy. But the Eastern front of the Allies was far more vulnerable. Russia could not begin to supply herself with a sufficiency of large guns and of heavy munitionment for them. She would be hopelessly inferior in this regard with the opening of the spring of 1915. She would remain inferior throughout the summer, and probably through the next winter as well.

Therefore the enemy might justly make some such calculation as this :—

“ I cannot break the line which contains me in the West, but I can break the line which contains me in the East. It is, of course, quite useless, save for purposes of parade and of affecting civilian



opinion at home, merely to shift the Russian line, and to push the Russian armies back. That would only postpone my inevitable defeat. But I believe it possible to strike so hard that the Russian line shall actually dissolve, the Russian armies lose their cohesion, the offensive power of Russia for the future disappear. At the best I can, when I have broken their front with my immense superiority in heavy artillery at the reopening of the fine weather, divide the Russian forces into two or more portions, and get round and capture one set of their armies after another. Such a proceeding will leave Russia without any striking power remaining to her. I shall have done to Russia what I did to France in 1870. She will have no real armies left, and she will be compelled to accept a separate peace. *That* done, I am at once in quite a new and much more favourable position. I can then come back West unhampered by any necessity of using men and munitions in the East. I shall be again in a most formidable superiority against my only remaining foes. I shall be able to destroy the resistance of the Western Allies, and

## 390 A GENERAL SKETCH OF

I shall thus have decided the war in my own favour upon a totally new plan, thanks to this accidental superiority I have just discovered in what now turns out to be the chief factor of success—a superior weight of heavy guns and their munitionment in high-explosive shell for use against trenches. I shall be the more certain of retaining my position because I shall *always have* an immense superiority in mere numbers of men against the Western Allies alone. At the worst, if I fail to envelop the Russian armies in detail, I shall yet, during their retreat, cost them such enormous losses in men and material as will leave them incapable of further effort. Russia finds it as difficult to make rifles and machine guns as she does to make shell and cannon. Her losses in small arms alone in a pressed retreat which I can certainly force upon her will be such that, even if her armies retain their organization, even if they remain technically in being, they can never during the course of the war be restored to any formidable strength. I shall in this way, therefore, probably obtain a separate peace from Russia, and in any case be

free to neglect my Eastern front save for a certain number of men and guns to watch upon it. This would leave me not quite as strong as my complete success against Russia would leave me, but at any rate strong enough to turn back West and decide the issue there."

The enemy failed in both these alternative calculations.

In the first, which was really decisive, he failed altogether. He never enveloped a single Russian army. He was wholly unable to put Russia out of action by the final and complete methods of which 1870 had left their imprint upon German strategy.

In the second best of his aims he much more nearly succeeded. The retreat to which he compelled Russia in the next phase of the war cost our ally far more men than it cost him—perhaps over a million men in prisoners alone—with a loss in rifles which was almost disastrous. But the success, though considerable, could not be pushed to an ultimate conclusion. The Russian armies, as we shall see, remained in being, their organization complete, and their power of recruitment

within a certain lapse of time, and even of rearmament, unimpaired. Neither could a separate peace be imposed upon Russia, nor was the condition of the Russian forces at the end of that great Eastern campaign such that the Central Empires could afford to leave upon the East a mere watching body, and to bring their weight back again Westward.

On the contrary, what happened, as we shall see in the next volume of this series, was a result in the main inconclusive, and, therefore, adverse to the Central Empires, whose permanent anxiety it was to conclude the war.

Germany attempted to obtain the Vistula line during the winter, as a prelude to her blow to be delivered in the spring. Meanwhile, during the same winter her ally lost Galicia, and found itself fighting with difficulty upon the summit of the Carpathian line. The embarrassment of Austria-Hungary had the great advantage to the enemy of giving him one united control, for Berlin assumed complete direction of the whole campaign. That unity enabled the great blow against Russia to be successfully struck in the last days of

April 1915; the great Russian retreat followed, with the consequences we have briefly set down. Those consequences did not involve the disappearance of Russia from the field. They left the campaign as a whole a problem in terms of time and attrition—that is, a problem in terms of slow and regular development. They increased, in spite of an occupation of new territory, the exhaustion, as they also extended the already too-extended fronts of the Austro-Germans. And they brought the nations of Europe into the second winter of the war, with no approach to a decision in favour of the Central Empires, with the rapidly approaching exhaustion of efficient reserves of those Empires, and with the gradual rearmament, the rapid increase in munitionment and in men, of the Western Allies.

## CONCLUSION.

WE are now in a position to summarize the Marne and its sequel in a few phrases which, though brief and general, can be exact.

The German Empire, long preparing for a campaign that should rid it of rivals, and give it the mastery over Europe, had maintained its preparation with singular secrecy, and had organized it in detail, if not with skill. It had in particular depended upon a system of espionage hitherto unknown in human history, and unsuspected by any of the older and more stable civilizations which it proposed to master. It had acquired for this task the leadership of Central Europe, and could count as effectives for its purpose all the available manhood governed by the Houses of Hapsburg and of Hohenzollern.

To the East it had to fear a rival very populous, but ill-organized and particularly lacking in the industrial opportunities

necessary to modern war. That rival was the Russian Empire.

Its task upon its other frontiers in the West was the immediate and apparently facile destruction of a competitor which it believed to be in political decay—the French people. It had against this more actively organized but despised rival an overwhelming superiority in number. The unexpected entry of Great Britain into the war promised complications of a very serious sort if the war should be prolonged; but in its first stages Great Britain could add to the armed forces of the French not more than a twentieth or so, and those first stages would be decisive.

The German Empire, distributing its allies and subjects after the simple fashion dictated by the circumstance—the Austro-Hungarians in such and such numbers to meet the slow Russian mobilization; a few of its own corps to watch its own side of the Russian menace on the north—marched immediately westward, violating the neutrality of Belgium, and sweeping down through the open country of Northern France upon a plan which fully utilized its numerical superiority.

## 396 A GENERAL SKETCH OF

It had the whole of the initiative. It had immensely stronger offensive power. It could accordingly produce a more extended line than its adversary. It swept back, and proposed to envelop, the inferior force opposed to it.

It was at the maximum of its developed energy, at the highest degree of its momentum, upon September 5, 1914: just sixteen days after the first main contact had been taken upon the line of the Sambre and the Meuse.

In such a situation did the French Higher Command catch a precise moment and a precise distribution of the line congenial to their counter-offensive. They effected a surprise on the west with one small portion of their forces (one-fourteenth). The German effort was checked. So far as this western surprise was concerned, however, it nearly recovered itself. But even as the western part was in process of recovering itself, on the fourth day, the great host was mortally struck fifty miles away at its centre. The invading line fell back, and its initiative and offensive were at an end. It had failed. This was the Battle of the Marne.



Next the pursuit compelled it to dig in. It was reduced to holding entrenched positions. It tried to break out in the centre and the east. It failed for all its superior numbers. It then tardily turned its energies to the prevention of that now triumphant weaker force opposed to it from turning its flank by the west. It countered hurriedly as best it could, but too late, the increasing extension of its opponent's line, still hoping that some gate could be forced again before that line should close. No such gate was forced. The line reached the sea. The armies of the German Empire, which two short months before had been legitimately confident of a victory, as certain as human calculation could make it, were now pinned to lines stretching from the Swiss mountains to the North Sea. From these lines it has been their effort, furiously undertaken at long intervals, to break out ; an effort in which they have gradually wasted their superiority in number, first of men, then at last even of industrial power. They have seen the numerically insignificant British contingent increased miraculously, if I may use the word without exaggera-

## 398 A GENERAL SKETCH OF

tion—increased, at any rate, in a degree unknown to any past example of European warfare—and presenting in its active combatant form alone, and in France alone, within eighteen months of development, a *tenfold* multiplication of number. The German Alliance has in the same interval made effort upon effort of a subsidiary kind: to compel her less-organized, under-armed Eastern foe to a separate peace; to disturb by internal quarrels the civilization she originally attacked; to move in her favour, for what it was worth, the remaining neutral fraction of the white races; to terrorize small neutrals; to shake the maritime supremacy and the commercial machinery of Great Britain; to menace her enemies through the Mahomedan world by I know not what ill-considered and exaggerated effects upon the Near East.

Meanwhile, throughout all those months the Western front has remained the cardinal theatre wherein the fate of the world must be decided, and Gaul, for the third time in history, has been the arena of Europe.

All that Western situation, the core of

the whole story, is no more than an extension of the Marne.

It is this consideration which gives to that stupendous action its moral, as a mere account of its numbers and breadth of ground gives it its material, grandeur.

The great campaign is not concluded at the moment in which these lines are written. Its future is completely veiled, though the last of the enemy's "shaking of the bars"—the Battle of Verdun—would seem, even as I write this, to be another failure, the most stupendous of all. But though it is impossible to predict the conclusion of any human affair, least of all the conclusion of these supreme affairs, until the full course is run, and all their effects are apparent, yet it is not rash to say of the Marne that it should stand alone among the great decisions of human history. Nor is it an exaggeration to say, even to-day while the war is still raging, that the Marne already takes a larger place (as well as one unique) than any of the short, decisive, famous days, its predecessors.

The Battle of the Marne secured Europe not from an external peril, as did Tours

and Châlons from the Arab and the Hun, but from one internal and spiritual. It decided that most profound of all issues which can appear within a man's own soul or within that of a nation, or within that of a whole vast tradition, such as is the tradition of Christendom—I mean whether the lesser should conquer the greater, the viler the more noble, the more changeable the more steadfast, the baser the more refined.

The Marne was that moment of issue in which a soul is saved or lost. The enormity of consequence with which those four blazing September days were filled, our generation—an inch away from them, so to speak—cannot gauge at all. We know generally, and generally state, that the Germanies have learnt their lesson imperfectly from the south and from the west; we know that of the Germanies Prussia was the basest part. We know, upon the analogy of all historical things, small and great, that the less creative, the dullest and the worst element may destroy, and has frequently attempted to destroy, the vital, the more creative, and the best. We appreciate—but dully and

confusedly, like men not yet fully recovered of a fever, their bodies still full of pain and their minds clouded—that the presence of death is removed, and that the corner of the road is turned; there is even a landscape before us. We owe that salvation to the Marne.

But all these things are still in flux, unstable within our minds. Those for whom the large presentment of history is absent or imperfect or forgotten, and those who grasped very slowly (being in a secure place) the magnitude of the affair, may still, even after twenty months, ask me, perhaps with irony, whether I have not distorted to exaggeration the vast scale of those September days.

No, I have not so distorted them. Upon the contrary, I find here in these concluding words of mine a sort of impotence. The thing is far too great for my pen. Said St. Jerome of the Auxiliaries sacking Rome at last: "*Perdidi vocabulum.*" I might repeat that phrase.

I have throughout this book dealt with the story of the Marne as military problems should be dealt with, I think—that is, so that one indifferent to the victory

## 402 A GENERAL SKETCH OF

of either side should be able from my narrative to comprehend the movement of troops and their effect, and be disturbed by nothing more.

Had it been my task to turn to the awful reality, the living powers at work behind and beneath these phenomena of strategy and of tactics, I would surely have attempted a vision of personal spirits in conflict far beyond the scale of mankind. In such an attempt I should have failed. A thousand years will pass, and no historian will ever successfully record it.

---

*Note on the opposing Numbers at the Marne (see p. 35).*

No official list has been published yet of the German units present at the Battle of the Marne. Several writers upon the battle have, as I have said, received information, not exactly official but trustworthy, as proceeding from men who had taken part in the action. Of the various lists so drawn up, that which allows least numbers to the enemy, and gives us, therefore, a minimum, enumerates the corps as follows:—

With Kluck . . . .	5 Corps (including the 9th, which is sometimes put down to Buelow's command).
With Buelow . . . .	4 Corps (including the Guard).
With Hausen . . . .	4 Corps.
With the 4th Army to the east of Hausen . . . .	5 Corps.
With the Crown Prince . . . .	5 Corps.
Total . . . .	23 Corps.

This list does not give the massed German forces south of Verdun, but we know that the concentrated attack upon the Grand Couronné, which had not finished when the Marne opened, was made with 8 corps, for they were identified, and there were certainly 2 corps more upon the very long stretch between the Swiss frontier and Nancy.

This source of information, therefore, allows for 33 corps apart from the independent cavalry divisions. Now, even if there were only two divisions in each of these corps, and if no third division had ever been present with any German corps, we would get from this list twice as many divisions as there were corps—that is, 66 divisions.

Every other list I have seen ascribes 6 corps instead of 5 to the Crown Prince, while the greater part also find another corps, the 11th, acting in the centre. There is little doubt that these 2 extra corps were present, which would raise our minimum number to 70 divisions.

Further, we know positively that at least one division, left up in the north upon the flank of Kluck's advance, came down during the great action and appeared upon the last day but one of the Battle of the Ourcq, menacing the French flank there.

Again, Maubeuge fell on the 6th of September. To contain Maubeuge certainly not less than two divisions were necessary, more probably three or even four, for the garrison alone consisted of two divisions. It is not credible that this force was left idle during the three ensuing critical days after it was released by the fall of Maubeuge. Some of these divisions must have appeared upon the Marne; and even if only one appeared, that would give us 72 divisions.

But all this, as I have said, is allowing only two divisions to each German army corps. Now we know that several of these corps brought with them a third reserve division, though how many of these formations peculiar to the German service there were is difficult to establish until the casualty lists already analyzed are available. — Even if there were only 4 or 5, that would bring the total

number of divisions up to 76 or 77 for the German force actually fighting during the days of the Marne.

The strength of the Allied army is much easier to establish, for we know it in some detail. You have 4 divisions originally present with the French 6th Army; 6, not of full establishment by any means, with the British contingent; 11 with Esperey and the 5th Army; 8 with Foch; with Langle and the 4th Army there were 6 divisions; while Sarrail commanded  $6\frac{1}{2}$  nominally—but a depleted  $6\frac{1}{2}$ . This gives us  $41\frac{1}{2}$  divisions. But the 4 divisions of the 6th Army grew to 9 before the Battle of the Ourcq by reinforcement, so we have a total of  $46\frac{1}{2}$  divisions for the French. To these must be added what remained south of Verdun. How many were here? I doubt if there were more than 4 divisions. There may possibly have been 5. My reason for saying this is that we know the Grand Couronné to have been defended with numbers less than half of the attack, and we know that the eastern armies had been skinned to the very barest limit by the withdrawal of men to feed the new "Mass of Manœuvre," the 6th and the 9th Armies. We also know that the 2 divisions which enabled Sarrail to stand were withdrawn from the east just before the battle. I doubt whether, when the full truth is known, more than 51 divisions will be found present upon the French lines when the battle opened, excluding the independent cavalry divisions. It is difficult to see how, in the evidence as yet available, there were as many as 53. There may have been 52.









