

1925

Griffith  
AND  
Turner Co.



SUPPLIES

GENERAL OFFICES, 205-215 N. PACA ST.

BRANCH HOUSE, 338 N. GAY ST.

BALTIMORE, MD.

Prospective Customers who are not rated in the Commercial agencies will save time in having their goods shipped by accompanying their Orders either with the Cash or satisfactory references. Baltimore references preferred.

NOTICE.—We make a specialty of quoting on complete outfits. SEND FOR PRICES.

FILLING ORDERS.—Every order is filled and forwarded as promptly as possible, but if not duly received, please notify us and we will make every effort to trace it without delay. Do not fail to sign your name and give full address.

PACKING AND SHIPPING.—We make no charge for boxes or packing of retail orders, and deliver all goods to any railroad or steamboat free of charge.

We charge for cotton bags as follows: Peck and half bushel, cents each; 1 bushel, cents each; 2 bushels, cents each.

HOW TO REMIT.—Remittances should be made by draft, Express Money Order, P. O. Money Order or Registered Letter.

We deliver by PARCEL POST FREE to any Postoffice in the United States all cash orders for Flower and Garden Seeds at Catalog prices, except Peas, Beans, Corn and Field Seeds. No seed delivered free unless order is accompanied with the cash. For postage on Peas, Beans, Corn, Field Seeds and All Merchandise, consult table below.

ON EVERY ORDER be sure to SIGN YOUR NAME and give your address PLAINLY, as we frequently receive orders lacking either or both; also give full shipping instructions. State if by freight or express and give route. This saves delay.

PRICES TO MARKET GARDENERS.—Market gardeners and all purchasers of Seeds in large quantities should submit us a list of their wants and we will name them special prices.

PARCEL POST RATES.

Weight in Pounds	Distance not over 150 miles.	Over 150 and not over 300 miles.	Over 300 and not over 600 miles.	Over 600 and not over 1000 miles.
1	\$.05	\$.06	\$.07	\$.08
2	.06	.08	.11	.14
3	.07	.10	.15	.20
4	.08	.12	.19	.26
5	.09	.14	.23	.32
6	.10	.16	.27	.38
7	.11	.18	.31	.44
8	.12	.20	.35	.50
9	.13	.22	.39	.56
10	.14	.24	.43	.62
11	.15	.26	.47	.68
12	.16	.28	.51	.74
13	.17	.30	.55	.80
14	.18	.32	.59	.86
15	.19	.34	.63	.92
16	.20	.36	.67	.98
17	.21	.38	.71	1.04
18	.22	.40	.75	1.10
19	.23	.42	.79	1.16
20	.24	.44	.83	1.22
21	.25	.46	.87	1.28
22	.26	.48	.91	1.34
23	.27	.50	.95	1.40
24	.28	.52	.99	1.46
25	.29	.54	1.03	1.52
26	.30	.56	1.07	1.58
27	.31	.58	1.11	1.64
28	.32	.60	1.15	1.70
29	.33	.62	1.19	1.76
30	.34	.64	1.23	1.82
31	.35	.66	1.27	1.88
32	.36	.68	1.31	1.94
33	.37	.70	1.35	2.00
34	.38	.72	1.39	2.06
35	.39	.74	1.43	2.12
36	.40	.76	1.47	2.18
37	.41	.78	1.51	2.24
38	.42	.80	1.55	2.30
39	.43	.82	1.59	2.36
40	.44	.84	1.63	2.42
41	.45	.86	1.67	2.48
42	.46	.88	1.71	2.54
43	.47	.90	1.75	2.60
44	.48	.92	1.79	2.66
45	.49	.94	1.83	2.72
46	.50	.96	1.87	2.78
47	.51	.98	1.91	2.84
48	.52	1.00	1.95	2.90
49	.53	1.02	1.99	2.96
50	.54	1.04	2.03	3.02
51	.55	1.06		
52	.56	1.08		
53	.57	1.10		
54	.58	1.12		
55	.59	1.14		
56	.60	1.16		
57	.61	1.18		
58	.62	1.20		
59	.63	1.22		
60	.64	1.24		
61	.65	1.26		
62	.66	1.28		
63	.67	1.30		
64	.68	1.32		
65	.69	1.34		
66	.70	1.36		
67	.71	1.38		
68	.72	1.40		
69	.73	1.42		
70	.74	1.44		

INSECTICIDES  
CANNOT  
BE SENT BY  
PARCEL  
POST

TO COUNTRY MERCHANTS.

WE PUT UP VEGETABLE SEEDS in papers for the Country. Trade in quantities to suit purchasers.

Our seeds are select and tested, and give satisfaction wherever used.

Beans, Peas, Corn, etc., in bulk, at lowest wholesale rates.

Write for special quotations in quantities.

Should you have placed your order for small papers for this year, we will be pleased to fill any shortage you may have, and solicit your patronage for another season

**O**UR SEEDS are the BEST that can be obtained anywhere, because we are as careful in our selection as it is possible for anyone to be, and are constantly on the lookout for the best of everything, but will not put on the market anything until it has been thoroughly tried and proved.

No matter what others may ask for their seeds, better quality cannot be obtained anywhere, as our constantly and rapidly increasing trade does and will testify.

Our Seeds are ALL TESTED thoroughly before being placed on the market. If for any reason you change your postoffice address, please advise us, giving your old address as well as your new one, stating which is the old and new one.

By writing out your order on the Order Sheet sent with each Catalogue you will greatly facilitate our work. Extra Order Sheets sent on application. Be sure to sign your name in full, giving postoffice and shipping point. If you have rural delivery, give name and number of route. If you want goods shipped by boat or railroad, state which you prefer, and what line to send by.

WEIGHT OF AGRICULTURAL SEEDS,  
PER BUSHEL, AND QUANTITY  
USUALLY SOWN PER ACRE.

Weight per Bushel.	Pounds per Acre.
60 lbs. Alsike, alone	6 lbs.
60 " Alfalfa or Lucerne	20 "
48 " Barley, broadcast	1 1/2 bus.
" Broom Corn, in hills	6 to 8 qts.
48 " Buckwheat, broadcast	1 bus.
21 " Crested Dog's Tail	25 lbs.
20 " Creeping Bent	50 "
60 " Crimson Clover	15 to 20 "
56 " Corn, for soiling	1 to 2 bus.
24 " English Rye or Perennial Rye	60 lbs.
20 " Evergreen Lawn	8 to 4 bus.
56 " Flax, for seed	1 "
" Flax for fiber	2 to 3 "
56 " Field Corn, in hills	4 qts.
50 " German Millet	50 lbs.
48 " Hungarian Millet	48 "
44 " Hemp	22 "
20 " Italian Rye	50 "
14 " Kentucky Blue	42 "
22 " Meadow Fescue	50 "
7 " Meadow Foxtail	80 "
14 " Orchard Grass	42 "
32 " Oats, broadcast	2 to 2 1/2 bus.
10 " Red Top, chaff	40 to 50 lbs.
14 " Red Top, unhusled	42 "
32 " Red Top, fancy	12 "
60 " Red Clover	15 "
56 " Rye, broadcast	1 bus.
12 " Sheep Fescue	30 lbs.
48 " Sorghum, drills	4 qts.
" Sorghum, broadcast	1 bu.
10 " Tall Meadow Oat	50 lbs.
45 " Timothy, alone	15 "
" " with other grasses	8 lbs.
" " Together for an acre	
" " Red Clover	6 "
" " Timothy	12 "
" " Teosinte, in hills	1 to 8 "
60 " Vetches, broadcast	1 bus.

WEIGHT OF AGRICULTURAL SEEDS,  
QUANTITY, ETC.—Continued.

Weight per Bushel.	Pounds per Acre.
14 lbs. Wood Meadow	30 lbs.
60 " White Clover, alone	6 "
" " White Clover, with other grasses	2 "
60 " Wheat, broadcast	1 1/2 to 2 bus.
" " Wheat, in drills	1 1/2 to 2 "

Vegetable Seed Table.

THE QUANTITY OF SEED USUALLY SOWN TO ACRE.

Asparagus	10 to 20 lbs.
Beans, dwarf in drills	3/4 bus.
Beans, pole, in hills	8 to 10 qts.
Beet, in drills	4 to 6 lbs.
Cabbage, in beds, to transplant 1 acre	1/4 lb.
Carrot, in drills	2 to 3 lbs.
Celery, to transplant	1/2 lb.
Corn, in hills (sugar)	4 qts.
Kale	4 to 6 lbs.
Melon, musk	1 1/2 to 2 "
Melon, water	2 to 8 "
Mustard, broadcast	12 to 16 "
Mangelwurzel	4 to 6 "
Onions, in drills to make large onions	6 to 8 "
Onion Seeds, for small sets	40 to 60 "
Parsnips, in drills	4 to 6 "
Peas, early, in drills	1 1/4 bus.
Peas, Marrowfat, in drills	1 1/4 "
Peas, broadcast	2 to 3 "
Potato, cut tubers in drills	8 to 11 "
Radish, in drills	6 to 8 lbs.
Radish, broadcast	10 "
Salsify, in drills	6 to 8 "
Spinach, in drills	12 to 20 "
Squash, bush varieties, in hills	4 to 6 "
Squash, running varieties, in hills	8 to 4 "
Turnip, in drills	1 lb.
Turnip, broadcast	2 lbs.
Tomato, to transplant 1 acre	1/4 lb.

"We give no warranty, expressed or implied, as to description, purity, productiveness or any other matter of any seeds, or bulbs we sell, and we will not be in any way responsible for them."

# GRIFFITH & TURNER CO.

205-215 N. PACA STREET  
Branch House, 336 N. GAY St.  
BALTIMORE, MD., U. S. A.

**HOW TO SEND MONEY:** By Mail, Express, P. O. Money Order, Registered Letter or Bank Draft.  
For Small amounts send Postage Stamps.

We deliver by Parcel Post free to any Post-office in the United States, all cash orders for Flower and Garden Seed at Catalog Price, except Peas, Beans, Corn and Field Seeds. No seed delivered free unless the order is accompanied with the cash. For Peas, Beans, Corn and Field Seeds, add to Catalog Price 6 cents a pint and 8 cents a quart. For each additional quart add at the rate of 2 cents a quart, for distances not over 150 miles from Baltimore. For other seed and merchandise rate consult first page in Catalog.

**VERY IMPORTANT.** No difference how often you have written us, always give your full address, and write your Name, Post-office, County and State very plainly. We frequently get orders without address or signature.

We give no warranty, expressed or implied, as to description, purity, productiveness, or any other matter of any seeds, bulbs or plants we sell, and we will not be in any way responsible for them.

**ORDER FLOWER SEEDS BY NUMBERS. PRICES SUBJECT TO CHANGE WITHOUT NOTICE.**

AMOUNT ENCLOSED

Forward by	} State on this line whether wanted by Mail, Express or Freight.	Post-office Order . . . \$ .....
Your Name .....		Express Money Order .....
Post-office .....	Route No. ....	Bank Draft . . . . .
County .....	State .....	Cash, Notes and Silver .....
Freight Office } .....	Date .....	Postage Stamps . . .
Express or } .....		(2c. stamps preferred) .....

QUANTITY	ARTICLES WANTED	PRICE



# Griffith & Turner Co.'s

ANNUAL

1925--CATALOGUE--1925

BEST GOODS

No. 38

LOW PRICES

## ASPARAGUS

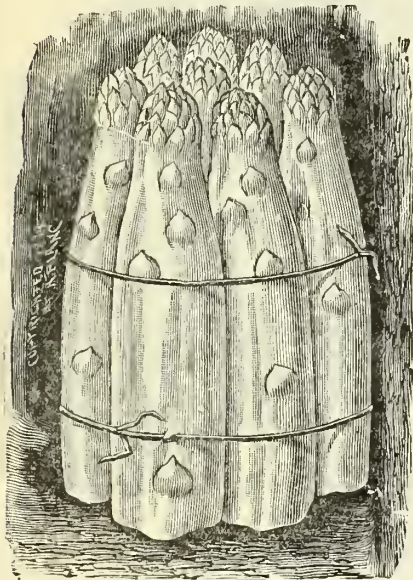

Palmetto Asparagus.

This is one of the earliest spring vegetables, and should be in universal use. Many persons think it is difficult to grow, but we consider this a mistake, and believe it can be produced as cheaply and easily as any on the list. Sow the seed in the seed bed late in the fall or the early spring, as soon as the ground can be worked, in drills one foot apart, covering the seed about one inch deep. When the plants are four or five inches high, great care should be taken to keep the bed free of weeds. One ounce of seed will sow forty feet of row.

**WASHINGTON ASPARAGUS.**—This variety is the result of careful breeding by the U. S. Department of Agriculture, with the object of eliminating rust. A dark green color.

Pkt., 5c. Oz., 20c. 1b., 65c. Lb., \$2.50.

**PALMETTO.**—A very early maturing variety, producing an abundance of very large, deep green shoots.

Pkt., 5c. Oz., 10c. ¼ lb., 20c. Lb., 75c. 5 lbs., \$3.50.

**MAMMOTH WHITE.**—Produces large, white shoots six inches above the surface; fine quality. Pkt., 5c. Oz., 10c. 1b., 20c. Lb., 75c.

**BARR'S MAMMOTH.**—The stalks are very large, and retain their thickness completely up to the top of the shoots; light in color.

Pkt., 5c. Oz., 10c. ¼ lb., 20c. Lb., 75c. 5 lbs., \$3.50.

**CONOVER'S COLOSSAL.**—A mammoth, green sort of the largest size and of good quality. One of the best known and most generally cultivated varieties.

Pkt., 5c. Oz., 10c. ¼ lb., 20c. Lb., 75c. 5 lbs., \$3.50.

**GIANT ARGENTEUIL.**—A French variety. Stalks large and thick. Pkt., 5c. Oz., 10c. ¼ lb., 20c. Lb., 75c.

**ASPARAGUS ROOTS.**—A saving of one to two years is effected by planting roots. A bed 12x40 feet, requiring about 100 roots, should give a sufficient supply for an ordinary family. 7,260 roots will plant an acre. Select good loamy soil, plow deep, put in good quantity of manure and 100 pounds kainit to 1,000 square feet of bed. Incorporate thoroughly, make a trench eight inches deep, set plants nine inches apart. In field culture rows are placed four feet apart.

<b>BARR'S MAMMOTH</b>	<b>COLOSSAL (Green)</b>	<b>PALMETTO (Green)</b>
Per 100, \$1.25.	Per 1,000, \$9.50.	
Prices, by Express, Not Prepaid.		

**LARGE GREEN GLOBE ARTICHOKE.**—A favorite French vegetable of medium height with rather deep green leaves. The buds or flower-heads are green, nearly round or somewhat elongated. Pkt., 5c. Oz., 40c.

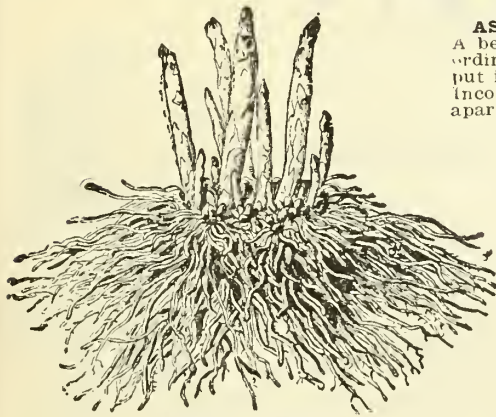

Asparagus Roots.

### RAFFIA

The best material for tying plants, vines, etc. Per pound, 20c.

### ASPARAGUS KNIFE



Made of solid steel; see the cutting point. Price, 40c. each.

### ASPARAGUS BUNCHER

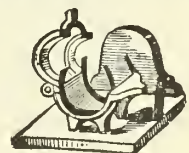

This Asparagus Buncher is adjustable with patented clamp. Price, \$4.00 each.

# BEANS

## Dwarf or Bush-Wax Podded

Select light, warm soil and plant when danger from frost is past in the spring, in drills 2 to 2½ feet apart, dropping the beans about 6 to 8 inches apart in the drills, and cover 2 inches deep. A succession of sowings can be made from the first week in May until August.

Add 6 cents per pound on all Beans if to be sent by mail.

### IMPROVED RUSTPROOF GOLDEN WAX

This is the earliest, handsomest and hardiest of all the Wax Beans. The Pods are straight, long and thicker than the ordinary Golden Wax, much superior in quality, absolutely rustproof and sure to become a favorite Wax Bean; in fact it has already gained great popularity with growers.

Pint, 30c. Quart, 50c. Peck, \$3.50. Bushel, \$13.00.

**SURE CROP STRINGLESS WAX.**—Recently introduced by the largest bean grower and originator of new varieties in this country. Entirely stringless, black-seeded, thick, flat yellow pods. The most desirable sort for canning.

Pint, 30c. Quart, 50c. Peck, \$3.50. Bushel, \$13.00.

### DWARF PROLIFIC BLACK WAX

Yellow pod, a very superior snap sort, ripening among the first earlies and having the best characteristics, Very tender.

Pint, 30c. Quart, 50c. Peck, \$3.50. Bushel, \$12.00.

### HODSON WAX

The most vigorous wax-podded bean yet introduced. The yield of large, handsome pods is enormous. Its dense foliage protects the pods, so that their color is clear, creamy white, Pods very long, straight or slightly curved, flat, but fleshy, quite stringless and of very good quality. While late in maturing, the remarkable vigor of the plant is a safeguard against blight and other diseases.

Pint, 30c. Quart, 50c. Peck, \$3.50. Bushel, \$13.00.

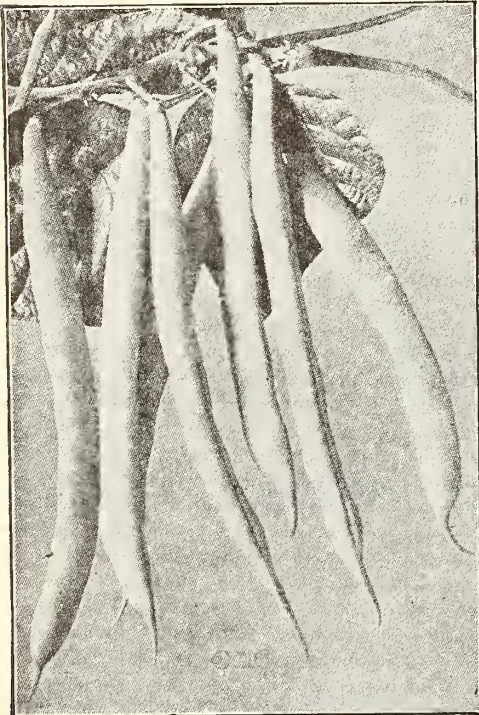

**CURRIE'S RUSTPROOF GOLDEN WAX**

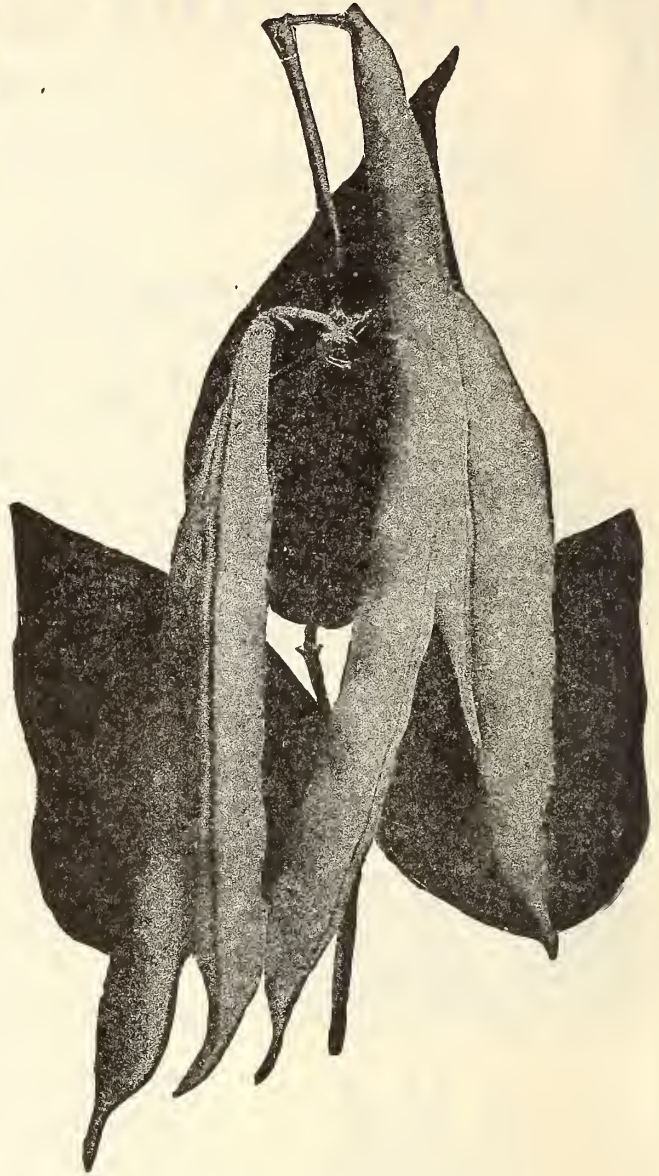

### NEW BALTIMORE STRINGLESS WAX

Black seeded, early; thick flat, yellow pod. No strings. Have appearance of Currie's Rustproof Wax, but are better cropper, and absence of strings make them much more desirable for canning and other uses.

Pint, 30c. Quart, 50c. Peck, \$3.50. Bushel, \$13.00.

### CURRIE'S RUSTPROOF BLACK WAX

For earliness and freedom from rust it is at the head of the Wax Bean family. Habit, upright and robust, holding the pods well from the ground. Pods long, straight, flat and very meaty, of a beautiful color; quality not surpassed, and for productiveness it is unequaled.

Pint, 30c. Quart, 50c. Peck, \$3.50. Bushel, \$12.00.

### WARDELL'S KIDNEY WAX BEAN

This is one of the best wax sorts. The vines are remarkably vigorous, hardy and productive. The pods are very large, smooth, showy, tender, perfectly stringless and of an unusually fine quality.

Pint, 30c. Quart, 50c. Peck, \$3.50. Bushel, \$13.00.

### NEW PENCIL POD WAX BEAN

Very early and productive. Pods long, straight and handsome; color, light golden yellow; strong and vigorous bush. One of the best varieties.

Pint, 30c. Quart, 50c. Peck, \$3.50. Bushel, \$12.00.

## BEANS—GREEN—PODDED BUSH

The green podded dwarf sorts are perhaps the most important class of garden beans and are probably more extensively used for snaps than the wax podded varieties, although the latter are considered by many as the more attractive in appearance. The green podded sorts are as a rule the more productive, being less sensitive to unfavorable conditions of soil and climate and of late years have been less susceptible to bean diseases.

**G. & T. CO'S EXTRA EARLY RED VALENTINE (Specialty).**—Ten days earlier than the ordinary Red Valentine Bean, and therefore the best for truckers and market gardeners. It is without doubt the very best and earliest green Snap Short Bean. The habit of the vine is dwarfed and very uniform. Color of pods light green, round, curved, succulent, prolific, continuing long in edible condition. **Pt., 30c. Qt., 50c. Pk., \$3.00 Bu., \$12.00.**

**BLACK VALENTINE.**—This excellent extra early variety has perfectly round, straight pods of excellent quality. It is suitable both for early and late planting, being extremely hardy. A most desirable sort for the market gardeners, owing to its enormous yielding qualities, large and handsome appearance. **Pt., 30c. Qt., 50c. Pk., \$3.00. Bu., \$12.00.**

**EXTRA EARLY BOUNTIFUL (Flat Green Pod).**—A prolific and continuous bearer. The first in the spring, the last in the fall. Absolutely stringless, very tender and of delicious flavor. **Pt., 30c. Qt., 50c. Pk., \$3.50. Bu., \$13.00.**

**EXTRA EARLY REFUGE.**—It is similar in every respect to the ordinary Refugee, but is nearly two weeks earlier. It is enormously prolific, and from its earliness is almost certain to produce a crop, no matter how unfavorable the season; is rapidly becoming a favorite sort, as it matures

**G. & T.'S IMPROVED EXTRA EARLY RED VALENTINE BEANS.**

equally early with Red Valentine and has that beautiful silvery green color in the pods that is so much desired. **Pint, 30c. Quart, 50c. Peck, \$3.50. Bushell, \$13.00.**

**REFUGEE, or 1000 TO 1.**

A medium to late variety, very productive and largely grown for pickling; handsome and tender pods.

**Pint, 30c. Quart, 50c. Peck, \$3.50. Bushell, \$13.00.**

**GREEN-PODDED STRINGLESS REFUGEE.**

Medium-early, round-podded green stringless; exceptionally good cropper. Fine for canning and table use. Newest thing in Green Pod Stringless Beans.

**Pint, 30c. Quart, 50c. Peck, \$3.50. Bushell, \$13.00.**

**FULL MEASURE (New)**—Large cropper; Stringless, Greenpodded, round Bean, not as early as Burpee's Stringless, but a heavy yielder. Best of quality. **Pint, 30c. Quart, 50c. Peck, \$3.50. Bushell, \$13.00.**

**BURPEE'S NEW STRINGLESS GREEN POD.**

One of the earliest varieties, pods round and full, absolutely stringless and of beautiful fleshy appearance; quality excellent. The only green pod bean of which the pods never develop any strings.

**Pint 30c. Quart, 50c. Peck, \$3.50. Bushel, \$13.00.**

**GIANT STRINGLESS GREEN POD.**

Resembles very much the old Valentine. The plants are of strong growth, very productive; pods 5 inches long, light green, slightly curved, very meaty, brittle and stringless at all stages and of mild flavor. **Pint, 30c. Quart, 50c. Peck, \$3.50. Bushel, \$13.00.**

**LONG YELLOW 6 WEEKS.**

The plants of this hardy variety, large, vigorous, erect and very productive. The leaves are large. The pods are long, about six inches, straight, flat, handsome, rather light green and when young are of good quality for snaps. **Pint, 30c. Quart, 50c. Peck, \$3.50, Bushel, \$13.00**

**DWARF HORTICULTURAL (Cherry).**

Very green podded sort, used as a shell bean, and for this purpose is one of the finest in general use; long a favorite with those who use a shell bean in a green state. **Pint, 30c. Quart, 50c. Peck, \$3.50. Bushel, \$13.00.**

**BEST OF ALL.**

One of the most valuable green podded sorts for family or market use. Pods are six inches long, very fleshy, succulent, stringless, of rich flavor; produced early and abundantly. **Pint, 30c. Quart, 50c. Peck, \$3.50. Bushel, \$13.00.**

**WHITE MARROWFAT.**

Extensively grown for sale as a dry bean for winter use. **Pt., 30c. Qt., 50c. Pk., 3.25. Bu., \$12.00**

**WHITE NAVY, or SMALL PEA BEAN.**

A well-known variety for field culture; very prolific. **Pt., 30c. Qt., 50c. Pk., \$3.25. Bu., \$12.00**



**BURPEE'S STRINGLESS GREEN POD BEANS.**

## BUSH LIMA BEANS

Plant in drills two to three feet apart, dropping the beans three to four inches apart and covering one and one-half to two inches deep. If planted in hills, make the hills two to three feet apart one way and two to two and one-half feet the other and plant four beans in a hill. Hoe often but only when the leaves are dry.



BURPEE'S BUSH LIMA.

Set the poles 3 to 4 feet apart and plant 6 to 8 beans, with the eyes downward, around each pole thinning to 4 healthy plants when they are up. They require the same soil and treatment as the dwarf varieties.

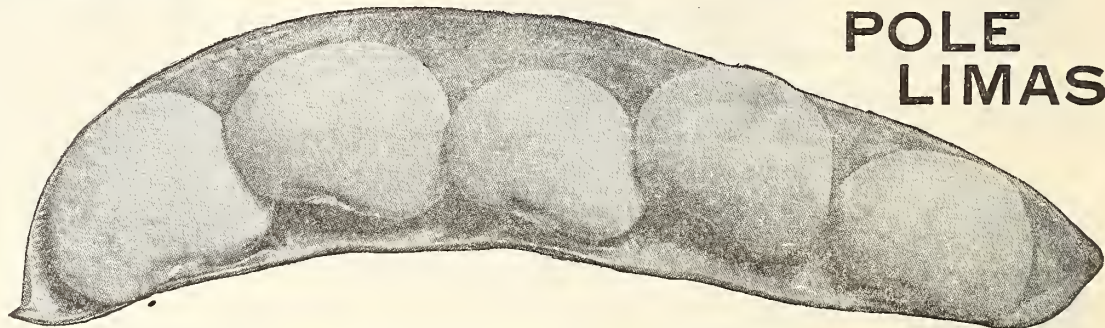

POLE LIMAS

When Beans are sent by mail add, for postage, 6c. per pound.

**FORDHOOK BUSH LIMA.**—An improved dwarf Lima of the Kumerle type. The plant is vigorous and erect growing, bearing well above the ground. The pods are produced in large clusters, each containing three to five large beans of exceptionally fine quality. Much more productive than Kumerle and matures earlier. We consider this a decided acquisition to the dwarf Lima, possibly the best of the class. Ft., 40c. Qt., 75c. Peck, \$5.00. Bushel, \$20.00.

**BURPEE'S IMPROVED BUSH LIMA.**—Will outyield Burpee's Bush Lima by fully one-third. This greater yield is due to the increased size of both pod and beans. The dried beans are very handsome, and generally show a greenish-white coloring, while dried beans of the Burpee Bush Lima, like those of the Large Pole Lima, are pure white. Pint, 30c. Quart, 60c. Peck, \$3.75. Bushel, \$15.00.

**BURPEE'S BUSH LIMA.**—Bushes grow 18 to 20 inches high, stout growth and always erect, yet branching so vigorously that each plant develops into a magnificent circular bush 2 to 3 feet in diameter; an immense yielder, each bush bearing 50 to 200 handsome, large pods, well filled. Pint, 30c. Quart, 60c. Peck, \$3.75. Bushel, \$15.00.

**KUMERLE, or DREER'S BUSH LIMA.**—Dwarf variety of Dreer's Improved Lima, which has been fixed in its character of a bush bean; very prolific, single plants often producing 150 to 200 pods. Equal in quality and tenderness to Dreer's Pole Lima.

Pint, 30c. Quart, 60c. Peck, \$3.75. Bushel, \$15.00.

**DREER'S WONDER BUSH LIMA.**—Very desirable on account of earliness, productiveness; of strong, upright growth, and are completely covered with large pods, many of which contain four beans, which are fully as large as the Pole Limas. The beans are flat in shape and of excellent quality.

Pint, 30c. Quart, 60c. Peck, \$3.75. Bushel, \$15.00.

**HENDERSON BUSH LIMA.**—These are very valuable, because they do not need poles, and, being so dwarf, can be planted close together. They are very early and prolific, continuing to bear until frost.

Pint, 30c. Quart, 60c. Peck, \$3.75. Bushel, \$15.00.

**CARPENTERIA POLE LIMA.**—The newest large pole Lima; enormously prolific; early green and delicious flavor. Pint, 25c. Quart, 50c. Peck, \$3.25. Bushel, \$12.00.

**HENDERSON'S EARLY LEVIATHAN.**—This is the very earliest. It will not only give large Lima beans earlier than any other strain, but it is also much more productive, both early and throughout the season. It is a strong grower, clinging well to the poles, and is a sure cropper. The pods hang out from the foliage in large clusters and contain three or four and sometimes five large beans to the pod. Pint, 25c. Quart, 50c. Peck, \$3.25. Bushel, \$13.00.

**KING OF THE GARDEN LIMA.**—This bean has met with enormous sales the past few seasons. They are vigorous growers, setting their beans early at bottom of pole, producing continuously to the end of the season. They are more prolific than the ordinary Lima, bearing pods 5 to 7 inches long, in clusters of 4 and 5, with 5 or 6 beans in a pod.

Pint, 25c. Quart, 50c. Peck, \$3.25. Bushel, \$13.00

**EXTRA LARGE WHITE LIMA.**—This is a splendid sort, and takes a leading place with growers, because of its many excellent qualities. As a shell bean surpasses all in quality, and is the favorite with most people.

Pint, 25c. Quart, 50c. Peck, \$3.25. Bushel, \$13.00

**EXTRA EARLY JERSEY LIMA.**—This variety is two weeks earlier than other sorts; the pods are large and numerous, making it a very profitable sort to grow. Pint, 25c. Quart, 50c. Peck, \$3.25. Bushel, \$13.00

**DREER'S IMPROVED OR CHALLENGE POLE BEAN.**—This popular bean is considered by many growers superior to all others in quality and productiveness. When green it is as large as the Large Lima, thicker, sweeter and more tender and nutritious, remaining green in the pod for a long time after maturing. Pint, 25c. Quart, 50c. Peck, \$3.25. Bushel, \$13.00

**CAROLINA OR SIEVA.**—A seedling variety of large White Lima, with small pods, usually about 2 inches long. A little earlier and hardier. Pint, 25c. Quart, 50c. Peck, \$3.25. Bushel, \$13.00



## BEANS—POLE OR RUNNING

These are of strong running growth, and need stout poles on which to climb. They require a longer season in which to mature than do the bush varieties, but by reason of their stronger growth are more productive, and growing on poles are more easily gathered.

**MARYLAND WHITE.**—This new White Pole Bean is destined to take its place as one of the best beans ever grown for general purposes. Its thick, meaty, green pods are very tender, rich in flavor, and produced in great abundance. It is equally valuable as a snap or shell bean. **Plnt 25c. Quart, 50c. Peck, \$3.25. Bushel, \$12.00.**

**LAZY WIFE.**—Large pale green pods, very thick meated, stringless, rich, tender and buttery; ripens early; clings well to the pole; enormously productive; splendid either as a snap or shell bean. **Plnt, 25c. Quart, 50c. Peck, \$3.25. Bushel, \$12.00.**

**KENTUCKY WONDER, OR OLD HOMESTEAD.**—A very prolific sort, bearing its pods in large clusters; pods green, often reaching 9 to 10 inches in length, nearly round when young, and very crisp. **Plnt, 25c. Quart, 50c. Peck, \$3.25. Bushel, \$12.00.**

**SPECKLED HORTICULTURAL, OR WREN'S EGG.**—An old favorite for both snap-shorts and dry beans. **Plnt, 25c. Quart, 50c. Peck, \$3.25. Bushel, \$12.00.**



Kentucky Wonder Pole Beans.

## BORECOLE

This is often called Broccoli by market gardeners, but belongs to the Kale family. Very spreading in habit and beautifully curled.

Seed should be sown in May and transplanted in July, in the open field and treated same as Savoy Cabbage. **Pkts. 5c. and 10c. Oz., 15c. ¼ lb., 40c. Lb., \$1.50.**

## BROCCOLI

1 Ounce of Seed to 100 Yards of Row.

The heads resemble somewhat a coarse cauliflower and the culture is the same as for that vegetable. Broccoli is well adapted only to those sections where the season is long, cool and rather moist. One of the most valuable features is that it withstands greater extremes of temperature than cauliflower.

**EARLY PURPLE CAPE.**—Large, compact. **Pkt., 10c. Oz., 50c.**

**LARGE EARLY WHITE.**—Head white, like cauliflower; the best.

**Pkt., 10c. Oz., 50c.**

## SWISS CHARD

(Sea Kale or Splnaeh Beet.)

This kind of beet is grown exclusively for the numerous, fleshy, tender leaves and leaf stalks, which are superior to those of other beets for use as greens. Later in the season the wax-like leaf stems are cooked like asparagus or are pickled.

This variety we offer has large, broad, undulated leaves, and remarkably broad stalks and midribs or chards. It is well worthy of a place in the home garden as well as for market use.

**Pkt., 5c. Oz., 15c. ¼ Lb., 30c. Lb., \$1.00**

## BRUSSELS SPROUTS

1 Ounce of Seed to 100 Yards of Row.

Brussels Sprouts are used in the fall and early winter and by some considered more tender and delicious than any cabbage. The plant resembles the cabbage, the edible part being the numerous very small heads or sprouts an inch or two in diameter formed on the stalk at each leaf joint. The culture is the same in all essentials as for cabbage, except the leaves should be broken down in the fall to give the little heads more room to grow.

**Pkts., 5c. and 10c. Oz., 20c. ¼ lb., 60c. Lb., \$2.00.**

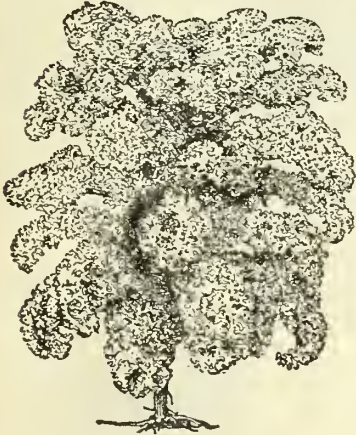

BORECOLE.

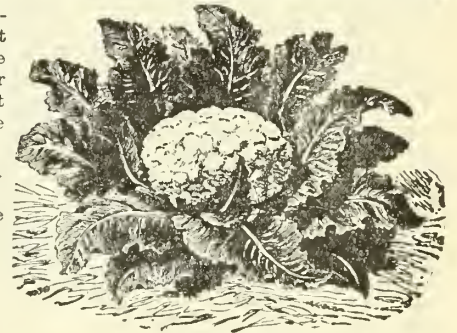

BROCCOLI.

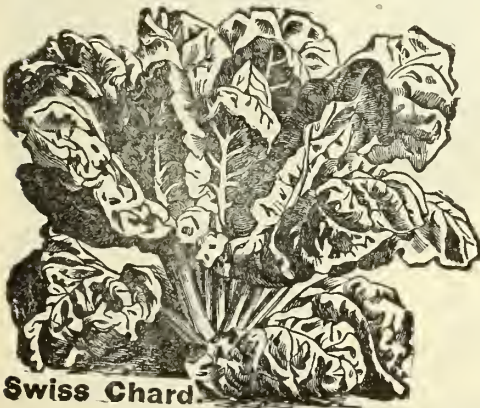

Swiss Chard



Brussels Sprouts.

## BEETS

One Ounce of Seed Will Sow One Hundred Feet of Drill

Select a deep, rich sandy loam and manure with well decomposed compost or a good chemical fertilizer. Sow in drills, 14 to 16 inches apart, and cover 1 inch deep. When the young plants appear, thin to 4 or 5 inches apart. For early use, sow as soon as the ground can be worked in the spring; for autumn use, about the middle of May, and for winter use, during June or July, according to the variety—the long varieties requiring more time to mature than the round, early kinds.

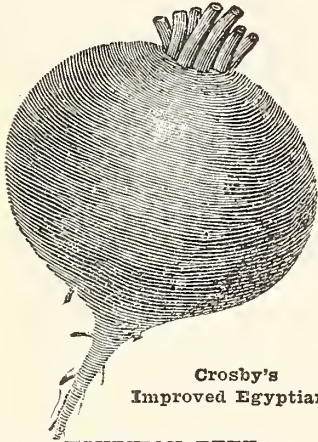

Crosby's  
Improved Egyptian.

### EGYPTIAN BEET. CROSBY'S IMPROVED

A very superior strain of the well-known Egyptian, carefully selected, blood color, quick, rapid growth. The shape is very desirable, as shown in the accompanying photograph, being not so round as the Eclipse, or quite so flat as the ordinary Egyptian. It may be sown outside as late as July. **Pkt., 5c. Oz., 10c. ¼ lb., 30c. Lb., \$1.00.**

### EARLY WONDER.

An improved dark-red very early Beet. Dark skin. Short top on small tap root. **Pkt., 5c. Oz., 10c. ¼ lb., 35c. Lb., \$1.25.**

### EXTRA EARLY EGYPTIAN.

This is a flat Beet, very early and deep red color. Owing to the small top it can be planted very close. **Pkt., 5c. Oz., 10c. ¼ lb., 30c. Lb., \$1.00.**

### G. & T. CO'S EARLY MARKET.

Its qualities are extra early, dark red color, fineness of shape and small top. One of the most attractive varieties grown, and is especially desirable for hotbeds on account of its small top and close-growing habit. **Pkt., 5c. Oz., 10c. ¼ lb., 20c. Lb., \$1.00.**



Eclipse Beet.

### ECLIPSE BEET.

This extra early Beet is remarkable for its fine quality and rapid growth; is of deep red color and handsome shape. As an early market sort it is unrivaled. It is to a large extent superseding the Egyptian, being earlier in development, more attractive in appearance, and of superior quality for the table. **Pkt., 5c. ¼ lb., 30c. Lb., \$1.00.**

### EDMAND'S RED TURNIP.

The most uniform of all Turnip Beets. It is of handsome round shape, good marketable size and deep blood color. It has a small top, and may be planted close. **Pkt., 5c. Oz., 15c. ¼ lb., 30c. Lb., \$1.00.**

### DETROIT DARK RED TURNIP BEET.

This is one of the finest formed and handsomest-colored Beets on the market. It is unsurpassed in the uniformity and beauty of the crop. It is exceedingly early, and produces more marketable specimens on the same acreage than any other variety. **Pkt., 5c. Oz., 10c. ¼ lb., 30c. Lb., \$1.00.**



### G. & T. CO'S EARLY BLOOD TURNIP BEETS.

This is our Special Stock of Early Blood Turnip Beet, which we have been growing for a number of years, and which the market gardeners of Baltimore and other places prefer. It is of dark red color, handsome shape and early. **Pkt., 5c. Oz., 15c. ¼ lb., 30c. Lb., \$1.00.**

### LARGE LONG BLOOD.

A large and desirable late variety of deep red color. **Pkt., 5c. Oz., 10c. ¼ lb., 30c. Lb., \$1.00.**

## MANGEL WURZEL BEETS FOR STOCK

### SOW 4 POUNDS TO THE ACRE.

Stock Beets grow larger than any other Beets, and hence require more room. They should be sown from April to June, in drills 2½ feet apart, and the plants thinned to 12 to 15 inches in the row. The attention of farmers to the growing of Beets for stock feeding has rapidly increased, but it should be grown more generally, and will show the results in the health and condition of the stock. It supplies good, rich food for cattle during the winter.

### LONG RED MANGOLD WURZEL.

The well-known, large, long variety, grows well out of ground. Color light red. Very productive. **Pkt., 5c. ¼ lb., 15c. Lb., 45c.**

### GOLDEN TANKARD MANGOLD.

The best type of Mangold—small top, smooth, rich skin, broad shoulders, very solid fleshed, golden stemmed, heavy producer. **Pkt., 5c. ¼ lb., 20c. Lb., 50c.**

### WHITE SUGAR BEET.

A large-growing sort, and used for feeding stock. **Pkt., 5c. ¼ lb., 15c. Lb., 45c.**

### CHAMPION YELLOW INTERMEDIATE, OR GATE-POST MANGOLD.

One of the very finest Mangolds ever introduced, giving unbounded satisfaction wherever grown. With good cultivation will crop at the rate of 200 bushels per acre. **Pkt., 5c. ¼ lb., 15c. Lb., 45c.**

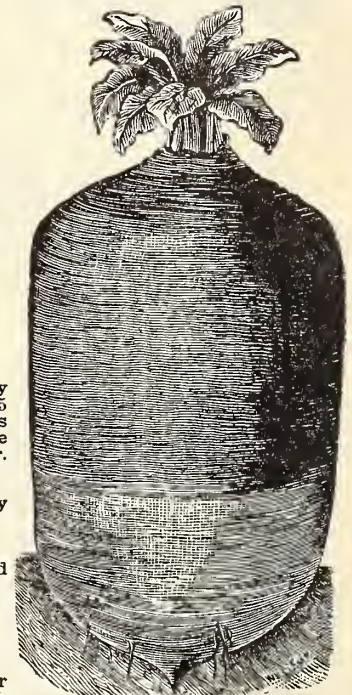

Golden Tankard Mangold.

## CABBAGE

One Ounce of Seed to 100 Feet of Row.

### EARLY CABBAGES.

Cabbage will thrive on any good corn land, though the stronger the soil the better they will develop. New land is preferable. Plow deep and manure very liberally, as cabbage is a strong feeder, and will repay for the care bestowed upon it. The early sorts bear planting from eighteen inches to two feet apart in the rows, with the rows from two to two and a half feet apart. The larger varieties to be from two to four feet apart in the rows, with the rows from two and a half to four feet apart, the distance varying with the size. It does not pay to buy cheap cabbage seed. Ours are American grown, and from the best stock in the country. For early use, sow in a hotbed in February or March, and transplant to a cold-frame as soon as large enough. In April the plants may be set out in the rows. For late crop, sow in nursery bed in May or June, and transplant as soon as the plants are five or six inches high. The ground should be thoroughly cultivated every week until the plants meet in the rows.

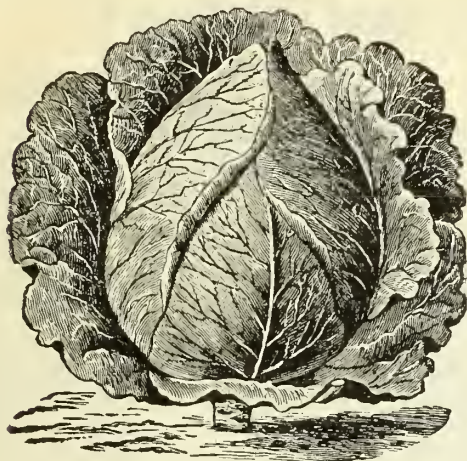

### SELECT EARLY JERSEY WAKEFIELD

American Grown.

The very best early Cabbage, and grown more extensively by market gardeners than any other variety. It is early, the heads are pyramidal in shape, very large and solid, and having but few outside leaves, the plants can be set close together. We secured our seed from a grower of the best Wakefield Cabbage in the country, and it is giving good results wherever it is used, so much so that our sales of this sort are rapidly increasing each year. The demand for this sort has brought on the market inferior stock at a low price; but when select stock, such as we offer, is used it cannot fail to give satisfaction. **Pkts., 5c. and 10c. Oz., 20c. ¼ Lb., 60c. Lb., \$2.25.**

### CHARLESTON, OR LARGE WAKEFIELD

American Grown.

This is now a very popular market cabbage, fully meeting the demand for a cabbage having all the characteristics of the Jersey Wakefield, but larger. It is five to six days later than Early Jersey Wakefield. The heads are fully one-half larger and quite solid. It is very compact in growth, and can be easily planted in rows two feet apart and twenty inches in rows. One great advantage is, it does not burst open when ripe, like many other early sorts, and consequently can be left standing on the ground a long while without injury until a favorable opportunity for cutting. No market or private gardener desiring a cabbage of this kind should fail to plant this valuable sort.

**Pkts., 5c. and 10c. Oz., 20c. ¼ Lb., 60c. Lb., \$2.25.**



LARGE OR CHARLESTON WAKEFIELD.

**KING OF EARLIES.**—Our own introduction; American grown. An extra early variety, fully a week ahead of all other varieties in forming marketable heads; the heads are tall and slim and of rather small size, formed like a Wakefield. Habit, vigorous; short stem and proof against sun. **Pkts., 5c. and 10c. Oz., 20c. ¼ Lb., 60c. Lb., \$2.25.**

**EXTRA EARLY EXPRESS.**—Heads are comparatively thicker and less pointed than Jersey Wakefield and slightly earlier. Heads softer, but stands shipping better. **Pkts., 5c. and 10c. Oz., 20c. ¼ Lb., 60c. Lb., \$2.25.**

**EARLY WINNINGSTADT.**—Head large, cone-shaped and solid. An old and popular sort. **Pkts., 5c. and 10c. Oz., 20c. ¼ Lb., 60c. Lb., \$2.25.**

**LARGE EARLY YORK.**—(American Grown)—One of the earliest. Forms a medium size, pointed head. **Pkts., 5c. and 10c. Oz., 20c. ¼ Lb., 60c. Lb., \$2.25.**

**COPENHAGEN MARKET.**—A new round head, solid cabbage, recently introduced from Denmark. It is without doubt the finest large round-headed early cabbage in cultivation. The type is thoroughly fixed and the heads mature uniformly, which enables the crop to be harvested at one time, so that the ground can be cleared in two cuttings.

It matures as early as the Charleston Wakefield, and will give a heavier yield per acre. In an average season heads will weigh about 8 pounds or more each.

The leaves are light green in color, tightly folded, which produces a short stem plant. We consider it the finest flat-head variety for spring or summer. Our seed comes from the originator direct.

**Pkts., 5c. and 10c. Oz., 30c. ¼ Lb., 90c. Lb., \$3.00.**



Copenhagen Market Cabbage, New From Denmark

## CABBAGE—CONTINUED



**NEW EARLY—American Grown.**

This is one of the finest large early cabbages grown. Forms solid, compact heads, and leaves close to the head, thus allowing many more cabbages to be grown on the acre than any other sort. One of its most striking features is its earliness. It heads so rapidly that the worms can't hurt it.

**Pkts., 5c. and 10c. Oz., 20c. ¼ Lb., 60c. Lb., \$2.25.**

**SUCCESSION CABBAGE.**—A fine early variety, coming in a few days later than Early Summer, but it is immeasurably superior to that variety; it is nearly double the size, and is absolutely true to its type under all conditions. In addition to this, it has no tendency whatever to run to seed. It is one of the finest sorts in existence today; whether for medium early, main crop or late use, it has no superior. It is so finely bred and so true to type that in a field of twenty acres every head appears alike. We can recommend it either for the market gardener, trucker or private planter, as it is a perfect cabbage in every respect, not only being of the largest size; but of handsome color and of the finest quality. It is probably the safest variety for an amateur to plant, as it does well at all seasons, and one is almost sure of getting a crop, no matter when it is planted.

**Pkts., 5c. and 10c. Oz., 20c. ¼ Lb., 60c. Lb., \$2.25.**

**EARLY SUMMER CABBAGE.**—American grown. One of the earliest of the summer varieties. Heads large and flat; short stemmed, few outside leaves, uniform in character, and about 10 days later than the Wakefield. It is very popular with the truckers. **Pkts., 5c. and 10c. Oz., 20c. ¼ Lb., 60c. Lb., \$2.25.**

**LOUISVILLE DRUMHEAD.**—American grown. This is the most popular intermediate or second early with market gardeners around Louisville and the Southwest. It comes off medium early, withstands heat to a remarkable extent, heads large, solid and uniform in size and color. We can recommend this sort very highly for the Southern and Middle States. **Pkts., 5c. and 10c. Oz., 20c. ¼ Lb., 60c. Lb., \$2.25.**

**FOTTLER'S EARLY DRUMHEAD OR SHORT STEM BRUNSWICK CABBAGE.**—In its improved type, this is a very fine summer or early fall variety. Good both for intermediate and winter use. **Pkts., 5c. and 10c. Oz., 20c. ¼ Lb., 60c. Lb., \$2.25.**

### ALL HEAD EARLY

**ALL-HEAD EARLY—American Grown,** is the largest of all early Cabbages, fully one-third larger than the Early Summer. It is the nearest approach to a thoroughbred cabbage of any variety, both in size and uniform development. As the All-Head comes in quicker than any of the other flat cabbages, it is consequently more tender. It is also valuable for a late or winter Cabbage.

**Pkts., 5c. and 10c. Oz., 20c. ¼ Lb., 60c. Lb., \$2.00.**

### EARLY DWARF FLAT DUTCH American Grown.

An old standard variety which stands the sun and produces fine, large heads, coming in soon after the Wakefield.

**Pkts., 5c. and 10c. Oz., 20c. ¼ Lb., 60c. Lb., \$2.25.**



**SUCCESSION CABBAGE.**

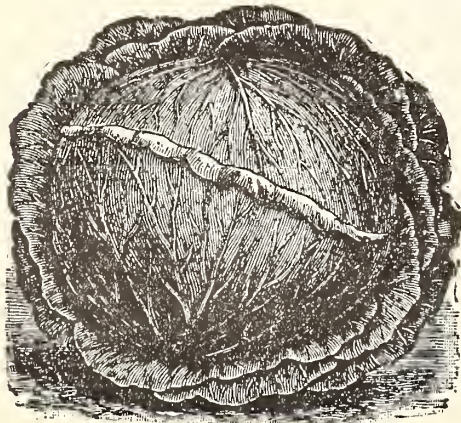

**ALL-HEAD EARLY CABBAGE.**

### ALL SEASON—American Grown

This forms a fine, large head, of superior quality, nearly as early as the Early Summer. Suitable for planting at any season.

**Pkts., 5c. and 10c. Oz., 20c. ¼ Lb., 60c. Lb., \$2.25.**

### SUREHEAD—American Grown

This popular cabbage is rightfully named Surehead, as it never fails to make a fine, large, solid head, with few outer leaves. It is a strong, vigorous grower, and very uniform in size and color. Always brings the highest price in our markets.

**Pkts., 5c. and 10c. Oz., 20c. ¼ Lb., 60c. Lb., \$2.25.**

# LATE OR AUTUMN CABBAGE

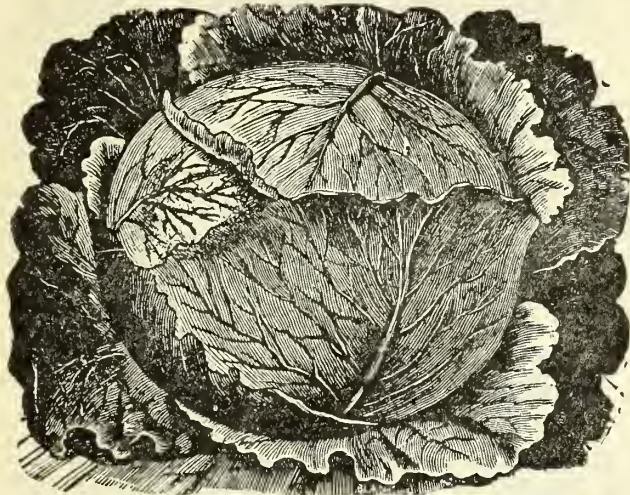

BOSS FLAT DUTCH—LATE CABBAGE.

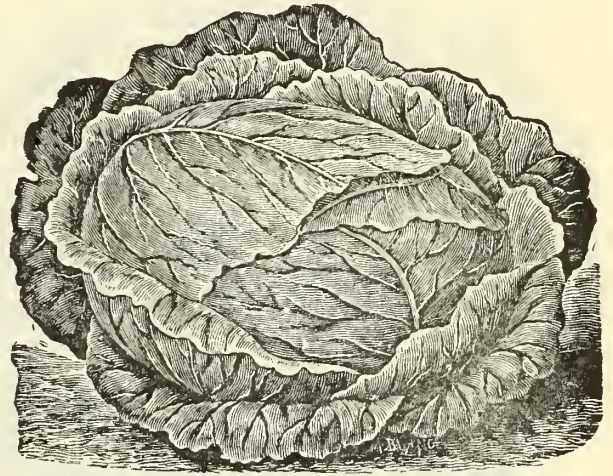

PREMIUM LARGE FLAT DUTCH—LATE CABBAGE.

## BOSS FLAT DUTCH CABBAGE—

In again calling the attention of market gardeners and truckers to this magnificent Cabbage, we should say that it has fully met the claims we made for it upon its introduction. When we ask our customers how they like it, their answer is "Splendid!" or "Elegant!" "Everything heads!" "You can scarcely find any that don't head!" The heads are large, hard, thick and flat, the leaves lapping across the center, making it the most desirable winter variety in cultivation. Try it and be convinced of its superior quality.

Pkts., 5c. and 10c. Oz., 20c. ¼ Lb., 60c. Lb., \$2.25.

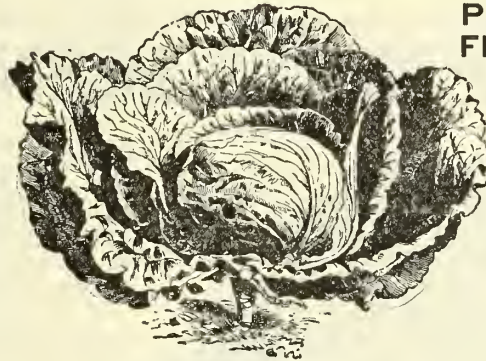

ENKHUIZEN GLORY.

## PREMIUM LARGE LATE FLAT DUTCH CABBAGE—

American Grown.

Large and excellent for winter; very extensively grown. The head is broad, thick and flat, well covered in by leaves lapping across the center, outside leaves feathered to the base of the leaf stem.

Pkts., 5c. and 10c. Oz., 20c. ¼ Lb., 60c. Lb., \$2.25.

# ENKHUIZEN GLORY CABBAGE

A most valuable second-early Cabbage that is becoming immensely popular. It produces fine marketable heads fully as early as our famous Allhead Early—but round or ball-like in form. The heads are very solid, with but few outer leaves—and of such compact growth as to permit quite close planting, thus increasing the yield. The heads are of medium size, tender and of fine flavor. They keep well when put away and consequently Enkhuizen Glory is valuable also for sowing later in the season for early winter use. Plants set out in mid-summer will produce fine heads before cold weather. The seed we offer has been grown by the originator in Holland and will yield heads that will delight the most critical planters.

Pkts., 5c. and 10c. Oz., 20c. ¼ Lb., 75c. Lb., \$2.50.

## DANISH BALL HEAD

This most excellent variety of cabbage, coming from Denmark, has grown very rapidly into favor with both market and private gardeners. It is a large, round, solid heading, medium early variety; a very sure header, having few loose leaves, consequently can be planted very close together. Although a medium early, can also be grown for a fall and winter crop, being one of the best keepers. Very popular in Philadelphia, New York and Boston markets.

Pkts., 5c. and 10c. Oz., 20c. ¼ Lb., 75c. Lb., \$2.75.



DANISH BALL HEAD CABBAGE.

## LARGE LATE AMERICAN DRUMHEAD—American Grown

One of the largest, most solid and best keeping late varieties. This variety seldom fails to head, and is of good quality. Pkts., 5c. and 10c. Oz., 20c. ¼ Lb., 60c. Lb., \$2.25.

## WORLD-BEATER OR AUTUMN KING

This is a very superior late cabbage. The large, broad heads are very thick through, slightly rounded at the top, fine grained and tender, has a short stalk, green color, and one of the best keepers we know, and is a rapid grower. Pkts., 5c. and 10c. Oz., 20c. ¼ Lb., 60c. Lb., \$2.25.

## RED DUTCH

The head is round, large, solid and a deep red color, the best of the red cabbages. Pkts., 5c. and 10c. Oz., 20c. ¼ Lb., 75c. Lb., \$2.50.

# LATE CABBAGES---CONTINUED

## PERFECTION DRUMHEAD SAVOY

AMERICAN GROWN.

This is without any exception the finest stock of Savoy cabbage to be found anywhere. The heads are large and solid, the leaves beautifully curled, and in tenderness and flavor it is almost equal to cauliflower, while its keeping quality is first class. To say that our market gardeners are pleased with it is putting it mild; they are enthusiastic over it, as they find it so much superior to the old-time Savoy. It is specially adapted to private use, as when grown in the fall and allowed to be touched by frost it is one of the most delicious

Packets, 5c. and 10c. Oz., 20c.  $\frac{1}{4}$  Lb., 60c., Lb., \$2.25.

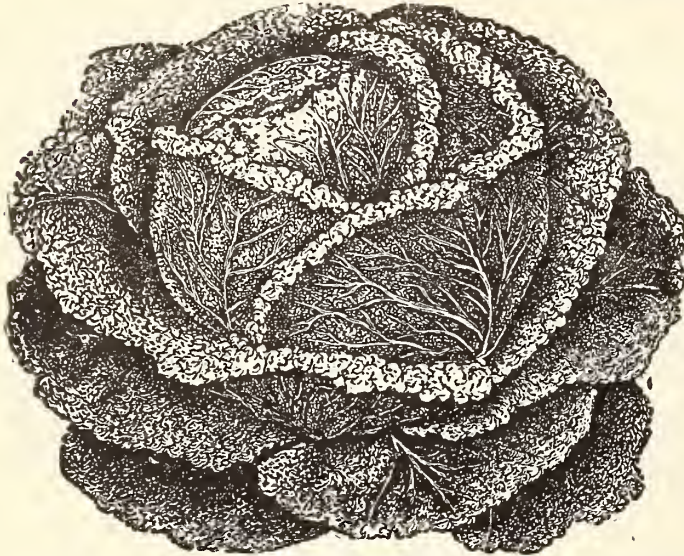

DRUMHEAD SAVOY.

## GEORGIA COLLARDS

Called the Cabbage Collard on account of its close bunching growth. The plant produces center leaves generally perfectly white, though sometimes dashed with pink. It is a very delicate vegetable and of the finest quality.

Packets, 5c. and 10c.  $\frac{1}{4}$  Lb., 30c. Lb., 75c.

# G. & T. CO.'S LARGE GILT EDGE SNOWBALL CAULIFLOWER

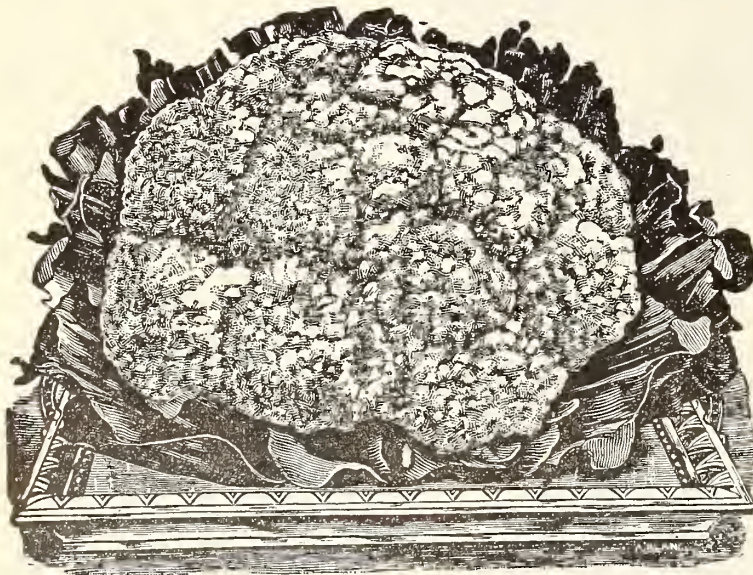

Is without exception one of the finest sorts now in cultivation. It is very early. Nearly every plant will, under proper cultivation, form a perfect snow-white head, and its close growing, compact habit enables the grower to plant one-third more on the same space of ground than other varieties. In fact, it is, and deserves to be, the standard with the market gardener and amateur.

Packets, 25c. and 50c.  $\frac{1}{2}$  oz., 90c. Oz., \$1.50.  
 $\frac{1}{4}$  Lb., \$5.00.

**EXTRA EARLY SNOWBALL.**—Our stock of this well-known variety is unexcelled. It is one of the best sorts for open ground or forcing under glass.

Packets, 25c. and 50c.  $\frac{1}{2}$  oz., 75c. Oz., \$1.50.

**G. & T. CO.'S "DROUTH-RESISTING."**—Produces large white solid heads, maturing about a week later than our large Gilt Edge Snowball. The best for hot, dry weather.

Packets, 25c. and 50c.  $\frac{1}{2}$  oz., 90c. Oz., \$1.50.  
 $\frac{1}{4}$  lb., \$5.00.

**G. & T. CO.'S SELECT EARLY DWARF BERTHURF.**—Long the standard of highest excellence, and still holding its own with a great many people.

Packets, 25c. and 50c.  $\frac{1}{4}$  oz., 50c. Oz., \$1.50.

**Culture.**—The same as for Cabbage, except that extra manure and plenty of water will pay upon Cauliflower. If the soil be dry, water frequently, and if the plants could have a heavy mulch of hay from drouth. The early kinds should be strong enough to plant out not later than the middle of April; the late kinds may be planted out same time as for Cabbage.

## CORN SALAD

Three Ounces of Seed to 100 Feet of Row.

A favorite salad plant, and very hardy. Sow in August or September, and protect with leaves during the winter; it can be gathered in the spring very early. Sown in April, it is soon ready for use. The leaves are sometimes boiled and served as spinach.

Pkt., 5c. Oz., 10c.  $\frac{1}{4}$  Lb., 20c.  
Lb., 75c.



## GRESS, OR PEPPER GRASS

Used as a small salad. Sow very thickly in shallow drills, on a smooth surface, at short intervals throughout the season.

**CURLED.**—Pkt., 5c. Oz., 10c.  $\frac{1}{4}$  lb., 25c. Lb., 75c.

**WATER CRESS.**—Water Cress may be grown along the margin of running streams, ditches or ponds, and has a ready sale in the hotels and markets.

Pkts., 5c. and 10c. Oz., 30c.  $\frac{1}{4}$  Lb., 75c. Lb., \$2.50.

ALL PRICES SUBJECT TO CHANGE WITHOUT NOTICE.

# G. & T. CO.'S CARROTS

1 OZ. OF SEED TO  
100 FEET OF ROW

Carrots thrive best in rather a light, rich loam. The ground should be well manured with fine, well-rotted or composted manure, and be thoroughly worked quite deep. Sow from middle of April to middle of May, in rows 14 inches apart, and thin the plants to 5 or 6 inches in the row. For late crops sow in June or July. An important point is to tread the rows firmly after sowing. For field culture, Carrots should be sown in drills 3 to 3½ feet apart, so as to cultivate with horse.

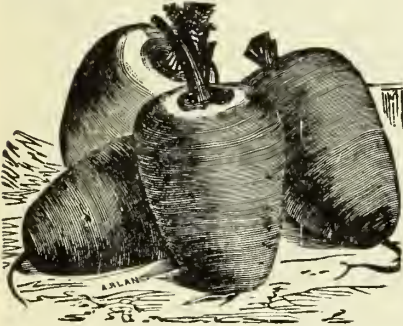

**OXHEART OR GUERANDE.**

## Oxheart or Guerande

One of the heaviest yielders and the best for stiff and heavy soils where the long varieties would fail. The roots are often 3 to 3½ inches thick at the top; nearly oval in shape; the flesh is bright orange, fine grained and sweet. Of the finest table quality and equally good for stock.

Pkt., 5c. Oz., 10c. ¼ lb., 30c. Lb., \$1.00



**CHANTENAY.**

## CHANTENAY

A most excellent, medium early, half long variety. It is one of the best in quality for the market and home garden, while its great productiveness and the ease with which it can be harvested make it desirable as a field sort. The tops are medium sized with small neck. The mature roots are thick, five and one-half to six inches in length, uniformly half long or stump rooted but tapering slightly, smooth, deep orange-red in color. The flesh is very crisp and tender. Although a medium early sort the roots are suitable for use nearly as early as any. The variety is extensively used for bunching.

Pkt., 5c. Oz., 10c. ¼ lb., 30c. Lb., \$1.00

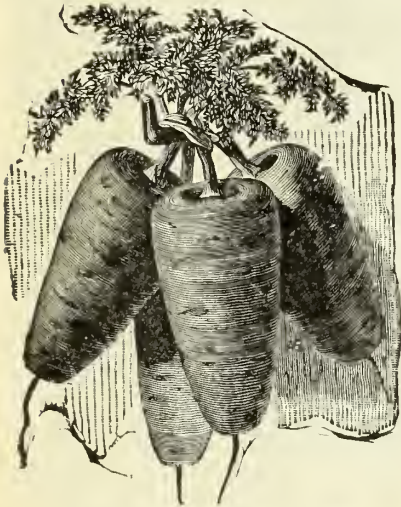

**EARLY SCARLET HORN.**

## EARLY SCARLET HORN

The earliest variety in our list. Blunt-pointed, about 3 inches long, 1½ inches thick, very fine grained, sweet flavored; deep rich orange color. Fine for bunching.

Pkt., 5c. Oz., 10c. ¼ lb., 30c. Lb., \$1.00

## HALF LONG DANVERS

A decided acquisition of the half-long type, broad-shouldered, cylindrical, admirable in color, fixed in habits, a wonderful producer. It is a first-class Carrot for all soils.

Pkt., 5c. Oz., 10c. ¼ lb., 30c. Lb., \$1.00

## IMPROVED LONG ORANGE

Deep orange color, long, smooth, fine for either garden or field culture. All who have cattle should raise a surplus of this Carrot for feeding milch cows during winter. It increases the flow of milk and imparts to the butter a delicious flavor and a rich golden color.

Pkt., 5c. Oz., 10c. ¼ lb., 30c. Lb., \$1.00

## SCARLET INTERMEDIATE

A fine handsome Carrot, in form midway between the Long Orange and Early Scarlet Horn. The roots are smooth and handsome, deep orange color, medium length tapering to a blunt point. The flesh is sweet, crisp and tender.

Pkt., 5c. Oz., 10c. ¼ lb., 30c. Lb., \$1.00



**IMPROVED LONG ORANGE.**



**DANVERS.**

## 1 Oz. Will Produce 2000 Plants. **CELERY**

### CELERY

Requires water, and lots of it, from the time the seed is sown in boxes in March until it is pulled in the autumn or winter. The seed is slow to germinate, and the soil where it is planted needs to be kept very wet.

Plant seed in hotbed or very early in open ground. Transplant 4 inches apart when 3 inches high in rich soil, finely pulverized; water and protect until well rooted. In June or July transplant into rows 3 to 4 feet apart, either on surface or well-manured trenches a foot in depth, half filled with well-rotted manure. Set the plants from 6 to 8 inches apart. To blanch, draw earth around the plants from time to time, taking care not to cover the top of the center shoots.

### FRENCH GOLDEN SELF-BLANCHING

This cannot be too highly recommended, as after being thoroughly tested it has fulfilled all that has been claimed for it. It is decidedly the very best and most profitable Celery in cultivation; it is very early and entirely self-blanching. The beautiful appearance of the plant, its close habit, compact growth, straight, vigorous stalks, solid, crisp, brittle ribs, fine quality and delicious flavor commend it to all lovers of Celery. No variety can surpass it, indeed, equal the Paris Golden Self-Blanching in its striking appearance and delicious flavor. Our stock of this variety has been giving the market gardeners the very best results for several years.

**Pkts., 5c. and 10c. Oz., 50c. ¼ lb., \$1.50. Lb., \$5.00.**

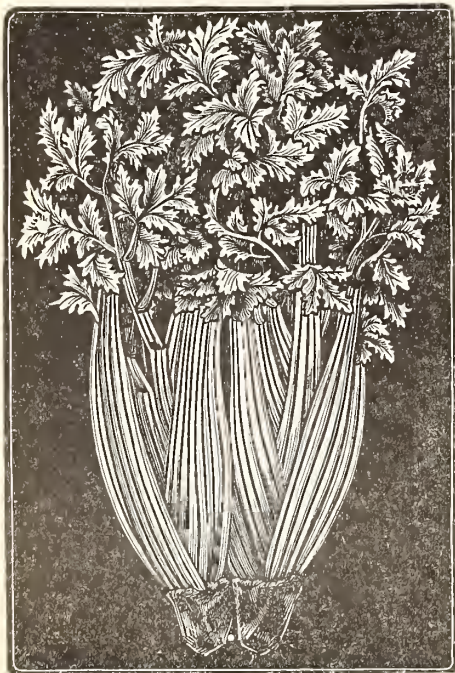

White Plume Celery.

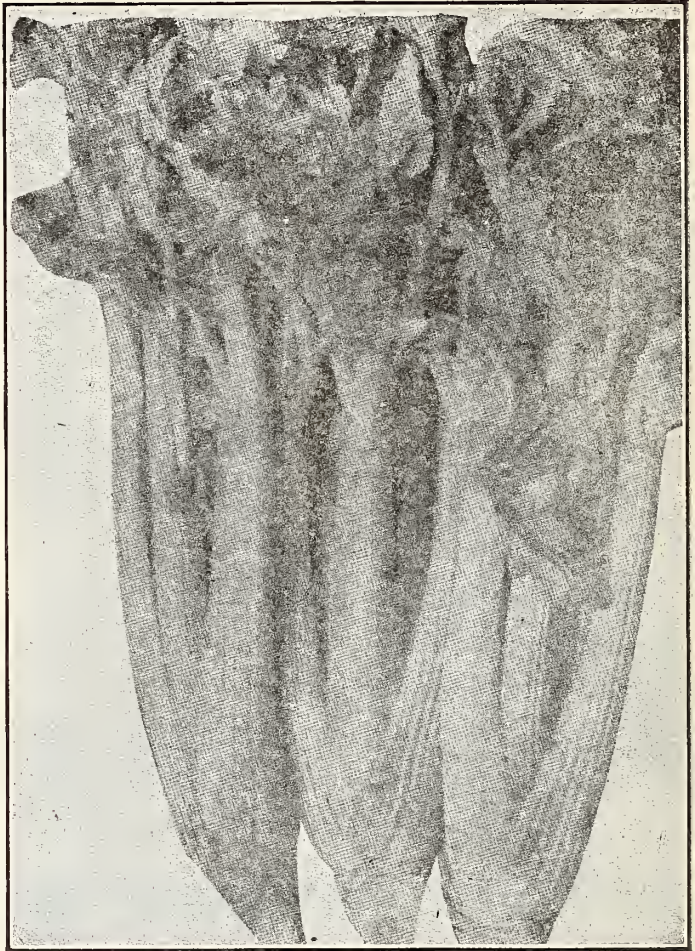

FRENCH GOLDEN SELF-BLANCHING CELERY.

### Improved Boston Market

This is a decided improvement on the old Boston Market, being earlier, larger in size and of more vigorous growth.

**Pkts., 5c. and 10c. Oz., 20c. ¼ lb., 50c. Lb., 1.75.**

### White Plume

An early, handsome, self-bleaching variety, growing in popularity every year. Like the Golden Self-Blanching, it requires very little earthing up to blanch it, and as a Celery for fall and early winter use it is unsurpassed.

**Pkts., 5c. and 10c. Oz., 20c. ¼ lb., 60c. Lb., \$2.00.**

### White Solid

A large standard sort. One of the large growing sorts.

**Pkts., 5c. and 10c. Oz., 20c. ¼ lb., 50c. Lb., \$1.75.**

### Celery Seed For Flavoring

This seed is used for flavoring pickles, soups, etc.

**Pkt., 5c. ¼ lb., 25c. ½ lb., 40c. Lb., 75c.**



## CELERY—CONTINUED

1 Oz. Will Produce 2000 Plants.

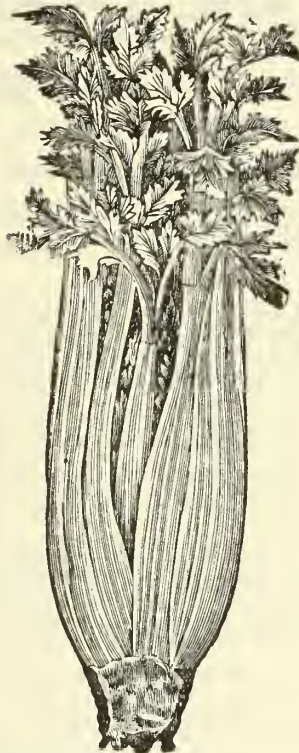
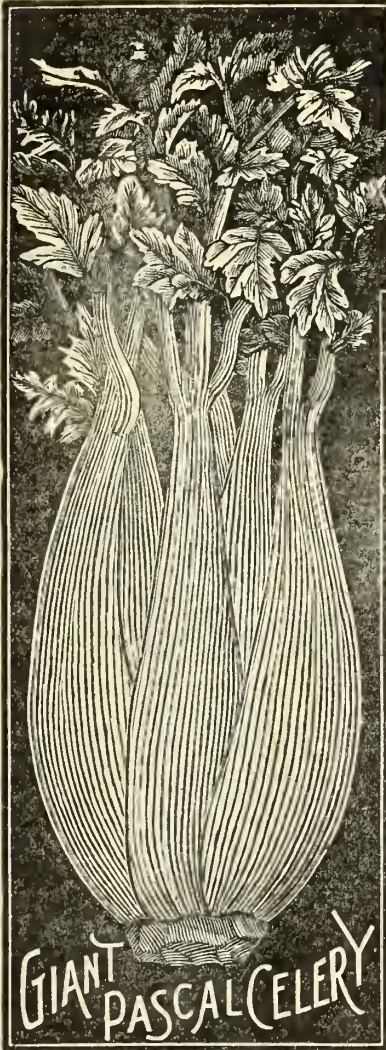

WINTER QUEEN CELERY.



GOLDEN HEART, OR GOLDEN DWARF CELERY.

### GIANT PASCAL CELERY.

A selection from the well-known Self-Blanching Celery. It partakes of the best qualities of that variety, is somewhat larger, and an excellent keeper. It is of fine nutty flavor, being entirely free from any bitter taste. It grows about 2 feet high. The stalks are very broad, thick and crisp; the width and thickness of these are distinctive features of this variety. Pkts., 5c. and 10c. Oz., 20c. ¼ lb., 50c. Lb., \$1.75.

### GOLDEN HEART, OR GOLDEN DWARF CELERY.

This old standard variety still holds a high place in the estimation of market gardeners, and is largely used, always giving satisfaction. A showy sort, solid, of fine flavor and a good keeper. Pkts., 5c. and 10c. Oz., 20c. ¼ lb., 50c. Lb., \$1.75.

### WINTER QUEEN CELERY.

It is, without doubt, the most valuable variety of Celery for winter and spring use ever introduced. It is also much stouter, thicker and heavier, with double the amount of heart of any known Celery. The plant is beautiful in appearance of close habit and compact growth, and blanches to a beautiful cream white. Ribs perfectly solid, crisp and of delicious nutty flavor. Pkt., 10c. Oz., 20c. ¼ lb., 50c. Lb., \$1.75.

### NEW YORK GIANT SELF-BLANCHING CELERY.

A fine large, white self-blanching celery. It is extra early, and if sown in early spring can be had for market in August. We consider it the best white variety for the early fall trade; has a vigorous growth and attains a very large size; is crisp, tender, brittle and very sweet, with a nutty flavor superior to any of the old kinds. Pkts., 5c. and 10c. Oz., 30c. ¼ lb., 60c. Lb., \$2.00.

## CELERIAC

### OR TURNIP ROOTED CELERY.

#### LARGE SMOOTH PRAGUE.

The largest, smoothest and best of the Celeriacs. Pkts., 5c. and 10c. Oz., 15c. ¼ lb., 50c. Lb., \$1.75.

#### NEW APPLE SHAPE.

Small foliage, large, round and smooth. Pkts., 5c. and 10c. Oz., 15c. ¼ lb., 50c. Lb., \$1.75.

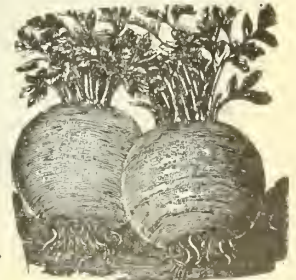

Large Smooth Prague.

ALL PRICES SUBJECT TO CHANGE WITHOUT NOTICE.

## CORN FOR TABLE USE

56 POUNDS PER BUSHEL

WHEN CORN IS WANTED BY MAIL, ADD 6 CENTS PER POUND TO PAY POSTAGE.

**CULTURE.**—Sugar Corn may be planted in rows 3 to 4 feet apart, and the seeds placed about 8 inches apart in the rows, or planted in hills 3 to 4 feet apart each way, according to variety grown, or richness of soil. Do not let more than three plants remain in each hill. It can be planted in this vicinity from first of May to last of July for succession of crop. By planting every two weeks a family may have good corn throughout the whole season.



Extra Early  
Baltimore.

Not a Sugar Corn, but are used for very early planting and will mature nice roasting ears before the sweet corn.

### FIRST EARLY VARIETIES

FIRST EXTRA EARLY VARIETIES.



Extra Early  
Adams

**EXTRA EARLY BALTIMORE.**—The hardiest and earliest variety for table use; it can be planted earlier than any other, but is not a sweet corn; white indented grains and short ears. **Pint, 20c. Quart, 40c. Peck, \$2.50.**

**EXTRA EARLY ADAMS.**—Extremely hardy and early; one of the best for early planting. **Pint, 20c. Quart, 40c. Peck, \$2.50.**

**EARLY ADAMS.**—A favorite in the South. **Pint, 20c. Quart, 40c. Peck, \$2.50.**

**NINETY-DAY CORN (Red Cob).**—This is an elegant corn for truckers and market gardeners, as it is as good a seller as green corn, and if not used as green corn makes a good variety for feeding purposes. It may be planted for early crop, and at intervals until the middle of July. Many truckers use it for their late planting, as it produces a very sure crop. **Quart, 40c. Peck, \$1.25. Bushel, \$4.50.**

## SWEET OR SUGAR CORN

EXTRA EARLY VARIETIES. (Bushel Sweet Corn, 44 Lbs.).

### DE LUE'S GOLDEN GIANT SUGAR CORN

**DE LUE'S GOLDEN GIANT SUGAR CORN** is the result of fourteen years of selection from the product of the **Howling Mob** crossed with **Golden Bantam** and combines all the good points of both parents. Because of its excellent qualities it was awarded the only medal given by the Massachusetts Horticultural Society in 67 years, and has since been given three first prizes by the same society.

The stalks grow 4½ feet to 6 feet tall and very near the ground; about one-third are purple in stalk, leaf and husk. They carry two or three good ears, 7-9 inches long; cob of small diameter, with 12-20 rows of long, deep kernels of deep orange color. The husk is very heavy, affording the end protection from worm and bird.

Customers of the last three years report that it is the sweetest and most tender and juicy of all sweet corns, and that it is in some cases one to two weeks earlier than Bantam, besides being three times as large.

It excels all other early varieties in size, productiveness and quality, and all the late varieties in quality and early maturity. It is the one corn for the home or market gardener who wants the greatest amount of highest quality corn in the shortest period of time from the smallest piece of land.

Our seed is grown and packed by the originator. **Pint, 30c. Quart, 50c.**

**NEW GOLDEN BANTAM SUGAR CORN.**—The earliest and best of sugar corns. It is of golden color and delicious flavor, with the sweetness of honey; can be planted earlier than the other varieties of true sweet corn, as it is very hardy. The stalks are dwarf in habit, growing about four feet high, producing two or three good ears five to six inches long, well set from the ground. **Pint, 25c. Quart, 50c. Peck, \$3.00.**

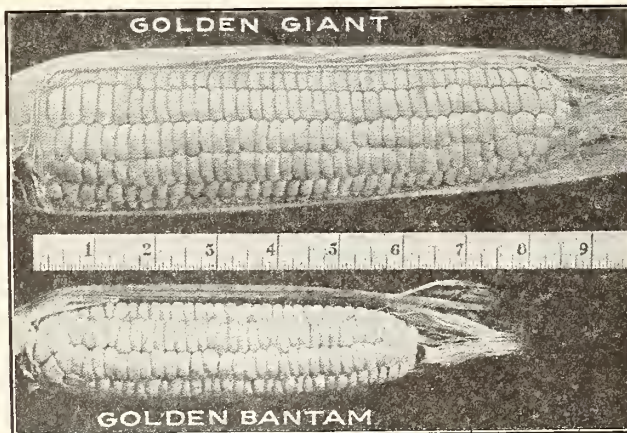

Comparative Size of Golden Bantam and New Golden Giant Sugar Corn.

**PREMO.**—The best early sweet corn on the market. A genuine sweet corn as early as the Adams Extra Early, and larger than any other early variety. The quality is the best, ears measuring 7 to 9 inches long, being well filled to the end; generally bearing two ears to the stalk. **Pint, 25c. Quart, 50c.**

**CORY.**—An early variety, red cob. **Pt., 25c. Qt., 50c.**

**FIRST OF ALL.**—A selection from the Cory, the ears about the same size as the Cory, lighter in color and earlier. **Pint, 25c. Quart, 50c.**

**WHITE CORY.**—An early variety, with good-sized ears and large kernels. **Pint, 25c. Quart, 50c.**

**STABLEY'S EARLY.**—Of larger size than usual for the early kinds. It is remarkable for the fine flavor and sweetness, and is a desirable gardeners' and canning variety. **Pint, 25c. Quart, 50c.**

**CROSBY'S EXTRA EARLY.**—An early market variety, very productive; ears rather short and rich, sugary flavor. **Pint, 25c. Quart, 50c.**

**EARLY MINNESOTA SUGAR.**—One of the first early among sugar corn. **Pint, 25c. Quart, 50c.**

**BLACK MEXICAN SUGAR.**—The black corn is especially rich in sugary qualities. **Pint, 25c. Quart, 50c.**

**CAUTION.**—Sweet Corn in bulk, even after being thoroughly cured, will often gather moisture and spoil, particularly if it has been exposed to a low temperature. To prevent this it should be taken out of the bag as soon as received and spread in a dry place.

ASK FOR PRICES IN QUANTITY.

ALL PRICES IN CATALOG SUBJECT TO CHANGE WITHOUT NOTICE.

## SWEET OR SUGAR CORN FOR TABLE USE

**CAUTION.**—Sweet corn in bulk, even after being thoroughly cured, will often gather moisture and spoil, particularly if it has been exposed to a low temperature. To prevent this it should be taken out of the bag as soon as received and spread in a dry place.

**EARLY SHEFFIELD.**—Plant as early as Adams. Makes strong, vigorous growth with abundant foliage, growing about 5 feet and bearing usually 2 ears of handsome appearance. **Pt., 30c. Qt., 60c.**

**METROPOLITAN.**—Extra early, ripens a few days later than Cory, but produces larger ears. **Pt., 30c. Qt., 60c.**

## MAIN CROP VARIETIES

**COUNTRY GENTLEMAN CORN.**—This is the sweetest and most deliciously flavored of all sugar corn. It is the finest variety for the table, and will delight the most fastidious epicure. It produces three to four ears to the stalk, and retains its greenness longer than other sorts. **Pint, 30c. Quart, 60c.**

**STOWELL'S EVERGREEN.**—So well known that it scarcely needs description. Excellent; keeps green till cold weather; ears large; one of the best. **Pint, 30c. Quart, 60c.**

**TRUCKERS' EARLY SUGAR CORN.**—This is the most desirable variety of sugar corn for truckers and gardeners to plant early. As its many excellent qualities are becoming generally known, it has come to be one of the standard sorts. It is ten days earlier than Evergreen, very productive, growing two to four ears to the stalk. The ears set low, are large and well filled, the grain long and narrow, similar to Evergreen, but smaller. It is one of the most productive varieties in cultivation. **Pint, 30c. Quart, 60c.**

**LATE MAMMOTH.**—The largest variety grown; very fine for market purposes. **Pint, 30c. Quart, 60c.**

**HOWLING MOB.**—Extra large, white, fine flavor. **Pint, 30c. Quart, 60c.**

**ZIGZAG EVERGREEN.**—This is one of the sweetest and best late sweet corn, not even excepting the celebrated Country Gentleman and Shoe Peg. The ears resemble Stowell's Evergreen in size and shape, except that the kernels are placed irregularly or zigzag upon the cob, which is always an indication of great sweetness in any variety of sugar corn. **Pint, 30c. Quart, 60c.**

**EARLY MAMMOTH.**—A splendid market sort, producing large, handsome ears; grain large, white and sweet; fills out well at the end. **Pint, 30c. Quart, 60c.**

**WHITE EVERGREEN.**—Has ears as large as Stowell's, is five days earlier; grains pure white. A valuable acquisition for the gardener and canner. **Pint, 30c. Quart, 60c.**

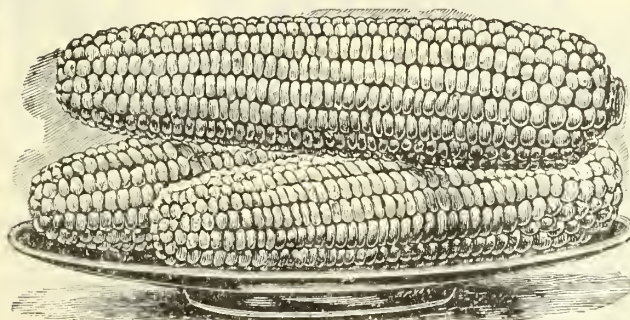
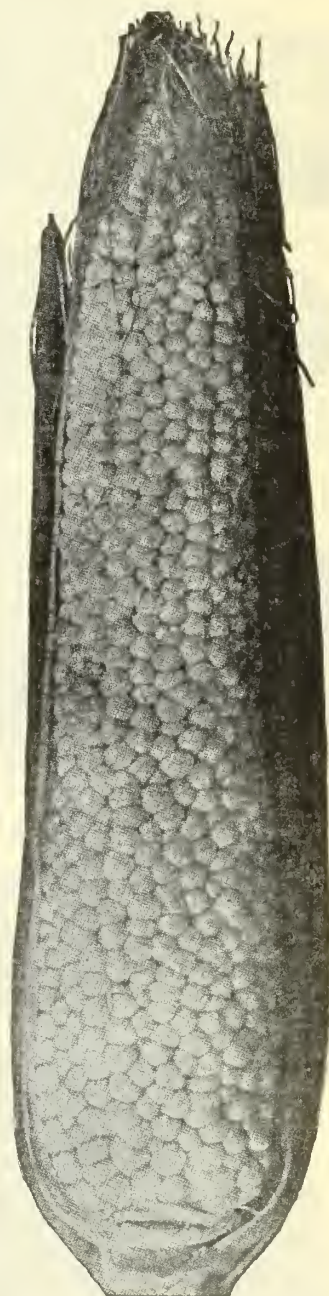
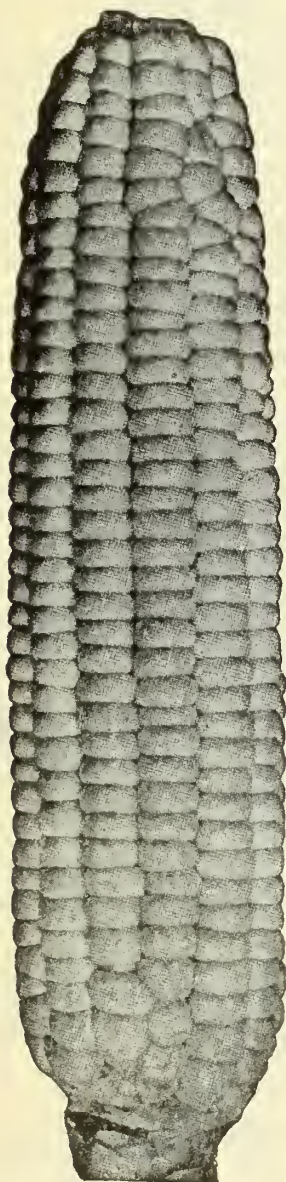

**STOWELL'S EVERGREEN.**

**BUSHEL SWEET CORN CONSISTS OF 42 POUNDS.**

**ASK FOR PRICES IN QUANTITY.**

1 Oz. Will Plant 50 Hills.  
2 Lbs. Will Plant an Acre.

## CUCUMBER CULTURE

For very early Cucumbers sow the first of April in a hotbed upon pieces of sod (grass side down), so that they can be readily transplanted to the open ground in rich soil when danger of frost is over, or protect by hand-glasses. The vines require a warm location for early Cucumbers. Plant after the ground has become warm in hills 4 feet apart for the smaller varieties, and 5 feet for the larger sort. For pickling sow from middle of June to last of July. Manure with

ashes, fertilizer or some well-rotted compost, working the manure just under the surface. Sprinkle the vines with slug-shot, plaster or air-slaked lime to protect from bugs. The Cucumbers should be gathered when large enough for use, whether required or not; if left to ripen, it destroys their productiveness.

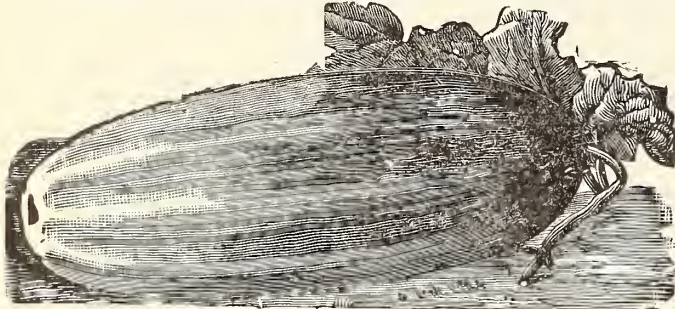

**IMPROVED BALTIMORE WHITE SPINE.**

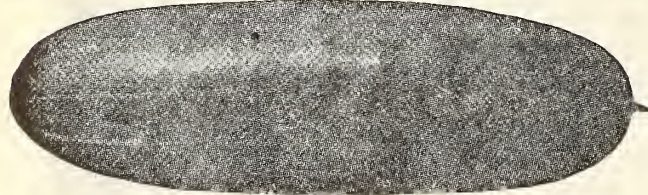

**EARLY FORTUNE CUCUMBER.**

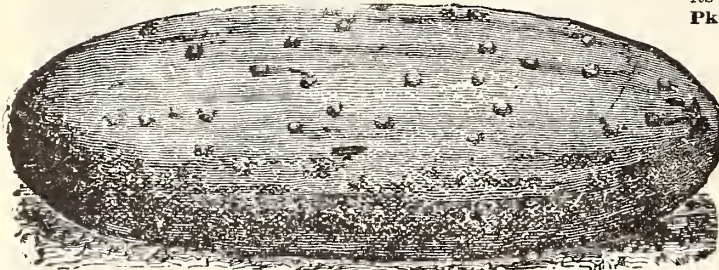

**JERSEY PICKLING.**

## IMPROVED BALTIMORE WHITE SPINE

This is the best Cucumber for early planting, because it will retain its green color longer than any other sort. It is of good size and shape, and the popular variety with truckers around Baltimore and Norfolk, as well as the growers from Virginia to Florida. **Pkt., 5c. Oz., 15c. ¼ Lb., 30c. Lb., \$1.10.**

**EXTRA EARLY WHITE SPINE.**—A strain of White Spine which has been improved through careful selection, with a view to use for forcing in hothouses and frames; also elegant for field culture. Our stock produces handsome, dark-colored fruits, which retain their color longer than other sorts. **Pkt., 5c. Oz., 15c. ¼ Lb., 30c. Lb., \$1.10.**

**ARLINGTON WHITE SPINE.**—A favorite extra early variety, of desirable size, handsome shape, dark green color, holding its color longer than most others. Good shipper and sells well. **Pkt., 5c. Oz., 15c. ¼ lb., 30c. Lb., \$1.10.**

**EARLY FORTUNE CUCUMBER.**—One of the earliest and best dark green White Spine Cucumbers. Extremely early, and beautiful shape. Good for market gardeners, truckers or private family; in fact, any one who likes a dark green white spine cucumber it cannot help but please. Fine for Southern growers, as it stands shipping remarkably well. **Pkt., 5c. Oz., 15c. ¼ lb., 30c. ½ lb., 55c. Lb., \$1.10.**

**JERSEY PICKLING.**—This is the most popular sort with the market gardeners around Baltimore and Philadelphia for pickling. Said to green better than any other variety. **Pkt., 5c. Oz., 15c. ¼ lb., 30c. Lb., 75c.**



**IMPROVED LONG GREEN.**

## IMPROVED LONG GREEN

The skin is of a deep green, and the flesh is solid, crisp and of fine quality. We have the very best strains of this variety and recommend it as much the best cucumber of all, and the variety every one should plant. The best known and most popular variety for general use. Is vigorous and productive, and forms fruit fit for use almost as early as the shorter varieties. The mature fruit is almost 12 inches long. **Pkt., 5c. Oz., 15c. ¼ lb., 35c. Lb., \$1.25.**

### CHICAGO PICKLING.

**Very Popular with Chicago Market Gardeners, and Extensively Grown in That Vicinity.** Fruit medium length, pointed at each end, with very large and prominent spines; color deep green. **Pkt., 5c. Oz., 15c. ¼ lb., 30c. Lb., \$1.10.**

### BURR, OR WEST INDIA GHERKIN.

An extremely small fruited variety, grown exclusively for pickles. It has no value for slicing. Is very prickly, but tender and crisp if pickled when young. Seed germinates slowly. **Pkt., 5c. Oz., 20c. ¼ lb., 40c. Lb., \$1.50.**

ALL PRICES IN CATALOG SUBJECT TO CHANGE WITHOUT NOTICE.

# CUCUMBERS—CONTINUED

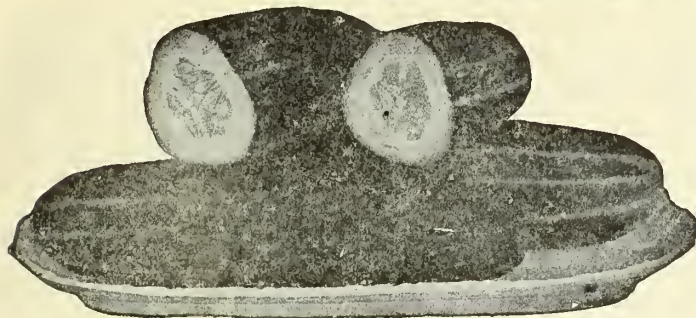

EARLY GREEN PROLIFIC.

## Early Green Prolific

A very productive variety, having fruits of good length and handsome form. Desirable for producing pickles of medium size and fine quality when sliced for the table.

Pkt., 5c. Oz., 15c.  $\frac{1}{4}$  lb., 30c. Lb., \$1.10.

## Ever-Bearing Cucumber

This variety is unique, and will prove valuable both for the table and for pickling. Is of small size, very early, enormously productive and extremely valuable as a green pickler. The peculiar merit of this new Cucumber is that the vines continue to flower and produce fruit until killed by frost, whether the ripe Cucumbers are picked off or not, in which respect it differs from all other sorts in cultivation.

Pkt., 5c. Oz., 15c.  $\frac{1}{4}$  lb., 30c. Lb., \$1.10.



EVER-BEARING CUCUMBER.

## CUMBERLAND

A new and distinct variety. Said to have originated from crossing the Parisian Pickling and the Early White Spine. It certainly has the good qualities of each of these sorts. The fruits are large, symmetrical, dark green, covered with innumerable small white spines, and are of prime quality for slicing. The vine is vigorous, wonderfully prolific, and continues in bearing much longer than most sorts.

Pkt., 5c. Oz., 15c.  $\frac{1}{4}$  lb., 30c. Lb., \$1.10.

## EARLY CLUSTER

A short, prickly variety, bearing in clusters near the root. A good bearer. Pkt., 5c. Oz., 15c.  $\frac{1}{4}$  lb., 30c. Lb., \$1.10.

## JAPANESE CLIMBING CUCUMBER

It bears abundantly throughout the season, while the climbing habit enables the hanging fruit to grow perfectly straight, from 12 to 16 inches in length; the Cucumbers are thick, tender and of delicate flavor; flesh white, skin dark green, turning to brown, and netted when ripe.

Pkt., 10c. Oz., 15c.  $\frac{1}{4}$  lb., 30c.

## TELEGRAPH (ENGLISH FORCING)

Should be grown in hotbeds where the temperature does not fall below 65 degrees at night. Pkt., 25c.



EARLY CLUSTER CUCUMBER.

# Green Curled Endive

Is One of the Best Salads for Fall and Winter Use. One Ounce of Seed to 150 Feet of Row.

For early use, sow as soon as the ground can be worked in the spring, in drills 15 inches apart, and then thin plants to 6 or 8 inches in the row. To blanch the leaves, gather them carefully together when perfectly dry and tie them with matting or soft fibrous material. Another method is to invert flower pots over the plant. The leaves are very highly esteemed for use as salads.

## Green Curled

The best sort in use. Useful as a salad, and also used for garnishing.

Pkt., 5c. Oz., 15c.  $\frac{1}{4}$  lb., 40c. Lb., \$1.50.



GREEN CURLED ENDIVE.

## BALTIMORE

# EGG PLANT

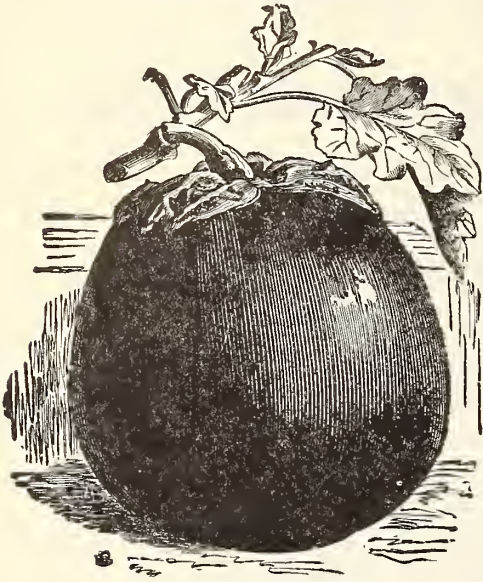

**EGG PLANT**

**CULTURE.**—Sow the seed in hot-beds early in March. When three inches high pot the young plants, using small pots, and plunge them in the same bed so that the plants may become stocky. They can be planted out from the pots when the season becomes sufficiently warm in May or June, or they can be transplanted into a second bed to make them strong until the weather is warm enough to transplant about three feet apart each way in thoroughly-worked and well-enriched soil. Draw the earth up to the stems when about a foot high. Egg Plant Seed will not vegetate freely without a strong, uniform heat, and if the plants get the least chilled in the earlier stages of growth they seldom recover. Therefore, repeated sowings are sometimes necessary. Care should be observed in cutting the fruit so as not to disturb the roots of the plants. **One ounce will produce about 1000 plants.**

**BLACK BEAUTY EGG PLANT.**—The earliest of all large fruited Egg Plants, and produces fruit quite as large as the **NEW YORK PURPLE** in 10 days' less time. The fruit is symmetrical in shape, of uniform size, of a dark rich purple color, which does not fade or change to lighter color at blossom end like some other varieties. Just the variety for the market gardener and trucker for early spring trade. **Pkt., 10c. Oz., 30c. ¼ lb., \$1.00. Lb., \$3.50.**

**NEW YORK IMPROVED LARGE PURPLE EGG PLANT.**—This market garden variety has plants of strong growth, and is very productive, producing plants of large size and fruits of smooth, deep purple color until frost. **Pkts., 5c. and 10c. Oz., 30c. ¼ lb., \$1.00. Lb., \$3.50.**

**THE FLORIDA HIGH-BUSH EGG PLANT.**—Is in great demand by Southern truckers. It has very vigorous growth and remarkably hardy. The plant grows very erect and holds the fruits clear of the ground. **Pkts., 5c. and 10c. Oz., 30c. ¼ lb., \$1.00. Lb., \$3.50.**

**BALTIMORE EGG PLANT.**—This is decidedly the best and most profitable Egg Plant in cultivation. It is large thornless, of beautiful shape and handsome purple color. We have never seen finer specimens of Egg Plant than those grown from our seed. When inspecting the field of Egg Plants growing for seed we were surprised at the regular size and uniform, handsome color of the fruit all over the field.

**Pkt., 10c. Oz., 30c. ¼ lb., \$1.00. Lb., \$3.00.**



**EXTRA CURLED NEW AMERICAN KALE.**

# KALE

**One Ounce of Seed Will Sow a Drill of About 200 Feet.**

The Kales are more hardy than cabbage, and make excellent greens for winter and spring use, and are improved by frost. For early spring use, sow broadcast in September and protect during winter. It must also be sown in April or May for later use.

**DWARF GREEN GERMAN KALE.**—This variety sow in September broadcast, and gather in early spring, like spinach. It may also be sown early in the spring for later use. **Pkt. 5c. ¼ lb., 20c. Lb., 40c.**

**EXTRA CURLED NEW AMERICAN KALE.**—This is an extra curled, long-standing variety of a beautiful green color; stands the winter well, and will stand longer in the spring before going to seed than any other variety. **Pkt., 5c. ¼ lb., 20c. Lb., 40c.**

**NEW IMPERIAL CURLED LONG-STANDING KALE.**—**Pkt., 5c. Oz., 10c. ¼ lb., 20c. Lb., 50c.**

**NORFOLK.**—A variety used by the truckers of Norfolk for shipment North. Light green color and leaves much curled. **Pkt., 5c. Oz., 10c. ¼ lb., 25c. Lb., 90c.**

# KOHLRABI

1 OZ. OF SEED TO 100 FEET  
OF ROW.

## White Vienna

BULB LIGHT GREEN.  
FLESH WHITE.  
VERY RAPID IN GROWTH  
EARLY MATURITY.  
FINE IN TEXTURE, and  
SYMMETRICAL IN FORM.  
SUPERIOR.

**Pkts., 5c. and 10c.**  
**Oz., 20c. ¼ lb., 40c. Lb., \$1.50.**

**IMPROVED KOHLRABI.**—**Pkts., 5c. and 10c. Oz., 15c. ¼ lb., 40c. ½ lb., 75c. Lb., \$1.50.**



# LEEK

1 OZ. OF SEED TO 150 FEET OF ROW.

Select good Onion soil, manure liberally, plant in April in drills 6 to 8 inches deep, and 18 inches apart, and thin to 9 inches apart in the drill. Gradually draw the earth around the plants until the drills are filled level with the surface. Draw for use in October. To be used in soups or boiled as Asparagus.

**EXTRA LARGE MAMMOTH.**—A large and strong plant; hardy. The best variety for general culture. **Pkt., 5c. Oz., 20c. ¼ lb., 40c. Lb., \$1.50.**

**MUSSELBURGH.**—**Oz., 20c. ¼ lb., 40c. Lb., \$1.50.**

**LARGE ROUEN.**—**Pkts., 5c. and 10c. Oz., 20c. ¼ lb., 40c. Lb., \$1.50.**

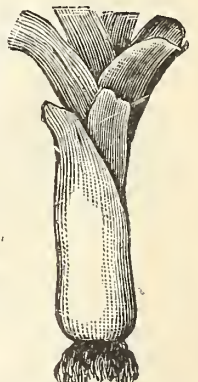

## LETTUCE

Lettuce requires rich and rather moist soil. The rows should be about 12 inches apart, and the plants thinned to 10 or 12 inches apart for the leading varieties. The more rapid the growth, the better the quality. Some varieties are peculiarly adapted for early culture, others for summer growth.

### G. & T. CO.'S WHITE SEED SUMMER LETTUCE

**The Best Summer Lettuce Ever Introduced.**—This variety, introduced by us recently, has exceeded our expectation. Those who purchased it were delighted with their crops, and came back for more seed. This Lettuce will stand the summer heat better than most sorts, and makes magnificent heads. We expect this sort to grow in favor wherever known. It has a beautiful green color; head solid; light leaves, nicely crinkled; very tender, and of most excellent flavor. **Pkt., 5c. Oz., 25c. ¼ Lb., 70c. Lb., \$2.50**

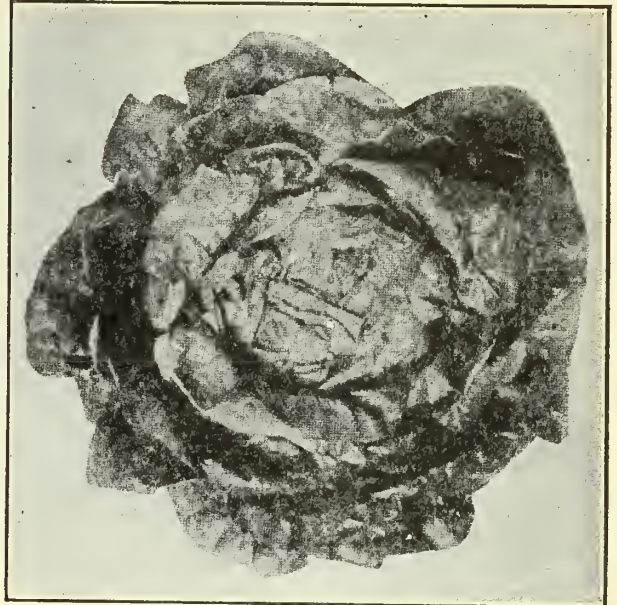

U. S. SUMMER LETTUCE

### G. & T. CO'S SUMMER LETTUCE (Black Seed.)

This Lettuce is becoming very popular among gardeners for summer use. It produces a splendid, large, solid head, of the Cabbage type, remaining a long time in prime condition without going to seed; in fact, it is often necessary for the seed growers to slit open the head in order to allow the seed stalk a chance to develop. It is of a light green color, fine quality, crisp, tender, and nearly every plant will make a fine, solid head in the hottest weather, when other varieties refuse even to grow. **Pkts., 5c. and 10c. Oz., 25c. ¼ lb., 70c. Lb., \$2.00.**

### IMPROVED NEW YORK, OR "WONDERFUL"

Plants of extra large growth, producing heads of immense size under favorable conditions. Inner portion is beautifully blanched and stands for a considerable time before running to seed. Outer leaves a deep, rich green. **Pkts., 5c. and 10c. Oz., 40c. ¼ lb., \$1.25. Lb., \$4.50.**

### CALIFORNIA CREAM BUTTER LETTUCE

This is fairly well known, and has given good results with the growers. **Pkts., 5c. and 10c. Oz., 25c. ¼ lb., 70c. Lb., \$2.00.**

### MAY KING

A very early, new variety, forming fine, hard heads within a few weeks after planting. It is medium sized, light green, with buttery but crisp heads. There is just a faint tint of brown on the head.

We have had no end of praise from our friends and customers who have tried this variety. It is essentially a spring sort, and does well all summer. Being of rapid growth and quick heading, it is especially recommended for home garden, and is universally esteemed. **Pkt., 5c. Oz., 25c. ¼ lb., 70c. Lb., \$2.00.**

### "ICEBERG" LETTUCE

The heads are large, crisp, solid and tender. **Pkts., 5c. and 10c. Oz., 25c. ¼ lb., 70c. Lb., \$2.00.**

### EARLY PRIZE HEAD (Seed White)

A large, clustering, non-heading lettuce, most excellent for the home and garden, and undoubtedly the most easily grown variety in cultivation. It is too tender, however, to stand shipping or handling on the market. The leaves are finely curled and crumpled, bright green tinged with brownish red, and are very crisp, tender and sweet. **Pkt., 5c. Oz., 25c. 2 Oz., 50c. ¼ lb., 70c. Lb., \$2.00.**

### EARLY WHITE CABBAGE, OR BUTTER

A broad-leaved, vigorous-heading sort; white; showy and desirable. **Pkt., 5c. Oz., 25c. ¼ lb., 70c. Lb., \$2.00.**

### EARLY CURLED SIMPSON

Black seed. Very early; excellent for salads; forms a compact mass of leaves: **Pkts., 5c. and 10c. Oz., 25c. ¼ Lb., 70c. Lb., \$2.00.**

### TENNIS BALL

Black seed. A favorite forcing variety; a very hard head. **Pkts., 5c. and 10c. Oz., 25c. ¼ Lb., 70c. Lb., \$2.00**

### ROMAINE OR WHITE PARIS COS

The best of the Cos or celery varieties. Forms a large, light green plant with the head well folded and quite solid. Cos lettuce is also called Romaine, and is very popular with our foreign population, for it is highly prized in England and France, while little known to our own people. **Pkt., 5c. Oz., 25c. ¼ lb., 70c. Lb., \$2.25.**

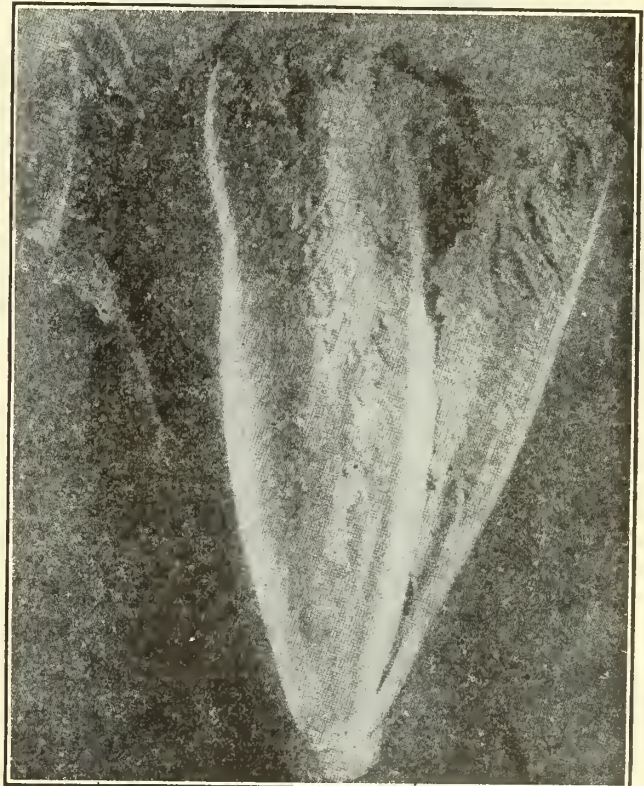

ROMAINE, OR WHITE PARIS COS LETTUCE

## LETTUCE---Continued Baltimore Cabbage Lettuce

**G. & T. CO.'S TRUE STOCK.**  
Large Heads, Beautiful Heads, Solid Heads;  
Stands Heat Well. Best of all for  
**FALL PLANTING.**

This new Lettuce, which we introduced a few years ago, and claimed to be one of the best ever put on the market, and which produced such a sensation among the large growers who tried it, still holds a high place among lettuce. As soon as the growers discovered its merits they came for more seed, and recommended it to all their friends; these, in turn, were delighted with their crops, as the result more than justified all we claimed for it. A grower at Gardenville, Md., says: "I had 3,000 heads of your Baltimore Cabbage Lettuce, and they all headed but one; they are slow to run to seed." The heads are large and solid; color pretty light green, and very slow to seed; in fact, it is just what the truckers and gardeners want. A large trucker in New Jersey writes: "The Baltimore Cabbage Lettuce I had of you was certainly very fine." **Pkts., 5c. and 10c. Oz., 25c. ¼ lb., 70c. Lb., \$2.50.**

### LARGE LEAF LETTUCE

This is so well known to truckers and gardeners around Baltimore and Norfolk that for them it scarcely needs description. For the benefit of those who are not acquainted with it, would say it makes large, compact heads, is of beautiful light green color, very tender and crisp. This is unsurpassed for frame use, and is also an excellent outdoor lettuce for fall or early spring.

**Pkt., 5c. Oz., 25c. ¼ lb., 70c. Lb., \$2.25.**



**BALTIMORE CABBAGE LETTUCE.**

### MAMMOTH BLACK-SEEDED BUTTER LETTUCE.

A strain of large, smooth-leaved, head lettuce, forming very large, solid cabbage-like heads of thick, brittle leaves, the inner ones becoming very white, tender and fine flavored.

**Pkts., 5c. and 10c. Oz., 25c. ¼ lb., 70c. Lb., \$2.00.**

### BALTIMORE OAK LEAF

This lettuce will resist the heat of summer and stand longer before running to seed than any variety we have ever known. It makes a large, solid head, and is very popular with those who know it.

**Pkts., 10c. Oz., 25c. ¼ lb., 70c. Lb., \$2.50.**

### BIG HEAD LETTUCE

The "Big Head" is certain to please market gardeners and truckers, because it always produces large, salable heads. It is very solid and crisp, of tender quality, which makes it attractive.

**Pkts., 5c. and 10c. Oz., 25c. ¼ lb., 70c. Lb., \$2.00.**

### HANSON.

A variation of the Indiana, forming a half-closed head.

**Pkts., 5c. and 10c. Oz., 25c. ¼ lb., 70c. Lb., \$2.00.**

### BOSTON MARKET

White seed. A celebrated variety in New England, of good heading habit; small, early and compact; quite desirable.

**Pkts., 5c. and 10c. Oz., 25c. ¼ lb., 70c. Lb., \$2.00.**

### GRAND RAPIDS

This variety is largely grown for shipment, and is considered by many the best loose-headed Lettuce for forcing under glass. Leaves medium size, of light, yellowish green color, much crimped and frilled, thin, but of very upright growth; crisp, tender and of good quality. Owing to its upright habit, it may be planted very closely. It is of extremely rapid growth; not very liable to rot; will stand without spoiling a week to ten days after it is fit to cut, and retains its freshness a long time after cutting.

**Pkts., 5c. and 10c. Oz., 25c. ¼ lb., 70c. Lb., \$2.00.**

### DEFIANCE.

Stands summer heat better than any other variety; one of the finest large-growing varieties. It forms very large, solid heads, so firm that they have to be cut open to allow the flower heads to come through.

**Pkts., 5c. and 10c. Oz., 25c. ¼ lb., 70c. Lb., \$2.00.**

### SALAMANDER (Black Seed).

An excellent sort for spring or summer use; forms good-sized heads of excellent quality.

**Pkts., 5c. and 10c. Oz., 25c. ¼ lb., 70c. Lb., \$2.00.**

### BIG BOSTON

The same in color, shape and general appearance as the Boston Market, double the size. A most desirable sort either for forcing in cold frames or planting in open ground. Is popular with truckers, as it makes large, solid, salable heads. Very highly recommended by those who have tried it.

**Pkts., 5c. and 10c. Oz., 25c., ¼ lb., 70c. Lb., \$2.25.**

**ALL PRICES SUBJECT TO CHANGE  
WITHOUT NOTICE**



**LARGE LOAF LETTUCE.**



**BIG BOSTON.**



## Muskmelon

NEW MARYLAND



**CULTURE.**—One ounce of seed to 50 hills. Sow about the last of spring or the first of summer in hills of light, rich, sandy soil, 4 feet apart, allowing but three plants to grow in each hill; after they have grown about a foot long, pinch off the points of shoots, which causes the vines not only to become stronger, but makes them produce lateral branches and prove more productive and mature earlier. It should not be grown near squashes, cucumbers or pumpkins, as the flavor will be affected in consequence.

**NEW MARYLAND CANTALOUPE.**—The latest acquisition to our collection of muskmelons. It is earlier, larger and cuts better than the Rocky Ford. Flesh is green, of fine flavor and heavily netted, making it the most attractive melon on the market. A sure moneymaker. Our truckers around Baltimore will have no other after planting our New Maryland. **Pkt., 5c. Oz., 15c. ¼ lb., 35c. Lb., \$1.25**

## ROCKY FORD MELON

This has become one of the most popular of small or basket melons, largely owing to the fact that growers in the Rocky Ford region pack and ship their fruit in a most attractive manner. The fruit is oval, slightly ribbed, densely covered with coarse netting. Flesh thick, green, very sweet and high-flavored.

We have an exceptionally fine stock of this variety grown from choice selected specimens. **Pkt., 5c. Oz., 15c. ¼ lb., 35c. Lb., \$1.00**

## Baltimore Nutmeg Cantaloupe

The Old Standard Variety That Has Found Favor Wherever Grown.

The stock seed of this splendid melon was secured from a trucker who enjoys the reputation for raising the finest Cantaloupes that come to the Baltimore market. The writer also tested the fruit, and found it to be of excellent flavor. It is green-fleshed, and the rind is handsomely netted. It is well known and popular with the truckers and market gardeners of Baltimore, Washington, Norfolk and other places—in fact, it is a leading sort all over the country. **Pkt., 5c. Oz., 15c. ¼ lb., 35c. Lb., \$1.00**

### IMPROVED JENNY LIND.

A small, early variety of surpassing good quality, highly recommended for family garden. We consider this the most delicious Cantaloupe we have ever eaten, and while the fruit is small, it is an abundant bearer. A market gardener having this sort for sale would in a short time have no difficulty in disposing of all he could raise. **Pkt., 5c. Oz., 15c. ¼ lb., 35c. Lb., \$1.00**

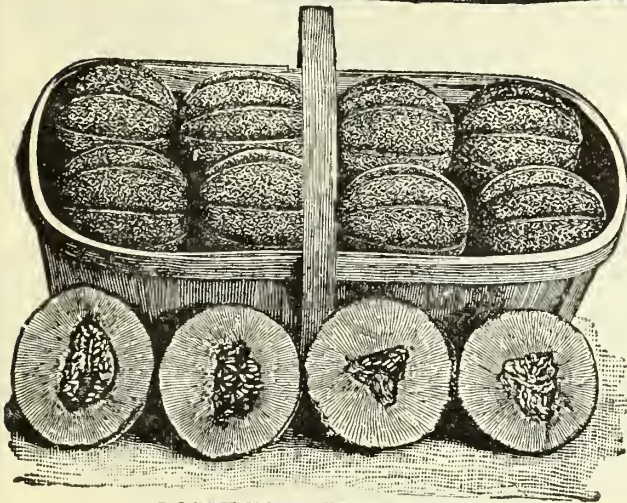

ROCKY FORD CANTALOUPE.

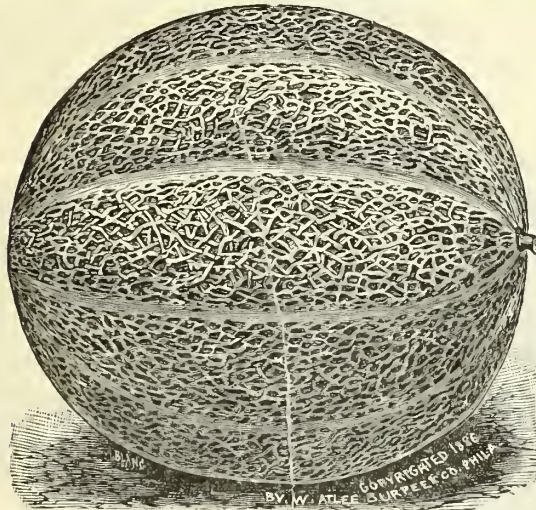

BALTIMORE NUTMEG.



### EARLY NETTED GEM.

EXTENSIVELY grown, and many prefer it to all others for table use. Grows remarkably uniform; thick meated; flesh light green in color, and of fine, luscious flavor; skin green, regularly ribbed and thickly netted; very productive and extra early in ripening; will keep for nearly a week after picking, and is especially suited for shipping in baskets or crates. **Pkts., 5c. and 15c. ¼ lb., 35c. Lb., \$1.00**

### EMERALD GEM.

Meat, salmon color, exceedingly sweet and delicious; very early and prolific. One of the best for family use. Its appearance is not attractive, but try it, and you will want it again. **Pkt., 5c. Oz., 15c. ¼ lb., 35c. Lb., \$1.00**

### OSAGE, OR MILLER'S CREAM.

Most delicious. The flesh is a rich salmon color, very thick, sweet and rich; rind very thin and finely netted. **Pkt., 5c. Oz., 15c. ¼ lb., 35c. Lb., \$1.00**

## MUSKMELONS--CONTINUED

### KNIGHT CANTALOUPE

**A NEW EARLY CANTALOUPE OF SUPERB QUALITY AND AT THE SAME TIME MAKES AN EXCELLENT MARKET OR SHIPPING MELON**

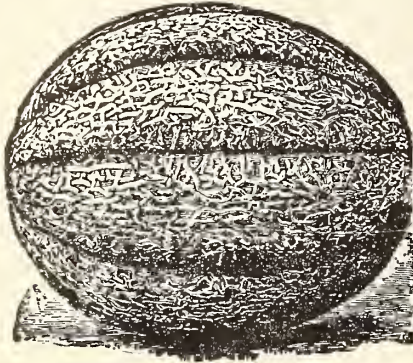

KNIGHT CANTALOUPE

This new Cantaloupe has been grown in Anne Arundel county for the past several years, and has created a furore with our truckers, on account of its earliness, productiveness, uniformity in shape and appearance and its fine table qualities. It matures about a week earlier than the regular Rocky Ford, is larger in size and makes a most attractive and salable melon. It has thick, green flesh, shading to orange at the center. The fruits are oblong in shape, well ribbed and well netted. It is a leader, both for planting for home use and market and for shipping. Its early maturity, together with its fine qualities, are strong points in its favor. **Pkt., 5c. Oz., 15c. ¼ Lb., 35c. Lb., \$1.25**

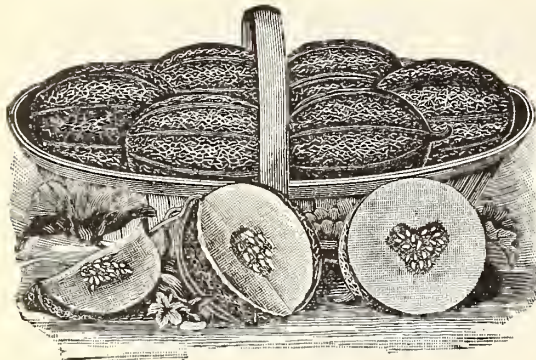

PAUL ROSE

**PAUL ROSE.**—In this new sort are combined all the good qualities of the Netted Gem and the Osage, the varieties from which it originated. The fruit is oval, about 5 inches in diameter, and in shape and general appearance similar to the well-known Netted Gem or Rocky Ford. The firm flesh is a rich orange-red color, like that of the Osage, but even sweeter and higher flavored, retaining its good qualities quite to the rind. We think it really has no equal as a market melon for professional melon-growers, and it is one of the very best sorts for the home garden. **Pkt., 5c. Oz., 15c. ¼ Lb., 35c. Lb., \$1.00**

### ANNE ARUNDEL CANTALOUPE

(Original Stock.)

This handsome melon, introduced by us several years ago, was for years a special favorite with a number of the leading growers of Anne Arundel county, Maryland. This county is justly celebrated as growing the finest Cantaloupes in the country. We might almost say the finest in the world. Knowing its value, we selected the stock and placed it before our customers. It has met every promise we made for it upon its introduction. **Pkt., 5c. Oz., 15c. ¼ Lb., 35c. Lb., \$1.00**

### EDEN GEM OR NETTED ROCK

One of the handsomest melons in our list. Splendid shape and thorough netting and absence of deep spaces between the ribs, indicating strong shipping properties. The flesh is unusually thick, the seed cavity very small, the flavor exquisite. A heavy yielder, the melons very uniform, but few run too large, and still fewer too small. For shipping we recommend it highly; also for home growers. **Pkt., 5c. Oz., 15c. ¼ Lb., 35c. Lb., \$1.00**

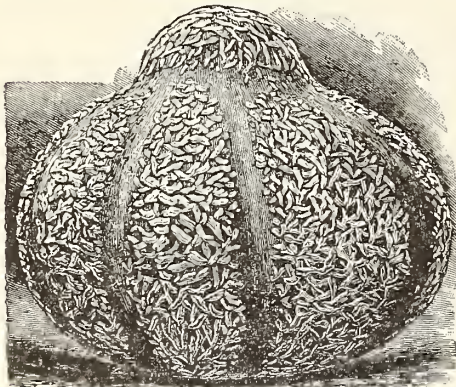

### NORFOLK BUTTON

An improved strain of Early Jenny Lind, having a nub or button on the blossom end, which gives it a distinction over all other varieties. It is very early, of remarkably fine texture and delicious flavor, and produces fruits of the finest quality. It is extra fine for both home and market use. We are putting the above on the market for the first time, and have but a limited supply of seed. Those who wish to secure a trial order will do well by placing their order at once. **Pkts., 5c. and 15c. ¼ Lb., 35c. Lb., \$1.00**

#### EXTRA EARLY HACKENSACK

Netted green flesh and excellent; very showy market variety and an excellent keeper. Ten days earlier than the Old Hackensack. **Pkt., 5c. Oz., 15c. ¼ Lb., 35c. Lb., \$1.00**

**LONG ISLAND BEAUTY**—Pkt., 5c. Oz., 15c. ¼ Lb., 35c.

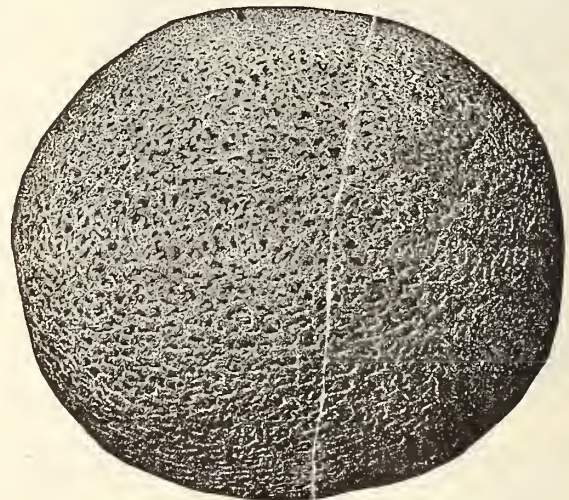

Netted Rock or Eden Gem Cantaloupe.

# WATERMELONS

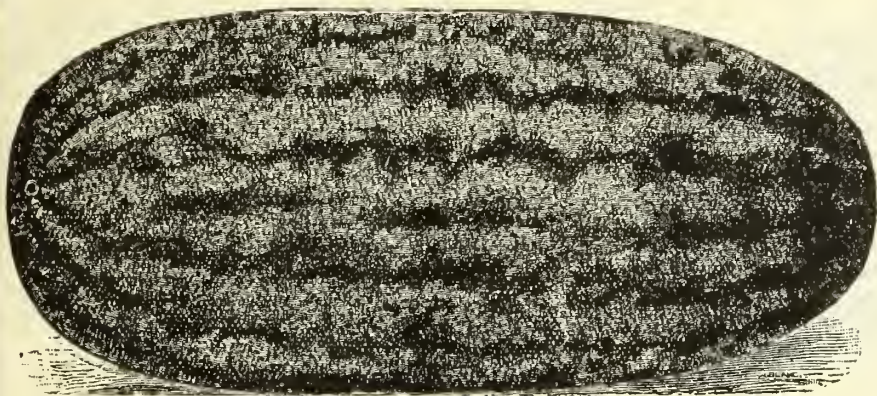

LORD BALTIMORE

**CULTURE.**—One ounce of seed to 30 hills. Watermelons require a rich, sandy soil for best development. Cultivate the same as for cantaloupes, except that the hills should be eight or ten feet apart.

## Lord Baltimore

It is very early, of oblong shape, and the flesh is of handsome crimson color, deliciously sweet and extending close up to the rind. It has a thin, hard rind, beautifully mottled light and dark green. Its perfect shape, faultless color, fine texture and excellent flavor combine to make it one of the very best melons that grow. It is a good snipper and beats all others as a seller.

Pkt., 5c. Oz., 10c.  $\frac{1}{4}$  Lb., 25c. Lb., 75c.

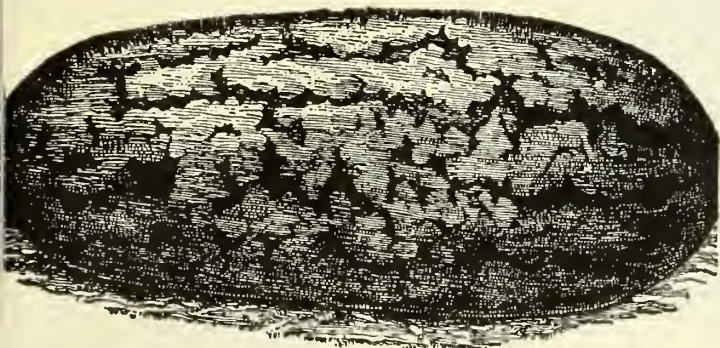

FLORIDA FAVORITE

## Florida Favorite

This we consider one of the richest and sweetest flavored melons grown, of medium size and prolific. The best of all for family garden. It is now very popular with the truckers and melon-growers of Maryland and Virginia, and sells readily in the Baltimore markets.

Pkt., 5c. Oz., 10c.  $\frac{1}{4}$  Lb., 20c. Lb., 60c.

## McIVER'S SUGAR WATERMELON

In outward appearance it somewhat resembles the old Rattle-snake. The quality is much superior. It is an extremely productive and hardy variety.

Pkt., 5c. Oz., 10c.  $\frac{1}{4}$  Lb., 20c. Lb., 60c.

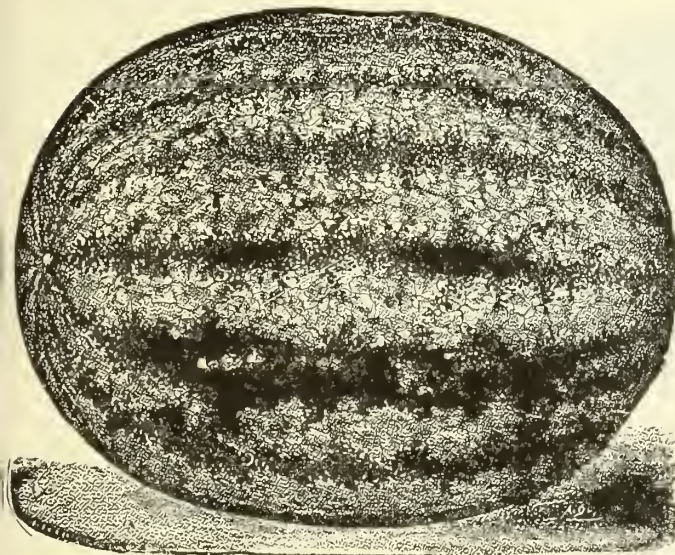

DUKE JONES

## Dark Icing

An extra early and extra good melon for home use and nearby market. One of the most delicious of melons; rich red and sugary to the very thin rind.

Pkt., 5c. Oz., 10c.  $\frac{1}{4}$  Lb., 20c. Lb., 60c.

## GRAY MONARCH OR LONG WHITE ICING

This distinct melon is without a doubt one of the largest of all, frequently attaining a weight of 70 pounds and over. The skin is a mottled gray color, shape long, flesh bright crimson, and of sweet, delicious flavor. It is also a fine shipper, carrying well long distances and bringing very high prices.

Pkt., 5c. Oz., 10c.  $\frac{1}{4}$  Lb., 25c. Lb., 60c.

## Duke Jones Watermelon

In shape the DUKE JONES resembles very closely the Kolb Gem. The rind is darker green in color, with indistinct irregular stripes of dark and light green alternating; in general appearance it is a dark green melon. It averages very large in size, comparatively no small melons; is very productive; it is also very early in maturing.

Pkt., 5c. Oz., 10c.  $\frac{1}{4}$  Lb., 20c. Lb., 60c.

## WATERMELONS--CONTINUED

### TOM WATSON (New)

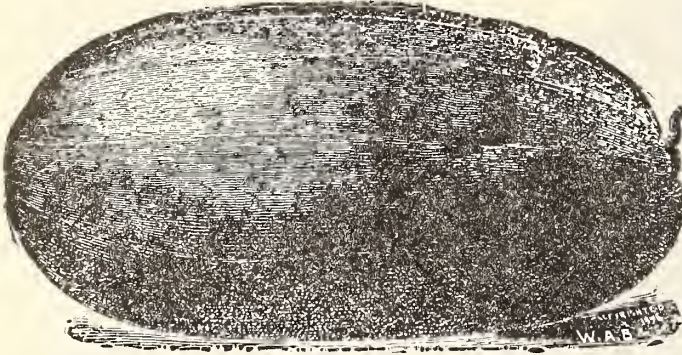

**TOM WATSON**

A recent introduction. A large oblong melon, dark green skin, with thin, tough rind, which gives it excellent shipping qualities. Melons are produced from 18 to 24 inches long and from 8 to 12 inches in diameter. Flesh, deep red, crisp, melting and of the finest flavor. Heart large, with little or no core. One of the best eating melons known.

**Pkts., 5c. and 10c. ¼ Lb., 20c. Lb., 60c.**

#### RATTLESNAKE WATERMELON.

Large, oblong, striped and mottled; flesh bright red; a good shipper, a favorite variety in the South.

**Pkts., 5c. and 10c. ¼ Lb., 20c. Lb., 60c.**

#### DIXIE.

It is earlier and larger than the well-known and popular Kolb Gem, and in color a darker green, with beautiful stripes, making it one of the handsomest melons on the market. Flesh deep red, sugary and melting.

**Pkt., 5c. Oz., 10c. ¼ Lb., 20c. Lb., 60c.**

#### SWEETHEART.

An entirely distinct and handsome new Watermelon. Vine vigorous and productive, ripening early. Fruit, large, oval, very heavy, uniformly mottled light and dark green. Flesh bright red, solid and very sweet.

**Pkt., 5c. Oz., 10c. ¼ Lb., 20c. Lb., 60c.**

#### KLECKLEY'S SWEETS.

Skin dark green, thin rind, flesh scarlet, very solid, firm and most luscious quality for the home market or family garden. It is decidedly one of the best.

**Pkt., 5c. Oz., 10c. ¼ Lb., 30c. Lb., 60c.**

**EXCEL.**—Many growers claim that for shipping it is even better than Tom Watson. In appearance it strongly resembles the Watson, has a very thin, tough rind, is uniformly large, averaging from 40 to 60 pounds. On the table it is as attractive as any melon can be, and its quality is fully equal to its attractiveness. It is an unusual melon in that although a grand shipper it is also one that we can highly recommend for the private garden, the beautiful red meat being decidedly crisp, sweet and luscious, and solid to the center. Seeds are both black and white.

**Pkt., 5c. Oz., 10c. ¼ Lb., 20c. Lb., 60c.**

**KOLB'S GEM.**—This is one of the largest, most productive, best keeping and best shipping watermelons grown. Sells readily at the highest market prices. In fact it is so well known that it speaks for itself. Our stock of this comes direct from the original grower. Special prices on large quantities.

**Pkt., 5c. Oz., 10c. ¼ Lb., 20c. Lb., 60c.**

**CITRON**—For Preserves. Fruit round and handsome. Used in making preserves only.

**Pkts., 5c. and 10c. ¼ Lb., 35c. Lb., 90c.**

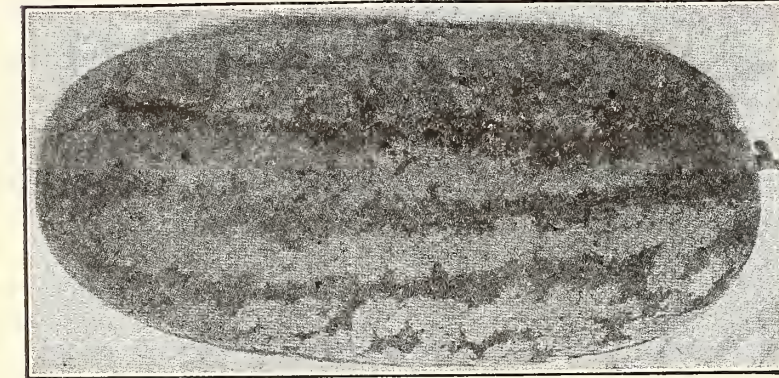

**GEORGIA RATTLESNAKE**

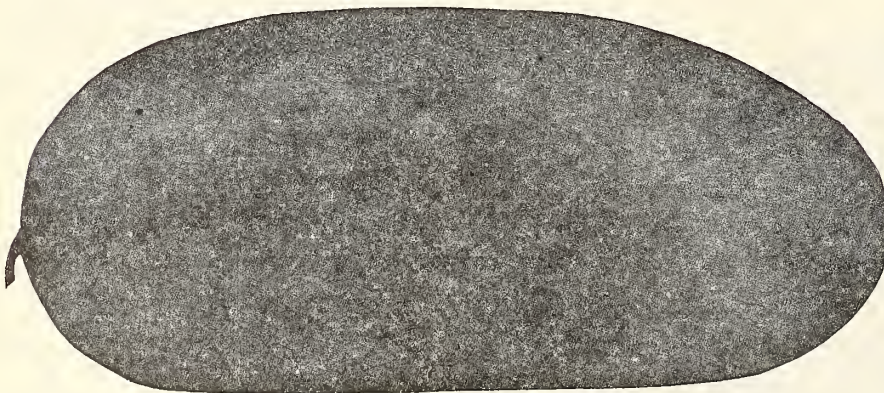

**NEW WATERMELON—"IRISH GREY."**

## IRISH GREY

The newest and best in watermelons, recently introduced. Considered by the best growers and shippers to excel all other varieties. Fine flavor, red to rind, dark tough skin long keeper and excellent shipper.

**Pkt., 5c. Oz., 10c. ¼ Lb., 25c. Lb., 75c.**

## ENGLISH MILL TRACK MUSHROOM SPAWN

Lb., 25c. By Mail, 30c. Lb., Postpaid. 10 Lbs., \$2.50. 100 Lbs., \$20.00, by Freight or Express.

### CULTIVATION

The cultivation of the Mushroom is a very simple matter and requires only ordinary intelligence and care. The materials needed are fresh horse manure, good soil and live spawn. The manure should not be too short, as it does not combine the necessary qualities. Long strawy litter, plentifully mixed with short manure, makes by far the best beds, as it does not heat too violently, decomposes slowly and retains its heat for a long period. Put in a heap and turn every three or four days to permit the escape of noxious gases and prevent burning. When ready for use it should be as hot as can be borne comfortably by the hand, and should also be moist. Make the beds 3 feet wide at the base, 2½ feet high, and of any desired length. The manure, when in proper condition, should be quickly handled to prevent the loss of heat, and be beaten down to make the heap firm and compact, and covered with long litter. The bed should within a few days warm to a temperature of 110 to 120 degrees. Never spawn a bed when the heat is rising, but always on the decline and under 90 degrees. Have a ground thermometer, and keep it plunged in the bed; by pulling it out and looking at it you can ascertain exactly the temperature of the bed. Should the temperature not exceed 100 or 110 degrees, no alarm should be felt, for if the manure was fresh it will likely produce a good crop. When the heat has decreased to 90 degrees, the bed is ready to receive the spawn, which is done by raising the manure with the hand and inserting pieces of spawn 2 inches square and 9 inches apart each way. At the expiration of a few days the bed may be covered with soil to the depth of about 2 inches. If in a closed cellar or mushroom house, wait about ten days, but if in open shed five days will do. If the soil is poor, add a liberal quantity of bone meal. It requires a period of 5 to 7 weeks before they are ready for use.

Two pounds of spawn are sufficient for a bed 3 feet by 6 feet.

Mushrooms can be readily grown in cellars, stables, sheds or pits. Many are successively grown on a shelf in an ordinary cellar, and yield sufficient crops to compensate the grower for his effort. The space under greenhouse benches or stagings will suit them exactly, using materials in the same manner as described.

### MUSHROOMS ON PASTURE LAND OR LAWN.

About the first of June take pieces of spawn an inch square and lift the sod with a trowel or spade just sufficient to get a spawn under it, and then press the soil down hard. Set the spawn 1 to 2 feet apart. In a favorable season a crop may be expected in 3 or 4 months from the time of planting.

## OKRA, or GUMBO



Select warm location and rich soil, and plant when the ground becomes warm, in rows three feet apart, thinning plants a foot apart in the row. As the seeds are liable to rot in cool weather, they should be sown thickly. The pods are used to thicken soup, being gathered when young. It is one of the most wholesome vegetables in use.

### DWARF OKRA.

This is the preferred kind with the growers; is of dwarf habit and very productive. Pkt., 5c. Oz., 10c. ¼ Lb., 20c. Lb., 60c.

### WHITE VELVET.

It is very distinct, and the pods are perfectly round and smooth, of an attractive white velvet appearance, and of superior flavor and tenderness. The pods are of extra large size, and produced in great abundance.

Pkt., 5c. Oz., 10c. ¼ Lb., 20c. Lb., 60c.

## ONION SETS

### CULTIVATION FOR SETS.

Have a clean and very rich soil, which should be thoroughly cultivated, or it will not do well enough to pay for the trouble. The most successful growers work their ground several times in the fall to kill out the weeds and get ground in nice condition. Use well-rotted manure freely, and be sure to get the seeds in as early as possible in the spring, no matter if it is ever so cold or unpleasant, and keep the soil mellow and clear of weeds, and if seed is good you will have a large crop of onion sets. On no other condition can you hope for success. Disturb the roots of the onion as little as possible, either in thinning or hoeing, and never hoe earth toward them to cover or hill, as we do most other things.

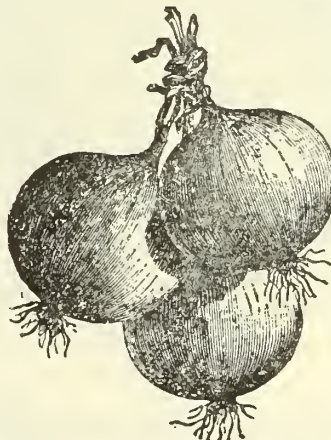

Sow the seed in drills about 12 inches apart. It will require from 40 to 60 pounds of seed to sow an acre.

**WHITE**—Qt., 30c.; mailed, 35c. **YELLOW**—Qt., 25c.; mailed 30c. Ask for prices on sets by the bushel. It requires 10 to 15-bushel sets to plant one acre.

## VEGETABLE ROOTS

### ASPARAGUS ROOTS.

A saving of one to two years is effected by planting roots. A bed 12x40 feet, requiring about 100 roots, should give a sufficient supply for an ordinary family; 7,260 roots will plant an acre. Select good, loamy soil, plow deep, put in good quantity of manure and 100 pounds of kainit to 1,000 square feet of bed. Incorporate thoroughly, make a trench 8 inches deep, set plants 9 inches apart. In field culture rows are placed 4 feet apart.

**Barr's Mammoth**—Per 100, \$1.25. Per 1,000, \$9.50.

**Palmetto**—Per 100, \$1.25. Per 1,000, \$9.50.

**Colossal**—Per 100, \$1.25. Per 1,000, \$9.50.

### HORSE RADISH ROOTS.

The land should be rich, well manured, plowed deeply, harrowed and free from lumps. Plant in a roomy space by itself. Make rows 15 inches apart, set plants 12 inches from each other. Plant shoots about five inches long, making holes for same with a stick, and set them about two inches under the soil. Have the shoots cut squarely across the bottom, but cut slanting at the top, in order that one side may be a little longer than the other. Keep free from weeds for the first and second seasons, after which the Horse Radish will take care of itself. Dozen, 20c. By Mail, 25c. Per 100, \$1.00. By Mail, \$1.25. Per 1,000, \$8.00. By Express, not Prepaid.

### RHUBARB, OR PIE-PLANT.

This very desirable vegetable comes early in the spring. The large stems of the leaves are used for pie-making and stewing. A deep, rich soil is indispensable to secure large, heavy stalks. Plant in rows 4 feet apart, with the plants 3 feet distant. Set so that the crowns are about an inch below the surface. Top-dress annually in the fall with stable manure, and fork under in the spring. 20c. Each. By Mail, 25c. Dozen, \$2.00. By Express, not Prepaid.

ALL PRICES SUBJECT TO CHANGE WITHOUT NOTICE.

# ONION SEED

**CULTIVATION TO GROW LARGE ONIONS FROM SEED.**—The seed should be sown as early as possible in the spring, as they grow much better during the cool weather, and should make most of their growth before the hot weather sets in. Sow 5 pounds of seed to the acre for large onions.

**THE NEW ONION CULTURE.**—Sow the seed in hotbed and transplant early as possible to open ground. They can be grown very successfully by this plan.



WHITE S. S. ONION.

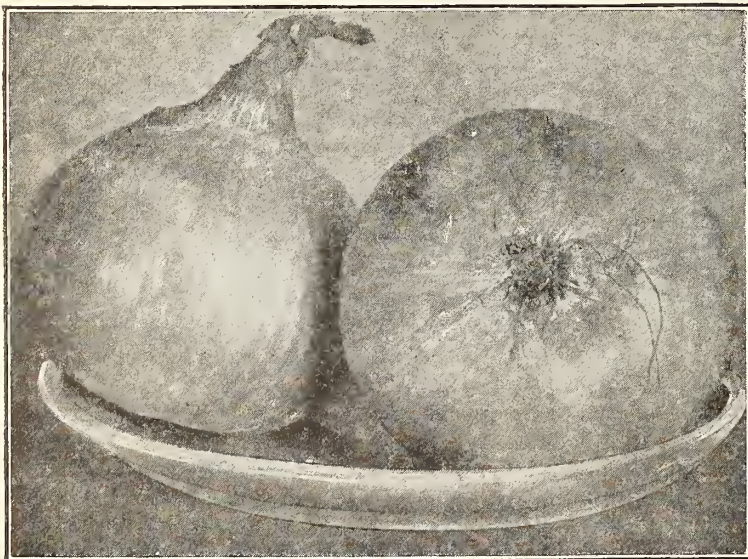

YELLOW DANVERS ONION.

**WHITE SILVERSKIN, or PORTUGAL.**—A good variety for family use, skin and flesh pure white, mild flavor and flat shape. The best white onion to grow largely for sets. Pkts., 5c. and 10c. Oz., 20c.  $\frac{1}{4}$  Lb., 75c. Lb., \$2.50

**WHITE PEARL ONION.**—Earliest of all, growing with all the rapidity of a summer radish. Pearly white, waxy and transparent. Form flat and broad, flavor very mild, and it can be eaten raw almost like an apple. On rich soil it will grow very large. This is an elegant sort to sow for large onions, because of its rapid growth and fine quality. Pkt., 5c. Oz., 20c.  $\frac{1}{4}$  Lb., 75c. Lb., \$2.50.

**AUSTRALIAN BROWN**—A Valuable Long-Keeping Onion.—This new Onion, introduced into the United States a few years since, has met with wonderful success, and is pronounced the best keeper of all onions. The outside skin is of a deep amber brown, distinct from all other onions, extremely hard and firm, of fine flavor, and will keep almost indefinitely. Australian Brown is the only onion Australian growers will plant. Pkts., 5c. and 10c. Oz., 20c.  $\frac{1}{4}$  Lb., 60c. Lb., \$2.00.

**WETHERSFIELD LARGE RED.**—Well-known and favorite sort. A large yielder and good keeper. Pkt., 5c. Oz., 20c.  $\frac{1}{4}$  Lb., 45c. Lb., \$1.75.

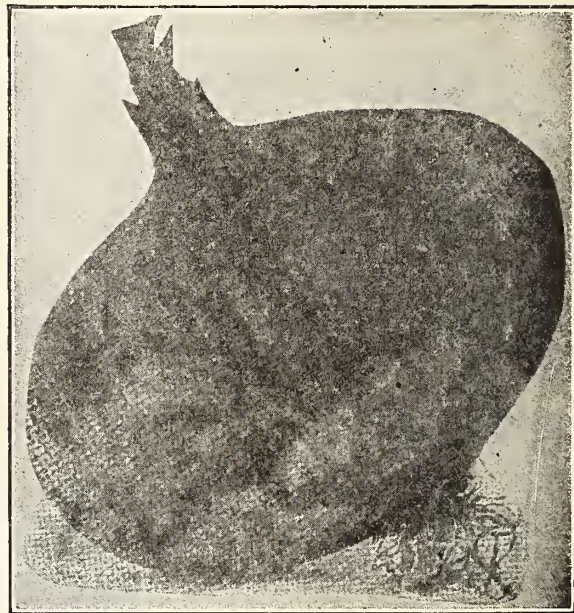

YELLOW DUTCH, or STRASBURG.

**YELLOW DUTCH, or STRASBURG.**—The most popular and best variety for set purposes. Is similar to the Yellow Danvers. Flat in shape, color and size, but as a set onion it has the quality of ripening down earlier and more uniformly. Pkt., 5c. Oz., 20c.  $\frac{1}{4}$  Lb., 50c. Lb., \$1.50

**YELLOW GLOBE DANVERS.**—A very handsome, round, yellow onion; a large yielder and splendid keeper; the preferred sort with market gardeners and large growers all over the country. We unhesitatingly recommend it for growing either sets or large onions. Pkt., 5c. Oz., 20c.  $\frac{1}{4}$  Lb., 50c. Lb., \$1.60

**YELLOW FLAT DANVERS.**—A good onion, both for the home garden and for market—combining reliability in ripening with large yield. It ripens more surely in moist locations than do the globe-shaped varieties, as well as earlier. The thin-necked flattened bulbs are quite thick through; light yellow skin; fine-grained, mild, white flesh. Pkt., 5c. Oz., 20c.  $\frac{1}{4}$  Lb., 50c. Lb., \$1.75.

## ONIONS--CONTINUED

**PRIZE-TAKER.**—This is the large, beautiful onion that is seen every fall offered for sale at the fruit stores in Baltimore and other large cities. It has a rich straw color, and is of enormous size. Although of such large size, it is very hardy and an excellent keeper. The flavor is mild and delicate, making the Prize-taker a favorite variety for salads. By sowing this sort early you can raise a large crop of large onions the first season with very little trouble. All that is necessary is good ground, proper cultivation, and not to have them too thick. Those of our growers who have tried this variety have had remarkably fine success. **Pkt., 5c. Oz., 20c. ¼ Lb., 60c. Lb., \$2.00.**

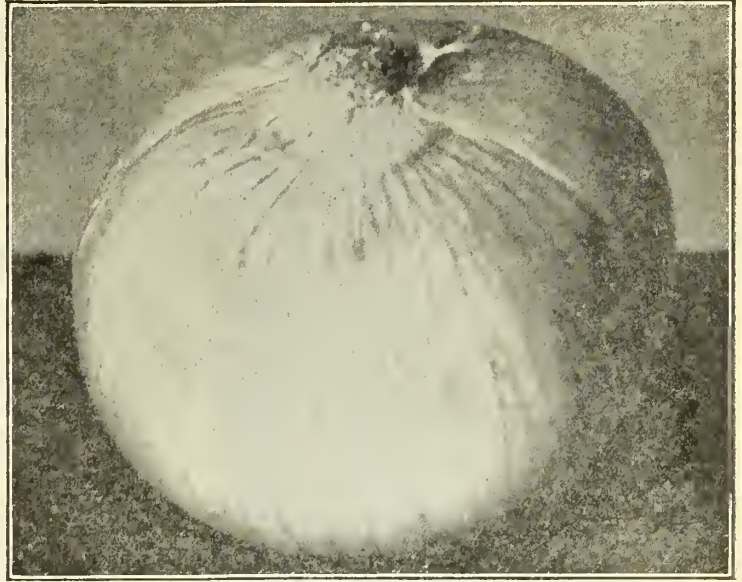

PRIZE-TAKER ONION.

## PARSNIP

The Parsnip will nourish best and give the longest, largest and smoothest roots in a very deep, rich soil—one that has been made rich from manure the previous year. Fresh manure makes the roots somewhat ill-shaped. Sow as early in the spring as the ground can be made ready, pretty thickly in drills from 12 to 18 inches apart, and about an inch deep. Thin the plants to five or six inches apart.



HOLLOW CROWN OR SUGAR

The Hollow Crown is superior in quality to all other varieties, and the preferred kind with Baltimore gardeners. The roots are smooth, tender, handsome shape and early. We have the finest stock of Hollow Crown Parsnips that we know of in this country. **Pkts., 5c. and 10c. ¼ Lb., 25c. ½ Lb., 40c. Lb., 90c.**

## MUSTARD

**GIANT CURLED.**—Highly esteemed in the South, where the seed is sown in the fall and used in the spring as a salad. Our stock is the true curled leaf, and produces plants two feet high and of greater breadth, forming enormous bunches.

**WHITE MUSTARD.**—**Pkt., 5c. Oz., 10c. ¼ Lb., 30c. Lb., \$1.00**  
**¼ Lb., 25c. Lb., 75c.**



## NASTURTIUM

Plant in May, the climbing varieties to cover arbor or fence, and the dwarf for beds or hanging baskets. The leaves are used for salad, and the seeds, when soft enough to be penetrated by the nail, for pickles.

**TALL.**—**Pkt., 5c. Oz., 10c. ¼ Lb., 20c. Lb., 60c.**

**DWARF.**—**Pkt., 5c. Oz., 10c. ¼ Lb., 25c. Lb., 75c.**

## PARSLEY

**SELECT** rich soil; sow the seed in drills one foot apart, covering half an inch deep. It would be well to firm the soil with the foot after sowing the seed. As the seed is usually from 15 to 25 days in germinating, it will be necessary to sow early. Thin plants to 4 inches apart when 2 inches high. The beauty of the plant may be increased by several successive transplantings. It is used principally for flavoring soups, etc., and for garnishing in its natural state.

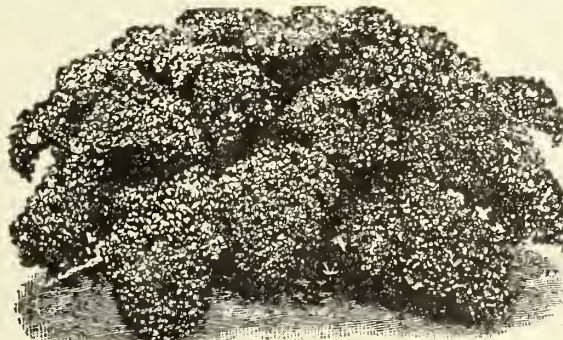

**DWARF EXTRA CURLED.**—The most beautiful and valuable variety in use; handsome bright green color; finely crimped, beautifully curled.

**Pkt., 5c. Oz., 10c. ¼ Lb., 20c. Lb., 75c.**

**MOSS CURLED.**—A very select crimped variety.

**Pkt., 5c. Oz., 10c. ¼ Lb., 20c. Lb., 75c.**

## P E A S

The dwarf varieties should be liberally manured; the tall sorts will run too much to vine if heavily manured, it being better to depend on the richness of the land that was previously in good condition. Plant the dwarf in rows two feet apart; those varieties attaining a height of from two to three feet in rows three feet apart, and the rows of the tallest sort four feet apart. Bushing the tall kind when six inches high, on poles set every six or eight feet, with twine fastened to them about four inches apart, will answer finely.

### G. & T. Co.'s First Early Peas

This is the earliest of all and the most profitable early market Pea, because of its early maturity, uniformity of growth, and ripening and its productiveness. It ripens up so evenly as only to require about two pickings to secure the crop. It is grown from selected stock, under our own supervision, and the greatest care is exercised to keep it up to the highest standard of quality. It is a great favorite with the truckers, and is largely used by private families. Our sales of this sort increase annually.

**Pint, 20c. Quart, 40c. Peck, \$2.50. Bushel, \$9.00.**

**NEW LARGE PODED ALASKA.**—In general habit and growth resembles the well-known Alaska. Ripening about three days later, but with much longer and thicker pods. Handsomely shaped, of a beautiful dark green color, which is retained long after other varieties have lost their usefulness. The seed is somewhat wrinkled and dented. We strongly recommend this new Pea to gardeners, truckers and shippers as a most productive and large extra early variety.

**Pint, 20c. Quart, 40c. Peck, \$2.50. Bushel, \$9.00.**

**ALASKA.**—Our best rogued and hand-picked stock. Height, 26 inches. The earliest Blue Pea; very uniform in growth and time of ripening. The dark green color of pods makes this a most desirable sort for canners and shippers, as it can be carried long distances without losing color.

**Pint, 20c. Quart, 40c. Peck, \$2.50. Bushel, \$10.00.**

### Early Bird Peas

Recently introduced. Hardy, prolific, early. Earlier than Alaska or First and Best. Large podded and very prolific. Fine luscious flavor. Hardiness unsurpassed.

**Pint, 25c. Quart 50c. Peck, \$3.00. Bushel, \$11.00.**

**FIRST AND BEST.**—Height, 2½ feet. Grown with special care. One of the earliest varieties.

**Pint, 20c. Quart, 40c. Peck, \$2.50. Bushel, \$9.00.**

**BOUNTIFUL.**—Ripening about three to four days later than extra early sorts. Much longer and thicker pods. Beautifully shaped, dark green color which is retained after earlier varieties have turned grey. Seed dented, and we recommend this pea to all market gardeners and truckers.

**Pint, 20c. Quart, 40c. Peck, \$2.50. Bushel, \$9.00.**

**PEDIGREE EXTRA EARLY.**—Introduced several years ago, has steadily increased in favor until now the truckers all want it. Early as Alaska, large pods, white seeded, very prolific. All mature at one time and can be gathered in one picking.

**Pint, 20c. Quart, 40c. Peck, \$2.50. Bushel, \$9.00.**

### Prolific Early Market

New. Recently introduced. The finest, largest and most prolific extra early variety. Larger than Alaska, nearly as early, quite as prolific. Handsome pods, which command the highest prices. Just the pea for the trucker, market gardener and family garden.

**Pint, 20c. Quart, 40c. Peck, \$2.50. Bushel, \$9.00.**

### Large Podded Extra Early Sugar Variety

#### MARYLAND PRIDE PEAS.

Introduced by us last season for the first time, giving universal satisfaction to the market gardeners and shippers. Pods large, of a deep green color and nearly as early as Alaska.

**Pint, 20c. Quart, 40c. Peck, \$3.00. Bushel, \$11.00.**

#### THOMAS LAXTON.

Habit and growth same as **GRADUS**, but pods are a deeper green color, square at the ends, having fine flavor.

**Pint, 20c. Quart, 40c. Peck, \$2.75. Bushel, \$11.00.**

#### GRADUS, OR PROSPERITY—Pale Green Wrinkled.

The most attractive novelty of recent years. Large, handsome pods, well filled, ripening with the earliest and of vigorous habit.

**Pint, 20c. Quart, 40c. Peck, \$3.00. Bushel, \$11.00.**

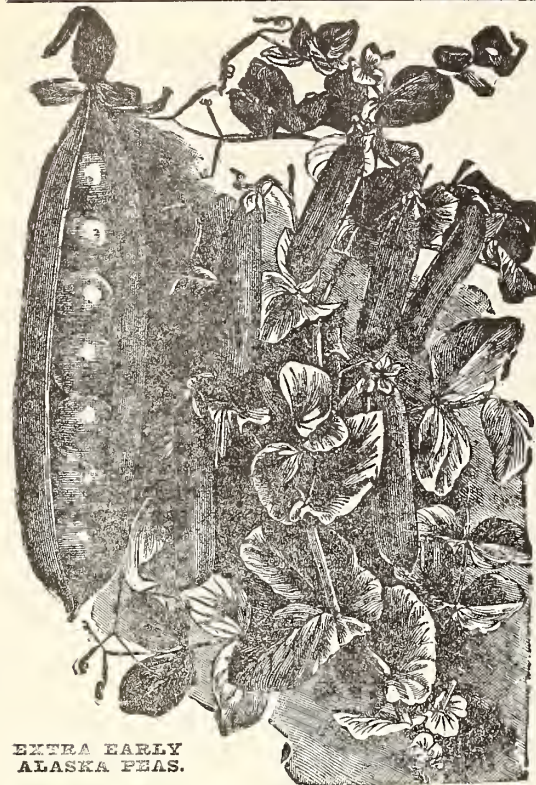

**EXTRA EARLY  
ALASKA PEAS.**

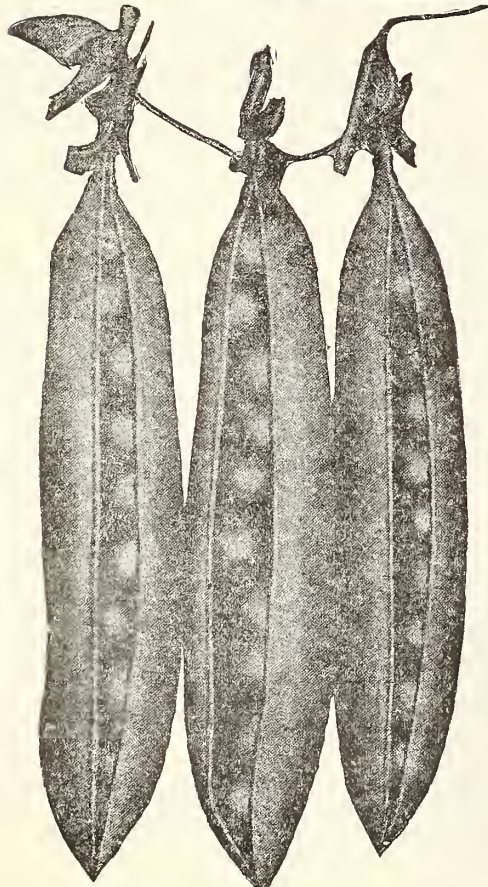

**MARYLAND PRIDE PEAS.**



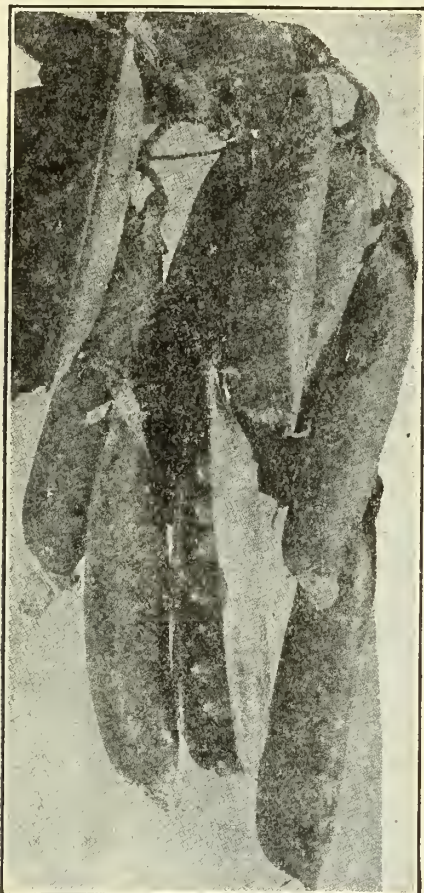

**NOTT'S EXCELSIOR.**

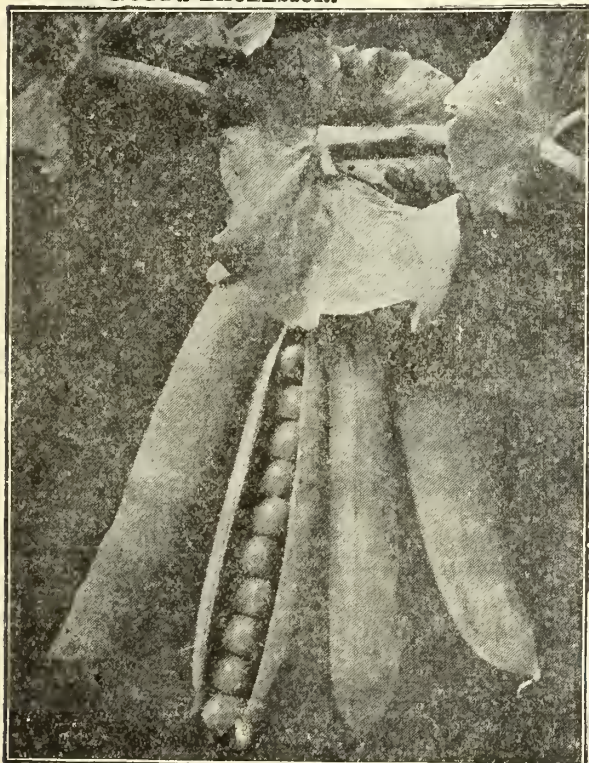

**GARDENER'S FAVORITE.**

## PEAS—CONTINUED

**NOTICE.**—In ordering Peas to be sent by mail, please add 6c. per pound to pay postage.

### DWARF EXTRA EARLY VARIETIES

#### Nott's Excelsior

It is the best of dwarf wrinkled extra early of recent introduction. The vines are larger and more vigorous than the American Wonder, while the pods are fully one-third larger, containing 6 to 8 fine, large Peas, packed so closely together in the pods that the Peas are always more square than round. The pods are always well filled with Peas, which in sweetness and quality have no superior.

Pint, 20c. Quart, 40c. Peck, \$2.75. Bushel, \$10.00.

#### AMERICAN WONDER

Very luscious in flavor. Try it. Height, 12 inches. The earliest wrinkled Pea; very productive and sweet. Better suited to the private than to the market garden.

Pint, 20c. Quart, 40c. Peck, \$2.75. Bushel, \$10.00.

#### PREMIUM GEM

Height, 15 inches. An improvement upon the Little Gem. A splendid wrinkled dwarf Pea; very luscious in flavor.

Pint, 20c. Quart, 40c. Peck, \$2.75. Bushel, \$10.00.

#### McLEAN'S LITTLE GEM

Similar to Premium Gem, but more straggling in growth; pods not so well filled; height, 18 inches; seed, green, wrinkled.

Pint, 20c. Quart, 40c. Peck, \$2.75. Bushel, \$10.00.

### SECOND EARLY HALF DWARF WRINKLED VARIETIES

#### GARDENER'S FAVORITE.

Height, 30 to 36 inches. A wrinkled variety named and introduced by us, and which is constantly gaining friends; of most delicious flavor; prolific bearer. specially suited for the market garden trade. It is also attracting considerable attention with some of our leading canners, as when packed they find the quality to be superior to any other sort.

Pint, 20c. Quart, 40c. Peck, \$2.75. Bushel, \$10.00.

#### ADVANCER.

Height, 2½ feet. A green wrinkled variety; introduced some years ago, and has always given satisfaction.

Pint, 20c. Quart, 40c. Peck, \$2.75. Bushel, \$10.00.

#### EVERBEARING.

Vines are about 2 feet high, of a branching character, forming as many as 10 stalks from a single root stalk. Peas large and of fine quality.

Pint, 20c. Quart, 40c. Peck, \$2.75. Bushel, \$10.00.

#### ABUNDANCE.

Height, 30 to 36 inches. An excellent half-dwarf, medium early wrinkled variety; pods 3½ inches long, containing 6 to 8 large Peas of excellent quality.

Pint, 20c. Quart, 40c. Peck, \$2.75. Bushel, \$10.00.

#### HORSFORD'S MARKET GARDEN.

Height, 2½ feet. A medium early wrinkled variety; highly recommended.

Pint, 20c. Quart, 40c. Peck, \$2.75. Bushel, \$10.00.

#### LAXTONIAN

A fine large mammoth-podded wrinkled pea. Vine is dwarf and is fine for home garden.

Pint, 25c. Quart, 50c. Peck, \$3.75. Bushel, \$15.00.

#### DWARF GREEN WRINKLED MARROW

An excellent new wrinkled variety. Large pods and very productive.

Pint, 25c. Quart, 50c. Peck, \$3.00. Bushel, \$12.00.

ALL PRICES IN CATALOG SUBJECT TO CHANGE WITHOUT NOTICE.

# PEAS—CONTINUED

## MEDIUM AND LATE VARIETIES

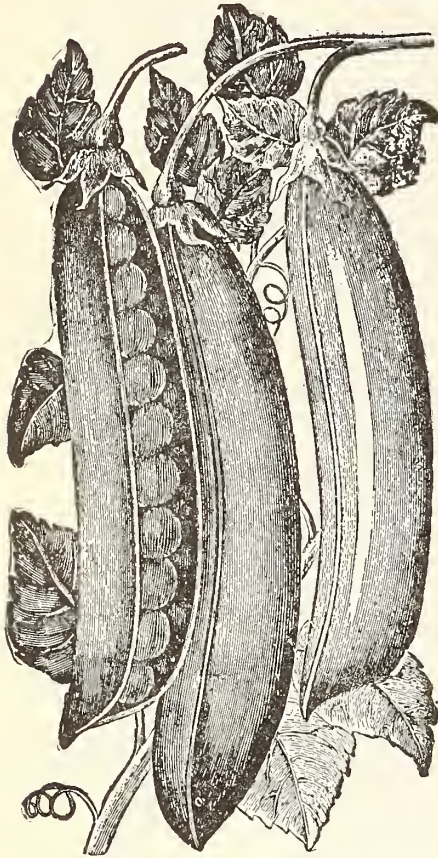

HEROINE PEAS.

**HEROINE PEAS.**—A medium early, green, wrinkled Pea, and one of the best of recent introduction; large, curved, showy pods; an immense cropper; Peas of finest quality. Height, 2 to 2½ feet.  
Pint, 20c. Quart, 40c. Peck, \$2.75. Bushel, \$10.00.

**CHAMPION OF ENGLAND.**—Height, 4 feet. An old favorite, rich flavored and very productive.  
Pint, 20c. Quart, 40c. Peck, \$2.75. Bushel, \$10.00.

**MELTING SUGAR (Edible Pods).**—This variety is ahead of all other Sugar Peas, not only in size of pod and prolific bearing, but also for its delicious flavor. It grows to the height of 5 feet, bears a profusion of very large, broad handsome light green pods, which are so brittle that they snap without any strings.  
Pint, 20c. Quart, 40c. Peck, —, Bushel, —.

**TALL GRAY SUGAR (Edible Pods).**—Cooked in the pods same as Snap Beans.  
Pint, 20c. Quart, 40c. Peck, —, Bushel, —.

**DWARF GRAY SUGAR (Edible Pods).**—Quite a favorite.  
Pint, 20c. Quart, 40c. Peck, —, Bushel, —.

**TELEPHONE.**—Height, 3 to 4 feet. Large wrinkled seeds; pods large and well filled.  
Pint, 20c. Quart, 40c. Peck, \$3.00. Bushel, \$10.00.

**TELEGRAPH, or LONG ISLAND MAMMOTH.**—Resembles the Telephone in every respect, except they are a deeper shade of green. Pods are very attractive in appearance.  
Pint, 20c. Quart, 40c. Peck, —, Bushel, —.

**IMPROVED SUGAR MARROWFAT PEAS (Genuine Stock).**—Height, 3½ feet. Grows a strong vine, bears in abundance large, filled pods. The truckers' favorite.  
Pint, 20c. Quart, 40c. Peck, \$2.25. Bushel, \$8.50.

**ADMIRAL DEWEY.**—Here we have a most excellent Pea, with large, handsome pods; Peas of the highest quality. More dwarf than the Stratagem and about a week earlier in maturing, regular and uniform in growth; vines stocky, healthy and of vigorous growth; pods long, frequently containing 10 peas, of tender and delicious flavor. Don't fail to try it.  
Pint, 20c. Quart, 40c. Peck, \$3.00. Bushel, \$10.00.

**FRENCH CANNER.**—Height, 3½ feet. The celebrated Pea used in France by the canners. It is wonderfully prolific, bearing an abundance of long pods, containing 7 to 9 peas of excellent flavor.  
Pint, 20c. Quart, 40c. Peck, \$2.25. Bushel, \$8.50.

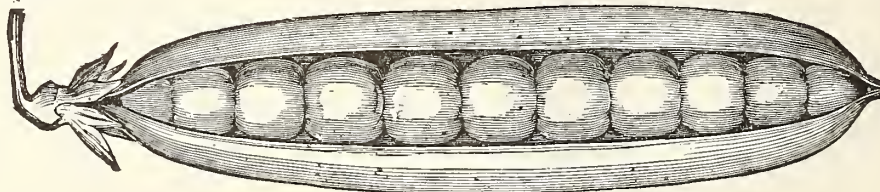
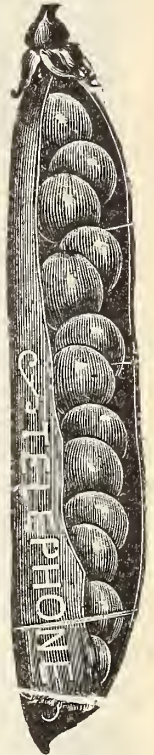

IMPROVED SUGAR MARROWFAT PEAS.

# HERBS

A well assorted selection of the various kinds of herbs should have a place in every garden. Their value in seasoning and flavoring is well known and appreciated. Sow in spring in shallow drills, one foot apart, and when well up thin out or transplant to a proper distance. Care should be taken to harvest on a dry day just before they fully blossom.

	Pkts.	Oz.	¼ lb.	Lb.		Pkts.	Oz.	¼ lb.	Lb.
ANISE .....	5c.	15c.	.....	.....	DILL .....	5c.	15c.	.....	50c.
BASIL .....	5c.	15c.	.....	.....	FENNEL (Sweet).....	5c.	15c.	.....	.....
BENE, use medicinally.....	5c.	15c.	.....	.....	LAVENDER .....	5c.	15c.	.....	.....
BORAGE, excellent for bees.....	5c.	15c.	.....	.....	MARJORAM .....	5c.	25c.	.....	.....
CARAWAY .....	5c.	15c.	.....	.....	ROSEMARY, an aromatic herb.....	5c.	35c.	.....	.....
CHERVIL .....	5c.	25c.	.....	.....	SAGE (American).....	5c.	20c.	.....	.....
CHICKORY .....	5c.	15c.	.....	.....	SUMMER SAVORY .....	5c.	15c.	.....	.....
CORIANDER .....	5c.	10c.	.....	.....	THYME (broad-leaved English)...	5c.	25c.	.....	.....

## PEPPER OR CAPSICUM

Is cultivated mainly for pickles; used as a seasoning in many ways; sometimes medicinally. Sow seed early in hotbed, if possible; if not, select a warm place in the garden for seed bed; sow as soon as the soil is warm. Transplant when 3 or 4 inches high, in rows 18 inches apart.

**LARGE BELL OR BULL NOSE.**—Plant vigorous, compact, very productive, ripening its crop uniformly and early. Fruit large, with thick, mild flesh, of excellent quality for use in salads and pickles; color bright red when ripe. **Pkt., 5c. Oz., 30c. ¼ Lb., \$1.00. Lb., \$3.50.**

**RUBY KING.**—An improved American variety often four to six inches in length and quite symmetrical in shape. It is very bright colored and the flesh is sweet and mild flavored. **Pkts., 5c. and 10c. Oz., 30c. ¼ Lb., \$1.00. Lb., \$3.50.**

**SWEET MOUNTAIN.**—Plants very vigorous, of compact, upright growth. The fruit does not ripen until very late. It is very large and long, often eight inches or more in length by two in diameter; very smooth and handsome, being when fully mature of a rich red color. Flesh very thick, sweet and mildly flavored. **Pkts., 5c. and 10c. Oz., 30c. ¼ Lb., \$1.00. Lb., \$3.50.**

**CHINESE GIANT.**—Double the size of Ruby King; the finest mild Red Pepper grown. It is very productive, having a magnificent appearance, which makes it sell readily. **Pkt., 10c. Oz., 40c. ¼ Lb., \$1.25.**

**LONG RED CAYENNE.**—A well known variety, having a slender, twisted and pointed pod about four inches long, and when ripe, bright red in color. Extremely strong and pungent flesh. **Pkts., 5c. and 10c. Oz., 30c. ¼ Lb., \$1.00.**

**RED CHERRY.**—Plant tall, bearing a profusion of round, bright red fruit which are very pungent when ripe. The plant, when in fruit, is very ornamental. **Pkts., 5c. and 10c. Oz., 35c.**

**RED CHILI.**—Used in the manufacture of pepper sauce. The bright, rich red pods are about two inches long, one-third to one-half inch in diameter at the base, tapering to a sharp point and exceedingly pungent when ripe. **Pkts., 5c. and 10c. Oz., 35c.**

## PUMPKIN

Plant in May, in hills 8 feet apart. Allot 10 seed to each hill, as bugs often destroy the young plants, but only allow 2 or 3 healthy plants to remain in each hill. They are usually planted in fields with corn or potatoes.

### G. & T. CO.'S MARYLAND SWEET POTATO

This is the best table Pumpkin in cultivation. In shape and size it somewhat resembles the Cashaw, but much more beautiful in color, being a handsome green and white striped. The flesh is a rich yellow color, solid, fine grained, very thick; flavor delicious. **Pkt., 5c. Oz., 15c. ¼ Lb., 25c. Lb., 90c.**

**LARGE CHEESE, OR KENTUCKY FIELD.**—A very large, flattened pumpkin, averaging about two feet through. When ripened the skin is a rich cream color. Flesh yellow and of fine quality. **Pkt., 5c. Oz., 15c. ¼ Lb., 20c. Lb., 60c.**

**TENNESSEE SWEET POTATO.**—A splendid pie and cooking pumpkin. They grow pear-shaped, of medium size, slightly ribbed; skin is creamy white, lightly striped with green; flesh very thick, creamy white, dry and fine-grained, keeping well until late in the spring. When cooked resembles sweet potatoes, but much more delicious in taste. **Pkt., 5c. Oz., 15c. ¼ Lb., 20c. Lb., 80c.**

### CONNECTICUT FIELD

A fine, large, orange-colored variety used for field culture and stock feeding. The skin is smooth and ribbed and the flesh is brittle and sweet. **Oz., 15c. ¼ Lb., 20c. Lb., 70c.**

**YELLOW CASHAW OR CROOKNECK.**—Solid flesh, fine and sweet; keeps well. **Pkt., 5c. oz., 15c. ¼ Lb., 20c. Lb., 75c.**

## SALSIFY OR VEGETABLE OYSTER

Sow in early spring in light, rich soil in drills 14 inches apart and thin the plants to six inches in the row. The roots will be ready for use in October and will sustain no injury by being left in the ground during the winter.

**SANDWICH ISLAND MAMMOTH.**—This new Salsify grows fully twice the size of the old sort, and is superior in quality. Invaluable to market gardeners. **Pkt., 5c. Oz., 15c. ¼ Lb., 50c. Lb., \$2.00.**

**LARGE WHITE.**—The old well-known variety. **Pkts., 5c. and 10c. ¼ Lb., 50c. Lb., \$2.00.**

ALL PRICES SUBJECT TO CHANGE WITHOUT NOTICE.



G. & T. CO.'S MARYLAND SWEET POTATO.



SALSIFY

## RADISH

**ONE OUNCE  
WILL SOW  
100 FEET  
OF DRILL**

For an early supply sow in hotbed in February. For a successive supply sow from middle of March to September. Radishes thrive best in light, rich, sandy loam. The radish must make a rapid growth to be fit for use; it will then be crisp and tender and of a mild flavor. If it grows slowly, it will be hard, fibrous and disagreeably pungent.

**EARLY SCARLET, OR PRUSSIAN GLOBE RADISH.**—This is the very best forcing variety; is sown largely by market gardeners and truckers, and they are delighted with it. It is of a globular shape and brilliant, beautiful crimson color, short top, and will stand a large amount of heat without becoming pithy. **Pkt., 5c. Oz., 10c. ¼ lb., 25c. Lb., 90c.**

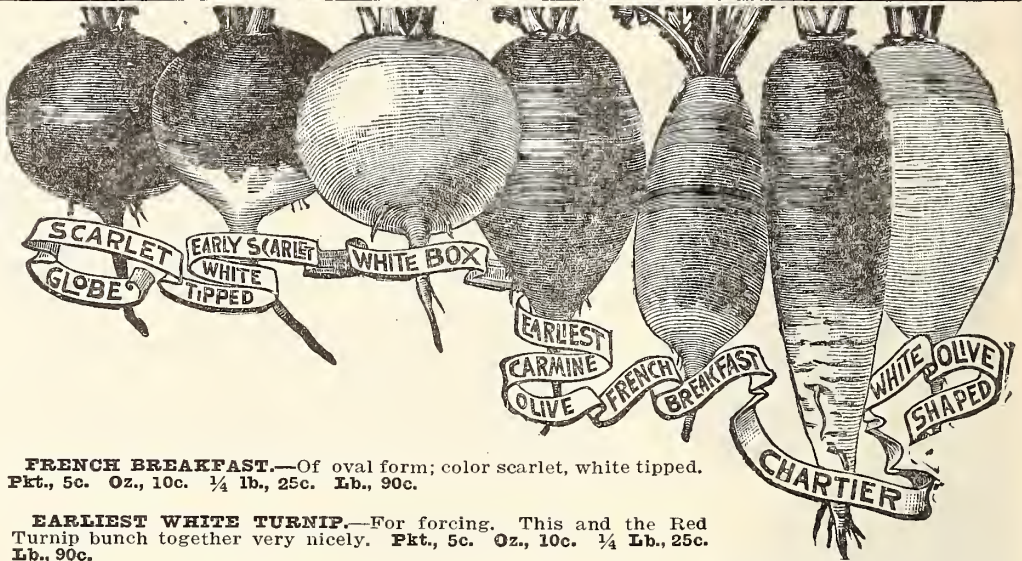

**FRENCH BREAKFAST.**—Of oval form; color scarlet, white tipped. **Pkt., 5c. Oz., 10c. ¼ lb., 25c. Lb., 90c.**

**EARLIEST WHITE TURNIP.**—For forcing. This and the Red Turnip bunch together very nicely. **Pkt., 5c. Oz., 10c. ¼ lb., 25c. Lb., 90c.**

**EARLY RED TURNIP.**—Turnip shaped; red skin; for forcing. Sometimes called Red Button Radish. **Pkt., 5c. ¼ lb., 25c. Lb., 90c.**

**SCARLET OLIVE-SHAPED RADISH.**—A showy half-long variety of pretty shape and bunches beautifully. **Pkt., 5c. Oz., 10c. ¼ lb., 25c. Lb., 90c.**

**WHITE BOX.**—Perfectly round, smooth skin, pure white, free from any sharpness or bitterness. A remarkably quick grower, with small top. For forcing, it is in every way superior. **Pkt., 5c. Oz., 10c. ¼ lb., 25c. Lb., 90c.**

**EARLY WHITE TIPPED SCARLET.**—An excellent variety for forcing, with very short leaves; bright scarlet in color, with a white tip. **Pkt., 5c. Oz., 10c. ¼ lb., 25c. Lb., 90c.**



White  
Strasburg  
Radish.

## SUMMER VARIETIES

**WHITE STRASBURG.**—This is becoming one of the most popular summer sorts; it is of handsome tapering shape, skin pure white; very tender. **Pkt., 5c. Oz., 10c. ¼ lb., 25c. Lb., 75c.**

**GIANT STUTTGART.**—A splendid new variety, of excellent quality; withstands summer heat. **Pkt., 5c. Oz., 10c. ¼ lb., 25c. Lb., 90c.**

**CHARTIER.**—A good variety for private or market garden purposes. Stands long before going to seed, and is tender and crisp. **Pkt., 5c. Oz., 10c. ¼ lb., 25c. Lb., 90c.**

**DELICACY.**—Resembles White Strasburg, being more evenly shaped and smaller topped; grows into full size and perfection during the hottest months. **Pkt., 5c. Oz., 10c. ¼ lb., 25c. Lb., 90c.**

**GOLDEN GLOBE.**—An excellent summer Radish; slow to run to seed; shape globular, bright yellow color and mild flavor. **Pkt., 5c. Oz., 10c. ¼ lb., 25c. Oz., 90c.**

## LONG VARIETIES

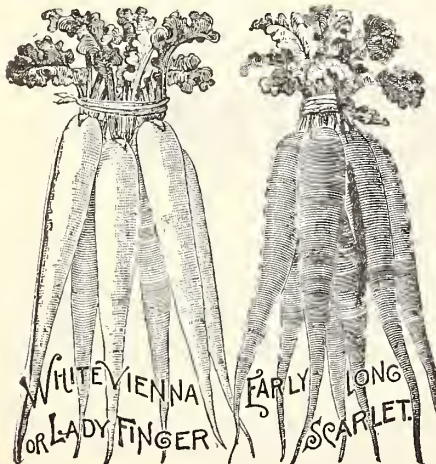

**CINCINNATI MARKET NEW GLASS RADISH.**—**Pkt., 5c. Oz., 10c. ¼ lb., 25c. Lb., 75c.**

**WHITE VIENNA, OR LADY FINGER.**—This is unquestionably the finest long white Radish. Of most handsome shape, color a beautiful snowy white. It is of very rapid growth, and remarkably crisp, brittle and tender; equally desirable for the market or home garden. **Pkt., 5c. Oz., 10c. ¼ lb., 25c. Lb., 75c.**

**LONG SCARLET (Finest Grown).**—Very attractive and sells rapidly. Owing to its handsome shape, brilliant color and fine qualities, it commands a higher price and more ready sale than the ordinary Long Scarlet as generally sold. **Pkt., 5c. Oz., 10c. ¼ lb., 25c. Lb., 75c.**

# RADISH—CONTINUED

## WINTER VARIETIES

**WHITE CHINESE WINTER, OR CELESTIAL**—This excellent variety is sold also as Chinese White Winter. The roots are long, cylindrical, with beautiful white skin and flesh, the whitest and usually the least pungent of the winter varieties. When fully mature the roots are six to nine inches long by about two and one-half to three and one-half inches in diameter. The flesh is compact and crisp. **Pkt., 5c. Oz., 15c. ¼ lb., 25c. Lb., 90c.**

**CHINESE ROSE WINTER**—Remarkably fine for winter use. The best of the winter sorts. **Pkt., 5c. Oz., 10c. ¼ lb., 25c. Lb., 75c.**

**LONG BLACK SPANISH**—A large winter variety; one of the hardiest, with dark green leaves, firm in texture, keeping until spring.

**LONG WHITE SPANISH (Winter)**—Fine keeping quality.

**ROUND WHITE SPANISH**—A good fall or winter variety. **Pkt., 5c. Oz., 10c. ¼ lb., 25c. Lb., 90c.**

**ROUND BLACK SPANISH**—A fine globe-shaped Radish; very popular with the Germans, known as Rettig; good quality. **Crop failed.**

## RHUBARB OR PIE PLANT

ONE OUNCE OF SEED TO 125 FEET OF DRILL.

**CULTURE**—Good plants are easily grown in any good garden soil. Sow seed thinly in shallow drills a foot apart, thin to 4 or 5 inches. Keep soil loose and free from weeds. The plants are liable to vary considerably. Pick out the strongest and best. In fall or spring following, transplant to the permanent bed, 4 feet apart each way, in deep, warm and very rich soil. The more mature the better stalks. For winter forcing take up two-year roots in fall, leave out to freeze, then bed close together on cellar bottom or under greenhouse bench in the dark. **Pkts., 5c. and 10c. Oz., 20c. ¼ lb., 35c. Lb., \$1.25.**

## RHUBARB ROOTS

20c. each.

Dozen, \$2.00.

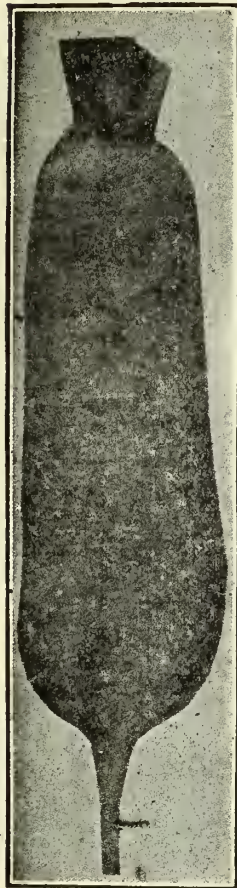

Chinese Winter Radish.

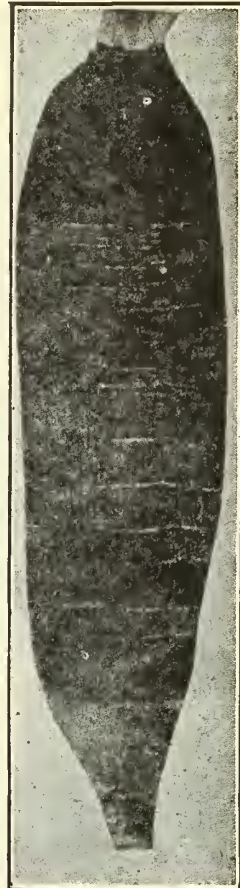

Long Black Spanish Radish.

# SPINACH

This is quite an important crop with market gardeners, and one easily managed. For summer use, sow early in spring, in drills eight inches to one foot apart, covering the seed one inch deep. Select rich soil and manure liberally. A succession may be obtained by sowing at intervals of two weeks through the season. For very early spring sow in August, and protect the plants through the winter by a thick covering of clean straw or some other similar light covering. Spinach is used principally as greens for boiling, and is very highly esteemed for this purpose.

**BLOOMSDALE SAVOY**—The variety most generally used in the East and especially throughout the South for shipping. Leaves large, round and thick, very much savoyed and rich deep green. One of the earliest varieties. Seed round. **Pkt., 5c. ¼ lb., 15c. Lb., 30c.**

**G. & T. CO.'S EXTRA CURLED AMERICAN-GROWN BLOOMSDALE SAVOY SPINACH**—This is grown especially for us, and is without exception the best type of Savoy Spinach in existence. It is beautifully curled and wrinkled, the leaves large, thick and heavy, produced in great numbers, and stands handling and transportation better than any other sort; in fact, we hardly think we could say too much about this valuable acquisition to the spinach family. Sold only in sealed bags. **Pkt., 5c. ¼ lb., 15c. Lb., 30c.**

**NEW ZEALAND**—This endures heat and is best for summer. **Pkt., 10c. Oz., 15c. ¼ lb., 30c. Lb., \$1.00.**

Bloomsdale—Savoy SU NELLÆ

# SPINACH--CONTINUED

**LONG STANDING**—Best for spring sowing, as it is very slow to seed. The leaves are large, round, unusually thick, curled and of dark green color. **Pkt., 5c.; ¼ Lb., 15c.; Lb., 40c.**

**LARGE ROUND-LEAVED VIROFLAY**—A new sort, with very large, thick leaves. **Pkt., 5c.; ¼ Lb., 15c.; Lb., 40c.**

**VICTORIA SPINACH**—This new spinach comes to us with the highest recommendations from the growers. The foliage is heavy, the broad, dark green leaves being of the true Savoy appearance and of the finest quality; but the most remarkable feature that will make it of special value, both for market and family gardens, is the fact that it is in prime condition from two weeks to three weeks after all other varieties of spinach have run to seed. **Pkt., 5c.; ¼ Lb., 15c.; Lb., 40c.**

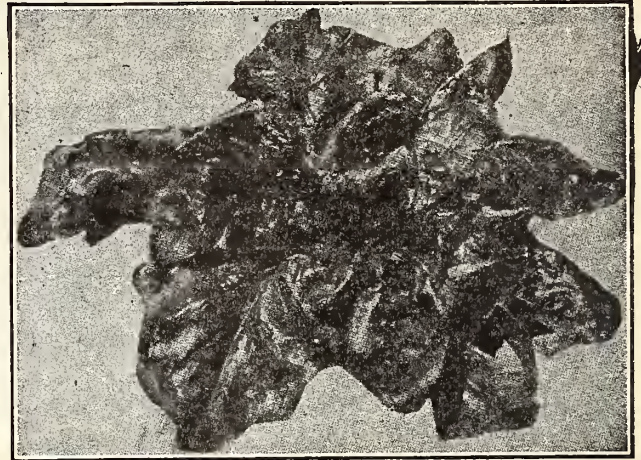

Long Standing Spinach.

WRITE FOR SPECIAL PRICES IN QUANTITIES.

# Squash

The Squashes are all quite tender, and therefore no progress can be made in starting them until the weather becomes somewhat warm and settled. Plant in hills five feet apart each way for the bush varieties, and eight feet for the running varieties; put eight seeds to the hill, but don't allow over three to stand.

**EARLY WHITE BUSH SCALLOP**—A desirable and marketable sort. Best known and most productive of all the summer sorts. **Pkt., 5c. Oz., 15c. ¼ Lb., 25c. Lb., 75c.**

**SUMMER CROOK NECK (Early)**—Fine flavor; a desirable table sort. **Pkt., 5c. Oz., 15c. ¼ Lb., 25c. Lb., 75c.**

**WINTER CROOK NECK**—Flesh red, fine flavor; largely grown for winter use. **Pkt., 5c. Oz., 15c. ¼ Lb., 25c. Lb., 75c.**

**HUBBARD**—The most popular winter squash. Fruit is oblong and pointed, heavily warted, dark green in color, with orange-colored flesh. Is remarkable for its keeping qualities. **Pkt., 5c.; Oz., 15c.; ¼ Lb., 35c. Lb., \$1.00**

**BOSTON MARROW**—A popular variety, with large, oval fruit. Skin bright reddish orange with light cream netting. Flesh orange. Fine grained and of excellent quality. This is the most popular variety for canning. The fruit makes a rich orange-red, and delicious flavored dish.

**Pkt., 5c. Oz., 15c. ¼ Lb., 25c. Lb., 60c.**

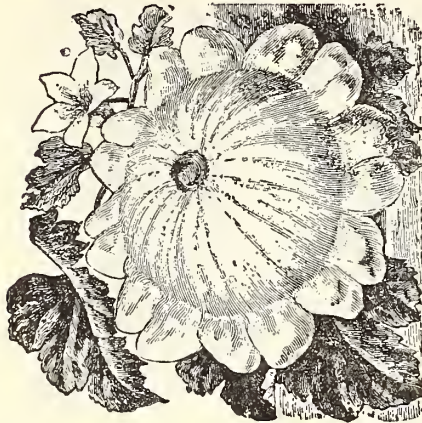

Early White Bush Scallop.

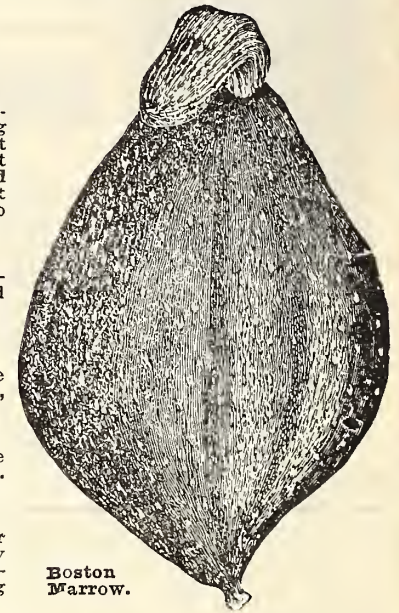

Boston Marrow.

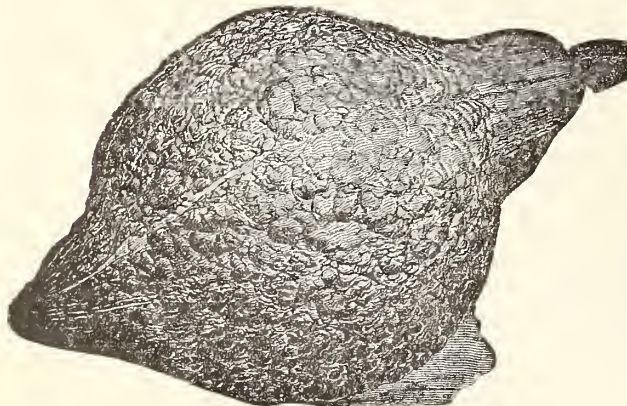

Hubbard.



Summer Crook Neck.

ALL PRICES SUBJECT TO CHANGE WITHOUT NOTICE.

# TOMATO

BONNY BEST  
TAKEN FROM  
PHOTOGRAPH.

ONE CLUSTER.

ONE-THIRD  
NATURAL SIZE



EXTRA EARLY RED

VARIETIES

For early fruit sow the seed in March or April, in the hotbed or in pots in a sunny exposure in the house. When the plants are about three or four inches high they should be set out four or five inches apart in another hotbed or cold frame or removed into small pots, allowing a single plant to a pot. Expose to the air as much as possible to harden, and about the middle of May set the plants in the open ground at a distance of four or five feet each way. Water freely at the time of transplanting, and shelter from the sun for a few days until the plants are established. Sufficient plants for a small garden, may be had by sowing a few seeds in a shallow box or flower pot and placing in a sunny window in the house. Cultivate thoroughly as long as the vines will permit.

Tomatoes will admit of training to stakes or trellis of various kinds, and the fruit is very much improved both in appearance and quality. This mode of cultivation is now quite common among gardeners who grow for early market. The usual method is to set one strong plant to a stake, using stakes out quite freely as the vines advance in growth. By adopting this method the plants may be set much closer than in the ordinary way.

five to seven feet in height, tying the plant up with wool or other strong, soft twine, pruning out quite freely as the vines advance in growth. By adopting this method the plants may be set much closer than in the ordinary way.

## BONNY BEST TOMATO

As its name signifies, it is the best extra early tomato yet introduced. Is fully ten days earlier than Chalk's Early Jewel, and within a day or two, if not quite as early as Spark's Earliana. Truckers who tested it claim it is as early as Earliana.

It is a vigorous grower, very prolific, with dense foliage, which protects the fruits from hot sun when other varieties like the Earliana have scalded fruits. The fruit is even size, smooth, round, red, of delicious flavor, ripening to stem.

It does not have the green surface like the Earliana and other extra early varieties. Pkts., 5c. and 10c. Oz., 35c. ¼ lb., \$1.25. Lb., \$4.00.

EARLY I. X. L. TOMATO.—Earliest, largest, most prolific. Pkts., 10c. Oz., 35c. ¼ lb., \$1.00 Lb., \$3.75

CHALK'S EARLY JEWEL.—Deep-fruited and solid. The growth is very compact. Fruit of uniformly good size; very solid; brightest scarlet, ripening up to the stem without cracks or green core; sweet flavor.

Pkts., 5c. and 10c. Oz., 35c. ¼ lb., \$1.25. Lb., \$4.00.

NEW SUCCESS.—A magnificent new scarlet fruited Tomato of the finest quality, handsome appearance, large size and great productiveness.

Pkts., 5c. and 10c. Oz., 35c. ¼ lb., \$1.00. Lb., \$3.00.

## EARLY RED VARIETIES

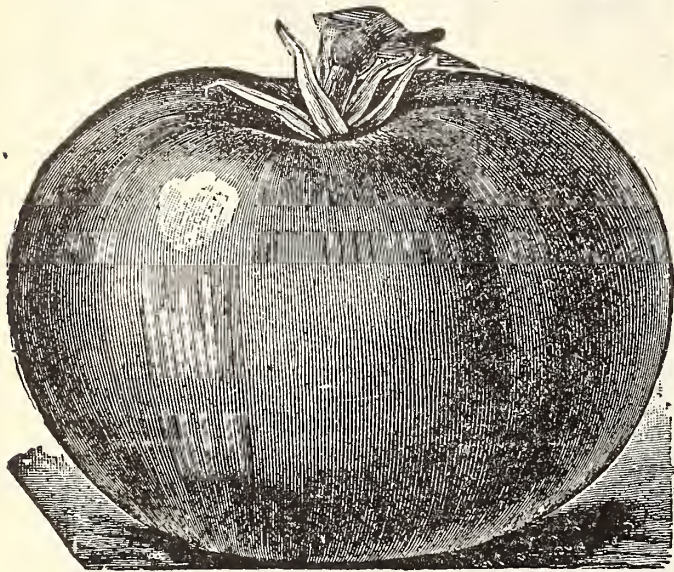

### EXTRA EARLY RUBY

While not as early as the Sparks' Earliana by a week or ten days, it is far superior in quality, size, shape, flavor and productiveness. In color, ruby red, nearly globe-shaped; solid flesh throughout, and with very few seeds and free from acidity; it makes a splendid main crop variety; a great keeper and shipper. Pkt., 10c. Oz., 35c.  $\frac{1}{4}$  lb., \$1.25. Lb., \$4.00.

**JOHN BAER.**—New, early and prolific. Fine flavor and shape; quite as early as Bonny Best.

Pkts., 5c. and 10c. Oz., 40c.  $\frac{1}{4}$  lb., \$1.25. Lb., \$4.00.

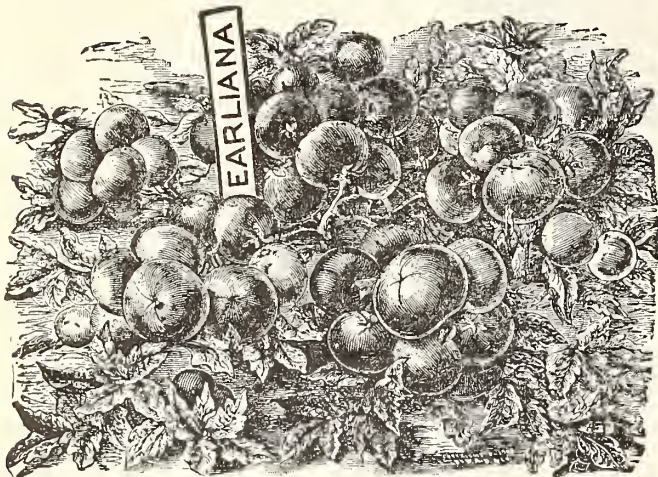

**SPARKS' EARLIANA.**—The earliest bright red Tomato; very large, smooth, color bright red; solid and excellent for slicing. The plants are of moderate growth, well set with fruits, nearly all of which ripen extremely early in the season. Grows in clusters; of medium size; smooth, solid, solid center, small seed cells, slightly acid.

Pkts., 5c. and 10c. Oz., 35c.  $\frac{1}{4}$  lb., \$1.25. Lb., \$3.75.

## Extra Early Purple Varieties

**BEAUTY.**—For early market and shipping this cannot be excelled, because of its solidity and toughness of skin. Color is a rich, glossy crimson, with a slight tinge of purple. It is well known and very largely used by our gardeners.

Pkts., 5c. and 10c. Oz., 25c.  $\frac{1}{4}$  lb., 75c. Lb., \$2.75.

**DWARF CHAMPION.**—Dwarf, upright growth; smooth purple fruit.

Pkts., 5c. and 10c. Oz., 35c.  $\frac{1}{4}$  lb., \$1.25. Lb., \$4.75.

**PRIZETAKER.**—Early; large; handsome; deep crimson; slight tinge of purple.

Pkts., 5c. and 10c. Oz., 25c.  $\frac{1}{4}$  lb., 75c. Lb., \$2.75.

## Medium Early Purple Varieties

**PRIZEWINNER.**—Purple; early; prince of market Tomatoes; color resembles Beauty, but larger; solid; one of the best keepers and shippers; smooth; well adapted for late crop.

Pkt., 10c. Oz., 25c.  $\frac{1}{4}$  lb., 75c. Lb., \$2.75.

**PONDEROSA.**—Remarkable for size; fruits heavy; deep red; flesh thick, solid and fine quality.

Pkts., 10c. Oz., 35c.  $\frac{1}{4}$  lb., \$1.25.

**ACME.**—Purple; early; medium; pink-purplish; slightly oval.

Pkts., 5c. and 10c. Oz., 25c.  $\frac{1}{4}$  lb., 75c.

## Small Fruited Varieties

**LORILLARD.**—Best for greenhouse forcing; bright, glossy red; very smooth. Pkt., 10c.

**PEAR-SHAPED RED.**—Pkts., 5c. and 10c. Oz., 35c.  $\frac{1}{4}$  lb., \$1.25.

**PEAR-SHAPED YELLOW.**—Used for preserves and pickles. Pkts., 5c. and 10c. Oz., 35c.  $\frac{1}{4}$  lb., \$1.25.

**YELLOW PLUM.**—Color bright yellow; excellent for preserving. Pkt., 5c. Oz., 35c.  $\frac{1}{4}$  lb., \$1.25.

## MAIN CROP



## Griffith & Turner Co.'s World's Fair

The great canner. The six great points of this great canner—solidity, symmetry, handsome, bright red, ripens uniform, free from rot. Its shipping and keeping qualities are unexcelled.

The planters now demand this great Tomato, notwithstanding the fact that there are many much-newer varieties. Yet it has been so successful that it is preferred above all others. The fruit is particularly solid and of fine flavor, good size, smooth, and certainly very attractive.

Pkts., 5c. and 10c. Oz., 25c.  $\frac{1}{4}$  lb., 75c. Lb., \$2.50.



MAIN CROP VARIETIES



**THE NEW STONE TOMATO.**—Ripens for main crop; is very large and of bright scarlet color; very smooth, with occasionally a specimen very slightly octagon-shaped, ripening evenly to the stem without a crack; exceedingly solid and firm-fleshed (as its name indicates). It is an excellent shipper; fine for canning; a good keeper; not subject to rot.

Pkts., 5c. and 10c. Oz., 25c. ¼ Lb., 75c. Lb., \$2.50.

**“GREATER BALTIMORE” TOMATO.**—Makes a fine crop.

Pkt., 10c. Oz., 25c. ¼ Lb., 75c. Lb., \$2.50.

**LIVINGSTON’S FAVORITE.**—Bright red, smooth Tomato of good size.

Pkts., 5c. and 10c. Oz., 25c. ¼ Lb., 75c. Lb., \$2.50.

**PARAGON.**—Well-known standard bright red Tomato.

Pkts., 5c. and 10c. Oz., 25c. ¼ Lb., 75c. Lb., \$2.50.

**ROYAL RED.**—New; resembles Favorite in form and color; good main crop variety.

Pkts., 5c. and 10c. Oz., 25c. ¼ Lb., 75c. Lb., \$2.50.

**NEW QUEEN TOMATOES.**—Fruit somewhat resembles Paragon in appearance. This sort is well known and a favorite among canners, but it is not as deep red in color nor as weighty and solid as our World’s Fair.

Pkts., 5c. and 10c. Oz., 20c. ¼ Lb., 75c. Lb., \$2.50.

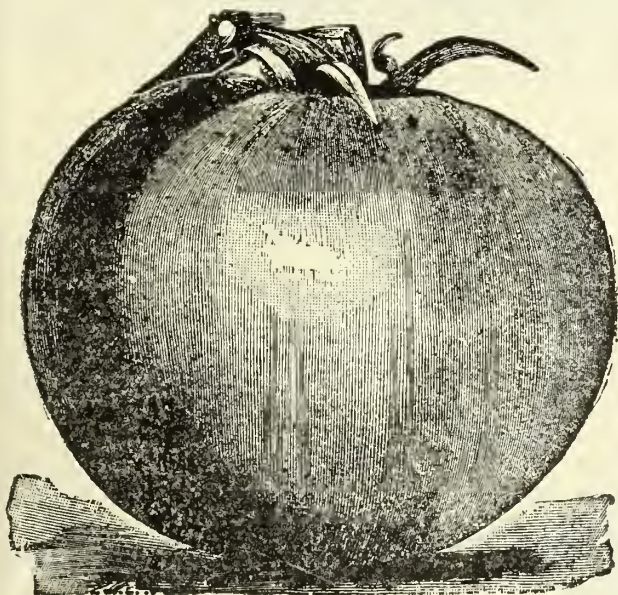

RED ROCK

One of the finest for canning, being extraordinarily solid, smooth and red. No other variety has any better qualities than the Red Rock. Of fine flavor, very meaty and wonderfully free from acid. A heavy producer and good shipper. We think it is the coming Tomato for main crop and canners’ use. Pkts., 5c and 10c. Oz., 25c. ¼ Lb., 75c. Lb., \$2.50.

**WISDOM.**—Recently introduced. Medium, early; good crop-per, fine size and flavor. Good for early or late planting.

Pkts., 5c. and 10c. Oz., 40c. ¼ Lb., \$1.25. Lb., \$4.00.

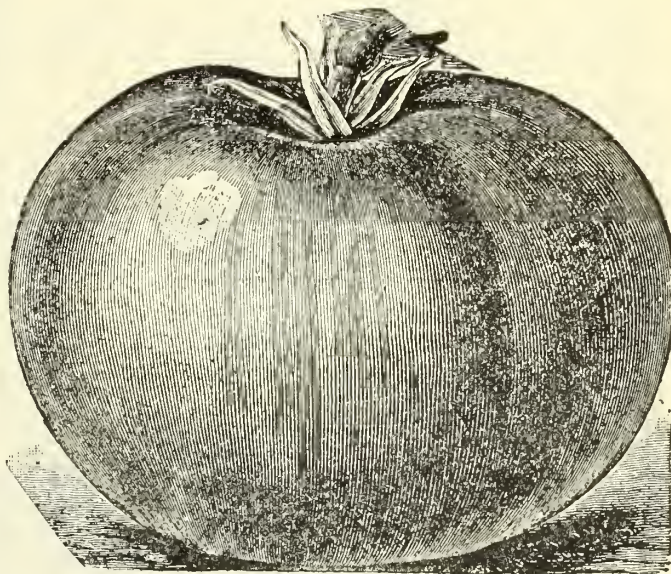

**MATCHLESS.**—The color is rich red. The skin is so tough that it makes a splendid keeper and shipper, and is less liable to crack in wet weather than any other large Tomato. Unsurpassed for market or table; strong grower and very productive, bearing with undiminished vigor until frost. The fruit is free from core and the seed spaces comparatively small.

Pkts., 5c. and 10c. Oz., 20c. ¼ Lb., 75c. Lb., \$2.50.

**BRINTON’S BEST.**—One of the leading sorts for second early and late use; the fruit is large, handsome and a splendid keeper. A great favorite with canners and truckers.

Pkts., 5c. and 10c. Oz., 20c. ¼ Lb., 75c. Lb., \$2.50.

**KELLY RED TOMATO.**—This splendid Red Tomato originated in Anne Arundel County, Md., and through its superior qualities it has become the Tomato most largely used in that section. It is large, meaty, an abundant yielder, and withstands unfavorable conditions remarkably well.

Pkts., 5c. and 10c. Oz., 20c. ¼ Lb., 75c. Lb., \$3.00.

## TURNIP

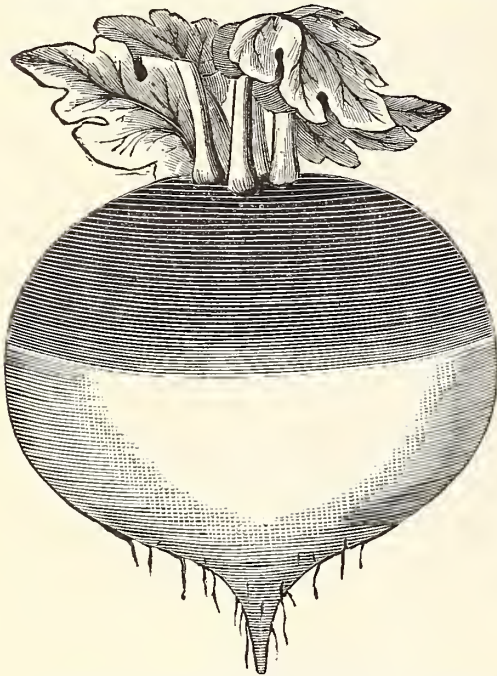

**Improved Purple or Red Top Globe Turnip.**

This excellent table variety is globular in shape, of good size and very attractive appearance. The roots are large, purple or dark red above ground, white below. The flesh is white, fine grained and tender. The roots when in best condition for the table are about three inches in diameter, but can be grown much larger for stock feeding. This sort keeps well for so early a variety, and is one of the best for market use. It is also known as Red Top White Globe.

Pkt., 5c.  $\frac{1}{4}$  Lb., 15c.  $\frac{1}{2}$  Lb., 20c. Lb., 40c.

For early use, sow the small sorts as soon as the ground can be worked in the spring, in drills 14 inches apart, the Rutabagas 30 inches. As the seed is very fine, it should be covered but slightly, excepting in very dry weather. Select light, and if possible, new soil and manure with plaster and ashes or phosphates. Should the young plants be troubled with insects, a sprinkling of slug shot will be beneficial. For fall and winter use the early kinds should be sown, from the middle of July to the middle of August, and the Rutabagas from the middle of June to the first of July, using from one to one and a half pounds of seed to the acre.

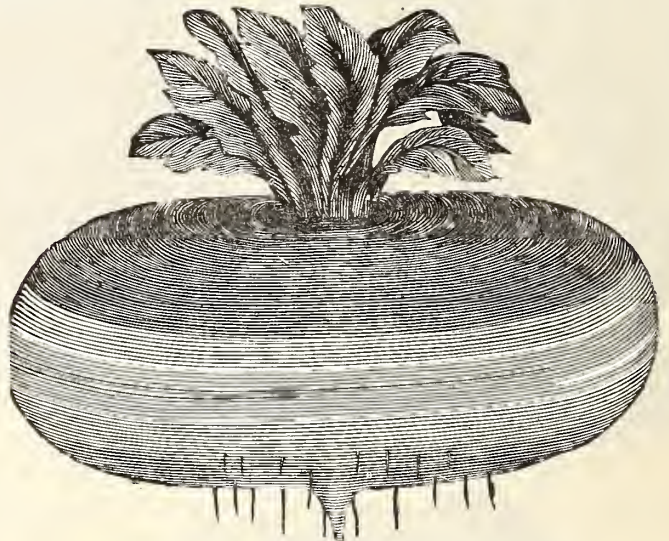

**Red or Purple Top Flat Strap-Leaved Turnip.**

A very early strap-leaved variety, very extensively used for the table. The leaves are few, entire, upright in growth. The roots are flat, of medium size, purple or dark red above ground, white below. The flesh is white, fine grained and tender. Roots when in best condition for table use are about two and one-half inches in diameter, but can be grown much larger for stock feeding. This sort is also known as Early Red Top, Strap-Leaved. Pkt., 5c.  $\frac{1}{4}$  Lb., 15c.  $\frac{1}{2}$  Lb., 20c. 1 Lb., 40c.

**YELLOW ABERDEEN, or SCOTCH YELLOW**—This is a highly approved Cattle Turnip, attaining a large size. It is solid, nutritious, a good keeper, and in every respect reliable.

Pkt., 5c.  $\frac{1}{4}$  Lb., 15c.  $\frac{1}{2}$  Lb., 20c. Lb., 40c.

**LARGE AMBER, or YELLOW GLOBE**—Grows to a large size; flesh yellow, firm and fine-grained. Excellent for either table use or feeding stock. Pkt., 5c.  $\frac{1}{4}$  Lb., 15c.  $\frac{1}{2}$  Lb., 20c. Lb., 40c.

**SEVEN TOP**—For greens and salads. Used largely in the Southern States. Pkt., 5c.  $\frac{1}{4}$  Lb., 20c.  $\frac{1}{2}$  Lb., 30c. Lb., 50c.

**EXTRA EARLY PURPLE TOP MILAN**—The earliest and handsomest Flat Turnip in cultivation; none equal to it for spring sowing. Pkt., 5c.  $\frac{1}{4}$  Lb., 25c.  $\frac{1}{2}$  Lb., 40c. Lb., 75c.

**WHITE FLAT (Strap Leaf)**—Differs from Red Top only in color. Pkt., 5c.  $\frac{1}{4}$  Lb., 15c.  $\frac{1}{2}$  Lb., 20c. Lb., 40c.

**EARLY WHITE EGG**—A new variety of rapid growth; egg-shaped and white, as its name indicates. Pkt., 5c.  $\frac{1}{4}$  Lb., 15c.  $\frac{1}{2}$  Lb., 20c. Lb., 40c.

**COW HORN (Large Croppers)**—This variety is pure white, excepting a dash of green at the crown, and in shape is long, like the carrot. Oz., 10c.  $\frac{1}{4}$  Lb., 15c.  $\frac{1}{2}$  Lb., 20c. Lb., 40c.

**SOUTHERN PRIZE**—True strain of the favorite Turnip for greens in Virginia and Carolinas. Valued also for its bulk. Oz., 10c.  $\frac{1}{4}$  Lb., 15c. Lb., 40c.

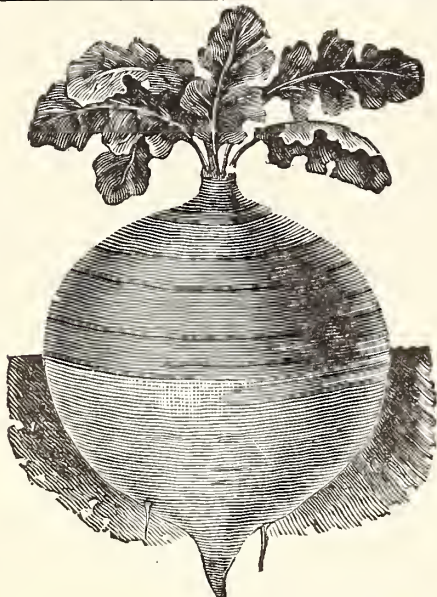

**G. & T. Co.'s Improved Purple Top Rutabaga.**

## RUTABAGAS OR SWEDES

The Swede Turnips, or Rutabagas, grow much larger in size, and are of greater value for stock feeding than ordinary turnips. Every farmer and stock-raiser should grow Rutabagas and Stock Beets for winter feeding.

**GRIFFITH & TURNER CO.'S IMPROVED PURPLE TOP**—Yellow-fleshed. A standard field variety for stock and fine for family use. This splendid Swede is the hardiest, most productive and most nutritious variety in cultivation. Pkt., 5c.  $\frac{1}{4}$  Lb., 15c. Lb., 40c.

**PURPLE TOP RUTABAGA**—An old standard sort of good quality. Pkt., 5c.  $\frac{1}{4}$  Lb., 15c.  $\frac{1}{2}$  Lb., 20c. Lb., 40c.

**G. & T. CO.'S WHITE ROCK**—Though sometimes called a turnip, this is more like a rutabaga. The root is large, both skin and flesh very white, and is one of the best varieties we have for table use. An excellent keeper and a desirable sort for market gardeners. Pkt., 5c.  $\frac{1}{4}$  Lb., 15c.  $\frac{1}{2}$  Lb., 20c. Lb., 40c.

# POTATOES

MAINE OR NORTHERN GROWN

ALL POTATOES SOLD BY WEIGHT ONLY

Owing to fluctuations in market for potatoes, ask for prices in quantity.  
A Bushel Consists of 60 Pounds.

The soil best suited to the Potato is a rich, sandy loam, but it seems to thrive in almost any soil or climate. The Potato being a gross feeder requires a liberal application of manure. If stable manure is to be used it should be well-rotted, and not allowed to come in contact with the tubers. On no other crop are the results from the use of phosphates so manifest as on the Potato. Almost invariably the tubers are smoother, brighter and freer from rust and the destructive influence of wire worms. **GRIFFITH & TURNER CO.'S PLANT FOOD** is especially adapted for Potatoes, as it promotes growth and at the same time prevents disease. Plant as early in the spring as the ground can be thoroughly worked in rows three feet apart and one foot in the rows, covering in light, warm soil about four inches, and in cold, wet ground three inches deep; draw the earth to the plants as they advance in growth. The soil should be constantly stirred through the season to prevent the surface from baking.

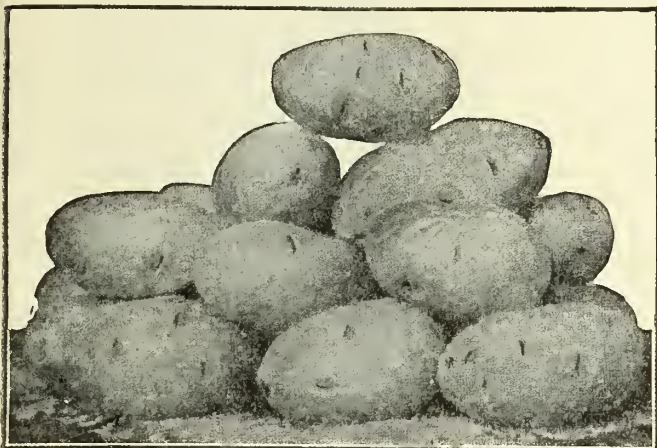

Extra Early Prize Potatoes.

**G. & T. CO.'S EXTRA EARLY PRIZE.**—This potato is in all respects a very superior early sort. It proved to be early and productive; also found its eating qualities first class. We consider it the best early Potato on the market today.  
15 lbs. @ 4c. lb.

**WHITE BLISS TRIUMPH, or PRIDE OF THE SOUTH.**—Extra early round white; identical with the Red Bliss, only different in color. A very fine variety for early market or family garden.  
15 lbs. @ 4c. lb.

**RED BLISS TRIUMPH.**—This beautiful variety combines the wonderful productiveness of the Peerless with all the good qualities of the Early Rose; is much more productive and matures its crop at least a week in advance of the Early Rose.  
15 lbs. @ 4c. lb.

**EARLY OHIO.**—This is very early and productive, of fine quality and an excellent keeper.  
15 lbs. @ 4c. lb.

**MAINE, or HOULTON EARLY ROSE.**—The Early Rose led the list for over 30 years, and is today one of the best early market Potatoes. Our stock of this is grown on new land, near Houlton, Maine; is rugged and pure, and produces as good crops as those which made the Early Rose famous in its early years. Remember, that this stock is not to be confounded with the old run-out Rose grown in other sections.  
15 lbs. @ 4c. lb.

**IRISH COBBLER (A New Sort).**—Very productive, matures early; shape chunky, eyes strong and deeply set, skin netted, flesh white, quality very superior. After years' experience we find that it is a very superior variety. Don't fail to get it.  
15 lbs. @ 4c. lb.

**BEAUTY OF HEBRON.**—Very rapid and vigorous grower, ripening as early as Early Rose, which it resembles, but frequently exceeds in productiveness and excellence for table use, either baked or boiled.  
15 lbs. @ 4c. lb.

**EARLY NORTHER.**—This superb Potato originated at Caribou, Maine. It resembles the Early Rose in shape and color, matures earlier than the Rose, and is much more productive. Under our own observation the past season it yielded more than the Rose, matured earlier, and was in all respects superior.  
15 lbs. @ 4c. lb.

**PROSPERITY.**—A middle-crop variety, one of the handsomest large Potatoes ever produced. The yield is immense, and even under unfavorable circumstances can be relied on; flesh very white; cooks dry and mealy.  
15 lbs. @ 4c. lb.

**RURAL NEW YORKER, No. 2.**—A valuable variety of large size, very smooth and a great cropper; in quality unexcelled. This variety is yearly becoming more popular as the best late long keeper, and we recommend it highly.  
15 lbs. @ 4c. lb.

**GREEN MOUNTAIN.**—A fine late sort.  
15 lbs. @ 4c. lb.

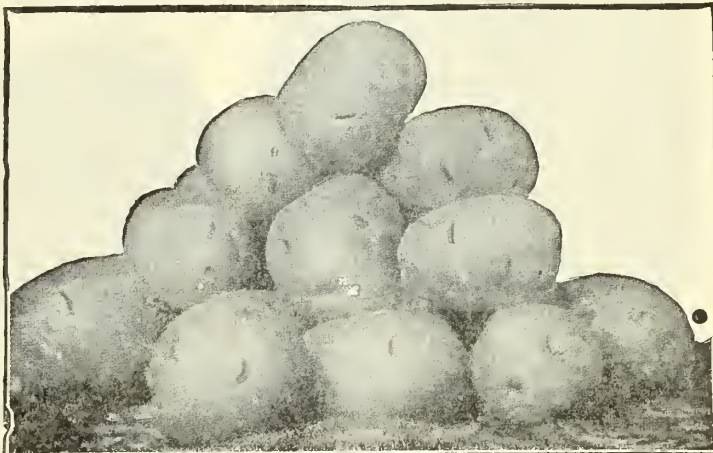

Irish Cobbler Potatoes.

If wanted by mail, add for Parcel Post charge as per table on inside 1st Cover Page.

## SWEET POTATOES

CHOICE JERSEY SWEETS AT MARKET PRICES DURING SEASON. WRITE FOR QUOTATIONS.

ASK FOR PRICE IN LARGE QUANTITIES.

ALL PRICES IN CATALOG SUBJECT TO CHANGE WITHOUT NOTICE.

# YELLOW FIELD CORN

**CHESTNUT GROVE YELLOW CORN**—This corn was grown on Chestnut Grove Farm, Baltimore County, and the average yield from the whole crop was 20 1-16 barrels to the acre. The ears are large, deep, medium-sized grain, and of beautiful color. **Qt., 20c. Pk., \$1.25. Bu., \$4.00.**

**NEW MARYLAND YELLOW DENT**—The stalks grow from 7 to 10 feet high, does not exhaust soil so much, and will stand drought better than a large stalk, and will yield 5 to 10 bushels per acre more than any other corn generally planted. **Qt., 20c. Pk., \$1.25. Bu., \$4.00.**

**IMPROVED EARLY LEAMING**—Bred and tested for 10 years. Pedigree stock. An early selected variety of yellow corn; small grains, weighty and productive. Highly esteemed in Maryland and Pennsylvania. One of the earliest varieties of yellow corn in cultivation. **Qt., 20c. Pk., \$1.25. Bu., \$4.00.**

**G. & T. CO.'S IMPROVED GOLDEN BEAUTY**—A large, broad-grained yellow corn, with ears of perfect shape and small cob. The richness of color and the quality of grain make it a very superior variety. **Qt., 20c. Pk., \$1.25. Bu., \$4.00.**

**90-DAY YELLOW**—This is an excellent quick-growing variety. May be planted after peas are taken off, and make a good crop. Largely used by truckers around Baltimore. **Qt., 20c. Pk., \$1.25. Bu., \$4.00.**

**REID'S YELLOW DENT CORN**—Matures in 100 to 105 days. Has a rich yellow color, very solid heavy ears from 8 to 12 inches long, with 16 to 18 rows of grain. The grains are deep on a small red cob. Fodder from 7 to 8½ feet high, and produces a great many stalks with two ears. A fine early corn. **Qt., 20c. Pk., \$1.25. Bu., \$4.00.**

**SMOKY YELLOW DENT**—The earliest dent Corn today; a good yielder and entirely free from disease. It is the most beautifully colored up corn in cultivation. Sides of grain red, with white cap. Grows strong, quick and has splendid seven to eight foot fodder. Will mature in 75 to 80 days. Price: **Qt., 20c. Pk., \$1.25. Bu., \$4.00.**

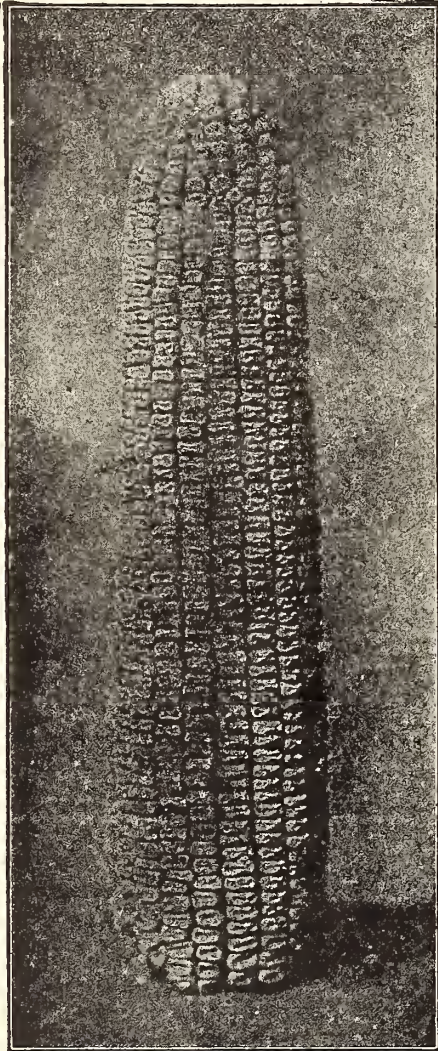

Maryland Yellow Dent Corn

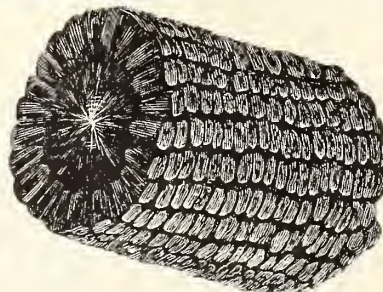

Improved Yellow Leaming

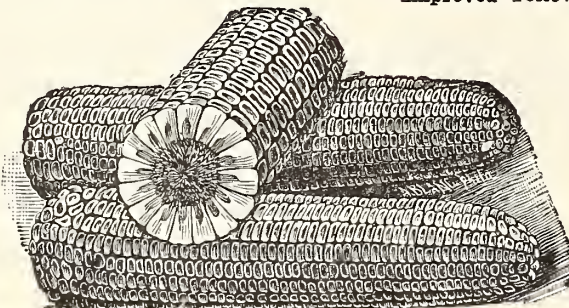

Golden Beauty (Yellow)

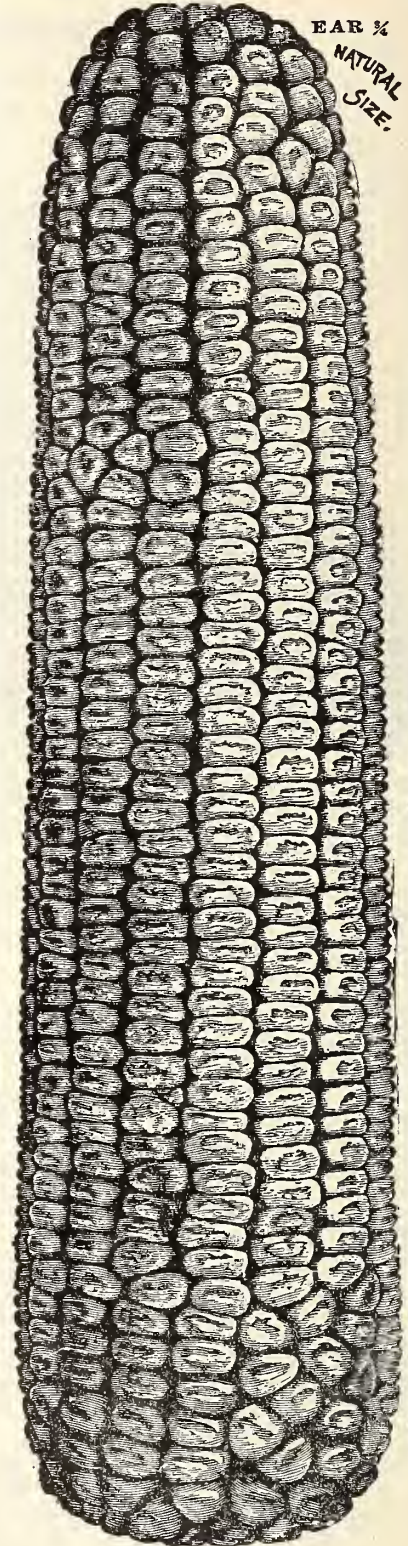

GRIFFITH & TURNER CO.'S CHESTNUT YELLOW CORN

## WHITE FIELD CORN

**G. & T. CO.'S IMPROVED MARYLAND WHITE DENT CORN.**—After years of careful selection we have secured this improved White Field Corn; grows good-sized ears and makes splendid meal. Produces better crops on average land than most any other variety. **Qt., 20c. Pk., \$1.25. Bu., \$4.00.**

**BOONE COUNTY WHITE.**—We believe this to be the best all around White Corn in existence. It is a heavy yielder; has large ears, deep grain, small cob and produces good-sized fodder, free from barren stalks. Matures in 110 to 115 days. **Prices: Qt., 20c. Pk., \$1.25. Bu., \$4.00.**

**HICKORY KING WHITE CORN.**—Produces very large broad, flat, white dent grains, which are closely placed on a very slender cob. **Qt., 20c. Pk., \$1.25. Bu., \$4.00.**

**90-DAY CORN (White with Red Cob).**—This is an elegant corn for truckers and market gardeners, as it is as good a seller as green corn. Is suitable for either early or late crop. **Qt., 20c. Pk., \$1.25. Bu., \$4.00.**

**WHITE ENSILAGE CORN.**—Specially adapted for ensilage. **Bushel, \$4.00.**

**POPCORN POPPERS.**—35c. each.

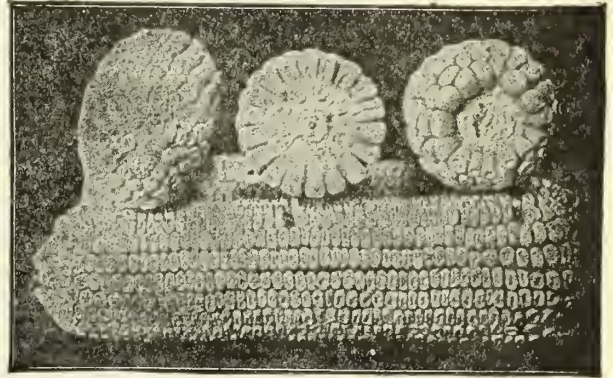

Maryland White Dent Corn.

**JOHNSON COUNTY WHITE CORN.**  
A favorite white corn in the Western Corn Belt. Ears are a little longer than the Boone Co. White, but about the same diameter. Good, deep grain on small, white cobs, and not quite so indented as the Boone Co. It will shell from six to seven bushels per barrel.

We recommend it as a fine general main crop sort. Will mature in about 120 days. Has abundant foliage, which makes it also valuable for ensilage purposes.

**Quart, 20c. Peck, \$1.25. Bushel, \$4.00.**

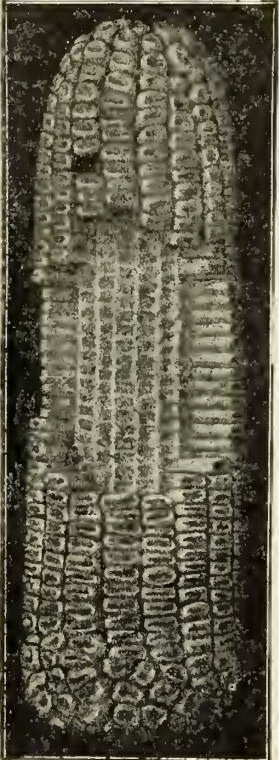

Boone County White Corn.

## SEED OATS

**IMPROVED WHITE TARTAR.**

The most remarkable Oats now under cultivation. Our customers say they will sow no others. These grand Oats outyield all others. The very best for all-round purposes. Greatest yielding variety in existence and rust-proof. Succeeds well on all soils. Straw is of golden yellow color, while the grains are white, with a slight golden cast. Withstands stormy weather. A measured bushel weighs from 36 to 42 lbs. Would highly recommend these Oats to all our customers. Change your seed this season. **Bushel of 32 lbs.** Write for price.

## WHITE SEED OATS

For spring sowing. 32 pounds to the bushel. Extra heavy fancy White Oats. Ask for prices.

## WINTER TURF OATS

Perfectly hardy in the Southern and Middle States, standing the winter nearly as well as wheat. Yields, on good land, from 50 to 70 bushels to the acre, of fine, heavy grain weighing from 30 to 40 pounds to the measured bushel. Furnishes excellent fall, winter and early spring grazing, without injury to the grain crop. Write for prices first of August.



WRITE FOR PRICES OF FIELD SEEDS IN QUANTITY.

## SEED WHEAT AND RYE

We can offer choice stocks of Seed Wheat and Rye, re-cleaned and at reasonable prices. Write us August 1 for special prices for fall sowing.

## SEED BUCKWHEAT

**JAPANESE.**—The best sort. The plants are large and vigorous, maturing their seed early and resisting drought and blight remarkably well, while the grain is much larger and at the same time has a thinner hull than the common or the Silver Hull. Owing to its branching character, only one-half the seed is required per acre, while the straw is much stiffer and stands up better. We recommend this especially for well-drained or sandy land and the dry climate of the Western plains. **Peck, 75c.**

**SILVER HULL.**—Same price as above.

## BARLEY

**BEARDLESS FALL BARLEY.**—A fall variety without beards. Ask for prices.

**BEARDED FALL BARLEY.**—A heavy yielder, much better than spring sown. Sow in September for best results. **Ask for prices.**

## HIGH-GRADE GRASS SEEDS

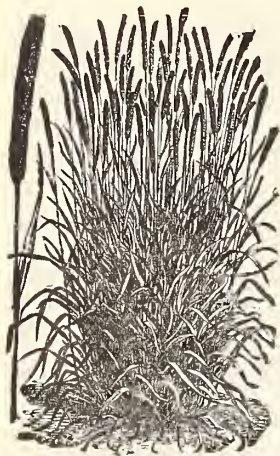

TIMOTHY.

**TIMOTHY (Phleum pratense.)**

This makes one of the most popular, nutritious and salable of hay grasses. It is best adapted for sowing on clay or heavy loams, low lands or in mountainous districts, although it will do well on any good stiff loamy soils, provided moisture is abundant. It does not succeed nearly as well, however, as Orchard, Tall Meadow Oat or Herd's Grass on soils of a sandy or light loamy texture, and is not of as much value for pasturage as other grasses. The stand of Timothy will also be injured if grazed or cut too closely. The yield of hay on good ground is from one and a half to three tons per acre. The best clover to sow with timothy is either the Sapling or Alsike, as they mature and ripen with timothy. **Found, 15c. Peck, \$1.25. Bushel of 45 lbs., \$4.75.**

**RED TOP, OR HERD'S GRASS (Agrostis vulgaris).**

This grass makes excellent pasturage and good crop of fine quality hay, and succeeds on a greater variety of soils than any other grass in general use, giving very good results on light soils and the very best results on heavier, moist or low ground soils. It is rather late in starting in the spring and matures its crop at the same time as Timothy. Is excellently adapted for seeding with Timothy for hay, and furnishes excellent pasturage afterwards. When it gets well established it will gradually supplant other grasses. The grades of seed usually sold are:

**CHAFF RED TOP.**—Seed in chaff Sow 4 to 6 bushels to the acre, 10 lbs. to bushel. **Price, 60c. bushel.**

**UNHULLED RED TOP.**—Seed in hull, but free of chaff and impurities. Sow 2 to 3 bushels to the acre; 14 lbs. to the bushel. **Price, lb., 15c.; bus., \$2.25; 100 lbs., 14c. lb.**

**FANCY CLEANED RED TOP.**—Hulled seed, free from all impurities. We would advise our customers to sow the Extra Cleaned Unhulled or Fancy Cleaned seed.

**Fancy Cleaned Red Top.**—Sow 12 to 15 lbs. to the acre. **Price, 25c. lb. \$20.00 per 100 lbs. Bushel of 32 lbs., \$6.40**

**RHODE ISLAND BENT GRASS (Agrostis canina).**—A very fine variety for lawns. **Lb., 60c.**



RED TOP GRASS.

**SHEEP FESCUE (Festuca ovina).**—It is a densely tufted perennial grass for dry, sandy and rocky soil where scarcely any other species will grow. It roots deeply, and forms a dense, short tuft, suitable for lawns and pleasure grounds where the soil is sandy. It affords wholesome food for all cattle, especially sheep. Specially recommended for pasturage mixtures. Sow about 30 pounds per acre. **Lb., 30c. Bushel of 12 lbs., \$3.50.**

**ITALIAN RYE GRASS.**—Is an annual, and should be sown every year at the rate of 50 pounds per acre. It can be sown during August, September or October. It should be mown as early as the blossoms appear, or the hay will not be so good, and it can be cut every month from early spring if the soil and weather are suitable. **Bus., 20 Lbs. Lb., 20c. 10 Lbs., \$1.50. Per 100 lbs., \$11.00.**

**ENGLISH RYE GRASS (Lolium perenne).**—This makes a quick growth very early in the spring, and is adapted for cool, moist locations. 24 lbs. to the bushel; 60 lbs. to the acre. **Lb., 20c. Bushel, \$3.00.**

**CRESTED DOG'S TAIL (Cynosurus cristatus).**—Should enter in moderate quantity in permanent pasture mixtures, and in larger quantities for lawns, as it possesses in a marked degree all the desirable features of a good lawn grass. 21 lbs. to bushel. **Lb., 60c. 10 lbs., \$5.00.**

**WOOD MEADOW (Poa nemoralis).**—An early nutritive grass; thrives better under trees than other grasses. Is also an excellent pasture grass. **Lb., —. 14 lbs. to bushel.**

**SWEET VERNAL (Anthoxanthum odoratum).**—True perennial; emits an agreeable odor, which it imparts to the hay. **Lb., —.**

**KENTUCKY BLUE GRASS.**—It is rather sensitive to heat, but not so to cold weather, and on this account does its best in the fall, winter and spring. It grows slowly at first, forms a very compact turf, making a fine pasturage when once established. It is much the best, however, to combine other grasses with it for either lawn or pasturage. Sow in the spring or fall. **Fancy, triple-cleaned. Per lb., 40c. Bus. of 14 lbs., \$5.00**

**ORCHARD GRASS (Dactylis glomerata).**—One of the best and most reliable grasses for the Middle and Southern States, either for hay or pasturage. It succeeds well on nearly all soils, but does best on upland, loamy or moderately stiff soils. It starts early in the spring and continues well into winter. It is of quick growth and relished by stock, especially when young, and bears close grazing. It makes excellent hay, and gives the very best results mixed and grown with Tall Meadow Oat Grass and Red Clover, as suggested under the head of Tall Meadow Oat Grass. It should be cut when in blossom, as the hay is injured if the seed is allowed to ripen. It can be sown in the spring or fall either with grain or alone. Sow 3 bushels per acre if sown alone, or with Red Clover, one and one-half bushels of Orchard and seven pounds of Clover are the quantities usually sown. **Price, 25c. lb. Bus. of 14 lbs., \$3.50.**

**TALL MEADOW OAT GRASS (Avena elatior).**

—Most valuable for pastures on account of its early and luxuriant growth; it produces an abundant supply of foliage, which is relished by cattle, early and late. For hay it may be cut twice a year, and for green soiling it may be cut four or five times in favorable seasons. It is very hardy and withstands extreme drought and heat and cold. Height, 2 to 4 feet. 50 pounds to the acre. (10 pounds to bushel.) **Lb., 40c. 100 lbs., \$35.00.**

**CREeping BENT GRASS (Agrostis stolonifera).**—Excellent for lawns; succeeds well in all conditions; makes a low, velvety growth. **Lb., \$1.00. Bus. (20 lbs.), —.**

**MEADOW FOXTAIL (Alopecurus pratensis).**—Closely resembles Timothy in growth, but has a soft, feathery head. It is a valuable pasture grass by reason of its rapid growth. About 7 pounds to the bushel; 3 bushels to the acre. **Lb., 75c. Bushel, —.**

**MEADOW FESCUE, RANDALL, or ENGLISH BLUE GRASS (Festuca pratensis).**

—This should be very much more largely used than at present. It makes a very good hay and pasture grass, and is particularly valuable for fall and winter pasturage, as it remains green throughout the winter. It is very popular in Southwest Virginia, East Tennessee and the Mountainous districts of North Carolina, where it is very highly appreciated as a large-yielding, nutritious pasture and hay grass. It succeeds well in nearly all sections of the South, and should be very largely used in pasture and hay mixtures, being specially suitable for sowing with Red Top and Timothy for hay, or with these and Orchard and Tall Meadow Oat for permanent pasturage. Sow either in the spring or fall at the rate of 50 pounds to the acre. Thrives better under trees than other grasses. 22 lbs. to bus. **Lb., 25c. 100 lbs., \$20.00.**

**AWNLESS BROME GRASS (Bromus inermis).**—Comparatively a new grass in this country, but in Hungary (Europe), its principal home, it is the chief meadow grass of the sandy moorlands. It grows coarse, resembling Orchard Grass; prefers light, dry soil. It roots deeply, and stands protracted droughts well, and will thrive upon soils too poor and dry to grow anything else but broom sedge; hence is valuable for such situations, both for grazing and hay, and especially in mixtures with other grasses. It has, however, been talked up very much in the agricultural press, especially in the West, and is worthy of extended trial. Sow at the rate of from 35 to 40 pounds per acre when sown by itself, either in the spring or fall. **Lb., —. Bushel of 14 lbs., —.**



KENTUCKY BLUE GRASS.



ORCHARD GRASS.

## Grass Mixture for Hay and Permanent pastures

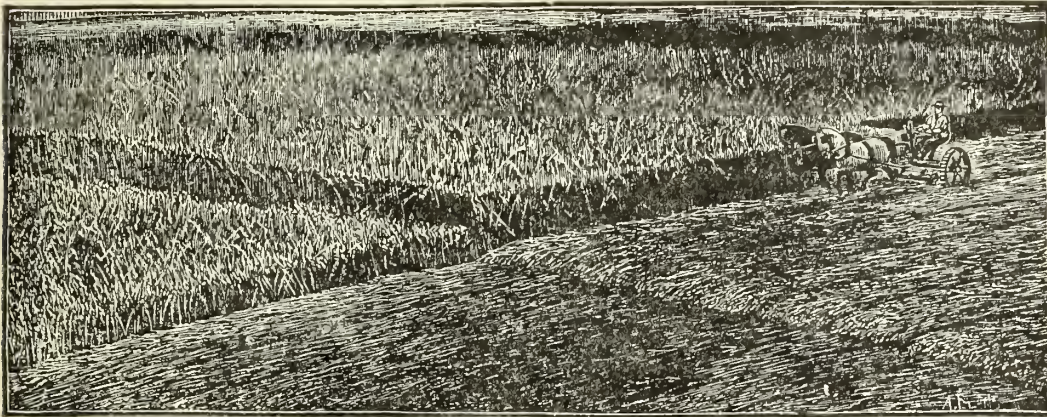

Prepared especially to meet the demand for a mixture that will be desirable for cutting for Hay or to use for Pasture, and contains such grasses as are best adapted for these purposes. In ordering, please state whether you want a mixture for upland or low ground.

**MIXTURE FOR UPLAND.**—14 lbs. to the bushel, 3 bushels to the acre. Per bushel, \$4.50; 10 bushels for \$42.50.  
**MIXTURE FOR LOWLAND.**—14 lbs. to the bushel, 3 bushels to the acre. Per bushel, \$4.50; 10 bushels for \$42.50.

## Grass and Clover Seed Mixtures, for Mowing the Hay, But Can Be Grazed

We have in the following mixtures combined grasses suitable for the various soils for which they are recommended. They are composed of grasses which will give an even growth for mowing for hay. We have also combined them so as to give a splendid pasture from early spring until late fall if desired. The different mixtures are prepared from seeds of the finest quality, and only those are used best adapted to the soils and situation for which they are intended.  
**MIXTURE No. 1.**—For Moist Bottom Lands. Sow 25 lbs. to the acre. Price, Lb., 35c. 10 lbs. and over, 30c. per lb.  
**MIXTURE No. 2.**—For Light, Dry, Gravelly or Sandy Soils. Sow 35 lbs. to the acre. Price, Lb., 35c. 10 lbs. and over, 30c. per pound.

# CLOVERS



ALSIKE CLOVER.



CRIMSON CLOVER.



WHITE CLOVER.



RED CLOVER.



LUCERNE OR ALFALFA CLOVER.

**RECLEANED RED CLOVER.**—We take great pains to supply an extra quality of Red Clover at a reasonable price. Farmers should not sow a poor quality of Clover Seed. We have however, cheaper grades for those who wish them. 40c. lb.

Ask for prices in large quantities.

**ALSIKE OR SWEDISH CLOVER.**—Hardest of all the Clovers, and on rich, moist soils yields an enormous quantity of hay or pasturage. Valuable for sowing with other Clovers or grasses, as it forms a thick bottom and increases the yield of hay. Sow, either fall or spring, 6 pounds per acre when used alone. Lb., 25c.

Ask for prices in quantity.

**WHITE DUTCH CLOVER.**—Thrives most everywhere. The best to sow with lawn grass and valuable to sow with blue grass for permanent pastures. ¼ lb., 25c. ½ lb., 40c. 1 lb., 80c. By mail, lb., 90c. 10 lbs., by express, not prepaid, \$8.00.

**LUCERNE OR ALFALFA CLOVER.**—One of the most valuable among Clovers, resisting drought and remaining green when other sorts are dried up. Sow on rich, moist loam or sandy soil. Prepare the land thoroughly and sow, either fall or spring, 20 pounds to the acre. Lb., 30c.

Special prices in large quantities on application.

**CRIMSON CLOVER (The Great Nitrogen Gatherer).**—The best crop for hay, silage and green manuring—all winter and spring pasturage. For hay it must be cut before it comes into full bloom, as otherwise it may cause hair-balls to form in the animal's stomach. It is used on poor and rich land. It is seeded in this country in June, July, August, September and October, and will produce an enormous crop early in the following spring, suitable either for consumption as green food or for hay. 15 to 20 pounds should be sown to the acre, according to the quality of the ground. 15c. per lb. Write for prices in quantity.

WRITE FOR SPECIAL PRICES ON ABOVE.

ALL PRICES IN CATALOG SUBJECT TO CHANGE WITHOUT NOTICE.

## LAWN GRASS SEED

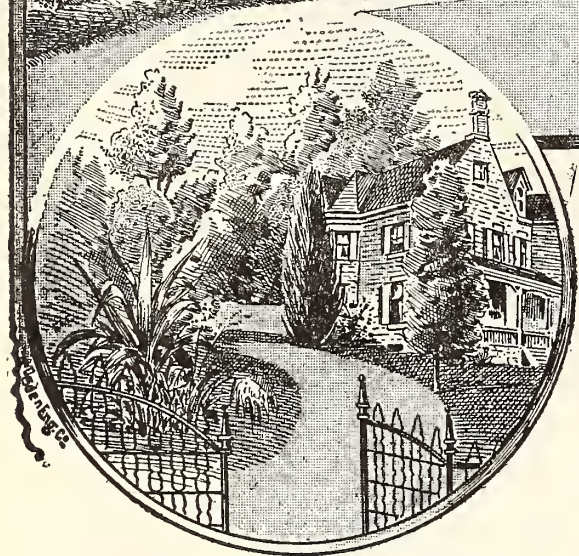
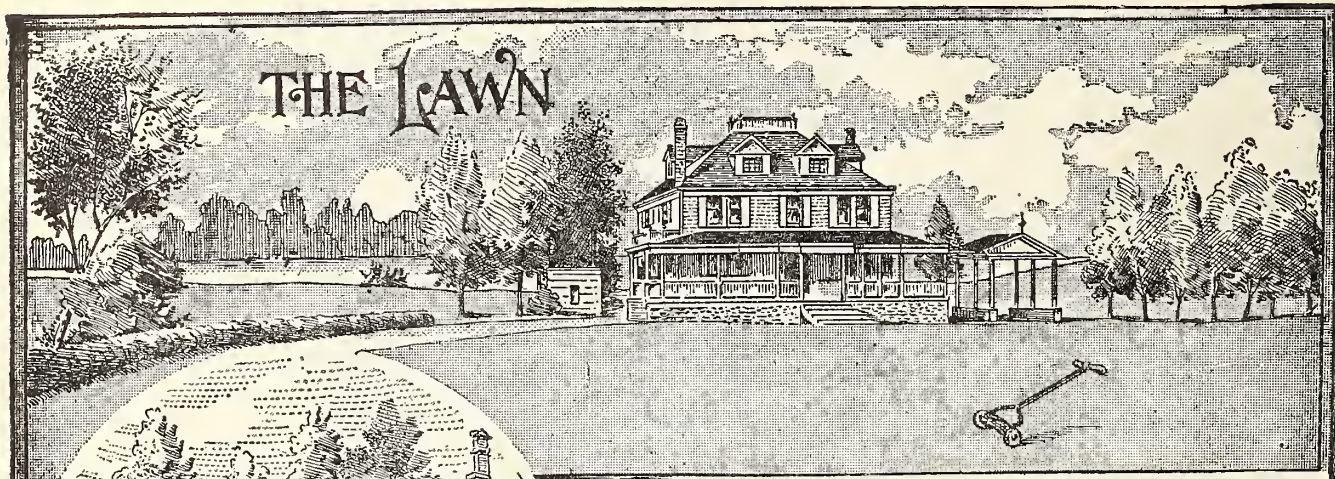

## PREPARATION AND CARE OF LAWNS

**T**HE ground should be thoroughly drained and well enriched before sowing. Work the soil until well pulverized, and have the surface as smooth as possible, so that the grass may present an even appearance. After sowing, cover seed lightly and follow with roller. The best results are obtained by using plenty of seed, four bushels to the acre being about the right quantity. One quart is sufficient for 300 square feet. Let the grass obtain a good start before cutting, and then it should be trimmed with a lawn-mower about every ten days. Old lawns may be improved and renewed by the application of fertilizers and seeding about half the quantity of seed required for new lawns. This should be done whenever they show any thin places.

## GRIFFITH & TURNER CO.'S EVERGREEN LAWN GRASS

This is a first-class mixture prepared by ourselves, and containing nothing but choice seeds—just the thing for tennis, croquet and ball grounds, remaining green and fresh during the hot summer months. Widely known and extensively used on the finest private and public grounds around Baltimore, Washington and elsewhere with the most satisfactory results. Nothing adds to the attractiveness of suburban homes more than a well-kept, closely-cut, velvety lawn; hence the importance of securing the best seeds. This we offer to the attractiveness of suburban homes more than a well-kept, closely-cut, velvety lawn; hence the importance of securing the best seeds. This we offer

in our selected Evergreen-Lawn Mixture, containing different varieties that grow and flourish at different months of the year, so that a rich, green, velvety lawn is constantly maintained. It is adapted to the small grass plots of city homes. **Pint, 20c. Quart, 30c.; by mail, 35c. 1/2-Peck, 90c. Peck, \$1.75. Bushel of 20 pounds, \$7.00. By freight or express not prepaid.**

### PARK LAWN GRASS

This mixture does not contain so much of the high-priced grasses as our Evergreen Lawn Grass, but it is superior to many of the cheap grades offered, and will make a very nice lawn. **Quart, 30c. Peck, \$1.50. Bushel of 16 Pounds, \$6.00.**

### GRIFFITH & TURNER CO.'S GOLF LINK MIXTURE

There being a growing demand for a grass mixture suitable for golf and cricket grounds, we have made a study of the grasses best adapted to these purposes, and have been mixed in proper proportions to give desired results. Many of the public and private grounds around Baltimore and other places have been sown with our mixtures, and the grounds have won the admiration of thousands of visitors. It is highly essential that golf and cricket grounds should be mowed closer than ordinary lawns. **14 pounds to bushel. Bushel, \$7.00. 10-Bushel Lots, \$6.50 Bushel.**

### SHADY NOOK GRASS

On nearly all lawns there are bare spots under the shade of trees. With this mixture the above can easily be corrected. It is a combination of grasses which are found growing in the woods in their natural state. Ground that has been densely shaded by trees is frequently "sour" and is apt to be covered with moss. In such cases apply slacked lime at the rate of one bushel per thousand square feet, but the moss should be first removed with a rake. **Price: Lb., 35c. 5 lbs., \$1.75. Bu. of 20 lbs., \$7.00. Add 8c. per lb. for postage.**

### "TERRACE" SOD MIXTURE

A special mixture of grasses best suited for sowing on terraces, railroad embankments and side hills—grasses that produce strong, spreading roots, thus preventing heavy rains from washing them out; that will withstand drought and exposure, thrive on shallow soils, and at the same time produce a rich, velvety green turf throughout the season. **Qt., 60c. Peck, \$2.40. Bushel of 20 lbs., \$10.00.**

### WHITE DUTCH CLOVER TRIFOLIUM REPENS

The best variety for lawns, as it forms a close herbage and remains green throughout the season. It is also valuable when mixed with grass seeds for pasture. Sow in spring at the rate of 6 pounds per acre when sown alone; half the quantity when sown with other grasses. **Pound, 80c. By mail, 90c. 10 pounds, by express, not prepaid, \$3.00.**



## FORAGE AND SILO SEEDS

SHOULD BE SOWN IN THIS LATITUDE, NOT BEFORE MAY 15th, AS THE SEED WILL NOT STAND COOL, WET WEATHER.

### COW PEAS



COW PEAS

The great soil enricher. Makes poor land rich and good land better. They also make good green forage for ensilage, and the best quality of Hay when cut and cured.

The sowing of **COW PEAS** is one of the cheapest as well as the best means of improving the soil. They can be turned down for green manuring, or, if allowed to ripen, cut Peas off and cure for hay; turn down roots, which will give as good results as when whole plant is used. For ensilage they are unsurpassed, being more nutritious than green corn, but when used for this purpose, would advise sowing Sugar Cane or Sorghum in connection with them. The two combined will make one of the very richest feeds. Ask for prices.

**BLACK**—This is the standard variety, and the one most largely grown in this immediate section. It is very prolific, makes a fine growth, both of vine and leaves, and a good yield of peas. It is a splendid land improver, and most valuable as a forage crop, and makes an enormous yield of rich, nutritious feed.

**WHIPPOWILL**—A favorite, early, upright-growing variety, more largely used and sold than any other kind. Has brown speckled seed, which are easily gathered. Makes a good growth of vine, which can be easily cut and cured as dry forage. We recommend this where an early variety of good growth and height is desired.

**WONDERFUL, OR UNKNOWN**—This makes an enormous and remarkable growth of vines, but requires the full growing season to make its crop. In yield and growth of vines it surpasses any of the varieties of Cow Peas, and it produces very largely of the shelled peas. This variety should be planted in May in order to come to full maturity.

**NEW ERA**—An early maturing variety which has proved very popular and satisfactory. It is upright growing, quick to mature, and remarkably prolific of peas. Rather small vine, which cures easily, making splendid dry forage. The seed are smaller in size than the ordinary cow pea, so that it does not require as much to seed an acre; from three-fourths to one bushel per acre will give ample seeding. **PRICES ON APPLICATION.**

### SORGHUM, OR SUGAR CANE, FOR FODDER

**EARLY AMBER** grows 10 to 12 feet high, and yields large crops of fodder, which is relished by all kinds of stock. It will produce two cuttings during the summer. Sow 3 or 4 quarts per acre in drills and cultivate same as corn. For hay, sow one bushel per acre broadcast. **Pound, 10c. Peck, ———.**

**EARLY ORANGE** has a large, strong growth, but requires longer time to mature than the Early Amber. Very popular in the South, where there are long seasons. **Prices same as Early Amber.**



EARLY AMBER CANE

### SOJA BEANS

The great drought-resisting forage crop; unsurpassed in nutritive value for feeding; also makes a splendid soil improver. Sow broadcast one-half bushel to the acre, or it may be planted in drills three feet apart and one foot between plants. Price on application.

### MAMMOTH YELLOW SOJAS

The largest-growing and most popular of soja beans for forage purposes. A little later in maturity than other kinds, but makes larger yields, both of forage and seed. Especially valuable for the South.

### HOLLYBROOK EARLY SOJAS

Makes a quicker growth and matures their crop two to three weeks earlier than the mammoth Yellow Soja. It makes a large yield, both of forage and peas, and the added advantage of its earliness makes it a most distinct and valuable acquisition. It is a sure cropper and a vigorous, quick-growing variety. Sown as a forage or hay crop, it is much easier to cure and handle, and makes even a more nutritious crop than cow-peas.

### WILSON BLACK SOJAS

One of the best, in our opinion, for the Northern States, where a quick, early variety is desired. Average height on good land is 2½ to 3 feet. A prolific variety, and requires about 90 days to be ready to cut for hay.

### KAFFIR CORN

The heads contain small white seeds, which make an excellent flour. They are greedily eaten by horses and cattle, and make fine feed for poultry, either fed in the grain or ground and cooked. Use 4 to 5 lbs. to acre.



GENUINE KAFFIR CORN



SOJA BEANS

ASK FOR QUOTATIONS ON ABOVE.



GERMAN MILLET.

## GERMAN MILLET

**GERMAN MILLET.**—A fine, quick-growing summer Hay crop. Produces splendid crops of fine nutritious hay. Grows quickly and easily cured. Should be sown thick, not less than one bushel per acre. Cut while in flower. Do not wait until seed becomes hard in head. If allowed to get too ripe stalks get hard and do not make as good quality of hay as when cut at proper time. It should be sown any time after middle of May up to first of August. Should not be sown too early, as seed will not germinate until soil and weather is warm. A crop will mature in seven to eight weeks in ordinary warm growing weather. **Price, Lb., 10c. Peck, \_\_\_\_\_.** Ask for price by the bushel.

## HUNGARIAN MILLET

**HUNGARIAN MILLET** is of the same family as German Millet, but is not used as extensively, as it requires stronger soil. However, it makes a very fine quality of hay, and like German Millet is fairly good substitute for Timothy. Hungarian Millet can be sown at the same time as German. **Price, Lb., 10c. Peck, \_\_\_\_\_.** Ask for price by bushel.

## CANADA FIELD PEAS

Sown in February, March or April, with a small quantity of oats, they make large yield of forage. Sow 1 to 1½ bushels per acre broadcast with half bushel of oats. Cut for hay before the peas mature.

Write for Special prices if a quantity is required.

## BROOM CORN

**50 Pounds to Bushel.**

To grow Broom Corn successfully the ground should be rich and well prepared. Plant seeds in rows 3 feet apart by 18 inches. The plants should be cultivated as soon as they are out of the ground. Harvesting should be done when the seed is in a soft, milky condition.

**IMPROVED EVERGREEN.**—This is the favorite sort; has a fine brush, yields well and keeps green. Height, 8 to 9 feet. **Lb., 30c. postpaid. 10 lbs. @ 25c. lb.**

## RUSSIAN SUNFLOWER

Growing to double the size of the common sunflower and the yield of seed is twice as great. It is highly recommended for poultry—the best egg-producing food known. **Lb., 15c.**

## DWARF ESSEX RAPE

It can be sown all through the season; being perfectly hardy, withstands the drought, and will produce a crop in any soil by sowing broadcast at the rate of 5 lbs. to the acre, or 2 to 3 lbs. in drills. It is unequaled as a pasture for sheep, and as a fattening food for all kinds of live stock it is without a rival. **Lb., 15c.;** by express, 10 lbs. and over, **10c. lb.,** not prepaid; **\$9.00 per 100 lbs.** If wanted by mail, add 8 cents for postage.



VETCHES.

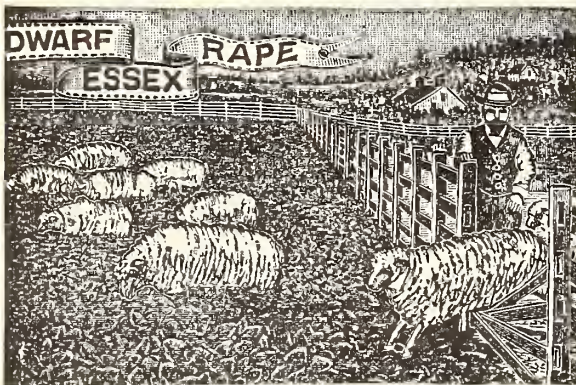

## VETCHES OR TARES

**SPRING VETCHES (*vicia sativa*).**—Closely associated with peas in character. Highly valuable for soiling or for green manuring. Sometimes grown with oats for mowing and feeding to stock. Use 40 to 60 lbs. to the acre. Sow in spring while ground is cool and moist, or in early autumn. **Pound, 11c. Peck of 15 Pounds, \_\_\_\_\_.**

**WINTER VETCHES (*Vicia villosa*).**—Also called Sand Vetch or Hairy Vetch. Recommended for fall sowing with rye, as in many localities in the North it is hardy, remaining green all winter. A valuable food for stock in early spring. Use 30 to 50 lbs. per acre. **Pound, 25c.**

## TEOSINTE

A most valuable and enormous-yielding cutting forage crop, but should be planted very early to succeed well. Good to use as green food, and also makes an excellent fodder. It branches as many as 50 stalks from one seed. Plant in May or June in rows 4 to 5 feet apart each way. **Oz., 10c. ¼ lb., 35c. Lb., \$1.25, postpaid.**

**FLAXSEED.**—Lb., 15c. 3 lbs., 40c.

**PRICES SUBJECT TO CHANGE. ASK FOR QUOTATIONS ON QUANTITIES.**

FLOWER SEEDS

ORDER BY NUMBERS

GENERAL DIRECTIONS FOR CULTIVATION.

Hardy Flower Seeds should be sown in the open, after danger of frost is past, in well-worked and moist soil. Seeds of medium size, put at depth of one-quarter to one-half inch. Very fine seeds, press into the soil, and cover slightly with a little sand or sphagnum moss. If seed is not deep, water frequently. When up, transplant from two to twelve inches apart, according to variety of plants. Do not leave too thick, as the plants will be weak and spindling. Keep weeds out of the flower beds. Annuals may be planted in early spring, and bloom the first season only. Biennials bloom the second year from seed and then die. Perennials bloom the second year from seed, and plants live to bloom during successive years.

Varieties marked ("A") stand for Annuals. Marked ("B") Biennials. Marked ("P") Perennials.



- 33. **SEMPLER'S BRANCHING ASTER, MIXED (A).**—A choice strain of American-grown Asters, which has, by careful selection, been brought to a high degree of excellence. **Packet, 10 cents.**
- 34. **BRANCHING ASTER (A) (White).**—Very choice. **Packet, 10 cents.**
- 35. **BACHELOR'S BUTTON, or BLUE BOTTLE (A) (Centaurea Cyanus).**—A very old favorite garden annual, with handsome flowers of various colors. It does best if sown in a hot-bed; half-hardy annuals; two feet. **Packet, 5 cents.**
- 40. **DOUBLE BALSAMS, CAMELIA FLOWERED (A) (Lady Slipper, or Forget-Me-Not).**—The well-known Balsams are one of the finest summer blooming annuals, free bloomers and highly colored. By transplanting them once or twice, the flowers are apt to be more double. **Packet, 5 cents.**
- 41. **BALSAM, PERFECTION WHITE (A).**—This resembles the mixed Balsams in shape, but the flowers are of a pure white, and is the variety usually grown by florists. **Packet, 10 cents.**
- 45. **CANDYTUFT, MIXED (A).**—Well-known favorite, hardy annuals; very pretty in beds or masses; useful for bouquets. Seeds may be sown in the fall for early flowering. **Packet, 5 cents.**
- 46. **CANDYTUFT, WHITE (A).**—Treated and used same as the mixed. **Packet, 5 cents.**
- 53. **CALENDULA, DOUBLE (A).**—Very profuse dwarf bushy annuals, blooming continuously and profusely until frost; of easy culture, and suitable for summer garden or for growing in pots in winter. **Packet, 5 cents.**
- 55. **CANNA, MIXED (Extra Choice) (A).**—The Cannas are desirable not only for the beauty of their spikes of scarlet flowers, but for their highly ornamental leaves. They make superb beds for the lawn. Soak the seeds thoroughly before planting, and keep in a warm spot. Very slow to germinate. **Packet, 5 cents.**
- 60. **CANTERBURY BELLS, SINGLE MIXED (Campanula) (A).**—A highly attractive class of plants, combining richness of color with stately growth; valuable for beds and borders. Sow early and transplant in light, rich soil. **Packet, 5 cents.**
- 61. **CANTERBURY BELLS, DOUBLE MIXED (P).** **Packet 5 cents**

- 1. **AGERATUM, MIXED (A).**—Suitable for beds, and especially nice for cut flowers and bouquets. **Packet, 5c.**
- 10. **ALYSSUM (A).**—The Sweet Alyssum has pretty little white flowers, useful in making small bouquets, and its fragrance, while sufficiently pronounced, is very delicate. The Alyssum grows freely from seed, blooms the whole season. **Packet, 5c.**
- 11. **ALYSSUM (A) (Tom Thumb).**—Of dwarf, compact habit, each plant covering a circle from 15 to 30 inches. It will bloom when small and remain covered with bloom from spring to autumn. **Packet, 5c.**
- 20. **AMARANTHUS, MIXED (A).**—Showy blooming plants, with long racemes of curious looking flowers and brilliant foliage; half hardy annuals. **Packet, 5 cents.**
- 21. **AMARANTHUS, TRI-COLOR (Joseph's Coat) (A).**—Red, Yellow and Green foliage; 2 feet. **Packet, 5c.**
- 22. **AMARANTHUS CAUDATUS (Love Lies Bleeding) (A).**—Graceful and handsome flowers of blood-red hue. **Packet, 5 cents.**
- 24. **ANTIRRHINUM, DOUBLE MIXED (P).**—One of the most useful and showy border plants. The recently improved varieties have large, finely shaped flowers of brilliant colors. Perennial. **Packet, 5 cents.**

ASTERS

Sow seed in March and April in cold-frame or boxes in the house, covering them ¼ inch deep, and when plants have three or four leaves transplant about 18 inches apart each way into well-prepared beds

- 25. **ASTERS, CHOICE (A).**—Choice mixed varieties. Well-known and beautiful flowers; should be in every garden. **Packet, 5 cents.**
- 27. **ASTER, TRUFFAUT'S PERFECTION (A).**—A very favorite class; thrifty, upright growers; flowers large, almost perfectly round, with incurved petals. **Packet, 10 cents.**
- 30. **VICTORIA ASTER (A).**—The most beautiful of all Asters, bearing flowers of all colors and shades; the colors include many extremely delicate and gorgeous shades. Very double and four inches across; height, 15 to 18 inches. **Packet, 10 cents.**
- 31. **COMET ASTER (A).**—This class of Asters has long, slender and curled petals, forming loose yet dense flowers of semi-globe shape, 3½ to 4½ inches in diameter, which resemble the Japanese Chrysanthemum. **Packet, 10 cents.**

- 68. **CENTAUREA CANDIDISSIMA.**—Silver white; leaves broadly cut. **Packet, 5 cents.**
- 70. **CHRYSANTHEMUMS, SINGLE, MIXED (A).**—Showy and effective garden favorites extensively grown for cut flowers. The hardy annuals are summer flowering border plants; good for pot culture and quite distinct from the autumn flowering varieties. **Packet, 5 cents.**
- 71. **CHRYSANTHEMUMS FRUTESCENS (A).**—(The Marguerite, or Paris Daisy).—Immense quantities are grown by French florists, and find a ready sale. It produces freely its white, star-like flowers under the most favorable conditions. **Packet, 10 cents.**
- 76. **CINERARIA HYBRIDA (P).**—Large flowering prize varieties; very attractive, free blooming plants, producing large and brilliant flowers. **Packet, 25 cents.**
- 77. **CINERARIA HYBRIDA DWARF (P).**—Large flowered, dwarf prize varieties; splendid strain. **Packet, 25 cents.**

## FLOWER SEEDS THAT GROW

80. **CLARKIA, MIXED (A).**—An old favorite hardy annual plant, growing in any garden soil and producing freely its cheerful flowers early in the season. Packet, 5c.
85. **COCKSCOMB (Celosia Cristata) (A).**—Very popular annuals of the easiest culture, highly ornamental for decoration of the greenhouse, drawing-room and garden. Half-hardy annuals. Packet, 5c.
86. **COCKSCOMBS, GLASGOW PRIZE (A).**—Immense, showy, dark crimson combs. Pkt., 10c.
88. **COWSLIP (P).**—Beautiful hardy spring flowers of different colors. Packet, 10c.
90. **CONVOLVULUS, TRI-COLOR MINOR (Dwarf Morning Glory) (A).**—A beautiful class of hardy annuals, affording a large, showy mass of flowers from July to October. Packet, 5c.
93. **COREOPSIS (Calliopsis) (P).**—Very handsome and showy plants, with numerous flowers of brilliant colors, and of long duration in bloom. Packet, 5c.
- 93a. **COREOPSIS LANCEOLATA (P).**—IMPROVED (California Sunbeams).—This is one of the finest of hardy plants, with large, showy, bright golden-yellow flowers, freely produced on long stalks, from June till frost; excellent for cutting; will thrive in almost any situation. Pkt., 5c.

## COSMOS

**COSMOS.** One of the very finest late summer and fall flowers; excellent cut flowers. The bushes grow tall, six to eight feet, and are loaded with large showy blossoms, in white, pink or crimson. Cosmos should be in every garden. Sow the seed early and transplant, or later in spring where it is to remain. Hardy annual.

94. **Early Flowering Dawn (A).**—White, slightly tinted with pink. Packet, 10c.
95. **COSMOS, Mixed (A).**—Pkt., 5c. Oz., 25c.
- 95a. **COSMOS, Pink (A).**—Pkt., 5c.
- 95b. **COSMOS, White (A).**—Pkt., 5 cents.
- 95c. **COSMOS, Crimson (A).**—Packet, 5c.
- 95d. **NEW MARGUERITE COSMOS (A).**—One of the prettiest and daintiest varieties imaginable. Packet, 10c.
97. **DAISY, MIXED (P).**—Well-known favorites, admirably adapted for edgings, borders and low beds, and it is also suited for growing in pots. Although they are perennials, they will flower the same season if seed is sown early in the house. Packet, 10c.
98. **DAISY, LONGFELLOW (P).**—This is a very pretty, large, double pink variety. Pkt., 10c.
99. **DAISY, SNOWBALL (P).**—An unusually large-flowered variety, and produces very double, pure white flowers. Packet, 10c.
100. **DAHLIA, SINGLE MIXED (A).**—Large, showy single flowers. Packet, 5c.
- 100a. **DAHLIA, CACTUS (A).**—A most curious and desirable variety of many colors. Pkt., 5c.
103. **FEVERFEW (GOLDEN FEATHER) (Pyrethrum Aureum) (P).**—A highly ornamental golden-yellow foliage plant, unexcelled for bedding. Hardy perennial; 1½ feet. Packet, 5c.

105. **FORGET-ME-NOTS (Myosotis) (P).**—Neat and beautiful little plants, with star-like flowers, succeeding best in a shady, moist situation; half-hardy perennials; blooming the first year from seed, if sown early. Packet, 5c.
106. **FOXGLOVE (DIGITALIS) (P).**—A handsome and highly ornamental, hardy perennial plant of stately growth; fine for shrubberies and other half-hardy places. Packet, 5c.
107. **GERANIUM (New Zonale) (A).**—A grand strain of Geraniums, containing all shades of colors. Packet, 10c.
108. **GOSETIA—Finest Mixed (A).**—Fine, profuse blooming, hardy annuals. Packet, 5c.
109. **GAILLARDIA (A).**—Very attractive plants, producing a profusion of bloom the entire summer and autumn. Half-hardy annuals. Packet, 5c.
110. **GILIA MIXED (A).**—Very pretty dwarf plants, early, free blooming, fine for massing and rock work. Hardy annuals. Packet, 5c.
112. **HELIOTROPE (A).**—These are deliciously fragrant flowers, remaining in bloom a long time; fine for pot culture or bedding; half-hardy annuals. Pkt., 5c.

125. **MARIGOLD, DOUBLE AFRICAN (A).**—A well-known free-flowering plant, of easy culture, with rich and beautiful double various-colored flowers. Pkt., 5c.
126. **MARIGOLD, DOUBLE FRENCH (A).**—Of compact habit, with numerous bright, showy flowers. Very fine. Packet, 5c.
130. **MARVEL OF PERU, or FOUR O'CLOCK (Mirabilis Jalapa) (A).**—Very pretty annual of vigorous growth. The flowers are brilliant, singularly mixed and varied on the same plant. Two feet. Packet, 5c.
133. **MESEMBRYANTHEMUM CHRYSANTHEMUM (Ice Plant) (A).**—Dwarf spreading plants of great beauty, blooming the entire summer, succeeding best in dry, sandy or loamy soil, and in a warm locality. Half-hardy annuals. Pkt., 5c.
134. **MIMULUS**—The beautiful Monkey Flower. Packet, 5c.
- MIGNONETTE.**—The delightful fragrance of the Mignonette makes it a universal favorite. Sow seed in the fall for early blossoms in the spring. Valuable for potting, bedding or for border.

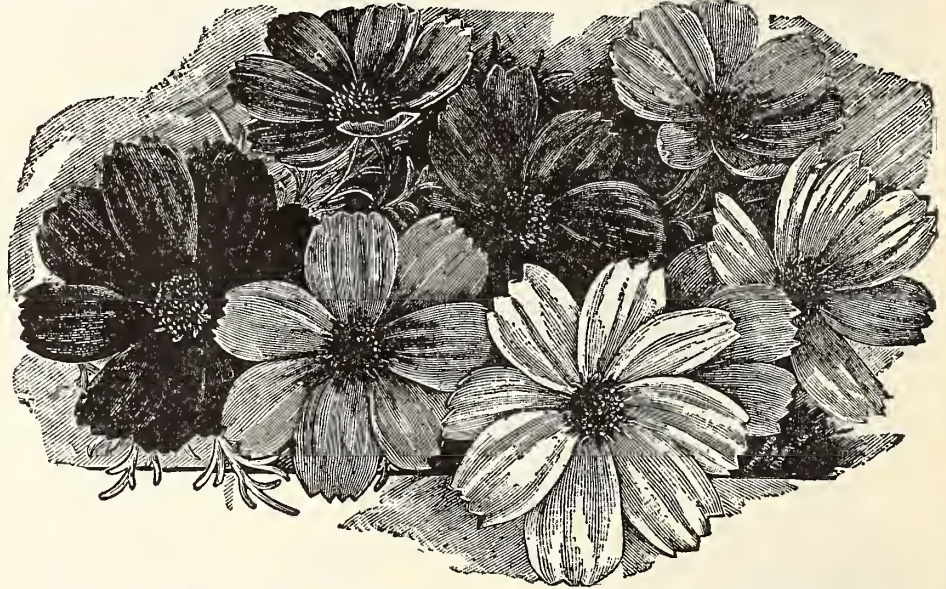

115. **HOLLYHOCK, CHATERS SUPERB MIXED (P).**—This is one of the oldest inhabitants of our gardens; now ranks as one of the finest autumn flowers. Pkt., 5c.
116. **HOLLYHOCK, CHATERS DOUBLE WHITE (P).**—Packet, 10c.
120. **LARKSPUR (Delphinium) (A).**—One of the most showy and useful plants, possessing almost every requisite for adornment of the garden. Packet, 5c.
121. **LARKSPUR EMPEROR (P).**—Of symmetrical bushy habit, with a profusion of brilliant dark-blue, red-striped and tri-colored flowers. Packet, 5c.

## LOBELIA

A beautiful and popular flower, very desirable for pot culture, beds or hanging baskets because of its trailing habits. Grows easily and does well in beds and rockeries. Bears a profusion of blue and white flowers.

122. **MIXED VARIETIES (A).**—Pkt., 5c.
123. **CRYSTAL PALACE COMPACTA (A).**—Rich deep blue. The finest for bedding. Packet, 10c.

**STIM-U-PLANT**—Makes a Wonder Garden.

135. **MIGNONETTE—SWEET (Reseda Odorata)**—A well-known and universal garden favorite, and one that requires no extra instructions for growing. Hardy annuals. Pkt., 5c. Oz., 15c.
136. **MIGNONETTE—PYRAMIDAL**—Large flowered. The largest flowered of all Mignonettes. Annual. Packet, 5c.
137. **MACHET**—True dwarf-growing variety; enormous spikes of beautiful, deep reddish crimson flowers; height 1 foot. Packet, 10c.
138. **MIGNONETTE VICTORIA (A).**—A splendid new, compact-growing variety of dense pyramidal, growing about six inches high. The flowers are of a brilliant red, and are suitable for pot or garden. Packet, 10c.
139. **ALLEN'S DEFIANCE (A).**—When grown under favorable conditions, and with proper care, spikes will not only be of remarkable size—from 12 to 15 inches long—but deliciously fragrant; much more so than any other variety. Packet, 10c.

## CHOICE FLOWER SEEDS

### NASTURTIIUM



- 142. **DWARF MIXED.**—The dwarf variety of Nasturtium is among the most useful and beautiful of annuals for bedding, massing, etc., owing to their compact growth, richness of color and profusion of bloom; mixed colors. **Packet, 5c. Oz., 10c.**
- 143. **DWARF NASTURTIIUM—AURORA.**—Blush white and salmon, blotched with garnet. **Packet, 5c. Oz., 15c.**
- 144. **DWARF NASTURTIIUM—BEAUTY.**—Bright scarlet, striped with yellow. **Packet, 5c. Oz., 15c.**
- 145. **DWARF NASTURTIIUM (Empress of India).**—Very dark foliage, with deep crimson flowers. **Packet, 5c. Oz., 15c.**
- 146. **DWARF NASTURTIIUM (Golden King).**—Brilliant yellow. **Packet, 5c. Oz., 15c.**
- 147. **DWARF NASTURTIIUM (King of Tom Thumb).**—Brilliant yellow flowers, blotched with maroon. **Packet, 5c. Oz., 15c.**
- 148. **DWARF NASTURTIIUM (Ruby King).**—Light ruby red. **Packet, 5c. Oz., 15c.**
- 149. **DWARF NASTURTIIUM (Cloth of Gold).**—Golden yellow foliage, light scarlet flowers. **Packet, 5c. Oz., 15c.**
- 150. **KING THEODORE—DWARF.**—Black-brown foliage. **Packet, 5c. Oz., 15c.**

**310. TALL NASTURTIIUM.**—Elegant, profuse flowering plants, constantly growing in favor for verandas, trellis, etc. The seed pods can be gathered while green and tender for pickling. **Packet, 5c. Oz., 10c.**

### OXALIS

**153.** Pretty little half-trailing annuals for hanging baskets. Mixed annual sorts. **Packet, 10c.**

### PANSIES---Annuals

Thrive best in a moist, shady location, and in rich, loamy soil. **Seed should be sown in the autumn** for early spring blossoms, or can be sown early in the year for good flowers late in the spring. The plants must be transplanted twice in order to get the largest flowers; once from the seed box to a chosen bed, and again to the open garden.

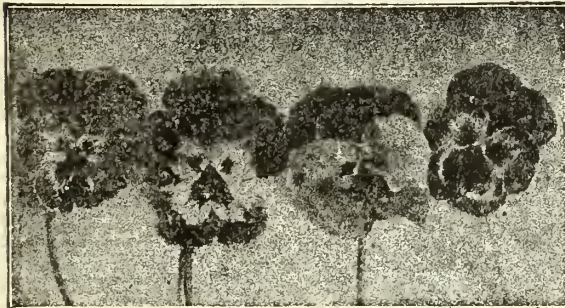

- 155. HEARTSEASE**—Mixed. An old but universally admired plant, producing an endless variety of color. They may be treated as annuals. **Packet, 5c.**
- 156. GIANT TRIMARDEAU**—Remarkable for the extra large size of the flower and an endless variety of beautiful shades. **Packet, 10c.**
- 157. G. & T. CO.'S EXTRA MIXED**—This mixture, containing the finest blotched varieties, is grown and selected with special care, and has given the most satisfactory results to both florists and amateurs in the past. **Packet, 15c.**

### PETUNIAS.



**PETUNIA.—**

Favorite, half-hardy, succeeding well in any rich soil. For the brilliancy and variety of the colors and the long duration of their blooming period, they are indispensable in any garden.

### Phlox Drummondii

- 175. PHLOX DRUMMONDII (A).**—A most brilliant and beautiful hardy annual, about one foot high, well adapted for bedding, making a dazzling show through the whole season. It succeeds well on almost any soil. **Pkt., 5c.**
- 176. PHLOX DRUMMONDII—(Nana Compacta) (A).**—Very fine mixed. This new strain is of dwarf, compact habit, and makes desirable pot plants; also excellent for ribbon lines and massing. **Packet, 10 cents.**
- 180. PINK CARNATION, or PICOTEE.** (Choicest Double Mixed *Dianthus Caryophyllus*).—Carnation and Picotee Pinks are generally favorites for their delicious fragrance, richness of colors and profuse bloom. Perennial. **Packet, 10 cents.**
- 181. PINK CARNATION (Riviera Market, or Gillaud).**—This is the only variety that will produce flowers the first season. They will thrive either in open ground or pots. **Packet, 25c.**
- 182. PINK CARNATION (Marguerite) (P).**—Will produce flowers in a few weeks from seed. Profuse bloomers, producing very double flowers of all shades of red, pink, white and variegated. Will bloom all summer until frost, or indoors in winter in pots. **Packet, 10 c.**
- 185. PINK—CHINA (Dianthus Chinensis) (P).**—Free bloomers, and a general favorite for bouquets; also a useful bedding plant. **Packet, 5c.**
- 195. PORTULACA (Mexican Rose) (A).**—One of the finest hardy annual plants, of easy culture, thriving best in rather rich, light loam or sandy soil; the single-flowering varieties are large and brilliant, of the richest shades of color, and produced throughout the summer in great profusion; fine for massing in beds or edgings of rock work. **Packet, 5c.**
- 196. DOUBLE PORTULACA (A).**—**Packet, 10c.**

- 165. FINE MIXED.**—Good mixture of small free-blooming colors. **Packet, 5c.**
- 168. PETUNIA.—Double-Fringed Mixed.**—The flowers of this sort being double, together with being fringed, are very beautiful. **Packet, 25c.**
- 200. POPPY-CARNATION (Papaver) (A).**—A showy and easily cultivated hardy annual, with large brilliant colored flowers, growing freely in any garden soil. **Packet, 5c.**
- 201. POPPY—PEONY FLOWERED (A).**—A magnificent species, large, showy, double globe flowers, resembling Peonies in shape. **Packet, 5c.**
- 202. SHIRLEY POPPY (A).**—These beautiful Poppies are generally single or semi-double. The colors, extending from one extreme to the other, are so varied that scarcely two are alike, while many are striped and blotched. The blooms, if cut when young, will stand for two or three days. **Packet, 5c.**
- 203. TULIP POPPY (A).**—A magnificent species. The plants attain a height of 14 to 16 inches, and produce from about 50 to 60 flowers of the brightest scarlet. **Packet, 5c.**
- 204. ICELAND POPPIES, MIXED (A).**—Although hardy perennials, these Poppies bloom the first season from spring-sown seed. **Packet, 5c.**
- 212. RICINUS, CAMBOGIENSIS (A).**—Ornamental plants of stately growth and picturesque foliage; fine for lawns, massing or center plants for ribbon beds; half-hardy annuals. **Pkt., 5c.**
- 212½. RICINUS ZANZIBARIENSIS, MIXED (A).**—Their immense leaves and gigantic plants exceed all other varieties. **Packet, 5c.**
- 213. SCABIOSA—GRANDIFLORA (P).**—A wonderful improvement over the old variety; bears beautifully formed flowers 3 inches **Packet, 5c.**

# HIGH-GRADE FLOWER SEEDS

215. **SCARLET SAGE** (*Salvia Splendens*) (A)—Tall, erect, green foliage. A favorite greenhouse and bedding plant, bearing long spikes of flowers in great profusion from July to October; half-hardy perennial, blooming the first year from seed. Three feet. **Packet, 5c.**

220. **SENSITIVE PLANT** (*Mimosa*)—Curious and interesting plants, with pinkish-white flowers; the leaves close in and droop when touched or shaken; tender annual. **Packet, 5c.**

230. **TEN WEEKS STOCKS** (*Gilliflower*)—A world-wide favorite, brilliant and varied in color, equally well-adapted for massing, bedding, edging or pot culture. Very profuse bloomers. Should be grown in rich soil. **Packet, 5c.**

231. **STOCKS—SNOWFLAKE IMPROVED**—A beautiful dwarf-growing variety; very large, double, snow-white flowers. Our seed of this variety is grown by a specialist, and will produce a large percentage of double flowers. **Pkt., 10c.**

237. **SWEET ROCKET** (*Hesperis*) (A)—Very pleasing, early spring flowering, profuse blooming plants, with fragrant flowers, growing freely in any light, rich soil. **Packet, 5c.**

240. **SWEET WILLIAM** (*Dianthus Barbatus*) (P)—A well-known free flowering, popular favorite; the great improvements upon the old varieties made within the last few years have rendered it still more desirable. Hardy perennials. **Packet, 5c.**

243. **SWEET VIOLET** (A)—Deservedly much in demand, because of their profusion of bloom and delicate, sweet odor. **Packet, 10c.**

245. **MAMMOTH VERBENA** (A).—One of the most popular and useful bedding plants. Verbenas delight in sunny situation, rich soil and thorough cultivation. **Packet, 5 cents.**

250. **VINCA ROSA** (A).—Rose with dark eye. **Packet, 5 cents.**

251. **VINCA ALEA** (A).—White, with crimson eye. **Packet, 5 cents.**

255. **WALLFLOWER, DOUBLE** (A).—Well known, deliciously fragrant plants, with large spikes of double flowers, similar to the Gilliflower. Succeed in light, rich soil, in a moist atmosphere. Perennials. **Packet, 10 cents.**

258. **ZINNIA ELEGANS** (Youth and Old Age (A).—This is one of the most brilliant of annuals, and has long been a general favorite. The flowers are large, finely formed, in great variety of colors, and continue to bloom the entire season. Half-hardy annuals. **Packet, 5 cents.**

**ZINNIA—DAHLIA—FLOWERED, Mixed.**—A new variety — $\frac{1}{8}$  oz., 25c.



Salvia Splendens.

259. **ZINNIAS CURLED AND CRESTED** (A).—New, odd and superb. Petals twisted, curled and crested into fantastic contortions and graceful forms. A magnificent variety of colors. **Packet, 5 cents.**

260. **ZINNIA—DOUBLE POMPON** (A).—Long, coneshaped flowers, very fine. **Packet, 5 cents.**

**ZINNIA—CRIMSON**—Packet, 10 cents.

**ZINNIA—WHITE**—Packet, 10 cents.

## GENERAL LIST OF CLIMBERS

270. **BALSAM APPLE** (*Momordica*) (A)—Very curious trailing vines, with ornamental foliage; fruit golden yellow; when ripe, opens, showing the seeds and its brilliant carmine interior. **Packet, 5c.**

272. **BALLOON VINE** (*Love in a Puff*) (A)—A rapid growing plant; succeeds best in light soil and warm situation; flowers white; half-hardy annual. **Packet, 5c.**

275. **CANARY BIRD FLOWER** (*Peregrinum*) (A)—With yellow, canary-like flowers; very ornamental and beautiful foliage; half-hardy. **Packet, 5c.**

276. **COBEA SCANDENS** (P)—A beautiful, rapid-growing climber, with handsome foliage and large bell-shaped flowers; blue; half-hardy perennial; grows 20 to 30 feet high. **Packet, 10c.**

278. **CYPRESS VINE, RED** (*Ipomea Quamoclit*) (A)—One of our most popular vines, with very delicate fern-like foliage, and masses of beautiful, small, star-shaped flowers. Sow last of May; 15 feet. **Packet, 5c.**

279. **CYPRESS VINE, WHITE** (A)—Usually grown with the red, making a handsome effect. **Packet, 5c.**

295. **HEAVENLY BLUE IPOMEA** (A)—The flowers are in large, airy clusters, and of that lovely hue so rarely seen. Flowers four to five inches across. **Packet, 5c.**

300. **MORNING GLORY** (*Convolvulus Major*).—One of the most free-flowering and rapidly-growing plant in cultivation, thriving in almost any situation. The beauty and delicacy of their brilliant flowers are unsurpassed; hardy annuals. **Packet, 5c.**

302. **GIANT JAPANESE MORNING GLORY.**—Packet, 10c.

305. **MOON FLOWER** (*Ipomea Noctiflora*)—Charming and popular blooming climbers; of rapid growth and showy effects; warm, rich soil, with a sunny exposure, suits them. **Packet, 5c.**

320. **SCARLET RUNNERS.**—Very handsome climbing Beans, with bright scarlet flowers. **Packet, 5c.**

326. **SMILAX.**—Charming climber for greenhouses or window gardens. **Packet, 5c.**

## ORNAMENTAL GOURDS

285. **MIXED GOURD** (*Cucurbita*) (A)—Packet, 5c.

286. **NEST EGG GOURD** (A)—White fruit shaped like an egg. Used as a substitute for nest eggs. **Packet, 5c.**

287. **DISHCLOTH GOURD**—Many women prefer a dishcloth made of this Gourd to anything else, as it is always sweet and clean as long as any part of it is left. **Packet, 5c.**

288. **DIPPER GOURD** (A)—Makes an excellent dipper. **Packet, 5c.**

290. **MOCK ORANGE** (P)—Fruit shaped like an orange. **Packet, 5c.**

291. **CALABASH OR PIPE GOURD**—Odd shaped fruit, which is used to advantage in making pipes. **Packet, 5c.**



## SWEET PEAS

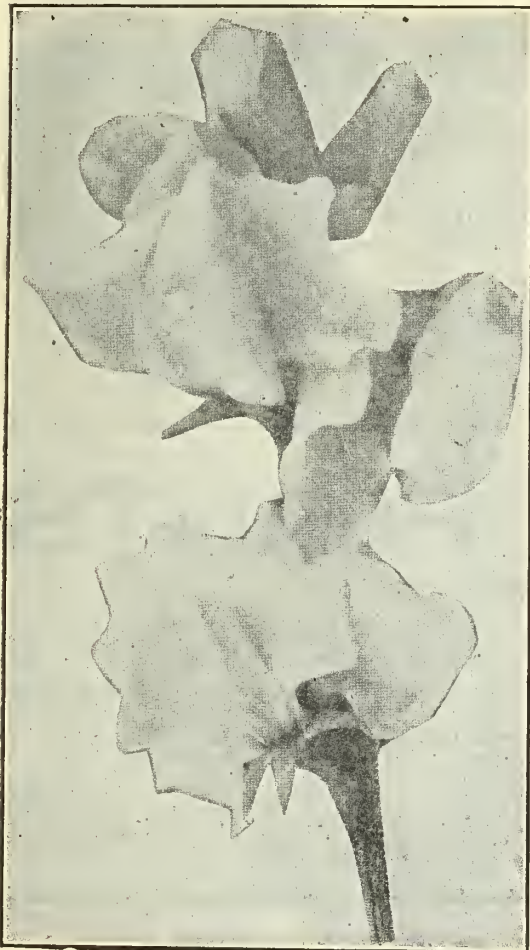

SWEET PEAS should be sown in drills latter part of November for fall planting, or as early as possible in spring, in rich, friable soil. Prepare the bed thoroughly, working in a quantity of well-rotted manure, if it can be done, making a furrow four to six inches deep. In this sow the seed and cover two inches deep. As soon as the plants begin to show through, fill in the furrow. This will secure a deep planting without the bad effect of deep covering of the seed at first, and so enable the plant to bloom continuously through the heat of summer. As fast as the flowers come into full bloom or fade they should be cut off, for if the pods are allowed to form the plants will stop blooming.

**377. G. & T. CO'S EXTRA FINE MIXED**—Consists of the very choicest varieties mixed in the newest colors and shades. **Packet, 5c. Oz., 10c. ¼ Lb., 25c. ½ Lb., 40c. Lb., 75c.** Postage, 6c. per lb. extra.

**379. SUPERB SPENCER MIXTURE**—This mixture contains practically all the true Spencer varieties. **Per oz., 15c.; ¼ Lb., 50c.; 1 Lb., \$1.50.**

## Gladioli

**AMERICA**—This is one of the finest Gladioli ever produced, and ranks as the best sort for cutting, as well as all-around purposes. The color is a very beautiful soft pink, the coloring and texture resembling those of the Orchid. **Each 5c.; dozen, 50c.; 100, \$3.25.**

**AUGUSTA**—A lovely and useful variety, pure white with blue anthers. **5c. each; 50c. per dozen; \$3.25 per 100.**

**CHICAGO WHITE**—White, lavender marking in throat. **Each, 5c.; dozen, 50c.; per 100, \$3.25.**

**HALLEY**—Predominating color, delicate salmon pink, with slight roseate tinge, though the lower petals bear a creamy blotch with a stripe of bright red through the centre, the whole producing a wonderful effect. **Each, 5c.; dozen, 50c.; per 100, \$2.25.**

**LE MARCHAL FOCH**—Rose-pink, resembling America in color but deeper. Blooms same time as the Halley. **5c. each; 50c. dozen; \$3.25 per 100.**

**MRS. FRANCIS KING**—Long, strong stalks, bearing flowers of vermillion-scarlet color. Very effective for cutting. **Each, 5c.; dozen, 50c.; per 100, \$3.25.**

**MRS. DR. NORTON**—Pure, soft white, with tips of petals suffused LaFrance Pink. Wonderful variety. **5c. each; 50c. per doz.; \$3.25 per 100.**

**PANAMA**—An improved America, largest and most notable spike of bloom among all pink sorts. **5c. each; 50c. doz.; \$3.25 per 100.**

**PRINCE OF WALES**—The flowers are large and well placed and the color is a most charming coral-pink. It is a sport of "Halley," but larger and of taller growth and also somewhat earlier. The delicate tint is practically without throat markings. **5c. each; 50c. dozen; \$3.25 per 100.**

**SCHWABEN**—Clear canary-yellow, shading to soft sulphur. Largest flower stalk and leaves of all. Planted 7 or 8 inches apart in rich soil produces wonderful blooms. **5c. each; 50c. dozen; \$3.25 per 100.**

**GIANT WHITE**—A very large flower, ruffled. **5c. each; 50c. dozen; \$3.25 per 100.**



GLADIOLI

**MIXED**—5c. each; 50c. dozen; \$3.25 per 100.

## CALADIUMS

### ELEPHANT EAR

The Caladium Esculentum is one of the handsomest of the ornamental-leaved plants. It will grow in any good garden soil. Plant where it will obtain plenty of water and an abundance of rich compost.

**SMALL SIZE (5 to 7 inches)**—Each, 5c.; doz., 50c.

**FIRST SIZE BULBS (7 and 9 inches)**—Each, 7c.; dozen, 75c.

**LARGE BULBS (9 and 11 inches)**—Each, 10c.; dozen, \$1.00.

**EXTRA LARGE BULBS (11 inches and upwards)**—Each, 15c.; dozen, \$1.75.

If by mail, add single bulbs, 5c. Dozen, 15c.

## TUBEROSES

One of the most fragrant and popular of the summer flowering bulbs. May be started early in hotbeds or pots, or planted in open ground after the first day of May.

**EXCELSIOR PEARL**—Double white; dwarf. Each, 5c.; dozen, 50c.; per 100, \$4.00.

If by mail, add dozen, 10c.

## STRAWBERRY PLANTS

### DIRECTIONS FOR CULTURE

Strawberries require well-tilled soil; the plants should be set 15 inches apart, in rows 2 feet wide. Firm the plants well in the soil and keep thoroughly cultivated.

In early winter when the ground is frozen, cover the whole with long straw, which should be removed from the plant in the spring, but allowed to remain on the ground as a mulch, to keep the berries clean next summer. When strawberries are moved in the fall, they should be left until October or the first of November.

**BIG JOE**—This variety was introduced about twenty years ago, and proven a wonderful discovery. It is a mid-season to late variety, equally in size, firmness and yield as the Chesapeake, and superior in flavor and color. Succeeds on a great variety of soils.

**CHESAPEAKE**—Late. Large, firm and productive. One of the fanciest varieties grown.

**GANDY**—Late. Large and firm.

**KLONDYKE**—Medium Early. Very productive, berries large and firm.

**LUFON**—Large, fine, medium early. A beautiful berry, solid and delicious.

**PREMIER**—One of the very best of extra early varieties; succeeds on almost all soil (if well drained). Produced in vast quantities, berries of good size, attractive appearance and excellent quality. Above varieties \$1.75 per hundred, postpaid.

**PROGRESSIVE-EVERBEARING**—\$3.50 per 100, postpaid.

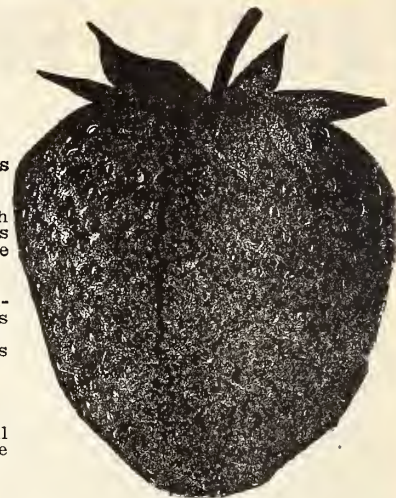

## VEGETABLE PLANTS

### FROM SEED BED. SPECIAL PRICE IN QUANTITY.

**CABBAGE**—All the leading varieties. May 1, frame grown, 70c. per 100; \$2.50 per 500; \$4.50 per 1,000. Field grown from June 1. to December 1. 60c. per 100; \$2.25 per 500; \$4.25 per 1,000. By express, not prepaid. Add 10c. per 100 if by mail.

**CAULIFLOWER**—Early Snowball, 30c. per dozen; \$1.50 per 100. Add 6c. per dozen if by mail.

**CELERY**—All the leading varieties. 60c. per 100; \$2.50 per 500; \$5.00 per 1,000. By express, not prepaid. Add 10c. if by mail.

**EGG PLANT**—Imp. Baltimore from seed bed, 30c. per doz., \$1.50 per 100. By express, not prepaid. Add 6c. per dozen, by mail.

**LETTUCE**—Ready at all seasons. All the leading varieties. 70c. per 100; \$3.00 per 500; \$6.00 per 1,000. By express, not prepaid. Add 10c. per 100 if by mail.

**PEPPER**—All leading varieties at 30c. per doz.; \$1.50 per 100. By express, not prepaid. Add 10c. per dozen if by mail.

**SWEET POTATO**—70c. per 100; \$3.00 per 500; \$6.00 per 1,000. By express, not prepaid. Add 10c. per 100 if by mail.

**TOMATO**—Ready May 1. Seed-bed plants of Bonnie Best, Chalk's Jewel, and Main Crop Varieties at 70c. per 100; \$2.50 per 500; \$5.00 per 1,000. Main Crop Varieties, Field Grown, ready June 1 60c. per 100; \$2.00 per 500; \$4.00 per 1,000. By express, not prepaid. Add 10c. per 100 if by mail.

## FROST-PROOF CABBAGE PLANTS

WILL MATURE HEADS TWO TO THREE WEEKS EARLIER THAN YOUR HOME-GROWN PLANTS.

### VARIETIES

Early Jersey Wakefield, Charleston Wakefield, Succession and Early Flat Dutch

These plants are grown in the open field during the fall and winter months, which causes them to make a slow, tough, hardy growth—so hardy that the outer leaves turn to a reddish brown. They can be shipped to distant points without danger of spoiling, and should be planted in the open ground from four to five weeks earlier than frame plants.

They will stand a temperature of 10 to 15 degrees above zero without injury. Will do very much better planted early, as they will take root and start to grow as soon as warm weather sets in.

Orders filled from January 1 until April 1. We do not advise planting later than this time.

Prices by Parcel Post, postage paid. In lots of 100, 200 and 300 plants at 50c. per 100 plants; 500 plants for \$1.60; 1,000 or more at \$3.00 per 1,000 plants.

Orders are filled by the 100, not 250 or 350. These prices are for even quantities of one variety to package; if you ordered 200 of one variety and 300 of another variety you would pay at the 100 rate.

Prices by Express, buyer paying express charges. In lots of 1,000 to 3,000 plants at \$2.00 per 1,000; 5,000 or more at \$1.50 per 1,000. Plants packed for express shipment, 1,000 or 2,000 plants of a variety to package, they weigh about 25 pounds per thousand plants, packed for shipment.

TERMS, CASH WITH ORDER, PLEASE. No Plants Shipped C. O. D.

ALL PRICES SUBJECT TO CHANGE WITHOUT NOTICE.



## CANNAS

### SELECT BEDDING VARIETIES

SUBJECT TO OUTTURN OF CROP.

FROM 3-IN. POTS. READY ABOUT MAY 1ST to 15TH.

POTTED PLANTS ONLY.

Price, except where otherwise noted, 15c. each. \$1.75 per doz. Add 5c. each extra for postage.

**THE PRESIDENT**—Glistening bright scarlet; large flowers; 5 ft. 50c. each.

**KING HUMBERT**—The broadest-leaved Canna; bronze, with orange-scarlet flowers; 4 to 5 ft. 25c. each.

**CITY OF PORTLAND**—A wonderfully deep rosy salmon, color much richer than Mrs. Alfred Conard; flowers of a large size, abundantly produced in large trusses; 3½ ft. 50c. each.

**ALPHONSE BOUVIER**—Crimson; 5 ft.

**GLADIATOR**—Bright yellow, spotted crimson, green foliage; 5 ft.

**GUSTAV GUMPPER**—Ideal yellow bedding canna; 3½ ft.

**MME. CROZY**—Rich orange-scarlet flowers, edged with bright golden yellow; 4 ft.

**MAROS**—Best white-flowering; creamy white flowers produced on stems well above foliage; 3½ to 4 ft.

**QUEEN CHARLOTTE**—Rich pomegranate red, bordered bright golden yellow; 3½ ft.

**RICHARD WALLIS**—Free-flowering yellow, with green foliage; 4½ ft.

**RUBIN**—Bright scarlet flowers, dark foliage; 4 ft.

**UNCLE SAM**—Clear deep orange flowers, borne in large clusters; rich green foliage; 6 ft.

**VENUS**—Gay rosy pink, with mottled border of creamy white; 4 ft.

**WYOMING**—Orange-scarlet, with bronze foliage; 4½ ft.

IF WANTED BY MAIL, ADD 5c. EACH EXTRA.



### FOLIAGE CANNAS

with bronze leaf, but do not bloom. Dormant roots at 6c. each; 60c. per dozen. By post, 10c. per dozen extra.

### MIXED CANNA ROOTS IN SPLENDID VARIETY

OUR SELECTION.

6c. Each; per Dozen, 60c.; per 100, \$5.00. By Express, Not Prepaid. By Parcel Post, add 10c. per Dozen, Extra.

## GERANIUMS

Price, 15c. each; \$1.50 per dozen. By express, not prepaid...

3 Cents Each for Postage.

### IVY-LEAVED VARIETIES

**ALLIANCE**—Delicate lilac white, upper petals blotched bright crimson rose semi-double flowers.

**CÆSAR FRANK**—Soft rich crimson, shading to rose at base of petals.

**JAMES ATTFIELD**—Extra large double flowers, of pretty tint of soft pink.

**JAMES T. HAMILTON**—Intense carmine-crimson.

**MBS. BANKS**—Blush white, upper petals feathered reddish Neyron. Light green foliage.

**PIERRE CROZY**—Semi-double bright scarlet flowers.

### STANDARD DOUBLE VARIETIES

**M. A. ROSELEUR**—Deep rose-pink.

**MARQUISE DE CASTELLANE**—Soft red crimson.

**MISS F. PERKINS**—Charming shade of deep rose.

**MISS KENDAL**—Dark carmine red.

**MME. RECAMIER**—Pure white.

**MARYLAND**—Handsomely marked foliage, with a chocolate zone. Intense dazzling fiery-red color.

**MME. F. SARLOVEZE**—Exquisite shade of light rose, shading to white at centre; immense semi-double flowers.

**ORNELLA**—Deep rich scarlet.

**S. A. NUTT**—Dark velvety crimson.

**SCARLET BEDDER**—A bright scarlet bedding variety; free bloomer.

### SCENTED-LEAVED VARIETIES

**EALM**—Upper petals light lilac; lower petals dark.

**CAPITATUM**—Small leaf, rose-scented.

**DALE PARK BEAUTY**—Small, fragrant foliage.

**FAIR ELLEN**—Fragrant and beautiful; large oak-leaved foliage.

**LADY MARY**—Sweet-scented; rose-lake color.

**LEMON**—Lemon-scented.

**NUTMEG**—Dwarf; bright green foliage; nutmeg scented.

**ROSE**—Rose-scented.

## HARDY POMPON CHRYSANTHEMUMS



### Small-Flower or Button Varieties

**ANNA MARY**—Creamy white, shaded pink.  
**HILDA CANNING**—Bright bronze, long stem for cutting.  
**JAMES BOONE**—Pure white.  
**YELLOW GEM**—Golden yellow.  
**LITTLE PET**—Rich, violet rose.

### Anemone Varieties

**EARLE**—Pearl white, silver-rose centre, dwarf.  
**EVA**—Rose-pink.  
**LADY OLIVIA**—Beautiful white.  
**MATILDA**—White, large flowers.  
**MYRR'S PERFECTION**—Fine pure white, tall grower; good for cutting.  
**PALMYRA**—Silver pink, long stem.

Price: 10c. Each; per Dozen, \$1.00; per 100, \$6.00.  
 By Express, Not Prepaid.  
 Add 3c. for postage.

### MOON VINES

15c. Each. \$1.50 per Dozen.  
**NOCTIFLORA**—The standard white Moonvine.  
**LEARI (Blue Dawn Flower)**—Generally known as the Blue Moonflower.  
 Postage 3 cents each extra.

### SCARLET SAGE

**SALVIA SPLENDENS**—Tall, erect, green foliage. The well-known Salvia.  
 10c. Each. \$1.00 per Dozen.  
 Add 3c. each for Postage.

### BEGONIAS

**GLORIE DE CHATELAIN**—Dwarf, compact grower. Always full of flowers of a lively pure pink color. Popular for pot and bedding plant. 15c. each.  
**PRIDE OF NEW CASTLE**—Red sport of Glorie de Chatelaine, being a deep rich Begonia red. 15c. each.  
**GRACILIS ROSEA**—Handsome flower of delicate rose color. 10c. each.  
**LUMINOSA**—Red flower, foliage turning reddish bronze, when growing in sun. 10c. each.  
**GRACILIS PFITZER TRIUMPH**—Pure white, free flowering. 10c. each.  
 Postage 3c. each extra.

All from 2-inch pots, for bedding outdoors, for cut flowers, but not the large greenhouse varieties.

They are, however, being cultivated extensively for garden purposes.

#### LARGE-FLOWERING OR ASTER VARIETIES.

(These are not for exhibition purposes, but good results can be obtained by slight disbudding, leaving from six to eight flowers on a spray. Should also be protected from frost when desired for cutting).

**ASBURY**—Sulphur-white. For cut flowers.

**BRADSHAW**—Lilac-rose, cut petals.

**ELDORADO**—Bright golden-yellow, open centre.

**ELKTON**—Light pink, full large flower.

**EXCELLENCE**—Pure white, tall grower.

**EXCELSIOR**—Bright orange-yellow, long stem.

**FRED J.**—Red orange, good for cut flowers.

**GERMANIA**—Large flower, straw white, long stems.

**HESTER**—Pearl white, shaded pink.

**JERRY**—Rose lilac, open centre.

**JERSEY**—Pure white, open centre.

**KING HENRY**—Straw white, long stem.

**MARIANA**—Snow white, large flower on long stem.

**PRINCE OF WALES**—Snow white, long stem, fine for cutting.

**REV. W. H. HOFFMAN**—Golden bronze, long stem.

**SIR MICHAEL**—Lemon yellow, open centre, long stem for cut flower.

**TRIUMPH D'OR**—Rich, golden yellow.

**VIOLA**—Rich, violet rose.

**WINDLESS**—Rich, golden yellow, large flowers.

# DAHLIAS

THE FOLLOWING NAMED VARIETIES SUPPLIED IN POTTED PLANTS ONLY. (Ready About May 1st-15th). Prices, except where otherwise noted, 15c. each; \$1.50 per doz. By Parcel Post, add 3 cents each for Postage.

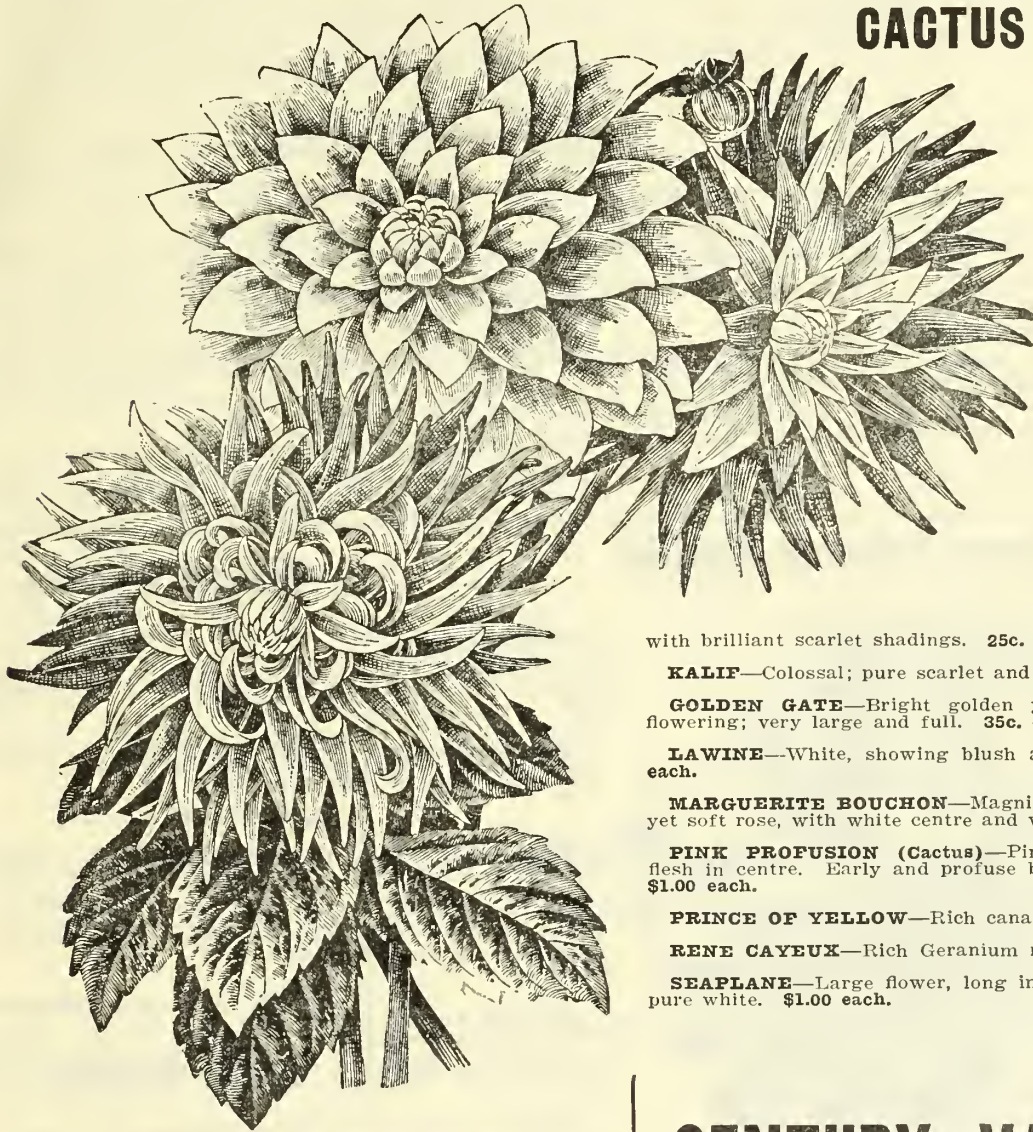

## CACTUS VARIETIES

**ABERDEEN.**—Deep carmine, bright shading cactus. 50c. each.

**ATTRACTION.**—A beautiful and large Dahlia, with curled or twisted petals, of soft silvery mauve-rose, with white suffusion. \$1.00 each.

**COUNTESS OF LONSDALE.**—Rich salmon.

**CONOWINGO.**—One of the best cactus to date. Outside petals salmon yellow, shading to lemon yellow towards centre. Large, free bloomer on good stems. \$1.00 each.

**GEN. J. B. SETH.**—Rich and gorgeous, with brilliant scarlet shadings. 25c. each.

**KALIF.**—Colossal; pure scarlet and perfect form. 50c. each.

**GOLDEN GATE.**—Bright golden yellow, early and free-flowering; very large and full. 35c. each.

**LAWINE.**—White, showing blush as flower matures. 15c. each.

**MARGUERITE BOUCHON.**—Magnificent shade of brilliant, yet soft rose, with white centre and white tips. 25c. each.

**PINK PROFUSION (Cactus).**—Pink, shading slightly to flesh in centre. Early and profuse bloomer. Dwarf grower. \$1.00 each.

**PRINCE OF YELLOW.**—Rich canary yellow.

**RENE CAYEUX.**—Rich Geranium red.

**SEAPLANE.**—Large flower, long incurved petals of almost pure white. \$1.00 each.

## SHOW VARIETIES

**CHAS. LANIER.**—Yellow amber, shaded buff.

**ETHEL MAULE.**—Pure white, tinged pale lavender in centre.

**QUEEN OF YELLOWS.**—Rich canary yellow; best for cutting.

**SOUVE MME. MOREAU.**—Deep rich pink. 25c. each.

**ZEBRA.**—Pearl white, edged deep pink. 25c. each.

## CENTURY VARIETIES

**BIG CHIEF.**—Brilliant cherry-red, margined rich velvety maroon.

**FRINGED TWENTIETH CENTURY.**—Similar to twentieth century, having petals deeply cleft. 25c. each.

**ROSE PINK CENTURY.**—Clear rose pink; immense size.

**SCARLET CENTURY.**—Bright scarlet.

**SENSATION.**—Vivid scarlet, heavily tipped white. 25c. each.

Prices, except where otherwise noted, 15c. each; \$1.50 per doz.

By Parcel Post, add 3 cents each for Postage.

By Express, Not Prepaid.

## DAHLIAS—Continued

### Decorative Varieties

- AUGUSTA NONIN**—Large flower of fiery red. 25c. each.
- A. C. IDE**—Rich velvety maroon, of fine quality, produced freely on erect stems. Some petals broad and flat. Some twisted and curled. 25c. each.
- BELOIT**—Large, bright growing crimson flowers, of good substance, 35c. each.
- BALTIMORE**—Lemon-yellow, mottled violet rose. 35c. each.
- CHESAPEAKE**—A peculiarly striped and tinted variety, very attractive. Canary yellow, striped and streaked throughout with crimson, the color of the reflex. \$1.00 each.
- DREAM**—Large, perfectly formed flowers. The color is a very pleasing shade of burnt rose and amber, with a slight pinkish tinge. 50c. each.
- DELICE**—Beautiful glowing rose-pink. 15c. each.
- FLAMINGO**—Rich and glowing rose-pink, showing sometimes an open centre. 25c. each.
- FRIDAY**—Bronze, of good form and habit. \$1.00 each.
- GOLDEN WEST**—Best yellow, fine for cutting. 25c. each.
- JACK ROSE**—Rich velvety crimson. 25c. each.
- JACK'S DISCOVERY**—White, mottled violet rose. 25c. each.

THE FOLLOWING NAMED VARIETIES SUPPLIED IN POTTED PLANTS ONLY. (Ready About May 1st to 15th).  
Prices, except where otherwise noted, 10c. each; \$1.00 per dozen. By express, not prepaid. By parcel post, add 3c. each for postage.

- HORTULANUS WITTE**—Very long stemmed, free flowering, pure white. 25c. each.
- KING OF AUTUMN**—Large perfectly formed flowers of beautiful shade of burnt amber, tinged and shaded old rose. 50c. each.
- LE GRAND MANITOU**—White ground color, prettily spotted, striped and blotched with deep, reddish violet. 25c. each.
- MABEL**—Light mauve; pretty and free-flowering. 50c. each.
- MINA BRUGLE**—Rich, luminous, dark scarlet; free-flowering. 35c. each.
- MISS MINNIE McCULLOUGH**—Soft yellow, overlaid with bronze. 15c. each.
- TAFFY**—Light rose pink, slightly streaked fleshy yellow. Good bloomer and good for cut flowers. \$1.00 each.
- QUEEN MARY**—Fine rose pink, free bloomer, good stiff stems. 15c. each.
- YELLOW DUKE**—Pure canary yellow. 25c. each.
- OREGON BEAUTY**—Intense oriental red with golden sheen and garnet suffusion. 25c. each.

### Peony-Flowered Varieties

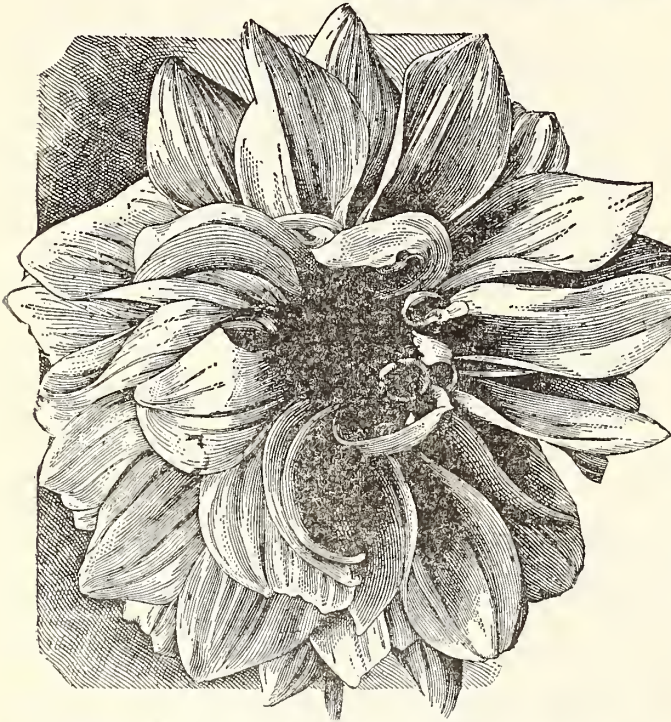

**GEISHA**—Scarlet and gold, with yellow center, deepening to scarlet at centre. 50c. each.

**HON. E. L. BORDEN**—Rich golden bronze. 25c. each.

**MRS. CHAS. L. SEYBOLD**—Distinct bright crimson-pink, each petal tipped white.

**PRAIRIE FIRE**—Rich scarlet.

**PRESIDENT FALIERES**—Intense red, free-flowering and of finest form. 25c. each.

**WEBER**—Lovely shade of rose-pink, fine form and stem. 50c. each.

**QUEEN WILHELMINA**—Fine, pure white. 25c. each.

### Pompon Varieties

15c. each. \$1.00 per Dozen.

**ALEWINE**—Flesh, edged lavender pink.

**CRIMSON QUEEN**—Deep crimson, shaded purple.

**INDIAN CHIEF**—Crimson.

**LITTLE BEAUTY**—Delicate shrimp pink.

**LITTLE MAY**—Bright lemon yellow.

### Single Varieties

**AMI BARILLET**—Scarlet-crimson flowers, dark bronze foliage.

**ST. GEORGE**—Large, pure yellow. 15c. each.

By Parcel Post, add 3c. each for postage.

## DAHLIA ROOTS

(OUR SELECTION)

In separate colors, not named varieties. Large clumps, 12c. each; \$1.25 per dozen. By express, not prepaid.

IF BY MAIL, ADD 3 CENTS EACH FOR POSTAGE.

ALL PRICES IN CATALOG SUBJECT TO CHANGE WITHOUT NOTICE.

## NURSERY DEPARTMENT

Before planting fruit trees, the soil (excepting new ground) should be made mellow by repeated plowing. When trees are received the root should be covered with a blanket, sack or straw until they reach their destination; the bundle should then be opened, and the trees separated from the moss in which they are packed; if the roots have become dry, from too long exposure, straw should be spread on the ground, the trees laid upon it, then covered entirely, roots and tops, with straw, and the whole well watered. In this condition they should remain for forty-eight hours, when they will be found as fresh as when first found in the nursery. Where only a few trees are to be planted, and the soil has not been sub-soiled, or where trees are to be planted in sod, then the holes ought to be at least four feet wide and eighteen to twenty inches deep, the sub-soil thrown back, and the holes filled up to a proper depth to receive the tree with fine top soil.

### SUMMER APPLES.

**YELLOW TRANSPARENT**—Early and prolific; clear white skin, changing to yellow. July.  
**BENONI**—Very early, skin dark rich red; flesh white; juicy, slightly tart.

### AUTUMN APPLES.

**GRAVENSTEIN**—Orange-yellow, overlaid with broken striped of light and dark red. Flesh yellowish. One of the finest fall apples. Fruit produced freely. September to October.  
**SUMMER RAMBO**—One of the best. Smooth skin, streaked dull yellowish; red, rich, spicy; sub-acid flavor. October to January.  
**SMOKEHOUSE**—Large fruited, striped red on yellow ground; sub-acid; productive and good for culinary purposes. September to October.

### WINTER APPLES.

**BLACK BEN DAVIS**—Red all over. Medium to large. Flesh white. Tree strong growing and very productive. Fruit will keep until late in season.  
**STAYMAN'S WINESAP**—Superior to old Winesap; large, bright red, very productive, adapting itself to different soils. Good marketing variety.  
**STARK'S DELICIOUS**—Brilliant dark red, shading to yellow at blossom end. Flesh white and tender. Large size.  
**GRIMES GOLDEN**—Yellow sub-acid; spicy and rich fruit. January to March.  
**JONATHAN**—Small, with yellow skin, almost covered red; fine flavor; popular everywhere. November to April.  
**YORK IMPERIAL**—Medium size, skin greenish-yellow, nearly covered with bright red; tender flesh, crisp and juicy; good bearer and keeper. February to April.  
**ROME BEAUTY**—Large, yellow, striped and mixed with light red; flesh yellow, breaking coarse-grained, sub-acid; valuable for market on account of its productiveness, size and beauty, as well as for certain bearing. November to January. Can always be depended on for a full crop.  
Price, \$1.25 each.

### CRAB-APPLES.

**HYSLOP**—Fruit large for its class; produced in clusters; dark rich red, covered with thick blue bloom; good for culinary purposes and for cider.  
**TRANSCENDENT**—Golden yellow, with beautiful rich crimson cheek; flesh creamy yellow; crisp, sub-acid, pleasant and agreeable. Tree a rapid grower and productive. September.  
Price, \$1.25 each.

### PEARS.

**BARTLETT (Summer)**—Yellow, with soft blush, fine-grained, sweet and juicy; good bearer. July and August.  
**KOONCE (Summer)**—Handsome fruit, good bearer, frost-proof and free from blight.  
**KIEFFER**—Standard winter variety. Large and juicy.  
**SECKEL (Autumn)**—Rich quality, hardy and productive. September to October.  
Price, \$1.50 each.

### PEACHES.

**CARMAN**—Large and round with pale yellow skin, red blush on sunny side; white flesh, superior flavor. Middle of July.  
**ELBERTA**—An exceedingly large high-colored Peach. A cross between Crawford's and Chinese Cling. Juicy, well flavored. Said to be finest yellow freestone in existence. Ripens early in August.  
**CRAWFORD EARLY**—A magnificent large yellow Peach, of good quality. Popular and productive; flesh very juicy, rich, slightly sub-acid, of good flavor; freestone; valuable for market. First of August.  
**CRAWFORD LATE**—A superb fruit of large size; skin yellow, with broad dark red cheek; flesh deep yellow, but red at stone, juicy and melting, with very rich and excellent vinous flavor. One of the best yellow and admirable market fruit; freestone. August 15th.

**SMOCK**—Rather large yellow, with red cheek; flesh yellow, red at stone; very productive; not of high excellence but valuable as a market variety. Most extensively grown in Delaware and Maryland. Middle to last of September.  
Price, 50c. each.

### CHERRIES (Sweet).

**BLACK TARTARIAN**—Fruit large size, sweet and productive. June.  
**GOV. WOOD**—Fruit large, yellow-shaded red; juicy and sweet. June.  
**NAPOLEON**—One of the best, well-flavored; pale yellow turning amber in the shade; richly dotted with deep red, and with fine marbled dark crimson cheek; flesh firm and juicy.

### CHERRIES (Sour).

**MORELLO**—Above medium size, skin dark red, becoming nearly black; flesh juicy, sub-acid, rich. July.  
**MONTMORENCY**—Large red acid Cherry; very prolific and hardy.  
**RICHMOND**—Medium size, red, flesh melting, juicy and at maturity a rich acid flavor. Very productive and fine for cooking. Commences ripening about last of May, and hangs long on tree.

Price, \$1.75 each.

### PLUMS.

**ABUNDANCE**—Lemon-yellow ground, nearly overspread with Cherry, with heavy bloom; flesh yellow and very juicy; sub-acid, with Apricot flavor; highly perfumed, stone small; tree hardy; bears regularly; early heavy bearer. August 1st.  
**LOMBARD**—Medium size, skin delicate violet, dotted thick red; flesh deep yellow, juicy and pleasant. One of the hardiest and most productive. Succeeds well anywhere.  
**SHROPSHIRE DAMSON**—An improvement on the common Damson, being largest of its class; dark purple; highly esteemed for preserving; enormously productive. September.  
Price, \$1.50 each.

### QUINCES.

**ORANGE (Apple Quince)**—Bright pale orange; surface only moderately fuzzy. Fruit variable in size and shape, but in ideal of original form; is distinctly flattened at both ends, like an apple. Ripens after mid-autumn, and keeps until February under good conditions.  
**CHAMPION**—Greenish-yellow; large fruit, flesh tender, delicate flavor; good keeper. Late.  
Price, \$1.50 each.

### GRAPES.

**CONCORD**—Vigorous growing vine and enormously productive. Comparatively free from disease; bunches large, compact; berries, large round black, with a blue bloom. Profitable market sort.  
**MOORES (Early)**—Bunch medium; berry large black, with **NIAGARA**—Large bunch, of greenish white berry, turning to blue bloom. Extremely hardy; for market. light yellow; thin skin, but tough. Is tender and sweet. Ripens with Concord.  
Price, 40c. each.

### RASPBERRIES.

**GREGG**—Large firm fruit, sweet and rich; strong grower and ripens late. Black and juicy.  
**KANSAS BLACK CAP**—Firm and of fine quality; strong and hardy. Second-early.  
**MILLER RED**—Bright red, does not fade; fruit ripens early and has very small core. Heavy bearer; best shipper.  
Price, 15c. each; \$1.25 per doz.

### BLACKBERRIES.

**ELDORADO**—Berries very large; jet black, sweet melting, no hard core. Splendid keeper and shipper.  
**LUCRETIA**—This is a trailing blackberry or dewberry; a good grower and productive. Fruit large and of good flavor.  
Price, 15c. each; \$1.25 per doz.

### CURRANTS.

**FAY'S PROLIFIC**—Strong grower, wonderfully productive, and comes to bearing young; fruit large, bright red and good quality.  
Price, 40c. each.

## BOOKS ON HORTICULTURE, AGRICULTURE AND KINDRED SUBJECTS

### "FARMERS' CYCLOPEDIA OF LIVE STOCK."

A compendium of the science, economics and practice of stock raising, dairying and poultry farming, comprising the origin, anatomy, physiology, breeding, feeding, diseases, management, marketing and slaughtering of farm stock and the utilization of animal products. Many superb illustrations. A very valuable reference book. By Earley Vernon Wilcox, Ph.D., Clarence Beaman Smith, M.S. Color plates and illustrations. Cloth, handsome and durable, gold stamping.....\$5.50

#### AGRICULTURE AND FARMING.

- FARMERS' CYCLOPEDIA OF AGRICULTURE.** By Messrs. Wilcox and Smith, Experiment Station Editors in U. S. Dept. of Agriculture. 6000 topics. 700 pages. 500 illustrations. Cloth bound..... 4.50
- THE BOOK OF ALFALFA.** F. D. Coburn. This is by far the most authoritative, complete and valuable work on this forage crop ever published..... 3.00
- ALFALFA.** By F. D. Coburn. Its growth, use and feeding value..... .90
- BOOK OF WHEAT (new.)** By P. T. Dondliuger. A complete study of everything pertaining to wheat. New, authoritative and up to date..... 2.00
- CLOVERS AND HOW TO GROW THEM.** By Thos. Shaw. The only book published which treats on the growth, cultivation and treatment of clovers in all parts of the U. S. and Canada. 2.00
- THE BOOK OF CORN.** By Herbert Myrick, assisted by specialists. A complete treatise upon the culture, uses and marketing of maize..... 2.00
- FARM GRASSES OF THE U. S.** By W. J. Spillman, Agrostologist of the U. S. Department of Agriculture..... 1.75
- TEN ACRES ENOUGH.** A practical experience showing how a very small farm may be made to keep a very large family..... 1.60
- LANDSCAPE GARDENING.** By F. A. Waugh. A treatise on the general principles of governing outdoor art. Every paragraph is short, giving perfect clearness to the discussion at all points. Illustrated. 162 pages, 5x7 inches. Cloth. Net. 1.25
- THE YOUNG FARMER: SOME THINGS HE SHOULD KNOW.** By Dr. Thomas F. Hunt. To the beginner who desires thorough and reliable information the work cannot be too highly recommended. Illustrated. 280 pages. 5x7 inches. Net..... 2.00

#### DAIRYING AND DAIRY FARMING.

- FIRST LESSONS IN DAIRYING.** By H. E. Van Norman. This book is just the thing for everyday dairymen and should be in the hands of every farmer in the country..... .90
- PROFITABLE DAIRYING.** By C. L. Peck. A practical guide to successful dairy management..... 1.25
- TESTING MILK AND MILK PRODUCTS.** By L. L. Van Slyke. A handbook for butter-makers, cheese-makers, producers of milk..... 1.40

#### CATTLE, SHEEP, SWINE AND HORSES.

- MANAGEMENT AND FEEDING OF SHEEP.** By Thomas Shaw. The best book that has yet appeared on this subject. It is complete in every detail..... 2.50
- DISEASES OF SWINE.** By Dr. R. A. Craig. A concise, practical and popular guide to the prevention and treatment of the diseases of swine..... 1.25
- THE FARMER'S VETERINARIAN.** By C. W. Burkett. A treatise on the diseases of farm stock; containing brief and popular advice on the nature, cause, and treatment of disease, the common ailments, and the care and management of stock when sick. It contains a number of illustrations, picturing diseases, their symptoms, and familiar attitudes assumed by farm animals when affected with disease. Illustrated. 5x7 inches. 288 pages. Cloth. Net..... 1.75
- HINTS TO HORSEKEEPERS.** By H. W. Herbert. How to breed, buy, break, drive, ride, groom, use, feed and physic.... 1.75
- MODERN HORSE DOCTOR.** By G. H. Dadd, M. D., V. S. Preservation and restoration of health, treatment of lameness, etc. 1.75

#### POULTRY, PIGEONS, BIRDS AND BEEKEEPING.

- POULTRY ARCHITECTURE.** By G. B. Fiske. All about the construction of poultry buildings of all grades, styles and classes; coops; locations, etc. 125 pages. Illustrated.. .90
- POULTRY DISEASES.** By E. J. Wortley. The entire subject of health and disease, and common cause of disease..... 1.25
- POULTRY BREEDING AND MANAGEMENT.** By James Dryden. This book is written for the man or woman on the farm who is interested primarily in making poultry pay as well as chapters on systems of poultry farming, housing, feeding and incubation, are fully treated. Illustrated. 5½x7½ inches. 416 pages. Cloth. Net..... 2.00

- POULTRY FEEDING AND FATTENING.** Compiled by G. B. Fiske. A treatise on poultry standard and improved methods of feeding and marketing all kinds of poultry. Illustrated. 160 pages. 5x7½ inches. Cloth.....\$ .90
- A B C OF BEE CULTURE.** By A. I. Root. A cyclopedia on bees, honey, hives, implements, honey plants, etc..... 3.00
- QUINBY'S NEW BEE KEEPING.** By L. C. Root. The mysteries explained; 50 years' experience; latest discoveries..... 1.76

#### CULTURE OF VEGETABLES.

- HOME VEGETABLE GARDEN.** By A. Krubm. A practical and suggestive guide for the man that wants to raise his own vegetables..... 1.50
- ASPARAGUS.** By F. M. Hexamer. A practical treatise on the best methods of raising, cultivating, harvesting, marketing, forcing and canning asparagus..... .90
- BEAN CULTURE.** By Glenn C. Sevey. The only complete, comprehensive and authoritative book published on the subject..... .90
- CABBAGES, CAULIFLOWER AND ALLIED VEGETABLES (BRUSSELS SPROUTS, KOHL-RABI, KALE, ETC.).** By C. L. Allen. Complete cultural instructions from seed time to harvesting.... .90
- CELERY CULTURE.** By W. R. Beattie. A practical guide for beginners and a standard reference to those already engaged in growing celery..... .90
- MELON CULTURE.** By James Troop. This is a practical treatise on the melon which is intended to be of service to the amateur as well as the large commercial grower..... .90
- MUSHROOM CULTURE.** By B. M. Duggar. The whole subject is treated in detail, minutely and plainly, as only a practical man actively engaged in mushroom growing can handle it..... 2.00
- ONION CULTURE.** By T. Greiner. For the home garden or market; new and highly valuable methods are described... .90
- PEAS AND PEA CULTURE.** By Glenn C. Sevey. Facts are tersely stated and readers will find this book an authority on many of the details connected with the crop..... .90
- TOMATO CULTURE.** By Will W. Tracy. The most complete account of tomato culture in all its phases that has ever been gotten together. Illustrated. 150 pages. 5x7 inches. Cloth..... .90

#### FRUIT CULTURE.

- AMERICAN FRUIT CULTURIST.** By J. J. Thomas. 20th edition; just revised and enlarged. A handbook of everything pertaining to fruit culture..... 3.50
- BEGINNERS' GUIDE TO FRUIT GROWING.** By F. A. Waugh. A simple statement of the practices of propagation, planting, culture, etc..... 1.25
- PRINCIPLES AND PRACTICE OF PRUNING.** By M. G. Kains. Prepared to meet the needs of practical and amateur growers. Lavishly illustrated by 300 actual photographs of specimens showing good and bad practice. Net..... 4.50
- AMERICAN PEACH ORCHARD.** By Waugh. The best work on growing peaches for profit or home use..... 1.75

#### FLORICULTURE.

- GREENHOUSE MANAGEMENT.** By L. R. Taft. This book forms an almost indispensable companion volume to "Greenhouse Construction." Over 100 excellent illustrations. 210 pages. 5x7 inches. Cloth..... 2.25
- PARSONS ON THE ROSE.** By Samuel B. Parsons. A treatise on the propagation, culture and history of the rose. New and revised edition. A simple garden classification has been adopted, and the leading varieties under each class enumerated and described. Illustrated. 211 pages. 5x7 inches. Cloth..... 1.60

#### SPECIAL BOOKS.

- SUCCESS WITH HENS.** By Robert Joos. This is a reliable guide to poultry-raising that thoroughly covers the subject by an expert. It is clear, practical and up-to-date. The fifty-five chapters give full directions for the hatching and brooding of chickens, incubation, feeding and housing, increasing the egg-supply, cure of diseases. Cloth. 234 pages..... 1.25
- SUCCESS WITH HOGS.** By Charles Dawson. In this important book everything connected with the raising of hogs is thoroughly treated in a clear, practical and reliable manner. Every hog raiser needs this book to help him take advantage of the present great demand for pork products. Net..... 1.25
- MAKING THE FARM PAY.** By C. C. Bowsfield. This very important book tells how to get the biggest returns from the soil and make farm life more attractive and successful. Farming opportunities, the marketing of produce, the raising of vegetables, fruit and poultry, dairy products, and all phases of agriculture are discussed by an expert. It is the most helpful book on farming ever published. The book is packed with new, practical money-making ideas. 314 pages. Cloth..... 1.25



## CARBOLA

**Saves Time and Labor  
Gives Better Results**

**A MEAN JOB MADE EASY**

The United States Department of Agriculture estimates the loss of farm livestock from contagious diseases at over \$200,000,000 each year. A large part of this stupendous loss could be prevented by proper sanitation in poultry houses, stables and pig pens. In addition to reducing this expense, clean living quarters also help to increase production. Next to a proper supply of feed and water nothing is more important than keeping the buildings clean. Sickness or disease usually start in unclean quarters, and in such quarters lice and mites always are more plentiful.

Carbola is used by thousands of poultry, dairy and breeding farms and by many agricultural colleges and experiment stations to increase the light in their farm buildings, and help put them in that clean, sweet-smelling sanitary condition that is such an aid in avoiding the losses caused by lice, mites and many of the contagious diseases that affect poultry and livestock.

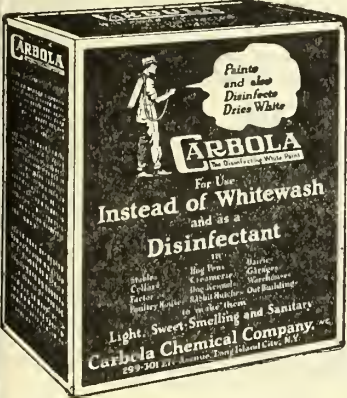

**CARBOLA** is a white paint in powder form combined with a disinfectant many times stronger than pure carbolic acid. It is non-poisonous and non-caustic. It kills lice, mites, fly eggs, etc., and helps prevent the start and spread of contagious diseases that affect man, beast and fowl. **CARBOLA** is two things in one—a paint that disinfects or a disinfectant that paints. It dries a clear snow white. It saves labor, time and money. It paints and disinfects at one operation in the same time and with the same labor required to paint or disinfect only.

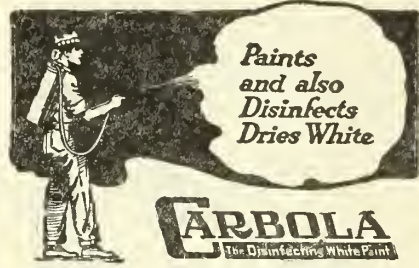

### PRICES

(Paints and disinfects 200 square feet).

5 pounds (5 gallons).....	\$ .75
10 pounds (10 gallons).....	1.25
50 pounds (50 gallons).....	5.00
200 pounds (about 200 gallons).....	18.00

**CARBOLA** is recommended for use instead of whitewash in every place where whitewash ordinarily is used.

- |           |            |              |
|-----------|------------|--------------|
| Garages   | Warehouses | Outbuildings |
| Factories | Cellars    | Tree Trunks  |

It is recommended for use instead of whitewash and disinfectants in

- |                |                |                 |
|----------------|----------------|-----------------|
| Stables        | Rabbit Hutches | Hog Pens        |
| Kennels        | Barns          | Dairy Buildings |
| Poultry Houses | Creameries     |                 |

It is recommended for use as a disinfectant.

## VICTOR

### MICE AND RAT TRAPS.

Made of hard wood blocks, bait hook designed to make catching sure every time. Long clinched staples that can't come out.

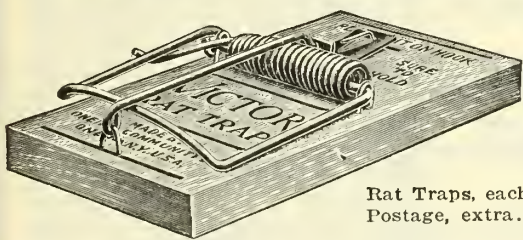
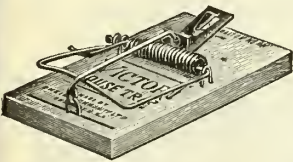

**PRICE:**  
Mice Traps, three for 10 cts.  
Postage, extra, 5 cts.

Rat Traps, each....10 cts.  
Postage, extra..... 5 cts.

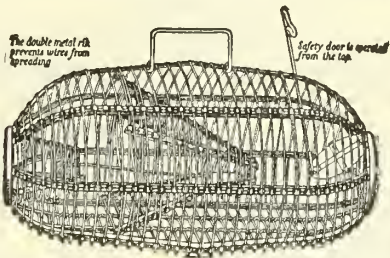

## THE WIRE CAGE RAT TRAP

The size of this trap makes it the ideal for house use. It is strong and will stand rough use. The patent door eliminates all danger from the caged rats. Size—15 inches long, 9 inches wide, 7 inches high. No. 17—Coppered wire; nine sheet-steel flanged ribs.  
**PRICE**.....80c.

## RAT-SNAP!

NO DANGER IN HANDLING—BUT DO NOT EAT

### A FEW POINTERS ABOUT RAT SNAP.

By a newly scientific discovery there is **NO SMELL** after rats and mice eat **Rat-Snap**. By the most careful study of the habits and tastes of rats and mice, **Rat-Snap** is so prepared that rats and mice crave it. It is a dessert for them—the last they eat. They leave all other foods for it, while in the cases of home prepared mixtures they will not touch them at all.

**Rat-Snap** may be dropped in holes or along cellar walls—in fact, all out-of-the-way places. In linen closets without soiling anything.

Keep away from chickens and stock. When used around chickens, ducks, etc., place in holes and cover with a stone.

**PACKAGES**.....15c. and 25c.

## RAX SCIENTIFIC RAT AND MICE DESTROYER



**Rax** is a bacteriological preparation, containing Pure Cultures of an active Virus, which has a deadly effect on **Mice, Rats and Field Mice**, but is harmless to all other animals.

Thus **Rax** is not a poison and may be used without the precaution necessary in handling other rat exterminators.

Rats and Mice having eaten the bait prepared with **Rax** become gradually sick and die within ten to fourteen days. While infected they communicate the **Virus** to other rats and mice coming in contact with them or their haunts. They never die inside the buildings, as they become very feverish and seek the open to get fresh air and water.

**Rax** has no equal as a destroyer of **Rats and Mice**.

Directions with every package. **Price, 75c.**  
By Parcel Post, 85c.

INOCULATE YOUR ALFALFA, CLOVERS, COW PEAS, SOY BEANS, VETCHES, AND ALL OTHER LEGUME CROPS WITH

# Mulford Cultures

**FOR LEGUMES**

**SMALL COST**

**LARGE RETURNS**

**EASY TO USE**

**NO LABOR EXPENSE**



Uninoculated ALFALFA Inoculated Photographed on same scale. Plant on left not inoculated—Plant on right inoculated with **Mulford Culture for Alfalfa**. All other conditions identical.  
**The Contrast Speaks for Itself**

**MULFORD CULTURES** contain pure, tested strains of active, vigorous nitrogen fixing bacteria, for inoculating seeds of legumes or soil. Enormous numbers of these very valuable and desirable bacteria are thus available to you in every package of Mulford Culture and may readily be applied to your seed. The sealed bottle insures purity.

## INCREASE YOUR CROPS IMPROVE YOUR SOIL

**LEGUMES OFFER THE BEST-KNOWN MEANS** of maintaining soil fertility and rejuvenating overcropped and worn-out fields. They add both humus and nitrogen to your soil and thus increase your yield of wheat, cotton, corn and other non-legume crops.

**THE U. S. DEPARTMENT OF AGRICULTURE** and many State Agricultural Experiment Stations recommend inoculation of legumes with nitrogen-fixing bacteria to induce a prompt "catch" and increase your yield.

**MULFORD CULTURES ARE SCIENTIFICALLY PREPARED** and tested by experts, in the biological laboratories of H. K. Mulford Co., Philadelphia, U. S. A., with the same degree of care as Mulford Antitoxins, Serums, Vaccines, etc., which are standard all over the world.

Always specify on your order what crop you want to inoculate, as there is a different strain of bacteria for each legume.

ALFALFA  
CRIMSON CLOVER  
SWEET CLOVER  
WHITE CLOVER  
RED CLOVER

ALSIKE CLOVER  
COW PEAS  
SOY BEANS  
CANADA FIELD PEAS  
VETCH

VELVET BEANS  
SWEET PEAS  
GARDEN PEAS  
GARDEN BEANS  
LIMA BEANS

### PRICES

**MULFORD CULTURES** are supplied for the varieties of legumes listed at the following prices:

5-Acre Size ("A Dollar per Acre").....	\$5.00
1-Acre Size.....	1.50
1/4-Acre Size.....	.75

**Why buy expensive commercial nitrates when you can grow legume crops and thus increase your yield and at the same time increase the nitrates and enrich and renovate your soil, by Nature's own method?**

**FREE DESCRIPTIVE LITERATURE SENT UPON REQUEST.**



## FARMOGERM

### HIGH-BRED NITROGEN-GATHERING BACTERIA

**GIVES NITRATES TO PLANTS,  
INCREASES THE GROWTH,  
AND ENRICHES THE SOIL**

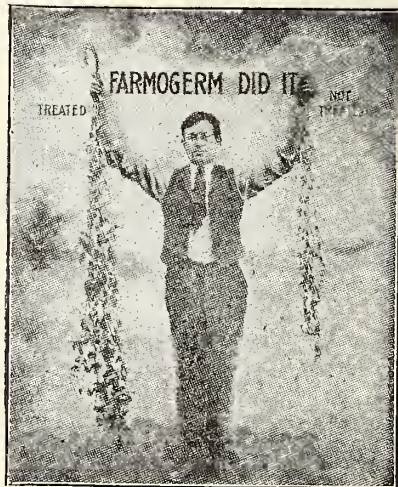

Grow legumes to build up worn-out lands. These crops add humus and nitrogen and make available for plant food the potash and phosphates that are in the soil. All legumes, when properly inoculated, will greatly benefit other crops growing with them, and further deposit large amounts of nitrogen in the soil for future crops. Use only the pure culture of recognized standards.

## FARMOGERM

Will greatly increase your yield and at the same time reduce your Fertilizer bills.  
**FARMOGERM** is prepared for the following legumes: Alfalfa, Crimson, Sweet, White, Red and Alsike Clovers, Cow Peas, Soy Beans, Spring Vetch, Winter Vetch, Canada Field Peas, Sweet Peas, Garden Peas, Lima Beans and Garden Peas.

Garden size for Peas, Beans and Sweet Peas.....	\$.50
One-acre size.....	1.00
Three-acre size.....	2.50
Twelve-acre size.....	9.00

ALL PRICES IN CATALOG SUBJECT TO CHANGE WITHOUT NOTICE.



# HORTICULTURAL TOOLS AND SUPPLIES



## GRASS HOOK

- No. 1 1/2 German Grass Hook.....\$ .70
- No. 2 German Grass Hook..... .75
- Best English Grass—No. 2..... .75
- Best English Grass—No. 3..... .80
- Best English Hedge or Grass Hooks—No. 4... .90
- Atkins' Perfection Grass Hook..... .75
- American—plain..... .50
- American—polished..... .55

## GARDEN TROWELS



- No. 212—American, 16-gauge tool steel, 6-inch blade, a handle that will not come out in dry weather. Price, 40c.
- No. 02—American, 6-inch bright steel blade, plain handle, 15c.

## PLAINTAIN TROWEL



- No. 217—5-inch blade.....20c.
- No. 217—8-inch blade.....35c.

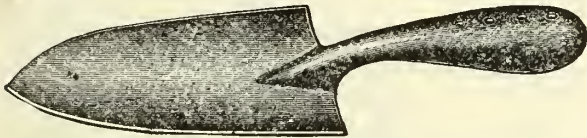

Strong Steel Trowel, with socket handle, very durable. Parcel post weight, 1 pound. Price, 15c.

## EUREKA HAND WEEDER



- A Very Handy and Useful Weeder.
- No. E—Grip handle.....45c.
  - No. EL—2-foot handle.....55c.
- Parcel post weight, 1 pound.

## LARGE HAND WEEDER

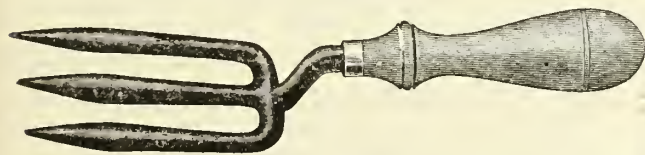

- No. 400—4 Prong Hand Weeder.....35c.
  - No. G—Solid Steel Hand Weeder.....45c.
- Parcel post weight, 1 pound.

## DIBBERS

For transferring plants. By far the best thing for the purpose ever introduced.

Right-angle shape, steel-polished, wood handle, 80c.  
D-handle Dibber, \$1.00.

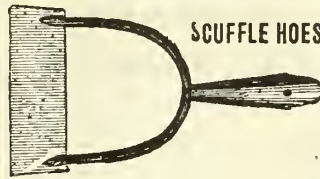
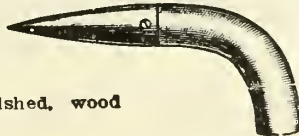

## SCUFFLE HOES

- 6-inch.....\$1.20
- 7-inch.....1.30

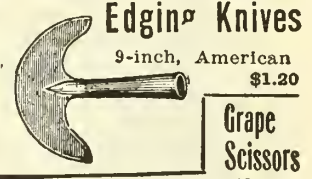

## Edging Knives

9-inch, American \$1.20



## Grape Scissors

- No. 4774 Grape Pickers.....\$ .60
- Flower Scissors.....1.50

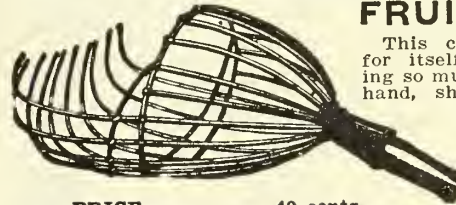

## FRUIT PICKER

This cut almost speaks for itself—the device, being so much like the human hand, shows at once the utility of the article. As a Fruit Picker it has no superior. It is made of heavy wire, and easily adjusted to a pole.

PRICE.....40 cents

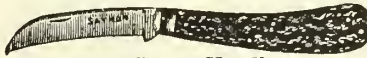

## Pruning Knives

- No. 66105—Cocoa Handle.....\$1.00

## BUDDING KNIVES

- No. 1508R.....\$1.00
- No. 1510B.....1.25

## ASPARAGUS KNIFE



Made of solid steel; see the cutting point. Price.. .40c. each  
Parcel post weight, 1 lb.

## ASPARAGUS BUNCHER

Put your asparagus up in bunches, with this Improved Asparagus Buncher. It is adjustable for all lengths of bundles, correct in design and quick in operation. It makes a well-formed, compact bundle, adding greatly to the looks of the vegetable.

- Price, each.....\$4.00
- Parcel post weight, 5 pounds.

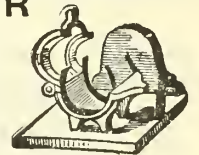

## GARDEN REELS

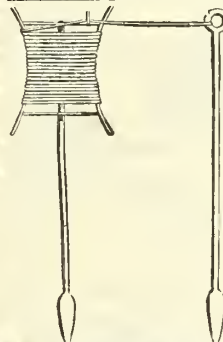

Every gardner should have one of these handy reels. Straight rows add greatly to the looks of the garden. These reels are made of heavy iron, and will last a life time.

- Large size reel to hold 100 feet of line.....\$3.15

## GARDEN LINE.

Best grade 3/16-in. Cotton Garden Line, in any desired length.

- Price, per 100 feet.....\$1.00



MOE'S LINE



MOE'S LINE

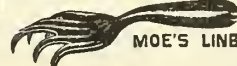

MOE'S LINE

## MOE'S ALL STEEL GARDEN TROWELS AND WEEDERS

Heavy pressed steel black enamel finish with polished points. No loose wooden handles.

- No. 80—Garden trowel, 6-in. blade, Each.....25c.
- No. 81—Transplanting trowel, Each.....25c.
- No. 82—Garden Weeder, Each.....25c.

**HORTICULTURAL TOOLS AND SUPPLIES—CONTINUED**

**"LITTLE WONDER"  
HEDGE TRIMMER**



By having a machine of your own, you can trim your hedge when it needs it and not wait for some one until the hedge has grown straggly and disgraced the entire property for several weeks.

Hedge will improve in appearance after it is trimmed with the "Little Wonder," by reason of the straight

cutting, no dips or round corners and many other common faults often noticed in hedge trimmed by hand shears.

It is not near as hard work trimming with the "Little Wonder" as the hand shears, it does not tire the wrists, in fact, it is a pleasure to walk along the hedge and turn the crank and see the hedge fly, it really operates astonishingly easy.

- 30-inch machine.....\$19.75
- 40-inch machine..... 25.00
- 60-inch machine..... 30.00

**HEDGE SHEARS**

(Plain)

- No. 100—8-inch..\$2.00
- No. 100—9-inch.. 2.25
- No. 100—10-inch.. 2.50
- No. 100—12-inch.. 3.25

(With Notch)

- No. 101—8-inch..\$2.25
- No. 101—9-inch.. 2.50
- No. 101—10-inch.. 2.75
- No. 101—12-inch.. 3.50

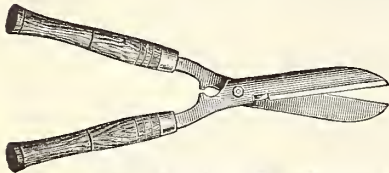

**Lawn Shears**

No. 1062—2 wheels, 8-inch blade, for cutting on narrow borders, under fences and shrubs .\$.45.00

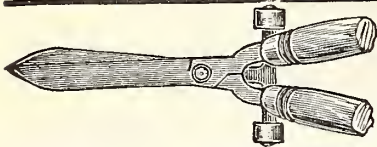

**GRASS SHEARS**



- No. 1360—Bent Handle..35c.
- No. 460—Trowel Handle..60c.

**BORDER SHEARS**



- No. 105
- With Wheel
- Price,
- \$4.25

**Sheep Shears**



- No. 055.....\$1.00
- No. 3755—Full
- polish..... 1.25
- No. 3075..... 1.50

**Pruning Shears**

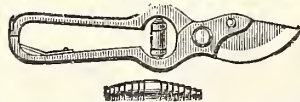

- No. 4—Flat Spring, Steel Blade.....\$.60
  - No. 33—Coil Spring, Mal. Handle, Steel Blade..... .60
  - No. 1537—Solid Steel, half polish, 9-inch..... 1.25
  - No. 4665—Solid Steel, 9-inch..... 1.00
  - No. 4666—Solid Steel, full polish, 9-inch..... 1.50
  - No. 2—French Pruning, 8½-inch..... 1.75
  - No. 544—Ladies', nickel-plated, 6-inch..... 1.75
- Parcel post weight, 1 pound.

**ALL PRICES IN CATALOG SUBJECT TO CHANGE WITHOUT NOTICE.**



**Water's Tree Pruners**

- 4 feet.....\$1.60
- 6 feet..... 1.80
- 8 feet..... 2.00
- 10 feet..... 2.20
- 12 feet..... 2.40
- 14 feet..... 2.60
- Extra Knives..... .20

**Telegraph Tree Pruners**

- Price, without pole.....\$1.40
- Extra blades.....20c.

**Lopping Shears**

The Baltimore Draw Cut Shear is extra strong, and will cut large limbs with the least exertion.

The American or Tip Top Shear is light and strong, and is very handy for light work. It will not tire you to handle it.

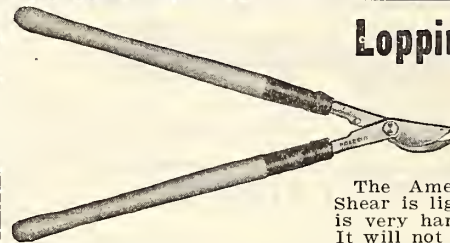

- No. 5—American, or Tip Top.....\$1.60
- No. 4—American, or Tip Top..... 2.00
- No. 5402—Baltimore Draw Cut, 24 in. Handles..... 3.50
- No. 5403—Baltimore Draw Cut, 22 in. Handles..... 3.00

**"McKENNEY" TREE PRUNERS**

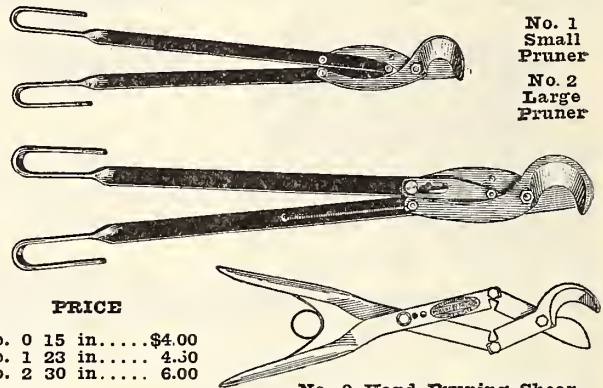

- No. 1 Small Pruner
- No. 2 Large Pruner

**PRICE**

- No. 0 15 in.....\$4.00
- No. 1 23 in..... 4.30
- No. 2 30 in..... 6.00

**No. 0 Hand Pruning Shear**

No. 2 cuts limbs 1½ inches in diameter easy and perfect. It has two cutting blades drop forged from tool steel, and with the patented leverage is the most powerful pruner built.

Besides the double leverage this Pruner has an addition of two separate cutting powers which is provided by the slots in the handles. If any time the blades are wedged in the limb and more power is required it may be obtained by stopping the pressure on the handles and pulling each handle into the middle notch, this change increases the original power 25 per cent.

If more power is required pull the handles into the last notch increasing the power 50 per cent. Two springs are provided which return the blades to their original position after the full amount of leverage has been used.

**PRUNING SAWS**



- No. 3 Saws.**
- 16-inch double.....\$1.35
- 18-inch double..... 1.45
- 20-inch double..... 1.55
- No. 1 Saws.**
- 16-inch single.....\$1.30
- 18-inch single..... 1.40
- 20-inch single..... 1.50

# FLORISTS AND GARDEN SUPPLIES

## PLANT SPRINKLERS

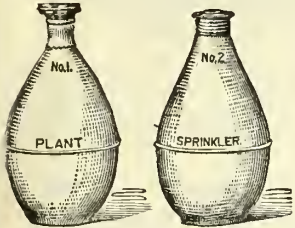

### PUTTY BULB

This Improved Putty Bulb is made from a good grade of rubber. For glazing greenhouses, new or old; will be found very handy.

Price .....\$1.50  
Parcel Post weight, 1 pound.  
We do not guarantee rubber goods.



For sprinkling cut flowers, seedlings, plants, clothes, etc.  
No. 1—Standard, 12-ounce .....\$1.50  
No. 2—Standard, 7-ounce ..... 1.25  
Parcel post weight, 1 pound.

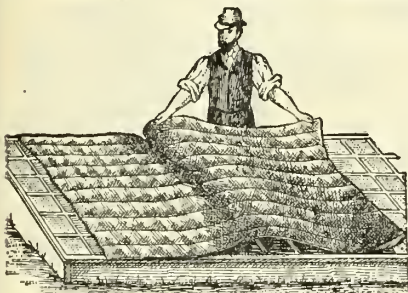

## HOT-BED MATS WOOL-LINED

Made of strong Drill, interlined with wool.

Price, 40 x 76,  
Each, \$1.90

Price, 76 x 76,  
Each, \$3.25

Special Price in  
Dozen Lots.

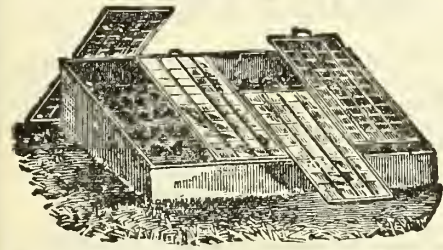

## UNGLAZED HOT-BED SASH

3 ft. 2 in. x 6 ft.

Price, \$2.25 each.

## PEERLESS GLAZING POINTS

(Imp. Van Reyper.)

The finest glazing points on the market. The glass cannot slip; they are quickly and easily put in with special pincers; no "rights" or "lefts" to bother with.

Per box of 1,000 .....75c.  
Pincers, per pair .....85c.  
Parcel post weight, 2 pounds.

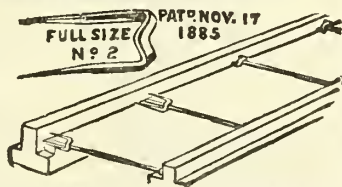

## MARLINE

Furnished in 1, 5, 10, 15 and 20-pound bales.

5-Pound Bales .....35c. per pound  
1-Pound Bales .....40c. per pound

Special Prices in Quantities.

## RAFFIA

The best material for tying Plants, Vines, etc.  
Per Pound .....20c.

## SPHAGNUM MOSS

For packing growing Orchids, Plants, etc. Per bale.....\$3.25

## GRAFTING WAX

¼-lb.....15c. ½-lb.....25c. 1-lb.....40c.

## MASTICA

Mastica.—For glazing greenhouses, sashes, new and old. It is elastic, adhesive and easily applied. It is not affected by dampness, heat or cold. "Mastica," when applied, in a few hours forms a skin or film on the entire mass, hermetically sealing the substance and preventing the evaporation of the liquids, and remains in a soft, pliable, and elastic condition for years. "Mastica" is of great value in going over old houses with a putty bulb or machine on the outside of sash, as it makes it perfectly tight and saves the expense of relaying the glass.

1-Gallon Cans .....\$2.25



## MASTICA GLAZING MACHINE OUR SPECIAL PRICE.....\$2.85

## Iron Clad Watering Pots

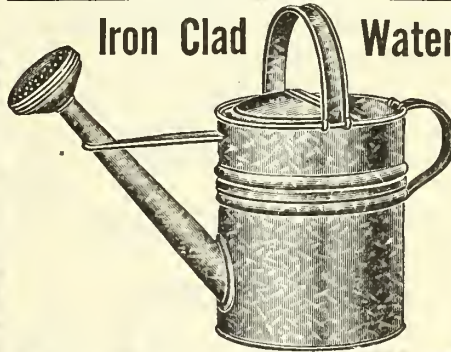

4-qt. ....\$0.70  
6-qt. .... .80  
8-qt. .... .90  
10-qt. .... 1.05  
12-qt. .... 1.30  
16-qt. .... 1.45

These pots are made from the best grade of galvanized iron, and are very heavy and strong. The long spout makes them very desirable for greenhouse and flower bed use. Each can is equipped with a fine and coarse nozzle, with copper perforation.

6-quart.....\$4.50  
8-quart..... 4.90  
10-quart..... 5.25  
12-quart..... 5.80

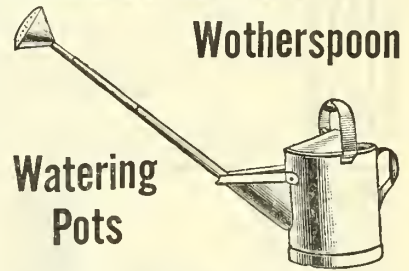

## Watering Pots

## Wotherspoon

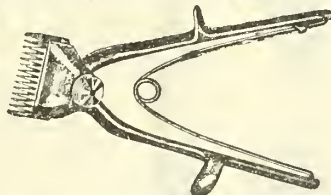

## TOILET AND FETLOCK CLIPPERS

No. 71—Fetlock Clipper.....\$1.40  
A1 Toilet Clipper..... 1.50  
Parcel post weight, 1 pound.

## Horse or Dog Clippers

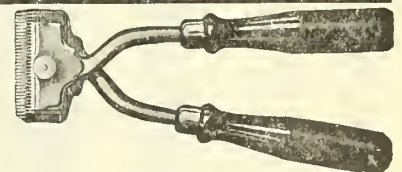

No. 159—Coates' Ball-Bearing Horse Clipper.....\$3.00  
Parcel post weight, 2 pounds.

**FLORIST AND GARDEN SUPPLIES--Continued**



**POT LABELS**

	Plain. Painted.	
4 -inch, per 1000..	\$1.55	\$2.00
4½-inch, per 1000..	1.70	2.25
5 -inch, per 1000..	1.90	2.45
6 -inch, per 1000..	2.35	2.95
12 -inch, per 100...	1.10	
Special price in quantities to florists.		

**PAINTED TREE LABELS**

	Per 1000
3½-inch, notched.....	\$1.90
3½-inch, iron wired.....	2.35
3½-inch, copper wired.....	2.70

**HEAVY OR DAHLIA STAKES**

	Each.	Per Doz.	Per 100.
2 feet.....	12c.	\$1.35	\$9.90
4 feet.....	17c.	1.80	13.10
5 feet.....	20c.	2.20	16.80
6 feet.....	25c.	2.85	20.60

**LIGHT PLANT STAKES**

	Each.	Per Doz.	Per 100.
1½ feet.....	3c.	\$ .30	\$1.75
2 feet.....	5c.	.45	3.25
2½ feet.....	8c.	.65	4.75
3 feet.....	10c.	.85	6.25

**CANE STAKES**

5 to 7 feet long.  
Per 100.....\$ .75. Per 1,000.....\$6.00

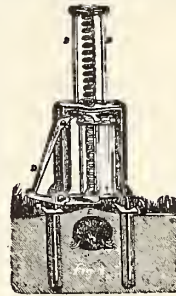

**L. M. OLMSTEAD'S IMPROVED RELIABLE MOLE TRAP**

Without a doubt, the best mole trap made, built so that you can place a weight upon it, insuring perfect action, even in the softest ground. It is built low, and can be used in many places that a taller trap would not do.

**OUR SPECIAL PRICE.....\$2.50**  
Parcel post weight, 2 pounds.

**OUT-OF-SIGHT MOLE TRAP**

Considered to be one of the best and cheapest Mole Traps on the market. Especially valuable for hot-beds and frames on account of convenient size.

**PRICE.....\$1.25**  
Parcel post weight, 2 pounds.

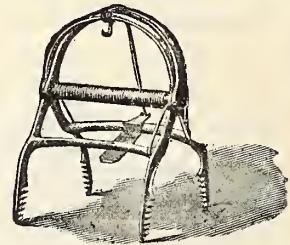

**THE LITTLE GIANT MOLE TRAP**

Self-setting by pressing down on lever. Very convenient feature found on no other trap. Made from best spring steel, thoroughly galvanized. Simple and durable in its construction.

**PRICE.....\$1.00**  
Parcel post weight, 2 pounds.



**THERMOMETERS**

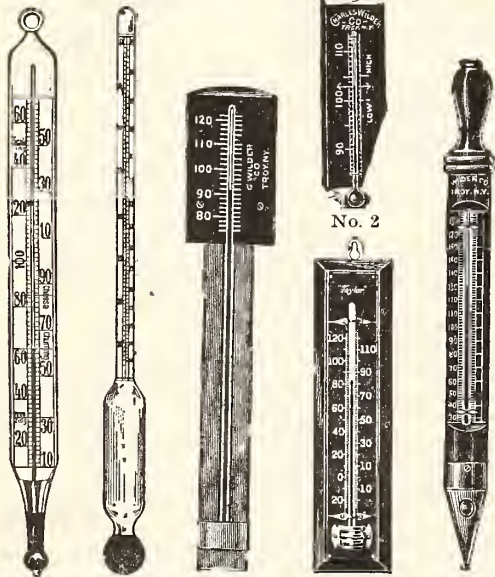

No. 5120—6-inch Cabinet, magnifying tube, black oxidized scale, white figures and graduation, brass screw clasps and guard, back of oak finished, natural.....\$1.25

No. 5140—8-inch Cabinet, magnifying tube, black oxidized brass scale, white filled figures, nickled straps and guard, wood back, finished in birch .....75c.

No. 5440—8-inch tin japanned.30c.  
No. 5442—12-inch Tobacco Curing, best quality, tested.....75c.

No. 5162—10-in. Distance Reading; an excellent thermometer for green-houses and for use where it is necessary to get a quick reading....40c.

No. 2—Universal Incubator Thermometer may be used for a stand-up, or reclining with proper holder. With holder, each.....\$1.00

No. 6—Brooder Thermometer for Prairie State Brooders, each....75c.

No. 5452--Self-Registering, box-wood scale, black filled figures, japanned tin case, 10-in.....\$6.00

No. 5981—Hot Bed, 16-in., wood frame, with handle, brass pointed ferrule, brass oxidized scale, white-filled figures and graduations.....\$2.25

No. 5730—Standard Dairy, stands boiling water; black oxidized brass scale, white-filled figures and graduations, range from 20 to 220 degrees .....\$1.25

No. 3740—Floating Glass Dairy 35c.

No. 7236—Milk Hydrometer (Quevne) .....\$1.50

No. 7410—Lime-Sulphur Hydrometer.....\$1.50

No. 7410—Lime-Sulphur Hydrometer, with test jar.....\$2.25

If thermometers are wanted by parcel post, add 10 cents for postage and packing.

No. 3740 No. 7410 No. 6. No. 5120 No. 5981

ALWAYS ORDER BY FIGURE AND NUMBER WHERE GIVEN

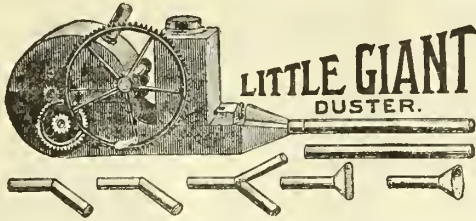

**LITTLE GIANT  
DUSTER.**

This Duster is somewhat like the Champion Duster, except it is lighter and has a smaller capacity. A fine machine for use on small places. And will do the work well. It is nicely made and very strong. Illustration shows pipes and nozzle.

**OUR SPECIAL PRICE** ..... \$11.00

## LEGGETT'S CHAMPION DRY POWDER DUSTER

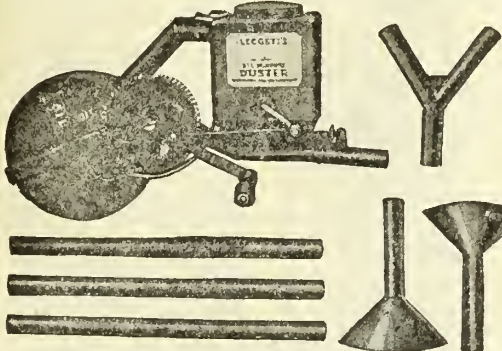

Dusts potato vines as fast as you walk, two rows at a time. Illustration below shows tubing and nozzles. Anyone can use it.

Weights, cased for shipping, 17 lbs.

**PRICE** ..... \$15.50

## LEGGETT'S STANDARD DUSTER FOR HEAVY DUTY

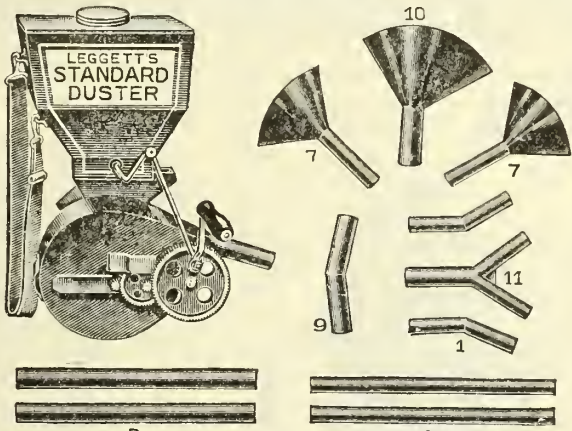

**PRICE** ..... \$18.00

## AUTO SPRAY No. 5

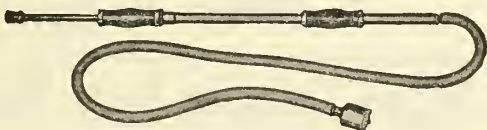

**GENERAL PURPOSE HAND PUMP**

It is made entirely of brass, doing away with all danger of corrosion. The pump is double-acting. This feature makes the spray continuous. Anyone who has used a single acting pump of this kind will immediately recognize the advantage in a pump that works on both the up and down stroke. The pump itself is so constructed that it can be taken apart.

**OUR SPECIAL PRICE** ..... \$4.50

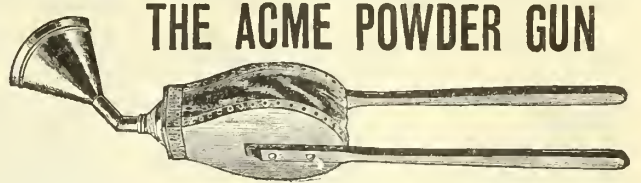

## THE ACME POWDER GUN

Consists of a tight valveless bellows equipped with a distributing tube or nozzle, a funnel, a spreader for diffusing the spray and an elbow for placing the spray on the underside of the leaves. Handles of convenient length and bellows of fine russet leather. A very practical and convenient way of applying Paris Green, Lice Killers, Insect Powder, etc. Parcel post weight, 2 pounds. **OUR SPECIAL PRICE, \$1.50.**

## Midget Tin House Sprayer

Similar to Tin Can Sprayer, only smaller. Holds half pint. Indispensable in every household. Just the thing for disinfecting sick rooms, drains, vaults, kennels, etc. Also rose bushes or any small shrubbery. Will successfully apply any non-sedimental liquids. Parcel post weight, 1 pound. **Price 35 cents.**

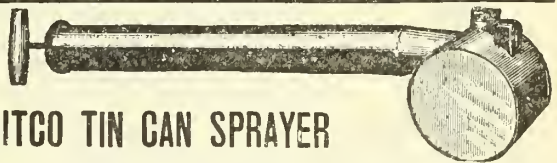
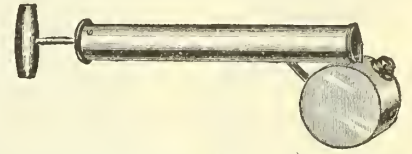

## GRITCO TIN CAN SPRAYER

For spraying insecticides on plants and flowers, disinfectants in sick rooms, kennels, cellars, drains, vaults, poultry houses, etc.

Tank, 4 inches in diameter, 4 inches deep; air chamber, 1 1/4 inches long, 1 3/4 inches in diameter. Coppered steel plunger rod. Made of heavy tin plate. Each one tested for leaks and sprays. Capacity, one quart. Parcel post weight, 2 pounds. **OUR SPECIAL PRICE** ..... 50c

## AUTO COMPRESSED AIR SPRAYER

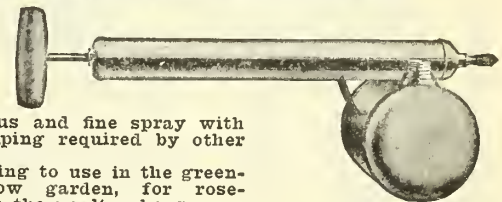

A continuous and fine spray with half the pumping required by other atomizers.

Just the thing to use in the greenhouse, window garden, for rose-bushes and in the poultry house.

Will handle all solutions, insecticides and disinfectants. Made throughout of stout material. Copper syphon tube, bronze ball valve, plunger rod, 1/4-inch, copper plated steel. The solution does not come in contact with the pump cylinder. The spray may be adjusted by a slight turn of the nozzle cap.

- No. 25-A. All Tin ..... \$1.00
- No. 25-B. Tin Pump and Galvanized Reservoir ..... 1.25
- No. 25-C. Tin Pump and Brass Reservoir ..... 1.50
- No. 25-D. 1/2 Gallon Galvanized Reservoir ..... 1.50
- No. 25-E. 1/2 Gallon Brass Reservoir ..... 1.75

## B. D. SIFTER



Made from heavy tin, bottom and side perforated. Can be adjusted to put on a small or large quantity of dust on potatoes or other vines. Parcel post weight, 2 pounds. **PRICE** ..... 75c.

## DICKEY DUSTER

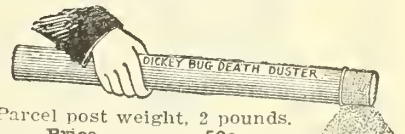

Parcel post weight, 2 pounds. **Price** ..... 50c.

**LEVER BUCKET SPRAY PUMPS**

Fig. 632.

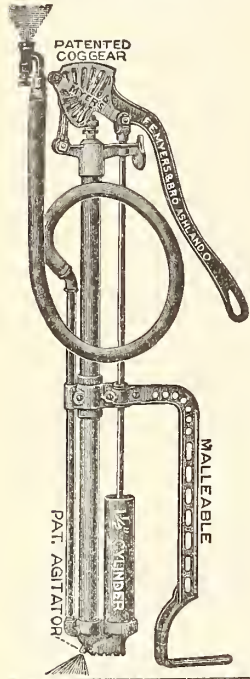

Fig. 632 represents the Myers Lever Bucket Spray Pump, made of brass, and fitted with brass ball valves and patented agitator. The cylinder is 1½ inch in diameter with solid plunger. The air chamber is fifty per cent larger than the ordinary bucket spray pump, has malleable iron foot rest and malleable lever. This pump can be operated with one-half the power of the ordinary bucket spray pump, owing to the advantage of the lever handle. This pump can also be used as a barrel spray pump the head having two holes in for bolting same to the barrel.

We recommend a Bordeaux Spray Nozzle for whitewashing and painting, if you desire the Vermorel Nozzle instead of the Bordeaux, please specify.

Fig. 632, No. R 324 Lever Bucket Spray Pump, with agitator, complete with hose, Bordeaux, coarse spray and solid stream nozzle.

**Our Special Price...\$7.00**

No. R 324A Lever Bucket Spray Pump, with agitator, complete with hose, Bordeaux, coarse spray and solid stream nozzle and eight foot pipe extension.

**Our Special Price...\$7.65**

No. R 324B Lever Bucket Spray Pump, with agitator complete with hose, Bordeaux coarse spray and solid stream nozzle and eight foot pipe extension with stopcock.

**Our Special Price...\$8.65**

**LITTLE GIANT BRASS SPRAY PUMP AND FIRE EXTINGUISHER WITH AGITATOR**

Fig. 639.

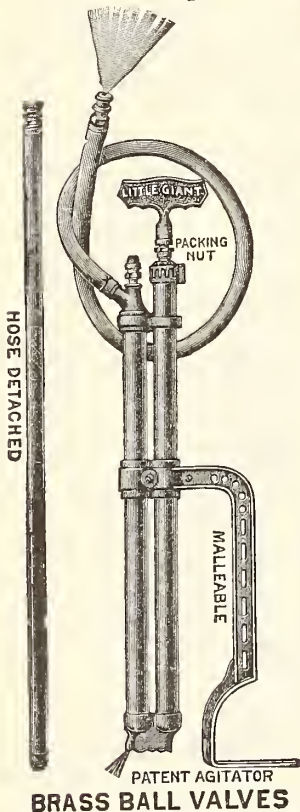

**AND FIRE EXTINGUISHER WITH AGITATOR**

Fig. 639 Spray Pump is constructed entirely of brass. They are so arranged that the labor of pumping is all on the downward stroke of the piston and nothing on the up. The effect of this operation while pumping is to hold the pump down. The foot rest steadies the pump, holding it in proper position. It is provided with a large air chamber and has brass ball valves and detachable hose; the nozzle throws a continuous spray, and is not affected by the movement of the plunger. Will throw a solid stream fifty feet, and is of unusual value in spraying trees, washing windows and buggies, extinguishing fires, spraying flowers and etc.

No. 327½, Fig. 639. Bucket Brass Spray Pump, complete with hose and combination fine, coarse spray and solid stream nozzle.

**Our Special Price.....\$4.50**

No. 328, Fig. 639. Bucket Brass Spray Pump, complete with hose and combination fine, coarse spray and solid stream nozzle. and an eight-foot pipe extension.

**Our Special Price...\$5.15**

**THE MYERS WHITEWASH, GOLD WATER PAINTING MACHINE AND GENERAL PURPOSE SPRAYER No. 329**

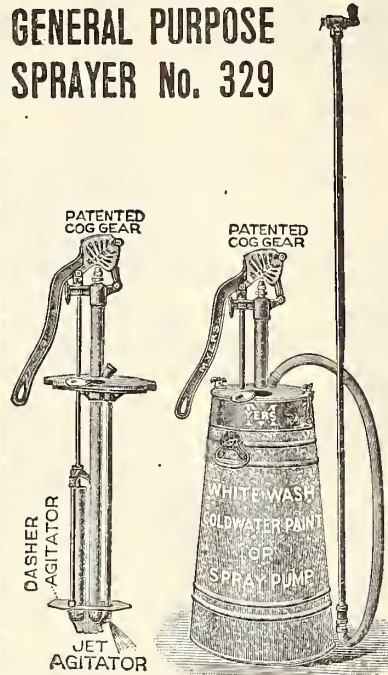

This General Purpose Sprayer with patent Double Agitator is a most complete and serviceable outfit. The tank is made of heavy galvanized iron with a wide bottom so as to set steady in operation. The cover is removable, is held securely in place by two thumb nuts, one on each side, which holds the cover tight and prevents spilling or splashing of the liquid. Holds 7 gallons.

This is an excellent outfit for whitewashing chicken houses, fences and outbuildings. For spraying trees, shrubbery, plants and in fact anything where a small sprayer can be used. This outfit will be found just the thing.

The pump used in this outfit is the same as the No. 324 Sprayer as shown under Fig. 632, fitted with Bordeaux nozzle, brass ball valves and has jet and dasher agitator.

Complete with Hose, Nozzle, Agitator and Extension Rod.

**Our Special Price, \$13.50**

**THE LEVER KNAPSACK SPRAY PUMP**

Fig. 547.—No. 330 Galvanized.

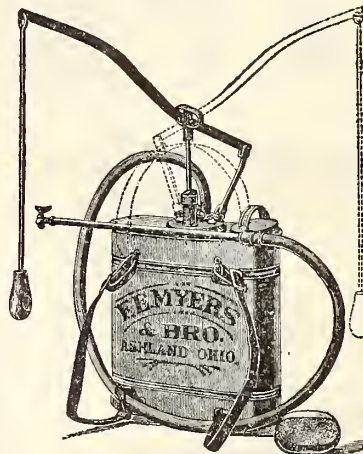

Tank holds 5 gallons, is fitted with lid, and strainer, which can be removed. This Pump has lever, large air chamber, ball valves, solid plunger and agitator. Fitted with 5 feet ½-inch hose, pipe extension and Bordeaux spray nozzle; can be graduated from a fine mist to a solid stream, or shut off entirely.

**Our Special Price, \$12.50**

**The Perfect Knapsack Spray Pump**

Fig. 547.—No. 331. Copper.

Is the same as No. 330, except tank is constructed entirely of copper. Complete with hose, stop-cock, pipe extension and Bordeaux nozzle.

**Our Special Price.....\$20.00**

**FOR SPRAYING MATERIALS, SEE PAGES 76 TO 79**

ALWAYS ORDER BY FIGURE AND NUMBER WHERE GIVEN

## AUTO SPRAY No. 1

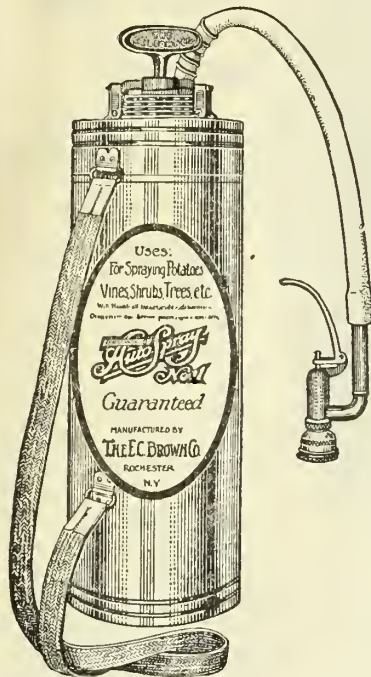

Weight empty, 7 lbs.  
Weight loaded, 39 lbs.  
Weight shipping, 15 lbs.  
**A Self-Operating or Automatic Sprayer.**

The Auto-Spray No. 1 is one of the best on the market. It is very strong and practical. When properly charged contains three gallons of solution and one gallon of compressed air. Ten to twelve strokes of the plunger will compress the air and two pumpings will empty the entire contents.

All parts which come in contact with solution are made of brass, and the handle and other parts are made of malleable iron.

Length of cylinder, 21 inches; diameter of cylinder, 7 inches; capacity, about 4 gallons; weight, empty, 7 pounds.

**Auto-Spray No. 1C—Galvanized Reservoir, Stop Cock. Our Special Price, \$6.00.**

**Auto-Spray No. 1D—Galvanized Reservoir, Auto-Pop. Our Special Price, \$6.50.**

**Auto-Spray No. 1A—Brass Reservoir, Stop Cock. Our Special Price, \$9.00.**

**Auto-Spray No. 1B—Brass Reservoir, Auto-Pop. Our Special Price, \$9.50.**

- Auto-Pop Nozzles . . . . . \$1.50
- Extension Pipe, brass, 2-foot length, 50c.; galvanized . . . . . .40
- Brass Elbow Extension . . . . . .35
- Double Row Attachment . . . . . 1.50
- Brass Strainer for straining solutions used in Auto-Spray . . . . . 1.20

## AUTO SPRAY No. 40B

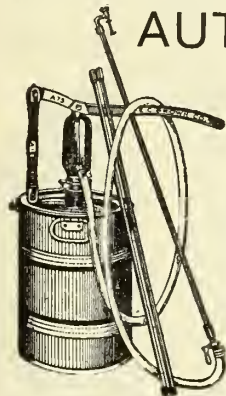

Capacity, 8 gallons.  
Net weight, 33 pounds.  
Shipping weight, 45 pounds.

The Auto-Spray No. 40B is especially adapted for spraying whitewash, cold-water paint, as well as for spraying trees, garden vegetables, vines and plants.

Correctly designed on mechanical principles, with every unnecessary part eliminated.

The machine is equipped with 8-foot high-grade spray hose, 8-foot iron extension rod, lever shut-off and latest pattern Vermorel Nozzle.

**Auto-Spray No. 40B, with 8-gallon galvanized tank equipped as described above.**

**OUR SPECIAL PRICE . . . . . \$17.40**

## AUTO SPRAY No. 40D

The Auto-Spray No. 40D is mounted on a steel truck, with a 20-inch steel wheel with a broad tire, and is especially adapted for garden, lawn and vineyard work.

The tank is made of heavy galvanized steel with a broad, flat bottom, which rests firmly on the ground while in operation.

Plunger Brass 1½ inches in diameter, 3 to 4½-inch stroke as desired. The plunger operating in connection with the air chamber ensures greater reserve capacity than is usually found in this size machine. Plunger style pump. Graphite packing adjustable from the outside by tightening two bolts. Brass ball valves. Suction pipe fitted with brass strainer. Mechanical agitator operated from the handle.

The top casting on tank has broad flange, which prevents the solution from slopping over. Equipped with 8 ft. ¾ heavy spray hose, 8 ft. iron extension, lever shut-off and latest pattern Vermorel nozzle.

Repair list, with formula for mixing whitewash and cold-water paint, with each machine.

**Price, complete with 12-gallon galvanized steel tank, \$26.00**

## Double-Acting Spray Pump

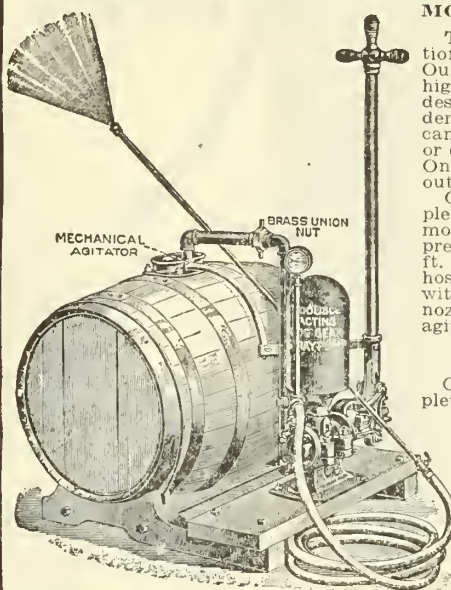

**MOUNTED ON SKIDS**

The general construction of this Spray Pump Outfit cannot be too highly commended. This desirable outfit meets the demand for a pump that can be used in a wagon or cart. It cannot upset. One of the most desirable outfits on the market.

Outfit A—Pump, complete, 50-gallon barrel mounted on skids, with pressure gauge; one 15-ft. lead ½-in. discharge hose, 8-ft. pipe extension with lever shut-off, spray nozzle and mechanical agitator.

**Price . . . \$54.00**

Outfit B—Pump, complete, 50-gallon barrel mounted on skids, with pressure gauge; two 15-ft. leads of ½-in. c h. discharge hose, 8-ft. pipe extension with lever shut-off, spray nozzle and mechanical agitator.

**Price . . . \$60.00**

## SPRAYING TANK

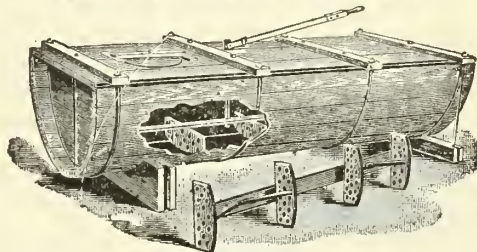

We are having our Spray Tanks made of 1½-inch clear cypress, which has proven to be the best material for this purpose. The tanks are gripped with steel rods.

Style No. 2—Weight, 175 lbs.; capacity, 150 gallons; dimensions, 4 feet long, 3 feet wide, 2 feet 6 inches high.

**Price, complete, without Agitator, but with Bolsters.**

**OUR SPECIAL PRICE . . . . . \$32.00**

**Other sizes quoted on application.**

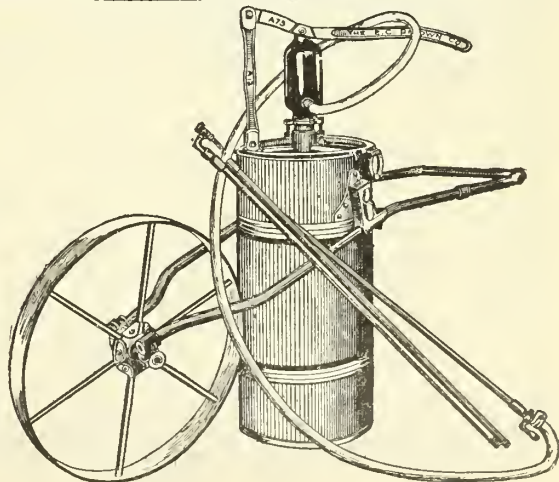
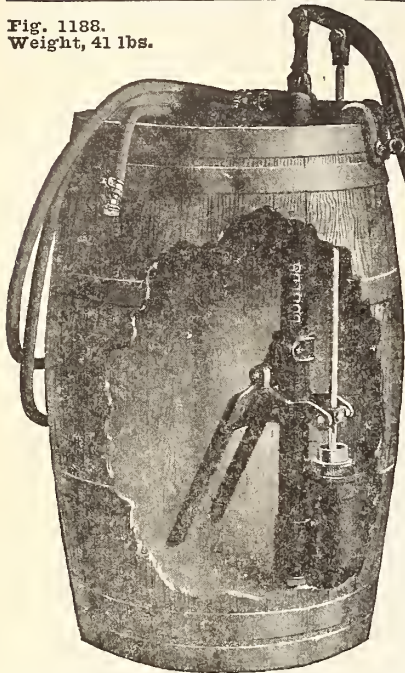

Fig. 1188.  
Weight, 41 lbs.

## GOULD'S "Fruitall" Spray Pump



**All Working Parts Bronze.**  
The Fruitall Sprayer is first-class in every respect. While the simplicity of its design allows it to be sold at a very reasonable price, and although lighter in weight and smaller in capacity than the "Pomona," we offer it as a thoroughly serviceable sprayer. The sprayer is held in place in the barrel by an adjustable clamp at

the top fitting over the end of a stave, and an anchor at the bottom of the barrel. The plunger is packed from the outside, so it is not necessary to take the entire pump apart to repack.

**Plunger, 2 inches diameter; stroke, 4 inches.**

	List Price.	Special Price.
Fig. 1188.—Pump only with Agitator and Hose Couplings .....	\$19.20	\$12.00
Fig. 1188.— <b>Outfit A.</b> —Pump with Agitator, Hose Bands and Couplings and one Mistry, Jr. Nozzle for one lead of hose, but without Hose..	21.52	13.45
Fig. 1188.— <b>Outfit B.</b> —Pump with Agitator, Hose Bands and Couplings, one Mistry, Jr. Nozzle and 15-foot lead No. 1 Spray Hose.....	25.12	15.70
Fig. 1188.— <b>Outfit C.</b> —Pump with Agitator, Hose Bands and Couplings, one Mistry, Jr. Nozzle, one 15-ft. lead No. 1 Spray Hose, fitted in barrel	35.12	20.70
Fig. 1188.— <b>Outfit D.</b> —Pump with Agitator, Hose Bands and Couplings, one Mistry, Jr. Nozzle, one 15-foot lead No. 1 Spray Hose, 8-foot Iron Extension Rod with Brass Stop-Cock, fitted in Barrel .....	37.76	22.35
Fig. 1188.— <b>Outfit E.</b> —Pump with Agitator, Hose Bands and Couplings, Two Mistry, Jr. Nozzles, two 15-foot leads No. 1 Spray Hose.....	32.80	20.50
Fig. 1188.— <b>Outfit F.</b> —Pump with Agitator, Hose Bands and Couplings, two Mistry, Jr. Nozzles, two 15-foot leads No. 1 Spray Hose, fitted in Barrel .....	42.80	25.50
Fig. 1188.— <b>Outfit G.</b> —Pump with Agitator, Hose Bands and Couplings, two Mistry, Jr. Nozzles, two 15-foot leads No. 1 Spray Hose, two 8-foot Iron Extension rods with Brass Stop-Cocks, fitted in Barrel.....	48.80	28.80
Fig. 1188.— <b>Outfit H.</b> —Pump with Agitator, Hose Bands and Couplings, one Mistry, Jr. Nozzle, one 15-foot lead No. 2 Wire-Wound Spray Hose	25.84	16.15
Fig. 1188.— <b>Outfit J.</b> —Pump with Agitator, Hose Bands and Couplings, one Mistry, Jr. Nozzle, one 15-ft. lead No. 2 Wire Wound Spray Hose, fitted in Barrel.....	35.84	21.15
Fig. 1188.— <b>Outfit K.</b> —Pump with Agitator, Hose Bands and Couplings, one Mistry, Jr. Nozzle, one 15-foot lead No. 2 Wire Wound Spray Hose, 8-foot Iron Extension Rod with Brass Stop-Cock, fitted in Barrel.....	38.48	22.80
Fig. 1188.— <b>Outfit L.</b> —Pump with Agitator, Hose Bands and Couplings, two Mistry, Jr. Nozzles, two 15-ft. leads No. 2 Wire-Wound Spray Hose.	34.08	21.30
Fig. 1188.— <b>Outfit M.</b> —Pump with Agitator, Hose Bands, and Couplings, two Mistry, Jr., Nozzles, two 15-foot leads No. 2 Wire Wound Spray Hose, fitted in Barrel.....	44.08	26.30
Fig. 1188.— <b>Outfit N.</b> —Pump with Agitator, Hose Bands, and Couplings, two Mistry, Jr., Nozzles, two 15-foot leads No. 2 Wire Wound Spray Hose, two 8-foot Iron Extension Rods with Brass Stop-Cocks, fitted in Barrel.....	49.36	29.60
No. 1 Spray Hose, in longer lengths, per foot....	.24	.15
No. 2 Spray Hose, in longer lengths, per foot....	.30	.18

ALL PRICES IN CATALOG SUBJECT TO CHANGE WITHOUT NOTICE.

Fig. 1100.  
Weight, 66 lbs.

## GOULD'S POMONA Spray Pump

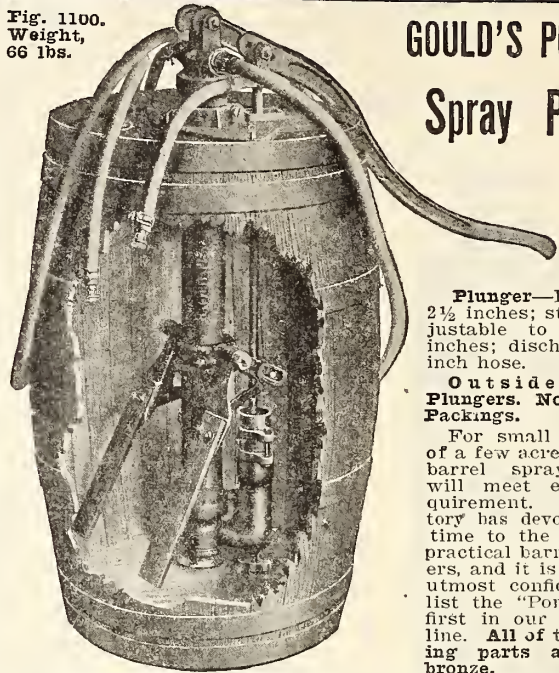

**Plunger**—Diameter, 2½ inches; stroke, adjustable to 3, 4, 5 inches; discharge, ½-inch hose.

**Outside Packed Plungers. No Leather Packings.**

For small orchards of a few acres; a good barrel sprayer that will meet every requirement. The factory has devoted much time to the study of practical barrel sprayers, and it is with the utmost confidence we list the "Pomona" as first in our complete line. All of the working parts are solid bronze.

The pump has a steel air chamber, extending from top of pump to valve chamber, making it easy to get up sufficient pressure to continue spraying for some time after pumping has stopped. It is equipped with a long adjustable handle. The pump may be placed in any length barrel, as the barrel plate is adjustable. The agitator is simple, but very effective.

	List Price.	Special Price.
Fig. 1100.—Pump only with Agitator and Hose Coupling .....	\$35.20	\$22.00
Fig. 1100.— <b>Outfit A.</b> —Pump with Agitator, Hose Bands and Couplings and one Mistry, Jr. Nozzle for one lead, but without Hose.....	37.52	23.45
Fig. 1100.— <b>Outfit B.</b> —Pump with Agitator, Hose Bands and Couplings, one Mistry, Jr. Nozzle and 15-foot lead No. 1 Spray Hose.....	41.12	25.70
Fig. 1100.— <b>Outfit C.</b> —Pump with Agitator, Hose Bands and Couplings, one Mistry, Jr. Nozzle, one 15-foot lead No. 1 Spray Hose, Fitted in Barrel .....	51.12	30.70
Fig. 1100.— <b>Outfit D.</b> —Pump with Agitator, Hose Bands and Couplings, one Mistry, Jr., Nozzle, one 15-ft. lead No. 1 Spray Hose, 8-foot Iron Extension Rod with Brass Stop-Cock, fitted in Barrel .....	53.76	32.35
Fig. 1100.— <b>Outfit E.</b> —Pump with Agitator, Hose Bands and Couplings, Two Mistry, Jr. Nozzles, two 15-foot leads No. 1 Spray Hose.....	48.16	30.10
Fig. 1100.— <b>Outfit F.</b> —Pump with Agitator, Hose Bands and Couplings, 2 Mistry, Jr. Nozzles, 2 15-ft. leads No. 1 Spray Hose, fitted in Barrel..	58.16	35.10
Fig. 1100.— <b>Outfit G.</b> —Pump with Agitator, Hose Bands and Couplings, Two Mistry, Jr. Nozzles, two 15-foot leads No. 1 Spray Hose, two 8-foot Iron Extension Rods with Brass Stop-Cocks, fitted in Barrel.....	63.44	38.40
Fig. 1100.— <b>Outfit H.</b> —Pump with Agitator, Hose Bands and Couplings, one Mistry, Jr. Nozzle, one 15-foot lead No. 2 Wire-Wound Spray Hose....	41.84	26.15
Fig. 1100.— <b>Outfit J.</b> —Pump with Agitator, Hose Bands and Couplings, one Mistry, Jr. Nozzle, one 15-foot lead No. 2 Wire Wound Spray Hose, fitted in Barrel.....	51.84	31.15
Fig. 1100.— <b>Outfit K.</b> —Pump with Agitator, Hose Bands and Couplings, one Mistry, Jr. Nozzle, one 15-foot lead No. 2 Wire Wound Spray Hose, 8-foot Iron Extension Rod with Brass Stop-Cock, fitted in Barrel.....	54.48	32.80
Fig. 1100.— <b>Outfit L.</b> —Pump with Agitator, Hose Bands and Couplings, two Mistry, Jr. Nozzles, two 15-ft. leads No. 2 Wire-Wound Spray Hose.	49.60	31.00
Fig. 1100.— <b>Outfit M.</b> —Pump with Agitator, Hose Bands and Couplings, two Mistry, Jr., Nozzles, two 15-foot leads No. 2 Wire Wound Spray Hose, fitted in Barrel.....	59.60	36.00
Fig. 1100.— <b>Outfit N.</b> —Pump with Agitator, Hose Bands and Couplings, two Mistry, Jr. Nozzles, two 15-foot leads No. 2 Wire Wound Spray Hose, two 8-foot Iron Extension Rods with Brass Stop Cocks, fitted in Barrel.....	64.88	39.30
No. 1 Spray Hose, in longer lengths, per foot....	.24	.15
No. 2 Spray Hose, in longer lengths, per foot....	.30	.18



## THE MYERS POWER SPRAY GUN

LENGTH OVER ALL, 26 INCHES.

Utilizes the Entire Capacity of any Power Spray Pump and Does Away With All Bamboo Extensions, Nozzles and Fittings.

All Working Parts on the Outside. Not Subject to Corrosion. Fig. 1824.



Fitted for 3/4-inch Hose Coupling and 1/4-inch Pipe.  
LIST PRICE, \$9.60. OUR SPECIAL PRICE, \$6.00

## The Myers Overhead Sprayer

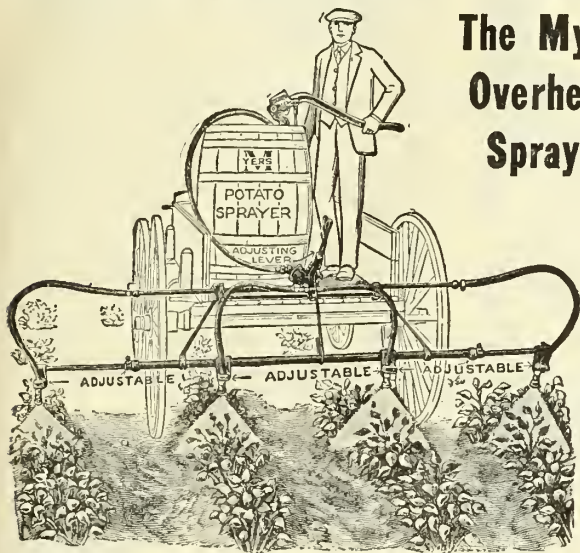

**FOR POTATOES, COTTON OR OTHER FIELD CROPS**  
Nozzles Adjustable to Any Required Height and to Any Width Row.

No. 6, Myers Hand Overhead 4 Row Adjustable Sprayer Complete with all necessary Hose and Nozzles, (Pump and Barrel not included).

LIST PRICE \$43.20. OUR SPECIAL PRICE, \$27.00

## PYRENE

FIGHT FIRES AT THEIR  
START

SAFEGUARD YOUR  
PROPERTY WITH  
PYRENE

The surest way to avoid serious fires is to have **Pyrene** on hand when the fire comes. It may save your home, your barn, your stock your crops your machinery and your automobile. **Pyrene** is a great economy even if you never have to use it because of the reduced rates you can obtain if you have it.

All insurance companies in the United States allow 15 per cent. reduction in automobile fire insurance rates if car is equipped with **Pyrene** Extinguisher.

**PRICE**

Brass Extinguishers.....\$10.00  
Liquid, per quart..... 1.50  
Guardene Fire Extinguisher..... 2.00

Write for booklet:

"THE VITAL FIVE MINUTES."



## Gould's New Combination Hand and Power Sprayer

Vertical Outside Packed, Bronze Plungers,  
Bronze Glands, Valves, Etc.

High-Grade Sprayer for Orchard Work.  
Also for Whitewashing.

**Fig. 1640**—Has two bronze plungers operating in two vertical cylinders, which are packed with a material unaffected by spraying solutions. This construction permits all gritty particles to pass through valves and out; does not grind the cylinder. Ports are large and direct. Valves are bronze, ground to fit their bronze seats, are accessible through handholes. This is the easiest operated Pump of its capacity on the market. **Diameter of Cylinder, 2 inches; Suction Hose, 3/4 in.; Discharge Hose, 1/2 in.**

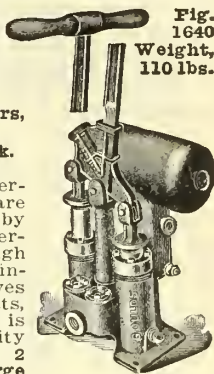

Fig. 1640  
Weight,  
110 lbs.

	List Price.	Our Special Price.
<b>Fig. 1640</b> —Pump only with Suction Strainer and Hose Coupling.....	\$68.80	\$43.00
<b>Fig. 1640. Outfit A</b> —This outfit includes Pump, Suction Strainer, one Mistry, Jr., Nozzle, Hose Bands and Couplings for one lead, but without Hose.....	71.76	44.85
<b>Fig. 1640. Outfit B</b> —This outfit includes Pump, Suction Strainer, two Mistry, Jr., Nozzles, Hose Bands and Couplings for two leads, but without Hose.....	75.20	47.00
<b>Fig. 1640. Outfit C</b> —This outfit is the same as Outfit A, except with one 15-foot lead of No. 1 1/2-inch Discharge Hose and 5 feet 3/4-inch Suction Hose.....	76.80	48.00
<b>Fig. 1640. Outfit D</b> —This outfit is the same as Outfit B, except with two 15-foot leads No. 1 1/2-inch Discharge Hose and 5 feet 3/4-inch Suction Hose.....	83.84	52.40
<b>Fig. 1640. Outfit C2</b> —This outfit is the same as Outfit A, except with one 15-foot lead No. 2 Wire-Wound 1/2-inch Discharge Hose and 5 feet 3/4-inch Suction Hose.....	77.44	48.45
<b>Fig. 1640. Outfit D2</b> —This outfit is the same as Outfit B, except with two 15-foot leads No. 2 Wire-Wound 1/2-inch Discharge Hose and 5 feet 3/4-inch Suction Hose.....	85.28	53.30
If Pressure Gauge is wanted, add.....	4.00	2.50

## Gould's Dreadnaught Duplex Power Sprayer

WITH AUTOMATIC GOVERNOR

This Gould's Duplex Spray Pump is a high grade, medium size, single-acting power spray pump, designed for pressures up to 250 pounds and is fitted with double reduction spur gearing. This gearing permits the pump to be direct-connected to an engine shaft without the use of a jack or extra gearing. The gear ratio is 9 to 1. When operated at the speeds recommended—50 to 67 revolutions per minute—engines with speeds of 450 to 600 revolutions per minute can be used. At a speed of 50 revolutions per minute it has a capacity of 5.30 gallons per minute, and at 67 revolutions per minute, 7.00 gallons.

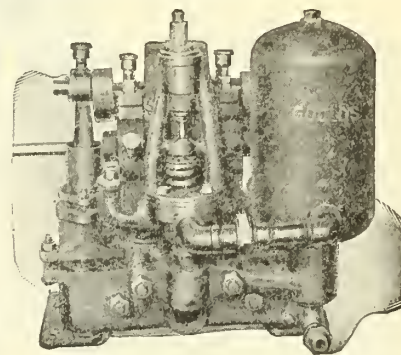

Fig. 1705—Power Sprayer with Automatic Governor.

This pump is equipped with an automatic governor which operates as follows:

When the pump is in operation and the spray nozzles open the flow of liquid has free access to the air-chamber and thence to the spray nozzles. Any excess pressure causes a diaphragm to open an overflow outlet which automatically relieves the pressure by allowing the surplus liquid to return to the tank.

The over all dimensions are: Width, 18 1/2 inches; length, 24 inches; height, 19 1/2 inches. This makes a very compact outfit.

Pump with Strainer and Hose Couplings	Cylinders		Suction Hose	Discharge Hose	Approx Weight Lbs.	List Price	Our Special Price
	Diam. Ins.	Stroke Ins.					
	2 1/2	2 1/2	1-in	1/2-in	210	\$170.00	\$100.00

ALL PRICES IN CATALOG SUBJECT TO CHANGE WITHOUT NOTICE.

# THE MYERS SELF-OILING POWER SPRAY OUTFIT

FITTED WITH AUTOMATIC DUPLEX PUMP.

Complete Except Engine

Belt Driven. Simple, Strong and Efficient.

The Automatic Pressure Governor Insures Safety, Secures Uniform Pressure and Eliminates Unnecessary Wear. Relief Valves Not Required.

Fig. 2193

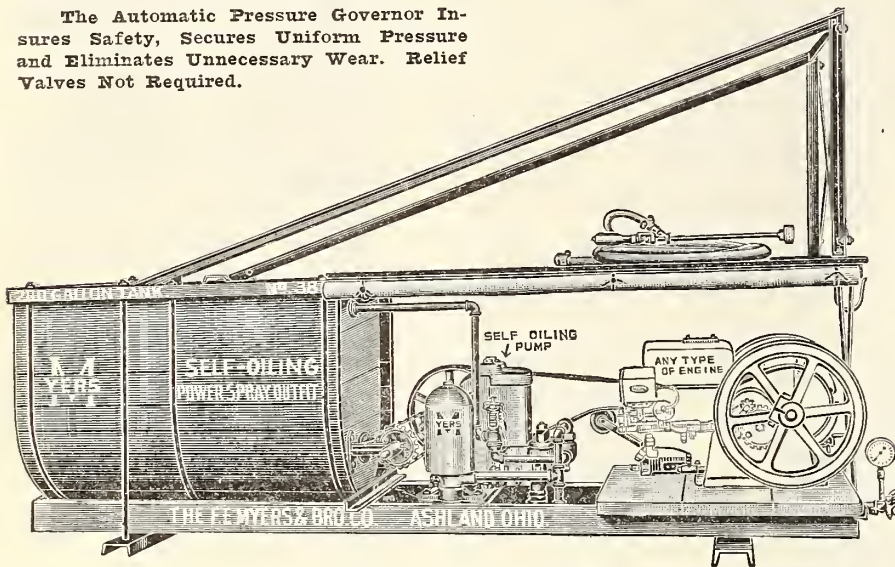

Fig. 2193 represents the Myers Self-Oiling Spray Outfit, which is furnished complete including hose, spray gun, pump, tank, agitator, etc.; in fact everything with the exception of the engine and wagon truck. The pump is supported on channel bars riveted to the frame. The engine is mounted on a 2 inch plank platform, the object being to supply a construction so that the consumer who is familiar with the use of the ordinary gas engine, can set it on the rig and dismount when wishing to use it for other purposes without requiring the services of a machinist. The entire framework is made of channel and angle iron, producing a very stiff frame with the least possible weight. The tank is made of selected cypress which makes a flexible joint and relieves the tank from all strain. The frame is fitted with two cross channel bars on the underside, which fit over the bolsters of the wagon, preventing forward or backward movement. The cab has heavy curtains for protection of the engine and pump. The guard rails on top are to prevent the operator from falling off, and fold flat for transportation or storage.

Fig. 2193, No. 28, Myers Self-oiling Spray Outfit, with 150-gallon Cypress Tank, fitted with Self-oiling 2½-in. Duplex Power Spray Pump, equipped as follows: One Myers Spray Gun, 25 ft. ½ in. Power Spray Hose, Coupled; Double Cut-off for discharge lines; Pressure Gauge; Rotary Agitator; Belt Tightener. Suction pipe taken from bottom of tank, with cut-off. As shown in illustration .....

- No. 28, Outfit, with 1½ H. P. Stover Engine and Belt,..... \$210.00
- No. 28, Outfit, with 1½ H. P. Stover Engine and belt, Mounted on Low Down Farm Truck, with Doubletrees and Neck Yoke..... \$295.25
- ..... \$352.75

## AUTO-SPRAY NO. 39

ONE HORSE      FOUR ROW FIELD SPRAYER      CAPACITY 50 GALLONS

The Auto-Spray No. 39 is the result of our 13 years of careful study and experience in manufacturing traction sprayers. It was designed to meet the requirements of the most particular growers of field crops, nursery stock, grapes, etc.

We guarantee this machine with 4 nozzles, large aperture, .081 inches in diameter, to maintain a pressure of not less than 150 lbs., or with 8 nozzles, holes in apertures .059 inches in diameter, a pressure of 100 lbs., or better.

The pump on the Auto-Spray No. 39 is driven by a short chain directly connected from the axle and is geared so that there is little draft from the operation of pumping.

By a convenient clutch arrangement this pump may be thrown out of gear with the wheels so that the machine may be drawn without working the pump and this also enables the operator to manipulate the pump with the hand lever while spraying trees.

**IN DETAIL**

- Axle**—Cold rolled steel, 1¾-inch diameter. Tracks two rows. Wheels adjustable on the axle for various widths.
- Wheels**—4 feet diameter, 3-inch tire.
- Pump**—Double cylinder. Plunger style. Brass plungers, 2½-inch diameter.
- Packing**—Graphite composition, packed from the outside. Adjustable without withdrawing the plunger by simply screwing two nuts over the gland.
- Valves**—Brass check. Broad brass seats. Set in pump manifold. Can be easily ground or replaced.
- Agitator**—Revolving twin paddles.

- Tank**—50-gallon, new barrel, or as ordered. An extra charge will be made for 100-gallon tank.
- Air Chamber**—Large capacity, tested under high pressure.
- Nozzles**—Non-Clog Junior Nozzles or as specified. Nozzles on field attachment adjustable to correspond with track. For barrel, 1 horse; for 100-gallon tank 2 horses are advisable.
- Spray Boom may be raised or lowered on the two uprights. Each machine has a perfect valve control and is equipped ready for going to work.
- SHIPPING WEIGHT**—700 lbs.
- Auto-Spray No. 39A—Complete for 4 rows, 4 nozzles, iron piping, 50-gallon barrel, spray boom A.....\$150.00

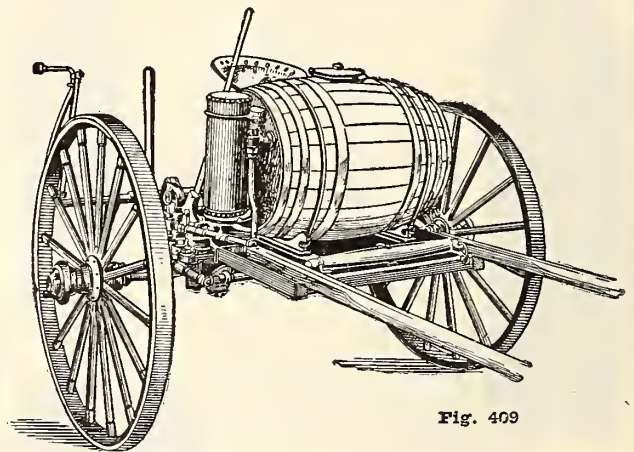
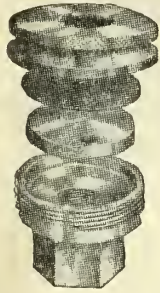

Fig. 409

Sectional View.



## MISTY JR. NOZZLE

THE BEST NOZZLE YET.



The Misty Jr. Nozzle is made from Brass with hardened tool steel disks in discharge cap. The steel disks can be inserted without the least trouble.

This nozzle has been tested under all conditions, and found to give entire satisfaction. It produces a perfect mist and covers a wide area. This nozzle is in our opinion the best that can be had. Brass, with extra steel disk.....\$1.00

Can also supply these nozzles with Brass, with extra steel disk.....\$1.00

Can also supply these nozzles with Brass, with extra steel disk.....\$1.00

Extra Steel Disks for Misty, Jr., Nozzle.....5c.

Extra Caps for Misty, Jr., Nozzle...30c.

## BORDEAUX NOZZLE



The Bordeaux Nozzle can be readily changed from a solid stream to a mist-like, fan-shaped spray. Should there be any clogging of the nozzles with the spray material, it is easily remedied by turning the handle.

An excellent nozzle for white-washing.

Price...\$1.25

## VERMOREL NOZZLE

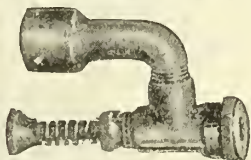

This is an improvement on the old style Vermorel Nozzle spray is finer and more evenly distributed. The cap with smaller hole makes finer spray.

Fig. 55—Gould's Vermorel Nozzle, each, One Discharge, \$1.00.

Caps for above, 25c. each.

## HOSE COUPLING

Fig. 1284.



BRASS HOSE COUPLINGS, FIG. 1284.

Fig. 1284 is a special Brass Hose Coupling, made with double length nipples, with heavy ribs, of sufficient length to use two hose hands if necessary. Especially adapted for use with Power Spray Pumps. Made in 1/2-in. size. Price, each.....60c.

# Spray Pump Accessories

## LEVER SHUT-OFF COCK, NO DRIPPING

Fig. 64.

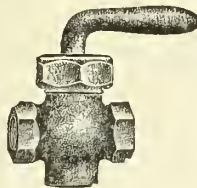

Fig. 64—Lever Shut-off Cock, all brass. Made for use with Pipe Extension. Requires quarter turn only to shut off complete. This quick action makes it a practical device for the purpose. Tapped 1/4-inch pipe size. Price, each...\$1.00

## LONG SHANK HOSE COUPLING



Fig. 67—Brass coupling, has one end cut 1/4-inch gas pipe and other end shank to wire into hose. Made from solid brass. Price, each...35c.

## 45° BEND BRASS Y

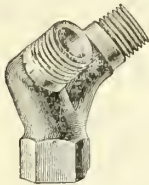

Fig. 1584—Brass Y with the two branches of the Y bent as shown.

Price.....50c.

Fig. 1074 1/2—Brass Y straight.

Price.....50c.

Fig. 491 1/2.



## BRASS Y

Brass Y is cut 3/4-inch. Female Hose inlet, with lateral discharges to fit 1/2 and 3/4-in. Hose Couplings.

Price.....75c.

## 60° BRASS ELBOW



Fig. 1107—Sixty degree brass elbow, threaded both ends 1/4-inch pipe for use with any nozzle.

Price.....30c.

## REDUCING COUPLING

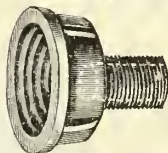

Fig. 65—Coupling small end cut 1/4-inch pipe thread to fit our spray nozzles, large end cut to fit 3/8-inch, 1/2-inch or 3/4-inch male hose coupling.

Price.....30c.

## PRESSURE GAUGE

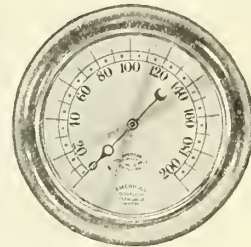

Fig. 30 1/2.

Brass Pin Silvered Dial, with black figures. Up to 200-pound pressure, with stop-cock.

Price—

2 1/2 in....\$3.25

3 in.....3.75

## FUNNEL STRAINER

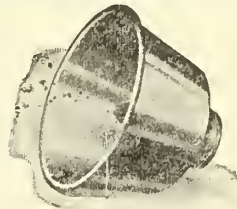

For straining spray solutions.

Heavy Galvanized Strainer with Brass Mesh.....\$1.75

Fig. 1346

## Relief Valves



FOR POWER SPRAY AND OTHER POWER PUMPS.

3/4-inch.....\$6.00

## Hose Nipples

1/2-in. or 3/4-in. hose, 3/4-in. iron pipe....\$ .40  
 1/2-in. or 3/4-in. hose, 1-in. iron pipe.... .40  
 1/2-in. or 3/4-in. hose, 1 1/4-in. iron pipe.... .70  
 1-in. hose, 1-in. iron pipe..... .60

## RUBBER GLOVES

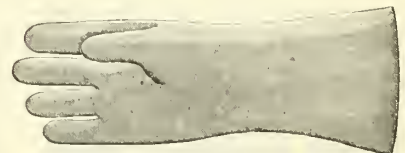

EXTRA HEAVY, ALL-RUBBER, SEAMLESS GLOVES

Just the thing to handle the poisonous chemicals used in the different spraying mixtures. Can be worn with canvas gloves inside or outside.

Price.....\$3.00

## EXTENSION SPRAY-RODS

Fig. 1536.

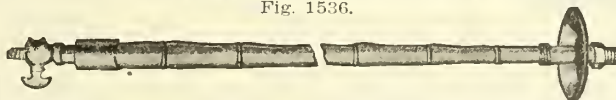

Fig. 1535.

Fig. 480—8-foot pipe extension, with couplings.....\$ .65

Fig. 1535—8-foot pipe extension, with stop-cock.....1.65

## BAMBOO

8 ft. with stop cock....\$4.20  
 8 ft. without stop cock...3.25  
 10 ft. with stop cock....4.75  
 10 ft. without stop cock...3.75

## GARDEN HOSE

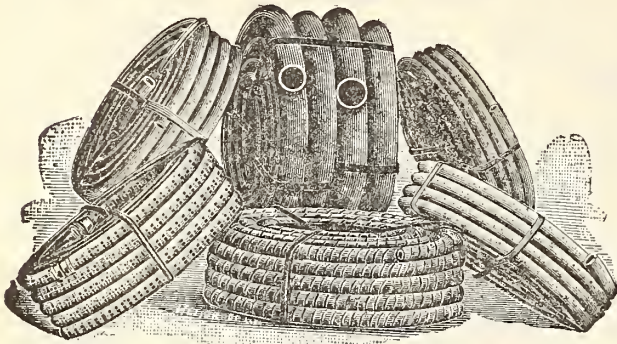

Our brands of Hose are all made up to our order, experience having taught us that High-Grade Hose is the cheaper. Low-Grade Hose will not give satisfaction.

These brands of Hose are guaranteed to be as represented, and have given our trade satisfaction for years.

<b>ORIOLE.</b> —5-ply, 3/4-in., in 25 and 50-foot lengths (75 lbs. pressure).....	Per Ft. <b>\$0.14</b>
<b>GRIFFITH &amp; TURNER CO.'S EXTRA.</b> —3-ply, 3/4-in., in 25 and 50-foot lengths (80 pounds pressure).....	<b>.16</b>
<b>GRIFFITH.</b> —6-ply, 3/4-in., in 25 and 50-foot lengths (125 pounds pressure).....	<b>.18</b>

## GRITCO MOULDED GARDEN HOSE



The construction of this Hose is entirely different from regular Hose. Over a seamless tube of high-grade rubber is braided two plies of tightly twisted cotton yarn.

Between each ply is placed a distinct layer of high-grade rubber. The Hose is protected by a cover made of rubber specially compounded. It is vulcanized in patented moulds under very high pressure.

This Hose is manufactured in continuous lengths up to five hundred feet.

3/4-inch, per foot, coupled, **18c.**

## HOSE FOR SPRAY PUMPS

We do not recommend a cheap Hose for spray work. Large sprayers handling a high pressure should use our No. 2, 1/2-inch spray hose. This Hose is made especially for this work. It is extra strong and is wire wound, adding to its strength, and insuring long life, as the wire also protects it from rough usage.

The No. 1, 1/2-inch Spray Hose will be found satisfactory for the various hand pumps.

Spray hose is made especially for spray pumps, being so constructed that spraying solutions have the least possible effect on them.

1/2-inch Oriole.....	<b>\$0.12</b>
1/2-inch Spray No. 1.....	<b>.15</b>
1/2-inch Spray No. 2, wire-wound.....	<b>.18</b>
1-inch 3-ply Hose.....	<b>.25</b>
1-inch Hard Rubber Suction Hose.....	<b>.35</b>
2-inch Wire-Lined Suction Hose.....	<b>.55</b>

1/2-inch Hose comes in 10, 15, 25, 30 and 50-foot lengths. We cannot cut other lengths. 2-inch Hose comes in 5, 10 and 20-foot lengths.

## HOSE COUPLING

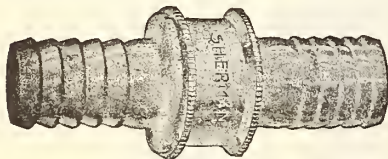

Fig. 504.

These Hose Couplings are made from brass, thoroughly machined, and are in perfect shape. The 3/4-inch are made from spun brass, and are very light and neat, assuring a large flow of water, as the opening is not reduced.

Fig. 504—Brass Hose Couplings:

Size, inches 1/2	3/4	1	1 1/2	2
Complete 25c.	25c.	35c.	\$1.25	\$2.00
Female half 15c.	20c.	25c.	.75	1.30

## SHERMAN'S BRASS HOSE CLAMPS



Fig. 1272, each, 1/2-in., 5c.; Brass Hose 3/4-in., 6c.; 1-in., Clamps, 12c.

## COOPER HOSE MENDER



No clamps necessary. Impossible to pull out of hose. Each, 10c.; dozen.....\$1.00

## HOSE REELS

### PARK REEL No. 21.

A tubular iron reel and frame mounted on steel wheels, tires 1 1/2 inches.

Height of wheels.....	28 in.
Outside width over all.....	26 in.
Shipping weight.....	45 lb.
Capacity, 3/4-in. hose.....	200 ft.
Capacity, 1-in. hose.....	100 ft.

Price.....\$12.00

### The No. 20 Tubular—

Wheels, 24 inches; weight 20 lbs. Capacity, 150 feet; 3/4-inch Hose.

Price.....\$6.00

### No. 200 ALL-STEEL REEL.

Diameter of wheels.....	7 in.
Diameter of reel.....	20 in.
Diameter of drum.....	9 in.
Width of drum.....	10 in.
Height of handle.....	39 in.
Capacity, 100 ft. 3/4-in. hose.	
Weight about 25 lbs.	

The weight of the hose is on the wheels, not on the hands when being moved about. This reel is light, yet rigid and durable.

Price.....\$5.00

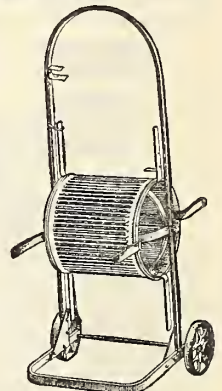

"Victor."

"VICTOR" REEL is constructed with channel steel frame; strong, cast-iron wheels; solid steel reel arms and 9-inch drum of heavy corrugated steel.

Weight, 12 1/2 lbs., bundled for shipping. Capacity, 100 ft. of 3/4-inch rubber hose.

Price.....\$3.00

## THE SURE SHUT HOSE MENDER



The simplest, strongest and best device on the market for repairing leaky hose. No tools whatever are necessary to attach it. Can be put on with the hands alone in less than a minute. Makes an absolutely water-tight connection. Is made entirely of brass. Can be detached and used over and over again. Made for 3/4-inch hose.

Price, each set.....\$ .15

Price, dozen sets.....1.75

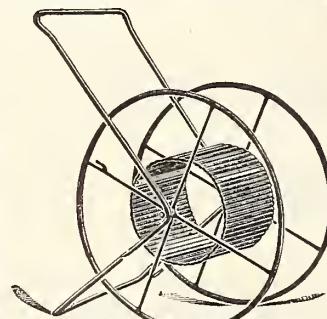

### No. 10 All-Steel Reel.

Diameter of wheels.....	22 in.
Diameter of drum.....	9 in.
Width between wheel.....	10 in.
Length of handle.....	28 in.
Capacity, 100 ft. 3/4-in. hose.	
Weight about 17 lbs.	

The large wheels roll easily over rough or soft ground. Nothing to get out of order.

Rigid, Durable, Attractive.

Price.....\$3.25

## REVOLVING SPRINKLER

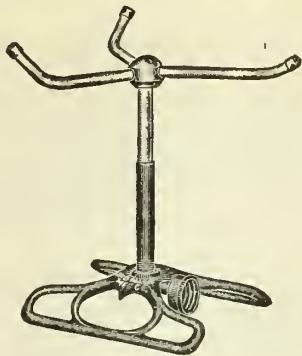

The Sprinklers are compactly and strongly made, with phosphor-bronze bearing.  
 Eureka Sprinkler, 12 in. high... ..\$2.50  
 Newport Sprinkler, 24 in. high..... 4.50  
 Parcel Post Weight, 5 Pounds.

## FOUNTAIN SPRINKLER

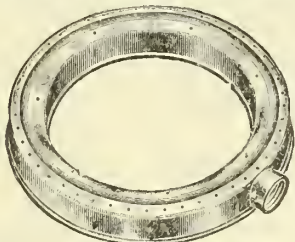

MADE OF HEAVY BRASS.  
 Easily moved over the lawn without turning off the water. The mist-like spray is a veritable "thing of beauty."  
 Price .....85c.

## C. B. G. SPRINKLER

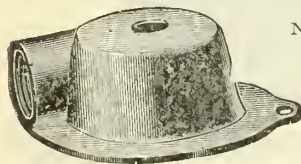

No. 54

Price  
 Each, 40c.

## FIBRE-WARE ROLLING STAND

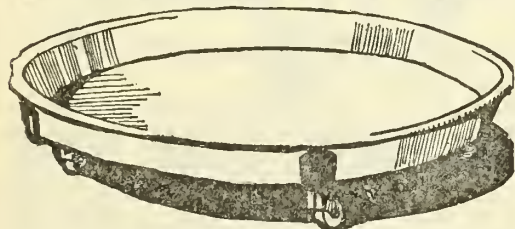

Fibre-ware Rolling Stands are mounted upon ball-bearing casters and furnish an easy and ready means of moving heavy plants in permanent or temporary locations.

Outside Diameter.	Will take tub diameter at bottom.	Price, Each.
12 inches.....	11 inches.....	\$1.40
14 inches.....	13 inches.....	1.75

## THE RAIN KING

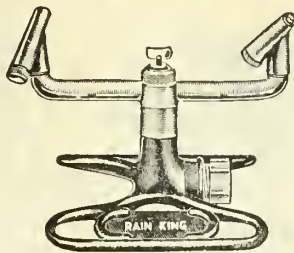

Absolutely nothing to get out of order.

Set instantly as a revolving or stationary sprinkler.

Distributes water perfectly at any pressure, either revolving or stationary.

Nozzles adjust immediately to a fine spray or coarse spray, with any pressure.

Waters a greater area than any other sprinkler, under any water pressure.

Waters a small or large circle, from 8 to 80 feet in diameter. Instantly adapted to surface to be covered.

Waters strips, corners or any odd-shaped places, or sprays trees, shrubs, flower beds, etc., without "slopping over" on walks or adjacent buildings.

Lacks the troubles common to the ordinary sprinkler.

Runs fast or slow, as wanted.

Price..... \$3.50

## U. S. PLANT TUBS



These plant tubs are made from best grade cedar, with strong iron handles and feet. Just the thing for Palms, Rubber Plants, etc. Painted Green with Black Trimmings.

No.	Outside Top Diameter.	Depth.	Price
1.....	12	10%	\$2.50
2.....	13	12%	3.25
3.....	14½	14%	4.00
3½.....	16½	15%	5.50
4.....	19%	16%	6.00
5.....	22%	18½	8.00

## HOSE NOZZLES

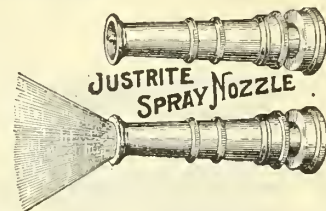

This nozzle is made from solid brass and is adjustable for all kinds of spraying, from solid stream to the finest spray, or can be shut off entirely.

¾-in. Justrite Nozzle.....80c.  
 Parcel Post Weight 1 Pound.

## THE FOUNTAIN SHOWER

A Hose Nozzle with the "Mist-Like Spray"

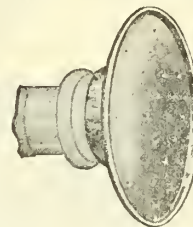

This shower Sprinkler is the best thing for attaching to the hose to be used like a watering pot. It gives a fine gentle shower and does not injure the plants as a heavy stream might do.

P. P. Weight 1 lb.  
 Price .....40c.

## THE SAVO STEEL All-Year-Round Flower Box

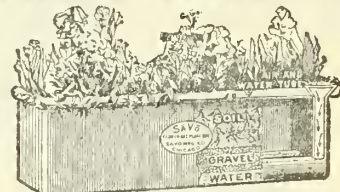

Patented Jan. 23, 1900

Self-Watering and Sub-Irrigating FOR

Windows, Porches, Sun Parlors, etc.

Perfect AIR Circulation and Drainage  
 Leak Proof and Rust Proof

**MOST EFFICIENT, DURABLE, ARTISTIC**  
 Six sizes. Beautifully finished

Fill with water only once a week. Move Savo Boxes indoors or out and you can have beautiful Flowers and Plants continually for many years.

## AN ALL - YEAR - ROUND - GARDEN

STANDARD STOCK SIZES AND PRICE LIST.

Model A—8 in. high, 9½ in. wide, 23 in. long.....	\$3.00
Model B—8 in. high, 9½ in. wide, 29 in. long.....	4.00
Model C—8 in. high, 9½ in. wide, 35 in. long.....	4.50
Model D—8 in. high, 9½ in. wide, 41 in. long.....	5.00
Model E—8 in. high, 12 in. wide, 12 in. long.....	3.00
Model F—12 in. high, 12 in. wide, 12 in. long.....	3.50
Model G—Round box with stand complete.....	6.00

These are outside measurements, including the ¾-inch roll rim.  
 Beautifully finished in Aluminum.  
 Only water once a week. No surface watering.

## WATER TRUCKS AND COMBINATIONS WITH STEEL WHEELS

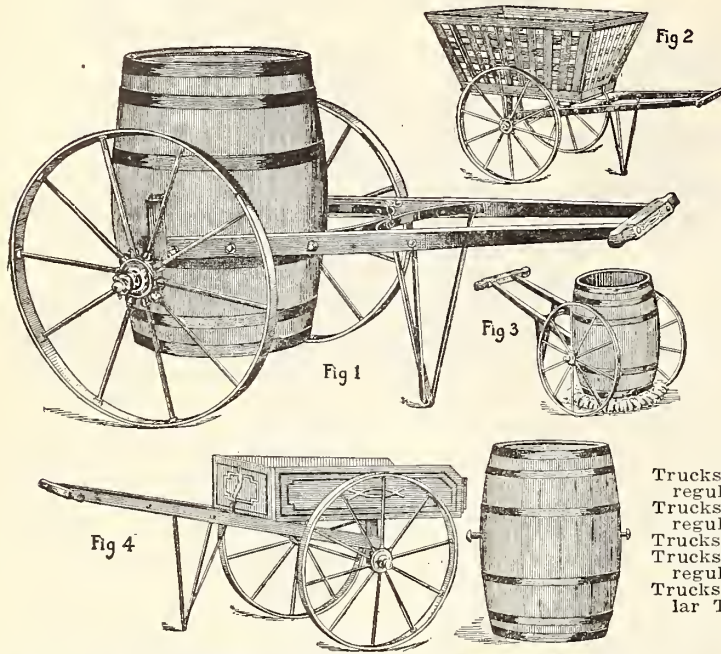

Fig. 1 represents our Barrel Cart, to which can be attached any of our Barrel Spray Pumps. This is a convenient combination, and may be found useful in various ways, such as watering gardens, spraying fruit trees, etc.

Fig. 2 shows Truck with Leaf Rack Attachment. Fig. 3 shows Truck and Barrel with Sprinkler Attachment.

Fig. 4 shows Truck and Box, with Barrel Detached. Dimensions: Height of Wheels, 2 ft. 9 in.; Distance between Trunnions, 2 ft. 2½ in.; Width Tire, Steel, 1½ in., 2½ in., 3½ in.; Wood, 1½ in., 2½ in., 4 inches.

Box Inside Measure: Width, 22½ in.; Length, 24 in.; Height, 8½ in. Box has tail door.

**Prices.**

	List Price.	Special Price.
Water Truck, with Regular 1½-inch Tire Steel Wheels.....	\$20.70	\$13.75
Water Truck and Barrel.....	29.40	18.75
Water Truck and Box.....	28.20	18.25
Water Truck, Barrel and Box.....	37.20	23.25
Sprinkling Attachment.....	10.00	6.00
Leaf Rack.....	14.40	9.00
Barrel.....	9.00	5.00
Box.....	7.50	4.50
Trunnions, per pair.....	1.60	.90

Trucks with 2½-in. Tire Steel Wheels, add to regular Tire Truck.....	1.60	1.00
Trucks with 3½-in. Tire Steel Wheels, add to regular Tire Truck.....	3.20	2.00
Trucks with regular 1½-in. Tire Wood Wheels.....	20.70	13.75
Trucks with 2½-in. Tire Wood Wheels, add to regular Tire Truck.....	1.60	1.00
Trucks with 3½-in. Tire Wood Wheels, add to regular Tire Truck.....	3.20	2.00

**Extra Truck Wheels.**

	List Price.	Special Price.
1½-in. Tire Wood or Steel Wheels, each.....	\$4.80	\$3.00
2½-in. Tire Wood or Steel Wheels, each.....	6.00	3.50
3½-in. Tire Steel Wheels, each.....	6.50	3.75
3½-in. Tire Wood Wheels, each.....	6.50	3.75
Axles, with Trunnion Holders, each.....	4.00	2.50

### WHEELBARROW LEAF-RACK ATTACHMENT



Can be attached to any style or size wheelbarrow with removable sides. Most convenient for gathering leaves, cut grass and rubbish. One of these attachments should be in use on every small suburban place, as well as the larger estates. Capacity, 10 bushels; made of galvanized wire, bolted to a wooden base. List Price, \$12.00. Our Special Price, \$7.50

Fig. 7.

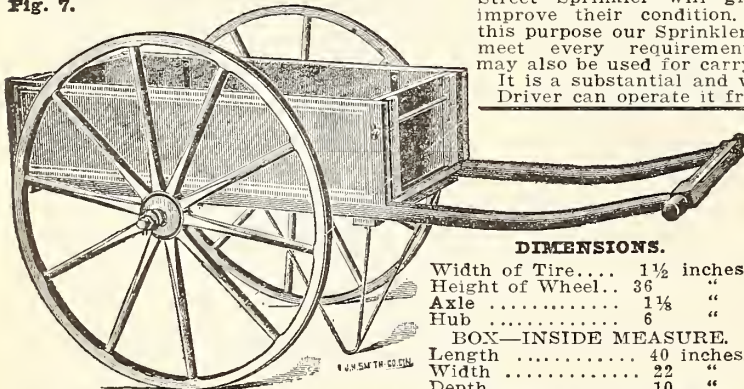

### BALTIMORE LAWN AND STREET SPRINKLER

LIST, \$250.00  
RETAIL, \$150.00

Parks, Cemeteries and Country Places having a considerable amount of Roadway, Walks and Lawns will find that the Baltimore Lawn and Street Sprinkler will greatly improve their condition. For this purpose our Sprinkler will meet every requirement. It may also be used for carrying water and other purposes.

It is a substantial and well-made Sprinkler in every respect. Driver can operate it from the seat.

**DIMENSIONS.**

Width of Tire.....	1½ inches.
Height of Wheel.....	36 "
Axle.....	1½ "
Hub.....	6 "
<b>BOX—INSIDE MEASURE.</b>	
Length.....	40 inches.
Width.....	22 "
Depth.....	10 "

Capacity About 160 Gallons.



### BALTIMORE PUSH CART

For the merchant, printer, farmer, etc., to have one of these carts on his premises it will be found a most useful vehicle. There are so many purposes for which they can be employed—carrying bundles, printers' forms, farmers' tools and light implements, etc. It is never out of place, and always ready to pick up at short notice. They are nicely finished; higher wheels, better ironed and altogether superior to anything of its kind on the market. There is now an immense demand for these carts, but notwithstanding we have placed the price low.

Retail.....\$18.00 List.....\$27.00  
Extra wheels, each—List, \$5.20. Retail, \$3.25.

## Monitor Cart No. 53

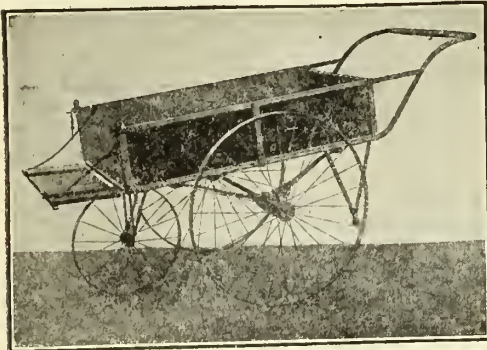

**The Monitor Construction.** The frames of the bodies are made of special carbon steel, riveted together with best Norway rivets. It is very light and strong, with durable first quality basswood box inside, and have oil-tempered half elliptical springs. The leg being V-shaped and pivoted at its two extremities to the bodies, forms an effective handle brace.

**Lightness.** We claim for the MONITOR Hand Cart extreme lightness. These carts weight about one-third as much as the old-fashioned wooden cart.

They are especially adapted to the uses of manufacturing or mercantile business, and are indispensable to grocers, bakers, laundries, printers, painters, plumbers, paper-hangers, carpenters, tin-smiths, gardeners and general family uses.

**No. 53**—Box 29x44x10 inches. 30-inch wheels. 3-16-inch spokes. Weight, 110 pounds.

**OUR SPECIAL PRICE**..... \$22.00

## Monitor Cart No. 23

The great convenience of a three-wheel cart will be appreciated when you realize that the weight is all upon the ground and none on the party pushing it. This cart is especially designed for convenience. It is nicely made, the body is finished in green nicely striped and varnished, the gear is finished in red.

It is just the thing for printers, grocery stores, factories, and in fact its many uses would be hard to enumerate.

The frame of bodies are made of special carbon steel, riveted together, the bodies are large, giving ample room for a large load. In the construction of MONITOR CARTS we use the very best material, making this the **lightest** and **strongest** cart obtainable.

**No. 23 MONITOR**—Box 23x41½x10 inches. Capacity, 600 lbs. 30-inch wheels. 3-16-in. spokes. Weight, 103 pounds.

**OUR SPECIAL PRICE**..... \$19.00

## THE DESHLER R. F. D. MAIL BOX

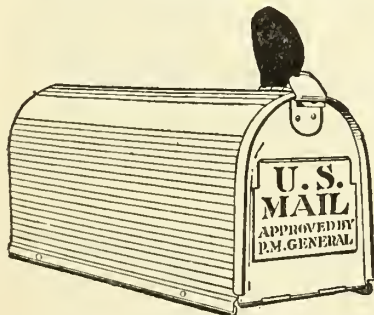

Will last a lifetime and sells at sight. Made of 20-gauge galvanized iron, painted aluminum, absolutely storm-proof, perfect in operation, positive locking signal in either position—up or down, weather-proof slot in door for depositing the mail without unlocking the box. No rivets or bolts required to set it up.

When the patron nails the box on a post this fastens the box so that it cannot be taken apart.

One half-dozen to a crate. Shipping weight, 72 pounds to the dozen.

List Price, \$1.80 each. Our Special Price, \$1.15 each.

## Handy Low Platform Cart

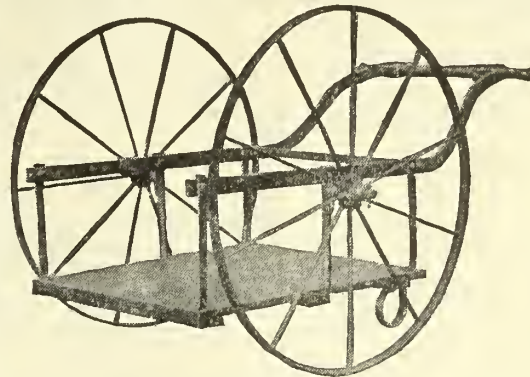

A handy cart for Farm and Dairy use. The low-down platform makes loading and unloading easy. It will carry five milk cans, water barrel or farm produce in sacks. The parallel steel bands on the sides and wooden back rest make possible a wider range of use and permits carrying small packages or merchandise.

**SIZE OF PLATFORM**  
27 x 30 inches.

Woodwork painted red, wheels and iron work black.

Crated for Shipment. Shipping Weight, 100 lbs.  
**OUR SPECIAL PRICE**..... \$12.00

## Merimac Cart No. 132



This cart is built especially for country use, where there are not any pavements, and a three-wheel cart is not necessary. In the construction it is just as high-grade as other carts listed and will be found a very useful addition on every place. The running gear is made of steel, the wheels are of the bicycle pattern, steel spokes, electrically welded tires and malleable hub, this construction gives the greatest strength.

The springs are so constructed and arranged as to carry the load in a way that makes the cart easy to push.

Body is finished in green, nicely striped and varnished. The gear is finished in red.

**No. 132 MERIMAC**  
Box 23 x 41½ x 9½ inches. Capacity, 250 lbs.  
26-inch wheels. Weight, 66 lbs.

**OUR SPECIAL PRICE**..... \$13.50

## LOCKS

ALL THESE LOCKS ARE  
TESTED BEFORE  
LEAVING FACTORY



	List Price, Dozen.	Special Price, Each.
4031—Pressed steel, brass plated, with 2 keys.....	\$3.84	\$ .20
6160—Greenenameled, with 2 keys.....	5.67	.30
4012—Wrought metal, self-locking, with 2 keys...	3.84	.20
1902—High grade bronze, with 2 flat keys.....	8.64	.45
1902—Bronze metal case, with 2 keys.....	10.56	.55
4067—Seamless steel shell, with 2 keys.....	7.68	.40
16022—Wrought steel, six levers, with 2 keys.....	7.68	.40
1904—Highest grade brass case, with 2 keys.....	13.44	.70
16034—Wrought steel, eight levers, with two double fitted drilled barrel keys.....	14.40	.75
9902—Mail lock, no chain.....	12.48	.65
9902—Mail lock, with chain.....	13.44	.70

# SPRAY CALENDAR

WHAT TO SPRAY	FOR WHAT TO SPRAY	WITH WHAT TO SPRAY	WHEN TO SPRAY			REMARKS AND CAUTION
			First Spraying	Second Spraying	Third Spraying	
Apple .....	Codling Moth	Kaylox	As soon as blossoms fall	7 to 10 days later	30 days later	Later spraying if made should be made with diluted solutions Use Lime-Sulphur only when trees are dormant  The spray just before blossoms open is very essential for scab Don't use strong emulsion when tree emulsion when trees are in full leaf
	San Jose Scale	Lime-Sulphur	Late in fall, late in winter or early in spring			
	Scab	Kaylox	Just before blossoms open	Within a week after blossoms have dropped	Same 7 to 10 days later	
	Woolly Aphis	Kerosene Emulsion	When trees are in full leaf	In fall		
Asparagus ...	Asparagus rust	Kaylox	After cutting crop	10 days later	10 days later	Repeat 3 to 4 times. Burn rusted brush in the fall
Bean .....	Anthracnose	Kaylox	On 2 or 3-inch plants	10 days later	After blossoms	1 oz. to 30 gals. of water
	Cabbage and Cauliflower... Cabbage Worm	Pyrethrum	With first appearance of worms	Whenever worms are observed	Same	
Cherry .....	Rot	Bordeaux	Before blossoming	After blossoming drop on fruit	Two weeks later on fruit	When fruit is large
	Curculio	Arsenate of lead	Before blossoming	As blossoms dry up	One week later	Avoid strong solutions. Do not use other arsenicals than arsenate of lead Week after fourth
Cucumber .....	Cucumber Beetle	Kaylox	Soon as plants appear	Week later	Week after second	
Currant .....	San Jose Scale	Lime-Sulphur	As with apple	In spring as with apple		Look for worms on under side of leaves first
	Worm	White Hellebore	When worms first appear	Repeat in 3 or 4 days	Repeat as second	
Gooseberry ...	Mildew	Bordeaux	Before blossoms open	After blossoming	Two weeks later	
Grape .....	Worm	White Hellebore	As on Currants	Just before blossoming	Just after fruit has set	Follow by two or three sprayings
	Anthracnose Downy and Powdery Mildew and Rot	Kaylox	Just before blossoming	Just after fruit has set	7 to 10 days later	
Peach .....	Leaf Curl	Bordeaux	In fall or spring	As buds are opening	Just after calyx drops	Destroy all mummies  Use only half usual amount of poison
	Rot and Scab	Bordeaux	As buds are swelling	Just after calyxes drop	2 to 3 weeks later	
	Bud Moth	Arsenates in Bordeaux	With opening of buds			
	San Jose Scale	Lime-Sulphur	In late fall or early spring			
Pear .....	Scab	Kaylox	When leaves are half grown	After blossoms drop		See Apple
	Codling Moth	Kaylox	As with Apple	Same as first		
	San Jose Scale	Lime-Sulphur	In fall or early spring			
Plum .....	Rot	Bordeaux	As buds are swelling	Just after calyx drops	3 to 4 weeks later	Repeat every 7 or 10 days
	Curculio	Arsenate of lead	With starting of buds	Just after calyx drops	5 days later	Destroy all mummies Jar, gather and destroy curculios and stung plums
	San Jose Scale	Lime-Sulphur	In late fall or early spring			
Potato .....	Early Blight	Kaylox	When plants are 6 inches high	Two weeks later	Two weeks later	90 minutes  Kaylox, 7 lbs. to 50 gals. of water
	Scab	Soak seed in	Corrosive sublimate	Solution (2 oz.)	In 16 gallons	
	Colorado Beetle	Kaylox	When beetles or young appear	As for first		
Quince .....	Fruit and Leaf Spot	Kaylox	Just before blossoms open	After blossoms drop	Two weeks later	Keep spray from leaves on bearing canes
	San Jose Scale	Lime-Sulphur	In late fall or early spring			
Raspberry and Blackberry...	Anthracnose	Kaylox	Before leaves open	Bord. on canes 6 inches high	Repeat second 1 week later	Repeat if necessary
Rose .....	Leaf Spot Slug Aphis	Kaylox Lemon Oil Co.'s Standard Insecticide	With first appearance of fungus On appearance of slugs	2 or 3 weeks later Repeat if necessary		
Strawberry ...	Leaf Spot	Kaylox	On new growth after crop	2 or 3 weeks later		
Tomato .....	Blight	Kaylox	Soon after fruit begins to set	Three weeks later	Three weeks later	



**LEMON OIL COMPANY'S  
STANDARD  
SOLUBLE IN WATER  
INSECTICIDE**

**NO DISAGREEABLE ODOR. NO POISON  
THIS INSECTICIDE  
IS DEATH TO PESTS—IS SAFE TO PLANTS  
—IS HARMLESS TO USER—IS LOW IN  
PRICE—IS FREE FROM DISAGREEABLE  
ODOR.**

We recommend **Lemon Oil Co.'s Standard Insecticide**. It is used by the most prominent florists and seedsmen to destroy **Scale, Mealy Bug, Rust, Aphid, Caterpillar, etc.**, on **Palms, Rose Bushes, Rubber Plants, Ferns, etc.** It leaves no disagreeable odor on blooms or foliage—advantages over the vile-smelling soaps and powders—especially for indoor use. Being **Poisonless**, it is not dangerous to use.

This will be found an excellent wash for dogs and other animals; it relieves Mange, destroys **Lice** and other insects, and gives the coat a beautiful glossy appearance. Contains no poison to injure the animal, and being liquid, gets through the hair to the hide.

It will destroy **Lice** and other insects in poultry houses.

It will also kill **Roaches, Ants** and other insects that infest houses.

**DIRECTIONS FOR USE:**

**FOR MEALY BUG.**—½ pint Standard Insecticide to 4 to 6 cups of lukewarm water or 1 tablespoonful to 2 cups of lukewarm water. When dipping for this insect the plants should remain in liquid from 10 to 15 seconds and kept in continual motion. When spraying use the finest sprayer and apply the liquid with force.

**FOR BROWN AND WHITE SCALE ON PALMS, RUBBER PLANTS, ETC.**—½ pint Standard Insecticide to 4 quarts warm water or 1 tablespoonful to 2 cups warm water, applying with sprayer or sponge.

**FOR THRIP, RED SPIDER, CATERPILLAR, BLACK AND GREEN FLY.**—½ pint Standard Insecticide to 2 or 3 gallons water or 1 tablespoonful to 3 or 4 cups water. Either spray or dip.

**FOR DESTROYING MITES.**—½ pint Standard Insecticide to 4 or 6 quarts of water. Water the plants with the liquid 2 or 3 times at intervals of 6 days.

**FOR DESTROYING ANTS.**—½ pint Standard Insecticide to 1 gallon water. Well water their nests and runs several times in the course of a few days.

**FOR DESTROYING FLEAS, INSECTS, RELIEVING MANGE AND SKIN DISEASES ON DOGS AND OTHER ANIMALS.**—1 teaspoonful of Standard Insecticide to 1 cup warm water; rub well into the hide, letting lather remain a few minutes.

**FOR DESTROYING LICE AND OTHER INSECTS IN POULTRY HOUSES.**—1 part Standard Insecticide to 10 parts water.

**FOR DESTROYING ROACHES, ANTS AND OTHER INSECTS IN HOUSES.**—1 part Standard Insecticide to 5 parts water.

**PRICES:** ½ Pint, 35c.; 1 Pint, 60c.; 1 Quart, \$1.00; ½ Gallon, \$1.75; 1 Gallon, \$3.00; 5 Gallons, \$12.00; 10 Gallons, \$22.50.

**DIRECTIONS ON EVERY CAN.**

**TRADE MARK**  
**KAYLOX**  
Registered in U. S. Patent Office.

**INSECTICIDE AND FUNGICIDE  
KILLS INSECTS AND PREVENTS BLIGHT**

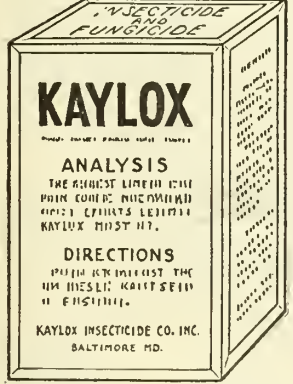

**KAYLOX** is adapted for spraying for late broods of **Codling Moth** on Apples, for **Potato Beetles, most Caterpillars** and many **Leaf-eating Insects** on fruit and other trees, **Tomatoes, Grapes, Currants, Celery, Cabbage, Cauliflower** and many other Plants.

A preventive of many **Blight**s and certain **Fungus** diseases.

Used as a general spray—1 pound to 10 gallons or 5 pounds to 50 gallons of water. For **Potatoes, Bitter Rot** and **Blotch** on Apples. Use 1 pound to 7½ gallons or 6½ or 7 pounds to 50 gallons of water.

Not to be used for late Spring or early Summer application on Apples, and not to be used on **Peaches** or **Japanese Plums**.

**CONTAINS** {  
Active ingredients:  
Dry Lead Arsenate, not less than.....30.0%  
Copper (Cu) not less than.....15.0%  
Inert ingredients:  
Not more than.....55.0%

**KAYLOX IS A POWDER, NOT A PASTE**  
**HIGH FREIGHT RATES** make it imperative that you buy **KAYLOX**, a highly concentrated spraying material, as you then do not have to pay freight on a preparation that is 50% water.

**KAYLOX** never spoils, **KAYLOX** never freezes, **KAYLOX** never becomes worthless, **KAYLOX** is always at your service, **KAYLOX** should be used, because it is your best insurance for a full crop.

**KAYLOX** is the outcome of many years of development in the use and manufacture of insecticides and fungicides. It meets the requirements of the largest growers as well as the small home gardener. **KAYLOX** is in convenient size packages.

½ Pound makes 5 gallons of spray	\$ .30	10 Pounds make 100 gallons of spray	\$ 4.50	100 Pounds make 1,000 gallons of spray	\$35.00
1 Pound makes 10 gallons of spray	.55	25 Pounds make 250 gallons of spray	10.00		
5 Pounds make 50 gallons of spray	2.50	50 Pounds make 500 gallons of spray	19.00	<b>WRITE FOR SPECIAL CIRCULAR.</b>	

**LIME SULPHUR SOLUTION**

The universally accepted spray material for dormant use is lime sulphur solution. Chemically made lime sulphur solution has now almost entirely supplanted the home-made solution because it is better.

This material combines the great fungicidal properties of sulphur with the scale remedy, and is especially recommended for peach and plum trees which need the combined treatment in the fall and spring. In spraying this material care should be exercised to avoid getting it in the eyes, and gloves should be worn to protect the hands.

Lime-Sulphur Solution is used both as an insecticide and a fungicide. As an insecticide it is used principally against scale insects, especially the San Jose Scale. For scale insects it is applied while the trees are dormant and is diluted with 8 or 9 parts of water. As a fungicide it is used chiefly for the control of apple scab, 1½ gallons to 50 gallons of water. Lime-Sulphur may be used in combination with arsenate of lead and tobacco extracts. Paris Green should not be used with Lime-Sulphur.

1-qt. Can.....\$ .30	5-gal. Can.....\$2.00	*1-bbl. per gallon.....\$ .18
½-gal. Can......60	10-gal. Can......50	*Drums charged at \$3.00; barrels
1-gal. Can......90	*½-bbl. per gallon......20	charged at \$2.00; ½-barrels, \$1.50 each,
		subject to return for credit.

**B. T. S.**

This is a trade name or designation for a definite chemical combination of sulphur with the mineral barium which is an insecticide, instead of the mineral lime. In this combination practically all the sulphur is available as an insecticide and fungicide in its most active form.

By the use of barium in the place of lime it is not only possible to obtain the highest efficiency of the sulphur, but also to obtain a dry product that reduces the bulk in shipping about 75 per cent, thus saving freight and reducing losses from leakage and waste.

**Results of Spraying with B. T. S.**—Experiments prove it to be equal to lime-sulphur solution, both as an insecticide and as a fungicide.

**Directions.**—For dormant spraying to control scale, etc., use 12 pounds to 50 gallons of water. For growing period spraying on apples to control scab, etc., use 1½ to 2 pounds to 50 gallons of water.

5-lb. package... \$ .90	10-lb. package.... 1.50	25-lb. package... \$3.25	50-lb. package... \$6.00	100-lb. package.. \$10.00
-------------------------	-------------------------	--------------------------	--------------------------	---------------------------

## ARSENATE OF LEAD

Arsenate of Lead is an arsenical poison for use against insects that chew and for such insects as the fruit-flies that lap and suck up sweetened liquids. It has also been shown to have considerable fungicidal value both when used alone or used in combination with lime-sulphur.

Arsenate of Lead is prepared in powder form. The powdered form can be used in liquid sprays. The powdered form is also used for dusting.

The principal insects for which Arsenate of Lead is used are: Apple-maggot, brown-tail moth, bud-moth, cankerworm, codling moth, fruit-tree leaf-roller, gipsy moth, tent caterpillar, pear slug, curculio, etc.

**Directions:** 1 to 1½ lbs. powder to 50 gallons of water.

Powdered Form.

1-lb. pkg., per lb. ....30c.    4-lb. pkg., per lb. ....25c.  
100-lb. pkg., per lb. ....22c.

## ARSENITE OF ZINC (POWDER)

**Arsenite of Zinc.**—This is a combination of arsenic with zinc to form a quick acting, adhesive insecticide for use on potatoes and some other truck crops. It is much more adhesive and less caustic than Paris Green and kills quicker than Arsenate of Lead.

The great advantages of Arsenite of Zinc are:

**First—It kills the bugs so quickly they do not have a chance to cause serious injury to vines.**

**Second—It sticks to the vines so that it is not necessary to respray after every rain.**

**Third—It can be used at sufficient strength to insure results without burning or injuring the vines.**

**Directions:** 1 to 1½ lbs. powder to 50 gallons of water.

**First—Apply as soon as eggs begin to hatch. For spraying use at rate of two pounds to the acre—this may require one or two pounds or more of the powder to fifty gallons of water depending upon the quantity of liquid distributed per acre by the spraying outfit. The spray tank should be partly filled with water and the powder sifted in slowly while the agitator is running.**

**Second—Make second application ten days to two weeks later in order to cover new growth.**

**Third—Make third application ten days to two weeks after second.**

1-lb. pkg., per lb. ....30c.    4-lb. pkg., per lb. ....25c.  
100-lb. pkg., per lb. ....22c.

## ATOMIC SULPHUR

This is pure sulphur treated by a special process to convert it into a very finely divided state in the form of paste, so it can be readily diluted with water and applied as a spray to coat fruit and foliage with a thin film of sulphur to prevent germination of fungous spores.

It is recommended for the control of scab on peaches, brown rot on peaches, plums and cherries and cedar rust on apples.

**Directions:** 5 to 7 lbs. to 50 gallons of water.

5-lb. pkg., per lb. ....22c.    50-lb. pkg., per lb. ....15c.  
10-lb. pkg., per lb. ....20c.    100-lb. pkg., per lb. ....12c.  
25-lb. pkg., per lb. ....16c.    Barrels, 180 lbs., per lb. ....10c.

## DRI-TOMIC

Similar to the Atomic Sulphur only in powder form. Can be used in solution for spraying as well as for dusting.

4 lb. Bag, per lb. ....\$ .20  
100 lb. Bag, per lb. .... .16

## BORDEAUX ARSENATE OF LEAD

USE KAYLOX—SEE PAGE 77

## BORDEAUX MIXTURE

**BORDEAUX MIXTURE** is a combination of copper sulphate and lime. It is a standard fungicide and may be used in combination with insecticides. Its use is indispensable in the control of black rot of grapes and the blight of potatoes. It is also used for apple-scab, bitter-rot, cedar rust, leaf spot and downy mildew.

**Directions:** 6 to 7 pounds to 50 gallons of water.

1-lb. pkg., per lb. ....25c.    4-lb. pkg., per lb. ....20c.  
100-lb. pkg., per lb. ....16c.



### Key Brand Tree Wound Paint

**PREVENTS DECAY AFTER PRUNING.**

This residuum, penetrating antiseptic paint is not affected by heat, cold or moisture. Does not peel, crack or get brittle. Stops tree bleeding.

**NOTE:** Antiseptic paint for wounds and pruning purposes.

1-Gal. Cans, \$3.00. 1-Qt. Cans, \$1.25.

ALL PRICES IN CATALOG SUBJECT TO CHANGE WITHOUT NOTICE.

## POISON KILL-WEED POISON

NOT TO BE USED ON LAWNS

**A SCIENTIFIC WEED DESTROYER. FREE FROM ODOR**

**By Analysis It Has Been Found There Is No Stronger Weed Killer on the Market.**

An unsurpassed preparation for the removal of grass, weeds, vines and bushes from paths, roadways, gutters, streets and any other place from which it is desired to remove any and all vegetable growths, thus destroying the breeding ground for mosquitoes. The work can be done in a speedy, thorough, economical and easy manner. The material has no bad effect on the ground, neither does it injure or discolor the brick, stone or marble curbing.

No more digging and disfiguring of paths and roadways. Saves expense of several men. **KILL-WEED** not only kills weeds, but destroys seed germs and roots of plants. Can be used with an ordinary sprinkling can. **One gallon KILL-WEED will make 30 gallons treating liquid when mixed with water.** One man with a sprinkling can in one hour can do as much or more than six men could in one-half day, and do the work better.

Judgment should be exercised in using **KILL-WEED**, as it is impossible to give full directions to suit every case. If the weeds are large and strong, the solution should be made stronger than for ordinary grass and weeds. They should be cut down so that the solution can reach the roots.

1-Quart Can.....	\$0.50	5-Gallon Can.....	\$ 7.00
½-Gallon Can.....	.90	10-Gallon Can.....	13.00
1-Gallon Can.....	1.50	1 Barrel, per gallon..	1.00

**Full Directions With Every Container  
Write For Special Circular**

## PARA-DICHLOROBENZINE

**FOR PEACH BORER CONTROL**

Remove all grass, weeds and rubbish from around the tree, make a smooth, bare surface about sixteen inches wide around the tree at the soil level.

Remove any gummy exudation adhering to the crown or collar of the tree.

After the ground is prepared, distribute the crystals of Para-Dichlorobenzine evenly in a narrow circular band around the tree, keeping the inner edge of the band at least two inches away from the bark of the tree.

After the crystals are placed on the soil around the tree cover them with earth, at first lightly so as not to disturb the chemical, and complete by mounding the earth against the trunk of the tree until a cone-shaped mass of dirt four or five inches deep has been made, tamping the dirt down with the back of the shovel.

Use one ounce to a tree 6 years old or older; in case of very large tree, 1½ ounces may be needed to form a satisfactory band. On trees four or five years old, use ½ to ¾ ounces to a tree. We do not recommend using it on younger trees. Do not use on apple trees.

Spring application in May, Fall application in September.  
1-lb. package, per lb. ....\$0.50    25-lb. package, per lb. ....30c.  
5-lb. package, per lb. .... .40    100-lb. package, per lb. ....28c.  
10-lb. package, per lb. ....35c.

## FISH OIL SOAP WITH TOBACCO

Apply for green-fly or aphid, one-half ounce to gallon of water; one ounce for mealy bugs and two ounces for most greenhouse scale. Outside purposes, double the strength for same kind of pest.

½ lb.....	\$0.15	5-lbs.....	\$1.25
1-lb.....	.25	10-lbs.....	2.00
2-lbs.....	.50	25-lbs.....	3.75
100 lbs.....			\$12.00

## FLOUR OF SULPHUR

1 lb.....	\$0.15 lb.	25 lbs.....	9c. lb.
5 lbs.....	.12 lb.	50 lbs.....	8c. lb.
10 lbs.....	.10 lb.	100 lbs.....	6c. lb.

## COMMERCIAL FLOUR OF SULPHUR

Sold in 150-lb. bags only. Per 100 lbs., \$2.75.

## HAMMOND SLUG SHOT

A non-poisonous powder; it requires no further mixing or preparation; easily applied; not injurious or dangerous to animals, the person applying it or fruits and vegetables treated; destroys potato bugs and beetles, green and black fly, slugs, worms, caterpillars, etc. Ten to forty pounds is sufficient for an acre.

1-pound Package.....	20c. ..
5-pound Package.....	50c.

## HAMMOND'S GRAPE DUST

For Mildew and Blight, 5 lbs. ....75c.

## Bluestone (or Copper Sulphate)

5 lbs., per lb.....	15c.	50 lbs., per lb.....	10c.
10 lbs., per lb.....	12c.	100 lbs., per lb.....	9c.

INSECTICIDES CANNOT BE SENT BY PARCEL POST



## The Complete Dormant Spray

Let SCALECID be your dormant spray. Then you will know that you have done all that can be done at that particular time by any dormant spray or combination of sprays. Fall spraying with SCALECID controls pear psylla and peach leaf curl. Spring application controls aphids, pear thrips, leaf minor, case bearer and leaf roller. Either fall or spring spraying with SCALECID controls scale, bud moth, European red mite, fungus or blight cankers from which are spread fire blight, collar rot and root rot! And in addition to controlling these insects and diseases, year after year use of SCALECID invigorates the trees.

- More than a scale killer pleasant to use
- Economical It Spreads**
- 1 qt. can \$ .60
  - 1 gal. can 1.40
  - 5 gal. can 6.25
  - 10 gal. can 10.60
  - 15 gal. Drums 13.50
  - 50 gal. can 38.00

## SCALECID

THE COMPLETE DORMANT SPRAY

### PARIS GREEN

- ¼ pound.....\$ .15
- ½ pound......26
- 1 pound......45
- 2-pound package.....\$ .88
- 5-pound package..... 2.15

### PURE WHITE HELLEBORE

The cheapest and best preparation for destroying rose slugs, currant worms, etc. One-quarter pound, 20c.; half-pound, 35c.; pound, 60c.

### TREE TANGLEFOOT



For protecting trees against climbing insect pests in a simple, economical and effective way, use Tree Tanglefoot—a sticky substance applied directly to the bark of trees. One application remains sticky on the trees three months fully exposed to the weather. Easily applied with a small wooden paddle. One lb. will spread 8 feet long by 5 inches wide, 1-16 inch thick. Will stay on tree three months.

- 1-lb. can.....\$ .50
- 5-lb. can..... 2.25
- 10-lb. can..... 4.25

# Dethol

**INSECTICIDE DEODORANT      MOTH PREVENTIVE**  
**CLEANSER DISINFECTANT**



**KILLS**

Insect Pests, Flies, Mosquitoes, Roaches, Bed Bugs, Ants, Moths, Water Bugs, Animal Lice and Ticks.

Positively Kills Mosquitoes and Flies  
Will Rid Your Place of Roaches, Ants and Water Bugs

**Gets Rid of Bed Bugs**

- is a positive Moth Killer and Preventive
- 14 oz. .... \$ .50
  - Quarts ..... 1.00
  - Gallons ..... 3.00

### FUMIGATORS

Made from heavy galvanized iron. In demand for fumigating greenhouses with tobacco stems and tobacco dust. If the greenhouse is larger than the capacity of one of the fumigators, one should be placed at either end of the house. Being made from heavy galvanized iron, there is not any danger from fire.

- No. 2—Height, 16 inches. For a house 12x40 feet.  
Price ..... \$4.25
- No. 3—Height, 20 inches. For a house 15x100 feet.  
Price ..... 5.25

### FORMALDEHYDE, 40% SOLUTION

IT IS VALUABLE AS A GERMICIDE, FUNGICIDE AND DISINFECTANT.

- 1-Pt. Bottles, 50c. 1-Qt. Bottles, 90c. 1-Gal. Jug, \$3.00.



### BUG DEATH

**BUG DEATH** kills Potato, Squash and Cucumber Bugs, Currant and Tomato Worms, and all bugs and worms that chew the leaves of plants; non-poisonous.

**Directions for Applying Dry:**

For potato and other vines which require a top application, apply dry with Shaker or Shifter at the rate of 15 to 25 pounds per acre to an application, according to size and conditions of the vines.

- 1-pound package.....\$ .20
- 3-pound package..... .40
- 5-pound package..... .60
- 12 ½-pound package..... 1.45
- 100 pounds..... 3.75

### "BLACK LEAF 40" NICOTINE SULPHATE—40% NICOTINE

This is the insecticide that is so highly recommended by Experiment Stations. It destroys Aphis (plant lice), Thrips, Leaf-hoppers on all tree, bush and vine fruits, vegetables, field crops, flowers and shrubs; also Apple Red Bug, Pear Psylla and similar soft-bodied sucking insects—all without injury to foliage.

May be combined with other sprays. Highly concentrated. Soluble in water—easy to mix—does not clog nozzles.

**YOU CAN NOT GO WRONG BY ORDERING "BLACK LEAF 40" FOR SUCKING INSECTS.**

**PRICES:**

- 1 oz., \$0.35, makes 6 gallons spray
- ½ lb., 1.25, makes 4 to 120 gallons spray
- 2 lb., 3.50, makes 160 to 500 gallons spray
- 10 lb., 13.50, makes 800 to 2500 gallons spray

### NIKOTEEN

Is the most powerful known insecticide and will be found more economical and convenient than weak tobacco extracts. Price: Pint cans, \$2.25.

- VAPORIZING FANS (for above).....\$ .60
- IRONS ..... .60
- 3 FANS, 3 IRONS and 1 HOOK..... 3.50

### NICO-FUME

Nico-Fume is a Tobacco Paper insecticide for fumigating greenhouses. Extensively used by prominent florists. Very easy to apply. Prices: 24 sheets, \$1.25; 144 sheets, \$5.50, and 288 sheets, \$10.00. Directions on each package.

### APHIS PUNK (NIKOTEEN)

Especially designed for use in private places and in houses without convenient furnaces for heating irons necessary for vaporizing Nikoteen or Tobacco Extract. It is very effective as an insecticide. The Punk is lighted with a match and allowed to burn, which it does without flaming, at the same time giving off dense white fumes of Nikoteen that kill aphids and thrip very effectively. Per box, \$8.00.

### TOBACCO DUST

Price: 5 pounds, 30c.; 20 pounds, \$1.00; 100 pounds, \$5.00.

### TOBACCO STEMS

Dampen thoroughly a few hours before using, place about a half-pound over a handful of shavings in a fumigator, and light. 50-pound bale, 5c. pound.

### TOBACCO SOAP



3-oz. cake makes 1½ gallons prepared solution, 10c. Mailed, postpaid, for 13c. 8-oz. cake makes 4 gallons prepared solution, 20c. Mailed, postpaid, for 25c.

### KEY BRAND CUT WORM KILLER

**FOR USE AS POISONOUS BAIT AGAINST CUT WORMS AND SLUGS** by placing around plants subject to attack. It has an enticing odor that worms prefer to vegetation.

**NOTE:** One pound is sufficient for 100 plants in hills or 75 in rows.

- 25-lb. packages, \$5.00.
- 5-lb. packages, \$1.50. 1-lb. packages, 35c.



## Pratts Poultry, Horse and Cattle Remedies

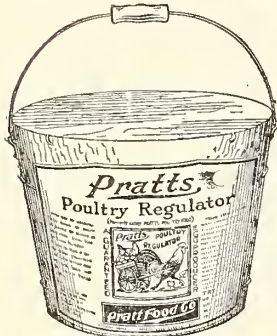

### HEALTHY HENS AND LOTS OF EGGS

You may expect vigorous, laying, paying birds when you give them

#### PRATT'S POULTRY REGULATOR

daily. It contains just those elements needed to keep poultry in perfect health. Both a tonic and digestive. Prevents common poultry ailments. Produces growth, gives increased vitality, and hastens maturity. Makes pullets early and constant layers.

25-lb. bag, \$2.50; 25-lb. pail, \$3.00; 12-lb pkg., \$1.40; 12-lb. pail, \$1.65; packages, 50c. and 25c.



Intelligent, humane and prudent owners of horses, cows and other live stock realize the value of good tonics, regulators and remedies. For nearly half a century Pratts has been adding to its successful record.

#### PRATT'S ANIMAL REGULATOR.

Packages: 25c. and 50c.  
12-lb. pails .....\$2.15  
25-lb. pails .....\$3.40

#### PRATT'S CONDITIONER FOR HORSES AND CATTLE.

(Formerly called "Pratts Food for Horses and Cattle.")  
7-lb. pkg. ....\$ .60  
12-lb. bags ..... 1.00  
25-lb. bags ..... 1.90  
100-lb. drums ..... 6.80



### RAISE EVERY LIVABLE CHICK

After a good hatch, keep the record good by raising every livable chick. For the first three weeks, and even longer, you will find that the greatest success follows.

#### PRATT'S BUTTERMILK BABY CHICK FOOD.

It makes baby chicks live. Makes bone and muscle. Brings along the weak ones. Prevents white diarrhoea, leg weakness, "pasting up" and other digestive troubles. Costs only a cent a chick for three weeks.

Bags—100 lbs., \$6.00; 50 lbs., \$3.25;  
25 lbs., \$1.75; 14 lbs., \$1.10.  
Packages—50c. and 25c.



### PRATT'S POULTRY DISINFECTANT

1/4 Gallon \$ .55  
Gallon 1.50

Three times as powerful as crude carbolic acid. A sure deodorizer, germicide and liquid lice killer. Use it in Roup, Colds and other contagious diseases.



### PRATT'S ROUP REMEDY

Tablets or Powder: \$1.00, 50c., 25c.  
Contains remedies which are quickly absorbed, purify the blood and reduce fever. Pills are convenient for individual treatment. Many poultrymen use this remedy the year round as an effective preventative.

### PRATT'S POWDER LICE KILLER

25c. and 50c.

Effective, non-poisonous, non-irritating. May be used wherever a powder is suitable. A splendid deodorizer. Will kill lice on horses, cattle, dogs or cats.



### PRATT'S WHITE DIARRHOEA TABLETS

To protect your chicks from white diarrhoea, the most destructive of all chick diseases, it is only necessary to give this remedy in the drinking water from the first drink. This remedy has saved many dollars worth of chicks to poultry raisers. You can depend on it.

25c. and 50c.

EVERY PRATT REMEDY IS GUARANTEED TO SATISFY OR MONEY REFUNDED



PRATT'S CONDITION TABLETS ..... 25c. and 50c. Packages  
PRATT'S GAPE REMEDY ..... 25c. and 50c. Packages  
PRATT'S SCALY LEG REMEDY ..... 30c. and 60c. Boxes  
PRATT'S SORE HEAD CHICKEN FOX REMEDY .. 30c. and 60c. Packages  
PRATT'S HEAD LICE OINTMENT ..... 30c. Boxes



### PRATT'S BUTTERMILK LAYING MASH

Is correct in composition, it furnishes the food elements required to make the yolks and whites in exact proportion.

Supreme  
100-lb. Bag, \$4.25.  
Victory  
100-lb. Bag, \$4.00.



### PRATT'S BUTTERMILK GROWING MASH

Produces large healthy chickens in the least time. They grow strong and vigorous making them pay for either layers or for table use.

100-lb. Bag \$4.50



### PRATT'S SCRATCH FOOD

Fine or Coarse. After using Pratts' Buttermilk Baby Chick Food, keep them healthy and growing on Pratts' Scratch Food

Supreme  
Fine for Chicks,  
100-lb. Bag \$4.75  
Coarse for Hens,  
100-lb. Bag \$4.25  
Victory  
Fine for Chicks,  
100-lb. Bag \$4.50  
Coarse for Hens,  
100-lb. Bag \$4.00

## DR. HESS Poultry and Stock Preparations



### Dr. Hess Poultry Pan-a-cea

makes poultry healthy; makes hens lay; not a stimulant, but a tonic, that tones up the dormant egg organs, brings back the scratch and cackle, and compels each hen to put her share of eggs in the market basket.

It also contains internal antiseptics that counteract disease; insures a healthy, singing poultry flock. Cost but a trifle—a penny's worth enough for 30 hens per day. 1½ lbs., 25c; 5 lbs., 75c.; 12 lbs., \$1.50; 25-lb. pail, \$3.00. **GUARANTEED.**



### DR. HESS ROUP REMEDY

LIQUID AND POWDER

For Roup, Diphtheria, Chicken Pox and all Catarrhal Diseases. It has three distinctive features: It is antiseptic, slightly astringent, non-irritating and healing. 4-oz cans, 25c.; 10-oz cans, 50c. **GUARANTEED**



### INSTANT LOUSE KILLER



Kills Lice on Poultry, Horses, Cattle, Sheep, Ticks, Bugs on Cucumber, Squash and Melon Vines; Cabbage Worms, Slugs on Rose Bushes, etc. Sold in sifting-top cans—look for the word "Instant" before buying. Price: 1 lb., 25c.; 2½ lbs., 50c. **GUARANTEED**

### Dr. Hess Dip and Disinfectant

Non-poisonous and non-irritating and guaranteed to be absolutely uniform in strength at all times. One gallon of Dip makes from 70 to 100 gallons effective solution. Spray it on roosts. Sprinkle it over the runs and in all cracks and crevices. Spray it on cattle and horses. Make a splendid dip for hogs and sheep. It's a sure parasitic and disease germ destroyer. Purifies stables, troughs, sinks, drains. **GUARANTEED** 1 Qt., 60c.; ½ Gal., \$1.00; 1 Gal., \$1.75.



### DR. HESS STOCK TONIC

Formula Printed on Every Package.

Every ingredient indorsed by the U. S. Dispensary and other high medical authorities. It aids digestion, makes stock healthy, and expels worms. Helps stock convert more ration into milk, flesh, blood and muscle. Every pound backed by the Dr. Hess & Clark unqualified guarantee. Prices: Packages, 25c. and 50c.; 10-lb. pkg., \$1.00; 25-lb. pail, \$2.25; 100 lbs., \$5.00.



### DR. HESS WORM POWDER

For Horses, Sheep, Cattle and Hogs. It is highly concentrated, and is an effective vermifuge. Dr. Hess' own prescription that proved effective in his practice. Price, 1½ lbs., 50c. **Guaranteed.**

### Dr. Hess Healing Powder

The modern Gall Cure. Cures Galls, Cuts, Wounds, Ulcers, Grease Heel. Antiseptic and soothing. Heals everything it touches by forming a coating, cleaning and closing up wounds. Comes in sifting-top cans. Price: 4-oz. 25c.; 10-oz. 50c. **ABSOLUTELY GUARANTEED**



### DR. HESS FLY CHASER

Drives flies away. One application lasts six hours. Prevents milk slump. Keeps cattle and horses contented during the fly season. Most humane idea of the age. Its use during summer months will insure good profits. **GUARANTEED** 1 Gallon ..... \$1.50



### DR. HESS HEAVE POWDER

A dependable preparation for relieving horses of heaves, chronic coughs, asthma, bronchitis, etc.; with careful diet, the frequent use of this valuable preparation will afford permanent relief in the majority of cases. Price, 1½-lb. package, 50c.



### Dr. Hess Colic Remedy

A reliable preparation for the treatment of Spasmodic and Flatulent Colic, Gripes, Acute or Chronic Indigestion, Impaction of the Stomach, Bowel Inflammation, etc. Price, \$1.00. **GUARANTEED.**

### DR. HESS DISTEMPER REMEDY

A reliable preparation for Distemper, Acute Colds, Fever and Cough. Price, 50c. **GUARANTEED.**

### BLATCHFORD'S PIG MEAL



The safety route from pighood to porkage. All "baby" pigs should be weaned on this strengthening tissue-builder. They will grow continuously and rapidly, developing bone and size without taking on surplus fat. 100 pounds makes 100 gallons of milk-substitute. 25-pound sacks..... \$1.25 50-pound sacks..... 2.25 100-pound sacks..... 4.50

### 'MILKOLINE'

Made from Pasteurized Modified Buttermilk, when properly diluted with water for feeding, costs only 2c. per gallon. Hustles Heavy Hogs to Market at lowest feeding cost. It isn't merely what Milkoline will do for the hogs you market, but here's the great Money Making Feature. Your brood sow will be in better physical condition to produce more and better pigs. Milkoline is the best tonic we know of for brood sows. There is no substitute for Milkoline and just as long as you delay feeding Milkoline you are sacrificing hundreds of dollars in profits every year. Milkoline is especially recommended for Baby Chicks and Laying Hens. Results in Great Gains. Will Require Less Grain, Produce More Eggs. Increase the Profits. Price per Gallon, \$2.00; Five Gallons, \$7.50; 10 Gallons, \$12.50; 32 Gallon Half Barrels, \$32.00, 55 Gallon Barrels, \$49.50

## One Drop of

### Bourbon Poultry Remedy

A few drops in fowls' drinking water cures and prevents white diarrhoea, cholera and other chick diseases. Use daily to keep your chicks healthy. Don't wait until disease strikes. Get it today. Small size 60c, half-pint \$1, pint \$1.50. At druggists, or by mail postpaid. Bourbon Remedy Co., Lexington, Ky.

Bourbon Poultry Remedy, Trial Bottle.....	\$.60
Bourbon Poultry Remedy, Half Pint Bottle.....	1.00
Bourbon Poultry Remedy, Pint Bottle.....	1.50
Bourbon Poultry Remedy, Quart Bottle.....	2.25
Bourbon Poultry Remedy, Half Gallon Size.....	3.50
Bourbon Poultry Remedy, Gallon Size.....	6.00
Bourbon Hog Remedy, Quart Size.....	2.25
Bourbon Hog Remedy, Half Gallon Size.....	3.50
Bourbon Hog Remedy, Gallon Size.....	6.00
Bourbon Egg Producer.....	.30
Bourbon Insecticide.....	.30
Bourbon Stock Tonic, 25-Lb Pail.....	3.60
Bourbon Stock Tonic, Package.....	.60
Bourbon Stock Tonic, Package.....	.30
Bourbon Colic-Relief, for Horses.....	1.20
Kentucky Horseman's Condition Powder.....	.60
Kentucky Horseman's Liniment.....	.60
Kentucky Horseman's Distemper Remedy.....	.60
Kentucky Horseman's Healing Oil.....	.30

## BOURBON REMEDIES

### BLATCHFORD'S LAMB FOOD

A Baby Food for Baby Lambs. Because it fully substitute the ewe's milk for motherless lambs. It carries all lambs in a thriving condition safely and rapidly from weaning time to the early market.

25-pound sacks.....	\$1.50
50-pound sacks.....	2.75
100-pound sacks.....	5.40

## BLATCHFORD'S CHICK MASH

**IT  
GIVES  
THE  
CHICKS  
A  
CHANCE**

Many poultrymen lose from one-third to one-half of all their chicks before they feather out. Improper feeding is the cause. Others are finding they can raise 90 to 95 per cent. of their chicks by starting and growing them on Blatchford's Chick Mash. It is the favored starting and growing feed of the most prominent and successful poultrymen in the country. It contains all the feeds and nourishment chicks need right from the start and shields them from **White Diarrhea, Bowel Trouble and Leg Weakness.**

4 lbs., 50c. 25 lbs., \$1.50. 100 lbs., \$5.50

## BLATCHFORD'S "FILL THE BASKET" EGG MASH



The excess nutriment taken by the hen from Blatchford's "Fill the Basket" Egg Mash causes the development of eggs so that she has to lay during the winter, while the ordinary unbalanced rations tend to produce fat hens, but lean profits.

Blatchford's "Fill the Basket" Egg Mash is made up of Blatchford's Calf Meal, the complete milk-equal, combined with the best quality meat and fish scraps and alfalfa and grain meals. This makes a perfect, balanced egg-producing mash, consisting of protein, 19 per cent.; fat, 4 per cent.; fiber, 10 per cent.

25-pound bags ..... \$1.25  
100-pound bags ..... 4.10  
500-pound lots ..... 20.00

## PRATTS CIRCLE-A HEN FEED

**THE BALANCED RATION FOR LAYING HENS.  
ALL GRAIN; NO GRIT OR SHELLS.**

This feed is formulated from pure, sweet grains. Only those grains are used that are of known value for producing eggs. This is the feed for the poultryman who feeds for profit. 5 lbs., 30c. 10 lbs., 50c. 100-lb. sacks, \$3.75. Special price in larger quantity.

## Pratts Victory Developing Feed

**"THE FEED THAT IS ALL FEED."  
ALL GRAIN; NO GRIT OR SHELLS.**

This feed is absolutely pure and unadulterated, containing no offal or injurious ingredients, such as rice hulls, ground straw or cobs, etc. It will not hurt or scour chicks. 5 lbs., 30c. 10 lbs., 50c. 100-lb. sacks, \$4.50.

## PURITY PIGEON FEED

The mixture contains a great variety of grain and seeds properly balanced under the direction of a successful man who has had years of study and experience with pigeons. No grit. No shell. 1 lb., 10c. 10 lbs., 80c. Per 100-lb. sack, \$5.50.

## C. & T. CO.'S HIGH GRADE PURE BEEF SCRAP

**50 TO 55 PER CENT. PROTEIN.**

This Beef Scrap is the highest possible grade, and is made from Pure Beef Trimmings and cracklings, and has no pork or other materials to cheapen same. It is fully guaranteed as to quality and will keep indefinitely. Price: 5 lbs., 50c. 100-lb. bag, \$4.75. 45% Scrap, 100-lb. bag, \$4.25.

## ALFALFA MEAL

This is a green feed all the year round. Everyone knows that alfalfa is fast supplanting clover. It is very high in protein, and furnishes the chicks a growing food which, at the same time, has a medicinal value. 5 lbs., 25c. 50 lbs., \$1.80. Per 100-lb. sack, \$2.75. Extra Fine, \$3.00.

## WATER GLASS

Put up expressly for packing away eggs, when they are plentiful and cheap. During the summer months especially eggs are much cheaper than they are in the winter time. With this preparation you can pack them away, and have a supply of fresh eggs all winter. One gallon of this solution is sufficient to mix with enough water to pack away fifty dozen eggs. Use 1 part Water Glass to 9 parts of water.

At a cost of only one cent a dozen, you will be able to save anywhere from fifteen to thirty cents on the dozen, and have the satisfaction of having your own eggs.

### PRICE

1-Quart Can ..... \$ .30  
1-Gallon Can ..... 1.00  
5-Gallon Can ..... 4.00

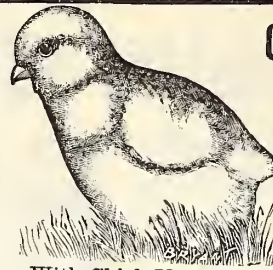

## Chick Manna or Health Food

**(FOR LITTLE CHICKS)**

**Chick Manna** is one of the first foods put up especially for baby chickens. It is the best thing on the market, and should be used exclusively for the first ten days. It will save many little chickens, and will repay many times its cost. The first ten days will decide whether the chick will grow into a profitable chicken.

With **Chick Manna** you are sure of a prime healthy chicken, one that will pay you to raise.

**Prices:**

1-pound package ..... \$ .15  
3-pound package ..... .40  
60-pound box bulk ..... \$6.25  
5-pound package ..... \$ .60  
15-pound package ..... 1.65

**FOR PREVENTION - FOR CURE**

# AVICOL

White Diarrhoea and Chicken Cholera can be cured and prevented by **AVICOL.**

**STOP THE LOSSES!**

**AVICOL SAVES THE CHICKS**—Avicol has a specific and selective action on the germs causing Cholera and White Diarrhoea. It knocks the germs and gives the chick a chance.

Prices ..... 50c. and \$1.00

## HACKETT'S GAPE CURE

**CURE FOR CHICKEN GAPES**

No drugging; simply confine the chicks and dust the powder over them; they inhale it; kills both worm and germ; treat the whole brood at once in less than five minutes.

Package, 40c. Postage on single package, 5c. extra.

## DON SUNG

**TABLETS FOR EGG LAYING**  
Scientifically compounded to make a balanced tonic and regulator for hens and to stimulate egg laying.

A concentrated Medicine—no filler.  
Price 50 cents and \$1.00 Packages

## SUGGULENTA TABLETS

do away with all the bother, the time and labor of feeding your chickens green sprouted oats, cabbage, beets, roots and all other green food. Simply dissolve a tablet in the drinking water; fowls drink it with a relish.

Via parcel post direct to you:  
100 Large Tablets ..... \$ .60  
250 Large Tablets ..... 1.00  
500 Large Tablets ..... 2.00



## GRANULATED CHARCOAL

A little ground charcoal mixed with the soft feed in the morning, once or twice a week, is an excellent corrective for the fowls, and keeps them healthy. We carry three sizes, one for grown fowls, one for small chicks, and pulverized. 5 lbs., 50c. 25 lbs., \$1.25. 50-lb. sack, \$2.00. 100 lbs., \$3.00.

## GRANULATED MILK FOR POULTRY

1 lb., 15c. 25 lbs., \$2.00. 100-lb. bag, \$7.00.

## BONE MEAL FOR POULTRY

This is exactly the same as the Cracked Bone described below, only it is ground much finer. 5 lbs., 50c. 10 lbs., 75c. 50 lbs., \$3.00. 100-lb. sack, \$5.50.

## CRACKED BONE FOR POULTRY

This article is manufactured from fresh, clean bones, and is perfectly pure and sweet. We carry two sizes—No. 1 for grown fowls, and 2 for young chicks. 5 lbs., 50c. 10 lbs., 75c. 50 lbs., \$3.00. 100-lb. sack, \$5.50.

## CRUSHED OYSTER SHELLS

It aids digestion as well as supplying lime. No. 3 for young chicks. 5 lbs., 15c. 100 lbs., \$1.00. 500 lbs., \$4.50. Special prices in larger quantities.

## MICA QUARTZ GRIT

5 lbs., 25c. 100-lb. sacks, \$1.00. 500 lbs., \$4.50.  
(Poultry, Pigeon and Chick Sizes.)

## BLATCHFORD'S CALF MEAL DOUBLED FARM PROFITS



Maturing or weaning all your calves rapidly on **Blatchford's Calf Meal**, at a cost of about one-fifth of what you get for your milk, then selling all the milk at a good profit, should appeal to you and to every wide-awake farmer as a good, profitable proposition. These profits both ways, need not be guessed at; they are discernible at a glance. Another source of profit that heretofore has been overlooked by most farmers is the raising of the fall and winter calf on this same milk-substitute. Many farmers and dairymen have taken up winter dairying, reaping the extra big profits on milk and cream during the winter months, but often the calf has been immediately "murdered." Calves raised during the winter give you veal during the term of high prices and are just as easily raised then as during the summer. Fall "freshening" is greatly to be desired. With the help of the silo or an abundance of alfalfa hay the winter feeding keeps up the milk supply until the new grass comes in the spring. The new pastures stimulate the milk-flow and keep it up through the summer. The winter milk prices more than offset the cost. When you stop to consider that this complete milk substitute costs you less than skim milk and is far better for calf-raising—made expressly for the calf—you will get some idea of its high efficiency. It is made from the several kinds of whole grains and seeds, and includes oil, sugar and albuminous compounds, pure locust-bean meal and pure flaxseed ground, with the oil left in. You cannot begin to get the results from any other method of calf-raising that you can get from feeding **Blatchford's Calf Meal**, the complete milk equal. **PRICES:** 25-lb. bag, \$1.50; 50-lb. bag, \$2.75; 100-lb. bag, \$5.50..



### BY USING **KOW-KARE**

THE GREAT COW MEDICINE

Watch every cow, and at the first sign of disorder in appetite, digestion or flow of milk, give a dose of **KOW-KARE**. Carefully follow the directions as given on the box, and that cow will get well.

**KOW-KARE** is in powder form, to be given in regular feed. It cures abortion, barrenness and scours, caked udder, removes retained afterbirth, purifies the blood, strengthens the appetite, vitalizes the nerves and prevents disease. It increases

the milk. It is a medicine for cows only. **Prices, small size, 65c.; large size, \$1.25.**

## BAG - BALM

For all diseases of the cow's udder and teats there is no remedy so quick and certain in its curative powers as **BAG BALM**. It is a soothing, penetrating ointment, especially adapted for all those serious and annoying troubles known as caked bag, cow pox, chapped, cracked and sore teats, bunches, chafing and inflammation of all kinds. **BAG BALM** penetrates through the skin and inner tissues at once, reaching the glands, where it reduces the inflammation, breaks up the bunches and spreads its cooling, softening effect to all the affected parts. This remedy has met with unequalled success, and is found on the most progressive dairy farms in the country. **Price**..... **60c.**

## AMERICAN HORSE TONIC

This tonic is a specific for horses, an actual medicine that goes to the root of all horse ailments and removes the cause of the trouble. A few doses will send a dull, listless horse on its way rejoicing.

Its curative power is wonderful. **AMERICAN HORSE TONIC** is the best remedy known for worms, stoppage of water, all bowel complaints, inflammation of the lungs, recent founders, distemper, coughs, colds and swelling of the glands of the throat. **Small size, 35c.; large size**..... **65c.**

## HORSE COMFORT

The Most Remarkable Remedy Ever Compounded for **Healing Cuts and Open Sores of Every Kind**. **HORSE COMFORT** is a liquid preparation which is unequalled in its power to quickly cure all kinds of open sores or abrasions of the skin. It is used by simply wetting the sore spot. No bandages or filthy rags, no rubbing or heating it in. Simply wet the spot and the cure begins. **Price, per bottle, 35c. and 65c.**

## BLACKMAN'S SALT BRICKS

Easiest and best way to give medicine to stock. It salts them too.

**Blackman's Medicated Salt Brick**, originated by a noted Veterinary Surgeon, insures stock getting the needed medicine without trouble or loss of time to their owners. When dropped in the feed-box, the brick is licked by the animal as needed, just as people use salt with their meals. Contains Copper as for Worms, Sulphur for the Blood, Saltpetre for the Kidneys, Nux Vomica, a Tonic, and Pure Dairy Salt. It is a wonderful improvement over the old plan. **Why not try it?**  
**DOZEN**..... **\$3.00**

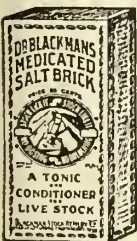

## SPRATT'S DOG REMEDIES

These remedies have been on the market for fifty years, and are sold in most every country in the world. In offering them for sale we recommend them as being the best in their line, and properly used will give satisfactory results.

We do not list but a few of the various remedies of this standard make and if you desire any of those we do not list, we will be glad to get them for you.

**Spratt's Dog Cake**, the standard dog food used at the different kennels and dog shows throughout the world. **Prices, small carton, 20c.; medium carton, 40c.; large carton, 75c.; 100-lb. bags, \$12.00; 25-lb. boxes, \$3.25; 50-lb. boxes, \$6.35; 100-lb. boxes, \$12.50.**

**Spratt's Puppy Cake**, small carton, 20c.; medium carton, 40c.  
**Spratt's Puppy Meal**, carton, 20c.  
**Spratt's Pheasant and Turkey Meal**, carton, 40c.; 25 lbs., \$3.25; 50 lbs., \$6.10; 100 lbs., \$12.00.

<b>Spratt's Elbo</b> .....	\$.60
<b>Spratt's Alterative Cooling Tablets</b> .....	.60
<b>Spratt's Anti-Vomit Tablets</b> .....	.60
<b>Spratt's Digestive Tablets</b> .....	.60
<b>Spratt's Diarrhoea Tablets</b> .....	.60
<b>Spratt's Distemper Tablets</b> .....	1.00
<b>Spratt's Hair Stimulant and Restorer</b> .....	.60
<b>Spratt's Kidney Tablets</b> .....	.60
<b>Spratt's Liniment</b> .....	.60
<b>Spratt's Pneumonia Tablets</b> .....	.60
<b>Spratt's Purgative Tablets</b> .....	.60
<b>Spratt's Worm Capsules for Puppies</b> .....	.60
<b>Spratt's Tonic and Condition Tablets</b> for toy dogs and puppies.....	.60
<b>Spratt's Distemper Tablets</b> for toy dogs and puppies.....	.60
<b>Spratt's Vermifuge Capsules</b> for toy dogs and puppies.....	.60
<b>Spratt's Eezema and Sarcoptile Mange Remedy</b> .....	.60
<b>Spratt's Patent Improved Dog Soap (White)</b> , for fleas, lice, etc. It is entirely free from poison and at the same time most effective in the destruction of lice and fleas. Per cake.....	.25
<b>Spratt's Patent Antiseptic Soap (Black)</b> , for veterinary uses, etc. Per cake.....	.50

## SAL-VET

**SAL-VET** is a medicated salt—a safe, simple, inexpensive remedy which gives stock the medicines they need along with the salt they crave. It requires no dosing, no drenching, no starving. It goes into the stomach and intestines and loosens the leach-like hold these blood-sucking parasites have on the tender linings. It drives the robbers out—without bother or trouble to you. Your animals eat **SAL-VET** in place of common salt and thus doctor themselves.

### PROTECT YOUR HERD AGAINST DISEASE

**A SINGLE WORM-INFESTED HOG IN YOUR HERD IS A CONTINUAL MENACE TO YOUR HOG PROFITS.**

It is the worm-infested, half-starved animals that spread the deadly **worm-carrier** over your farm. They are **disease-breeders and disease-carriers** of the worst kind. Helpless themselves to resist contagion, they let down the bars to the cholera scourge and death stalks through your herd. They are the **danger spots** in every herd.

5-lb. packages "Sal-Vet".....	at \$ .60 each
15-lb. packages "Sal-Vet".....	at 1.50 each
50-lb. pail "Sal-Vet".....	at 4.00 each
100-lb. kegs "Sal-Vet".....	at 6.75 each
200-lb. barrels "Sal-Vet".....	at 12.00 each
300-lb. barrels "Sal-Vet".....	at 16.00 each

### GRANGE GARGET REMEDY

This remedy has stood the test of twenty years as a successful remedy, and is indorsed by thousands of dairymen.  
**Price, Per Can**..... **65c.**

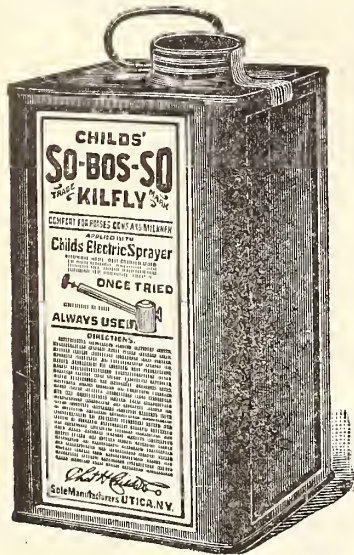

## SO-BOS-SO

Trade **KILFLY** Mark

Cows will give 15 to 20 per cent. more milk if protected from the torture of flies with **So-Bos-So-Killfly**. Kills flies and all insects; protects horses as well as cows. Perfectly harmless to man and beast. Rapidly applied with sprayer, 30 to 50 cows sprayed in a few minutes.

What is more trying to the patience than to milk a cow when she is continually stepping back and forth and lashing her tail under the irritation of a lot of flies? A moment's work with a sprayer and a little **So-Bos-So-Killfly**, and all is quiet and serene. From 30 to 50 cows can be sprayed in a few moments.

- 1-quart can.....\$ .50
- 1/2-gallon can......75
- 1-gallon can..... 1.25

Sprayer for applying **So-Bos-So**, 50c.

## COW-EASE

RELIEVES CATTLE AND HORSES FROM FLIES.

A liquid preparation carefully compounded from effective materials. It is of the right consistency for applying with a sprayer, and it will not gum the hair or blister the skin.

**A SURE PREVENTIVE FOR LICE, TICKS AND VERMIN.**

A light application of **Cow-Ease** will relieve cattle from lice, also prevent tick—the cause of Texas Fever.

**Cow-Ease** is an excellent article for spraying the interior of hen houses, also roosts and dropping board; it will prevent head lice and fleas and keep the house in a sanitary condition.

PRICES: Qt., 50c.; 1/2 Gal., 85c.; Gal., \$1.50; 5-Gal. Can, \$7.00



## CREONOID

LICE DESTROYER AND FLY SPRAY.

Takes the worry off your hens. Protects your cattle and horses.

**CREONOID** means animal comfort. It effectively keeps them free from the persistent Texas and other flies. It means comfort in milking and increased yield in milk. Eliminates fretting and nervousness.

Use it freely to keep the hen-house clear of pests.

PRICE: Gallon Cans.....\$1.25



## Dr. Hess Fly Chaser

Drives flies away. One application lasts six hours. Prevents milk slump. Keeps cattle and horses contented during the fly season. Most humane idea of the age. Its use during summer months will insure good profits. **GUARANTEED.**

One Gallon.....\$1.25

## GRADE 1 CREOSOTE OIL

Grade One Liquid Cresote Oil is coal-tar cresote refined sufficiently to give the maximum efficiency to the convenient and inexpensive Brush and Open Tank methods of treatment. Briefly, Grade One Liquid Cresote Oil is superior to the commercial coal-tar cresote for use by the small consumer, because

- It is liquid.
- It is free from water.
- It has low evaporation loss.
- It has high specific gravity.
- It has low viscosity, and, being liquid, penetrates readily and deeply into the wood.
- It has increased antiseptic and decay-preventing qualities.
- It is a clean oil and imparts a pleasing, dark-brown color to the wood.
- It is uniform, standardized material.

- 1-Gallon Can.....\$1.00
- 5-Gallon Can..... 4.50



## KILL-GERM DIP AND DISINFECTANT

These goods represent the highest attainment in Dip Manufacture.

An official dip of great efficiency for the killing of Lice, Ticks, Scab and other Parasites and disease germs which infest the bodies and pens of Hogs, Sheep and Cattle.

One of the most powerful Disinfectants and Germicides ever produced. A powerful Antiseptic and Purifier. For sanitary purification of dwellings and tenement houses, sinks, closets, stables, public schools, railway stations, hospitals, workshops, hotels, etc., it is unequalled.

- 1-quart can.....\$ .65
- 1/2-gallon can..... 1.05
- 1-gallon can..... 1.60
- 5-gallon can..... 7.50
- 1/2 bbl., per gallon..... 1.25
- 1 bbl., per gallon..... 1.20

## DOMINION FLY SPRAY

is an oil heavily charged with chemicals, having the peculiar property of giving off for a long time a vapor which drives away all kinds of flies. **DOMINION FLY SPRAY** contains about 4 per cent. Cresol, and is perfectly safe for use on all animals. If the animal licks it, no harm will result. Cows sprayed with this every morning go through the heat of the day with ease and comfort. Such cows keep up their flesh and their flow of milk; where cows are left to the ravages of flies, they fall off in flesh and the flow of milk is greatly reduced.

- 1-Gallon Cans.....\$1.25
- Sprayers used for putting on Fly Spray, 50 cents.



DISINFECTANT DEODORANT ANTISEPTIC

1-Gal. Bottle

- 1-Quart Bottle.....\$ 1.25
- 1-Gallon Bottle..... 3.00
- 5-Gallon Carboy..... 12.50

## ARROW CARBOLINEUM

Made in U. S. A. Formerly Avenarius Carbolineum

PRESERVES WOOD EVERYWHERE

against rot and decay, adding at least 100 per cent to the life of fence posts, poles, sills, floors, bridge timbers, porches and to wood embedded in concrete

**FOR STAINING BUNGALOWS AND FARM BUILDINGS**

Arrow Carbolineum is brushed on the wood and is self-absorbing, therefore need not be rubbed nor worked into the wood like paint

- COVERING CAPACITY**
- 350 square feet on dressed lumber
- 250 square feet per gallon on rough lumber
- 100 square feet per gallon on shingles

Second coat only requires one-third or one-fourth the quantity for first coat

**KILLS MITES IN POULTRY HOUSES**

PRICE

- 1-Gallon Can.....\$1.75
- 5-Gallon Can..... 7.00





## BANNER ROOT CUTTERS

No. 7

### EXCLUSIVELY FOR POULTRY

It cuts fast and is easy running. Leaves the feed in fine brittle, ribbon-like strips that make choking impossible. Fowls large or small can safely eat the feed. The knives are adjustable and made of the very best of steel. An iron grate in bottom of hopper lets dirt and gravel escape before reaching the knives. In this cutter we offer the poultrymen a low-priced, high-grade, nicely-finished and mechanically constructed machine, and feel that anyone who desires to feed Roots and Vegetables to their flocks can well afford to own one. Two to five minutes will cut enough feed for a large flock of birds.

Price.....\$7.50



Banner No. 7

### BANNER No. 28

A New Root Cutter. A Shredder. Using the Patent Banner Knife. For Poultrymen, for Sheepmen, for Stockmen.

A Root Cutter that cuts all roots and vegetables like Beets, Carrots, Potatoes, Onions, Apples, Turnips, Cabbage or anything else of the same nature into ribbons, literally shredding the material into feed cut so fine that all stock and poultry can feed without danger of choking. Built strong and stout to stand power use, and furnished with a crank so it can be used by hand also. This cutter has a large capacity, is supplied with eight steel knives. It has a heavy cast iron Platter Wheel, 28 inches in diameter to which the knives are attached by bolts. The hopper is such



Banner No. 28

shape that the machine feeds itself and the roots cannot possibly get away from the knives until they are all cut. A grate in the bottom of the hopper allows the dirt to escape before going to the knives. This cutter is designed more particularly for power use for the large Poultrymen and Sheepmen. Weight of machine complete, 150 pounds. Capacity of hopper about 2½ bushels. Speed by power 125 to 150 Rev.

Price, Complete, with Pulley and Crank, \$29.25.

### BANNER No. 20

The No. 20 Banner Root Cutter. It is made for hand power. It has a capacity of 30 to 50 bushels per hour, although it will cut at the rate of a bushel a minute easily on the test.

It is well built, nicely finished, runs easily, feeds itself, separates the dirt from the cut feed. Price, \$17.50.

### BANNER No. 25— FOR HAND OR POWER.

This is a new style machine.

It can be used by hand or light power. Is very strong and durable. Capacity 30 to 60 bushels per hour.

Weight, 100 lbs.  
Price, with crank.....\$18.50

### BANNER No. 16

#### A GRAND MACHINE FOR HAND AND POWER USE—

Supplied with crank also for hand use. Capacity by hand, 30 to 50 bushels per hour. Weight, 150 lbs. Capacity by power, 2 to 3 bushels per minute. Our Retail Price, \$26.75.

### No. 35—BANNER ROOT CUTTER.

Heavy construction for hand or power, weight, complete, 185 pounds; capacity of hopper about 3 bushels.

This is a cylinder type cutter and is made strong to stand power. The hopper is large and deep. The Cutting Drum to which the knives are attached is strong and will not break or wear out. It is positive feed as the roots lay on top of the Cutting Drum. It has 30 gouge-shaped knives.

Price, complete, with Pulley and Crank .....\$37.50

### NEW BANNER "30" ROOT CUTTER

Turns easily by hand. At 60 revolutions, the knives hit and cut the roots 1800 times. The result being at a low estimate 1½ to 2 bushels per minute of cut feed. Cut feed left in long half round slices that has made the Banner Root Cutter a popular machine for this work for 20 years.

Weight, 175 to 190 lbs. Price, \$40.00.

### WILSON No. 0 FAMILY GRIST MILL

This mill is especially made for grinding Graham Flour or Corn-meal; can be adjusted for cracking grain if desired. Weight, 30 lbs., \$7.50. With iron stand; weight, 65 lbs. Price, \$10.50. Diameter of hand wheel, 20 in.

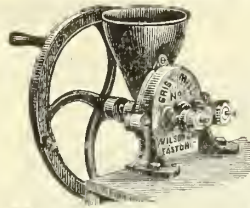

### WILSON No. 1 BONE AND SHELL MILL

Weight, without stand, 33 lbs...\$7.50  
Weight, with stand, lbs.....10.50

## RED CHIEF MILLS

No. 1—For Small Poultry Raisers. Price.....\$4.00

No. 2—Best Crank Mill on earth. Feed gauge to regulate grinding. Price.....\$5.50

No. 5—With large capacity, feed gauge and fly wheel. Clamps to box. Price.....\$7.75

No. 10—With feed gauge, fly wheel and handsome stand to screw on table. Price.....\$9.50

No. 12—Best Hand Mill on earth. Bronze boxes, steel axle, large fly wheel. Price.....\$16.00

No. 15—Power Mill for one-horse engine; strong, durable and easy running. Price.....\$16.00

### COMBINED HAND AND POWER MILL.

No. 20—Power Mill for two-horse engine; tight and loose pulley, best of bronze boxes and cold rolled steel axle, capacity 10 to 20 bushels per hour. Has no equal. Price, \$22.00.

Corn Sheller Attachment, shells the corn and grinds at the same time. Price, extra.....\$10.00

Table Meal Separator, makes fine table meal while grinding stock feed. Price, extra.....\$7.00

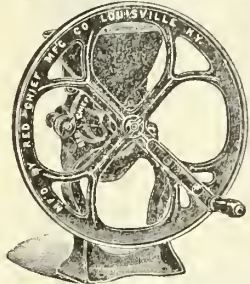

No. 10

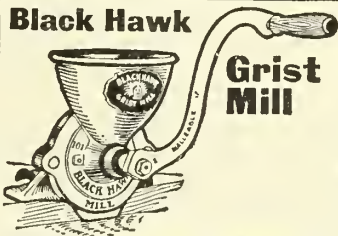

Black Hawk

Grist Mill

## Black Hawk Feed and Grist Mill

Just the thing for cracking corn, etc., for poultry. Makes best Graham flour and meal for table use.

Grinds corn, wheat, rye, rice, spices, etc. Weight, 17 pounds. Price....\$3.75

## MANN'S GREEN BONE CUTTER

No. 5C.—This machine is exactly the same as the No. 5B, with a crank handle instead of a balance wheel. Capacity not quite equal to 5B. Weight, 35 lbs. \$12.00

No. 5B.—This machine is exactly the same as the No. 5BM, except that it has not the iron stand. The capacity is the same. Weight, 60 lbs.....\$15.00

No. 5BM.—Intended for flocks of 15 to 25 hens. Mounted on iron stand. Cylinder 6 inches diameter, 4 inches deep. Cutter plate has 4 knives instead of 3.....\$18.00

No. 7.—Intended for flocks of 40 to 100 hens. Mounted on strong iron stand with large table for box or pan to receive cut bone. Weight, 107 lbs. Cylinder, 7¼ in. in diameter, 5¼ in. deep. Capacity, ½ to 1 lb. per minute. \$19.75

No. 11.—Intended for large flocks of over 100 fowls. Capacity 100 lbs. per hour. Horse-power required, 1 to 1½. Weight, 215 lbs. Diameter of pulley, 15 inches; 3½-inch face; speed of pulley, 300 to 350 revolutions per minute. Capacity, 100 lbs. and upward per hour.....\$45.00

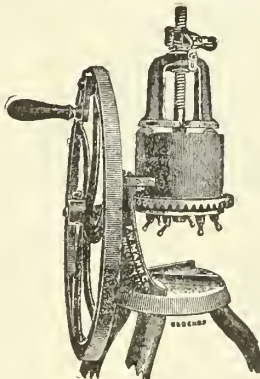

No. 5BM.

### Poultryman's Clover Cutter

Designed for cutting, either green or dry, such growths as clover, alfalfa, vegetable tops, etc. These growths are the cheapest and most productive egg-forming poultry foods for cold weather.

With four 7-in. knives; weight K. D. 60 lbs...\$20.00  
Gem Clover Cutter.....\$34.00  
Gem Clover Cutter with legs.....\$35.00

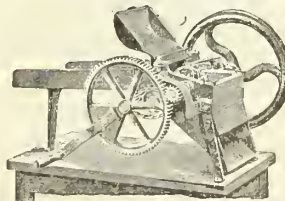

## The Prairie State Sand Tray Incubator

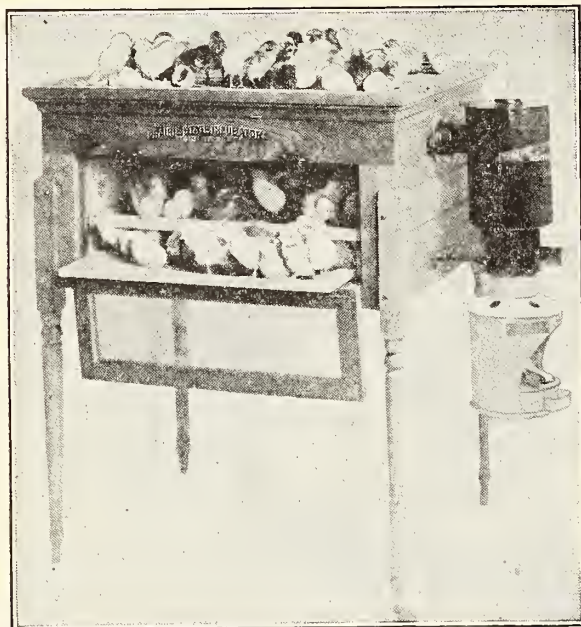

Prairie State Incubators contain many exclusive patented features found in no other machine. The Sand Tray models have the best reputation ever made by any incubator for high hatching results—for large chicks of extreme hardness. Remember, profit comes from the "Chicks that live."

**The Prairie State Sand Tray** with nursery—our standard for the past eight years. It is offered now in a further improved condition, fitted with our latest type fool-proof heater and provided with a wire chick tray substituted for the burlap formerly used, which, resting just above the sand tray, permits this tray to remain throughout the hatch, thereby retaining uniform humidity until completion.

- No. 0—100 hen eggs; 125 lbs. crated.....\$30.00
- No. 1—150 hen eggs; 160 lbs. crated..... 37.50
- No. 2—240 hen eggs; 240 lbs. crated..... 52.50
- No. 3—390 hen eggs; 275 lbs. crated..... 67.50

### Prairie State Universal Hover

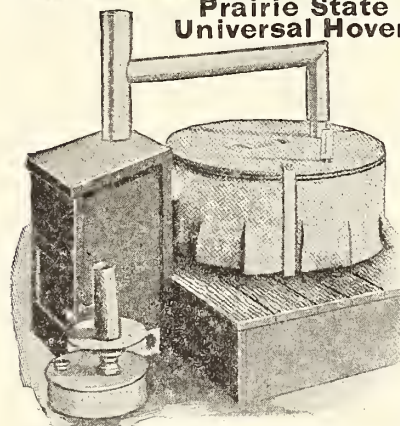

It may be attached to any form of outdoor brooder, two feet or more in height, to any size or form of colony house, shed, coop, piano, dry goods or organ box. It also enables those who wish to build their own brooders to get the best brooding device possible in an economical manner. It fills that want, felt by everyone who raises poultry, for something they can use anywhere, any time, and do the work well.

**UNIVERSAL HOVER**—Price for hover, with lamp case, smoke conductors, lamp and thermometer, \$9.00.

When used indoors alone, lamp case and smoke conductors are not required. Hover and lamp, \$8.00. Hover regulator, \$2.00 extra.

### The Prairie State Jr. Portable Hover

The Prairie State Jr. Portable Hover embraces in principle and construction all those original and successful features which at once establish the high reputation of the Prairie State Universal Hover. It is a Universal Hover so modified as to bring the lamp case to the floor level without sacrificing safety, economy of oil consumption, or ventilation, and involving attached lamp case and all-steel construction. It is a Portable Hover built along lines different from all others. Contrary to general practice in building Portable Hovers. **The Prairie State Jr. Portable Hover, 60 to 100-chick size. \$10**

## National Wick-Type Oil-Burning "Blue Flame" Colony Brooders

The "National" Wick-Type Oil-Burning "Blue Flame" Colony Brooder is highly efficient and thoroughly proven. After a year's service in the hands of thousands of users all over the country, we feel confident that "National" will meet every requirement. Without any change in construction whatever, and with the endorsement of retailers and users everywhere, we can assure you satisfactory service. The "National" Blue Flame Colony Brooder is of the wick-type construction, burns coal oil (kerosene) and is just as simple to operate as an ordinary house lamp. It will not smoke, is odorless and operates without noise. It is free from complicated mechanism, and has no troublesome levers, valves or thermostats. It is self-feeding, safe and durable, maintaining an even flame as long as there is oil in the reservoir.



OIL-BURNING	No. 60	No. 61	No. 62
Price.....	\$17.50	\$19.00	\$22.50
Chick Capacity.....	200	350	500
Diameter of Canopy.....	34"	42"	52"
Shipping weight.....	35 lbs.	40 lbs.	50 lbs.

## EGG TESTER

WITHOUT LAMP

PRICE 35c

POSTPAID 45c



## INCUBATOR LAMPS

- No. 1 Lamp and Burner, using 1/2-in. wick.....\$1.50 each
- No. 2 Lamp and Burner, using 1-in. wick..... 2.00 each
- No. 3 Lamp and Burner, using 1 1/2-in. wick..... 2.50 each
- Brooder Lamp, complete..... 2.00 each
- No. 1 Sun Hinge Burner..... .50c.
- No. 2 Sun Hinge Burner..... .60c.
- No. 3 Sun Hinge Burner..... .75c.
- Nos. 1 and 2 Wicks..... 30c. doz.
- No. 3 Wicks..... 40c. doz.

### Prairie State Tested Thermometers

- No. 2—Universal; may be used as hang-up, reclining, stand-up or inclining with proper holder. Without holder, each, \$1.00; postpaid.....\$1.10
- No. 5—Incline, with holder, each \$1.25; postpaid..... 1.35
- No. 6—Brooder Thermometer for Prairie State Brooders, each, \$ .75; postpaid..... .85

**ALL PRICES IN CATALOG SUBJECT TO CHANGE WITHOUT NOTICE.**

## QUEEN INCUBATORS

A **QUEEN** costs but little more, and the extra chicks that live and grow soon pay the difference. Remember, it is not how many chicks you **HATCH** that counts, but how many you **RAISE**. Chicks that hatch out weak and wobbly, and live but a few days, mean nothing to you but trouble and loss. They make one sick of the poultry business.

Most of the chicks you lose in the first few weeks die because they did not have, when hatched, enough strength or vitality for a good start. **Queen Incubators** are famous the country over for big hatches of strong, healthy chicks that live and grow.

### PROPER INSULATION

The **Queen** is doubly insulated. First we use double walls of California Redwood, forming a dead air space. Second, corrugated strawboard is used between the wooden walls. Proper insulation adds considerable expense to the manufacturing cost. However, it is an absolute requirement of a good incubator.

### QUEEN HOT WATER HEATING

The **Queen System** of hot water heating prevents the drying-out tendencies found in hot air incubators and provides a soft, uniform heat over every part of the egg chamber—a heat that is most natural for the hatching eggs. The circulation of water through the radiator prevents any moisture being added or taken away from the eggs. When it becomes necessary to remove the lamp, the hot water circulating through the radiator maintains an even heat within the egg chamber without the slightest variation.

**Queen Incubators** are not

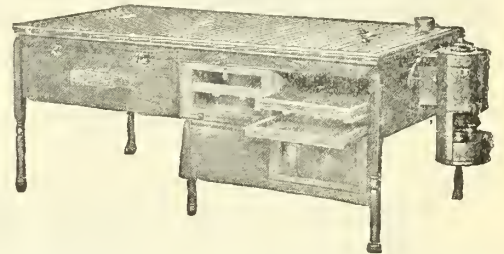

Queen No. 2—135-Egg Size

cheap, but they are cheap in the long run. They will be turning out good hatches years after the cheap machines have been junked.

The **Queen** line has all copper heater and pipes.

#### SIZES AND PRICES

No. 20 Style K—70-egg size.....	\$16.50
No. 21 Style K—130-egg size.....	27.50
No. 22 Style K—220-egg size.....	36.75
No. 1 Queen—85-egg size.....	27.50
No. 25 Queen—550-egg size.....	103.00
No. 2 Queen—135-egg size.....	\$37.50
No. 3 Queen—180-egg size.....	44.50
No. 4 Queen—275-egg size.....	57.75
No. 5 Queen—400-egg size.....	68.00
No. 45 Queen—1,000-egg size.....	157.00

## QUEEN STOVE BROODER

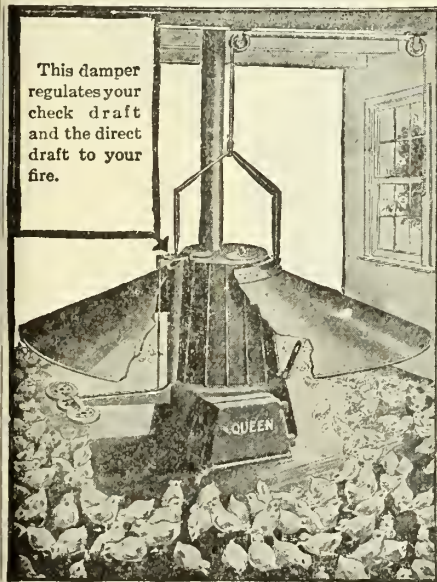

This damper regulates your check draft and the direct draft to your fire.

The **Queen Colony Brooder** is a new and improved design of brooder stove. It is made of highest quality iron castings that will wear and last indefinitely.

There are no drafts on the smoke pipe of the **Queen**. The check rests on top of the stove and opens outward when fire is too warm, thus giving a gentle inflow of air to retard the heat. While the opening of the draft to increase the fire is located at the top of the stove, it opens into the fire at the base through an opening extending down the side to the bottom. This feeds the draft into the fire from underneath with no opening below the hover.

#### BURNS ANY KIND OF FUEL

The **Queen** stove burns any kind of fuel with equally satisfactory results. We recommend chestnut sizes in all kinds of fuel and hard or soft coal, coke or charcoal burn equally well. Of course, hard coal will not cause the pipe to become dirty as quickly as the others, but it will give no better heat.

**No. 1—600-Chick Size, \$21.50    No. 2—1200-Chick Size, \$26.50**

## QUEEN OUTDOOR LAMP-HEATED BROODER

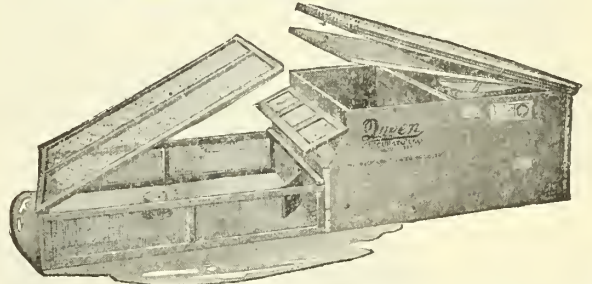

**Queen Outdoor Lamp-Heated Brooders** are designed to raise the chicks in all kinds of weather at any time of the year with insurance for success. They can be relied upon to give the little chicks the protection they need both day and night.

No. 10—125-chick size, shipping weight, 131 lbs.....	\$31.50
No. 11—165-chick size, shipping weight, 141 lbs.....	34.50
No. 12—250-chick size, shipping weight, 184 lbs.....	37.75

## QUEEN INDOOR LAMP-HEATED BROODER

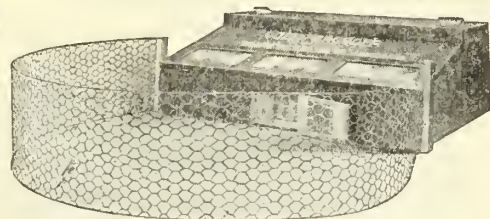

**Queen Indoor Brooders** are made of the same selected, high-grade lumber that is used to construct the outdoor brooders, and painted with two coats of paint.

No. 7—125-chick size, shipping weight, 65 lbs.....	\$19.50
No. 8—165-chick size, shipping weight, 78 lbs.....	22.75
No. 9—250-chick size, shipping weight, 80 lbs.....	25.50

## NEW MODEL Metal Egg Crate

The biggest thing to be said of the New Model is that it is designed and built—both inside and out—to eliminate waste of fillers and breakage of Eggs as well as deterioration of the carrier, thus insuring long life.

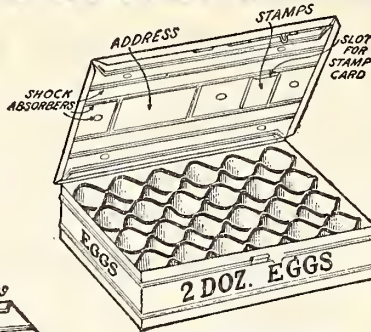

### METAL EDGE FILLER

The new patented Filler made of cardboard, circular in shape (like an egg) and reinforced with Metal Edges to insure strength, yet retain lightness in weight, is a wonder for safety and durability.

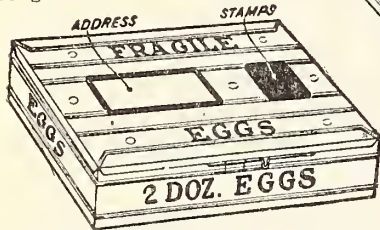

2 Dozen Egg Size.....	\$1.50
3 Dozen Egg Size.....	1.75
4 Dozen Egg Size.....	2.00
6 Dozen Egg Size.....	2.50

### COMBINATION CRATES

No. 1—2 lbs. and 1 dozen eggs.....	\$1.50
No. 2—4 lbs. and 2 dozen eggs.....	2.00
No. 3—4 lbs. and 3 dozen eggs.....	2.25

## PARCEL POST EGG BOXES

Eggs need protection. This shipping package is so constructed that the eggs are separated by a thickness of corrugated board and the entire contents are surrounded by a double wall of air-cushioned corrugated board. Absolute protection is therefore assured, as the box possesses sufficient strength and durability to stand the usual rough handling in transit.

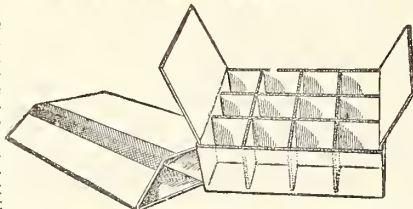

Boxes holding 1 doz.....	20c. each
Boxes holding 2 doz.....	25c. each
Boxes holding 3 doz.....	30c. each

## ANDERSON EGG BOX

FOR FANCY  
EGGS FOR  
HATCHING.



	Shipping Weight.	Per Dozen.
1 Setting .....	10 lbs. per doz.....	No. 3, \$3.50
2 Setting .....	13 lbs. per doz.....	No. 4, 5.00
50 Egg Size.....	24 lbs. per doz.....	No. 5, 6.50

This box may be used either Parcel Post within weight limit or Express.  
Use string instead of sealing strips for Parcel Post.

## MASTER BREEDERS LIVE CHICK BOX

Shipped Crated to Save Freight.

	Price Each	Per Dozen
25 Chicks. Size, 11x 9x5 1/2.....	20c.....	\$2.20
50 Chicks. Size, 18x11x5 1/2.....	30c.....	2.75
100 Chicks. Size, 22x18x5 1/2.....	40c.....	3.50

## BOXES FOR FRESH EGG FOR THE MARKET TRADE

This is not a Parcel Post or Express Box, but is intended for counter and private use. Any one selling eggs will find this box a great convenience, as it obviates any mistakes in the count and also avoids any breakage.

Delaware Egg Boxes, two rows for 12 eggs, per 100.....	\$1.50
Eagle Egg Boxes, three rows for 12 eggs, per 100.....	1.20

**SPECIAL PRICES IN QUANTITIES**

## MOE'S MAMMOTH DRY MASH HOPPER

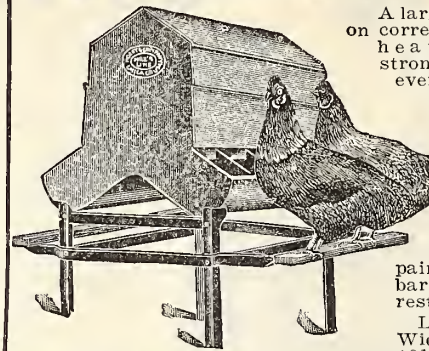

A large capacity hopper built on correct principles. Made of heavy galvanized iron, strong and substantial in every detail.

The taper shape and interior construction provides a uniform automatic feed, and the wire grid and cross wires prevents any waste.

The stand is of heavy angle iron, painted, and has wooden bars for the poultry to rest on when feeding.

Length of hopper, 35 in. Width, 21 in. Height, 18 1/2 in.

Capacity, 100 lbs. Height of stand, 15 1/2 in. Total height, 34 1/2 in.

Packed one in a box. Shipping weight, 50 lbs.

No. 3 Hopper and stand complete. Price each.....\$12.00

## MOE'S FEEDER AND EXERCISER

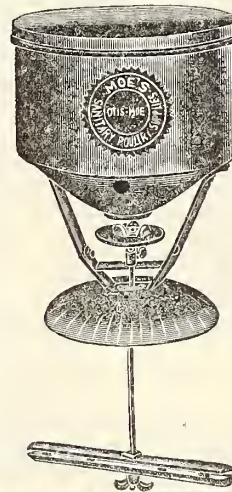

Fill the hopper once a week and let the chicks do the rest. Moe's Automatic Feeder will save more time, and save more feed, than any other fixture in a poultry yard.

Guaranteed to be rain and weather proof, rat and bird proof. Always ready to feed the chickens just as often and just as much as they want to eat, and at the same time makes them scratch and exercise in order to get it.

PRICE: No. 52—8 Qt.....	\$1.45
No. 53—16 Qt.....	2.00

## Moe's Insulated Double Wall Fountain

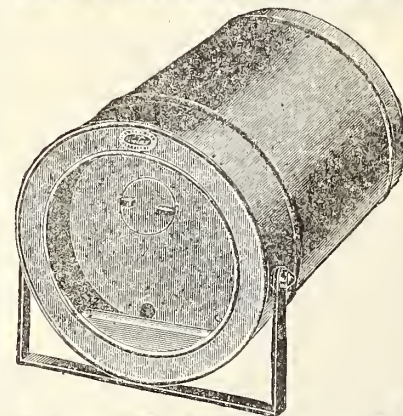

Made of best quality galvanized iron, with double walls packed with an efficient insulating material.

The wrought iron stand or rest is hinged, and acts as a handle to carry the fountain.

Plenty of fresh water at the right temperature, in zero or torrid weather will keep your birds healthy and increase the egg yield.

Shipping weight, 16 lbs. Capacity, 3 gallons. Packed one in a box.

No. 8. Each....\$4.00

## HUMPTY DUMPTY FOLDING EGG CRATES

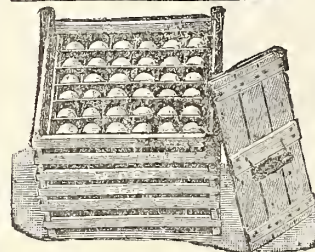

The Humpty Dumpty Egg Carriers are strong and durable cases, the favorite of thousands of shippers in the poultry industry. It delivers the eggs in the best shape, giving the largest return. The eggs it saves soon pays for itself.

Size	Price
3 Dozen.....	\$0.60
6 Dozen.....	.75
9 Dozen.....	.80
12 Dozen.....	.90

## Jamesway Dry Mash

### Hoppers

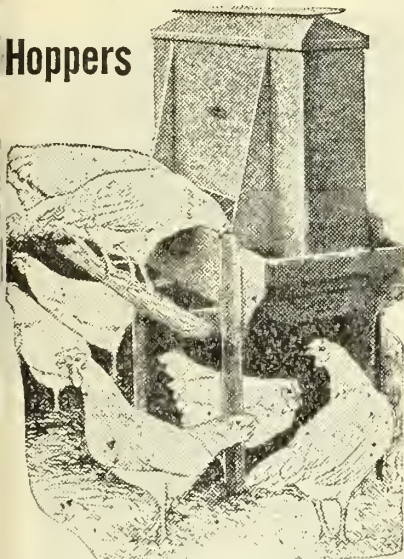

### A CENTRAL FEEDING PLANT

It keeps the mash before the birds all the time. It gives them all the feed they want, when they want it, every working hour of the day.

It is really "five hoppers in one." The small dry mash hopper has a capacity of 50 pounds dry mash. The large size hopper holds double the amount of dry mash. Each of the other hoppers will hold 4 quarts of grits, meat scraps, charcoal, or oyster shell, thus giving the hens free access to the things they need.

The hopper sets up off the floor; the smooth sturdy sheet metal legs raise hopper to a sufficient height to furnish exercise to the hens in going after the mash and at the same time use but little of the scratching room.

So arranged that the birds cannot in any manner foul the feed or feed spaces.

It is unexcelled for the breeder who is anxious to feed his birds properly for mating purposes.

Feed Saver Pans on either side catch all feed thrown out of feeding spaces by the hens. Stop waste of feed—all the feed goes to making eggs. Pans may be removed, as shown, and contents returned to hopper.

- No. 520.....\$13.50
- No. 521.....20.00

## JAMESWAY NO-WASTE CHICK FEEDER

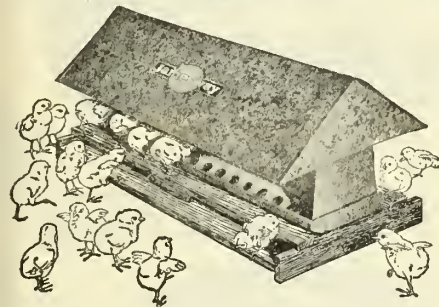

Feed chick mash in a Jamesway "No-Waste" Chick Feeder. Forty-five to fifty chicks can eat at one time from this feeder. It can be used from the first day to the day chicks mature. It solves one of the biggest problems on the poultry farm. Chicks cannot get in to scratch out or foul the feed.

Rain top shelters the feed and chicks from the weather. Roof tilts up to permit easy filling. The wood base raises the feeder up off the damp ground. Furnished with the feeder without extra cost.

It holds about 3/4 bushels of chick mash, enough to self-feed 200 to 250 chicks a week without refilling.

- No. 532.....\$8.00

## Jamesway Wall Feeder No Waste---Can't Glog

This wall feeder is about 22 inches high; 20 inches wide; and extends 10 inches from the wall. Distance from wall to roost is 16 inches. Made of selected galvanized steel sheets of superior weight and quality. Capacity 22 lbs. dry mash. For 20 to 35 hens. Top is inclined to prevent hens from roosting and fouling feed.

The roost is attached to the feed saver pan, which can be removed and contents poured back into the hopper whenever necessary. The feed saved will soon pay for the hopper.

- No. 522, 19 in. long.....\$5.00
- No. 524, 35 in. long.....7.00

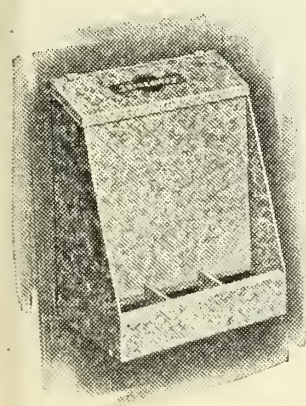

## JAMESWAY POULTRY WATERER

At least 65 per cent of an egg is water. Therefore to make lots of eggs a hen needs not only an abundant supply of clean, fresh air, and egg-making feed, but also an abundant supply of clean, sweet water.

She needs water not only for egg making, but also for maintaining her health. She needs it to carry off body wastes, to regulate the body temperature, to assist in digesting and assimilating her feed. And she needs and wants it when she wants it—at any and every hour of the day, and at a temperature palatable enough to induce her to drink lots of it.

The Jamesway Waterer holds eight gallons of water, sufficient for a flock of 200 birds twenty-four hours. The extra large capacity insures an adequate supply at all times—necessary for big egg production.

Built of first-class materials throughout, rendering the best and greatest service to users.

Weight, crated, 30 pounds.

### PRICE

- No. 512, 8-Gallon.....\$9.25
- No. 514, Electric Heated.....\$9.25
- No. 515, Stands.....1.60

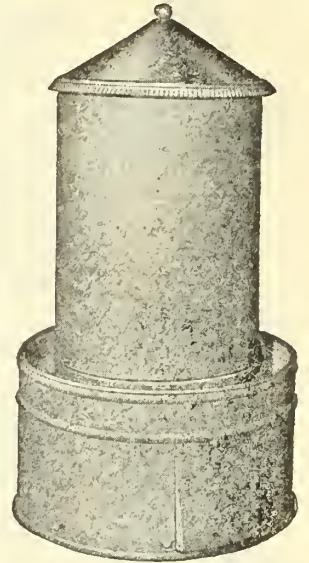

## JAMESWAY SELF-CLEANING NESTS

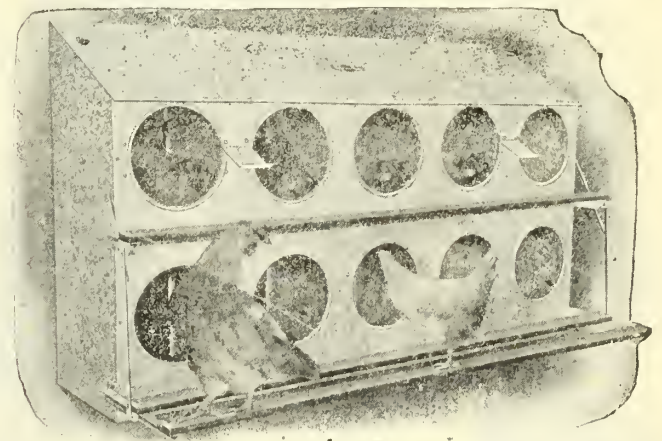

The Jamesway poultry nests are neat, they are pleasing in appearance, they are sanitary. But of high quality, selected steel sheets; they are non-absorbent and offer no harboring place for lice, mites or other parasites.

The inclined top prevents chickens from roosting above. The backs of the nests are open, making it easy to clean them. To clean the nests, all that is necessary is simply to release the catch in front which holds the section to the wall.

- No. 623—3 hole, 9 1/4 in.....\$5.50
- No. 626—6 hole, 9 1/4 in.....8.75
- No. 630—10 hole, 9 1/4 in.....12.00
- Trap Nest Attachment for each hole extra......40

## JAMESWAY BABY CHICK FEEDERS

Nos. 530 and 531

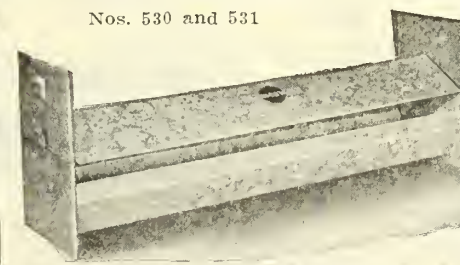

Cover is hinged. Can be tilted back to make filling easy. Cover and feeding pan are adjustable in height. Can be raised 3 inches—1/2 inch at a time—to accommodate chicks as they grow.

- 530—24 in..\$1.75
- 531—36 in..2.25



## Nesco Cone-Shaped Drinking Fountain

- 1 Quart.....\$ .30
- 2 Quarts..... .35
- 4 Quarts..... .45

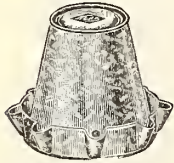

## NESCO ECONOMY CHICK FOUNT

- No ..... 0
- Diameter Pan, ins. 5
- Height, inches.... 4
- Each.....15c.

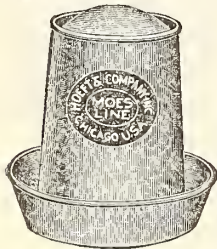

## BOTTOM FILL FOUNTAINS

The round taper shape prevents damage from freezing.

- No. Capacity Each
- 19 1 Quart \$ .35
- 20 2 Quarts .45
- 24 1 Gallon .60

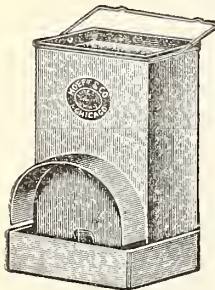

## DROP BOTTOM FOUNTAIN

Drop Bottom, easy to fill and to clean. Has wire handle and may be hung on the wall out of the litter and dirt.

- No. Capacity Each
- 40 2 Quarts \$ .95
- 41 1 Gallon 1.20
- 42 2 Gallons 1.50

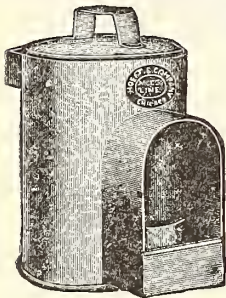

## Wall Fountain

The covered outlet keeps out dust and dirt, and a removable plate prevents any floating rubbish from being drawn into the reservoir.

- No. Capac. Each
- 97 2 Qts. \$ .90
- 98 1 Gal. 1.10
- 99 2 Gal. 1.40

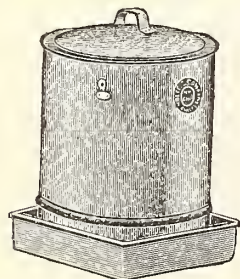

## MOE'S "TOP FILL" FOUNTAIN

Automatic Feed  
Easy to Fill  
and  
Keep Clean

- 1 Gallon \$1.75
- 2 Gallons 2.50
- 4 Gallons 3.25



## FEED AND DRINKING CUPS

**GALVANIZED**  
Especially suitable for Exhibition Coops.  
No. 61—Each.....\$ .15  
Doz..... 1.80



## WATER PANS

- 12 in. ....\$ .50
- 14 in. .... .60
- 16 in. .... .70

## MASON JAR FOUNTAIN

No. 142. Mason Jar Fountain, made of tin, and is screwed on an ordinary glass jar. Diameter 6 1/4 inches.  
Price, each..\$0.10  
Dozen..... 1.20  
Gross..... 14.40  
(Glass jars are not included.)

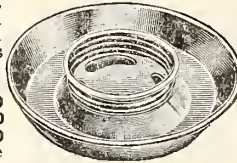

## Moe's Star Fountain and Feeder

Made of a single piece of heavy metal. No solder, no seams, no loose parts. Suitable for feed as well as water. Little chicks can not drown. Fits any Mason jar in 1 Pint, 1 Quart, and 2 Quart sizes.

No. 32 (Glass jar not included), each 10c.

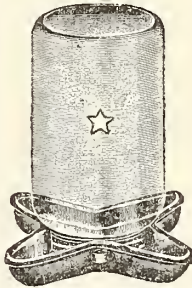

## Moe's Magazine Chick Feeder and Waterer

A new chick feeder and waterer with a magazine or container to hold a good quantity.

2 Qts. ....65



## BABY CHICK FEEDERS

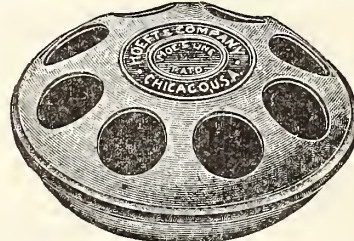

- No. 11—Diameter 6 in. with 8 holes, each 15c.
- No. 12—Diameter 8 1/4 in. with 12 holes, each 25c.

## MOE'S DOUBLE FEEDING TROUGHS



- No. 58—12 in. ....\$ .45
- No. 59—18 in. .... .60
- No. 60—24 in. .... .70
- No. 21—12 in., Single Row ..... .40
- No. 22—18 in., Single Row ..... .60
- No. 23—24 in., Single Row ..... .75

## GRIT AND SHELL BOXES

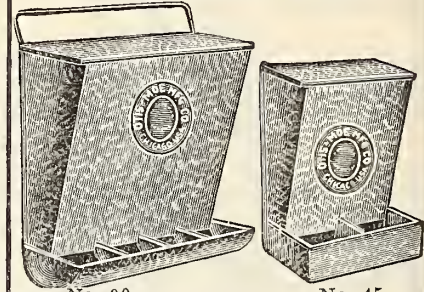

- No. 90
- No. 45
- No. 45—Two compartments.....\$ .40
- No. 9—Three compartments..... .90
- No. 90—Four compartments..... 1.25

## DRY MASH HOPPERS

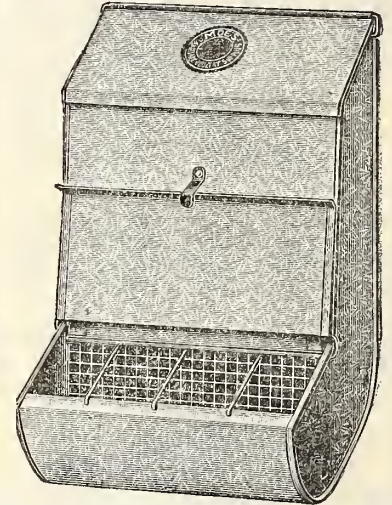

- No. 35—Width 8 1/2 in. ....\$1.50
- No. 36—Width 12 in. .... 2.00
- No. 13—Width 18 in. .... 2.40
- No. 37—Width 24 in. .... 2.80

## MOE'S WINTER FOUNTAIN

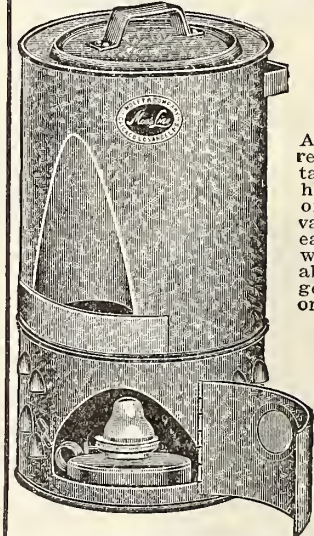

Capacity  
5 Gallons

A simple and reliable fountain with heater. Made of heavy galvanized iron, easily filled, with nothing about it to get out of order.

- No. 75—Fountain Complete.....\$3.85
- No. 74—Tank only..... 1.95
- No. 10—Heater only..... 1.90
- No. 26—1 Gal. Wall Fountain with Removable Bottom..... .75

## THE LAWN PARK COOP

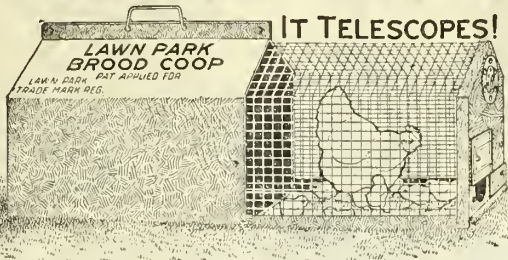

**IT TELESCOPES!**

It is made entirely of galvanized material, will not rust and is proof against all chick enemies. The body of coop is made from strong 28 gauge galvanized steel, the wire park is made from heavy 1/2-inch mesh galvanized wire screen. The Lawn Park is large and roomy, being 18 inches wide, 19 1/2 inches high and 24 inches long, with park closed and 48 inches long with park extended. Gives absolute protection to chicks, permits chicks to grow and thrive nature's way.

**PRICE, Each, \$4.00; 6 for \$22.50**  
Coop Without Park, Each, \$2.00; 6 for \$12.00

## Moe's Eclipse Feeding Troughs



- |                                  |       |
|----------------------------------|-------|
| No. 27—10 inch, Galvanized ..... | \$.25 |
| No. 28—20 inch, Galvanized ..... | .40   |
| No. 69—10 inch, Aluminum .....   | .50   |
| No. 70—20 inch, Aluminum .....   | .90   |

## IRON POULTRY TROUGH

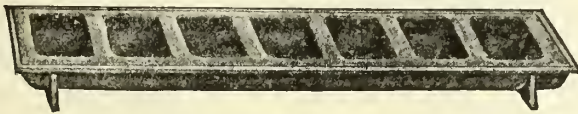

The above cut illustrates our new Cast-Iron Poultry Trough with arched lid, making it the best thing of its kind on the market.

- |  |        |
|--|--------|
| Length, 12 inches; Width, 6 inches, with Arched lid..... | \$1.00 |
| Length, 18 inches; Width, 6 inches, with Arched lid..... | 1.25   |
| Length, 24 inches; Width, 6 inches, with Arched lid..... | 3.00   |
| Length, 30 inches; Width, 6 inches, with Arched lid..... | 4.50   |
| No. 2—Length 6 inches, V-shaped with lid.....            | .60    |
| No. 4—Length 12 inches, V-shaped no lid.....             | .75    |
| No. 5—Length 18 inches, V-shaped no lid.....             | 2.00   |
| No. 6—Length 24 inches, V-shaped no lid.....             | 2.90   |

## MOE'S TRAP NEST FRONT

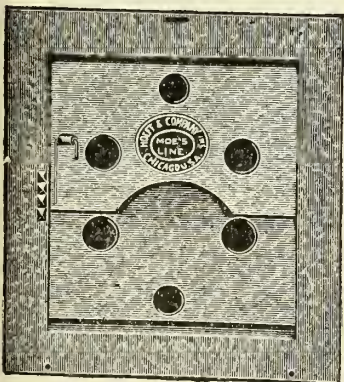

A new inexpensive and useful device which meets a popular demand and has proven to be a big seller.

Made of best quality galvanized iron, simple in operation, with no small loose parts to get out of order.

Can be easily fitted to any orange or ordinary wood box or coop and gives the breeder the opportunity to use a size nest adaptable to his birds, with a uniform automatic trap feature suitable for any breed of fowl.

Effectively traps the hen, yet allows ample ventilation.

Door is hinged, making it easy to remove the hen

or clean the nest. Made in one size. Dimensions 11 in. wide by 12 in. high  
No. 63. Trap nest front. Each...\$0.50 Per dozen...\$6.00

## OAT SPROUTER

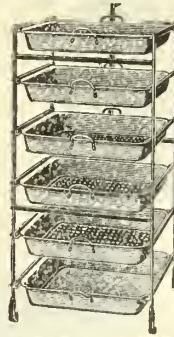

Steel frame, well braced and painted. With six heavy galvanized iron pans which are interchangeable. Provides the very necessary green feed at all seasons. Total Height 3 ft. Size of Pans 16x18 in. No. 110—Oat Sprouter ..... Each \$6.00

## MOE'S IDEAL POULTRY PUNCH

A new Improved Punch. Works easily, cuts clean, and does not pinch the foot. Length 3 1/2 in. Nickel plate. No. 39—Moe's Ideal Punch ..... Each 50c.

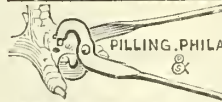

## LANSDOWNE POULTRY MARKER

Our special price 25c.



## PHILADELPHIA POULTRY MARKER

Large or small size, 25c.



## CAPONIZING TOOLS

You can do your own caponizing easily with this set of tools. Each tool is made for this special work, and are of the highest grade. These sets are packed in a neat wooden box.

Philadelphia Set.....\$3.25  
Farmer's Set..... 3.50

## French Poultry Killing Knife

Expeditious and humane way of killing and dressing poultry. Price, with instructions, each, 50c.

## PHILADELPHIA GAPE EXTRACTOR, 25c. each. ....

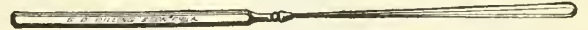

## WIRE HEN NESTS

EACH.....25c. PER DOZEN.....\$2.50

## PORCELAIN NEST EGG

The best and cleanest nest egg used. Each, 5c. Dozen, 30c. By mail, 45c.

## LICE KILLER AND NEST EGG

COMBINED IN ONE.

Lasting, effective. Not expensive. Does not affect the flavor of the egg nor injure it for hatching.

60c. Dozen.

## LEG BANDS

ALUMINUM

CELLULOID

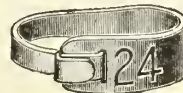

- |                 |        |
|-----------------|--------|
| Per Dozen ..... | \$ .15 |
| Per 50 .....    | .50    |
| Per 100 .....   | .75    |

ALL PRICES IN CATALOG SUBJECT TO CHANGE WITHOUT NOTICE.

## The Universal Meat Chopper

The Universal is the most perfect meat chopper on the market. The feed screw is so constructed that it feeds the meat to the knives without mashing it. The knives work against the plate giving a good clean cut, producing the best grade of chopped meat. The grinders are made in three numbers. The No. 331 has a plate that fastens to the table, as shown in illustration. The No. 333 has an arm that clamps to the table. The No. 304 has a plate like the No. 331. These grinders are all heavily tinned and will not rust.

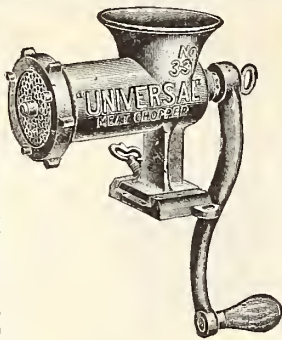

- No. 331.....\$5.00
- No. 333..... 5.50
- No. 304..... 8.75
- Stuffing Attachment for Nos. 331 and 333.....\$1.00
- Stuffing Attachment for No. 304..... 1.15

## THE UNIVERSAL FOOD CHOPPER

Chops all kinds of meat, raw or cooked, and all kinds of fruits and vegetables—in fact, everything that is ordinarily chopped in a chopping bowl—into clean-cut, uniform pieces, fine or coarse, as wanted, without squeezing or mashing, and with great rapidity.

- No. 0, Small Family three cutters.....\$1.85
- No. 1..... 2.25

## KEYSTONE FOOD CHOPPER

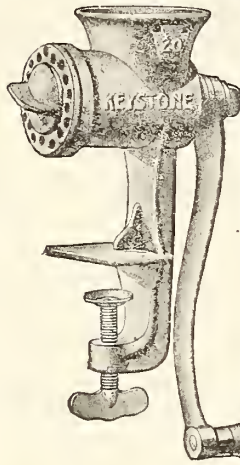

- No. 10, weight 3½ lbs., will chop 1½ lbs. meat per minute. Price each.....\$1.60
- No. 20, weight 4½ lbs., will chop 2 lbs. meat per minute. Price each.....\$1.90
- No. 30, weight 6¼ lbs., will chop 3 lbs. meat per minute. Price each.....\$2.40
- No. 40.....\$3.00
- No. 45.....\$3.00
- Stuffing Attachment for No. 20 or 30 Chopper.....85c.

## SLIDING KRAUT CUTTER

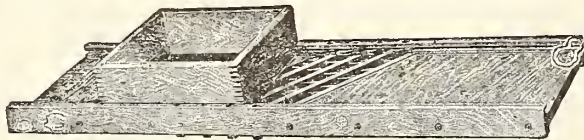

- Sliding Kraut Cutter with Two, Three or Four Knives.
- No. 50—2 Knives, 8x26 inches.....\$2.50
- No. 55—3 Knives, 8x26 inches..... 2.75
- No. 65—3 Knives, 9x30 inches..... 3.75
- No. 80—4 Knives, 13¼x40 inches..... 8.00

## HORSE RADISH GRATER

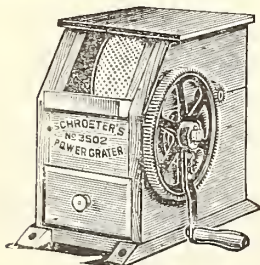

This Grater is designed for hand power only. Is constructed of wood, excepting Grating Drum, the sides of which are iron bolted together over which our Patent Double Drum is riveted. Besides horseradish, this machine will grate equally as well the following: Coconut, Potatoes, Bread, Turnips, Carrots and vegetables of all kinds.

PRICE.....\$35.00

## UNIVERSAL ALL STEEL LARD and FRUIT PRESS and SAUSAGE STUFFER



### PRICES.

- No. 44—4 quarts..\$10.50
- No. 66—6 quarts.. 11.50
- No. 88—8 quarts.. 12.50

This Machine is an excellent Lard Press, an equally good Sausage Stuffer, and is also extensively used for pressing the juices from fruit for making jelly, etc. The Universal Steel Press has many advantages over the old style cast-iron press. It is unbreakable, rigid and strong, and is more easily handled because it is lighter.

## VIRGINIA HOME CAN SEALER

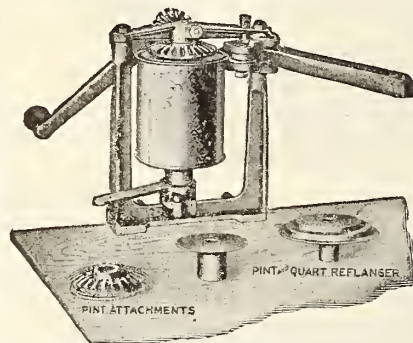

Virginia Home Can Sealer with can ready for sealing—Seals, Opens and Re-Seals. Enables you to use same Cans for next season.

With this Virginia Home Can Sealer and Virginia Sanitary Tin Cans, it is as easy and cheaply for you to do just as good canning in your own kitchen as if you had the finest canning plant in the world. In fact, you would have as good equipment only on a small, inexpensive scale with the additional advantage of having absolutely fresh-picked products to start with. It is far more economical to use Sanitary Tin Cans than it is to use glass jars for your canning. You can buy 100 Virginia Sanitary Cans for the price of two dozen glass jars.

- Sealer.....\$21.00
- Price of No. 2 and No. 3 Cans on application.

## HOME CANNING BOILER

Will successfully can fruits and vegetables in either tin cans or quart glass jars.

The boiler will hold 12 tin cans or 10 Mason quart jars at one loading. The work can be done on an ordinary cook stove or range.

The complete outfit consists of boiler, steam gauge, safety valve and crate. Weight, 80 lbs. For persons preferring to use tin cans, a soldering outfit can be furnished at an extra cost of \$18.00, gasoline blast furnace, two round capping irons and two tipping coppers. Home Canning Boiler, \$22.00.



## COOK STOVE FRUIT DRIER

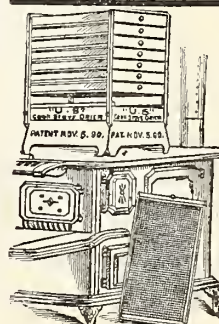

To meet the demand for a small Drier, suitable for use on any ordinary room, kitchen, cook or gasoline stove, we offer the U. S. Drier. It is a very simple, economical, efficient and convenient arrangement, and for farmers use just what is wanted, a durable drier at a reasonable price.

Dimensions, 26 in. high, and takes up space on stove, 21x15 inches.

OUR SPECIAL PRICE, \$7.50



## RANNEY REFRIGERATORS

These Refrigerators are constructed with an inside case of odorless and tasteless lumber, matched and clamped together, well nailed and glued, and fastened to hardwood cleats, making it a thoroughly air-tight strong cabinet in itself. The outside case is of solid hardwood lumber, and is nailed and glued to the cleats which bind the inside case, thus making it one of the strongest and most durable Refrigerators ever built. The ice rack is made of galvanized steel bars, welded together and most common sense ice rack made. The shelves are of genuine steel wire, woven on a heavy steel wire frame and heavily tinned. They are finished in three coats of best quality of filler and waterproof varnish, giving them a gloss finish that looks well and that will wear. The inside construction is neat and sanitary, containing many features covered by patents. These add much to the convenience of the user.

### "Lapland Monitor" Refrigerators WHITE ENAMELED Selected Ash Lumber—Golden Oak Finish

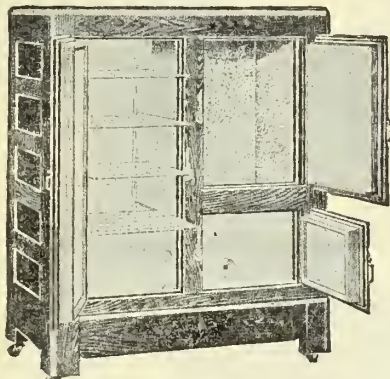

Nos. 101E and 103½E. Open.

No.	Ice Cap.	Sh.	Wt.	Wth.	Dpth.	Ht.
	lbs.	lbs.	in.	in.	in.	in.
101E	100	195	32	19½	45	
Ice Compartment.....	13¼	14½	18½			
Small Provision Comp.13¼	14¼	10				
Large Provision Comp.13¼	14¼	31				
List Price, \$57.40. Retail Price, \$40.25						
103½E	130	240	38	20½	51	
Ice Compartment.....	16	15¾	24½			
Small Provision Comp.16½	15¼	10½				
Large Provision Comp.16	15¼	37				
101E has three provision shelves only.						
List Price, \$70.25; Retail Price, \$49.25						

### The Ranney One Piece Porcelain Refrigerator Selected Ash Lumber—Golden Oak Finish.

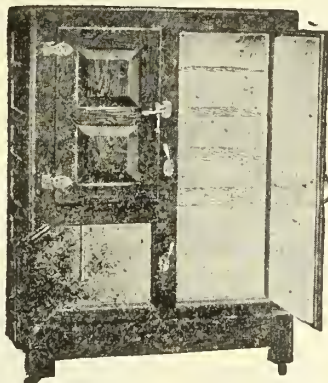

Nos. 1060, 1070 and 1080. Open.

No.	Ice Cap.	Sh.	Wt.	Wth.	Dpth.	Ht.
	lbs.	lbs.	in.	in.	in.	in.
1060	70	225	30¼	18	42½	
Ice Compartment.....	12¾	12¼	17½			
Small Provision Comp.13¼	12¾	8¾				
Large Provision Comp.12	12¾	27¾				
List Price, \$77.00. Retail Price, \$53.90						
1070	90	245	32½	19	45½	
Ice Compartment.....	13½	13	19			
Small Provision Comp.13½	12½	9½				
Large Provision Comp.13½	12½	30½				
List Price, \$88.00. Retail Price, \$61.60						
1080	115	265	34¼	20	48	
Ice Compartment.....	14½	14	20¼			
Large Provision Comp.14	14½	33¾				
List Price, \$96.80. Retail Price, \$67.75						

### "Radium" Refrigerators WHITE ENAMELED Selected Ash Lumber—Golden Oak Finish.

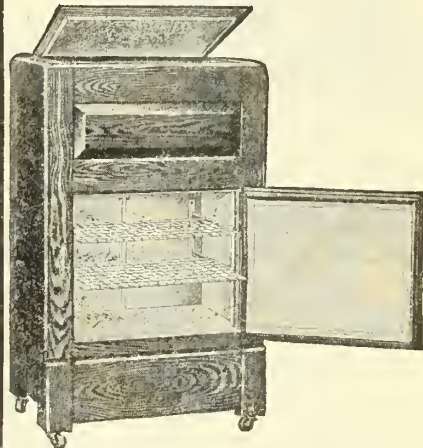

Nos. 705E to 709E. Open.

No.	Ice Cap.	Sh.	Wt.	Wth.	Dpth.	Ht.
	lbs.	lbs.	in.	in.	in.	in.
705E	75	155	25½	18½	43	
Ice Compartment.....	18¼	13½	10			
Provision Compartment.....	21	14	16½			
List Price, \$36.00. Retail Price, \$25.25						
709E	110	195	30¾	20	47	
Ice Compartment.....	22½	14½	11½			
Provision Compartment.....	25	15	19			
List Price, \$49.15. Retail Price, \$34.50						

### "The Ranney Porcelain" Refrigerators

Selected Ash Lumber—Golden Oak  
Finish.

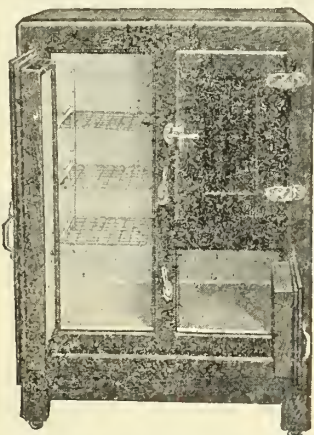

Nos. 1020 and 1035. Open.

No.	Ice Cap.	Sh.	Wt.	Wth.	Dpth.	Ht.
	lbs.	lbs.	in.	in.	in.	in.
1020	115	250	35	19½	46	
Ice Compartment.....	14½	14¼	20			
Small Provision Comp.14½	14	10				
Large Provision Comp.14½	14½	32				
List Price, \$80.55. Retail Price, \$56.50						
1035	130	275	38	20½	51	
Ice Compartment.....	15¾	15¼	24			
Small Provision Comp.16	15¼	10½				
Large Provision Comp.16	15¼	37				
List Price, \$94.00. Retail Price, \$65.75						

### Double Lid Ice Chests Selected Hardwood Lumber Mostly Ash Golden Oak Finish. Lined with Galvanized Iron.

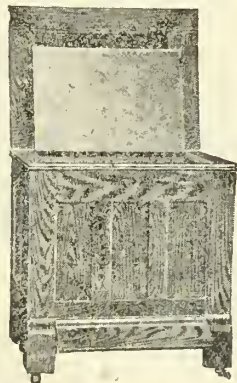

No.	Sh.	Wt.	Wth.	Dpth.	Ht.
	lbs.	in.	in.	in.	in.
770	75	23	17	24	
Inside Dimensions.....	20	14	13½		
List Price, \$14.25. Retail Price, \$10.00					
771	100	28¼	17¼	25¼	
Inside Dimensions.....	22½	11¾	12¾		
List Price, \$18.20. Retail Price, \$12.75					
774	125	27¾	20	30	
Inside Dimensions.....	22¼	14½	17¼		
List Price, \$24.00. Retail Price, \$16.80					
777	142	32¾	21	32	
Inside Dimensions.....	26¾	15½	20		
List Price, \$28.85. Retail Price, \$20.25					
No. 770 has single lid only.					

### Ashwood Refrigerators Selected Ash Lumber—Golden Oak Finish. White Enamel Lined

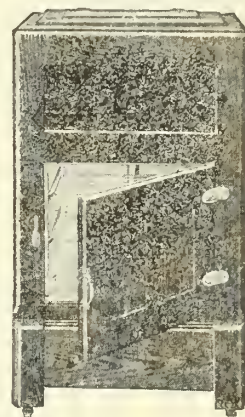

No.	Ice Cap.	Sh.	Wt.	Wth.	Dpth.	Ht.
	lbs.	lbs.	in.	in.	in.	in.
AE	30	92	19¼	14½	39	
Ice Compartment.....	14¾	11¼	9			
Provision Compartment.....	17½	11¼	14¼			
List Price, \$21.00. Retail Price, \$14.70						
BE	40	106	22½	14½	40¼	
Ice Compartment.....	16¼	10¼	10½			
Provision Compartment.....	18¼	11	14½			
List Price, \$25.40. Retail Price, \$17.80						
CE	50	122	23¾	15½	42	
Ice Compartment.....	17	10¾	10½			
Provision Compartment.....	19¼	11½	14½			
List Price, \$29.05. Retail Price, \$20.35						

## G. & T. BOILER AND FEED COOKER

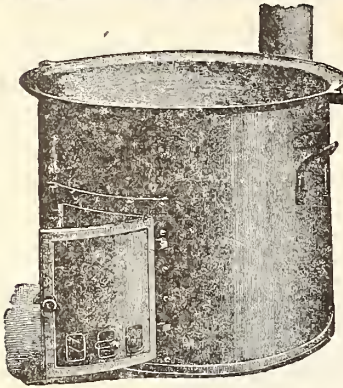

Heavy cold rolled steel furnace; extra large feed door; wrought iron handles, firmly riveted on. Kettles smooth, heavy cast iron. Door frame and flue collar cast iron. Never buckles or warps from heat; designed to set on ground or brick foundation; especially adapted for cooking feed, rendering lard, making soap, scalding hogs, poultry, etc. Cast iron flues are constructed inside, thus retaining heat and economizing fuel. We always ship furnace for wood fuel unless otherwise specified. Also used for lime and sulphur.

Usual Rating.	Actual Capacity.	Diameter of Furnace.	Shipping Weight.	Retail Price.
No. 3—or 1583	24 1/4 gallons.	26 inches.	160 pounds.	\$22.40
No. 4—or 1584	30 gallons.	28 1/2 inches.	190 pounds.	25.60
No. 5—or 1585	37 gallons.	29 1/2 inches.	200 pounds.	27.60
No. 6—or 1586	45 gallons.	31 1/2 inches.	258 pounds.	30.40
No. 7—or 1587	52 gallons.	32 inches.	280 pounds.	33.60
No. 8—or 1588	60 gallons.	34 inches.	325 pounds.	40.80
No. 9—or 1589	72 gallons.	36 inches.	385 pounds.	44.00

We always ship furnaces without firepot for coal unless otherwise specified. For wood fuel no firepot or grate is required, but for coal it is necessary to use firepot.

**FIREPOT, Retail Price, \$8.00**

Actual Capacity.	Furnaces Only.	Kettles Only.
No. 3—24 1/4 gallons.	<b>Price, \$11.00</b>	<b>Price, \$12.00</b>
No. 4—30 gallons.	<b>12.00</b>	<b>14.50</b>
No. 5—37 gallons.	<b>13.00</b>	<b>17.50</b>
No. 6—45 gallons.	<b>14.00</b>	<b>19.00</b>
No. 7—52 gallons.	<b>15.00</b>	<b>21.50</b>
No. 8—60 gallons.	<b>16.75</b>	<b>24.00</b>
No. 9—72 gallons.	<b>17.50</b>	<b>27.00</b>

### STEEL HOG SCALDER AND COOKER

It takes the lead of anything on the market. When not used for scalding, can be used for feed cooker, boiling spray material, or for dipping sheep, can also be used for watering stock.

This outfit will save half of the time, and most of the hard labor in connection with Hog Killing, and will pay for itself in a very short time.

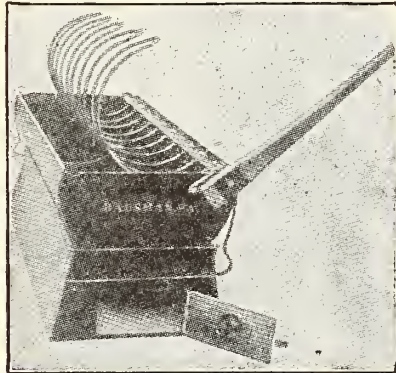

Plain Scalder does very well if placed over a ditch and fire built underneath, but most farmers prefer rack and fire-box complete. Shipping weight, 425 lbs.

Plain Scalder, with legs, 6 ft. x 30 in. x 18 in. deep. **Our Special Price, \$27.00.**

Fire-box with 5-inch pipe hole. **Our Special Price, \$15.00**

Dumping Rack with lever. **Our Special Price, \$15.00**

Scalder complete. **Our Special Price, \$55.00.**

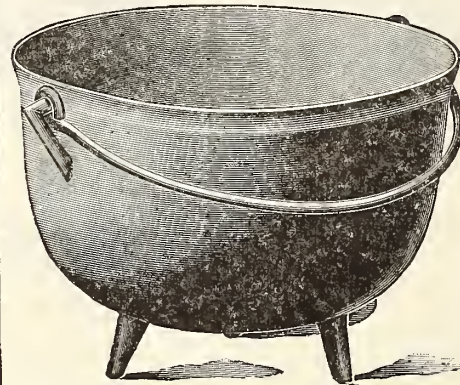

### IRON KETTLES

Capacity
No. 4... 15 gals.
No. 5... 20 gals.
No. 6... 25 gals.
No. 7... 30 gals.

Our Special Price.
No. 4.....\$ 6.75
No. 5..... 7.50
No. 6..... 9.00
No. 7..... 10.50

### IMPROVED KETTLE RANGE

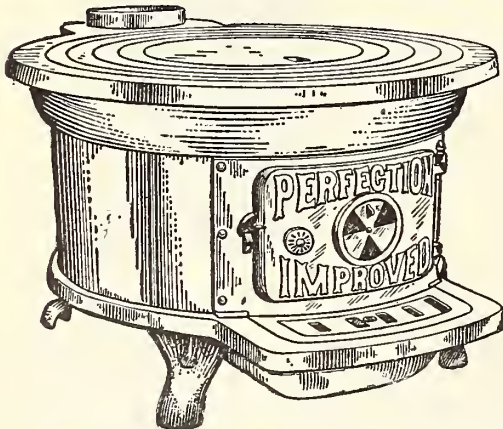

This Kettle Range is made to accommodate any kettle a farmer may happen to have. Any copper or iron kettle up to 40-gallon capacity can be used.

The largest opening, when all the rings are off, is 25 inches, and the smallest is 12 inches.

The outside of the fire-box is made of heavy steel plates and lined inside with cast-

iron firebacks on all sides. The size of the firebox is 12 inches wide and 24 inches long and supplied with grate and ash pit, and has ash pan so that ashes can be removed without use of shovel. Pipe opening for 6-inch pipe. Weight, 200 lbs. **Our Special Price, \$35.00.** Lighter and cheaper Range with pot hole top and one ring, \$30.00.

### "Cymaco" Dry Mash Feeders

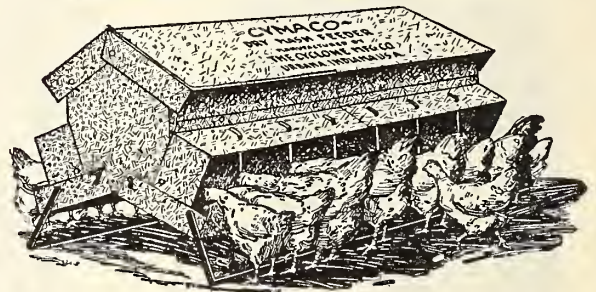

#### SOLVE THE FEEDING PROBLEM

The feeder that has won the highest favor among thousands of poultry men and farmers throughout the country. The **CYMACO** feeder is made of the best galvanized steel with enamelled steel legs to hold the feeder off the ground. The flow of the feed may be regulated by means of two thumb screws at either end of the feeder. Agitators are worked automatically by the fowls while feeding. The **CYMACO** accommodates twice as many hens as the ordinary hopper feeder. **CYMACO** is provided with a catch tray which prevents waste of feed and provides a means to close at night.

No.	Capacity	Shipping Weight	Each
12	1/2 bu.	11 lbs.	\$2.25
24	1 bu.	17 lbs.	3.50

**ALL PRICES IN CATALOG SUBJECT TO CHANGE WITHOUT NOTICE.**

## THE NEW SHARPLES Suction Feed Tubular Cream Separator

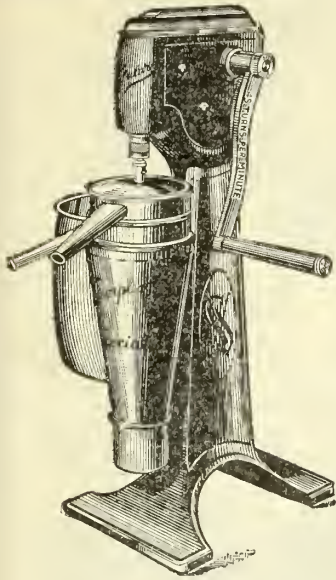

When you buy a cream separator you naturally want the best—the separator that will net you the greatest dollar for dollar returns on your investment. The **SHARPLES** guarantees greater returns than any other. It is the only cream separator in the world guaranteeing a clean skim at any speed and delivering a cream of the same density all the time. That means a far greater saving of butterfat (money) for you.

Moreover, the **SHARPLES** is the easiest to clean, to operate, and is the most reliable.

The famous Sharples Tubular Bowl has only **one** piece in it—no 30 or 40 discs as you find in others; the supply tank is only knee high from the floor and you don't have to strain your back to pour in the milk. For your wife and your family it means less work and greater convenience, and for you it means the **best** separator investment you can make.

Sizes	Capacity	Shipping Weight	Prices
1S	225 lbs. per hour	190	\$65.00
2S	300 lbs. per hour	190	75.00
3S	400 lbs. per hour	190	85.00
4S	500 lbs. per hour	260	95.00
6S	700 lbs. per hour	260	110.00
9S	900 lbs. per hour	260	135.00

### G. T. CO'S PERFECTION SEPARATOR OIL

This Oil is put up expressly for the use of separators, and we recommend it to users of all hand machines, it being a light oil and having a very low cold test.

1-quart can.....	\$0.50
½-gallon can.....	.75
1-gallon can.....	1.25
5-gallon can.....	5.00

### THE BOSS CREAM SEPARATOR

The **Boss Cream Separator** consists of a water vessel containing one or more milk vessels fastened together with our Patent Can Attachment.

The **Water Vessel** is made of the very best quality of 26 gauge galvanized iron, and is provided with a large water faucet at the bottom and overflow pipe at the top.

The **Milk Vessel** is made of the best grade 3XXX 4AAAA Charcoal Tin Plate. It is oblong and deep with a sloping bottom, milk and cream will drain off rapidly. All seams are carefully soldered both on the inside and outside, and there is no chance whatever for milk to lodge and sour. All milk vessels are coated with Aluminum which is the best rust preventative known.



No.	Height	Width	Weight	
No. 1—2½ gal. milk vessel..	18 in.	13 in.	14 lb.	\$ 7.20
No. 2—4 gal. milk vessel..	20 in.	15 in.	17 lb.	8.00
No. 3—6 gal. milk vessel..	22 in.	17 in.	20 lb.	8.80
No. 4—8 gal. milk vessel..	24 in.	18 in.	22 lb.	9.60
No. 5—10 gal. milk vessel..	28 in.	18 in.	24 lb.	10.80

### THE TWIN BOSS

The **Twin Boss** is especially adapted for farmers and dairy-men who get more than 10 gallons of milk at a milking. A milk vessel that holds more than 10 gallons is hard to handle and will not produce as good results as smaller ones.

We would also recommend **The Twin Boss** to those who prefer a Separator with two milk vessels, so that one can be used in the morning and the other in the evening. This method has many advantages over the Separator with the single milk vessel.

No.	Height	Length	Width	Weight	
22 two 2½ gal. milk vessels	18 in.	24 in.	13 in.	27 lbs.	\$14.40
24 two 4 gal. milk vessels	20 in.	30 in.	15 in.	33 lbs.	16.00
26 two 6 gal. milk vessels	22 in.	30 in.	17 in.	38 lbs.	17.60
28 two 8 gal. milk vessels	24 in.	30 in.	18 in.	41 lbs.	19.20
210 two 10 gal. milk vessels	28 in.	30 in.	18 in.	46 lbs.	21.60

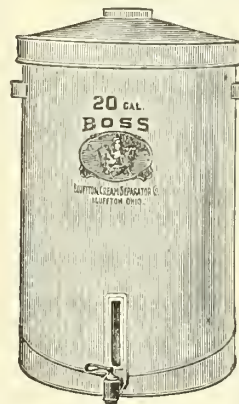

### THE BOSS

**VENTILATING AND AERATING CREAM SEPARATOR**

In the **Boss** Dilutors or Water Mixers the milk and water is mixed together or, in other words, the water is poured right into the milk so as to chill it instantly and cause the cream to raise in about one hour.

In ordering a separator of this kind, be sure and order one that will hold twice the amount of milk that you wish to put into it, so as to make allowance for water.

No.—Sizes	Prices
6—8 gal., holds 4 gals. milk..	\$4.80
7—12 gal., holds 6 gals. milk..	5.60
8—16 gal., holds 8 gals. milk..	6.40
9—20 gal., holds 10 gals. milk..	7.20
10—24 gal., holds 12 gals. milk..	8.00

### THE TRIPLE BOSS

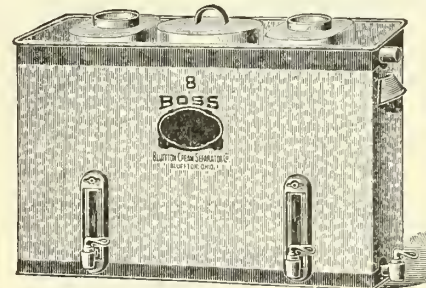

Too much can hardly be said in favor of the **Triple Boss**. It is fast getting to be our best seller and from all indications is the machine of the future. With two milk vessels, one for the morning's and one for the evening's milk, a cream can to keep the cream in the best condition for making first-class butter and room enough

back of the cream can to set another vessel, in which to keep the butter during hot weather, it is certainly all that one can desire in the line of a Cream Separator.

No.	Gallon	Gallon	Ht in.	L'g't in.	W'th in.	Wt lbs.
32 two 2½ milk can, 2½ cream can, 18	24	13	30	\$16.00		
34 two 4 milk can, 3 cream can, 20	30	15	37	17.60		
36 two 6 milk can, 3 cream can, 22	30	17	42	19.20		
38 two 8 milk can, 4 cream can, 24	30	18	45	20.80		
310 two 10 milk can, 4 cream can, 28	30	18	50	24.00		

## MINNETONNA HOME CREAMERY

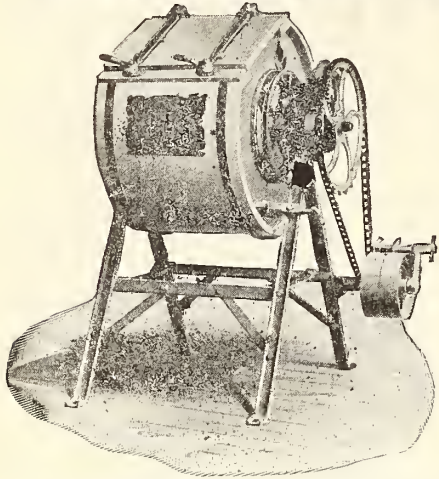

**CHURNS  
THE BUTTER  
AND  
WORKS IT.**

The Minnetonna process of churning is the most efficient method of agitating the cream during churning yet discovered. It works on the same principle that is used in some of the most modern and approved big creamery churns.

Style No. 1-H hand-power plant; churning capacity, 12 to 15 gallons; working capacity, up to 25 pounds butter.

The style No. 1-H is a very good size for dairy farmers wanting to make butter once or twice a week by hand, and having from five to fifteen cows.

No. 1 H. P. Minnetonna Home Creamery; hand and power. Churning capacity, with barrel half full, 12 gallons. Working capacity, 3 to 20 pounds. Can be belted to your gasoline engine. Pulley, 8 x 2 1/4 inches. Speed, 200 R. P. M. Floor space required, 2 ft. 8 in. x 2 ft. 7 in. Shipping weight, 210 pounds.

### IT WORKS THE BUTTER PROPERLY AND QUICKLY

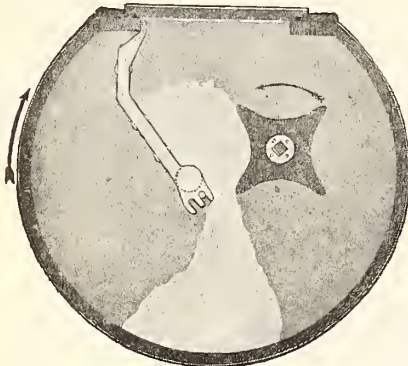

Cross section view of Minnetonna Home Creamery, showing how the butter is worked between two rolls.

Here is another feature wherein the Minnetonna is way ahead of the old-fashioned farm churn. The working is done in the barrel after the churning and washing are finished. The butter-fat particles are all gathered together and thoroughly worked between the main roll in the center of the barrel and the small idle roll at the end of the basket. The main roll revolves when the working gear is thrown into place. The whole job is done with a few revolutions of the barrel.

	Factory Number	Churning Capacity With Drum Half Full	Butter Working Capacity	Shipping Weight	Style	Price
Minnetonna Home Creamery	No. OMB 1 H.	12 Gallons	3 to 20 lbs	195 lbs.	Hand Operated	\$60.00
	No. OMB 1 H. P.	12 Gallons	3 to 20 lbs	210 lbs.	Hand and Power	\$70.00
	No. OMB 2 H. P.	20 Gallons	5 to 40 lbs	250 lbs.	Hand and Power	\$75.00

## CEDAR CYLINDER CHURN

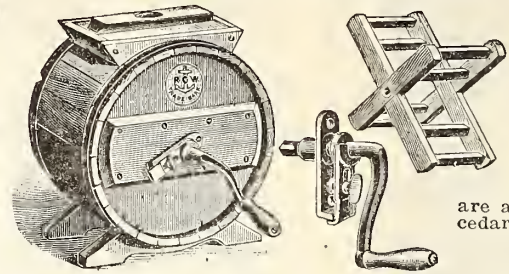

There are a number of Cylinder Churns on the market sold at a lower price, but they are made of pine or other inferior wood, while these are all of selected cedar, free of knots.

No. 1—2 3/4 gallons... \$4.40  
 No. 2—4 gallons... 5.20  
 No. 3—7 gallons... \$6.10  
 No. 4—10 1/2 gallons... 6.95

## Baltimore Favorite Churn

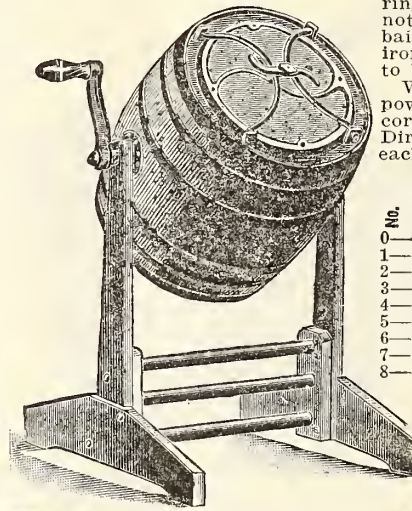

It is made of thoroughly seasoned material. It is finished smooth inside as well as outside. The iron ring head is strong and not liable to break. The bails are fastened to the iron ring, where they need to be fastened.

We furnish pulleys for power. Prices extra, according to size desired. Directions for using in each Churn.

No.	Capacity, Gallons	To Churn, Gallons	List Price	Retail Price
0	1	3	\$11.20	\$ 7.00
1	10	5	12.50	7.85
2	15	7	14.00	8.70
3	20	10	15.40	9.60
4	25	12	19.60	12.25
5	35	17	22.30	14.00
6	60	30	36.30	22.75
7	75	37	52.80	33.00
8	90	45	61.60	38.50

12-inch Single Pulleys with Trunions for above. List, \$6.00. Retail, \$3.75. Pulley only. List Price, \$4.00. Retail, \$2.50. Trunion only. List, \$2.00. Retail, \$1.25.

## DAVIS SWING CHURN

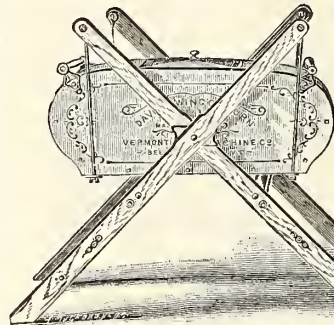

The round ends of the Churn cause the cream as it strikes against them to slide up and over, turning a complete somersault.

Each Churn has a glass indicator in the cover.

No.	To Churn, Gallons	Capacity, Gallons	Weight, Pounds	Price
1	4	8	55	\$15.40
2	5	10	59	16.10
3	8	16	73	17.50

Additional for Pulley 12x3, with attachments, \$9.25.  
 Additional for Tight and Loose Pulley, 12x3, with attachments, \$13.00.

## ASEPTIC MILKING TUBES

**FOR COWS WITH SORE TEATS.**  
 Insert one in the teat and the milk will flow.



Plain Tube, 25c.



Self Retaining Tube, 25c.

## CHAMPION AUTOMATIC MILK COOLER-AERATOR

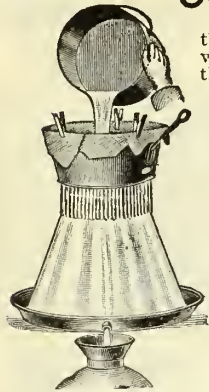

**To Operate**—Set as low as possible where there is plenty of pure, fresh air; if the wind blows, the better. It can be used in the strongest wind without a drop being blown away. Use very cold water. Use a cloth or metal strainer over the top of milk receiver.

No.	Capacity of Milk Receiver	Size of Dairy.
2.....	18 quarts	10 to 25 cows
3.....	34 quarts	25 to 50 cows
4.....	52 quarts	50 to 100 cows

No.	Takes Care of	Our Special Price.
2.....	3 milkers	\$ 9.25
3.....	5 milkers	11.00
4.....	8 milkers	13.75

## The "FROST KING" Steel Frame Single Motion Freezer

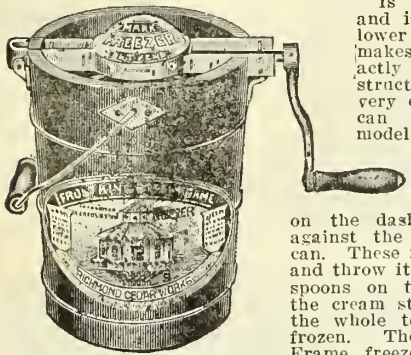

Is a single-motion freezer, and is accordingly sold at a lower price than our other makes. It is, however, of exactly the same high-grade construction. The mechanism is very easy to operate, and the can being of the narrow model type makes the freezing very rapid. The operation of this freezer is extremely simple.

The wood scrapers on the dasher press automatically against the sides of the revolving can. These remove the frozen cream and throw it to the centre where the spoons on the beater mix it with the cream still unfrozen and return the whole to the sides to be refrozen. The "Frost King" Steel Frame freezer will produce a rich and evenly frozen ice-cream in about three minutes.

Sizes	2-qt.	3-qt.	4-qt.	6-qt.	8-qt.
Retail Prices.....	\$2.80	\$3.35	\$4.10	\$5.20	\$6.90

## "SNOW BALL" FREEZER

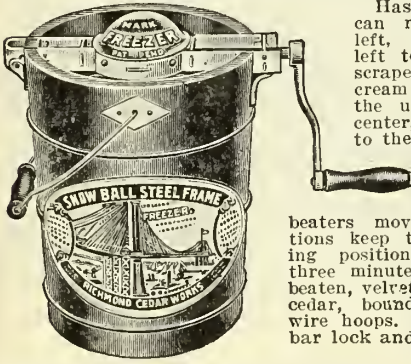

Has three motions. The can revolves from right to left, the outer beater from left to right, the two wood scrapers removing the frozen cream from the sides with the unfrozen cream in the center, and throws all back to the side to be again frozen and removed by the scrapers. The continuous action of the can and two

beaters moving in opposite directions keep the cream ever changing position, producing in about three minutes a very smooth, well-beaten, velvety cream. Virginia white cedar, bound with electric welded wire hoops. Fitted with new cross bar lock and reinforced cross bar.

Sizes	2-qt.	3-qt.	4-qt.	6-qt.	8-qt.
Retail Prices.....	\$3.40	\$4.05	\$5.00	\$6.30	\$8.10

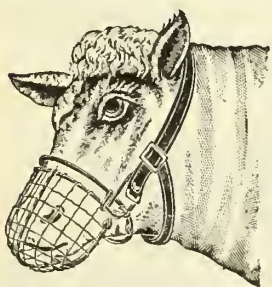

## SHAW'S CALF WEANERS

The **SHAW'S CALF WEANER** is thoroughly practical. The action is entirely in the basket, it being hinged to the end of the nose piece. The basket is made of heavy galvanized wire, with extra bars running through. The halter that goes over the neck is made of solid leather, and can be adjusted to suit the calf's head.

Prices: No. 1, 50c. No. 2, 65c. No. 3, 80c.

## Reid Corrugated Milk Cooler

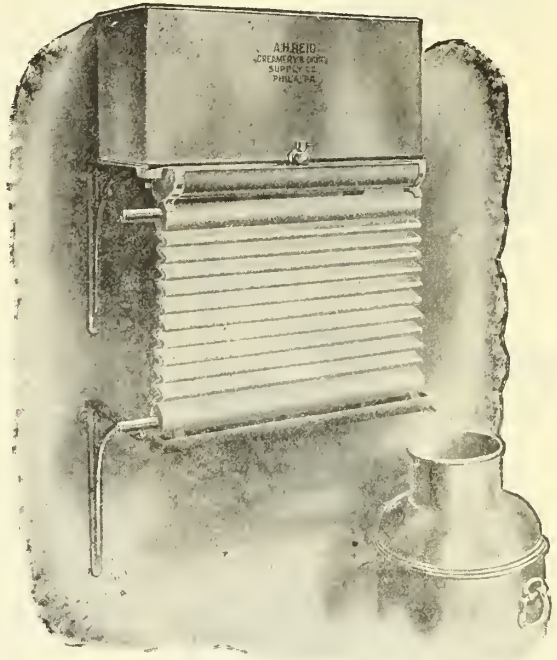

The Reid Corrugated Cooler is made of non-rusting or corroding material. The corrugations or cooling surface are of heavy tinned copper. The heads are made of castings of solid manganese bronze, which is the strongest tin and copper alloy made. The sheets are sweated to the heads and the inlet and outlet are made of seamless tinned brass tubing. The top and bottom troughs are made of tinned copper. The ends are of tinned brass. There is absolutely nothing about the body of the cooler to rust or wear out.

The standard reservoir is made of tinned steel with a sanitary removable plug faucet. If desired, a tinned copper reservoir can be furnished.

No.	Cooling capacity in gals. per hr.	of body	Capacity of reservoir	Price
No. 1.....	45	12 in.	5 1/2 gals.	\$31.50
No. 2.....	55	15 in.	8 gals.	35.00
No. 3.....	65	18 in.	9 gals.	38.00
No. 4.....	80	21 in.	11 gals.	43.00

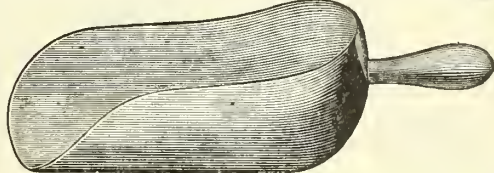

## Aluminum Scoops

Made of pure aluminum, cast in one piece, Light and convenient—Absolutely indestructible. Our Special Price.

No. 1—Size, 4x11 inches, each.....	\$1.50
No. 2—Size, 5x12 inches, each.....	2.00
No. 3—Size, 5 1/2 x14 inches, each.....	2.50
Per Set.....	6.00



## RICE'S CALF WEANERS

ALSO PREVENTS COWS FROM SUCKING THEMSELVES.

No. 1—For Calves. Retail Price.....	\$ 50
No. 2—For Heifers. Retail Price.....	.75
No. 3—For Cows. Retail Price.....	1.00

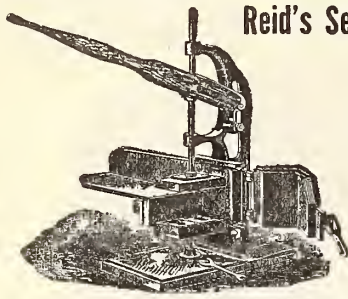

## Reid's Self-Gauging Butter Printer

Prints butter very neatly and quickly. Weighs into pounds or half pounds as desired. Does it in one-quarter the time it can be done by hand, making prints of uniform weight. Moulds are square.  
 Both pound and half pound combined... **\$20.00**  
 Either pound or half pound..... **15.00**  
 Extra for initials and monograms..... **1.50**

## LAFAYETTE BUTTER PRINTER

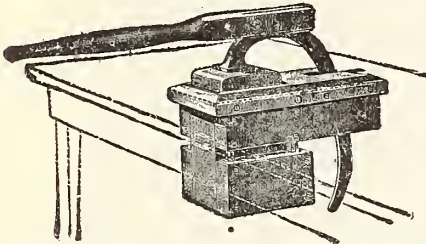

This is also self-gauging. Intended for use in creameries, but more especially for reprinting. Very simple and handy.

Either pound or half pound, with table, **\$33.00**.  
 Either pound or half pound, without table, **\$16.00**.  
 Extra for initial or monogram, **\$1.50**

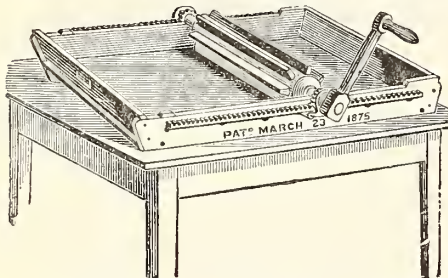

## Reid's Butter Worker

No. Measurement	Capacity, Pounds.	Weight, Pounds.	Retail Price.
4—14x24x2½ in.	10	20	<b>\$12.00</b>
3—17x27x2½ in.	20	25	<b>14.00</b>
2—20x36x2½ in.	30	29	<b>16.50</b>
1—23x36x2½ in.	50	45	<b>19.00</b>

Large size, especially designed for mixing, reworking and coloring, or creamery use.

No. Measurement	Capacity, Pounds.	Weight, Pounds.	Retail Price.
0—23x37x3 in.	75	60	<b>\$27.00</b>
00—23x56x3 in.	112	80	<b>30.60</b>
000—23x72x3 in.	150	100	<b>39.60</b>

When desired, we can send legs along with any size machine for **\$5.00** extra, which can be set up after arrival at destination.

## POLISHED MAPLE BOWLS

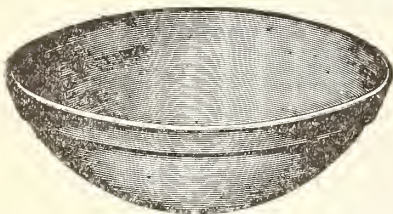

Made from Hard Maple turned from a solid block. Every Bowl is first quality, smoothly finished and polished.

Bowls, 15 in... **\$1.00**  
 Bowls, 17 in... **1.75**  
 Bowls, 19 in... **2.40**

## SPECIAL CARVED DESIGNS

The prices given below are for special carved blocks, pound or half pound, for any of the above printers.  
 Plain Block, no carving..... **\$ .50**  
 Plain Sheaf Blocks, chain border..... **1.00**  
 Initial on block, up to five letters..... **1.50**  
 Blocks with more than five letters, **\$1.50**, with an additional charge of 10 cents for each letter over five.  
 For Lafayette Printers, add price of plate..... **.25**

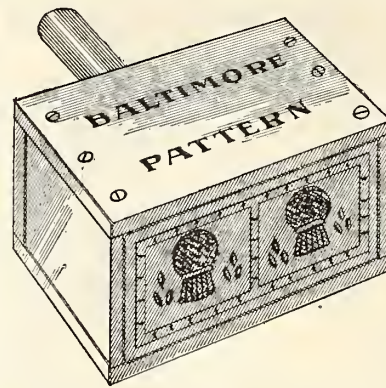

## Baltimore Pattern Hand-made Butter Mould

This Butter Print is hand-made out of solid hardwood, and is put together with brass screws, making it indestructible. Being a two-piece print makes it very handy to use. ½ lb. Sheaf of Wheat Print, **\$1.25**; 1 lb. Sheaf of Wheat Print **\$1.50**. ½ lb. Special Print, Carved with Initial, **\$2.50**; 1 lb. Special Print, Carved with Initial, **\$2.75**.

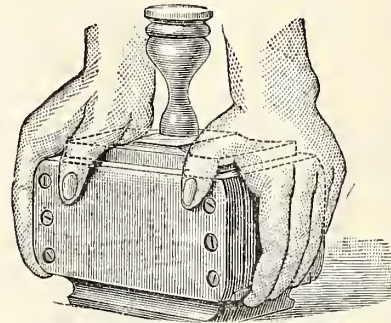

## EXTRA HEAVY BRICK BUTTER MOULD

Philadelphia Pattern, ½ pound, **\$2.00**  
 Philadelphia Pattern, 1 pound... **2.00**

Can furnish moulds to order with initials cut at an extra cost of **\$1.50**.

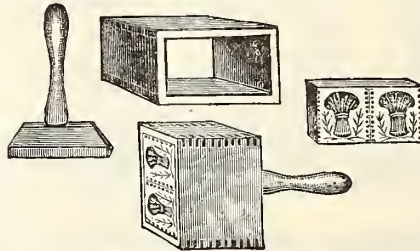

## BUTTER MOULD

SEELEY PATTERN.

Furnished with sheaf of wheat. Movable block.  
 ½ pound..... **65c**.  
 1 pound..... **85c**.

## ECONOMY BUTTER PRINTER

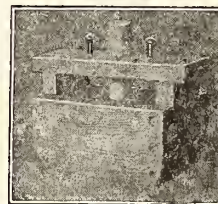

The Economy Printer is one of the most popular hand printers. It is of wood put together with brass screws, and has brass gauge screws at the top, making it self-gauging. With it butter may be printed very rapidly. Cutting the butter from the churn batch on the table, pressing the hopper full, leaving contents of hopper in a neatly formed block of butter which is pressed from the printer by pressure on the wood stem of block extending through the printer head block.

½ lb., complete, with sheaf of wheat block..... **\$2.25**  
 1 lb., complete, with sheaf of wheat block..... **2.25**

## LADLES AND SPADE

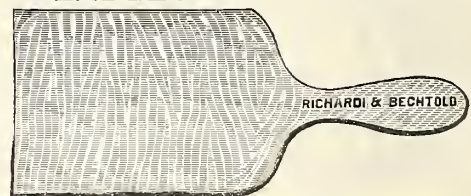

4x12 Butter Spade..... **15c**. No. 1 Butter Ladle..... **25c**.

## BUTTER BOXES

These boxes are iron bound at the edges and capped at the corners. An ice box is fitted in the center, which can be removed at will and the space utilized.

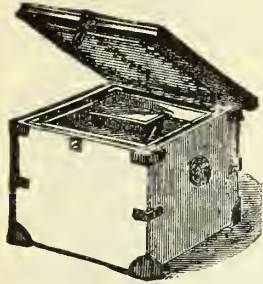

Capacity	Price.
36 1/2-pound prints.....	\$15.75
64 1/2-pound prints.....	18.00
80 1/2-pound prints.....	19.00
100 1/2-pound prints.....	23.75
120 1/2-pound prints.....	27.25
140 1/2-pound prints.....	30.10
20-pound prints.....	14.10
30-pound prints.....	16.20
40-pound prints.....	20.25
56-pound prints.....	24.30
80-pound prints.....	27.00
96-pound prints.....	29.25
120-pound prints.....	33.25

## PELOUZE DAIRY SCALE

**Graduated by Tenths of a Pound.  
GUARANTEED ACCURATE.**

Made to comply with Departments of Weights and Measures. Large Circular Brass Dial, with distinct, black figures and graduations.

Two indicator hands—one red, to be set at the weight of empty pail.

Very attractive and durable.

“PELOUZE” DAIRY SCALE.

No. D 40—Capacity, 40 lbs.....	\$4.75
No. D 60—Capacity, 60 lbs.....	5.00

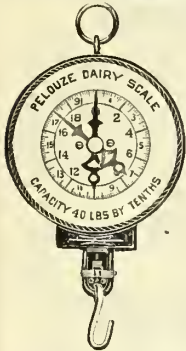

## MILK BOTTLE BASKET

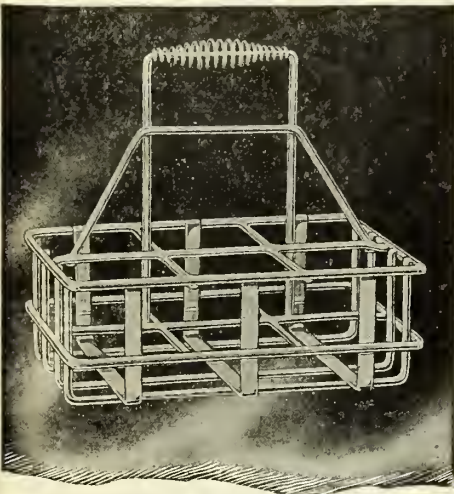

These baskets are made from the best grade of flat and round steel wire. The welded joints make them the same as one piece, hence, all strain and shocks are distributed over the entire body.

No rivets being used in its construction, there is no part to get loose and at the same time is not weakened by rivet holes.

It has no crevices in which dirt can collect consequently it is easy to clean and sterilize.

6 bottles, \$1.75  
8 bottles, 2.00

## DOMINION DAIRY AND HOUSEHOLD CLEANSER

An improved cleanser and purifier for all dairy and household purposes. Just the thing for Churns, Pails and anything used in dairies. For household use, laundry work, all kitchen use, house-cleaning, public buildings, hotels and factories.

Dissolves with greatest ease in either hot or cold water, and rinses off perfectly clean without leaving a soapy scum. Price: 5-lb. bag, 35c.; 25-lb. bag, \$1.50.



## MILK BOTTLES



These bottles are made by a factory devoted especially to bottle making. The glass is clear flint. This makes a bottle that the milk shows up to the best advantage. They are made to stand the rough usage of the street delivery and collection on routes, and washing and sterilizing in the dairy house. These bottles are made with a long neck, and will show a deep cream line. Prices named are for bottles F. O. B. Baltimore.

If you desire name plates, same can be put on any order of five gross or more of one size, at an additional cost of \$2.50 for each name plate. Each size bottle will require a different plate. On second orders, there will not be any extra charge for lettering.

	Quart.	Pint.	1/2 Pint.	1/4 Pint.
One dozen.....	\$ 1.10	\$ .80	\$ .70	\$ .70
One gross.....	10.50	8.00	6.50	6.50
Two gross and over.....	10.45	7.95	6.45	6.45
Five gross and over.....	10.40	7.90	6.40	6.40
Fifteen gross and over.....	10.35	7.85	6.35	6.35

WRITE FOR CARLOAD PRICES.

## MILK BOTTLE CAPS



The great convenience of this cap will be appreciated, as it is made with a lift to take the cap out. This prevents spilling the milk, or having to use anything to pry it out.

These caps are made from 40-point thick board, and are thoroughly waterproofed with paraffine.

One thousand.....	\$ .70
Five thousand.....	3.25
Twenty-five thousand.....	16.25

LARGER QUANTITIES—PRICE ON APPLICATION.

## PARCHMENT BUTTER PAPER

It can be used in all cases where wax paper, tin foil or muslin has been adopted, and in many cases where these cannot, for preserving goods from the effects of moisture, etc. In sheets 24x36, or can furnish the paper cut in the following sizes without extra charge: 6x9 for half pounds, 9x12 for one pounds, and 10x15 for two pounds. Price, 30c. per pound; by mail, 40c.; 6 pounds, \$1.75.

## DAIRY SALT

25-pound sacks.....	\$ .75
50-pound sacks.....	1.20
100-pound sacks.....	2.00



## NEW YORK Pattern Milk Cans

Furnished with our new Umbrella Cover, with seamless rim welded to top. The malleable iron handle is so curved that it does not strike the body of the can, and is practically noiseless.

20-quart .....	\$4.60
30-quart .....	5.50
40-quart .....	5.80

Special Prices in Quantities.

Our charge for marking name on can will be 40 cents each. Permit Plate 15c.

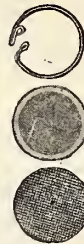

## Milk Strainers

**NEW SANITARY STRAINER**  
With Reovable Strainers .....\$2.00  
**REGULAR STRAINERS**

These milk strainers are made of extra heavy tin and brass wire cloth. They are warranted not to rust.  
Prices.

3-quart .....	\$1.10
6-quart .....	1.35
10-quart .....	1.85

## Iowa Pattern Milk Cans

IOWA PATTERN HEAVY MILK CAN.

20-quart .....	\$3.45
32-quart .....	4.10
40-quart .....	4.25

Special Prices in Quantities.

Our charge for marking name on can will be 40 cents each. Permit Plate 15c.



## Sanitary Fish Mouth Dairy Pail

Approved and recommended by State Dairy Inspectors. Used exclusively by many large and practical Dairymen. Made from finest charcoal plate. One piece retinned top or hood. Steel Bail. Reinforced Ears. All seams sanitary soldered inside and out.

**PLATE. IXX. HEAVY CHARCOAL**  
12-quart .....

12-quart .....	\$1.80
14-quart .....	1.90

## Milk Cans or Kettles

Finest charcoal plate. Seamless cover and neck. Bottom reinforced with steel band. Heavy steel bail. Sanitary soldered. Full capacity.

2-quart .....	\$ .95
4-quart .....	1.10
6-quart .....	1.35
8-quart .....	1.60
10-quart .....	1.85
12-quart .....	2.00
16-quart .....	2.25
20-quart .....	2.50



## Dairy Strainer Pail



Coppered Ball. Natural finish ball wood. Reinforced ears Handle near bottom to use when pouring from pail.

**IXX. CHARCOAL PLATE**  
14-quart .....

14-quart .....	\$1.60
----------------	--------

## Milk Pail

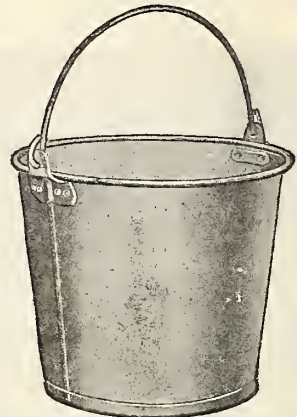

**BEST IXX BLOCK TIN.**

12-quart .....	.80c.
14-quart .....	.90c.

**LIGHTER PAILS.**

12-quart .....	.60c.
14-quart .....	.65c.

**HEAVY GALV. PAIL.**

12-quart .....	.85c.
14-quart .....	.95c.

**LIGHT GALV. PAIL.**

12-quart .....	.50c.
14-quart .....	.55c.



## CREAM PAILS

These pails are made from 5A Charcoal plate, Mirror Finish, are very strong and durable.

We furnish them in two sizes, with or without Gauge or Faucets and with outside lids.

14 Qt. Without Gauge and Faucet .....

20 Qt. Without Gauge and Faucet .....

14 Qt. With Gauge and Faucet .....

20 Qt. With Gauge and Faucet .....

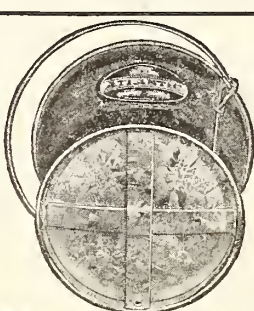

## Wooden Stable Bucket

J. I. C. Cedar—Heavy iron-bound stable bucket. Each, \$1.50

## Double Bottom Cement Pail

Heavy reinforced Galvanized Cement Pail.....\$1.75

## WELL BUCKETS

Crown, \$1.00.



## Well Bucket Pulleys

10 in. ....	\$ .90
12 in. ....	1.00



## GALVANIZED STEEL BASKETS

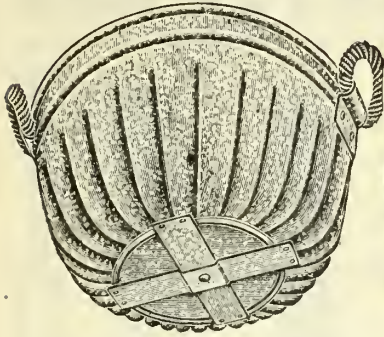

With Reinforced or Double Steel Bottoms.  
Bushel—A 101—  
Each .....\$2.25



### UTILITY STEEL BASKETS GALVANIZED.

With Bale or Side Handles, ½ Bushel, \$1.00; 1 Bushel, \$1.25; 1½ Bushels, \$2.00.

### OAK BASKETS.

1-Bushel Oak Basket (round splint).....\$2.00

### BAMBOO AND OAK BASKETS.

1 Bushel (iron bound).....\$1.50  
1½ Bushels (iron bound).....1.75  
2 Bushels (iron bound).....2.00

### FLAT OAK SPLINT BASKETS.

1 Bushel (iron bound).....\$1.00  
1½ Bushels (iron bound).....1.50  
2 Bushels (iron bound).....1.75

## DUST PROOF COAL ASH SIFTER

This Ash Sifter saves coal and is dust-proof. It is made from extra heavy galvanized sheets heavily wired and braced and equipped with a cover at top which prevents the dust from escaping. The revolving cylinder is made from extra heavy galvanized wire mesh, operated by handle or crank equipped with wooden grip. The lip at the end of sifter allows the coal to drop directly into the hod. A strong hook holds the hod securely in place.

PRICE.....\$3.50. ....

## CHERRY SEEDERS

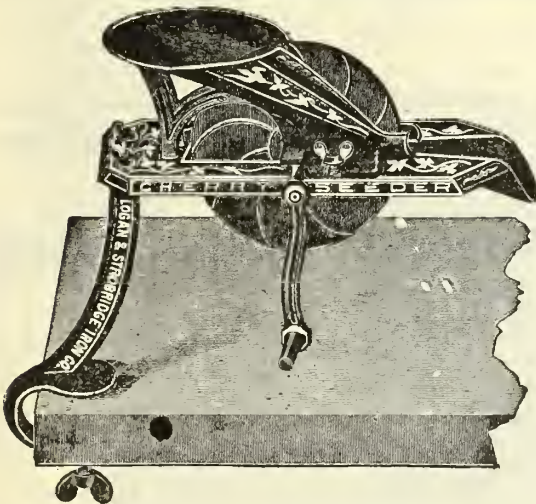

These cherry seeders are so constructed that they can be adjusted for different size cherries. They work very rapidly and do not tear up the fruit.

The No. 2 Seeder is made as shown in the illustration. The No. 1 Seeder has four legs which screw to the table.

PRICE No. 1.....\$1.00  
PRICE No. 2.....1.00

ALL PRICES IN CATALOG SUBJECT TO CHANGE WITHOUT NOTICE.

## CEDAR AND OAK MEASURES

Each.  
¼ -Peck, wire hoops .....\$ .80  
¼ -Peck, flat hoops ..... .60  
Peck & ½ -Peck comb, wire hoops. 1.20  
Peck & ½ -Peck, flat hoops..... .90  
½ -Bushel, wire hoops ..... 1.60  
½ -Bushel, flat hoops ..... 1.20

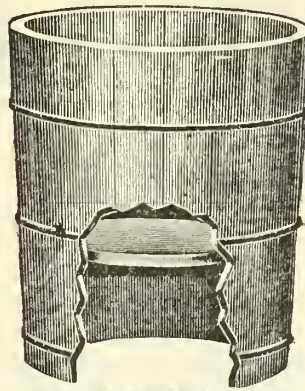

## WITT ASH CANS



## GARBAGE CANS



No.	Cap.	Price
8004	5¼ Gallons	\$1.30
8005	6¼ Gallons	1.50
6812	8¾ Gallons	1.65
6815	10¾ Gallons	1.80
LIGHTER CANS		
00	5¼ Gallons	1.05
No. 10 With Side Handles..	2.70	02
No. 9 With Side Handles..	4.30	03
No. 2 With Side Handles..	5.00	04
No. 8 With Bale Handles..	2.05	
No. 9 With Bale Handles..	2.25	
No. 9½ With Bale Handles	2.50	

## THE EAGLE SLAW CUTTER



Slaw Cutter and Vegetable Slicer is the speediest, handiest and most serviceable cutter on the market for cutting Slaw, Kraut, Noodles, Cucumbers, Potatoes, Onions, Parsnips, Pie Plant, Beets, Bananas, Turnips, Vegetable Oysters, String Beans, Pineapples, Saratoga Chips, Etc.

The cleanest, quickest and nicest way to prepare fruits and vegetables that require cutting is to use an "Eagle" Slaw Cutter and Vegetable Slicer.

PRICE.....\$3.00

## 1898 TURN-TABLE APPLE PARER

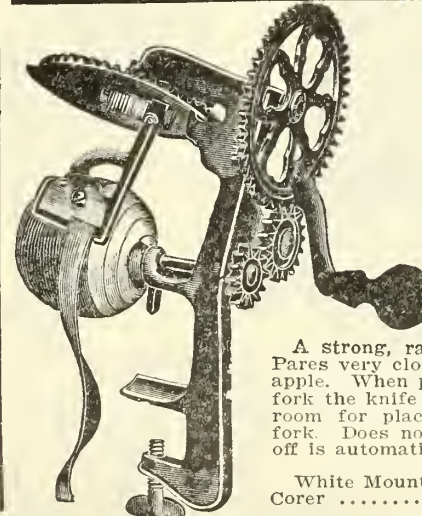

A strong, rapid, durable machine. Pares very close at both ends of the apple. When passing the end of the fork the knife recedes leaving ample room for placing the apple on the fork. Does not core or slice. Push-off is automatic. Price, each, \$1.25.

White Mountain Parer and Corer .....\$1.00

**MILK TESTERS AND GLASSWARE**

**WAGNER PRECISION BABCOCK GLASSWARE**

For testing milk and its products, in accordance with specifications formulated by the Bureau of Standards, Washington, D. C., and adopted by the Official Dairy Instructors' Association. The markings are unusually exact, the lines being sharp and uniform. All the markings are permanent being filled with a red enamel which will not wash out.

P1000	10% Milk Test Bottles.....	Each	\$ .25	Doz.	\$2.75
P1005	30% Cream Test Bottles.....	Each	.30	Doz.	3.00
P1011	50% Cream Test Bottles.....	Each	.35	Doz.	3.75
1014	1-100% Skim Milk Test Bottles.....	Each	.75	Doz.	8.00
1026	Acid Measures.....	Each	.15	Doz.	1.50
1019	17.6 c. c. Milk Pipette.....	Each	.30	Doz.	3.00
1023	9 c. c. Cream Pipette.....	Each	.30	Doz.	3.00

**THE BABCOCK TESTER**

- No. 4-2 Bottle size for milk only.....\$7.50
- No. 5-2 Bottle size for milk and cream...\$8.50
- No. 6-4 Bottle size for milk only.....\$8.00
- No. 7-4 Bottle size for milk and cream...\$9.00

Shipping weight about 17 pounds.

All Testers are equipped with full set of glassware for testing milk or milk and cream; also furnished with brush and bottle of acid.

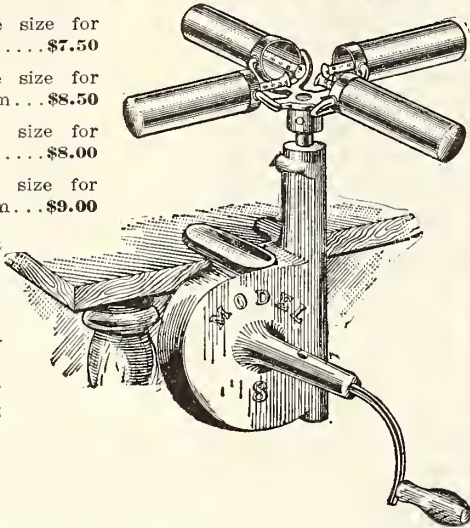

**THE "AGOS" BABCOCK MILK TESTER CAST IRON FRAME**

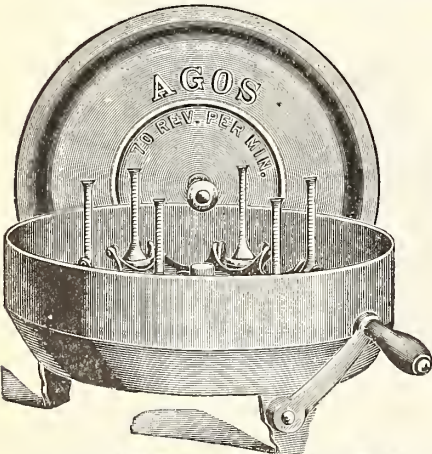

The "Agos" Tester uses the ordinary Babcock bottle, the "B. & W." or the "Ohlson" patent. With each Tester is furnished the following outfit: Full set of regular Babcock milk bottles, pipette, acid measure, acid sufficient for making 50 to 100 tests, and directions for manipulating. They are made in five sizes, as follows:

4 Bottles...	\$17.50
6 Bottles...	18.00
8 Bottles...	19.00
10 Bottles...	19.80
12 Bottles...	20.50

**SULPHURIC ACID FOR TESTING**

9-Pound Bottles.....\$2.25  
Larger quantities, price on application.

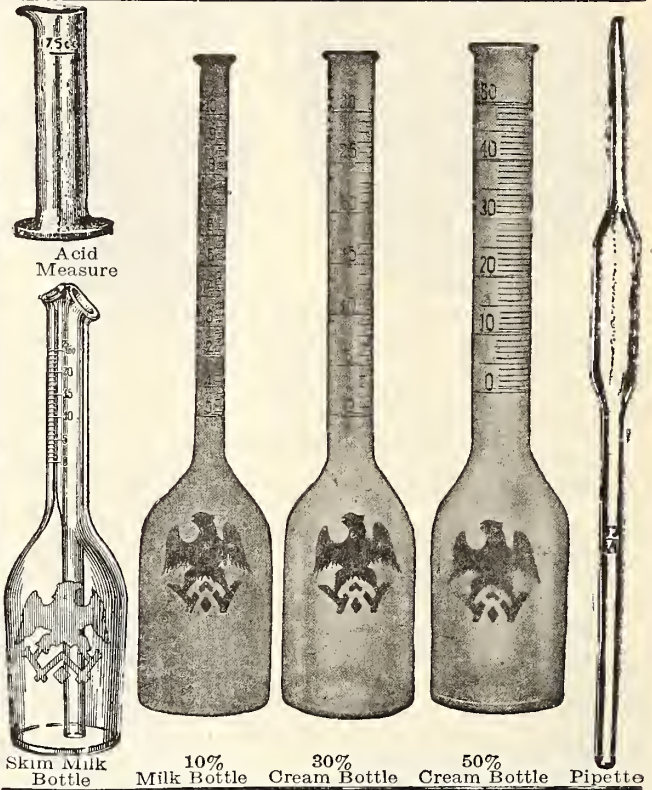

Acid Measure  
Skim Milk Bottle 10% Milk Bottle 30% Cream Bottle 50% Cream Bottle Pipette

**FLOATING GLASS DAIRY THERMOMETERS**



8-inch. Price, 35c. each.  
8-inch Flange Dairy Thermometer, stands boiling water Price, \$1.25 each  
Milk Hydrometer, No 2085 (Quevenne), \$1.50  
Add 8 cents each if by mail



**WELL'S & RICHARDSON CO.'S**

**BUTTER COLORING**

Will not color the buttermilk; will never turn rancid; gives the brightest and best color; butter never becomes reddish; perfect economy in use. It is cheaper than any other coloring.

Dandelion Brand Butter Coloring is guaranteed to be purely vegetable, and that the use of same for coloring butter is permitted under all Food Laws—State and National.

Put up in four sizes  
Small size to color 500 lbs.....\$ .35  
Medium size to color 1,250 lbs .65  
Large size to color 2,800 lbs... 1.00  
Gallon cans..... 5.00

35c. and 65c. size by mail  
Add 15c. for Postage and Packing

## SHARPLES SEPARATOR BRUSHES

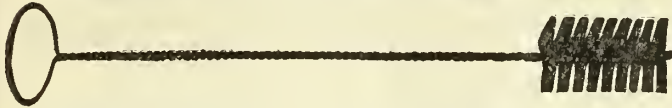

- No. 1—Bowl Brush.....\$0.35
- No. 2—Bowl Brush......35
- No. 3—Bowl Brush......35
- No. 4—Bowl Brush......35
- No. 6—Bowl Brush......35
- Spout Brushes......25
- Feed Tube Cleaner Brush......10

## HAND BOTTLE BRUSHES



No. 86—Prepared Stiff Bristle; brush part, 2 3/4 inches diameter, 6 inches long; hickory handle, 1/2-inch in diameter, 9 inches long. Dozen, \$6.00; each, 55c.

## MILK CAN BRUSHES

Made of an excellent grade of durable fibre, very full, with solid backs. Unquestionably the best and most serviceable Milk Can Brushes on the market.

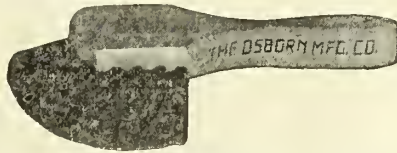

No. 416—Stiff Palmetto; brush part, 4x5 inches. Dozen, \$1.50. Each, 40c.



No. 08—Stiff Palmetto Fibre; length on face, 9 inches; width on face, 5 inches. Dozen,

\$5.75; each, 50c.

## FACTORY, WAREHOUSE AND RAILROAD BROOMS

These brooms are made with heavy steel bands or heads, securely nailed together. By this method of construction it is impossible for the brooms to work loose on the handles. They will last longer and give better service than the ordinary corn broom.

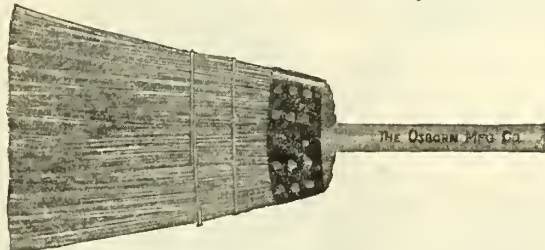

- No. 223—Japanese Fibre; length of broom part, 14 inches...\$ .60
- No. 221—Japanese Fibre; length of broom part, 16 inches... .75
- No. 200—All-Corn Heavy Warehouse Broom..... 1.10
- No. 211—Corn and Bamboo Broom..... 1.25

## STABLE OR PUSH BROOMS



These brooms are of the highest quality. Made with heavy blocks.  
No. 0286—Genuine African Bass, 4 rows.....\$1.00

## Improved Barrel Headers

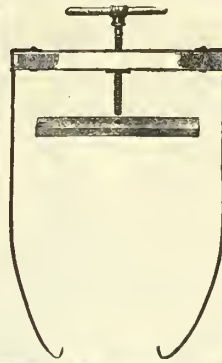

The Nos. 1 and 2 Barrel Headers have the followers attached to the screw, which device is patented. The follower attached thus can revolve, and is taken up with the screw after the barrel is headed. The side clamps are steel and fastened with two bolts.

### Price.

- No. 1 and No. 1-A, with 3/8-inch screw.....\$2.50
- No. 2, with 1-inch screw..... 3.00
- No. 6, with lever..... 2.25

## Keystone Calf Feeder

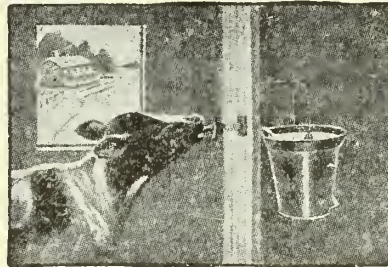

A simple device, based on natural laws, for feeding calves without teaching them to drink. The food is sucked through a rubber nipple and is mixed with the saliva and the digestive juices in a natural way. This feeder will prevent scours. It will make the calves fat and healthy. Used by more than 30 agricultural colleges.

Price.....\$2.25

## Keystone Dehorning Clipper

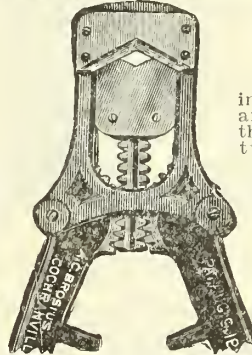

The practice of dehorning cattle is coming more into vogue. It is a mercy to the animals. Prevents going. The blades on the Keystone are made of best steel. No twisting motion or second cut on horn. Parts are all interchangeable, and can be replaced. It is approved by veterinary surgeons and leading dairymen. The horns must go, and they cannot go too soon.

Clipper with leader and rope, extra blades and screw, fully warranted. Our Special Price, \$18.00 Clipper alone; Our Special Price, \$16.00.

## OX BALLS

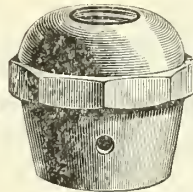

PAIR.....50c.

## BULL RINGS

- 2 1/2-in. Copper Rings, 45c.
- 3-inch Copper Rings, 50c.
- HEAVY BULL RING, \$1.50



## HILL'S HOG WRINGER

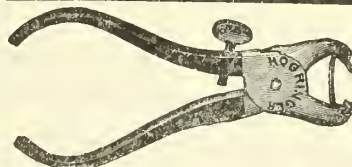

- PRICE.....25c.
- HOG SNOOT CUTTER.....\$2.00
- PRICE.....20c.
- PIG RINGS.....20c.
- SHOAT RINGS.....20c.
- HOG RINGS...20c. Box



## BULL LEADER SNAPS

PRICE, WITHOUT POLE.....\$1.00



## INTERNATIONAL ONEPIPE HEATER

**THE ONEPIPE** or, as termed by many manufacturers, the "pipeless" heater is the most modern development of the warm air heating system, and we unhesitatingly recommend the **INTERNATIONAL ONEPIPE HEATER** as one of the most practical, durable and efficient heaters of this type on the market.

**INTERNATIONAL ONEPIPE HEATERS** are adapted to many city houses as well as to country homes. They are especially efficient in the square type two-story houses with open stairways. They are ideal for heating churches, stores, etc., because of the recirculating feature which takes the cold air from the floors. Because of their low installation cost they are frequently placed in summer camps and cottages that are occupied in spring and fall, and for week-end parties in the winter.

The **INTERNATIONAL ONEPIPE HEATER** is simply a device for heating the air and causing it to circulate through the rooms. It is essentially the same as a regular **INTERNATIONAL Warm Air Furnace**—not a stove, but a furnace, properly designed to get the greatest benefit from the fuel burned, and all parts carefully mounted and fitted. Surrounding this are two castings, an inner and outer casing, and on top you can see the register.

This heater uses only the one large register, which is divided into two parts. It is a well-known fact—as old as nature itself—that air when heated expands and rises. As the warm air pours up through the central portion of the register it goes at once to the ceiling of the various rooms and floods the whole house with warmth.

This warm air displaces the cooler air, which falls to the floor and is then drawn down through the outer portion of the same register, between the outer and inner casings, and is then rewarmed and recirculated.

As the space between the outer and inner casings is always filled with the cooled air returning to be heated, an **INTERNATIONAL ONEPIPE** positively does not heat the cellar.

### LIST PRICE, CAPACITY AND DATA

Number	List Price	Retail Price	Capacity No. of Rooms	Diam. Casing	Diam. Firepot	Diam. Smoke Pipe	SIZE OF REGISTER	
							Outside	Warm Air Pipe
*38-0	\$270.00	\$162.00	4 to 6	38-inch	18-inch	7-inch	24-in.x27-in.	18-inch
42-0	300.00	180.00	6 to 8	42-inch	20-inch	7-inch	30-in.x30-in.	22-inch
46-0	344.00	206.40	8 to 10	46-inch	22-inch	7-inch	35-in.x35-in.	26-inch
50-0	400.00	240.00	10 to 14	50-inch	24-inch	7-inch	40-in.x40-in.	30-inch

\*The 38-0 size does not have coil opening.

These sizes have single feed door.

All Double Door Heaters measure 7 feet 11 inches from base to register, but extension pipe telescopes, so as to fit without cutting, as low as 6 feet 11 inches. Special measurements can be furnished to order, when distance from basement floor to top of first floor is given.

The Moto-Mower has all the desirable features of previous models. It offers efficient power Mowing Service at a moderate cost.

A twist of the wrist controls the power. The power from the engine is transmitted direct to the Cutting Reel, through Jack Shaft, chain and Sprocket, the most efficient method of drive known.

It will operate on hills and terraces, and runs an average of eight hours on a gallon of gasoline.

## THE "PENNSYLVANIA TRIO" LAWN MOWER

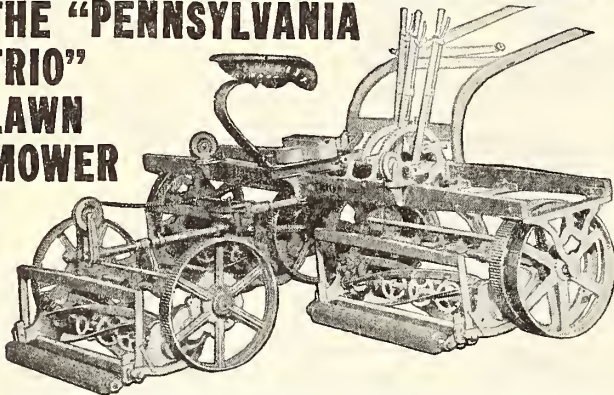

**Automatic Clutch.** It is only necessary to lift the cylinders carrying the revolving knives to disengage them from the gears. The clutches are automatically operated by the lifting device. The cylinders immediately revolve when they are again lowered.

**Wheels.** The wheels are 18 inches in diameter and have a tread of 2½ inches. They are fitted with automobile-type ball bearings.

**Cylinders.** The knives are the same "PENNSYLVANIA" quality of crucible steel, oil-hardened and water-tempered.

**Cylinder Bearings.** The Cylinder carrying the knives revolves in a universally adjustable, bronze bearing. These bearings can be adjusted for wear and cannot get out of alignment. This insures true-running of the cylinder, and a bearing which will last indefinitely.

**Rollers.** Are entirely noiseless and will wear indefinitely. A most convenient feature is that they can be adjusted for height.

- Complete Mower.....\$475.00
- Separate Cutting Units..... 120.00
- 5 Unit Tractor or 4 Horse Mower..... 775.00

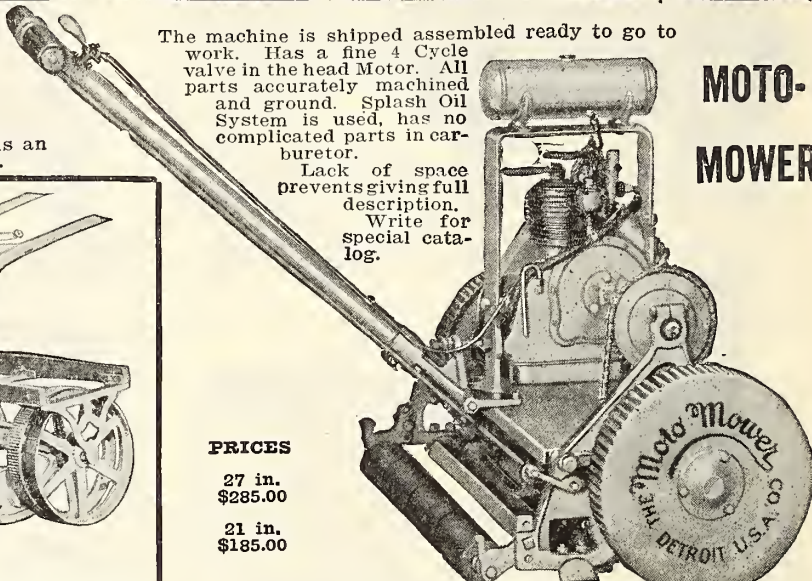

The machine is shipped assembled ready to go to work. Has a fine 4 Cycle valve in the head Motor. All parts accurately machined and ground. Splash Oil System is used, has no complicated parts in carburetor.

Lack of space prevents giving full description. Write for special catalog.

**MOTO-MOWER**

**PRICES**

27 in. \$285.00

21 in. \$185.00

## COLDWELL'S MODEL "L"

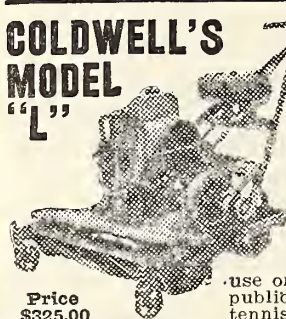

**A Small Mower of Large Capacity (with the Fuller & Johnson Motor)**

The Coldwell Model "L" Motor Lawn Mower and Roller, twenty-five inch cut, has been designed with a view of combining the extreme flexibility of the hand lawn mower with the large cutting capacity, rolling feature and other advantages and conveniences which can be obtained only with a motor mower.

This mower is adapted for use on private lawns, parks, cemeteries, public grounds and for fine cutting on tennis courts and bowling greens.

Price \$325.00

## WHITMAN & BARNES LAWN MOWERS

### NEW NORKA MOWER

**9-INCH WHEEL.**

Pawl and pinion attachment thoroughly tested; one of the best. Ratchet Clutch, cast solid with pinion; no extra pieces to break or get out of order.

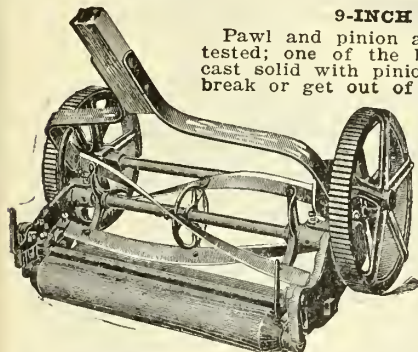

**Do not class with the cheap low-wheel machines.**

Regular.	
12 inch.....	\$ 8.15
14 inch.....	8.50
16 inch.....	8.75
18 inch.....	9.10
Ball Bearings.	
14 inch.....	10.30
16 inch.....	11.00
18 inch.....	11.60

### "NEW ELECTRIC" MOWERS

Wheels 9 inches diameter. Reel 5 3/4 inches diameter. Four blades. Special Ball-Bearing Adjustment, high-grade hardened steel balls, cups and cones, ground, polished and dust-proof. Reel shaft cold-rolled steel. Reel cones best grade Knife Steel perfectly ground.

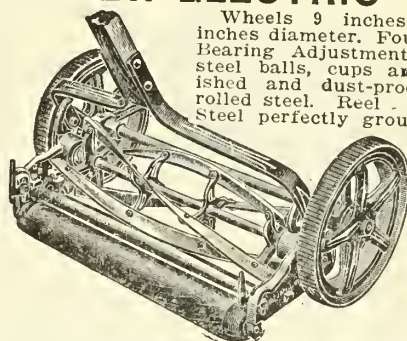

Regular.

12 inch.....	\$ 8.75
14 inch.....	9.25
16 inch.....	9.75
18 inch.....	10.25

Ball Bearings.

12 inch.....	\$10.50
14 inch.....	11.15
16 inch.....	11.75
18 inch.....	12.40

### LITTLE SHAVER MOWER

Low priced and good. 12 in., \$6.90. 14 in., \$7.30. 16 in., \$7.75.

### W. & B. Jr. LAWN MOWERS

Strictly first-class, high-wheel, adjustable reel Mower. Built very strong. Casings have long hubs, through which an 11-16 inch solid steel shaft is passed.

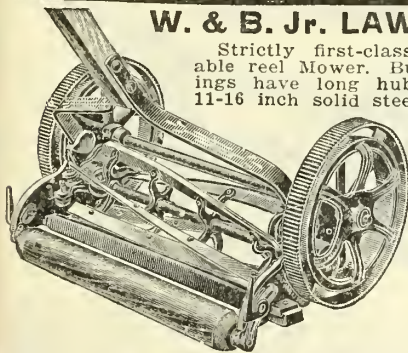

Regular.

14 inch....	\$10.65
16 inch....	11.25
18 inch....	11.90
20 inch....	12.50

Ball Bearings.

14 inch....	12.50
16 inch....	13.15
18 inch....	13.75
20 inch....	14.40

### DIAMOND SPECIAL BALL-BEARING MOWER

This machine is built of highest quality material, and is fitted with Ball-Bearing Adjusting Device. The balls, cups and cones are of high-grade, uniformly hardened, polished and dust-proof. The reel has five blades of best knife steel, and is adjusted to the Cutter Bar by a special adjusting and locking device. Wheels, 10 inches in diameter.

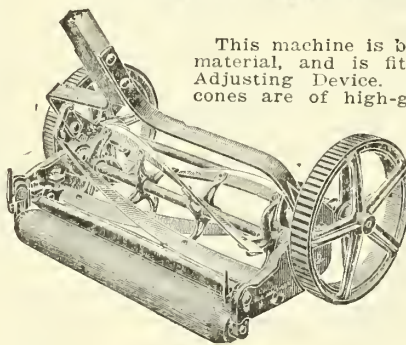

14 inch.....	\$14.40
16 inch.....	15.30
18 inch.....	16.25
20 inch.....	17.20

## BALTIMORE HORSE LAWN MOWER

The Baltimore Horse Lawn Mower is made of best material; most satisfactory adjustment of knives; strong and durable; heavy roller, which is a necessity to keep the lawn in good order; simplest and strongest machine in construction on the market, and most economical as far as repairs are concerned.



It is made with shafts and seat, and also with draft rod. For hilly lawns, we recommend shafts and seat, but for level lawns with many trees and shrubbery, we recommend the draft rod, as it enables the driver to work the machine close to them. See it work, and you will be convinced that it is the most practical machine made.

	Our Spec. Price.
25-inch Machine, with Draft Rod.....	\$110.00
30-inch Machine, with Draft Rod.....	123.00
30-inch Machine, with Shafts and Seat.....	143.00
35-inch Machine, Shafts and Seat.....	163.00

### Pennsylvania Regular Horse Mower

Furnished with handles and draft irons, the latter arranged to swing to the side, thus permitting the horse to walk on the cut grass.

26-inch Machine, with Draft Rod.....	\$125.00
38-inch Machine, with Draft Rod.....	155.00
30-inch Machine, with Shafts and Seat.....	150.00
38-inch Machine, with Shafts and Seat.....	180.00

### Lawn Mower Repairing and Sharpening

OUR well-equipped shop and competent mechanics, that have been repairing and sharpening lawn mowers for years, assures you of a first-class job. In a season we repair many hundreds of lawn mowers, and as most of them have to be repaired and sharpened before the first grass mowing, you will readily see the necessity of sending your mower in early. During the early season we run our repair department many times at night that we might give our patrons prompt service.

Our repair department does not confine its operation to sharpening and repairing lawn mowers only. We are in position to do general repair work and solicit your patronage in other lines of work.

For your convenience, look over your lawn mower during the winter and send it in during the late winter months. This will give our mechanics ample time to give it the attention required, and will save you the possibility of being inconvenienced by having to wait your turn later on.

## PENNSYLVANIA HIGH-WHEEL MOWER

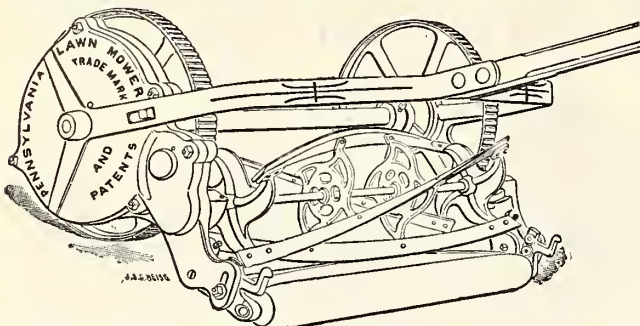

This high-grade Mower is constructed for cutting ordinary grass, as well as grass from 6 to 10 inches high. Wheel, 10 1/2 inches; cylinder, 6 1/2 inches. Four crucible steel knives.

	List	Retail		List	Retail
15 inches...	\$30.00	\$28.50	19 inches...	\$38.00	\$36.10
17 inches...	34.00	32.30	21 inches...	42.00	39.90

## GREAT AMERICAN BALL-BEARING MOWER

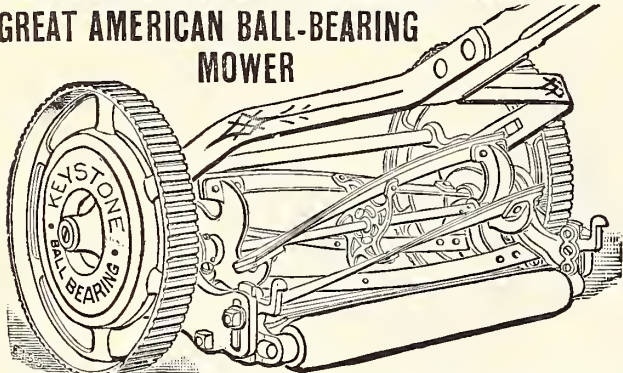

Every detail of this Mower is in keeping with the high grade of the Pennsylvania and Continental. Can be regulated to cut from 3/4 to 1 3/4 inches from the ground.

	List	Retail		List	Retail
15 inches...	\$30.00	\$21.00	19 inches...	\$38.00	\$26.60
17 inches...	34.00	23.80	21 inches...	42.00	29.40



Our Special Price, \$15.00

## HORSE LAWN BOOTS

Fastened firmly to hoof instead of around ankle, giving free action to horse's feet. Rolling toe prevents cutting of turf. Width inside, No. 2, 5 1/2 inches; No. 4, 6 1/2 inches; No. 6, 7 inches—the right sizes for Nos. 2, 4 and 6 horses-shoes. No. 0 Mule and No. 1 Pony. Special sizes to order.

## CONTINENTAL HIGH-WHEEL MOWER

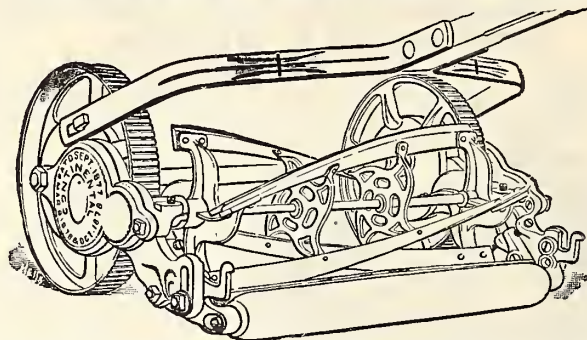

This very high-grade machine will cut fine grass two inches high; also grass six to eight inches. We highly recommend this machine.

	List	Retail		List	Retail
15 ins.....	\$30.00	\$28.50	19 ins.....	38.00	\$36.10
17 ins.....	34.00	32.30	21 ins.....	42.00	39.90

## Pennsylvania Jr. Ball-Bearing Mower

Same high-grade construction used in the Pennsylvania High-Wheel and Continental Mower.

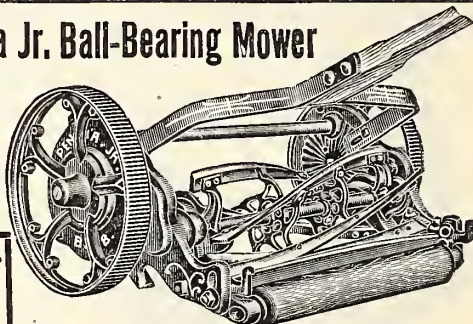

	List	Retail		List	Retail
15 ins.	\$30.00	\$28.50	19 ins.	\$38.00	\$36.10
17 ins.	34.00	32.30	21 ins.	42.00	39.90

## Pennsylvania Roller Mower For Putting Greens

This mower is unexcelled for cutting undulating or wavy greens, also tennis courts, cricket creases and other Lawns requiring an exceptionally close and smooth cut.

It has six crucible tool steel blades oil-hardened and water tempered Triple gears, insuring power and speed, cast iron roller, 7 inches in diameter, improved curved pattern tempered crucible steel tool bottom knife, cuts 3-16 to 1 1/4 inch. Staytite hardwood handle with adjustable steel clamps on cross bar.

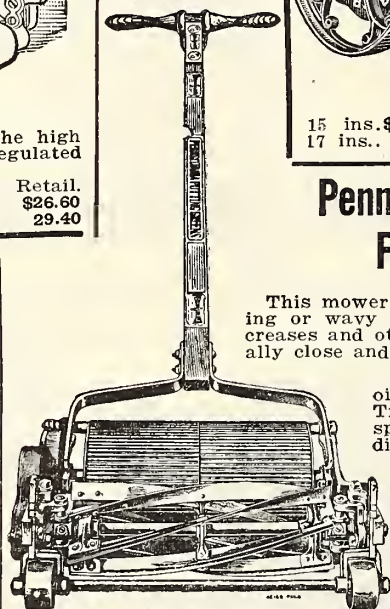

PRICE	
16 inch.....	\$35.25
18 inch.....	39.60

## GRASS CATCHERS

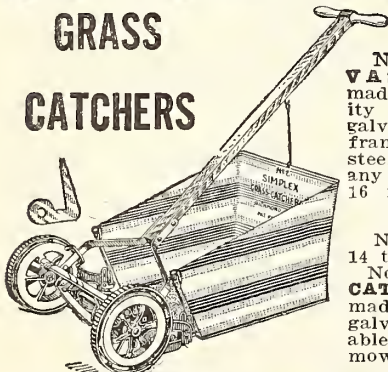

No. 110—CANVAS CATCHER, made of fine quality duck, heavy galvanized wire frame; adjustable steel hooks will fit any mower, 12 to 16 inches wide.

Price...\$ .75

No. 115—From 14 to 20 inches. Price \$ .90

No. 160H—METAL BOTTOM CATCHER, 13 inches deep made of heavy duck; heavy galvanized wire frame; adjustable steel hooks; adjustable to mowers, 12 to 16 inches wide Price..\$1.10

No. 165H—16 to 20 inches wide..... Price \$1.25

## ORCHID BALL-BEARING MOWER

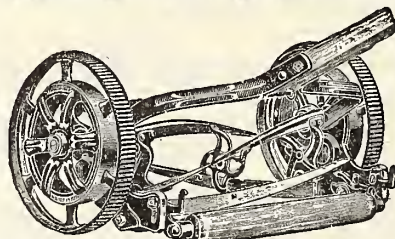

This machine is made from high-grade material. Its construction, while extremely simple, is very strong and durable.

16 inch, Our Special Price, \$17.25

18 inch, Our Special Price, \$18.00

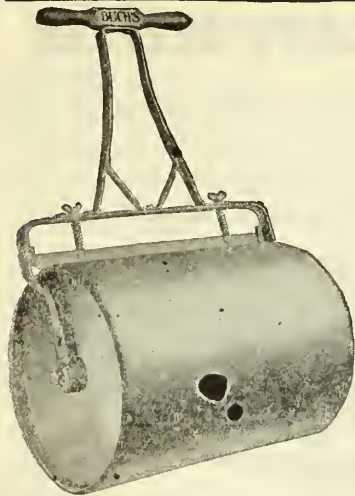

## WATER BALLAST LAWN ROLLER

filled with water to any desired weight. It can thus be regulated to suit soft turf, firm lawns or driveway, tennis court, etc. It can be emptied for storing away, making it light and easy to handle. The drum is high carbon steel with all seams electric welded. Edges are rounded back to prevent cutting of lawns, courts, etc.

The axle is mounted on roller bearings, making the roller run very easily.

Order No.	Diam. of Drum.	Length of Drum.	Weight Empty.	Filled with Water.	Price.
601	14 in.	24 in.	60 lbs.	250 lbs.	\$17.00
602	18 in.	24 in.	73 lbs.	330 lbs.	20.00
603	24 in.	32 in.	100 lbs.	440 lbs.	23.00
604	24 in.	32 in.	115 lbs.	590 lbs.	26.00

## HAND LAWN ROLLER (CAST IRON)

No.	No. Sec.	Width Face.	Diam. Sec.	Total Length.	Weight.	Our Special Price.
4 or 504	2	10 in.	20 in.	20 in.	250 lbs.	\$73.50
6 or 507	2	10 in.	20 in.	24 in.	300 lbs.	82.25
9 or 509	2	10 in.	24 in.	20 in.	400 lbs.	96.00

In presenting this **Double Gang Pulverizer**, we wish to call special attention to the construction of the end brackets, which are so constructed as to allow the trailer to raise and fall with the variations of the soil, thus insuring an even pressure from both gangs at all times.

No.	Size	Front Gang	Rear Gang	Weight	Price
626	7-foot	18-15 in. Discs	19-12 in. Discs	900	\$72.50
627	8-foot	21-15 in. Discs	22-12 in. Discs	1000	80.00
628	9-foot	24-15 in. Discs	25-12 in. Discs	1100	90.00

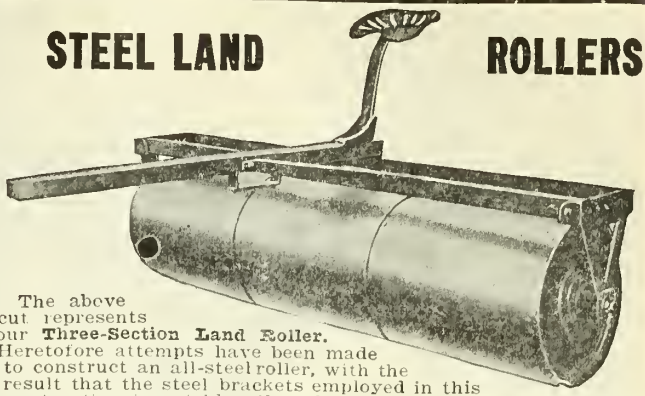

## STEEL LAND ROLLERS

The above cut represents our **Three-Section Land Roller**. Heretofore attempts have been made to construct an all-steel roller, with the result that the steel brackets employed in this construction invariably allowed the rolls to get out of alignment, thus quickly wearing out the boxes. To avoid this tendency, we have substituted heavy iron brackets to support the bearings and which entirely surrounds them. This construction insures true alignment and eliminates constant expenditures for repairs and replacing boxes. An additional feature of this roller is the blocking in of the frame under the pole with a 4-inch hard wood block. This construction gives the roller perfect rigidity and absolutely springing of the steel frame when turning around, crossing dead furrows, etc. It is further braced with steel braces from the frame to the pole, which not only adds strength to the roller, but prevents breaking of the pole.

The Drums are 24 inches in diameter, made from extra heavy hard steel sheets and are not easily indented. The ends are made from pressed steel and fitted with heavy cast bearings which allows each roll to turn independently.

Sections	Length feet	Diameter inches	Weight lbs.	Special Price.
No. 105 1/2	2	24	550	\$40.00
No. 105 1/2	3	24	585	42.50

Price does not include Doubletrees and Neck Yoke.  
Doubletrees and Neck Yoke..... \$6.00

## GRITCO DOUBLE GANG PULVERIZER

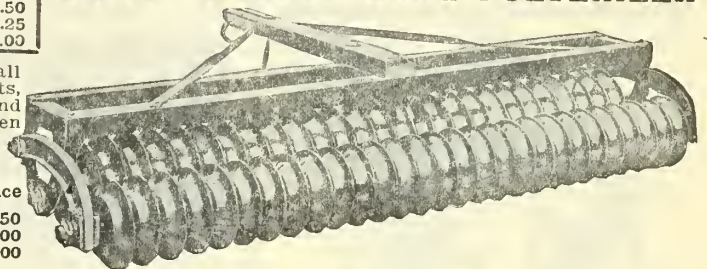

## OLIVER

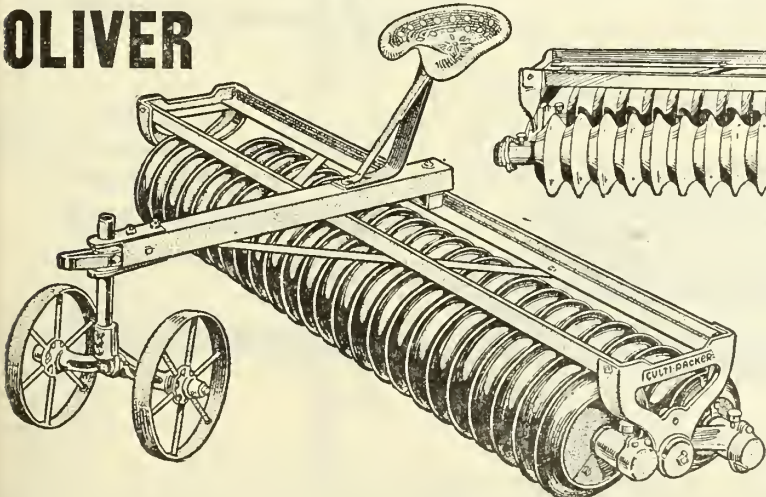

## TRACTOR CULTI-PACKER

The effective grinding, pulverizing action of the Culti-Packer on the soil is accomplished by the peculiar shape and position of the wheels. The edges of the wheel are moulded in a curved "V" shape which turns soil away at either side much like a mouldboard of a plow.

No.	Size	Front Gang	Rear Gang	Price
HP7	7-ft.	18-15 in. Discs	19-12 in. Discs	\$95.00
HP8	8-ft.	21-15 in. Discs	22-12 in. Discs	103.00
HP10	10-ft.	27-15 in. Discs	28-12 in. Discs	122.50
Culti-Packer without foretruck, deduct,				6.00

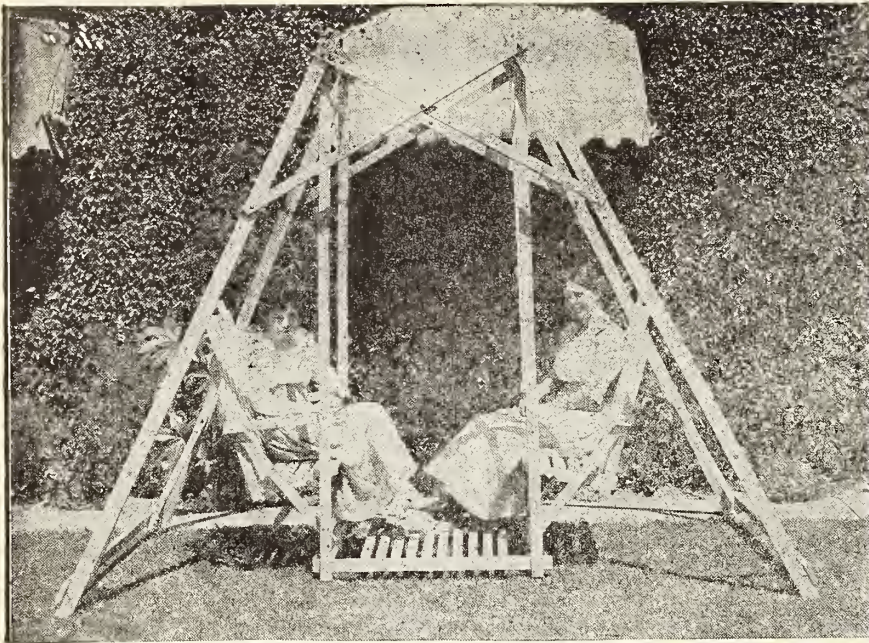

**Lawn Swing—The Bonanza**

Accompanying cut represents our "Bonanza" four-passenger Lawn Swing. Made of hardwood, with 3/4-inch bolted frame

Has three seat and foot-rest adjustments. Frame painted red; balance of swing golden oak. Hooks where swing bars hang on iron rods at top of frame.  
 Height ..... 9 ft.  
 Seat Space ..... 34 in.  
 Ground Space ..... 9 ft 4 in. x 6 ft.  
 4-Passenger ..... \$11.75



**Bausman Steel Lawn Swing**

With Canopy ..... \$23.40  
 Without Canopy .. 20.50

**No. 6 Porch Settee**

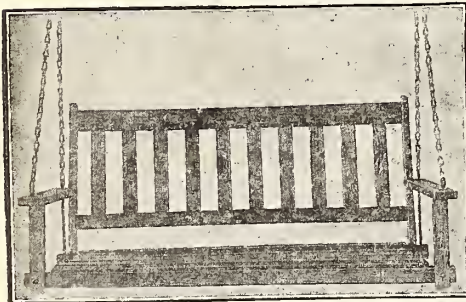

Made from 1-inch oak stock. In design the lines are very much the same as the No. 8, made with formed seat, as shown in cut, but without the paneled ends.  
 No. 6—3 1/2-foot. Our Special Price \$4.30  
 No. 6—4-foot. Our Special Price 4.90

**WINNER LAWN SWING**

This Lawn Swing is made of hardwood, frame painted a bright vermilion, chairs, hangers and foot-rest a beautiful golden oak, and is a splendid value for the money.

4-Passenger ..... \$10.00

**COMPETITION LAWN SWING**

4-Passenger ..... \$9.25

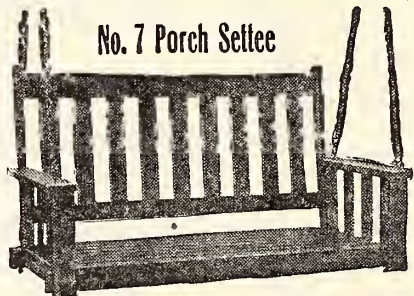

**No. 7 Porch Settee**

Very popular and durable. Finished in weathered oak. All slats bolted to frame; no rivets.

No. 7—4-foot. Our Special Price, \$5.80  
 No. 7—5-foot. Our Special Price, 6.80

**No. 8 Mission Porch Settee**

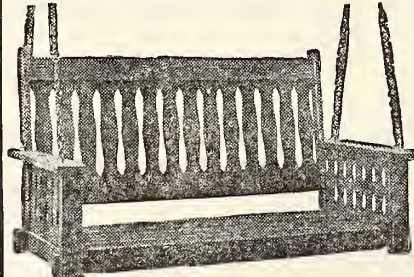

1 1/4-inch oak stock, very strong and substantial, mission effect saddle seat. Put together with rods and bolts.

No. 8—4-foot. Our Special Price, \$7.50  
 No. 8—5-foot. Our Special Price, 8.75  
 No. 8—6-foot. Our Special Price, 10.10

**LAWN SETTEES**

The Lawn Settees listed below, have strength and beauty, and at the same time are very reasonable in price. The frames are made from strong steel, and the seats and backs from smoothly finished hardwood.

**Meadowbrook Settee**

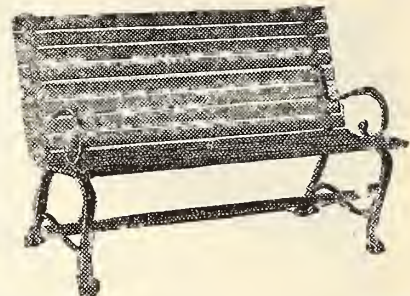

4 Foot..... \$10.25  
 5 Foot..... 12.25

**Commonwealth Settees**

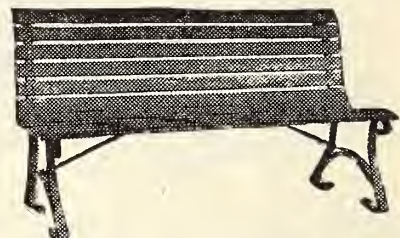

4 Foot..... \$ 8.25  
 5 Foot..... 10.25

**Country Club Settees**



4 Foot..... \$7.25  
 5 Foot..... 9.25

**Parkside Settees**



4 Foot..... \$6.30  
 5 Foot..... 7.80



## PERFECTION FABRIC

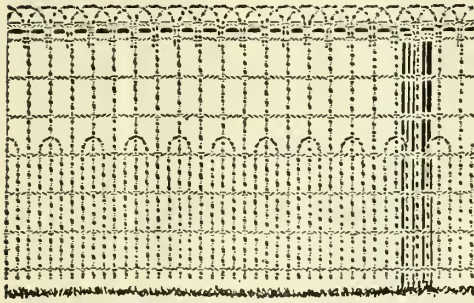

Lawn Fence is made of No. 9 heavy galvanized wire spacing between uprights at the bottom, being 1 3/4 inches, and at the top 2 1/4 inches; the cables are of heavily galvanized wire, spaced about six inches apart, except the two at top, which are spaced 2 1/4 inches apart; furnished regularly in rolls of 200 feet. Any length cut to order.

### PRICES OF PERFECTION FENCING

Height	List, Per Ft.	Our Price.
36 inches	22c.	17c.
42 inches	25c.	19c.
48 inches	28c.	21c.

These prices are for the fence fabric only, and do not include posts. For prices of complete fence see below.

### PRICE OF ECONOMY FENCING

Height.	List Price.	Our Price
36 inches	16c.	12c.
42 inches	18c.	14c.
48 inches	20c.	16c.

## ECONOMY FABRIC

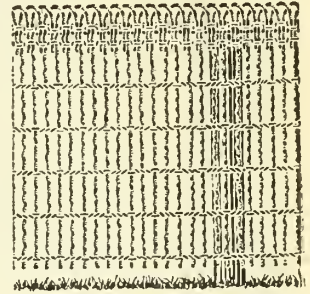

## PERFECTION GATES

The frames are made of high grade heavy steel tubing, and are regularly finished in galvanized frames. Filling of these gates is the regular Perfection Fence Fabric, described at top of page, and as shown by illustrations, the gates have ornamental scrool tops. In giving the dimensions of gates, state first the height and then the width. The width of these Gates means the distance between the posts. The factory makes proper allowance for hinges and latch.

### WALK AND SINGLE DRIVE GATES

36, 42 or 48 Inches High.

Width, Ft.	List Price.	Our Price.
3 Walk	\$ 4.80	\$ 5.00
3 1/2 Walk	5.20	4.45
4 Walk	5.60	5.40
8 Drive	10.00	8.50
10 Drive	12.00	10.20
12 Drive	14.00	11.90
14 Drive	16.50	14.00

### DOUBLE DRIVE GATES.

36, 42 or 48 Inches High.

Width, Ft.	List Price.	Our Price.
8	\$12.00	\$ 9.50
10	14.00	11.90
12	16.00	13.25
14	17.20	14.65

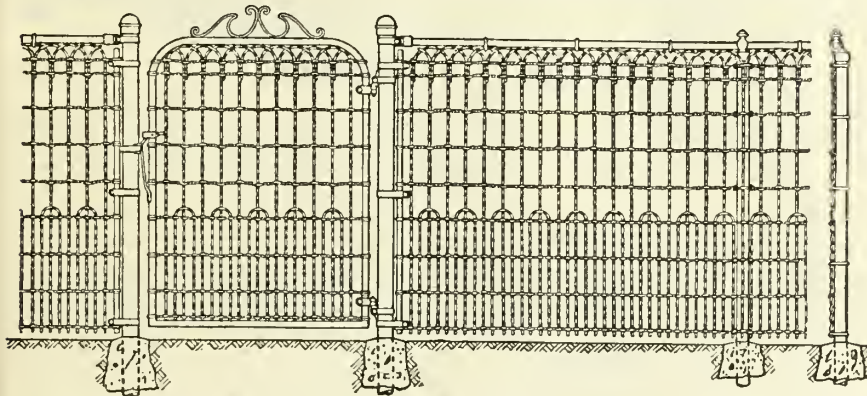
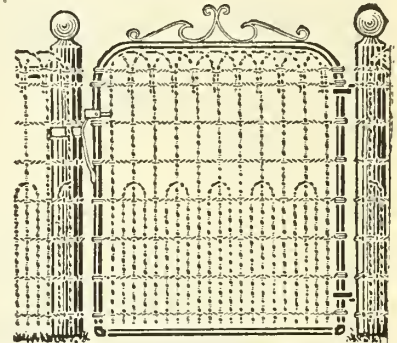

## PERFECTION COMPLETE FENCE

Perfection Complete Fence is a pleasing dignified design which will harmonize with and add character to the property inclosed. Furnished in suitable heights for the home, private grounds, cemeteries and parks.

Height refers to fabric used. The complete fence, when erected will measure a few inches higher than the fabric. Gates are not included in the lineal footage of fence, but are billed separately at regular prices.

All parts of fence are thoroughly galvanized.

### Price per Foot F. O. B. Factory.

36 inches	84c.
42 inches	88c.
48 inches	92c.

## CYCLONE TRELLIS

Train your flowers on this trellis, which is an attractive and practical trellis at a few cents per foot. Cyclone Trellis is made of strong, durable, galvanized wire, which will keep its shape, and last almost indefinitely. Easily put up and cut to any length desired.

24-inch width.  
List Price, per ft. 20c.  
Our Price, 16c.

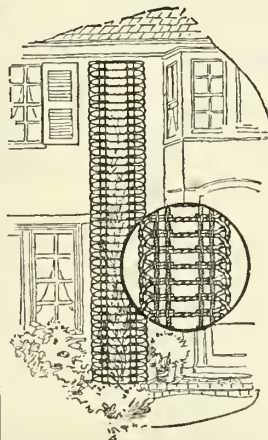

## PERFECTION TRELLIS

This trellis carries the general style of Perfection Fencing. It is extremely strong, embracing beauty and adaptability. Cut in any length desired.

Width.	List Price.	Our Price.
18 inches	14c.	12c.

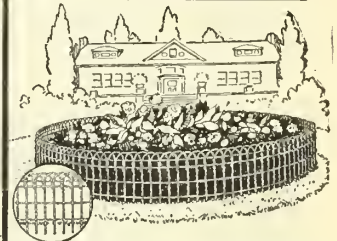

## PERFECTION FLOWER-BED GUARD

Is 18 inches high above ground. Has 3 cables of two No. 13 wires. Has No. 9 crimped uprights. All heavy galvanized pickets project for insertion in ground. Requires no posts. Can be cut to length to any bed. It provides protection against dogs and chickens.  
List Price, per foot, 13c.  
Our Special Price, 11c.

## U. S. FIELD FENCE

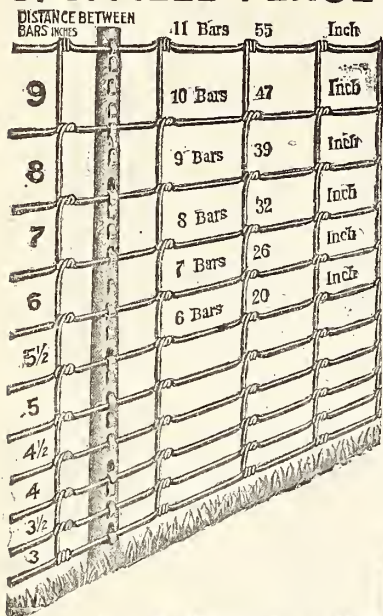

SIZE OF WIRE USED IN FIELD FENCE. IN POULTRY FENCE.

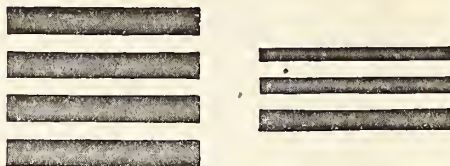

## U. S. POULTRY AND GARDEN FENCE

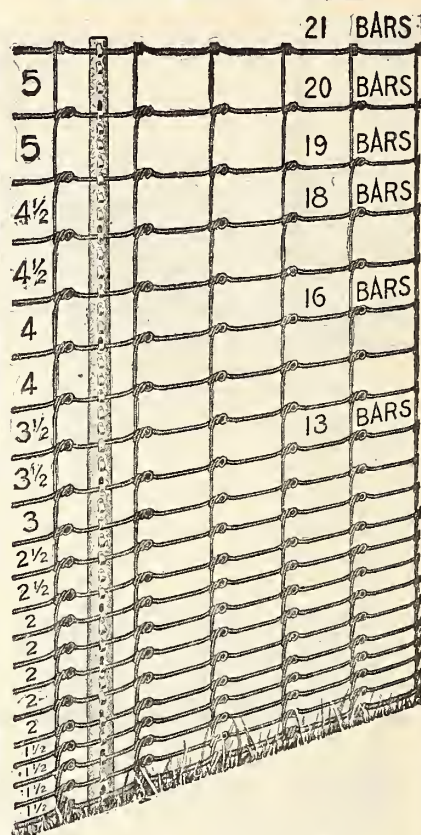

## U. S. CATTLE AND DIVISION FENCE

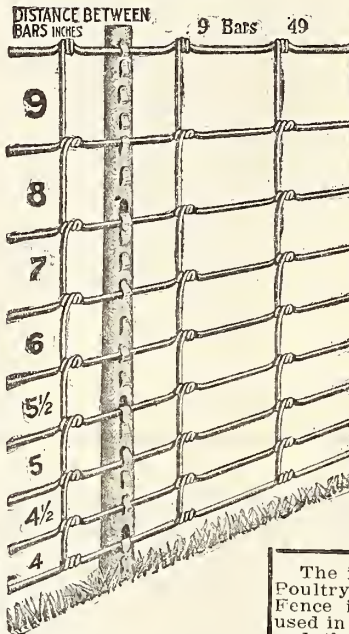

## U. S. FIELD FENCE

For Horses, Cattle, Sheep, Hogs and all Farm Animals.

Stay wires either 6 or 12 inches apart. This fence made in five heights is ample for general farm use. The close spacing at the bottom turning hogs and the construction is such as to hold sheep, cattle and horses.

The top bar is No. 9, the bottom No. 10, the intermediate bar, No. 11 and the stays are No. 11 wire.

Style No.	Height in in.	12-INCH STAYS		Retail Prices per Rod	6-INCH STAYS		Retail Prices per Rod
		Approx. Weight per Rod Pounds	List Prices per Rod		Approx. Weight per Rod Pounds	List Prices per Rod	
1155	55	11.8	\$1.28	.77	15.9	\$1.79	\$1.08
1047	47	10.6	1.14	.69	14.1	1.58	.95
939	39	9.4	1.02	.62	12.4	1.40	.84
832	32	8.3	.90	.54	10.8	1.22	.73
726	26	7.2	.79	.48	9.3	1.05	.63

This is an ideal horse and cattle fence and is used largely for division fences. The stays are 12 inches apart, and we do not recommend its use for hogs. The top bar is No. 9 the bottom No. 10, the intermediate bars are No. 11 and the stays are No. 11 wire.

## U. S. Cattle and Division Fence

Style Number	Height in Inches	12-INCH STAYS		Retail Prices per Rod
		Approx. Weight per Rod Pounds	List Price per Rod	
949	49	10	\$1.08	\$0.65
845	45	9	.98	.59
635	35	7	.76	.46

The illustration above shows the U. S. Poultry and Garden Fence, and the U. S. Poultry Fence is built of the same grade of wire as is used in the U. S. Field Fence, but of lighter gauge and the same excellent wrap is used. It is an ideal fence against poultry and small animals. The spacing is graduated from 1 1/2 inches at the bottom to 5 inches at the top, as shown by the illustration and the distance between the stays or uprights is 6 inches. We carry this fence in stock in the styles mentioned below. It is very extensively used as a protection for poultry yards, gardens and orchards. It meets the requirements; therefore it is a great favorite. Furnished regularly in rolls containing 10 rods or 165 lineal feet.

Style No.	Distance Between Stays	Height Inches	Approx. Weight Per Rod	List Price Per Rod	Retail Price Per Rod
2158	6	58	12.5	\$1.37	\$.83
1948	6	48	11.1	1.22	.73
1635	6	35	9.2	1.01	.61

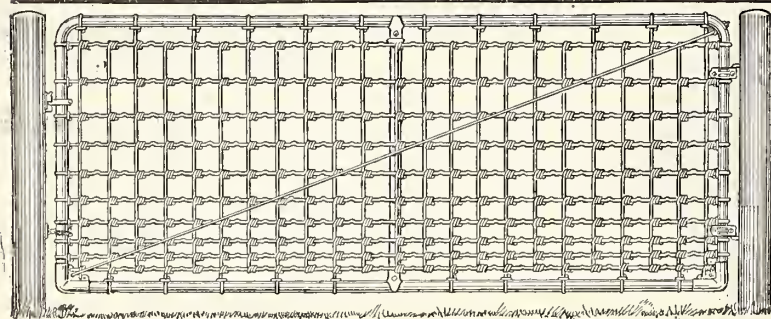

## General Purpose Farm Gates

The frame is made from heavy 1 1/4 inch outside dimension tubing. The wire filling is Heavy Galvanized No. 9 Woven Wire. The frames are Galvanized, and electrically welded at the joints thus insuring a gate that will not sag or twist out of alignment. In addition the gates are strengthened by internal braces.

The fabric is actually woven into the frame and not simply tied in with a lace wire.

Height	Distance Between Posts			
	10 Ft.	12 Ft.	14 Ft.	16 Ft.
48 inches.....	\$8.85	\$10.20	\$11.30	\$12.70
54 inches.....	9.20	10.85	11.75	13.25

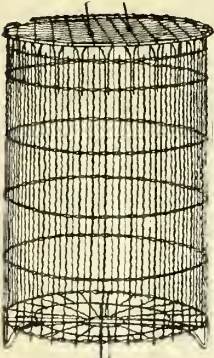

## TRASH BURNER OR CONSUMERS

The best way to dispose of your waste paper and rubbish is to burn it in a **Consumer**. Avoids danger and helps to keep the yard and lawn clean and free from litter. Being made of heavy steel wire, with removable cover, it serves as a strong and neat waste basket.

- No. 1—20 in. diameter, 30 in. high.  
**Retail Price.....\$4.00**
- No. 2—17 in. diameter, 25 in. high.  
**Retail Price.....\$3.00**

## SAMPSON WOVEN WIRE STRETCHER

This stretcher answers perfectly the demand for a first-class woven wire stretcher of sufficient strength to sustain any pull with enough power to stretch any length of fence desired. The **SAMPSON** fits the case exactly for it is strong enough to stand any strain necessary to make the fence snug and tight.

Handle is 5 feet long, clamping bars 4 ft. 6 ins. long, both of hard wood. Eight feet of tested chain with each stretcher. Weight, 35 pounds. **Price.....\$8.25**

## THE "NEVERSLIP" STRETCHER

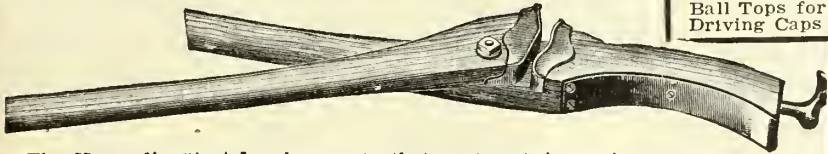

The **Neverslip Stretcher** has no teeth to cut or injure wire. Simple and strong in construction. Has hickory handle and malleable jaw. One man operates it, and both hands are left to drive staple. Price without staple puller, **\$1.00**; with staple puller, **\$1.25**.

## GALVANIZED STEEL FENCE POSTS

**CHEAPER THAN WOOD AND MORE DURABLE—  
GALVANIZED INSIDE AND OUT.**

These posts are neat, strong, durable and easy to erect. They will give you much more and better service than can be expected of wood posts because all being alike in size and quality of material, you get benefit of every post in the fence from year to year, while wood posts rot and decay. The line posts are strong enough to hold up any wire fencing, and furnish all necessary resistance. The end and corner posts are so strong that they will maintain any wire fence made.



Nos.	Length in Feet	Approx. Weight in Lbs.	Special Prices, Per Post	
14 1/2	Line Post.....	5	7.4	<b>\$0.65</b>
14 1/2	Line Post.....	6	8.4	<b>.70</b>
14 1/2	Line Post.....	6 1/2	9.3	<b>.74</b>
14 1/2	Line Post.....	7	10.	<b>.80</b>
14 1/2	Line Post.....	7 1/2	10.7	<b>.85</b>
14 1/2	Line Post.....	8	11.4	<b>.95</b>
14 1/2	Line Post.....	9	12.8	<b>1.35</b>
10	End Post.....	7	51.	<b>4.25</b>
10	End Post.....	8	59.	<b>4.75</b>
10	Corner Post... 7		75.	<b>6.30</b>
10	Corner Post... 8		86.	<b>6.80</b>
	Ball Tops for Line Posts.....			<b>.27</b>
	Ball Tops for End and Corner Posts.....			<b>.54</b>
	Driving Caps for Line Posts.....			<b>.54</b>

## WIRE STRETCHER No. 1



## PAGE RELIABLE FENCE

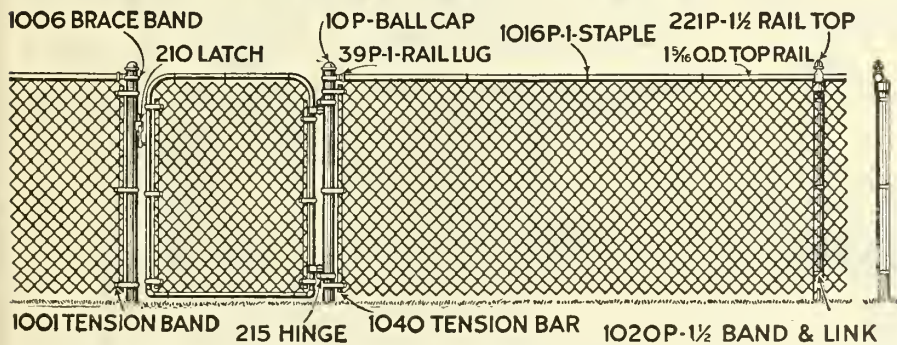

There are many instances where a fence is required which combines the qualities of attractiveness and maximum protection. Page Wire Link makes up into a most attractive fence, one which will enhance the natural beauty of any property. Its several exclusive features makes it possible to supply in this fence the protection desired.

The fabric is of 2-inch mesh No. 9 (W. & M. Gauge) wire, heavily galvanized. Each picket is interlocking, thus preventing any spreading of the wires. It is non-climbable.

Height refers to height of fabric used. The complete fence, when erected, will measure a few inches higher than the fabric.

Gates are not included in the lineal footage of fence, but are billed separately at regular prices.

Height.	Complete Fence, F. O. B. Factory		Fabric only, F. O. B. Baltimore.	
	List Price	Retail Price	List Price	Retail Price
36 inches	<b>\$.84</b> Per ft.	<b>\$.68</b> Per ft.	<b>\$.26</b> Per ft.	<b>\$.20</b> Per ft.
42 inches	<b>.88</b> Per ft.	<b>.71</b> Per ft.	<b>.30</b> Per ft.	<b>.24</b> Per ft.
48 inches	<b>.92</b> Per ft.	<b>.74</b> Per ft.	<b>.35</b> Per ft.	<b>.28</b> Per ft.
60 inches	<b>1.02</b> Per ft.	<b>.82</b> Per ft.	<b>.44</b> Per ft.	<b>.36</b> Per ft.

**BARBED WIRE RIBBON WIRE  
TWISTED TWO STRAND WIRE  
PLAIN GALVANIZED WIRE  
PLAIN ANNEALED WIRE**

**PRICES ON APPLICATION.**

## AMERICAN SINGLE JACK STRETCHER

The American Single Jack Stretcher combines all the important features of a fence Stretcher—Simplicity, Strength and Safety.

It is made entirely of steel, therefore, strong and durable.

Its angle bars, or clamp bars, are rounded in such a way as to prevent injury to the wire during the stretching.

Only three bolts on Clamp Bars—which can be easily and quickly tightened.

It can be operated by one person.

This Stretcher consists of one pair of Clamp Bars, one Jack or Stretching Head, one set of Chains and Lever.

**Price, \$10.50**

## LOTT STRETCHER

Clamp Bars made of, reinforced with half-oval iron to keep wire from slipping.

Lott Stretcher furnished complete except Lever. Use for this purpose an old piece of pipe or lever cut from wood.

**Price, \$9.00**

## DIAMOND MESH POULTRY NETTING

The wire we offer is No. 20, double twist, 2-inch mesh, thoroughly galvanized. Sold in bales of 150 running feet.

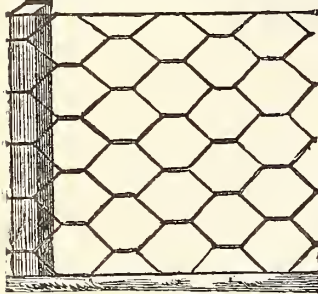

In. No.	Sq. Wide.	Feet.	List Price Per Bale.	Retail Price
20	12	150	\$2.14	\$1.45
20	18	225	3.08	2.05
20	24	300	3.92	2.65
20	36	450	5.35	3.60
20	48	600	7.13	4.80
20	60	750	8.91	6.00
20	72	900	10.69	7.15

Price 1½c. per square foot in less than bale lots. Staples for fastening, 10c. per pound.

### ONE INCH MESH

No.	1-inch Mesh Galv. After Weaving. Inches wide.	Square feet.	List Price Per Bale.	Retail Price Per Bale.
20	12	150	\$ 4.95	\$ 3.30
20	18	225	7.12	4.75
20	24	300	9.08	6.10
20	36	450	12.38	8.30
20	48	600	16.50	11.00
20	60	750	20.63	13.80
20	72	900	24.75	16.50

## GALVANIZED STEEL WIRE CLOTH

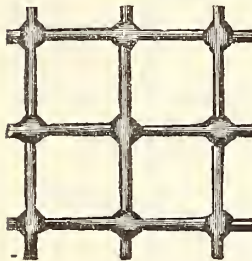

Made from heavy wire thoroughly galvanized after weaving. This insures long life, as every part of the wire is coated by the dipping process.

Used largely in corn cribs to make them mice and rat proof, also for sieves and fan screens and over windows for protection.

We carry it in stock in widths 2, 2½, 3 and 4 foot.

The word mesh means number of meshes to the inch (2x2, 2 to the inch; 4x4 mesh, 4 to the inch, etc. Full rolls contain 100 running feet.

PRICE.	Full Rolls.	Less Than Full Rolls.
2x2 Mesh, per sq. ft.	\$0.06	\$0.07
3x3 Mesh, per sq. ft.	.06½	.07½
4x4 Mesh, per sq. ft.	.07	.08

2x2 Mesh, per sq. ft.	\$0.06
3x3 Mesh, per sq. ft.	.06½
4x4 Mesh, per sq. ft.	.07

## BANNER POULTRY FENCE

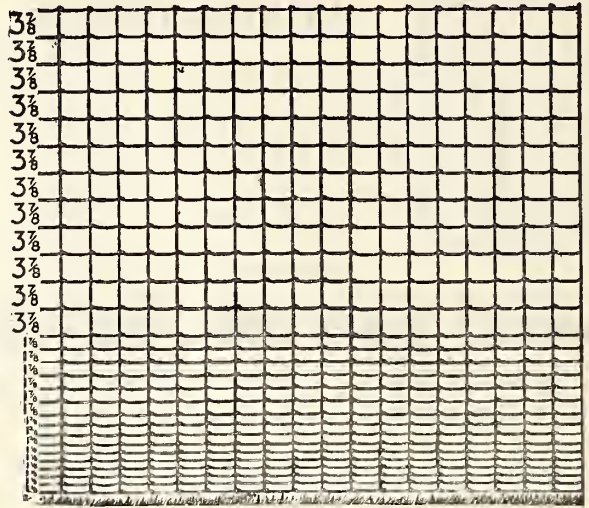

Banner Fence meets the demand for a closely woven fence heavier than the light poultry nettings. The spacing between the six line wires at bottom of fence is only 1½ inches and gradually increased to 3¾ inches at top, so the essential feature of a satisfactory poultry fence—closeness of mesh—is well taken care of in this fencing. The upright wires or stays run continuously across the fence and lock firmly around the intersecting line wires in a loop knot, forming a smooth, solid joint without any sharp, rough edges. Top and bottom wires No. 15; all other wires No. 17 gauge, hard steel, thoroughly galvanized.

Style.	Height.	No. of Bars.	Price per 10-rod Roll.
1624	24 inches	16	List, \$7.10 <b>Our Price, \$4.25</b>
1936	36 inches	19	List, 8.80 <b>Our Price, 5.25</b>
2248	48 inches	22	List, 10.50 <b>Our Price, 6.30</b>
2560	60 inches	25	List, 12.30 <b>Our Price, 7.40</b>
3872	72 inches	28	List, 14.00 <b>Our Price, 8.40</b>

## American Walk Gates—Galvanized Frames

	List Price	Our Special Price
3 ft. Wide 50 in. High.....	\$5.40	\$4.00
3 ft. Wide 58 in. High.....	5.70	4.25
3½ ft. Wide 50 in. High.....	5.98	4.50
3½ ft. Wide 58 in. High.....	6.35	4.75

These gates are for use with Poultry Fencing.



**This Fencing IS STRONG ENOUGH FOR LARGE ANIMALS, AND Small ones cannot pass THROUGH THE Fine Meshes.**

## FOLDING CLOTHES DRYER

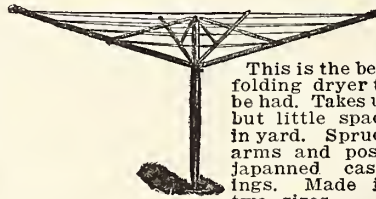

This is the best folding dryer to be had. Takes up but little space in yard. Spruce arms and post, japanned castings. Made in two sizes.

**Our Special Price.**

No. 1 Dryer carries 110-ft. line.....	\$ 9.00
No. 2 Dryer carries 150-ft. line.....	10.00

## "COTTAGE" LAWN AND GARDEN FENCE

Height, inches.	List Price, per rod.	Our Price, per rod.
24	\$2.00	\$1.35
36	3.00	2.00
48	4.00	2.70
60	5.00	3.35
72	6.00	4.00

## REMOVABLE STEEL CLOTHES-LINE POST NO. 1



Complete with base, Our Special Price, \$2.75

## “RIVAL” GARDEN PLOW COMPLETE

**PRICE,**  
\$3.75

- Extra Mould 50c
- “ Sweep 45c
- “ Large Blade 30c
- “ Bull Tongue 25c
- “ Rake 50c
- “ Wheel \$1.50
- “ Weeder 40c

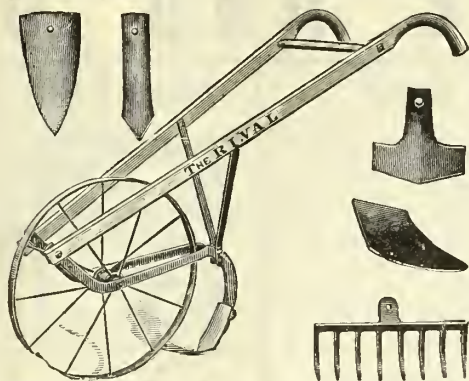

### Five-Tooth Weeder Attachment

Can be attached to any of the Garden Plows.

Price \$1.00 each.

## No. 1 Gritco Garden Plow

**PRICE,**  
\$3.75

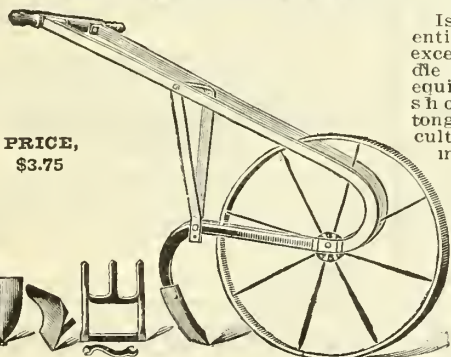

Is constructed entirely of steel, except cross handle bar, and is equipped with shovel, calftongue, weeder, cultivator and mould-board.



## No. 17 Planet Jr. Single Wheel Hoe



The No. 17 Single Wheel Hoe will do about the same variety of work as No. 12 Double but is wider. Thousands of Market Gardeners and Home Gardeners buy them every year and there are more of them in use than any other tool of this kind. Equipment: 1 Garden Plow, 2 steel cultivator teeth, 1 pair of 6-inch hoes. The No. 17 will do practically all the work mentioned under the No. 12 and will do in one day work that would require several days with the old-style hand hoe.

No. 17 Planet Jr. Single Wheel Hoe.....\$8.00

## No. 18 Planet Jr. Single Wheel Hoe

The simplest equipment we offer and the cheapest for the work it does. It hoes completely all the space between 12 and 14 inch rows. It can be so changed that it can be used to cultivate both sides of a row, while the plants are small.

No. 18 Planet Jr. Single Wheel Hoe.....\$6.00

## Fire Fly Garden Plow

This is an exceedingly useful tool to owners of small gardens. It will throw a furrow 4 to 6 inches wide and 1 to 3 inches deep, and deeper by going the second time in the same furrow. It opens furrows for manure or seed and covers them, and opens up rows for all kinds of plant-setting.

Fire Fly Garden Plow.....\$4.25

## Planet Jr. Garden Tools--Combined Seeder and Single Wheel Hoe

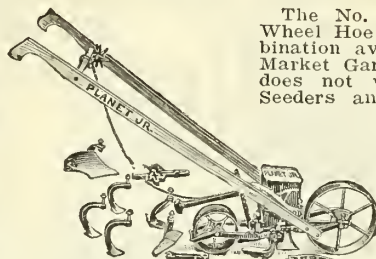

The No. 4 Combined Seeder and Wheel Hoe is the most useful combination available for the Home or Market Gardener where the acreage does not warrant having separate Seeders and separate Wheel Hoes. More of them in use than any other tool of this kind. Sows all vegetable seeds in the drill or drops in hills 4, 6, 8, 12 or 24 inches apart. Fine assortment of cultivating attachments take care of all garden work.

Capacity of seed hopper 2 1/2 quarts. Quickly changed from hill to drill seeder and from seeder to wheel hoe.

No. 4 Hill and Drill Seeder and Single Wheel Hoe Combined.....\$19.00  
No. 4-D Seeder only.....\$15.00

## No. 25 Hill and Drill Seeder, Double and Single Wheel Hoe Combined

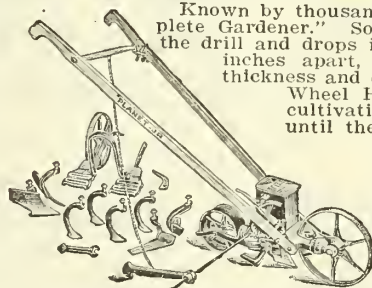

Known by thousands of users as the "Complete Gardener." Sows all vegetable seed in the drill and drops in hills 2, 6, 8, 12 and 24 inches apart, at the right depth and thickness and economically. As a Double Wheel Hoe it straddles the row, cultivating both sides at one time until the plants are 20 inches high.

When used as a Single Wheel Hoe it does very effective cultivating on one side of each row and in between rows. Cultivating attachments consist of 1 pair of plows, 1 pair of 6-inch hoes, 4 steel cultivator teeth and a pair of leaf lifters.

No. 25 Hill and Drill Seeder, Double and Single Wheel Hoe Combined.....\$22.50

## No. 12 Planet Jr. Single and Double Wheel Hoe

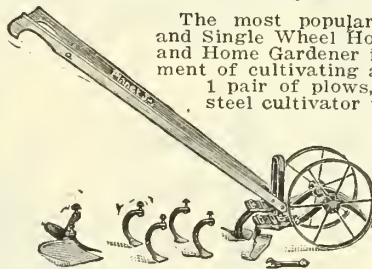

The most popular combination of Double and Single Wheel Hoe for the Market Gardener and Home Gardener in use today. The assortment of cultivating attachments consisting of 1 pair of plows, 1 pair of 6-inch hoes, 4 steel cultivator teeth, and one pair of leaf lifters enables one to do the plowing, to open furrows for seed, fertilizer, etc., to cover them, to hill up plants, and to do practically all other farming and cultivation in the garden. As the Double

Wheel Hoe the No. 12 will straddle the row, cultivating both sides at one time, until the plants are 20 inches high. Then it can be used as a Single Wheel Hoe on the sides of the rows and between and will do various kinds of cultivation in this manner. Thousands of users would not do without the No. 12 nor would you if you were to use it just once.

No. 12 Planet Jr. Double and Single Wheel Hoe.....\$11.50

## No. 11. Planet Jr. Double and Single Wheel Hoe Combined

No. 11 Planet Jr. is the most complete combined double and single wheel hoe we offer, and has the largest and most useful set of attachments. The steel frame can be set at different heights to suit any kind or depth of work and the attachments or their position can be changed in a few seconds.

Equipped with the following attachments: One pair 6-in. hoes, one pair 4 1/2-in. hoes, four steel cultivator teeth, one pair plows, two 3-tooth rakes, two 5-tooth rakes, and two leaf lifters.

No. 11 Planet Jr. Double and Single Wheel Hoe Combined.....\$14.50

## AXLE GREASE AND OILS



### POLARINE OIL

A highly efficient light medium-bodied oil for the protective lubrication of automobile and motor-boat engines. A year-round lubricant—has a near-zero cold test, and maintains its lubricating efficiency in summer heat.

1-gallon cans.....\$1.10  
5-gallon cans.....4.25  
50-gallon barrels, per gallon......65

### POLARINE OIL—HEAVY

A medium-bodied oil for lubricating automobile engines that have badly-worn pistons; heavy-duty truck engines that have pressure oiling systems; sleeve-valve engines; motorcycle engines, and certain types of tractor engines.

1-gallon cans.....\$1.15  
5-gallon cans.....4.50  
50-gallon barrels, per gallon......70

### POLARINE OIL—EXTRA HEAVY

A heavy-bodied oil for lubricating automobile engines that have badly-worn pistons; heavy-duty truck engines that have pressure oiling systems; sleeve-valve engines; motorcycle engines, and certain types of tractor engines.

1-gallon cans.....\$1.25  
5-gallon cans.....5.50  
50-gallon barrels, per gallon......95

### MICA AXLE GREASE



This is the highest quality of Axle Grease, and contains ground mica which forms a coating on the axle and makes a perfectly smooth surface. After this surface is formed you need use only half as much Mica as of any other axle grease.

Tin Box.....\$0.20  
3-lb. Pail......40  
15-lb. Pail.....1.60  
25-lb. Pail.....2.40

### GRITCO AXLE GREASE

1 lb.....\$0.15  
10 lbs.....1.20  
25 lbs.....2.25

### Polarine Transmission Lubricant B, BB and Cup Grease

A semi-fluid lubricant for transmission and differentials that are not tight enough to permit the use of an oil.

1-lb. cans.....\$0.25  
5-lb. cans.....1.00  
10-lb. cans.....1.50

### HOUSEHOLD LUBRICANT OIL

This very fine oil is put up in small oil cans, 1/2-pint sizes, very convenient to use. It is especially adapted for use on sewing machines, lawn-mowers, hinges, locks, in fact everything about the house that needs lubricating.

1/4-pint cans.....\$0.20

### Albany Grease or Hard-Oil



Every grease cup, axle cap and ball and roller bearing on your car should be filled with Albany Grease regularly. If you want a finely running car, with no danger of bearings burning out, always use Albany Grease. In the Spring, Fall and Winter use No. 0 or No. 1.

In the Summer, use No. 3 or No. X to secure best results. Albany Grease is packed in 5-10 pound cans.

5-lb. pkgs.....\$1.25  
10-lb. pkgs.....2.50

### HARVESTER OIL

This oil is put up expressly for use on farm implements, Mowers and Binders and all tools on the farm should not be neglected, and care should be used to select an oil especially adapted to the needs of such machines. Many machines have been ruined by using oils that were too heavy or too light.

We strongly recommend the use of this oil.

1-gallon cans.....\$ .85  
5-gallon cans.....4.00

### G. & T. CO.'S PERFECTION SEPARATOR OIL

This oil is put up expressly for the use of separators, and we recommend it to users of all hand machines, it being a light oil and having a very low cold test.

1-quart can.....\$0.40  
1/2-gallon can......75  
1-gallon can.....1.25  
5-gallon can.....5.00

### OIL CANS

No. 77. Straight Spout.

No. 77. Bent spout.

These oil cans are made from Cold Rolled Steel and have Clock Spring Steel Bottoms.

Price each 15c



No. 620. Copperized Steel Mowing Machine Oiler.

No. 620. Bent or Straight Spout.

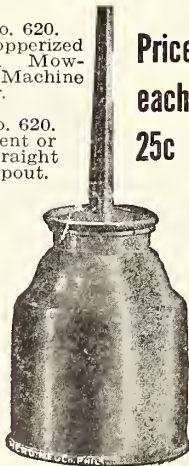

Price each 25c



### Copperized Steel Oilers

Made from high grade cold rolled steel, with guaranteed clock spring bottoms; seamless drawn steel bodies (collar included) all one piece; heavy rolled threads; bottom double seamed and rolled. Heavy electro copper plated, 1 3/8 inch wide mouth opening.

No.	Size	Lgt.	Spt.	Price
12	1/4 pt.	3 in.		15c.
13	1/2 pt.	3 in.		20c.
14	3/4 pt.	9 in.		25c.
15	1 pt.	3 in.		30c.
16	1 pt.	9 in.		35c.

No. 2800—Small round handle that will not cut fingers and on which the front and back brace swing in and out of plane with each other when fingers open and close, preventing blisters. Perfect fit for every hand. Set rigid for any size. Heavy steel nickel-plated.....20c.

### HUSKING PINS



No. 06-Y

No. 06-Y—Large mule skin finger cot protected with steel washers from wear. Mounted on cold rolled steel pin, nickel-plated, with two-compartment finger strap and buckle adjustment.....25c.

No. 7-Y—Same as 06-Y, with cot more open between the fingers. Grain leather.....25c.

No. 41—Heavy narrow steel pin nickel-plated, with extra large elk leather shield covering the ends of the fingers or laced to form a finger cot with divided finger strap to support knuckle. Sliding ring making three compartments and buckle adjustment...30c.

No. 100-Y—Cold rolled steel 4 1/2 inches, nickel-plated pin with split leather shield and double compartment, adjustable finger strap.....15c.

No. 00X—Clark's "Hickory" Pin 4 1/2 inches long, made of best cold rolled steel, with one compartment.....10c.

## Cahoon's Broadcast Seed Sower

For sowing Clover, Timothy, Millet, Oats, Wheat, Hemp, Barley, Rye, Rice, Buckwheat, etc. **Standard Seeder of the World—A Model for Accuracy and Durability—Malleable Iron Frame—Steel Hopper and Gate—Brazed Discharger.**

The breadth of the cast will be according to the weight of the seed. Wheat and Rye, -30 to 36 feet. Oats, 21 to 25 feet. Barley, 27 to 33 feet. Clover, Millet, Hungarian Seed, 20 to 24 feet. Hemp, 27 to 30 feet. Timothy, 15 to 18 feet.

**OUR SPECIAL PRICE, \$5.50.** Parcel post Weight, 8 lbs.

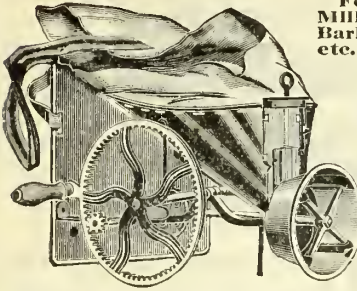

## The Original Improved Cyclone

It differs materially and very advantageously from all other Sowers in having a slope feedboard with an oblong hopper which terminates in a metal edge, on which edge oscillates a feed plate which does not allow the seed to become clogged, but makes a positive force feed and insures a uniform flow desiring a convenient,

and even distribution of seed. Anyone practical and an all-round first-class grain and grass seeder, a good, large sower that will meet the most exacting demands, we cannot recommend the **CYCLONE** too highly.

**PRICE, \$2.50.** Parcel Post Weight, 6 lbs.

## Meeker Smoothing Disc Harrow

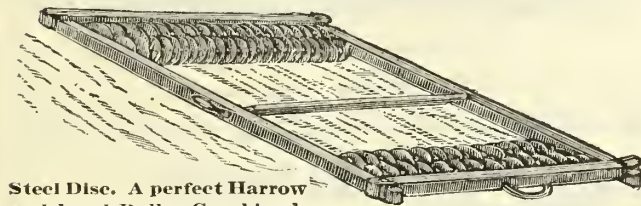

**Steel Disc. A perfect Harrow and Land Roller Combined.**

The frame measures 6 feet 8 inches by 6 feet, and has four sets of rollers, having 58 discs, 8 inches diameter on them. The discs grind all the lumps so fine that the seed must come up, leveling and leaving the land fine and smooth, and doing its work far better than the rake.

**Our Special Price, \$33.50**

### PRICES CLIMAX PLOWS.

- PONY**—Light, 1-horse, 7-in. cut, wood beam, very popular. Price with extra steel point; weight, 37 lbs., **\$5.50.**
- A. O.**—1-horse, 8-in. cut, wood beam. Price, with extra steel point; weight, 41 lbs., **\$6.00.**
- B. O.**—1-horse or light 2-horse, 9-in. cut, wood beam. Designed for either stubble or light sod, doing both kinds of work in the most satisfactory manner; very light draft. Price, with extra steel point; weight, 43 lbs., **\$7.00.**
- C. O.**—2-horse, 10-in. cut, wood beam. Price, with extra steel point; weight, 63 lbs., **\$9.00.**
- D. O.**—2-horse, 11-inch cut, wood beam; it turns its furrow slice perfectly. Price, with extra steel point; weight, 66 lbs., **\$10.30.**

## Thompson's Clover and Grass Seeder

**Sows 14 to 16 Feet Wide, Any Amount Desired Per Acre. Will Sow 20 to 25 Acres Per Day.**

This Grass Seeder is simple, without gearing, cams or intricate machinery. It cannot get out of order.



Perfection feed is attained in making it absolutely positive, yet a non-leaking carrier, when thrown out of connection. The quantity of seed to the acre is accurately shown by the index plate.



It is strong, yet weighs but 40 pounds.

No. 1—Complete Clover and Grass Seeder, the most popular style. **14-foot, \$11.00. 16-foot, \$12.00.**

No. 5—Complete Seeder, with Double Hopper, sows Red Top, Orchard Grass, Blue Grass, Lawn Grass, as well as Clover. **14-foot, \$13.00.**

### MANILA ROPE FEEDER.

### GRITCO No. 9 LAWN GRASS SEEDER.

Made especially for handling Lawn Grass Mixtures. These mixtures are generally composed of different kind of grasses, and the regular seeder will not handle them.

**No. 9, \$16.00**

## Thompson's Royal Clover and Grass Seeder

These Seeders are similar to the Thompson above, except they have **Chain Feed.**

- No. 11—14 ft., single hopper..... **\$11.00**
- No. 11—16 ft., single hopper..... **12.00**
- No. 12—14 ft., double hopper..... **13.00**

## LIGHTNING SEED SOWER

**Cheap, durable, weighs only 12 oz. Simple; no repairs.**

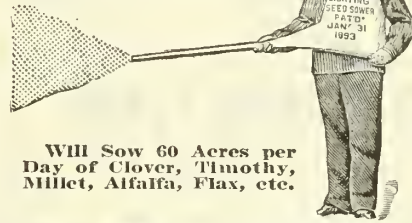

Will spread seed evenly from 30 to 40 feet. Method of sowing is by swinging tube in horizontal position from right to left which closely resembles the old method by hand. Gives control over seed on a circle of 8 feet before it leaves the tube and the wind has no chance to blow seed into bunches before it strikes the ground.

**PRICE, \$1.00.**

Parcel Post Wt., 1 lb.

## CLIMAX STEEL PLOWS

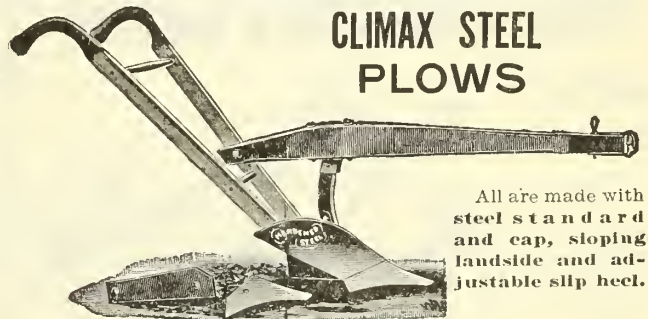

All are made with steel standard and cap, sloping landside and adjustable slip heel.

### PRICES OF EXTRAS.

	Points	Lands	Moulds	Beams without Clevis	Handles per pair, less bolts	Wood Beam Clevis
Pony.....	\$0.60	\$0.50	\$1.35	\$1.95	\$1.70	\$0.35
A. O. ....	.70	.50	1.60	1.95	1.70	.35
B. O. ....	.80	.50	1.85	2.45	1.70	.50
C. O. ....	1.00	.90	2.15	2.80	2.05	.56
D. O. ....	1.25	.90	2.60	2.80	2.05	.70

## OLIVER SULKY

## PLOW NO. 11

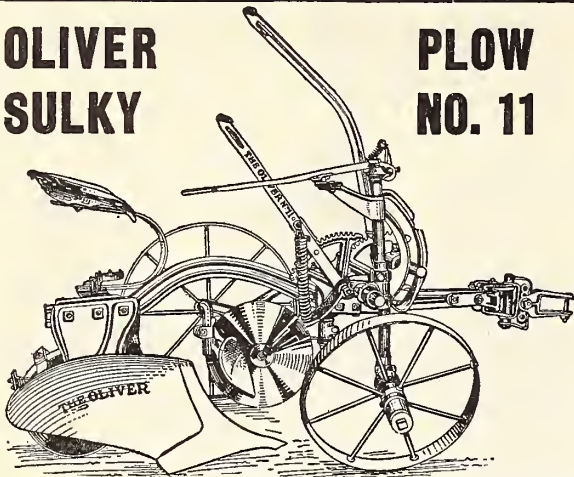

Light, durable and effective. Simple and novel device for turning. Plows the most difficult soils and does it well. Can be used with or without tongues. Depth easily regulated. Turns square corners without lifting out of the ground. Made in both right and left hand.

No. 11—Sulky Plow, Steel or Chilled Mouldboard, Chilled Share, Rolling Coulter and Jointer combined, Weed Hook, less Tongue and Neck Yoke. Our Special Price, **\$64.00.**  
No. 11—Sulky Plow, same as above, but with Jointer only. Our Special Price, **\$61.00.**

## OLIVER REVERSIBLE SULKY PLOW NO. 23A

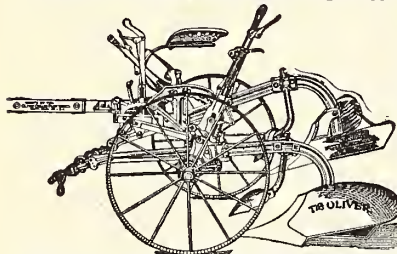

This reversible sulky plow is more easy to manipulate than any other on the market and more convenient and safe for the operator in hillside work. By means of the power lift, operated by a foot trip when riding, or a hand latch when walking, this "horse lift," which is brought into play by simply pressing forward slightly on the foot trip, the operator's work is diminished by fully one-half.

Sulky with Chilled Shares, Jointers and 2- or 3-Horse Hitch. Our Special Price, **\$100.00.**

## OLIVER NO. 1 GANG PLOW

No. 1—Gang Plow, Steel or Chilled Mouldboard, Chilled Shares, Combined Rolling Coulter, Weed Hooks, Four-horse Evener and tongue. Our Special Price, **\$115.00.**

No. 1—Gang Plow, same as above, but with Jointers only. Our Special Price, **\$113.50.**

## STEEL BEAM MIDDLE BURSTER

SHARES FOR  
MIDDLE BURSTER

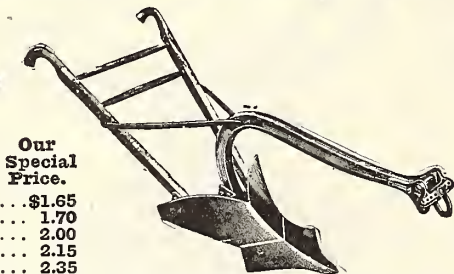

Cuts	Our Special Price.
8-inch	\$1.65
10-inch	1.70
12-inch	2.00
14-inch	2.15
16-inch	2.35

The Beam has a high throat, and wings are shaped especially for black, waxy lands. Wings and points are of high carbon steel. Points have reinforced nose. A strong, serviceable tool for two, four or six horses.

We can furnish them as follows:

Cuts	Our Special Price.
Cuts 8 inches; weight 77 pounds.	\$12.25
Cuts 10 inches; weight 82 pounds.	13.00
Cuts 12 inches; weight 87 pounds.	13.75
Cuts 14 inches; weight 83 pounds.	14.50
Cuts 16 inches; weight 98 pounds.	16.25

## Farmers' Friend Plow

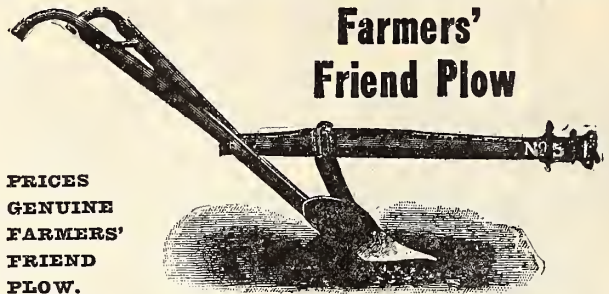

PRICES  
GENUINE  
FARMERS'  
FRIEND  
PLOW.

No. 1/2	\$5.50	No. 1 Hillside	8.25
No. 5	5.50	No. 2 Hillside	8.25
No. 7 R.	7.50	No. 3 Hillside	8.50
No. 7 L.	7.75		
No. 7 1/2 R.	7.75		
No. 8 R. and L., with clevis	9.00		
Plain Castings, per lb.	8c.	Polished Castings, lb.,	9 1/2 c.

### "BOY" DIXIE PLOW

"Boy" Dixie	\$4.90	GIRL CHAMPION PLOW	
No. X	5.85	No. "Girl"	\$6.00
No. I	7.25	No. A	6.50
No. II	8.15	No. 2	7.00
No. 2	9.50	Castings, per lb., Plain,	8 1/2 c.; Polished, 10c.
Plain Castings, per lb.	8c.		

## WHITE'S CLIPPER PLOW

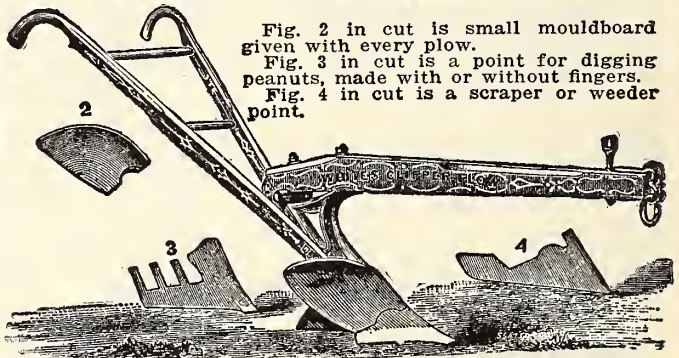

Fig. 2 in cut is small mouldboard given with every plow.

Fig. 3 in cut is a point for digging peanuts, made with or without fingers.

Fig. 4 in cut is a scraper or weeder point.

Prices Clipper Plow and Extras.

No. 1 and 2, Cast, One-Horse	\$6.25
No. 12, Cast, Two-Horse	11.00
Cast Point for Clipper Plow, per pound	.08

## Old Dominion Grub Plow



TWO-HORSE	\$15.00
THREE-HORSE	16.00
COULTERS	4.10
BOTTOMS	7.60

It is peculiarly adapted to newly cleared ground that is encumbered with growth of hazel or other bushes. All wearing parts are of best steel, and it is so strongly built that it will withstand the hardest usage. It is the favorite plow of its class. It is built in right hand only, and cuts about 7 inches.

ALL PRICES IN CATALOG SUBJECT TO CHANGE WITHOUT NOTICE.



## GENUINE OLIVER PLOWS

### AND GENUINE OLIVER REPAIRS

Don't forget to look for the **OLIVER TRADE MARK** on all **OLIVER** goods; none genuine without it.  
In ordering Oliver Chilled Plows, state whether Wood or Steel Beam, and Right or Left Hand.

#### WOOD BEAM

##### Prices.

	Retail Price.
Nos. A-1 and A-2, right hand.....	\$10.00
No. B-N, right hand.....	12.00
No. 10-N, right and left hand.....	16.00
No. 13-N, right hand.....	18.00
No. 19-N, right and left hand.....	19.50
No. 20-N, right and left hand.....	21.00
No. E-1-N, right and left hand.....	24.00
Nos. 40-N and 40-X-N, right and left hand.....	24.00
No. 40-XX, left hand.....	26.10

Note—A Clevis Wrench and an extra Share are included in prices for Plows fitted with Cast Shares, but Wheels and Jointers are not.



### OLIVER HILLSIDE PLOWS

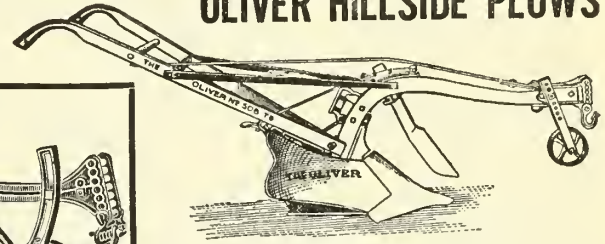

#### HILLSIDE PLOWS:

##### Prices.

No. 53½, Chilled Mouldboard, Wood Beam, Chilled Share, Two-Horse .....	\$22.50
No. 524, Iron Beam, Chilled Mouldboard, Chilled Share, Shifting Clevis, Two-Horse .....	\$23.75
No. 512, Chilled Mouldboard Chilled Share, Steel Beam, Shifting Clevis, Light, Two-Horse.....	\$27.00
No. 513, Chilled Mouldboard, Chilled Share, Steel Beam, Shifting Clevis, Heavy, Two-Horse....	\$28.00

#### STEEL BEAM

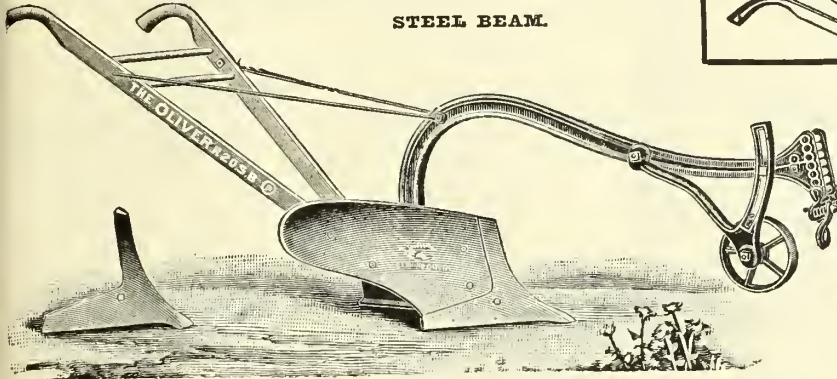

##### PRICES.

	Retail Price.
Nos. A-1 and A-2, right hand.....	\$10.50
No. B-N, right hand.....	12.75
No. 10-N, right and left hand.....	16.00
No. 13-N, right and left hand.....	18.00
No. 19-N, right and left hand.....	19.50
No. 20-N, right and left hand.....	21.00
Nos. 40-N and 40-X-N, right and left hand.....	24.00
No. 83-N, right and left hand.....	21.50
No. 84-N, right and left hand.....	24.50
No. 88-N, right and left hand.....	26.00

The two bottom tractor, the Oliver No. 132 tractor plow offers all the advantages of the two wheel construction that has become so popular within the last few years, and in addition a number of new and distinctive features of extremely practical value. In light draft, ease of control, ability to do the best possible plowing and durability the No. 132 meets the requirements of the most particular plowman and marks another pronounced development in Oliver progressive plow building.

The method of hitching the plow to the tractor is one of the extremely desirable features of this plow.

Depth and leveling adjustment are made by screws, operating with greatest ease. The screw controlling depth adjustment is accessible from the tractor seat. The plow is self-leveling, and when properly leveled at any one depth automatically maintains a level position when the depth is varied.

The No. 132 is regularly furnished equipped with the famous Oliver combined rolling coulter and joiner. Bottoms for all conditions can be supplied. The Oliver quick detachable share, making possible share changes in a few seconds' time and with minimum effort, is regularly furnished.

The draw bar of the Oliver No. 132 tractor plow can be adjusted to the draw bar needs of all standard tractors so that the plow and

### OLIVER UNIVERSAL LIGHT IMPROVED TRACTOR PLOWS

No. 132—TWO BOTTOM CHILLED PLOW \$105.00

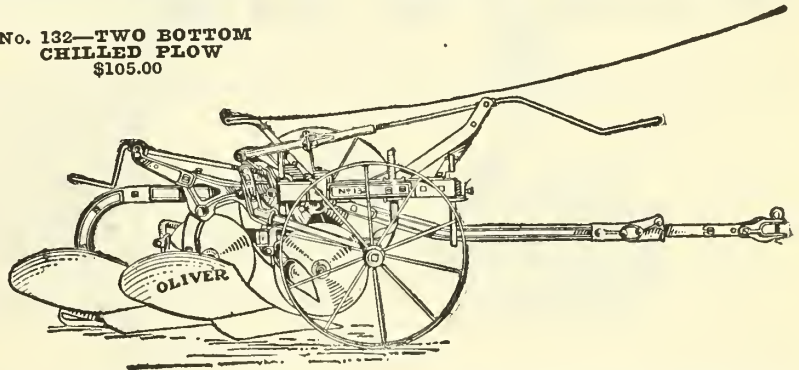

tractor operate in approximately perfect line of draft, and accordingly at greatest efficiency. Vertical adjustments can also be made through the draw bar guide. All adjustments are made with ease because of the simplicity of construction.



## WIARD PLOWS AND REPAIRS

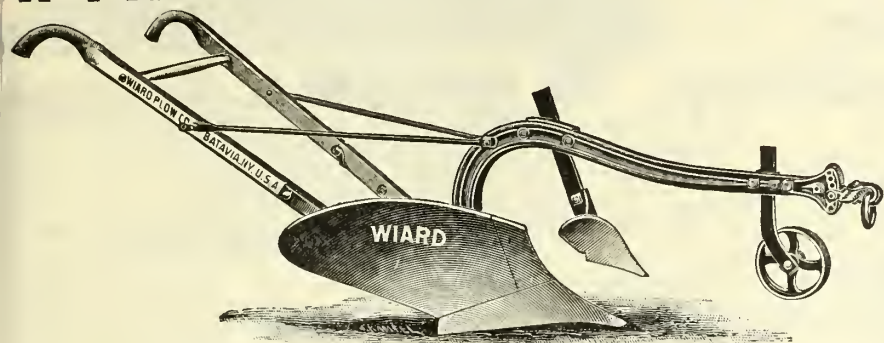

### "WIARD" SWIVEL OR HILL-SIDE PLOW

- No. 127—Light 2-Horse with Cast Mold, Steel Beam.....\$19.00
- No. 120—Medium 2-Horse with Cast Mold, Steel Beam..... 26.00
- No. 126—Regular 2-Horse with Cast Mold, Steel Beam..... 27.00
- No. 15X—Light 2-Horse, with Cast Moldboard, Cast Beam..... 22.50
- No. 126X—2-Horse, with Cast Moldboard, Cast Beam..... 24.00

PRICES WIARD STEEL BEAM PLOWS AND EXTRAS	Capacity Inches	Weight Lbs.	Price of Plow.	Plain Shares	Cutter Shares	Plain Slip Shares	Slip Nose	Landslides	Mould Board	Steel Beam	Handles Pair, Complete	Standards
No. 210—R. H. 1-Horse.....	4 1/2 x 8	60	\$9.25	\$.35				\$.75	\$2.00	\$4.50	\$2.25	\$2.25
No. 212—R. H. 1-Horse.....	4 1/2 x 9	71	10.25	.45				.75	2.25	4.50	2.25	2.50
No. 215—R. H. 1 or 2-Horse.....	5 1/2 x 11	93	15.00	.50				1.00	3.25		2.25	2.50
No. 218—R. H. 2-Horse.....	6 x 11	99	17.00	.70				1.25	4.20	5.50	2.50	3.25
No. 219—R. H. 2-Horse.....	6 1/2 x 12	110	19.00	.85		\$1.00	.20	1.40	4.50	6.00	2.50	3.50
No. 220—R. H. 2-Horse.....	7 x 13	120	21.00	.85		\$1.00	.20	1.40	5.00	6.00	2.50	3.50
No. 420—L. H. ....	9 to 13		21.00	.85		\$1.00	.20	1.10	4.50	6.00	2.50	3.50
No. 440—L. H. ....	11 to 15		24.00	.90				1.50	5.00	7.00	2.50	3.75
No. 220—R. H. ....	9 to 13		21.00	.85		1.00	.20	1.40	5.00	6.00	2.50	3.50
No. 240—R. H. ....	11 to 15		24.00	.90		1.10	.20	1.50	5.00	7.00	2.50	3.75
No. 546—L. H. 2 or 3-Horse.....	11 to 15	130	21.50	.85	1.00	1.00	.20	1.60	5.00	6.00	2.50	4.00
No. 44—R. H. 2 or 3-Horse.....	11 to 15	130	21.50	.85	1.00	1.00	.20	1.25	5.00	6.00	2.50	4.00
No. 45—R. H. 3-Horse.....	12 to 17	150	25.00	.95	1.10	1.10	.20	1.25	5.50	6.00	2.50	4.50
No. 103—L. H. 2-Horse.....	9 to 13	120	19.75	.85	1.00	1.00	.20	1.25	4.50	6.00	2.50	4.00
No. 104—L. H. 3-Horse.....	11 to 15	130	21.50	.85	1.00	1.00	.20	1.25	5.00	6.00	2.50	4.00
No. 106—L. H. 3-Horse.....	12 to 17	150	25.00	.95	1.10	1.10	.20	1.25	5.50	6.00	2.50	4.50
No. 80—L. H. 2 or 3-Horse.....	11 to 15	132	22.00	.85	1.00	1.00	.20	1.00	5.00	5.50	2.50	4.50
No. 81—L. H. 2-Horse.....	10 to 14	128	21.00	.85	1.00	1.00	.20	1.00	4.50	5.50	2.50	4.50
No. 90—R. H. 2 or 3-Horse.....	11 to 15	132	22.00	.85	1.00	1.00	.20	1.00	5.00	5.50	2.50	4.50
No. 91—R. H. 2-Horse.....	10 to 14	128	21.00	.85	1.00	1.00	.20	1.00	4.50	5.50	2.50	4.50

Wheels with Standards, \$2.20; Joiners or Coulters with Holder and Attachment, \$4.75; Bolts for Shares, Moulds, Lands and Jointer Points, 6c. each. Wheel Standard Bolts. Each, 15c.

- No. 65—Iron Beam Contractor Plow, R. H., Cast Points, with Clevis and Shoe.....\$33.00; Cast Point, \$1.15
- No. 65—Iron Beam Contractor Plow, R. H., Steel Points, with Clevis and Shoe..... 38.50; Steel Point, 6.50
- No. 67—Iron Beam Contractor Plow, R. H., Steel Points, with Clevis and Shoe..... 43.50; Steel Point, 7.75
- No. 67—Steel Beam Contractor Plow, R. H., Steel Points, with Clevis and Shoe..... 60.50; Steel Point, 7.75
- No. 69—Steel Beam Contractor Plow, R. H., Steel Points, with Clevis and Shoe..... 69.00; Steel Point, 8.50

### "A. W. R." One Hoss Riding Cultivator

The A. W. R. Cultivator has been thoroughly tried out under varying farm conditions since 1918, and has proven its worth. There are many farms upon which there is too large an acreage of row crops to be handled by a walking cultivator, but where two-horse machines will not work satisfactorily.

While no expense has been spared to make this tool right, the price is very reasonable, especially when you consider that it will do practically the same amount of work as the two-horse machine—do it easier, cheaper and better. The wheels and cultivator frame are adjustable for width and the depth is easily controlled by a removable key pin.

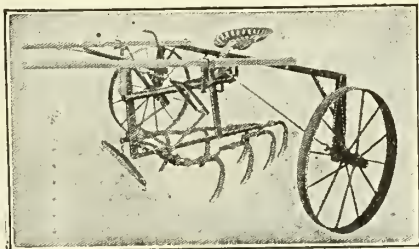

- It will cultivate corn up to three or even four feet high. For those who seed to grass and clover at the last cultivation of corn, this cultivator leaves the ground in perfect condition.
- Price of Cultivator.....\$45.00
- Price of Weeder Attachment..... 15.00

### "MOON" ROLLING COULTER

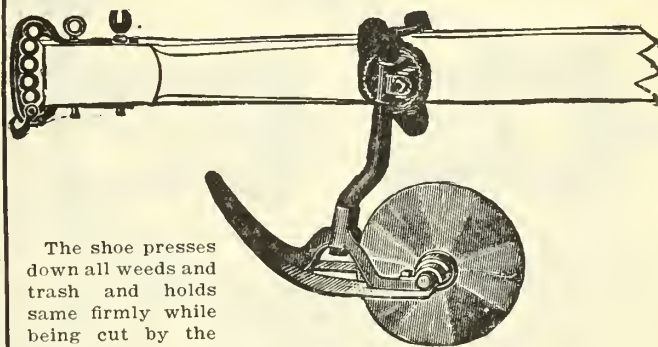

The shoe presses down all weeds and trash and holds same firmly while being cut by the coulters.

- No. 1—8-inch disk.....\$5.00
- No. 2—10-inch disk..... 6.00
- No. 3—12-inch disk..... 7.00

### Wood Single, Double and Tripletrees

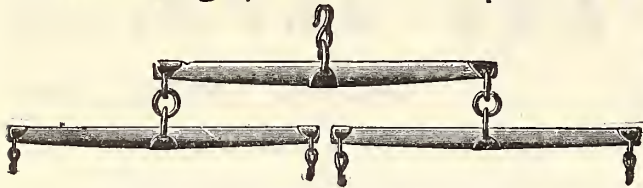

26-in. Southern.....	\$0.55	36-in. So. Doubletrees..	\$1.25
28-in. Extra Nailed....	.65	36-in. Hvy. Doubletrees..	1.50
28-in. Ex. Nailed, 3 Hks..	.75	40-in. Hvy. Doubletrees..	1.75
30-in. Hvy. Singletrees..	.90	Extra Hvy. Tripletrees..	3.50
32-in. Hvy. Singletrees..	1.00	Singletrees, less irons..	.40
34-in. Hvy. Singletrees..	1.10	Doubletrees, less irons..	.60
Wagon Singletrees, 36	inches.....		\$1.50

### WOOD NECK YOKE

No. 6—40-inch....	\$1.50	42-inch....	\$1.60	48-inch..	\$2.25
<b>WAGON, SINGLE AND DOUBLETREES.</b>					
Wagon Singletrees, No. 9 1/2, each.....	\$1.50				
Wagon Doubletrees, No. 12 1/2, each.....	1.75				
Doubletrees and Singletrees, with neck yoke for low-down wagon trucks, per set.....	\$5.75				

### STEEL SINGLE AND DOUBLETREES

**PRESSED STEEL THREE-HORSE HITCH OR TRIPLETREE**

Size 1— Evenser, 40 inches. Equalizer, 28 inches. Singletrees, 26 or 28 inches.	Size 2— Evenser, 45 inches. Equalizer, 32 inches. Singletrees, 30 inches.
--	--

Retail, Single Set....	\$10.50	Retail, Single Set....	\$13.00
------------------------	---------	------------------------	---------

**U SINGLE, DOUBLE AND TRIPLETREES**

Prices: Singletrees, with Malleable Hooks, 24-inch, 75c.; 26-inch, 80c.; 28-inch, 85c.; 30-inch, \$1.10. Doubletrees, with Hooks, 36-inch, \$1.25. Steel Tripletrees Set, complete per set of 6 pieces, \$6.00.

### Improved Eureka Three-Horse Equalizer

**RIGHT HAND ONLY.**  
This Equalizer, while simple in construction, is strong and durable; is perfect in equalization, and absolutely removes all side draft. Can be changed very quickly from a three-horse to a doubletree by removing the long bar. Price, \$9.50

### SET OF WELDED CLIPS

- CLIPS FOR DOUBLETREES.**  
No. 77—Southern; one 3/4-inch Center Clip and Hook, with hook and two 1/2-inch Clips. Set, 75c.  
No. 76—Pennsylvania; one 3/4-inch Center Clip and Hook, with 3/4-inch hook and two 9-16-inch End Clips. Set, 90c.
- CLIPS FOR SINGLETREES.**  
No. 75—One Center 1/2-inch Clip, and two 3/8-inch End Clips; used on 28-inch Singletrees. Set, 50c.  
No. 74—One Center 9/16-inch Clip, and two 7/16-inch End Clips. Set, 65c.  
No. 73—One Center 5/8-inch Clip, and two 7/16-inch End Clips; used on 34 and 36-inch heavy Singletrees. Set, 80c.  
No. 72—One Center 3/4-inch Clip, two 1/2-inch End Clips. Set, 90c.  
Clips for Tripletrees—Three Pieces. Per Set, \$1.50.

### Malleable Clevises

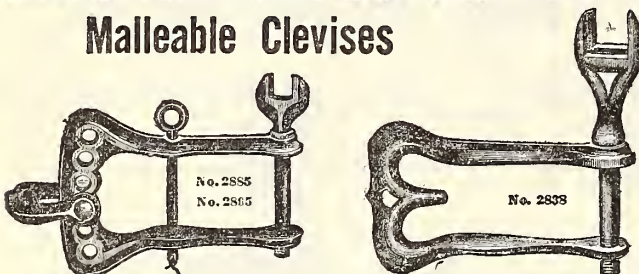

- No. 2885.—2 1/4-in. beam; 2 7/8-in. from center of wrench to center of pin; 6 3/4-in. extreme length; 6 holes; shackle and pin. For use on No. 5 F. F. and similar cast plows. List price, doz., \$6.00. Retail price, each, 35c.
- No. 2895.—2 1/2-in. beam; 3 3/8-in. from center of wrench to center of pin; 7 1/2-in. extreme length; 6 holes; shackle and pin. For use on No. 7 F. F. and similar cast plows. List price, doz., \$8.00. Retail price, each, 45c.
- No. 2854.—2-in. beam; 5 3/4-in. extreme length; 3-in. from center of wrench to end of beam. Patent wrench. For use on Girl Champion and similar cast plows. List price, doz., \$3.50. Retail price, each, 20c.
- No. 2847.—2-in. beam; 5 5/8-in. extreme length; 3-in. from center of wrench to end of beam. Patent wrench. For use on "Boy" Dixie and similar cast plows. List price, doz., \$3.50. Retail price, each, 20c.
- No. 2806 B—End Clevis.—3/4-in. inside measure; 3-in. extreme length. List price, doz., \$2.00. Retail price, each, 10c.
- No. 2800—Flow Link.—3-in. long, 2 1/2-in. wide. List price, doz., \$2.00. Retail price, each, 10c.



### PLOW HANDLES--Not Finished

1 1/2 x 2 inches, 5 feet long, per pair.....	\$0.75
1 1/2 x 2 1/4 inches, 5 feet long, per pair.....	.80
1 1/2 x 2 1/4 inches, 6 feet long, per pair.....	1.00
1 1/2 x 2 3/8 inches, 5 feet long, per pair.....	1.20
1 1/2 x 2 3/8 inches, 5 1/2 feet long, per pair.....	1.30
1 1/2 x 2 inches, Side Bend, per pair.....	.80

### Repairs For Syracuse Plows

Nos.	Wood Beam Chilled Plows.	Shares.	Land.	Moulds.	Beams.	Standards.	Shins.	Slip shares.	Slip points.
52	1 Horse R. H. only	\$.50	\$1.10	\$3.35	\$3.25	\$2.75	...	...	...
56	Reg. 2 " "	.80	1.55	3.00	4.75	4.00	.70	1.00	.30
57	2 or 3 H " "	.85	1.70	5.50	4.75	4.40	.75	1.05	.30
58	2 Horse L. H.	.75	1.45	4.75	4.50	3.85	...	.95	.30
59	2 " " " "	.80	1.55	5.00	4.75	4.00	...	1.00	.30
97	2 or 3 H " "	.85	1.50	5.50	4.75	4.40	...	1.05	.30
501	" " " "	.90	1.50	5.50	4.15	4.00	...	1.10	.30
502	" " " "	.85	1.40	5.00	4.15	3.75	...	1.05	.30
503	" " " "	.85	1.40	4.50	4.15	3.60	...	1.05	.30
601	" " " " R. H. only	.90	1.50	5.50	4.15	4.00	...	1.10	.30
602	" " " " " "	.85	1.50	5.00	4.15	3.75	...	1.05	.30
603	" " " " " "	.85	1.40	4.50	4.15	3.60	...	1.05	.30

### Repairs For Syracuse Contractors' Plows

Nos.	For Contractors' Plows, see page 121	Steel shares.	Moulds.	Beams.	Standards.	Shins.
99	.....	\$9.50	\$6.00	\$16.50	\$19.25	\$1.10
98	.....	6.00	.....	23.50	.....	.....
1	Heavy Cast.....	1.10	5.75	13.50	.....	.....

### Extras for Iron Beams Syracuse Plows

Nos.	No. Horse.	Common shares.	Cutter shares.	Cast lands.	Moulds chilled.	Beams.	Slip shares	Slip points
3-78	R. H. only 2 Horse	\$.80	\$1.00	\$1.10	\$5.00	\$8.00	\$1.00	\$.20
2-78	" " 2 " "	.85	1.05	1.25	5.50	8.75	1.05	.30
1-78	" " 2 " "	.90	1.10	1.30	5.75	9.50	1.10	.30
10-78	" " 2 " "	1.05	1.25	1.45	6.15	12.00	.....	.....
20-78	L. H. only 2 " "	.90	1.10	1.25	5.75	9.50	1.10	.30
30-78	" " 3 " "	1.05	1.25	1.45	6.25	12.00	1.25	.30
15	R. H. only 3 " "	1.00	1.25	2.00	6.25	7.00	.....	.....
35	L. H. only 3 " "	1.10	1.30	2.00	6.75	7.00	.....	.....

Jointer Points for any of above Syracuse Plows, 35c. Syracuse Base Bolts, 5c.

### Repairs For Chattanooga Plows

Nos.	No. Horse.	Plain Shares.	Cutter Shares.	Slip Nose Shares.	Slips.	Landslides.	Mould-boards.	Beams.	Handles with Braces, Set.	Standards.
45	2-Horse, W. B.	.85	1.05	.20	1.50	4.50	4.25	3.25	4.00	
45	2-Horse, S. B.	.85	1.05	.20	1.50	4.50	6.50	3.25	4.00	
46	3-Horse, W. B.	.40	1.10	.20	1.50	4.75	4.25	3.25	4.30	
46	3-Horse, S. B.	.90	1.10	.20	1.50	4.75	7.50	3.25	4.30	
62	1-Horse, W. B.	.40	.50	.10	.70	3.00	3.50	2.50	2.25	
62	1-Horse, S. B.	.40	.50	.10	.70	3.00	5.00	2.50	2.25	
72	1-Horse, S. B.	.45	.55	.10	.70	3.10	5.00	2.50	2.25	
63	2-Horse, S. B.	.60	.75	.15	1.10	3.00	5.00	2.70	3.00	
64	2-Horse, S. B.	.75	.90	.15	1.25	4.00	6.50	3.25	3.75	
65	2-Horse, S. B.	.85	1.05	.20	1.50	4.50	6.50	3.25	4.00	
66	2-Horse, S. B.	.90	1.10	.20	1.50	4.75	7.50	3.25	4.35	

Rolling Coulters, complete, \$5.25; Wheels, complete, \$1.75; Jointers, complete, \$4.00; Bolts for Shares, Landsides, Moulds, 4c.; Rear Beam Bolts on 1-Horse Plows, 10c. All other Beam Bolts, 15c.

Shovel Plow Clevises, Doz.....	Ret. Price. \$7.20	Retail Price. Each, 40c.
Cultivator Clevises, Doz.....	4.80	Each, 25c.

## HASLUP WHEEL SCRAPERS

These scrapers are very popular with the contractor trade on account of their splendid construction and convenience. The wood wheels are made of thoroughly seasoned stock and are very strong. Metal wheels can be furnished on order. Tongues, best quality hardwood, heavily ironed, with double steel draft bars.

**Size of Bowl.**

		in.	in.	in.	in.	in.	
No. 1	9	Cu. ft.	36	36	12	36	
No. 2	13	Cu. ft.	37	38	13½	40	
No. 2½	14½	Cu. ft.	41	38	14	44	
No. 3	17	Cu. ft.	41	44	16	44	
No. 1	— Weight, 450 lbs.					Price,	\$62.50
No. 2	— Weight, 600 lbs.					Price,	\$1.75
No. 2½	— With Snatch Rod, weight 675 lbs.					Price,	\$6.50
No. 3	— With Snatch Rod, weight 750 lbs.					Price,	\$9.00

Wood Doubletrees and Neck Yoke, \$6.00 extra.

Snatch Rod regularly furnished with No. 2½ and No. 3.

Square steel axles are used, arched high, spindles turned and polished.

### The No. 24 Iron Beam, Right Hand Contractors' Plow

Strong, heavy. Furnished with either cast or steel cutter shares; with draft iron running from clevis to beam. With wheel jointer or hanging coulters as desired. R. H. only.

Oliver's Latest Pattern, Road and Grading Plow, No. 24. IRON BEAM.

Price, Plain, \$32.00 with Wheel, \$34.75  
Above prices include one extra Share.

### Haslup Round

### Back, Solid Pressed Drag Scrape

**Prices with 2 Steel Runners**

Size.	Capacity.	Weight.	Price.
No. 1	7 Cu. ft.	100 lbs.	\$12.00
No. 2	5 Cu. ft.	90 lbs.	11.50
No. 3	3½ Cu. ft.	80 lbs.	11.00

For extra Bottom Plate add 75c.

**LIGHT DRAG SCRAPER**

Size.	Capacity.	Weight.	Price.
No. 1L	7 Cu. ft.	90 lbs.	\$11.00
No. 2L	5 Cu. ft.	80 lbs.	10.50
No. 3L	3½ Cu. ft.	70 lbs.	10.00

REPAIRS FOR CONTRACTORS' PLOWS,  
Price List on Page 120.

### OLIVER CONTRACTORS' PLOWS



No. 1 Oliver Wood Beam Road and Grading Plow all steel with standing Coulters, Gauge iron.  
Price, \$67.50.



No. 25 Oliver Iron Beam Pavement Plow with Gauge Iron.  
Price, \$46.75.

### "SSS" FRESNO SCRAPER

Contractors that are not acquainted with the "SSS" FRESNO SCRAPER are overlooking one of the best tools ever designed for moving earth rapidly and cheaply.

With this scraper dirt can be carried any distance and dumped

in bulk, or it can be scattered in layers from one to twelve inches deep simply by adjusting two tail nuts on the cross bar; no wrench required.

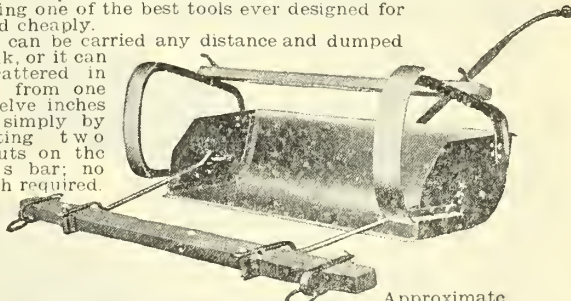

THREE SIZES	Width.	Approximate Weight.	Price.
No. 1—4-Horse.....	5 feet	300 lbs.	\$34.50
No. 2—2 or 4-Horse.....	4 feet	275 lbs.	31.50
No. 3—2-Horse.....	3½ feet	250 lbs.	30.00

### Syracuse Contractors' Plow No. 1

One of the best two-four horse contractors' plows. A great favorite.

Hard iron wearing parts. Extra heavy beam, share and strip, steel wheel standard. Turn furrow 5 to 9 inches deep, 12 to 15 inches wide. For general grading purposes. Two to four-horse. Weights 185 lbs. with wheel, \$32.00

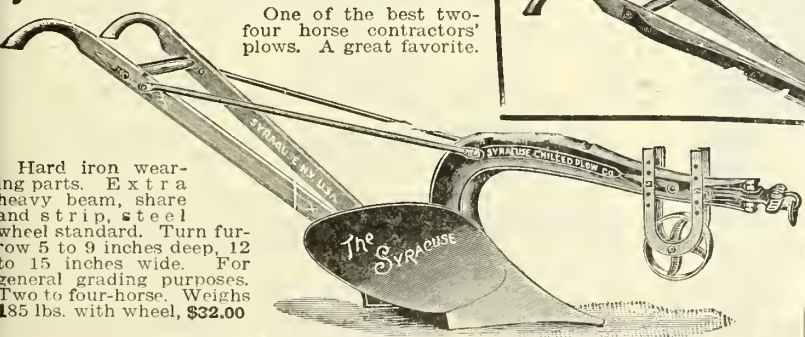

### Syracuse Pavement Plow No. 98

Adjustable and double-bar steel point. Adjustable shoe in place of wheel. Loop handle wear irons. Very strong. Specially adapted

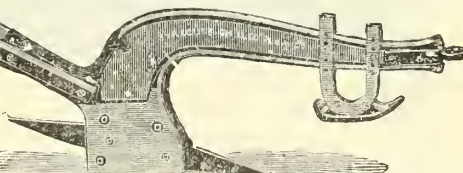

for tearing cobblestones and macadam pavements. Four or six-horse. Weight, 265 lbs. Without extra point **Price, \$40.00**

**SYRACUSE CONTRACTORS' PLOW No. 99**  
Four to Eight Horses. Weight, with Shoe, 310 lbs. Without extra Share **\$70.00**

## McDONALD STEEL PITLESS WAGON SCALE

**ECONOMY AND SIMPLICITY**  
 No pit is required for the "McDonald Pitless." The working parts are above the base of the steel and frames. As compared with the total cost of the scales that require a pit, you save in the purchase of the "McDonald Pitless" the services of a carpenter, experienced mechanic, 700 to 900 feet of heavy timber, an expensive and troublesome pit, the expense of replacing heavy timbers every few years, and 70 per cent. of the cost of the foundation. The first cost of the "McDonald Pitless" is practically the final cost.

**SOLID STEEL CHANNEL FRAME**  
 Frame is made of solid channel steel, which is connected at each corner with heavy steel corner irons and machine bolts, which gives a heavy, substantial, rigid frame.

**SOLID STEEL JOISTS**  
 The "McDonald Pitless" is equipped with solid I-beams that will support several hundred pounds in excess of the capacity of the scale.

8 x 14, 2 Joist, 6 Ton Scale, Double Beam.....	.....	\$150.00
8 x 16, 3 Joist, 6 Ton Scale, Double Beam.....	.....	200.00
8 x 16, 3 Joist, 6 Ton Motor Truck Scale, Triple Beam.....	.....	205.00
10 1/2 x 18, 4 Joist, 10 Ton Motor Truck Scale, Triple Beam, F. O. B., Baltimore.....	.....	500.00
10 1/2 x 18, 4 Joist, 10 Ton Motor Truck Scale, Triple Beam, F. O. B., Factory.....	.....	425.00

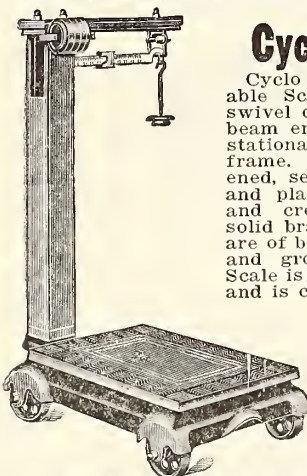
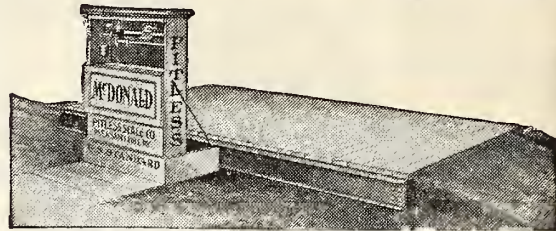

### Cyclo Platform Scale

Cyclo Ball-Bearing Swivel Wheel Portable Scales are constructed with two swivel or castor wheels at the front or beam end of frame, combined with two stationary wheels at the rear end of frame. This Scale is fitted with hardened, self-adjusting lever bearing loops and platform bearing feet. The beam and crescent-shaped sliding poise of solid brass, highly polished. All pivots are of best tool steel, carefully tempered and ground to a knife's edge. Each Scale is sealed to U. S. Standard weights, and is carefully packed.

- No. 87 - Capacity 600 lbs. Price, \$28.50.
- No. 88 - Capacity 800 lbs. Price, \$30.00.
- No. 89 - Capacity 1,000 lbs. Price, \$33.50.

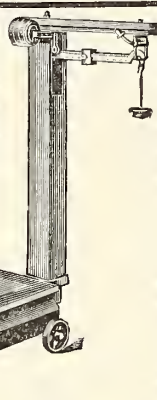

### Gritco Platform Scale

This is the best cheap grade Portable Platform Scale on the market. It is intended for use where a Scale is only used occasionally, and is not subject to hard usage. The iron parts are finished in black japan, and the wood parts are painted blue, and are well finished.

Each Scale is sealed to U. S. Standard weights, and is carefully packed.

No. 1124 Capacity 1,000 lbs.....	Price, \$26.00
No. 1128 Capacity 500 lbs.....	Price, \$22.00

### Gritco Broadcast Lime Distributor

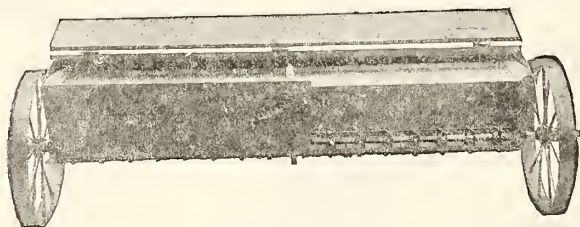

**8 FOOT  
 TWO HORSE - \$55.00**

### Crystal Metal Farm Bells

Prices, including hangings complete. Bronzed.

No.	Wgt. of Bell	Diam. of Bell	Re-com. tail Price
1.	40 lbs.	15 in.	\$4.00
2.	50 lbs.	17 in.	5.00
3.	75 lbs.	19 in.	7.50
4.	100 lbs.	21 in.	10.00

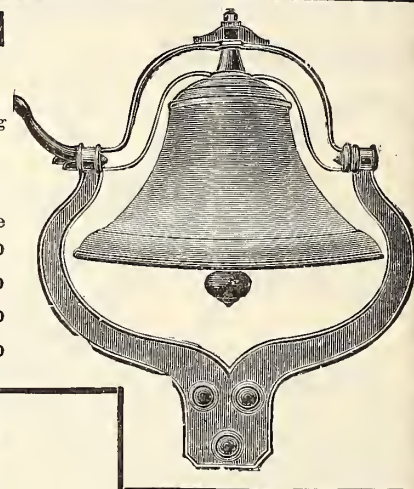

### Steel Alloy Church and School Bells

Cast from an alloy of cast steel and crystal metal, and can be relied on under all circumstances and in all seasons.

Tolling hammer not furnished with No. 22. When furnished with No. 24; Retail, \$6.00. Prices on above named are for Complete Bells, and include wood sills and iron Wheels.

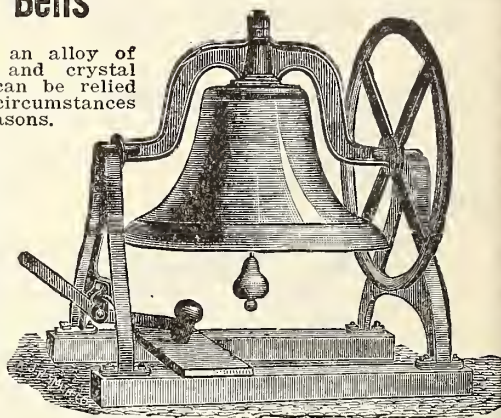

No.	Diam.	Weight, Bell only.	(MOUNTED) Wt. complete.	Retail Price.
20	20 in.	110 pounds	165 pounds	\$20.00
22	22 in.	122 pounds	205 pounds	22.50
24	24 in.	153 pounds	250 pounds	27.50

This distributor is designed for broadcasting lime and ashes, and it will distribute in drills or rows when supplied with an extra feed plate especially punched according to the width of the row.

The amount of lime this machine will sow to the acre depends somewhat on its weight per bushel, as well as its condition, but the 13 notches of feed opening average to spread from 250 lbs. per acre at the lowest notch to 3550 lbs. at the highest notch.

Special features make this distributor lead all machines of its kind and work where others fail.

## O. K. CHAMPION POTATO PLANTER No. 25

Has a seed-dropping device consisting of the endless-cup system, one which is recognized as the most accurate. The seed is picked up and deposited on a dial plate, which is equipped with pockets for the reception of the seed pieces, where any correction necessary can be made, insuring absolutely one piece to every hill. Tests have proven that this machine will plant absolutely 100 per cent. correct. The cups are

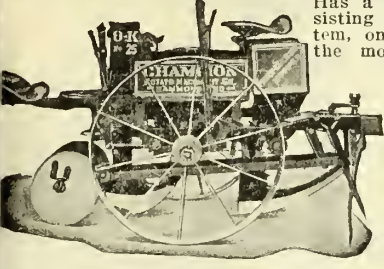

adjustable and permit perfect planting for large or small pieces. The distances of dropping are 12, 15 and 18 inches. This machine can also be converted into an automatic planter. This planter embodies all requisites necessary to make it a durable machine, and in construction it is very simple. Weighs with fertilizer attachment about 350 pounds.  
**No. 25 Planter—List Price, \$215.00. Our Special Price, \$125.00**  
**No. 22 Planter—List Price, 160.00. Our Special Price, 100.00**

## Success Junior Potato Digger

PRICE \$13.50

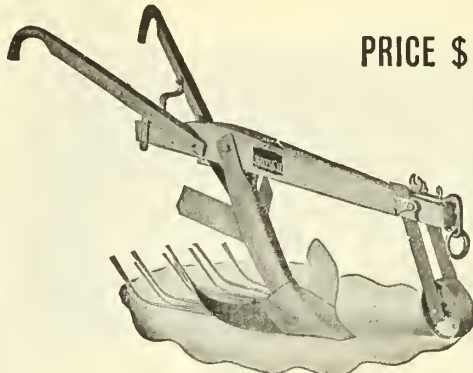

The **SUCCESS JUNIOR POTATO DIGGER** does cleaner digging in one trip over the row, and the tubers are left in better condition for picking up. It greatly reduces the labor, and saves many potatoes.

## O. K. CHAMPION POTATO DIGGER

The **O. K. Champion Digger** with its many superior features commends itself to the careful buyer. It has stood the test of years and has many times proven to be the victor in the potato field over all competitors.

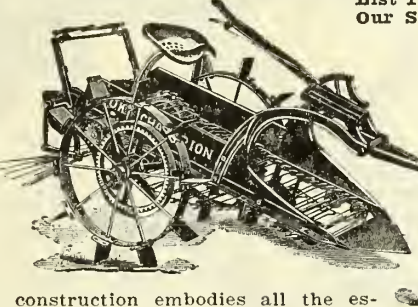

List Price, \$190.00.  
 Our Special Price, \$110.00.

Weight, 600 Pounds.

Send for Special Catalog.

Its construction embodies all the essential features which make it absolutely reliable. It is built with a view to simplicity, going away with all unnecessary wearing parts, which accounts for its easy draught. Two horses will do the work with ease. There is no chain drive to cause friction and wear; only two gear wheels are employed on the entire machine.

The shovel is 20 inches wide, scooping up that width of ground and potatoes, depositing them on the elevator separating apron, whose links are alternately raised and lowered.

**No. 8 Heavier Digger.**  
**List, \$205.00. Retail, \$117.50**

## NISCO TRANSPLANTER

A Transplanter of unusual merit, that will set the plants right. Adjustable to every condition. **Our Special Price, \$110.00.**

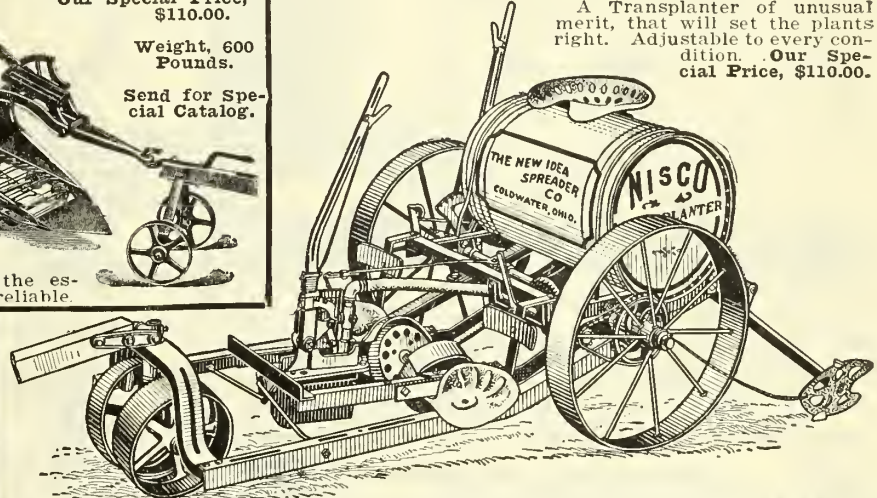

## O. K. Champion Potato Cutter

**OUR SPECIAL PRICE, \$7.50**  
**LIST PRICE, \$12.00.**

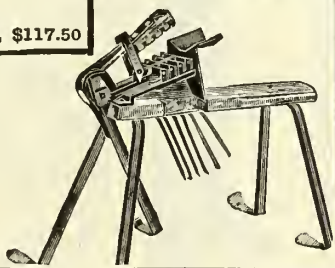

## Gem Seed Potato Cutter

The construction of the **Gem Seed Potato Cutter** is very simple, and is built for accuracy as well as convenience. It is strong and durable; the knives are of good quality steel and are fitted to grooves in frame, making them easy to remove if necessary. It will cut any size potato in pieces uniform in size, thereby insuring more accurate planting when power planter is used. Size, 24 inches long, 8 inches wide. Weight, 8 pounds.

**List Price, \$3.00. OUR SPECIAL PRICE, \$5.00**

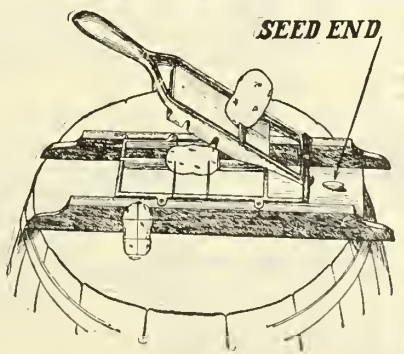

## Master's Rapid Plant Setter

All kinds of Plants, such as Cabbage, Tobacco, Tomatoes, Cauliflower, Strawberries, Sweet Potatoes, Sugar Beets, etc.. The only Hand Mechanical Plant Setter on the market; is built on scientific principles throughout. Its conical jaws are made of heavy sheet steel and the main body or water reservoir and plant tube of heavy tinned plate. The water valve is of brass with rubber packing. The valve rod and trip spring are of steel wire; thumb button and other fittings are also of brass. The machine is well put together with rivets and solder and should last for years.

Price, each ..... \$6.00

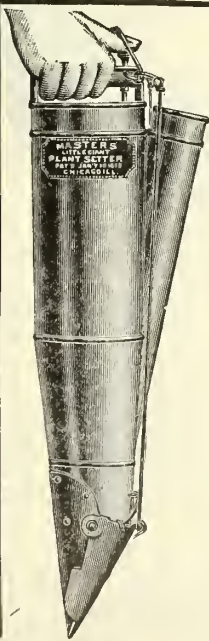

## Acme Tubular Hand Potato Planter

**THE LIGHTEST TUBULAR PLANTER MADE.**

Its spring-closed jaws are especially designed to enter the sod easily, yet open wide enough to drop the largest seed. The dropping lever or dump is adjustable for any depth of planting. The conveyor tube is galvanized iron.

**OUR SPECIAL PRICE... \$2.00**

**Directions for Using.**—Walk erect, plunge planter into the soil, press forward as you withdraw it; seed is left in moist soil, not dry, as is usually the case when seed is dropped by one man and left to be covered by another.

## Bickford & Hoffman Grain Drill

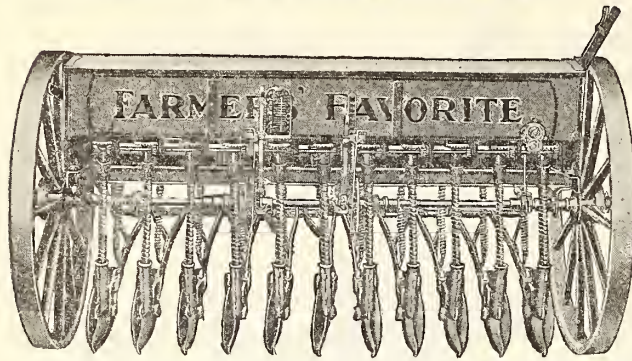

Both the grain and fertilizer are positive force feeds, and will sow with absolute regularity any kind of grain, or fertilizer in good condition. The grass seeder is also a force feed, and can be used either in front or rear of the hoes; also quantity can be changed to any amount necessary. It is fastened on the frame, and very low down, thus preventing the wind from blowing the seed away before reaching the ground. The fertilizer feed can be stopped or started at any time while the drill is in motion, which makes it convenient in case the operator does not wish to sow fertilizer while going over the ground.

8-Hoe Pin.....	\$140.35	10-Hoe Spring.....	\$165.80
9-Hoe Pin.....	147.60	11-Hoe Spring.....	173.65
10-Hoe Pin.....	159.75	8-Disk Drill.....	150.05
11-Hoe Pin.....	167.50	9-Disk Drill.....	158.50
8-Hoe Spring.....	145.20	10-Disk Drill.....	171.85
9-Hoe Spring.....	153.05	11-Disk Drill.....	180.20

### GRAIN DRILL TUBES



Plain Top.

**IN ORDERING TUBES** it is always best to send an old tube as a sample. If that cannot be done, be sure to state name of Drill, the kind of Tube, whether ring flange or plain top, or special bell-shaped top with straps, and by all means the length and diameter at top and bottom.

Plain Tubes, each.....	30c.
Bell Top Tubes, with strap, each.....	60c.

### GRAIN DRILL POINTS

We are one of the largest distributors of **GRAIN DRILL POINTS AND TUBES**

in the Country.

For All the Leading Grain Drills.

**IN ORDERING POINTS**, either send an old one or give name of Drill, length of point, and be sure to give distance from center of hole to end of point. It is always best, if possible, to send an old sample.

Price, Points, each.....	15c.
--------------------------	------

### PERFECTION CORN CRADER

**NO ONE WHO PLANTS CORN CAN AFFORD TO BE WITHOUT A CORN GRADER.**

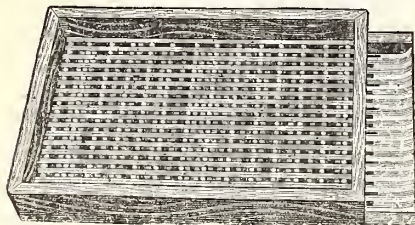

Every farmer now knows his seed corn should be graded. No planter will drop right with ungraded seed.

Graded seed insures perfect dropping, stronger plants, and increases the yield 5 to 15 bushels per acre. This has been proved over and over by thousands of

farmers, over by the Experiment Stations and

**DOUBLE SCREEN,**

List Price, \$24.00 Dozen. Our Special Price, \$1.25 Each.

**ALL PRICES IN CATALOG SUBJECT TO CHANGE WITHOUT NOTICE**

## GRITCO-B Furrower and Marker

Neck Yoke  
and Whiffle  
Trees, \$4.50.

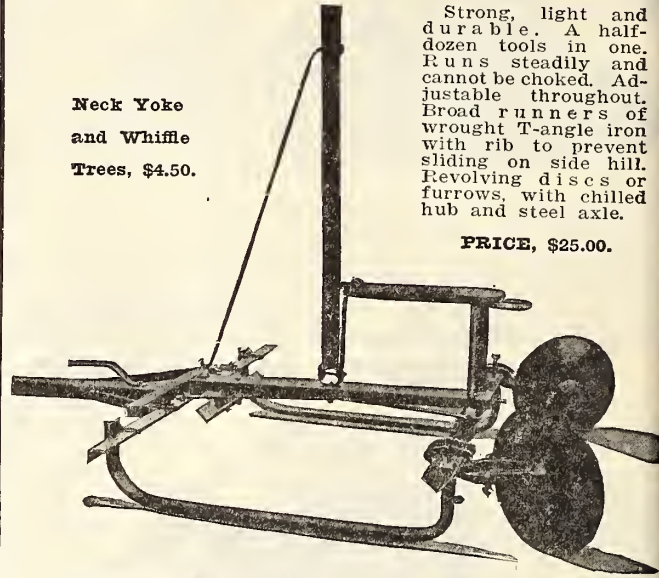

Strong, light and durable. A half-dozen tools in one. Runs steadily and cannot be choked. Adjustable throughout. Broad runners of wrought T-angle iron with rib to prevent sliding on side hill. Revolving discs or furrows, with chilled hub and steel axle.

**PRICE, \$25.00.**



3 Row Shovel Marker  
\$16.50

### The Gritco Wheel Marker

The Marker will open rows from 2 to 6½ feet. By the use of the lever they can be opened any depth desired. The Marker is light draft and easily controlled. It can be used for laying of rows, listing or covering. The Marker is equipped with marker pole, doubletrees and neckyoke.

Price.....\$40.00

### Gritco Hand Corn Planter

In the Gritco there is no chance of cracking the corn, beans or other seed, because of the Chinese bristle brush cut-off. The stamped steel slide is formed on a segment of the circle, whose center is the pivot of the blades. Slide quickly adjusted for different sized seeds. Galvanized iron hopper.

List, each, \$3.20. Retail, each, \$2.00.

### Acme Hand Corn Planter

**ITS ROTARY SLIDE** has a motion two ways—back and forth. It prevents skips. No matter how short the stroke, the pocket is pushed into the corn and back into the conveyor tube.

This motion is positive. It breaks up all bridging and fills the pocket uniformly—it counts the kernels for each drop.

List, each, \$4.00.

Retail, each, \$2.50.



### CHECK-ROWER WIRE FOR ALL THE LEADING PLANTERS.



Carry in stock the following sizes:

3 ft., 3 ft. 2 ins., 3 ft. 4 ins., 3 ft. 6 ins., 3 ft. 8 ins., 3 ft. 10 ins. and 4 ft.

The above comes in 10, 20, 40 and 80-rod rolls. Per Rod, List, 10c. RETAIL, 8c.



## BLACK HAWK ALTERNATING DRILL No. 76

For Altering Corn and Peas  
or Corn and Beans

Planting cowpeas and soybeans along with the corn crop has been proven to be a good practice and is increasing in popularity.

When the corn is used for silage the peas or beans make a more complete and balanced ration than corn alone.

When the corn ears are to be harvested in the regular way, many farmers turn the cattle and hogs into the field to eat the bean plants after the corn is harvested, thus returning the valuable manure to the soil. The field will grow the two crops as well as one.

The Black Hawk Alternating Drills handle both seeds with one can, the peas or beans being in an inner compartment and the corn in the outer. This makes a neat appearing, convenient assembly. Separate spouts are provided for the corn and for peas or beans.

No. 76 Planter, \$27.50.

No. 76, with Fertilizer Attachment, \$34.00.

## Black Hawk Corn and Cotton Planters

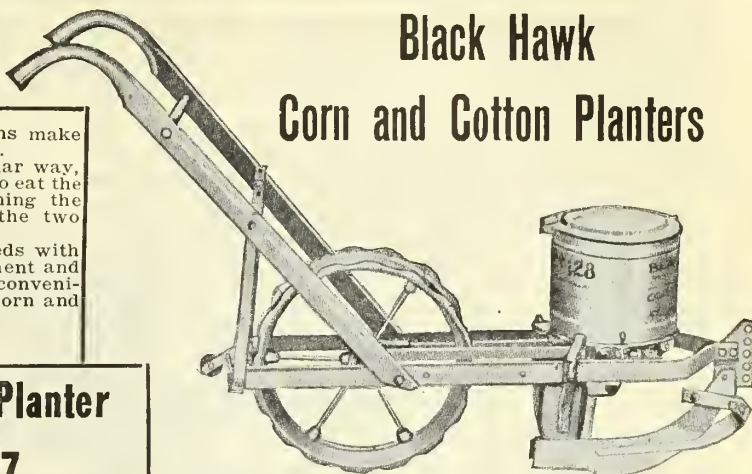

No. 128 is operated with an inside Pitman drive. This drive is direct and being placed within the frame cannot be damaged by bumping stalks, corn stalks, weeds, trash, etc.

Gauge shoe is furnished as a part of the regular equipment.

Fertilizer Attachment can be furnished for No. 128 at regular extra price when ordered.

No. 128—Plain.....\$22.50

No. 128—With Fertilizer Attachment. 29.00

## Black Hawk Planter No. 127

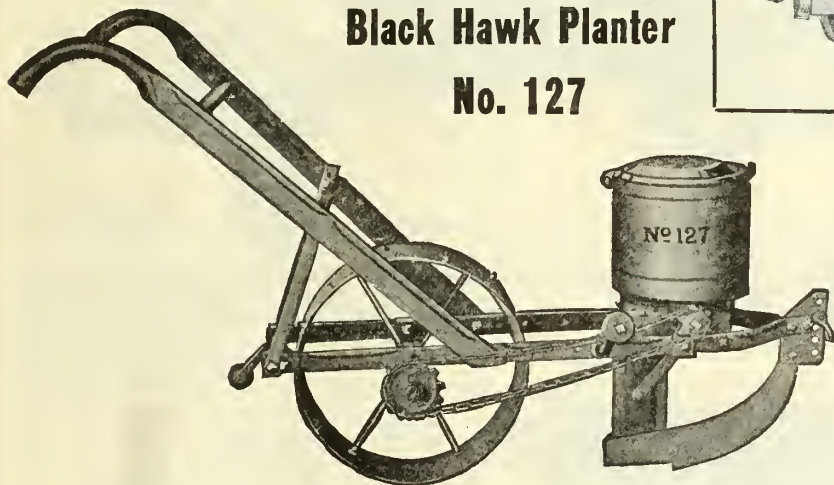

No. 127, Black Hawk One-Row Combined  
Corn and Cotton Drill

The No. 127 plants Corn and Cotton. Accuracy of drop in planting is assured by use of the original edge-drop system of seed planting.

The Drill is regularly equipped with gauge shoe, which regulates the depth of planting, and also helps to break up the clods. Planter can be furnished with Fertilizer Attachment.

No. 127—Plain.....\$22.50

No. 127—With Fertilizer Attachment..... 29.00

## No. 123 BLACK-HAWK ONE ROW CORN DRILLS

The No. 123 is a One-Row Chain Drive driven Drill, using the famous Black Hawk edge-drop system of seed selection. Plates can be furnished at an extra price for all kinds of beans, peas, kafir corn, broom corn, sorghum, beet seed, etc.

No. 123—Plain.....\$23.50

No. 123—With Fertilizer Attachment..... 30.00

## Planter Runner Shoe

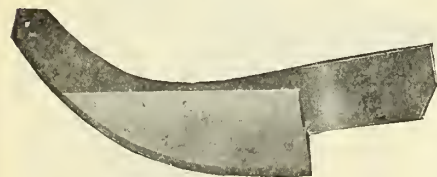

Intended for use on most old worn-out runners where a new runner cannot be obtained, and it will answer the purpose, but where new runners can be had it is much preferable.

Per Pair, List Price, \$3.00. Our Special Price, \$2.00.

## Corn Planter Runner

In ordering Planter Runners always state, as near as possible, the year Planter was made; whether steel or wood frame; or, better still, a diagram showing position of hole and size of bend.

### RUNNERS FOR SINGLE ROW PLANTERS.

	List Price Each.	Our Special Price Each.
For Hench & Dromgold Daisy .....	\$2.80	\$2.00
For Hoosier .....	2.80	2.00
For Keystone, No. 6½.....	2.80	2.00
For Farmers' Friend.....	2.80	2.00
For Evans .....	2.80	2.00
J. I. Case.....	2.80	2.00
For Black Hawk.....	2.80	2.00
Avery No. 27.....	4.00	2.75

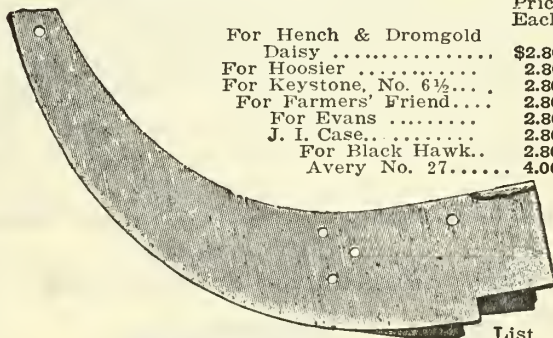

### For Double Row Planters.

	List Price Per Pr.	Our Sp'l Price Per Pr.
For Janesville, Nos. 1, 5, 7 and 8.....	\$6.00	\$3.75
" Black Hawk, No. 1.....	6.00	3.75
" Black Hawk, No. 4.....	5.50	2.75
" Black Hawk, No. 5.....	5.50	3.75
" Deere, No. 8 .....	5.50	3.75
" Deere, No. 9 .....	5.50	3.75
" Deere, No. 999.....	6.00	3.75
" J. I. Case.....	5.50	3.75
" Evans' Steel Frame.....	5.50	3.75
" Evans' Wood .....	5.50	3.75
" Evans' Simplex .....	5.50	3.75
" Superior .....	5.50	3.75
" Hoosier, No. 10.....	5.50	3.75
" Hoosier, No. 11.....	5.50	3.75
" Tiger, No. 4.....	5.50	3.75
" Tiger, No. 10.....	5.50	3.75
" Bullseye .....	6.00	3.75
" Union Victor .....	6.00	3.75

## Twelve Reasons Why You should Use BLACK HAWK Corn Planter

1. It has the most positive and simplest variable drop. Why? The only means necessary to impart the movement is a simple, chilled pinion. We have eliminated the use of springs and cams which are found necessary in many other planter drives.
2. A distinctive feature found only on the Black Hawk is the impulsive movement which allows the plate to rest over the seed spout while depositing each grain of corn.
3. The impulse movement will plant 5 per cent. more perfect than any other drive mechanism.
4. No matching or timing necessary in changing seed plates. Drop in the plate which finds its own position.
5. No danger of a butt kernel remaining in seed plates; means are provided for expelling same the first time around.
6. Cone shaped plates grooves leading to all seed cells.
7. Double channel shank allows corn to accumulate three times before depositing; insures accuracy in hill dropping.
8. Nine different distances in drilling without changing plates—7 1/2" to 22". Additional plates can be furnished to drill from 3 1/2" to 88" apart.
9. No danger of clogging seed spout by team backing up. Seed is forced out into the ground.
10. Narrow runner scours well, plants straight line.
11. Reversible check fork.
12. Best balanced farm planter. It balances without the aid of springs.

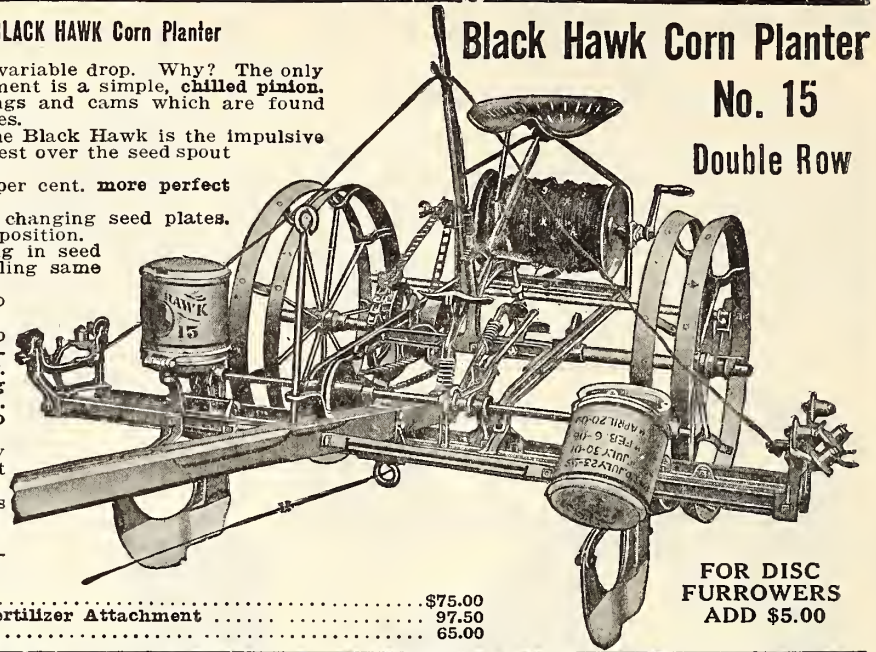

## Black Hawk Corn Planter No. 15 Double Row

FOR DISC  
FURROWERS  
ADD \$5.00

No. 15—Plain Check Rower Planter.....	\$75.00
No. 15—Planter, with Check Rower and Fertilizer Attachment .....	97.50
No. 35 Double Row Drill Planter.....	65.00

## BLACK HAWK MANURE SPREADER

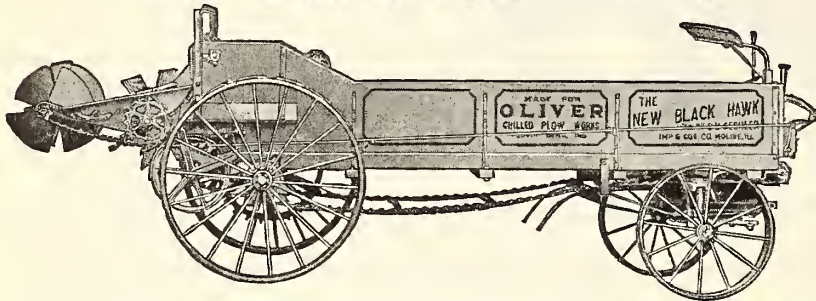

### A FEW OF THE MANY REASONS WHY YOU SHOULD OWN A BLACK HAWK SPREADER

1. The machine is made of the best materials and is properly proportioned.
2. Has no cog gears and few working parts.
3. Both front and rear axle set under the body so that weight of load is evenly distributed.
4. Rear axle is made of 2-inch high-grade carbon steel.
5. Short wheel base only 92 inches.
6. Front truck most perfect ever used.
7. No whipping or lashing of the pole.
8. Has strong and positive feed service.
9. Has large main beater with 8 bars.
10. Wide spread discs 12 gauge, twice as heavy as discs on other wide spread attachments.
11. All bearings and other essential working points are contained in a single unit and cannot change. The usual method employed by others is of boring holes in wood sides and inserting bearings.
12. Solid bottom which does away with slat trouble.

### SIMPLE DRIVE REDUCES WEAR

The driving mechanism—a strong chain that lowers into mesh with the main drive sprocket—is in motion only when operating the distributing device. This greatly reduces wear as the chain is lifted from the main sprocket wheel when the spreader is thrown out of gear leaving no parts running idle.

### WIDE SPREAD ATTACHMENT

In the New Black Hawk Spreader the large, eight bar, steel beater throws the manure from the load in a regular flow. The Black Hawk wide spread attachment thoroughly pulverizes the manure and scatters it evenly. A simple ratchet adjustment varies the amount of the flow. This is regulated by a lever placed convenient to the operator. The flow can be controlled from the quantity required for a light top dressing for grain to a very heavy spread for run-down land. The value of this feature is appreciated by every farmer who realizes that different soils and crops require varying amounts of manure for obtaining maximum production. Correct design and simple construction assure positive action throughout the life of the spreader. 40-A—60 to 70 bushels. \$155.00. Brake, \$10.00. Top Sides, \$5.00.

## Our Special Fertilizer Distribution

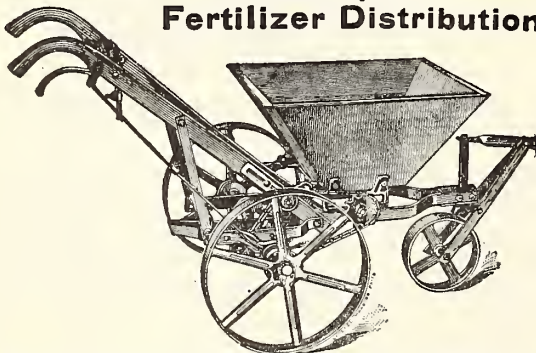

This cut shows Our Special Fertilizer Distributer, which has become very popular. It has a positive force feed, and will sow all kinds of fertilizer. It is made of the best material, and is practical. **OUR SPECIAL PRICE, \$22.50**  
For Raised Hopper add, \$1.50.

## GRITCO STALK CUTTER

- 7-Blade, single row. .... \$50.00
- 9-Blade, single row. .... 55.50

Practically an all-steel frame machine, making it neat of construction and giving it ample strength. The wheels are all steel, with removable box and 2-inch tire. The lever is within easy reach of the operator and is connected with pressure spring

Without Hitch

which connects with the cylinder or knife heads, and with which can be produced an even pressure at all times on the knives.

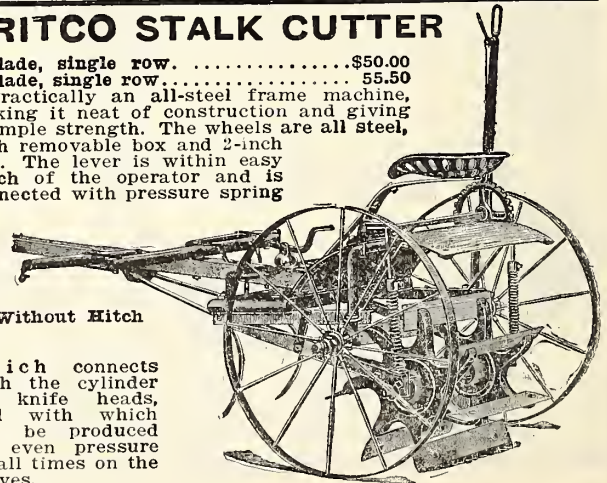

## CELEBRATED APPLETON CORN HUSKER

This Husker will do the work. It is no experiment. It is superior to all others. We will be pleased to send anyone names of representative farmers who are using the Appleton Husker and will testify in its favor. We know that most Huskers have failed to give satisfaction. The Appleton Husker never fails to measure up to the expectation of purchaser.

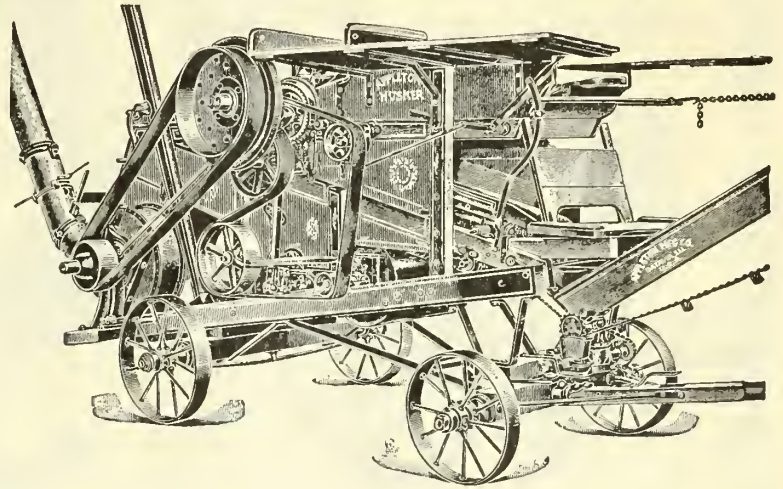

Write for Interesting Husker Catalogue.

We guarantee that under the same conditions the Appleton Husker will do more and better work than any other Corn Husker on market; that it is simpler and requires less power. It is easier and safer to feed.

### Capacity of Appleton Corn Husker and Power Required.

Size.	Horse-Power	Capacity per Hour.
No. 18.....	6-10	40-60 Bushels.
No. 24.....	8-12	60-90 Bushels.

Above power for cutter head. For shredder head we recommend 4 H. P. more.

No. 18—Four-Roll Husker, with cutter head, swivel, ear-corn carrier, 20-ft. blower and wheel mounting.....	\$551.50
No. 18—Husker, with shredder head instead of cutter head.....	561.60
No. 18—Husker, with both shredder and cutter head.....	620.50
No. 24—Six-Roll Husker, with cutter head, swivel, ear corn carrier, 20-ft. blower and wheel mounting.....	747.75
No. 24—Husker, with shredder head instead of cutter head.....	761.00
No. 24—Husker, with both cutter and shredder head.....	838.50
Blower Pipe, extra length, per foot.....	1.25

## MONARCH STEEL STUMP PULLERS

Monarch Stump Pullers embody in their construction special features which make them the strongest and most efficient machines for such work. The heavy solid one-piece main frame, the grooved drum, the drum clutch, the high-grade cable and other features place the Monarch Stump Pullers in a class to themselves. Special catalogue fully describing these features mailed free on application.

If interested in Stump Pullers, write for our catalogue of the Monarch line, which is very complete and useful; also let us know how much stumpy land you have, the kind of soil, the kind and size of stumps, how close to the ground they are cut and whether they are green or dead. This information will enable us to recommend the equipment most suitable for your work.

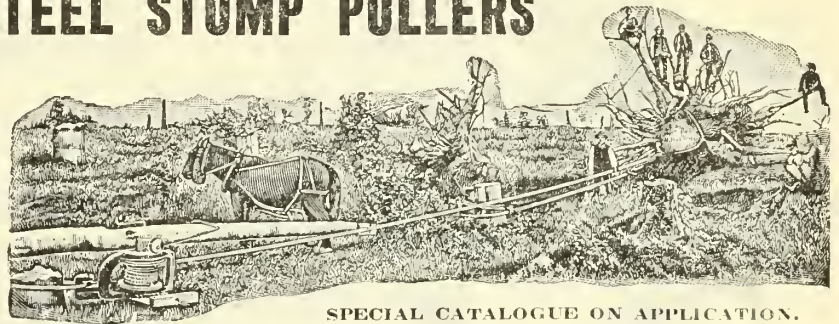

SPECIAL CATALOGUE ON APPLICATION.

**No. 3—Steel One-Horse Stump Puller**, equipped with 50 feet of 3/4-inch pull cable and 8 feet of 3/4-inch anchor cable. For ordinary stumps. Weight 450 pounds. **Our Price, \$153.25**, with 75 feet of pull cable.

**No. 4—Monarch Steel Stump Puller**, 75 feet 3/4-inch pull cable, 10 feet 3/4-inch anchor cable. Weight, 675 pounds. **Our Price, \$191.75**. Extra cable (to make pull cable any length you want), per foot,

**No. 4—Cam Take-Up**, with 10 foot 3/4-inch cable and steel cable hook. Weight, 50 pounds..... **\$36.75**

**No. 4—Double Power Pulley**, 12 feet 1-inch cable and steel cable hook. Weight, 65 pounds..... **\$46.75**

**No. 5—Monarch Steel Stump Puller**, 75 feet 3/4-inch pull cable, 12 feet 3/4-inch anchor cable. Weight, 875 pounds, **\$250.00**. Extra cable (to make pull cable any length you want), per foot, —.

**No. 5—Cam Take-Up**, 12 feet 3/4-inch cable and steel cable hook. Weight, 70 pounds..... **\$46.75**

**No. 5—Double Power Pulley**, 15 feet 1 1/4-inch cable and steel cable hook. Weight, 95 pounds..... **\$61.75**

**No. 6—Monarch Steel Stump Puller**, 75 feet 1-inch pull cable, 12 feet 1-inch anchor cable. Weight, 1075 pounds, **\$283.50**. Extra cable (to make pull cable any length you want), per foot, —.

**No. 6—Cam Take-Up**, 12 feet 1-inch cable and steel cable hook. Weight, 80 pounds..... **\$63.35**

**No. 6—Double Power Pulley**, 15 feet 1 1/4-inch cable and steel cable hook. Weight, 110 pounds..... **\$71.75**

**No. 7—Monarch Steel Stump Puller**, 75 feet 1 1/4-inch pull cable 15 feet 1 1/4-inch anchor cable. Weight, 1450 pounds. **Our Price, \$500.00** Extra cable (to make pull cable any length you want), per foot, —.

**No. 7—Cam Take-Up**, 15 feet 1 1/4-inch cable and steel cable hook. Weight, 150 pounds..... **\$88.35**

**No. 7—Double Power Pulley**, 20 feet 1 1/2-inch cable and steel cable hook. Weight, 150 pounds..... **\$100.00**

### MONARCH BESSEMER STEEL STUMP HOOKS.

Notice the sharp cutting edges on the inside of each prong and the heavy steel back of them, which counts for strength.

**No. 4—Regular Mesquite Stump Hook**, for use with No. 2, No. 3 and No. 4 Mighty Monarch Stump Pullers; used extensively for heavy brush hedge, palmetto, mesquite and old stumps. Weight, 65 pounds. **Our Price, \$31.75**.

**No. 5—Medium Mesquite Stump Hook**, for use with No. 5 and No. 6 Mighty Monarch Stump Pullers; for heavy stumps and heavy mesquite, etc. Weight, 85 pounds. **Our Price, \$43.20**.

**No. 8—Giant Mesquite Stump Hook**, for use on No. 7 Mighty Monarch Stump Pullers or on large double, triple and quadruple power outfits for extra heavy work where no other stump hook will stand the strain. Weight, 160 pounds..... **\$83.35**

**OLIVER RIDING CULTIVATOR NO. 32**

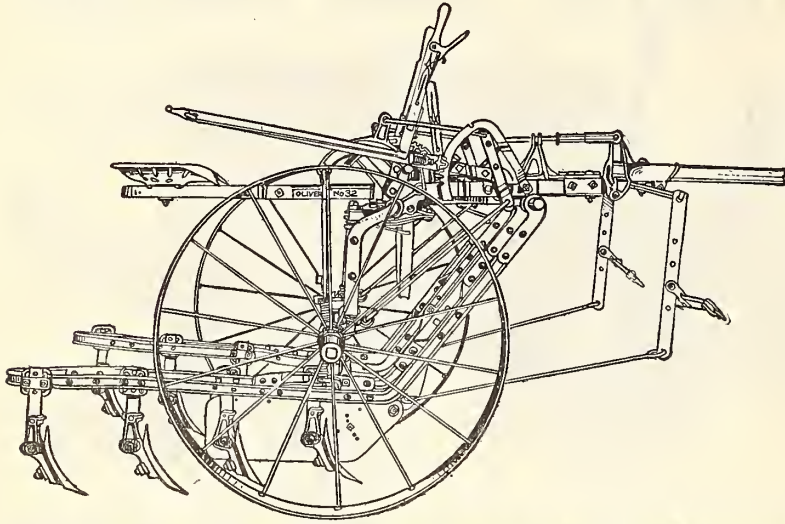

The New Oliver No. 32 is a light draft, easy running cultivator; the draft is evenly distributed. Both gangs are controlled by a master depth lever, raising or lowering both gangs to the desired depth. In addition there is an individual depth lever which controls each gang separately. The balance is perfect. Has unusual clearance, and can be used as late as it is practicable for cultivating without damage to crop. The pivot pole and axle makes it exceptionally quick acting in following crooked rows and dodging plants out of line.

All shovels are adjustable up and down, or can be turned to throw as little or as much dirt to the crop as desired.

By changing the location of the shanks on the gangs, four, six, or eight shovels may be used without changing the gangs.

The distance between the gangs is regulated by a lever within easy reach of the operator. A simple forward or backward pull on the lever increases or decreases the distance between the gangs. Distance between the gangs can be changed while the cultivator is in motion.

The depth of the front shovels in relation to the depth of the rear shovels can be instantly changed by means of a crank screw placed directly in front of the operator.

6 Shovel Pin Hoe.....	\$63.50
8 Shovel Pin Hoe.....	65.00
6 Shovel Spring Hoe.....	68.50
8 Shovel Spring Hoe.....	70.00

**OLIVER WALKING CULTIVATOR NO. 2**

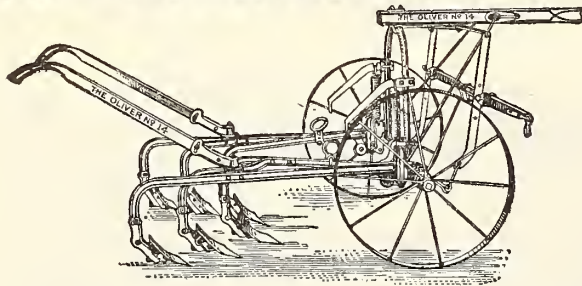

There are many walking cultivators on the market whose combined merits would, if embodied in a single machine, no doubt result in a fine implement, but it is left for the Oliver No. 2 to represent the majority of existing advantages besides offering some entirely new features. The axles are continuous, and by virtue of the solid clamp and solid brace fastening below, the Oliver is the most rigid and strongest machine of the kind ever offered. Compare this construction with others where braces terminate in loose eyes around the axle, or when upper ends of axles are held in loose sockets with set screws. The tongue is perfectly balanced, the wheels are strong, fitted with 2-inch tires and dust-proof hubs. The hitch is short, and this is the only cultivator with eveners behind the point on pole where arch braces fasten. The spring lift is adjustable up and down on the arches.

**Our Special Price.**

No. 2—6-Shovel Pin Hoe, Parallel Pipe Beam.....	\$47.00
No. 2—8-Shovel Pin Hoe, Light Gang.....	41.00
No. 2—6-Shovel Spring Hoe, Parallel Pipe Beam....	51.00

**GRITCO STEEL BEAM DIVERSE CULTIVATORS WITH LEVERS**

These cultivators are also very popular in the South for cotton cultivation.

Each, List, \$16.00. Retail, \$10.00.	
Fenders for above, List, \$2.00. Retail, \$1.25.	
For Reversible Point Teeth, add per cultivator, List, \$1.60. Retail, \$1.00.	
Gauge Wheels, List, \$2.00. Retail, \$1.25.	

	<b>EXTRA TEETH.</b>	
	List Price.	Retail Price.
Plain .....	\$1.20	\$0.70
With Rev. Points.....	1.40	.80

**WEEDERS AND ATTACHMENTS**

By the use of Weeders much time and labor are saved and better crops grown. These weeders or shallow cultivators, as they are sometimes called, can be worked in dry or wet weather. They will not cut the roots of the crop, but cultivate just deep enough to retain the moisture where it is most needed. Use a weeder early and often, and you will be surprised at the results. It is a good policy to use the weeder after a heavy rain, when the ground has been beaten down, to avoid the forming of a hard crust which retards the growth and development of the crops.

**GRITCO FLAT TOOTH WEEDER**

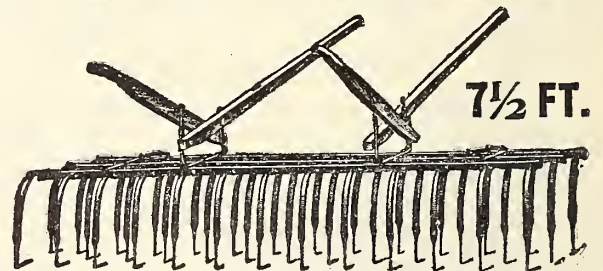

	List Price.	Our Special Price.
7 1/2-foot Gritco Flat-Tooth Weeder....	\$22.00	\$13.50
Extra Teeth.....	.40	.30

**GRITCO WOOD BEAM DIVERSE CULTIVATORS WITHOUT LEVERS**

Each, List, \$13.00; Retail, \$8.00. Fenders for above, List, \$2.00; Retail, \$1.25. For Reversible Point Teeth, add per cultivator. List, \$1.60; Retail, \$1.00.

## CULTIVATOR AND HORSE HOE STEELS

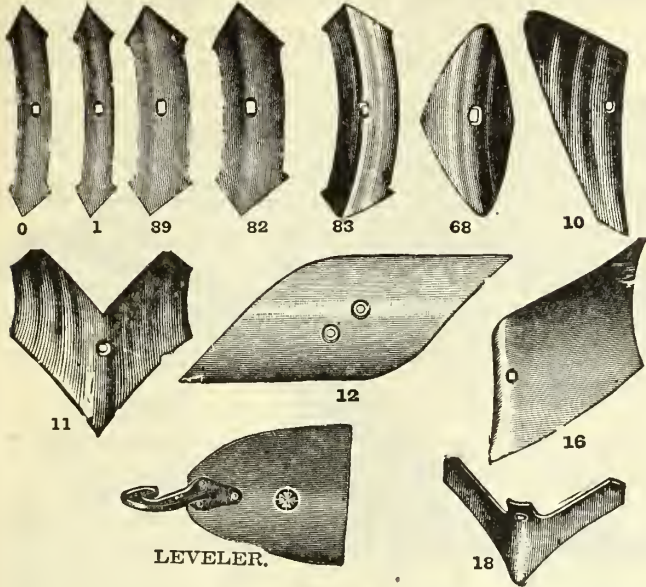

No.	Description	List Price.	Our Special Price.
No. 0	1 1/4-in. Diamond Point Steel	\$20.00 per 100	\$0.13 ea.
No. 1	2-in. Diamond Point Steel	22.00 per 100	.15 ea.
No. 89	2 1/2-in. Diamond Point Steel	24.00 per 100	.16 ea.
No. 82	3-in. Diamond Point Steel	26.00 per 100	.17 ea.
No. 83	3 1/2-in. Diamond Point Steel	29.00 per 100	.18 ea.
No. 84	4-in. Diamond Steel Point	32.00 per 100	.20 ea.
No. 68	Oval or Jersey Point Steel	32.00 per 100	.20 ea.
No. 10	Turn Shovel, right or left	42.00 per 100	.27 ea.
No. 16	Turn Shovel	40.00 per 100	.25 ea.
No. 11	6-in. Sweep, about 7-in. across	50.00 per 100	.32 ea.
No. 11	8-in. Sweep, about 11-in. across	56.00 per 100	.32 ea.
No. 12	Horse Hoe, Steel only, without shank, R. & L.	57.00 per 100	.36 ea.

Description	List Price.	Our Special Price.
Horse Hoe, Steel, with Shank or Standard, per pair	\$2.20	\$1.35
Horse Hoe Attachments, complete, per set of three pieces	2.60	1.70
No. 18—6-in. Sweep, each	.48	.30
No. 18—8-in. Sweep, each	.54	.33
No. 18—10-in. Sweep, each	.60	.39
No. 18—12-in. Sweep, each	.70	.42
No. 18—15-in. Sweep, each	.90	.58
Wheels for Cultivator, each	1.40	.85
Levelers for Cultivators, each	1.50	.75
Cultivator Plate Bolts, 1 1/2, per 100	4.00	ea. .03
Cultivator Plate Bolts, 2 1/2, per 100	4.00	ea. .03
Cultivator Frame Bolts, per 100	4.00	ea. .03
Wheel Cultivator Clamps, each	.70	.45
Set Screw Cultivator Clamps, each	.60	.40
Teeth for Baltimore Combined Harrow and Cultivator, Diamond Shaped Steel, each	.20	.14
Cultivator Handles, finished with rod and round, per pair	2.40	1.50

All of the above goods are of the best steel and highly polished.

## Steels for Hench and Drungold's Riding Cultivators and Champion

Walking Cultivators		List Price.	Our Special Price.
1 1/2-inch Plain Shovel, O. S., without revolving backs		\$0.34	\$0.21
2 1/2-inch Plain Shovel, O. S., without revolving backs		.43	.27
3-in. Plain Shovel, O. S., without revolving backs		.44	.28
3 1/2-in. Plain Shovel, O. S., without revolving backs		.46	.29
2 1/2-in. Plain Shovel, N. S., with revolving backs		.86	.54
3-in. Plain Shovel, N. S., with revolving backs		.88	.55
3 1/2-in. Plain Shovel, N. S., with revolving backs		.94	.59

Steels for Iron Age Riding Cultivators		List Price.	Special Price.
No. 90—1 1/4 inches wide, each		\$0.44	\$0.27
No. 91—2 1/2 inches wide, each		.52	.32

## Steels for Riding Cultivators WITH AND WITHOUT BACKS

For Round and Open Foot Shanks. For Brown, Brown-Manly, Buckeye and Deere Cultivators.

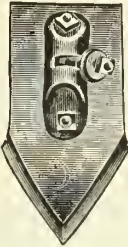

No. 5—Back for convex or open foot shanks.



No. 2—Back for round shanks.



This cut shows 3x10 reversible steel.

Always specify which style of Back is Wanted.

Back No. 2

Back No. 5

In ordering 5x11-inch Steels in less than sets of four, always specify whether wanted with straight top or flared top, and right or left hand.

## STEELS FOR RIDING AND WALKING CULTIVATORS

Description	List Price.	Our Special Price.
1 1/2 x 10 inches, Reversible with Back	\$0.68	\$0.44
2 x 10 inches, Reversible with Back	.75	.47
2 1/2 x 10 inches, Reversible with Back	.80	.50
3 x 10 inches, Reversible with Back	.84	.52
3 1/2 x 10 inches, Reversible with Back	.87	.54
1 1/2 x 10 inches, Reversible without Back	.24	.20
2 x 10 inches, Reversible without Back	.35	.22
2 1/2 x 10 inches, Reversible without Back	.38	.23
3 x 10 inches, Reversible without Back	.40	.25
3 1/2 x 10 inches, Reversible without Back	.42	.27
5 x 11 inches, With Back	1.20	.75
5 x 11 inches, Without Back	.84	.53
5 x 11 inches, Not Bored	.80	.50
1 1/2 x 10 inches, Bull Tongues, with Back	.75	.47
2 x 10 inches, Bull Tongues, with Back	.76	.48
2 1/2 x 10 inches, Bull Tongues, with Back	.78	.49
1 1/2 x 10 inches, Bull Tongues, not Bored	.40	.25
2 x 10 inches, Bull Tongues, not Bored	.42	.26
2 1/2 x 10 inches, Bull Tongues, not Bored	.44	.27

## Spike Harrow Teeth



1/2 and 7-16 in., lb. .... 10c.

5/8 in., lb. .... 9 1/2 c.

3/4 in., lb. .... 9c.

Special Price in Quantity.

## STEELS SIZES SHOVEL PLOW STEELS

For Single and Double Shovel Plows.





**DRAG BLADES.**  
4"x7", 4 1/2"x7", 5"x8"

**D. S. BLADES**  
5", 5 1/2", 6", 6 1/2", 7" wide.  
8", 10" and 11" long.

**S. S. BLADES**  
All sizes from 8" to 19" wide by 11" to 16" long. In 1 and 2 hole.

**CALF TONGUES**—1 1/2", 1 3/4", 2" wide by 8" long.  
**BULL TONGUES**—1 3/4", 2" and 3" wide by 11" long.  
 Above can be furnished in 1 or 2 hole.

Full and complete line of polished steels for Single and Double Shovel Plows made in both one and two-hole styles. Genuine Malta Double or Single Shovel Plow Steels, per pound ..... \$0.13  
 Farmers' Favorite Triple Shovel Plow Steels, per pound ..... \$0.14  
 Farmers' Favorite and Double Shovel Plow Steels, per pound ..... .13  
 Bolts for Shovel Plow Blades, each ..... .05  
 Shovel Plow Pender ..... .75

## SHOVEL PLOW HANDLES

Finished, for Single or Double Shovel Plows, complete with round and rod, per set	\$1.50
Finished without round and rod, per pair	1.40
Finished and bored, right and left, each	.75

## LORD BALTIMORE CULTIVATOR AND HORSE HOE FIG. 20

Equipped with our latest improved **Hollow Pressed Steel Standards, Lever Expander and Outside Handle Braces.** Extra high Steel Frame. Standards are interchangeable, there being no "right" nor "left" as in the solid standards in general use.

The **Horse Hoe Standards** differ from the other three, and take either the regular Cultivator Teeth or Hilling Attachments. They have two holes to accommodate Hillers, and may be turned all the way around, thus giving any sideway angle desired. Hillers are reversible, and may be used with either point or rounded edge foremost. Weight, 60 lbs.

With Lever, List Price, \$14.00. **OUR SPECIAL PRICE**.....\$8.50

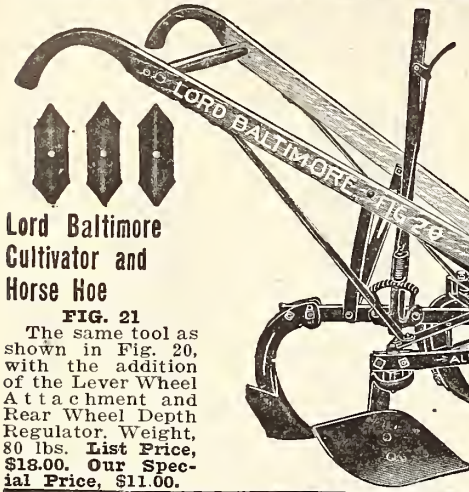

Lord Baltimore Cultivator and Horse Hoe

FIG. 21

The same tool as shown in Fig. 20, with the addition of the **Lever Wheel Attachment and Rear Wheel Depth Regulator.** Weight, 80 lbs. **List Price, \$18.00. Our Special Price, \$11.00.**

With Lever and Wheel, **List Price, \$15.50. OUR SPECIAL PRICE, \$9.50.**

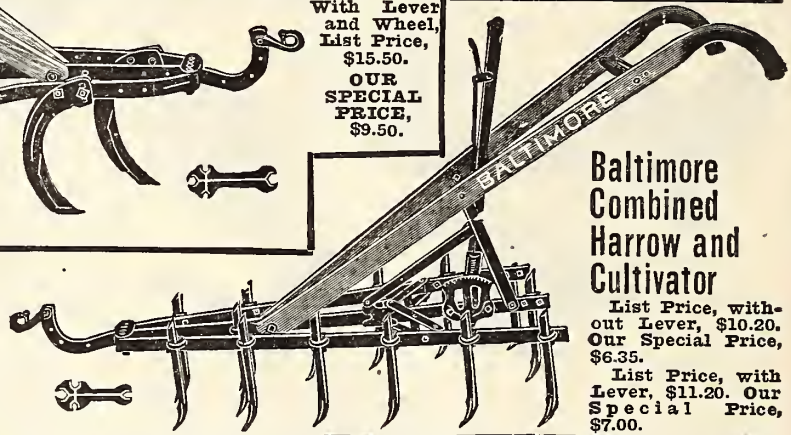

Baltimore Combined Harrow and Cultivator

List Price, without Lever, \$10.20. **Our Special Price, \$6.35.**

List Price, with Lever, \$11.20. **Our Special Price, \$7.00.**

## Baltimore Combined Harrow and Cultivator

The teeth have four positions—first, position shown in cut, in which case can be used for working very close to small plants. Thoroughly pulverizes, throws no dirt on plants. Second position, as a straight tooth harrow. Third position, teeth can be arranged as a smooth harrow, with sharp points down, in order to cut and level surface. Fourth position, teeth can be set with sheared end down, being less liable to injure young plants.

Can be contracted to 9 inches and expanded to 21 inches. **Weight, 51 pounds. 14-TOOTH.**

Oriole and O. D. have Plates No. 89

## SHOVEL PLOWS

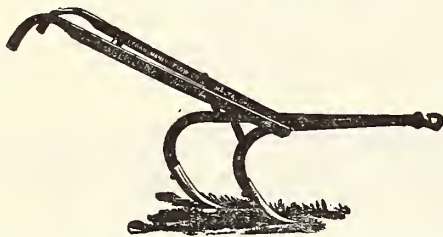

The cost of these goods is not so much in finish as in the construction and material, these being the principal requisites in an implement.

Farmers' Favorite, single-shovel Plow. . . \$4.00  
Farmers' Favorite, double shovel Plow. . . 4.50  
Triple-shovel Plows, regular. . . . . 6.25  
Extra Heavy three-shovel Plows. . . . . 6.50

These Cultivators can be contracted to about 9 to 10 inches, and expanded to about 26 inches.

WEIGHT  
42 lbs.

wherever sold it becomes a favorite. Both have No. 89 plates.

	List Price	Special Price
Cultivator, plain	\$ 9.00	\$5.50
Cultivator with Lever	10.30	6.25
Horse Hoe Attachments, complete, per set of three pieces	2.60	1.60
Wheels for Cultivators, each	1.30	.85

## Old Dominion Oriole and Cultivator

The difference between Oriole and Old Dominion Cultivators is: The first has bent frame and the other has straight frame. The Old Dominion Cultivator is sold principally in Virginia and the South, and

## GRITCO STEEL BEAM FOUR SHOVEL PLOWS

PRICE, \$7.10.

Both the Steel Beam and Wood Beam four shovel Plows are special favorites in the South, particularly in North Carolina and Virginia.

Three Shovel, Steel Beam, \$6.35.  
Four Shovel, Steel Beam, \$7.10.

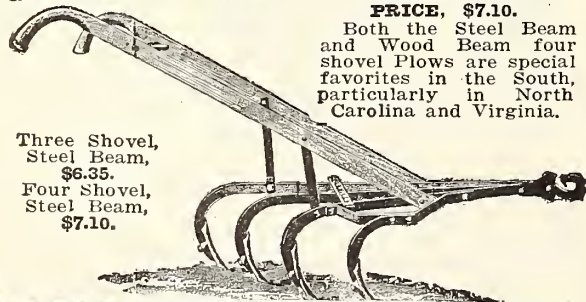

## GRITCO WOOD BEAM FOUR SHOVEL PLOWS

Both Wood and Steel Beam are furnished with reversible plates. **PRICE**.....\$6.50

## The Original and Genuine "Malta" Iron Beam Single and Double Shovel Plows

Has 1 1/4 x 3/4-inch Beam. **PRICE:**

Extra Heavy Double Shovel Plow . . . \$5.40  
Extra Heavy Single Shovel Plow . . . \$4.50



**ALL PRICES IN CATALOG SUBJECT TO CHANGE WITHOUT NOTICE.**

15 TOOTH,  
258 LBS.  
17 TOOTH,  
276 LBS.

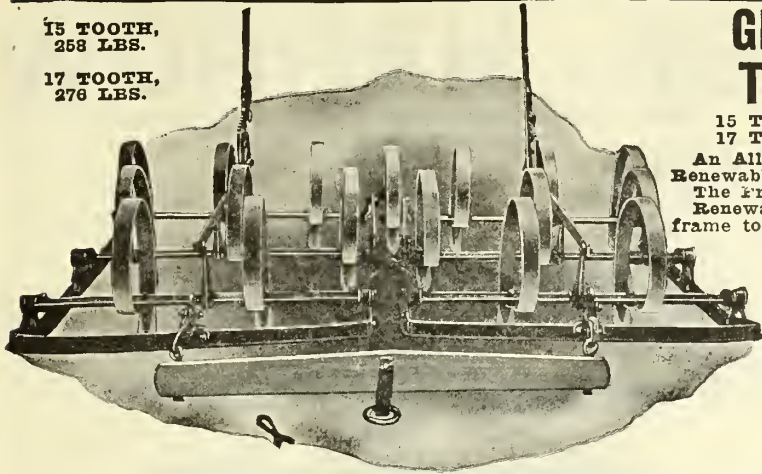

## GRITCO RUNNER SPRING TOOTH LEVER HARROW

15 TOOTH, \$28.50      23 TOOTH, 3 SECTION, \$41.00  
17 TOOTH, 30.50      25 TOOTH, 3 SECTION, 42.50

An All-Steel, Low-Down Lever Spring Tooth Harrow with Renewable Steel Runners. 15 or 17 Teeth. Two Sections. The Frame is made of special "T" Steel forged in one piece. Renewable Steel Shoes are bolted on to the underside of the frame to take the wear, so that no wear comes on the frame itself. These shoes can be renewed at a slight expense, making the harrow practically indestructible.

The Teeth are made from the best Open Hearth Steel, finely tempered in oil and fully warranted, and can be instantly raised or lowered by means of the levers. As the point of the tooth wears, same can be lowered by adjustment on the tooth bars.

The Shape of the harrow is correct to make it run steadily and smoothly and permit the teeth always to work at a uniform depth; teeth can be easily raised or lowered, to transport from field.

Construction is simple. It is durable and does not require a man and wrench to keep it in working order.

## GRITCO LEVER WHEEL HARROW

The Main Frame is constructed entirely of double "I" steel of high carbon. The frame surrounds the teeth, and there are no projecting parts to engage obstruction. Cross Bars are 1 1/4-inch structural tubing, and have no holes drilled through them; compression clamps instead of bolts being used for fastenings.

The Arrangement of Teeth—The front bar carries four, middle bar six, and rear bar seven teeth in the 17-tooth machine. Best arrangement possible.

Teeth are of regulation size, 1 3/4 inches wide, 1/4-inch thick, are made of best quality of spring steel and fully guaranteed against imperfection.

Tooth Holders—By our method of constructing tooth holders, or clamps, tooth may be readily adjusted and kept in line.

The Carrying Wheels are constructed with broad rims and the bearing surfaces are chilled. The Lever Racks are strong and durable, being made of malleable iron. It is painted with a heavy coat of green paint.

15 TOOTH.....\$30.00	19 TOOTH.....\$35.00
17 TOOTH.....\$32.00	23 TOOTH.....\$43.50

## THE BUTTS REVERSIBLE HARROW TOOTH POINTS

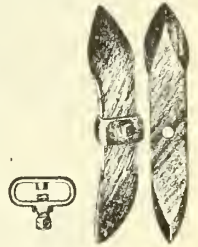

Can be used on all Spring Harrow Teeth.  
List Price, 45c. Price, each, 25c.  
Osborne. List, 34c. Our Price, 20c.  
Deering. List, 34c. Our Price, 20c.

### SYRACUSE REVERSIBLE HARROW TOOTH POINTS.

List Price, 32c. Retail Price, 20c.  
Michigan List Price, 45c. Retail, 25c.

## GRITCO PULVERIZING HARROW

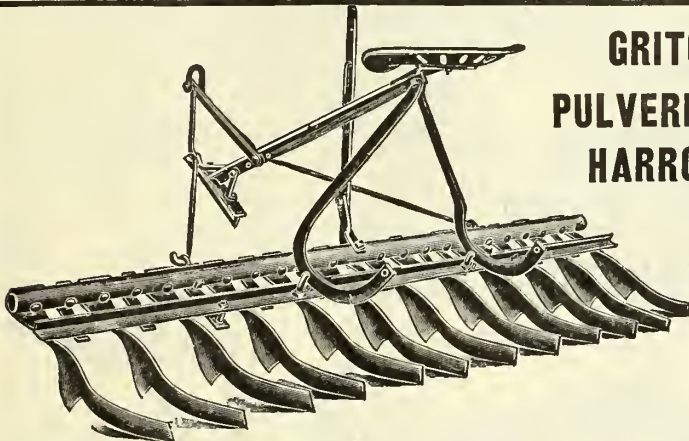

This Pulverizing Harrow will pulverize either light or heavy soil, and do it better than other harrows. The action of the blades is to pulverize the soil and at the same time put the ground in a smooth condition, thus producing an ideal seed bed.

It produces the work of a disk and spike tooth harrow. It can be adjusted by the use of the lever to any desired depth, and will not drag out the filth, but cut it up underneath where it will rot and improve the soil.

It is the lightest weight and lightest draft harrow on the market.

No. 6—12-Blade Riding Harrow.....	\$24.00
No. 5—8-Blade Riding and Walking Harrow.....	20.00
No. 3—6-Blade Walking Harrow.....	13.50
Coulters or Blades.....	.75

## SPRING HARROW TEETH

For All Leading Harrows.

Price.....55c. each

When taken in full sets, special price.



## WOOD FRAME HARROW, STEEL LINED

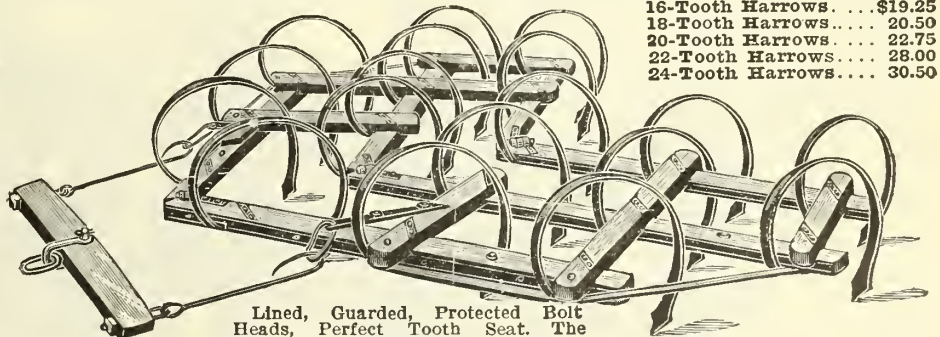

16-Tooth Harrows....	\$19.25
18-Tooth Harrows....	20.50
20-Tooth Harrows....	22.75
22-Tooth Harrows....	28.00
24-Tooth Harrows....	30.50

Lined, Guarded, Protected Bolt Heads, Perfect Tooth Seat. The best of "Wood Frame" Harrows.

**Cutaway**  
*(CLARK)*

# DISK HARROW

## Cutaway Single Action Harrow-Regular

The CUTAWAY (CLARK) Single Action Harrow was built up to a standard measured by actual field conditions of the most severe type. Observe in the illustrations opposite that the head is built directly on top of the gangs. Note the tongue, seat, braces and levers are all fastened to it, thereby making the disks carry the entire weight of the machine. This construction gives such a perfect balance that there is practically no weight on the horses' necks and makes the use of the tongue truck optional with the user. Without a tongue truck the hitch is placed back close to the machine and the draft is the very minimum.

The CUTAWAY (CLARK) Single Action Harrow is reversible; that is, the gangs can be swung end for end, so that the soil may be thrown either out or in. To reverse, it is only necessary to pull the cotter pins that hold the lever links, drop the links, swing the gangs around and reattach links.

Instead of having a heavy truss construction forward of the gangs with the line of draft at a considerable angle upward, the CUTAWAY (CLARK) Single Action Harrow is built on top of the gangs and the line of draft is practically horizontal. Instead of power being wasted in lifting the harrow out of the ground, it is all utilized in pulling the harrow in a horizontal direction and allows the machine to "take the ground."

Size.	No. of Disks.	Width of Cut.	Hitch.	Wt.	Retail Price.
A-4	8	4-ft.	2-h.	250	\$42.30
A-5	10	5-ft.	3-h.	275	49.65
A-6	12	6-ft.	4-h.	305	56.65
A-7	14	7-ft.	4-h.	435	64.35

16 inch Discs.



## CUTAWAY SINGLE ACTION HARROW-EXTENSION

Orchard tillage should be intensive. It is common knowledge that no crop responds to thorough tillage more profitably than large fruits. It is, therefore, natural that the orchardists should demand CUTAWAY (CLARK) harrows especially built for their peculiar needs.

The CUTAWAY (CLARK) Single Action Harrow Extension is the same machine as the CUTAWAY (CLARK) Single Action Harrow-Regular, except that the head is longer so as to spread the gangs out beyond the team and under the branches of the trees. The head is built on top of the gangs. To it are attached the tongue, braces, seat and levers. Thus the entire weight of the machine is on top of the gangs and is carried entirely by the disks.

Size.	No. of Disks.	Diam. of Disks.	Width of Cut.	Hitch.	Wgt.	Retail Price.
A-4	8	16-in.	6-ft.	2-h.	265	\$44.55
A-5	10	16-in.	7-ft.	3-h.	295	52.00
A-6	12	16-in.	8-ft.	4-h.	320	60.70

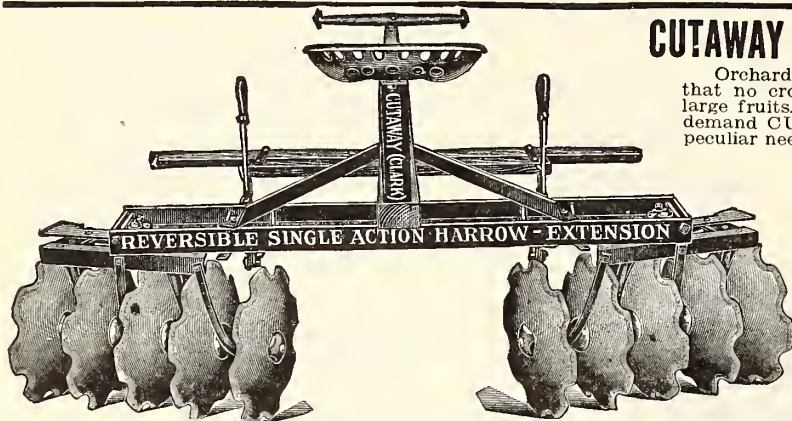

## Cutaway Single Action Harrow with Tongue Truck

This harrow is the same as the Cutaway Single Acting Harrow, except it is provided with a tongue truck, and in this instance the harrow is furnished without long tongue and neck yoke.

Four essentials of a good tongue truck are: first an axle joint, which allows either wheel to rise up and run over clods, stones and other obstacles without affecting the even, regular draft of the harrow; second, adjustable tongue attachment, which makes it possible to attach the tongue truck to a harrow of any height; third, adjustable hitch attachment, which makes it possible to set the hitch to suit the size of any team; fourth, dust-proof, oil-soaked hardwood bearings. Each of these essentials are found perfectly worked out in the CUTAWAY (CLARK) Harrow Tongue Truck. The prices are for complete harrows.

Size.	No. of Disks.	Width of Cut.	Hitch.	Wgt.	Retail Price.
A-4	8	4-ft.	2-h.	250	\$50.70
A-5	10	5-ft.	3-h.	275	58.05
A-6	12	6-ft.	4-h.	305	65.05
A-7	14	7-ft.	4-h.	435	72.75

16 inch Discs.

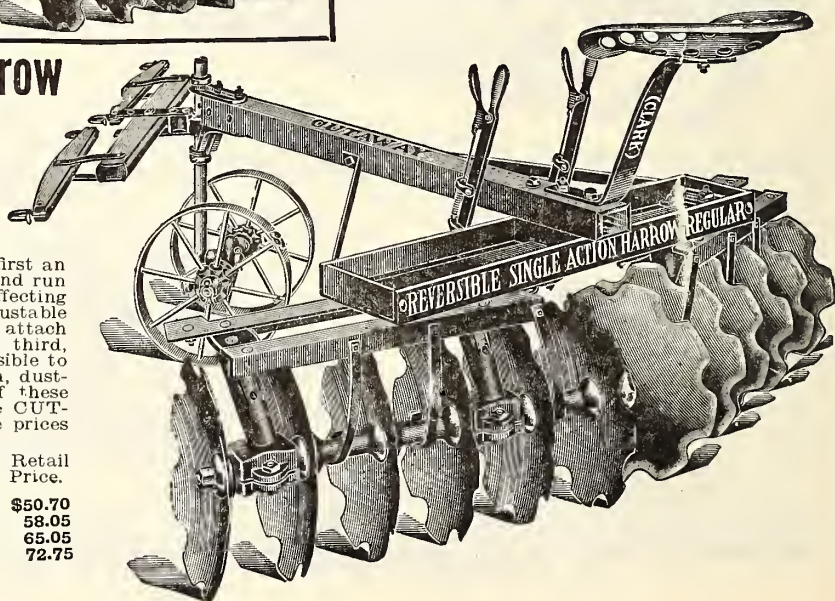



## CUTAWAY DOUBLE ACTION HARROW

### REGULAR

The great efficiency of Cutaway (Clark) Double Action Harrows is due more to the rigid main frame than to any other feature. All four gangs are attached to this one rigid main frame. Observe their positions in relation to one another. The rear disks cannot slue from side to side, following the course of least resistance, but cut just midway between the fore disks. Every particle of soil to the full depth to width the disks run is thoroughly stirred. Note how compactly the machine is built; how uniformly the weight is distributed; how excessively strong it is throughout. The Cutaway (Clark) is the original double action harrow. Its popularity spread because of its unequalled efficiency, and its efficiency is mostly due to the rigid main frame. There are substitutes, but at best they are only substitutes. Whenever there is any flexibility between the gangs the real efficiency is lost. The rigid main frame is vital.

No. of Disks.	Width of cut.	Hitch.	Wt.	Retail Price.
A-3	12	3' 6"	4-h	345
A-4	16	4' 6"	4-h	435
A-5	20	5' 6"	4-h	510
A-6	24	6' 6"	4-h	610
16 inch Discs.				97.35

*Cutaway*  
(CLARK)

## DISK HARROWS

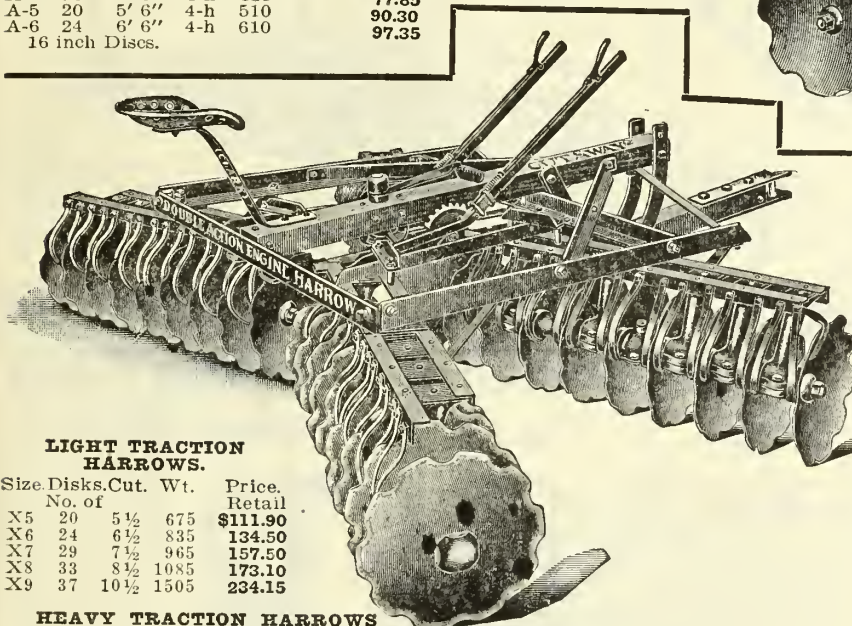
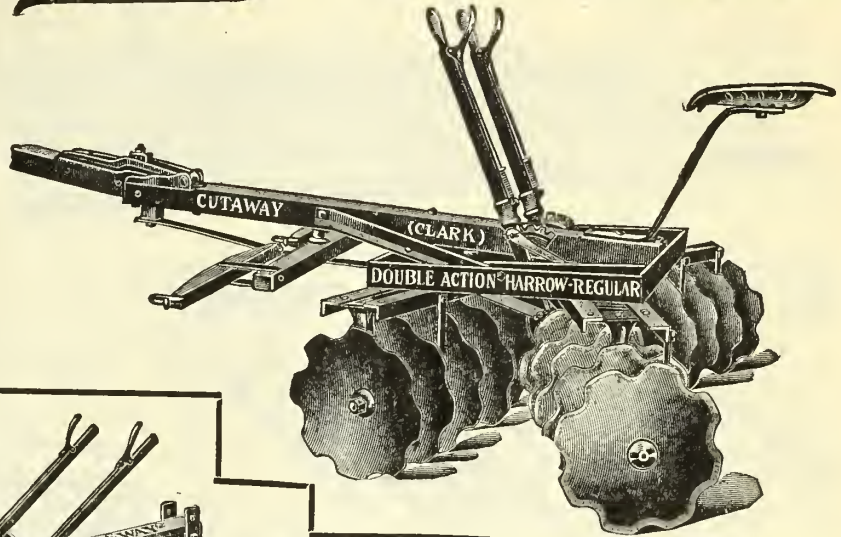

## CUTAWAY DOUBLE ACTION ENGINE HARROW

The mechanical detail of this machine is shown in the illustration opposite. All four gangs are attached to the one rigid main frame. This construction is all-important—vital. Only by the rigid main frame can a double action engine harrow be made to do such work as to justify its existence. The gangs are held rigidly. They cannot shift and slue about, but work in correct relation to one another at all times. The fore disks throw the soil out, and the rear disks cut just midway between the fore disks and throw the soil back, so that all is thoroughly stirred and left level. In the center is an extra disk which cuts out the middle. Observe in the illustration opposite how excessively strong this harrow is built throughout. The frame is of heavy angle iron, stoutly braced with angles. Draft rods extend between the frame and axles, so that the strain from the pull is uniformly distributed. The hitch is adjustable to any engine, and a perfect line of draft can always be maintained. The gangs are easily set at any angle desired. There is a size for almost every engine, and by hitching in multiples practically any sized outfit can be rigged. Sizes and specifications are given in table.

### LIGHT TRACTION HARROWS.

Size.	No. of Disks.	Cut.	Wt.	Price.
X5	20	5 1/2'	675	\$111.90
X6	24	6 1/2'	835	134.50
X7	29	7 1/2'	965	157.50
X8	33	8 1/2'	1085	173.10
X9	37	10 1/2'	1505	234.15

### HEAVY TRACTION HARROWS

Size.	No. of Disks.	Width of Cut.	Weight.	Retail Price.
B-6	25	7'	1475	\$220.35
B-7	29	8'	1665	247.35
B-9	37	10' 6"	2170	327.75
B-11	45	12' 6"	2575	421.30

\*"X" means that the disks are 18 inches in diameter; "B," 20.

## Cutaway Bush and Bog Plow

On many farms are fields lying out as waste, simply because their owners do not know how cheaply and quickly they may be put under cultivation. The old, expensive, hand-labor method is no longer necessary. Much work that could be done heretofore only by slow, tedious and hard labor with the ax, bush-knife and shovel can now be done with the Cutaway (Clark) Bush and Bog Plow.

As is shown in the illustration opposite, this machine is a big, heavy disk plow or harrow. It weighs 660 pounds. It is equipped with extra heavy 24-inch disks of standard Cutaway (Clark) quality, forged sharp. The bearings are dust-proof, oil-soaked hardwood, perfectly lubricated.

No. of Disks.	Diam.	Width	Hitch.	Wt.	Retail Price.
8	24 in.	5 ft.	4 H.	680	\$110.70
8	20 in.	4 1/2 ft.	2 H.	440	73.30

Additional for above, fitted with fore truck less long tongue and neck yoke. Retail Price, \$8.40.

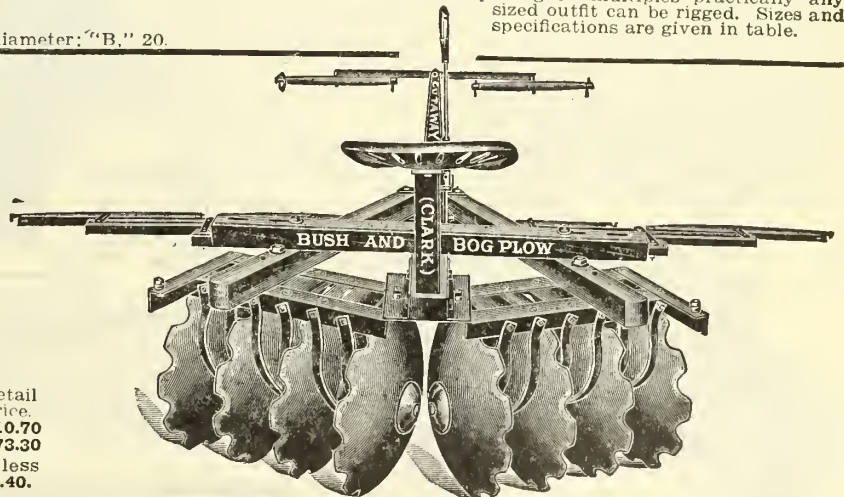

Made in 25 and 30-tooth sections, and with 1/2-in. or 9/16-in. teeth.

## Style E

## Gritco Guarded Frame Lever Harrow

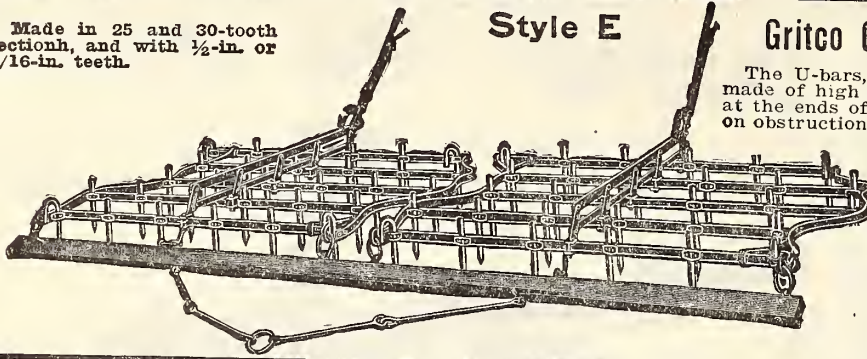

The U-bars, channels, oscillating bars and teeth are made of high carbon steel. The channels, being placed at the ends of the U-bars, prevent them from catching on obstructions, as is frequently the case with the open-end harrow. Strong and well made, but carrying no superfluous weight. Corner braces, oscillating castings and lever castings of malleable iron.

	List Price.	Our Price.
50-Tooth Harrow, 1/2-inch Teeth; Weight, 190 lbs.	\$35.60	\$21.00
50-Tooth Harrow, 9/16-inch Teeth; Weight, 195 lbs.	37.50	22.50
60-Tooth Harrow, 9/16-inch Teeth; Weight, 215 lbs.	42.00	24.00
75-Tooth	59.00	32.50
90-Tooth	65.00	37.50

## BALTIMORE DOUBLE HINGE HARROW

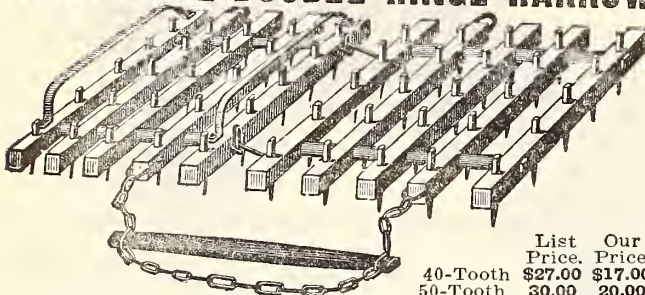

This is a two-section, wood-frame, spike tooth Harrow. The runners, as seen in the cut, are intended to be used in carrying the Harrow from one field to another.

	List Price.	Our Price.
40-Tooth	\$27.00	\$17.00
50-Tooth	30.00	20.00

	Lighter Harrow	60-Tooth	Our Price.
50-Tooth	\$19.50		21.00
75-Tooth			28.00

## Gritco Wood Bar Lever Harrow

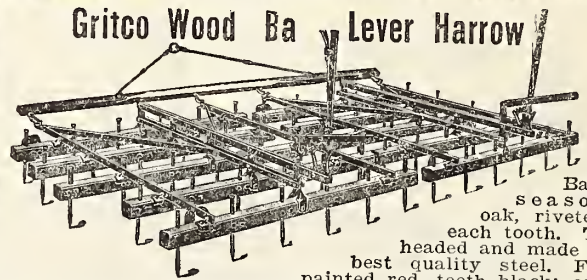

Bars of seasoned oak, riveted at each tooth. Teeth headed and made from best quality steel. Frame painted red, teeth black; combination draw bars furnished for two, three and four-section harrows when ordered.

	List Price.	Our Price.
No. 2450—2-Section, 50-9/16-inch Teeth	\$37.50	\$22.50
No. 2560—2-Section, 60-9/16-inch Teeth	40.80	24.50

## GARDNER'S HARROW

This Harrow is similar to the Baltimore Double Hinge Harrow, noted above, only it is made in one section instead of two. It is designed to be used with one horse. We furnish this Harrow with 30 teeth, which cuts 4 feet 6 inches wide, and with 25 teeth, cutting 3 feet 8 inches wide.

	List Price.	Our Price.
25-Tooth	\$15.50	\$10.00
30-Tooth	17.50	11.00

## OLIVER TRACTOR DISC HARROW

The advanced construction of the Oliver disc harrow permits all four gangs to be controlled easily from the tractor seat, by a simple screw device which changes the angle of all four gangs with the utmost convenience. It is not necessary for the harrow to be moving to change the angle of the gangs. If a difficult spot is encountered, taxing the power of the tractor, the operator can with a few turns of the screw adjustment, lighten the load and go on with the work. The screw part of the crank shaft is enclosed in a dust proof case which keeps the grease from working out.

The design of the Oliver Tractor Disc Harrow makes quick penetration and full depth cutting a certainty. The hitch is placed lower than the pivot bearing which connects the rear and front frame. This creates a downward pull on the front gangs which makes the blades penetrate without additional weight.

The Oliver Tractor Disc Harrow thoroughly stirs the soil on the corners.

The best materials are used on the Oliver Disc harrow, the frame being constructed of high carbon flat bar steel. The three standards of each gang are equipped with specially-designed, well-lubricated, long-life bearings.

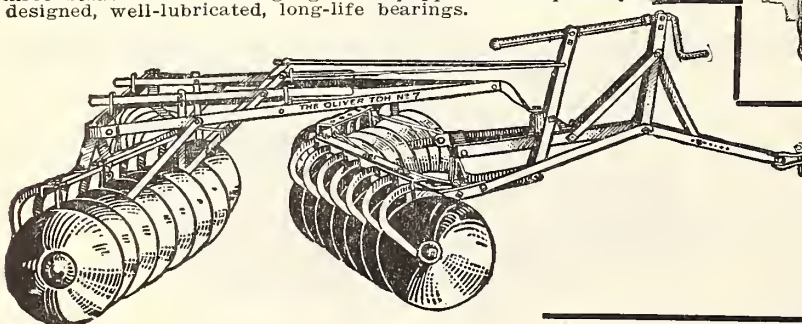

## THE MARTIN FARM DITCHER AND TERRACER

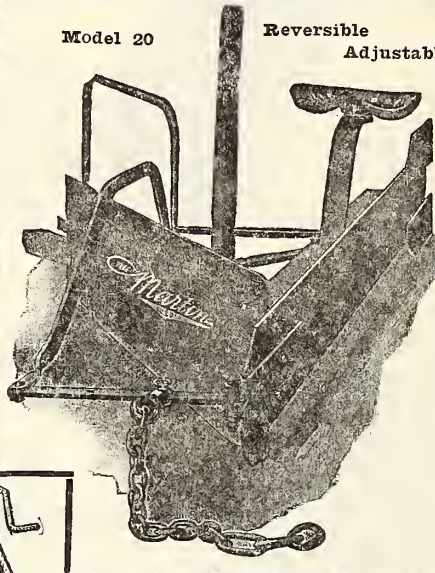

Specifications:  
 Landside 10 inches x 3/8 inch x 9 1/2 feet. Bessemer steel. Rear guide fins, crucible plow steel. All steel stationary footboard built into center of landside. Goose-neck, clogless hitch, heavy steel forging extends from draw bar to center of cutting blade. Steel rail handle to control cutting blade. Rolling couler in front.  
 Model 20, Standard Double Edge Cutting Blade, Steel Beam, reversible. No seat. 2 to 4-horse, \$65.00  
 Model 20-E, Like Model 20, but smaller; for 2 horses. Price without seat, \$60.00.  
 Seats, extra, \$3.50  
 Road Drag and Snow Blade for any Model, extra, \$11.00

The shape and position of the scrapers effectively keeps the discs clean.

No matter what standard light tractor you have, the adjustable hitch of this harrow enables you to secure full tractor efficiency.

No.	No. of Discs	Cut	
TDH 6	24—16 in.	6 ft.	\$97.50
TDH 7	28—16 in.	7 ft.	105.75
TDH 8	32—16 in.	8 ft.	133.75
Extra for 18 in. Discs,			30c. per Disc.

## E-B OSBORNE BINDER

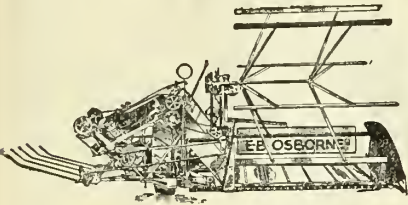

Judge the E-B Osborne by the results it has given your neighbors and other Osborne binder owners. In seasons of heavy growth it has bound and dropped bundles about a foot apart, and has picked up down grain that was thought entirely lost. Under the worst conditions it cuts a surprisingly clean stubble and binds reasonably good bundles. These facts are what make the E-B Osborne binder so desirable in a wet or stormy season. You cannot go wrong by getting an E-B Osborne, because you are then prepared for every emergency that may arise.

6 Ft. With Bundle Carrier.....	\$210.00
7 Ft. With Bundle Carrier....	216.00
8 Ft. With Bundle Carrier and Tongue Truck.....	242.50
Transport or Truck, additional	9.60
Tractor Hitch for Binder...	10.25

## E-B OSBORNE CORN BINDER

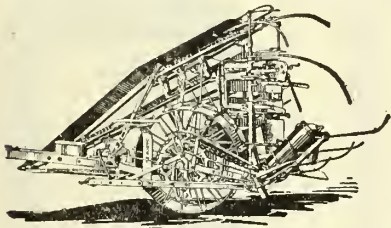

More nearly eliminating side draft on the E-B Osborne corn binder has made it pull casier and wear longer than others. Side draft is reduced by balancing the operating strain on opposite sides of the main wheel. All power is taken from the left side of the main wheel, but the work of cutting and binding is all done at the right of the main wheel. This balancing of the operating mechanism makes it possible to cut corn with less power.

On most corn binders the pole is at the left of the main wheel. The pole on the E-B Osborne corn binder is directly in front of the main wheel. This is another good feature which lessens side draft. It is a fact you will see more E-B Osborne corn binders pulled by two horses than any other make of corn binder.

With Swinging Bundle Carrier \$210.00

## E-B MODEL AA TRACTOR

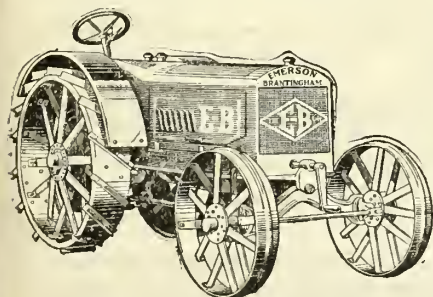

WRITE FOR CATALOG AND PRICES

## SELF-DUMP HAY RAKE

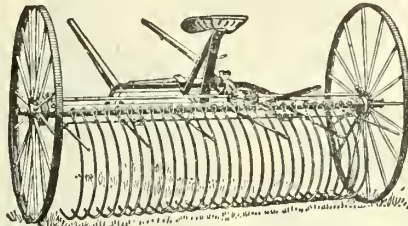

**E-B SELF-DUMP HAY RAKE—1st.** Truss under frame prevents sagging whether teeth are raised or in raking position. 2nd. Reversible axles provide four wearing surfaces. 3rd. Automatic Lock Down enables any boy to do a man's work in the hay field with the E-B Rake.

8 Ft. 20-Tooth Rake.....	\$41.00
8 Ft. 25-Tooth Rake.....	41.50
9 Ft. 28-Tooth Rake.....	44.60
10 Ft. 32-Tooth Rake.....	47.00

## STEEL TEDDER

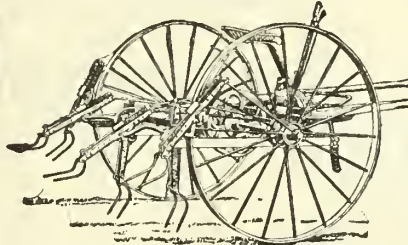

Well-built, large ground wheels, free from vibration. Center chain drive.  
6-Fork, \$75.00. 8-Fork, \$81.75.

## E-B GEARLESS LOADER

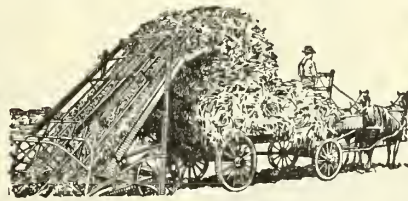

A One-Man Machine.

No cogs to wear. No gears to strip. No springs to weaken. No combination of ropes and slats to rot and break. No chains to break, slip or stretch. Strictly a one-man loader. Moves with slow, easy stroke like a hand rake in the hands of an expert.

No. 1, 6 Ft. Gearless Loader with Side Arms.....	\$123.75
No. 11, 8 Ft. Gearless Loader with Side Arms.....	129.60
No. 14, 6 Ft. Cylinder Loader..	115.80

## E-B MANURE SPREADER



No. 1 Low Down Spreader.....	\$170.00
Brake.....	7.80
Side Boards.....	4.20
Tractor Hitch.....	6.00

## E-B STANDARD MOWERS

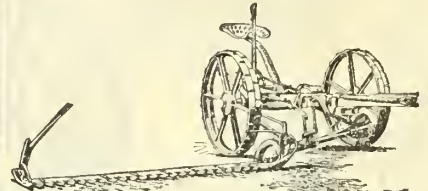

E-B Standard Mowers have led for years. They are famous for their light draft, efficient work, strength and ease of operation. Some of the features of the E-B Standard Mower are a wide track to insure steady running and no side draft, cutter-bar weight carried on wheels to increase traction and decrease neck weight, main frame in one piece, no friction on knife because bar is always straight when operating and a reversible wearing plate at the back of the sickle that doubles the life of the plate.

No. 3, 4½ Ft., Foot Lift.....	\$ 83.75
No. 5, 5 Ft. Foot Lift.....	85.00
No. 6, 6 Ft., Foot Lift, High Truck.....	95.60
No. 8, 8 Ft., Foot Lift, High Truck.....	104.75
Vertical Lift, on 4½ and 5 ft. only, add.....	1.25

## E-B OSBORNE MOWER

Mower cuts a clean swath, has strong drag bar, Extra Bearings for Hinge Coupling. The heavy drag bar is stiffened by a tie rod reaching across from the push bar. This is unusually strong construction.

No. 1, 3½ Ft., 1 Horse.....	\$75.25
No. 2, 4½ Ft., 2 Horse.....	78.00
No. 2, 5 Ft., 2 Horse.....	79.25
For Vertical Lift, add.....	1.25

## E-B SIDE DELIVERY RAKE AND TEDDER

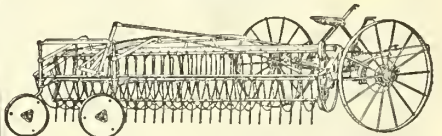

Changed from Side Rake to Tedder by moving a lever. Eccentric botton to teeth does not break nor roll the hay. Lever convenient to operator, raises or lowers the teeth without stopping the team. Weight of operator forward of axle increases traction of drive wheels and decreases weight on rear wheels.  
No. 166, 8 Ft.....\$115.00

## E-B GEISER AND PEERLESS THRESHERS

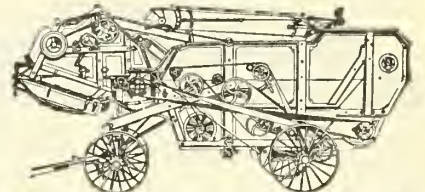

SPECIAL CATALOG AND PRICES ON REQUEST

## E-B GEISER SAWMILLS

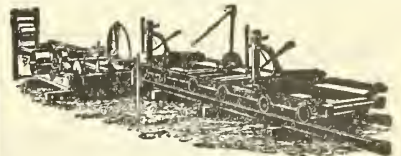

Made in 3 Sizes.  
A SPECIAL SIZE TO SUIT YOUR REQUIREMENTS

## Blocki Windrowers and

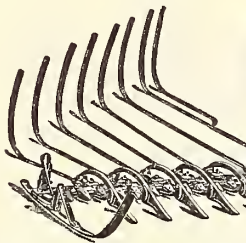

## Pea Harvester

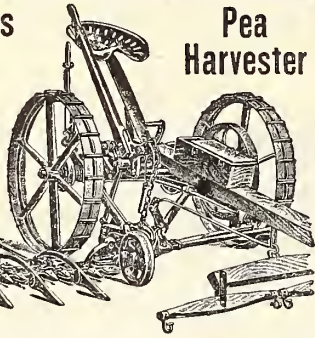

Use the Blocki Windrower for harvesting the seed crops of red, alsyke, mammoth and alfalfa clovers. Sometimes also used for harvesting flax, buckwheat, and even short tangled grain. Is an excellent tool to harvest cow peas, beans, etc. Can be readily attached to any mower and gives the best satisfaction. The guards are strong, being made of malleable iron; the rods retain their shape because they are made out of the right kind of steel.

Blocki Pea Harvester No. 7X consists of 7 Guards, 7 Rods and Divider.

Blocki Pea Harvester No. 8X consists of 8 Guards, 8 Rods and Divider.

Blocki Pea Harvester No. 9X consists of 9 Guards, 9 Rods and Divider.

**Prices:**

No. 7X.....	\$25.00
No. 8X.....	27.50
No. 9X.....	30.00
Extra Guards, each.....	3.00
Windrower for 4½- or 5-ft. Mower.....	15.00
Windrower for 6-ft. Mower.....	17.25

## The Schick All Steel Baler

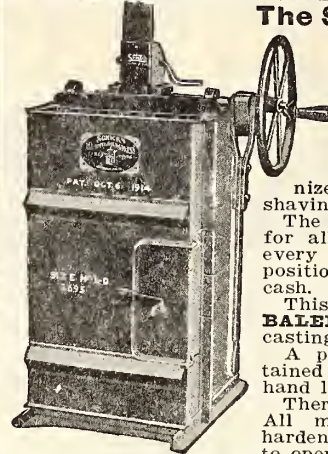

This baler is a device that is so low in initial cost that the material which it conserves pays for it in a short time. It bales all kinds of material, such as paper, scrap, pasteboard boxes, excelsior, cloth clippings, old rags, tobacco stems, tin and galvanized scrap in can factories, steel shavings in machine shops, etc.

The great and increasing demand for all kinds of waste material of every description has put you in a position to change this waste into cash.

This shows the top of the **SCHICK BALER**. Note the solid one-piece casting supporting the geared rack. A pressure of three tons is obtained by means of the wheel and hand lever.

There are but five working parts. All made of crucible steel, case hardened, making it easy and simple to operate.

As waste paper accumulates it is emptied into the **Schick**; a turn of the wheel compresses it. When bale is compressed it is wired and ready to remove from the press.

No. 2—Open Top Schick All Steel Baler Bales, from 100 to 150 pounds.....	\$ 70.00
No. 3—Open Top Schick All Steel Baler Bales, from 150 to 200 pounds.....	85.00
No. 4—Open Top Schick All Steel Baler Bales, from 200 to 350 pounds.....	125.00

## LINK CHAIN BELTING

No.	Links per ft.	Av. Ult. strength lbs.	Price plain links	Price link
25	13.3	700	15c.	3c.
32	10.4	1100	16c.	3c.
33	8.6	1190	15c.	3c.
34	8.6	1300	17c.	3c.
35	7.4	1200	18c.	3c.
42	8.75	1500	19c.	4c.
45	7.4	1600	16c.	3c.
48	6.	1660	20c.	4c.
50	8.7	1900	22c.	5c.
51	10.4	1900	23c.	6c.
52	8.	2300	23c.	5c.
52½	7.9	2866	30c.	6c.
55	7.4	2200	20c.	5c.
62	7.25	3100	27c.	6c.
65	5.66	2460	29c.	8c.
72	5.9	4240	48c.	8c.
72½	7.25	4590	52c.	9c.
76½	5.8	3890	35c.	9c.
77	5.2	3600	32c.	9c.

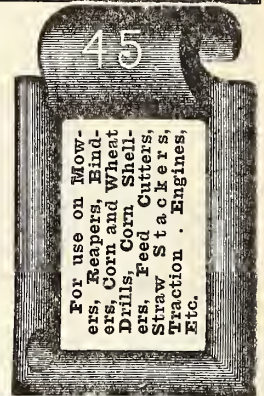

## KEYSTONE TONGUE SUPPORT

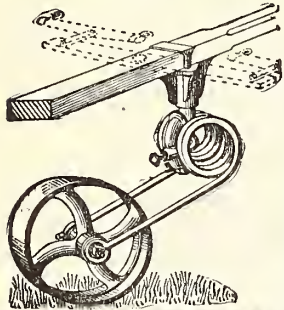

For Harvesting Machinery and Disk Harrows.

This Tongue Support is simple and light in weight. The springs are made of best 5/8-inch spring steel. The coils are 4½ inches in diameter, and have arms extending 12 inches. The wheel is 11½ inches high, with 2¾-inch tread, thus assuring a light draft. No holes need to be bored in the tongue to fasten this support, thus allowing the tongue all its strength. **Price, \$5.00.**

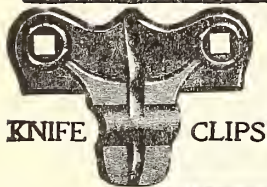

KNIFE CLIPS



WOOD PITMANS

PITMAN STRAPS OR CLASPS

## BINDER CANVAS SLATS

Each, 10c.

## WEARING PLATES

### KNIFE CLIPS

To Fit the Following Machines:	Price, Each.
Champion, A413, A468, A467, A693.....	.15
Deering, F94, E461.....	.15
McCormick, M254, M533, H496, H919, L39.....	.15
McCormick, M290, M293, M652.....	.25
Milwaukee, J1, Osborne, E36.....	.15
Osborne (Columbia), K256.....	.15
Plano, J46, J106, J325.....	.15
Wood, 171, 1432.....	.15

### WOOD PITMANS

(Without Pitman Box and Bolts.)

To Fit the Following Machines:	Price, Each.
Deering (Ideal Mower), 1901 and since, D1471.....	\$1.75
McCormick (Big 4 Mower), 1896 and since, M392.....	1.75
Milwaukee (No. 6 Mower), 1894 and since, PN290.....	1.75

### WEARING PLATES

To Fit the Following Machines:	Price
Champion, H315, Under Shoe Cap.	
Champion, H282, Under Clips.	
Deering, D1038, Under Clips.	
Deering, 1040, Under Shoe Cap.	
Deering, D1455, Under Shoe Cap.	
McCormick, M468, Under Clips.	
McCormick, M490, Under Shoe Cap.	
Milwaukee, PK156, Under Clip P.J1.	
Milwaukee, PG157, Under Shoe Cap.	
Osborne, K325, Under Clips.	
Osborne, K326, Under Shoe Cap.	
Price .....	\$0.15

### PITMAN STRAPS OR CLASPS

To Fit the Following Machines:	Price
Malleable Deering, D464, D465, D605, D606, D470, D607, Each.....	\$ .30
Malleable McCormick, M556, M557, M147, M304, M315, Each.....	.30

## SPRING COTTERS



Assorted, box of 100.....75c.

## PITMAN WOODS

Finished and Bored, Without Straps, Bolts and Boxes. To fit the following machines: Deering (Ideal Mower), McCormick (Big 4 Mower), Milwaukee (No. 6 Mower), Plano (Jones Mower). Each, 60c.

## PITMAN BOLTS

To Fit the Following Machines:  
 Deering Knife End, Deering Box End, McCormick, M322, with Nut; M483, with Nut 2½x7-16; with Nut 3x7-16, Milwaukee, with Horn Nut, PG174, Milwaukee, with Ratchet Nut, PG175, Osborne, Box End (Long), Osborne, Knife End (Short), Wood, with Nut.....\$ .15

**ALL PRICES IN CATALOG SUBJECT TO CHANGE WITHOUT NOTICE.**

PITMAN BOXES

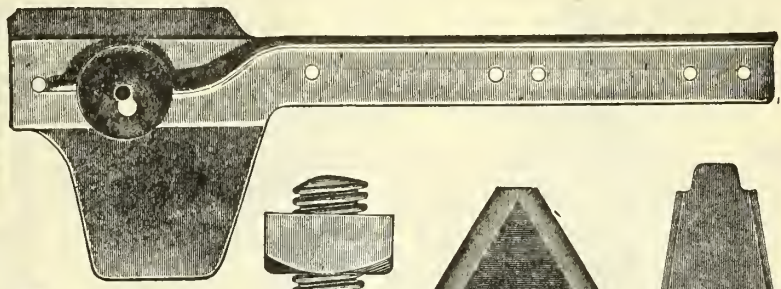
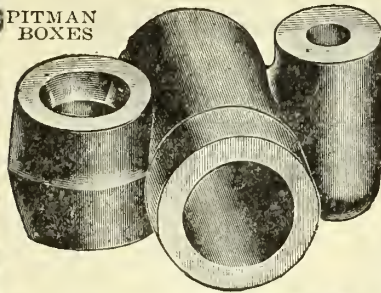

KNIFE HEAD.



GUARD.

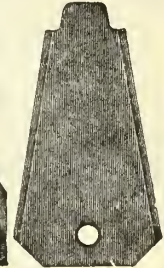
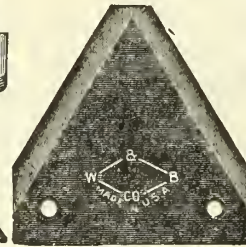

GUARD BOLT. SMOOTH SECTION. LEGER PLATE.

## MOWER SMOOTH SECTIONS, KNIVES AND GUARDS

Made to fit the following Machines.	Size of Section.	Retail Price of Section	No. of Guard.	Retail Price of Guard	No. of Knife Head.	Retail Price of Knife Head.	Knives complete.		Pitman Boxes No.	Retail Price of Pitman Boxes.
							4 1/2 ft.	5 ft.		
Wood.....	3x3 1/4	\$.08	L	\$.35	K366	\$.55	\$3.00	\$3.25	AK124	\$1.45
Wood.....	3x3 1/4	.08	2355	.35	2479	.55	3.00	3.25	A2301	1.45
Wood.....	3x3 1/4	.08	A	.35	1680	.55	3.00	3.25	A2301	1.45
Wood.....	3x3 1/4	.08	L	.35	2862	.55	3.00	3.25	2941	1.20
Wood.....	3x2 5/8	.08	P. P.	.35	1810	.55	3.00	3.25		
Deering.....	3x3 1/4	.08	D698	.35	D463	.55	3.00	3.25	D711	.65
Deering.....	3x3 1/4	.08	D698	.35	F123	.85	3.00	3.25	D334	.90
McCormick....	3x3 3/16	.08	M462	.35	M139	.55	3.00	3.25	M317	.60
McCormick....	3x3 1/16	.08	M253	.35	M139	.55	3.00	3.25		
Champion.....	3x3 3/16	.08	A881	.35	A870	.55	3.00	3.25	B683 1/2	.30
Champion.....	3x3 5/16	.08	A 41	.35	A415	.55	3.00	3.25		
Champion.....	3x3 9/16	.08	A 42	.35	A415	.55	3.00	3.25	A747	.75
Champion.....	3x3 3/16	.08	A811	.35	A415	.55	3.00	3.25		
Osborne.....	3x3 3/16	.08	K514	.35	K774	.55	3.00	3.25	K826	.80
Osborne.....	3x3 High Punch	.08	K280	.35	K284	.55	3.00	3.25	K278	.80
Osborne.....	3x3 Low Punch	.08	K 72	.35	K212	.55	3.00	3.25		
Johnston.....	3x3 3/8	.08	1811	.35	2211	.55	3.00	3.25	2207C	.75
Johnston.....	3x3 1/8	.08	77	.35	124	.55	3.00	3.25	257	.75
Plano.....	3x3 1/4	.08	J110	.35	J 94	.55	3.00	3.25	J100-J99	.70
Milwaukee.....	3x3 1/4	.08	P.K.5	.35	P.G.6	.55	3.00	3.25	P.J.50	.70
Adriance Buckeye	3x3 3/8	.08	3087	.35	557F	.55	3.00	3.25		
Dain.....	3x3 3/16	.08	Z 5	.35	Z 4	.55	3.00	3.25	Z162	.80

## BINDER SICKLE SECTION, GUARDS AND KNIVES

Machines. Made to fit the following	Size of Section	Retail Price of Section.	No. of Guard.	Retail Price of Guard.	No. of Knife Head.	Retail Price of Knife Head.	Knives complete		
							6 ft.	7 ft.	8 ft.
Wood Binder.....	3 x2 3/8	\$0.08	W	\$0.35	H 2139	\$0.55	\$3.50	\$3.75	....
Wood Binder.....	3 x2 3/16	.08	H171	.35	H 1150	.55	....	....	....
Deering Binder.....	3 1/4 x2 1/4	.08	286	.35	H 877	.55	3.50	3.75	\$4.00
Deering Binder.....	3 1/4 x2 1/4	.08	286	.35	H 260	.55	3.50	3.75	4.00
McCormick Binder.....	3 x2 1/4	.08	H495	.35	B 23	.55	3.50	3.75	4.00
Champion Binder.....	3 x2 3/8	.08	U 53	.35	1852	.55	3.50	3.75	....
Osborne Binder.....	3 x2 1/4	.08	D300	.35	B 587	.55	3.50	3.75	....
Johnston Binder.....	3 x2 3/8	.08	50 A	.35	L 296	.55	....	....	....
Plano Binder.....	3 x2 3/16	.08	L 300	.35	L 395	.55	3.50	3.75	....
Plano Binder.....	3 x2 1/2	.08	L 67	.35	L 66	.55	3.50	3.75	....
Milwaukee Binder.....	3 1/4 x2 1/4	.08	J 76	.35	H 41 3/4	.55	3.50	3.75	....
Adriance Binder.....	3 x2 1/2	.08	1265	.35	1245A	.55	3.50	3.75	....

Leger Plates for all Machines, 6c. each. Section and Guard Rivets, 15c. lb. Guard Bolts for all Machines, 5c. each.

Above we give a table of sizes, numbers and prices of Sections, Guards, Knife Heads and Knives complete, and combinations generally used. In some cases more than one Knife Head and Guard have been used with the same section. In ordering, always give number of Guard and Knife Head, also drawing of Section wanted, showing holes punched in Section. In ordering Knives complete, always give number of old Knife Head; also give number of cutting sections.

REAPER SICKLE.

COTTER.



SECTION AND

GUARD RIVETS



## GRIFFITH & TURNER BALL-BEARING GRINDSTONE

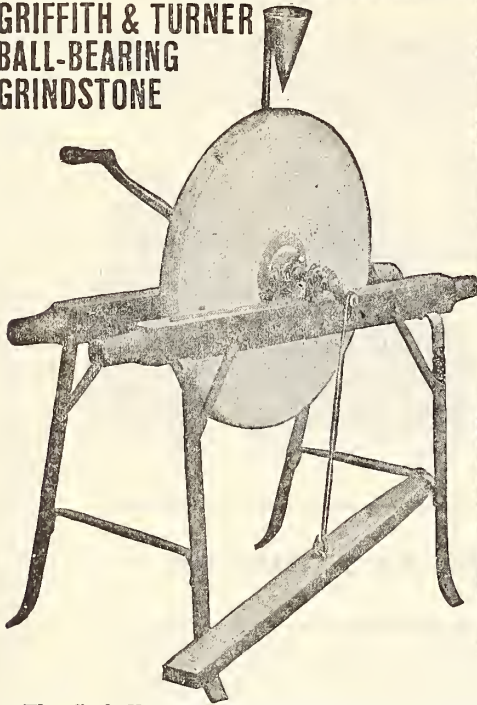

The G. & T. B. B. Grindstone has a combination steel and hardwood frame. Stone carefully selected Berea grit. Ball-bearing steel journals and axles. Stones usually furnished vary in thickness from 1 3/4 to 2 1/4 inches. Weight of frame and fixtures only 32 lbs. Shipped knocked down unless ordered otherwise. If crated, an additional charge will be made.

- No. 1 Stone, 90-110 pounds, each.....\$9.25
- No. 2 Stone, 70-80 pounds, each..... 8.50
- No. 3 Stone, 40-50 pounds, each..... 8.00

## GRITCO BALL-BEARING GRINDSTONE

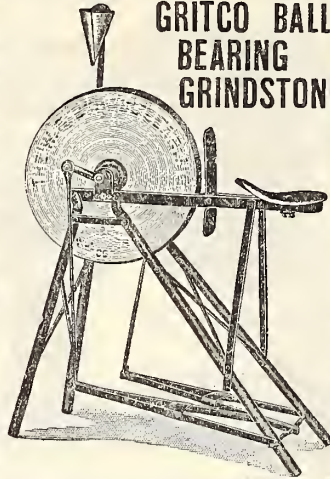

### The Gritco Ball-Bearing Grindstone

is one of the strongest built, and is practically indestructible.

PRICE .....\$9.75

## No. 82-C Sickle and Tool Grinder

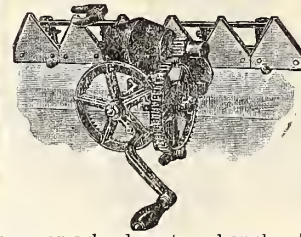

The No. 82C Grinder is a simple, compact and serviceable hand-power sickle and tool grinder especially suited to farm work. It can be clamped either to a

mower wheel or to a bench. The tool wheel is 4 1/4 x 1 3/8 inches.  
82C—With Bevel and Flat Tool Wheel 7.00  
82CW—With Bevel Wheel.....\$6.00

## No. 86 Sickle and Tool Grinder

A useful farm grinder for tools and sickle sharpening. Made especially to take care of all general grinding on the farm. This machine can be quickly attached to a mower wheel or bench.

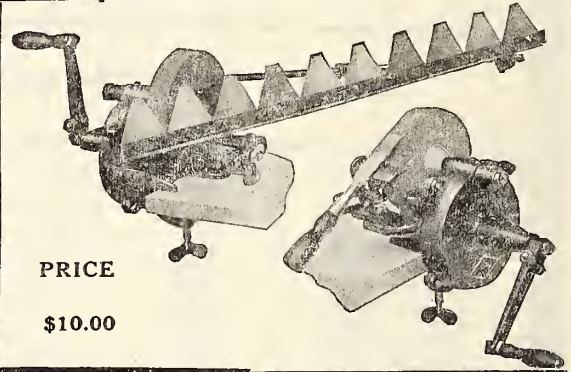

PRICE  
\$10.00

## Gritco Wood Frame Bi-Pedal Grindstone

Thickness of Stones, 1 3/4 to 2 1/4 inches.

- No. 100 Stone, 100-110 lbs.....\$10.50
- No. 200 Stone, 70-80 lbs..... 9.75
- No. 300 Stone, 40-50 lbs..... 9.00

## Gritco Wood Frame Grindstone

With Foot Pedal and Hand Crank.

- No. 1 Stone, 100 to 110 pounds.....\$8.50
- No. 2 Stone, 70 to 80 pounds..... 7.75
- No. 3 Stone, 40 to 50 pounds..... 7.00

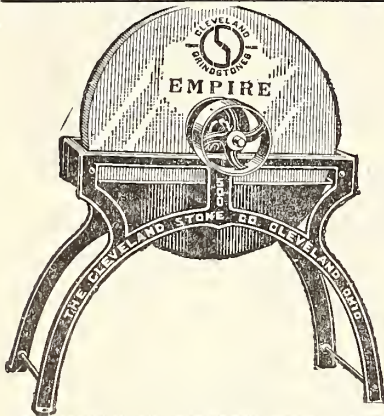

## Empire Iron Frame Power Grindstone

The EMPIRE is equipped with genuine Berea Stone, 24 inches in diameter and 2 inches to 3 1/2 inches thick. This is the most efficient and best grit produced for general use, and especially for farm tools.

Weight, complete, about 225 pounds.

Price, complete, \$27.00.

## Farmers' Special Power Grindstone

(Wood Frame)

Price, complete.....\$19.25

## Harvest King Power Grindstone

Price, regular, which includes 24-in.x2-in. Stone; 12-in.x2 1/2-in. Pulley, Hand Crank and Drip Cup.....\$13.50

Cast Grindstone Fixtures with Shaft.

15-in., per set, 80c. 17-in., per set, 90c. 19-in., per set, \$1.00.

## TOOL GRINDERS

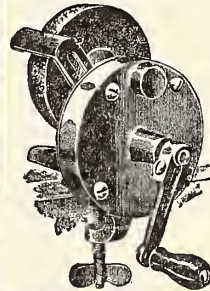

- No. Z2C—Kitchen Grinder, with smooth stone for sharpening knives.....\$2.50
- No. 24B3—It is equipped with a 4x3/4-in. Grinding Wheel, and is intended for a Household Grinder. Weighs 6 lbs. boxed. Price.....\$3.25
- No. 25B—It is equipped with a 5x3/4-in. Grinding Wheel, and will be found a very handy tool for mechanics. Weighs 7 lbs. boxed. Price.....\$3.75
- No. 26B—It is equipped with a 6x1-in. Grinding wheel. Weighs 11 lbs. boxed. Price.....\$5.50

## No. 309-C POWER BENCH GRINDER

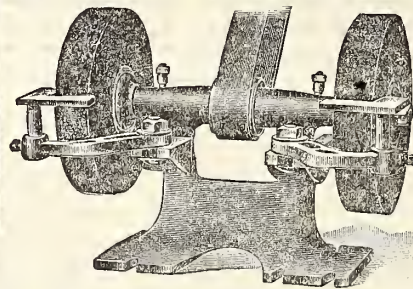

This grinder is constructed along the best mechanical lines. It can be bolted to any bench and its heavy design makes it the ideal grinder for power of any sort. It is equipped with two sharpening wheels of Light Dim-O-Grit, 7 inches in diameter and 1 1/4 inches wide, one medium grit and the other coarse,

and two universally adjustable tool rests. Weight, boxed, 32 pounds. PRICE.....\$16.00

No. 306 Power Bench Grinder.....\$8.00

## We carry a full line of loose stones

Prices: From 40 lbs. to 200 lbs., per lb., 4c. Under 40 lbs., per lb., 4 1/2c. Over 200 lbs., per lb., 4 1/2c.

## Standard Belt Power Press

This is our Standard Belt Power Press, for use with tractor or traction engine. It is an ideal outfit for the custom baler, fitted with traction jointed tongue of angle steel for either tractor or horses, and complete equipment ready to hitch on and start on the road.

It is a sturdy, fast outfit, good for years of profitable work and will return its purchase price with interest every year to any baler who has a good round of custom baling to do.

The following items are furnished with the press at the purchase price—

- |   |                        |
|---|------------------------|
| Alarm Bell,   | Road Brake,            |
| Automatic Relief Clutch                                 | Tongue, Doubletrees,   |
| Feeder,   | Neckyoke, Tool Box,    |
| Belt Power Transmission,                                | Wrench, Oil Can,       |
| Plain Pulley,   | Four Division Boards,  |
| Four Way Tension,                                       | Extension Feed Table,  |
| Automatic Block Dropper,                                | Feed Fork, Tail Board, |
| Steel Wheels (Front 30                                  | and Windshield.        |
| in., Rear 34 in., 4 in. grooved tires and 56 in. tread. |                        |

**PRICES:**

- |  |          |
|--|----------|
| 16 x 18 Standard Belt Power Press..... | \$660.00 |
| 17 x 22 Standard Belt Power Press..... | 675.00   |
| 14 x 18 Light Belt Power Press.....    | 515.00   |
| 16 x 18 Light Belt Power Press.....    | 525.00   |

All F. O. B. Factory.

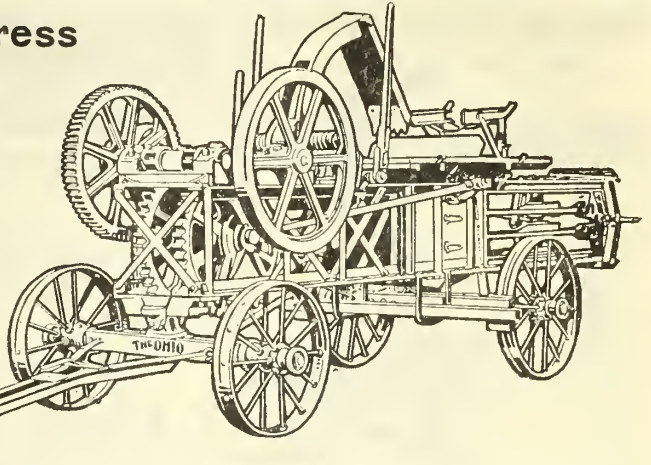

## Baling Ties

**Cross Heads**



Measure around the bale and add three inches to get the proper length. We carry 8½ and 9 ft. Cross Heads and 9 and 9½ ft. Single Loop. Can furnish any other stock size or style.

**CROSS HEAD BALE TIES**—9-ft. No. 14, \$3.50. 8½-ft., No. 15, \$2.75. 9-ft. No. 15, \$3.00.

**SINGLE LOOP BALE TIES**—9-ft., No. 14, \$2.25; 9½-ft. No. 14, \$2.35. 8½-ft., No. 15, \$1.85. 9-ft., No. 15, \$1.90. A bundle contains 250 ties.

**ANNEALED BALING WIRE**—Nos. 11, 12, 13, 14, and 16 always on hand at lowest market prices on application.

Special prices in quantity to Threshermen and Balers.

## No. 9 Royal Pea Huller

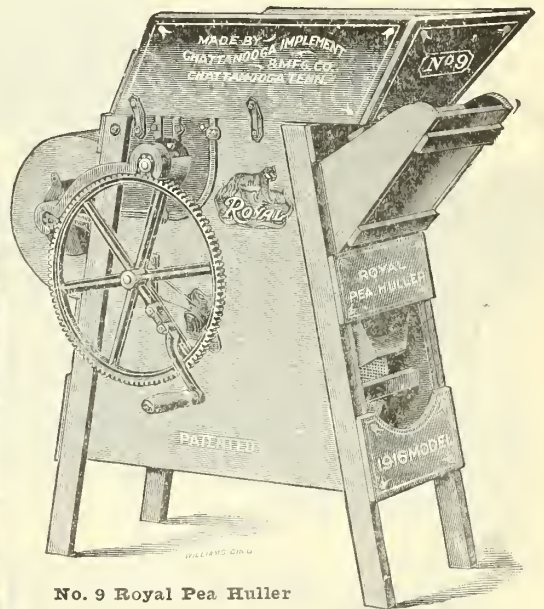

No. 9 Royal Pea Huller

## Owen's Bean and Pea Thresher

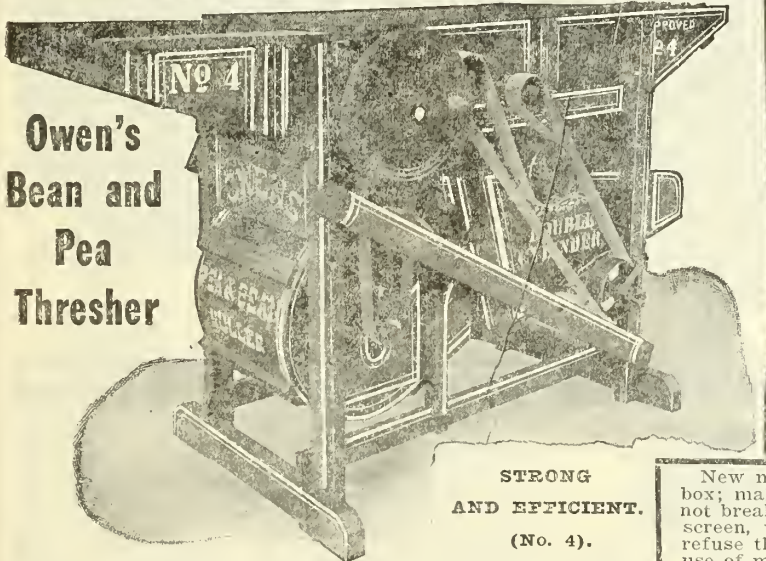

**STRONG AND EFFICIENT.**

(No. 4).

It will thresh all varieties of beans and peas directly from the vines as taken from the field, without splitting the grain; and at the same time shred the vines, the same as the larger size threshers. We wish to make one exception to the above, and that is in cow peas, where the vines grow very rank and heavy. You will readily see that, on account of its size, the No. 4 could not possibly be expected to handle these like one of our larger threshers, but where the vines do not grow too large and where care is exercised in feeding, it does very good work, indeed. We have shipped a great many of the No. 4 threshers to all parts of the South, and they are giving excellent satisfaction, especially with those who simply wish to save the seed and do not care for a large capacity. Capacity, 10 bushels per hour. One to three horse-power.

The No. 4 will also thresh buckwheat. Weight, 400 pounds. Price, \$185.00

New model No. 9, with heavy bearings, wooden frame and box; malleable iron cylinder and concave sections. Teeth do not break. Heavy fly-wheel and two cranks. Patent revolving screen, which insures absolutely clean peas and carries the refuse through a separate outlet. Reversible hopper to allow use of machine for cleaning wheat of other small grain. Cleans and threshes the peas thoroughly without breaking them. Shipping weight, 260 pounds. Can be furnished for operation by power by substituting a pulley and heavier shaft for one of the cranks at an additional net cost of \$2.50. Cow Peas intended for seed should be allowed to get more mature. These will unavoidably lose most of the leaves, but will still be good feed after the Peas are picked and threshed.

The **ROYAL PEA HULLER** will save a larger per cent. of all the Peas than any other method. The ownership of a Royal Pea Huller represents an outlay so small in comparison to the benefits, that no successful farmer will be without one.

Special and exclusive features to be had only with these machines are covered by patent, and cannot be had in any other make. Capacity, 8 to 15 bushels Dry Peas per hour. Price, \$60.00.

**MARYLAND LEVER CUTTER**

Strong, Cheap and Durable.

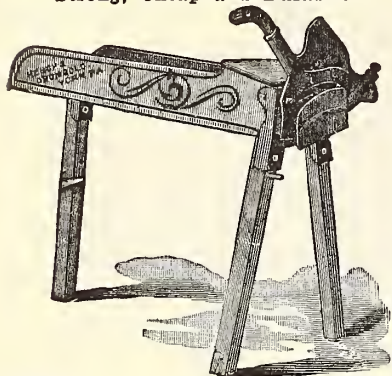

Retail .....\$7.50

**CYLINDER TYPE HAND CUTTER**

**One and Two Knife**

No. 11½—"TWO-KNIFE."—The feeding rolls on this cutter are operated by means of cog wheels and sprockets. The feed is constant and uniform, and the cutter has large capacity. The feed rolls are equipped with coil tension springs; the cutter has large heavy flywheel, large crank, chilled shear bar and hardwood frame; length of cut, ¼ inch, ½ inch and 1 inch. Special gears for cutting ⅛ inch can be furnished on order.

OUR SPECIAL PRICE, \$34.50

**PONY CUTTER**

No. 11¼—"ONE-KNIFE," \$27.50.

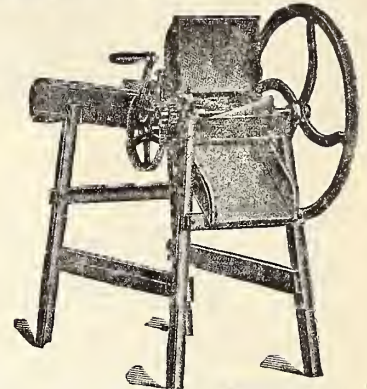

**Baltimore Improved Grain Fan**

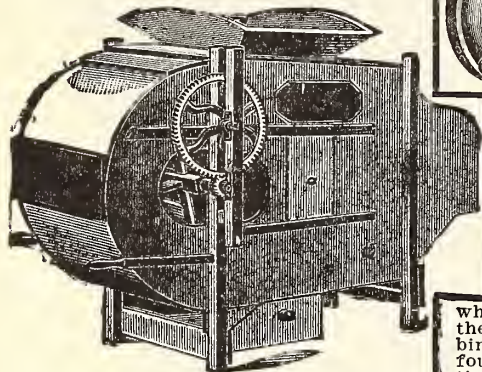

Will clean from 60 to 100 bushels per hour. Made of best material and finished in a neat and tasty manner.

List Price, \$67.26.

Our Special Price, \$42.00.

Sieves, List Price, each, \$3.00.

Retail, \$2.00.

**Ross Standard Hay and Fodder Cutter**

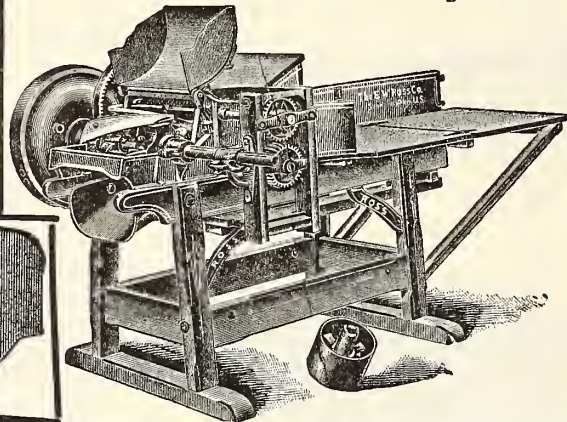

The excellence of the Ross Fodder Cutters is well known. They are the result of over 50 years' experience in manufacturing this class of machinery. They are built strong and durable, possess valuable features for convenience and efficiency, and are neatly finished. The manufacturers aim to construct a line of cutters which will not only do the work, but do it so well that the buyer is sure to be pleased in every way. On account of lack of space, we cannot give a full description of the exclusive patented features possessed by the **Ross Cutters**, but will be pleased to mail to anyone interested in the purchase of a cutter a special catalogue of the **Ross** line. Will mention briefly here that some of these features are:

Very efficient feeding rolls, which are positive, and which are provided with a knuckle-joint arrangement to allow the rollers to readily adjust themselves to uneven feeding of the machine without binding or causing friction; a special comb bar for keeping the spiked roller clear; a four-sided reversible steel cutting plate; an improved type of safety flywheel; a practical and convenient knife adjustments; a special starting and stop lever, and the **Ross** folding feed table.

Size	Knives Inches	Capacity per Hour on 1-Inch Cut		Power Required H. P.	Weight Pounds	Price with Either Cutter or Shredder		Price of 12-Foot Angle and Straight Carrier Retail
		Ensilage Tons	Dry Fodder Tons			Cylinder Retail	Application	
No. 111	4-11	3 to 4	1 to 1½	2 to 3½	425	\$70.00		

Shredder Cylinder: If both shredder and knife cylinders are wanted, write for prices.

**Ross No. 30, No. 40, No. 50, and No. 60 Cutters and All Steel Blowers**

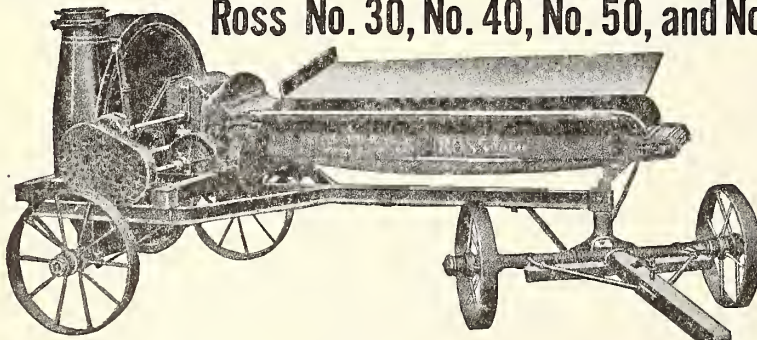

The knives on flywheel type of Ross Silo Filling Machines with Blower have made a home for themselves with all their users. This is due to the fact that they possess the required strength and features to enable them to accomplish the work of filling silos in a way that brings comment from all. Realizing the fact that users of this class of goods expect more and more each year in the line of quality and quantity of work, they possess features fully described in the special catalogue, which we will be pleased to mail, namely: Four-sided reversible steel cutting plate, positive tension to the feeding rolls, special knife adjustment, self-aligning and adjustable main shaft bearings and roller shaft bearings, extra bearings for main shaft, special balanced main frame, etc.

Size.	Throat Capacity.	Capacity per Hour on 1-Inch Cut. Ensilage.	Power Required.	Weight Without Truck.	Cutter with Traveling Feed Table and Blower, with 30-ft. Blower Pipe and Elbow.		Blower Pipe, Including Elbow, per Foot.	Sets Shredder Blades and Attachments.
					Pr. with Truck.	Retail.		
No. 30	38 sq. ins.	4 to 6 tons	6 to 8 H. P.	500 lbs.	\$187.50	\$75		\$12.75
No. 40	55 sq. ins.	6 to 8 tons	6 to 8 H. P.	1250 lbs.	262.50	.85		12.75
No. 50	72 sq. ins.	8 to 10 tons	8 to 10 H. P.	1450 lbs.	277.50	.85		13.50
No. 60	85 sq. ins.	12 to 18 tons	12 to 14 H. P.	1800 lbs.	296.25	.85		22.00

ALL PRICES IN CATALOG SUBJECT TO CHANGE WITHOUT NOTICE.



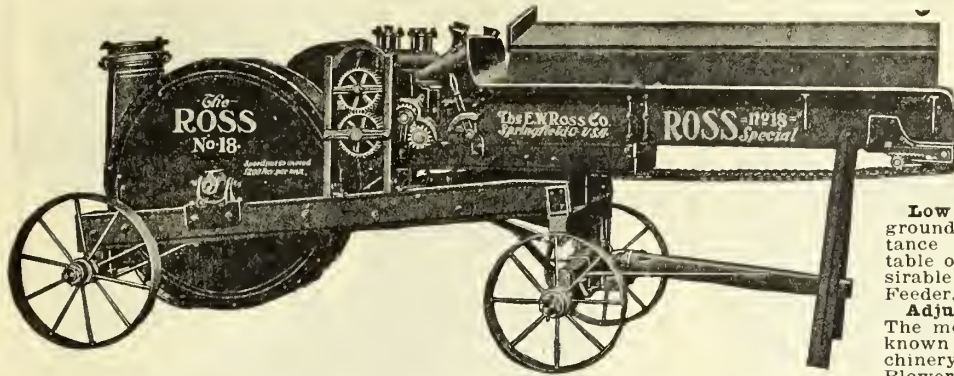

## Ross Improved Ensilage CUTTER

With Traveling Feed Table and All-Steel Blower.

The illustration represents the Ross line of Silo Fillers especially designed for heavy work, such as large Plantations or by Threshermen for jobbing work.

Low Down, so that feeder stands on the ground instead of up on machine. Distance from ground to top of traveling table only 3 feet 9 inches. The most desirable machine made for convenience of Feeder.

Adjustable Bearings for Blower Shaft. The merits of the adjustable bearing are known to all practical operators of machinery. No excuse whatever for the Ross Blower Bearings heating or running hard or consuming extra power.

Blower Casing, with Swivel and Tilting Rings. Combination Toothed and Fluted Feed Rollers with Comb Bar Attachment. Steel Shear Bar with Four Cutting Edges. This feature is accountable for the class of work turned out by the Ross. Start, Stop and Reverse Lever. This arrangement saves many a break and prevents delays of various natures. Traveling Feed Table. Folds up for convenience in moving from place to place and when storing away. Steel Cutting Cylinder. This is a point that must not be overlooked. If saving of time and repairs is worth anything, the ROSS SILO FILLER is worth double the price of any other. Steel Blower. No manufacturer likes to hear of their "Cast Iron" Blowers exploding on large size cylinder type Silo Fillers, but it will occur as long as it is made of Cast Iron. If our example was followed, and the Blower made of SOLID STEEL, like THE ROSS, the welfare of Silo users would then be taken care of. Capacity, Durability, Simplicity in Construction and Quality of Work have been the principal objects in the construction of Ross Silo Fillers. If these claims are not convincing, order the ROSS SILO FILLER and give it a trial. The results will be far more convincing than our claims.

Size.	Knives.	Capacity per Hour on 1-Inch Cut. Ensilage.	Power Required.	Weight.	Table and Blower with 30 ft. Pipe and Elbow Mounted on Truck.	Extra Galv. Pipe, per foot.	Two Shredder Blades, Extra.	Prices on Application
No. 18	4—18 inch	15 to 18 tons	12 to 16 H. P.	2800 lbs.	\$300.00	\$.85		
No. 20	4—20 inch	18 to 22 tons	15 to 20 H. P.	2900 lbs.	\$325.00	\$.85		



Alfalfa water-proof belting is a belt woven especially with a view of obtaining great tensile strength. Nothing but the finest long staple cotton is used.

	List.	Our Price.
2-inch, 4-ply.....	\$0.40 ft.	20c. ft.
3-inch, 4-ply.....	.51 ft.	25c. ft.
4-inch, 4-ply.....	.70 ft.	35c. ft.
5-inch, 5-ply.....	1.08 ft.	54c. ft.
6-inch, 5-ply.....	1.24 ft.	62c. ft.

We have been able to develop by the use of the best raw material obtainable, and by a direct system of impregnation a fabric belt, which has a breaking strain of 6,730 pounds per square inch, which is equal to, of not in excess of, the breaking strain of any belt that has been produced.

RUBBER BELTING			
	List.	Retail.	
3-in., 3-ply..	.55c. ft.	30c. ft.	5-in., 3-ply.. \$0.87 ft.
3-in., 4-ply..	.65c. ft.	36c. ft.	5-in., 4-ply.. 1.02 ft.
4-in., 3-ply..	.70c. ft.	39c. ft.	6-in., 4-ply.. 1.22 ft.
4-in., 4-ply..	.82c. ft.	45c. ft.	

Special Prices for Larger and smaller sizes on application.

## Cut Raw-Hide Belt Lacing



	List Price.	Retail Price.
3/8-inch, per 100 feet.....	\$3.75	\$3.00
1/2-inch, per 100 feet.....	5.50	4.40
5/8-inch, per 100 feet.....	6.50	5.15
3/4-inch, per 100 feet.....	7.50	5.95

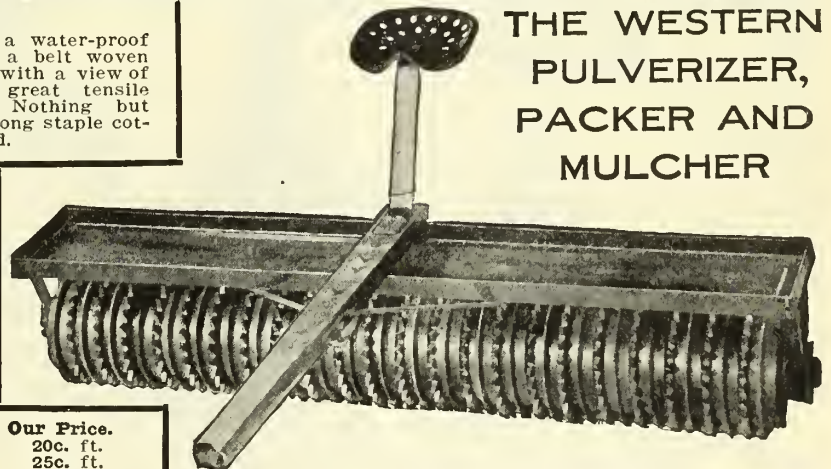

## THE WESTERN PULVERIZER, PACKER AND MULCHER

- For making a perfect seed bed.
- For mulching or cultivating small grain in the spring.
- For breaking the crust on grain or cotton fields, to allow young sprouts to come through.
- For packing down soil heaved by frost and sprouts of wheat or clover in early spring.
- For pulverizing soil in corn and tobacco fields before and after cultivating and on other plant crops to insure good cultivating and yields.
- For packing down sod.
- For crushing and pulverizing clods.

Is a great improvement over all other kinds of packers or field rollers of every known make, whether single or double type. The WESTERN is a machine made up of two series of wheels, but has the advantage of having them all mounted on one axle so that the combined packing and crushing power of both series of wheels is delivered at one time and at one point and is not divided as in double gang machines. This fact no one can dispute and that packing and firming and pulverizing of the soil as deep as plowed is all important.

Size and Length over all.	Weight,	Price
4-ft. Single section with shaft for one horse..	500	\$50.00
7-ft. Single section, medium two horse.....	800	80.00
8-ft. Single section, large two horse.....	900	90.00
10-ft. Single section, medium four horse.....	1,130	100.00

## THE BALTIMORE SHELLERS

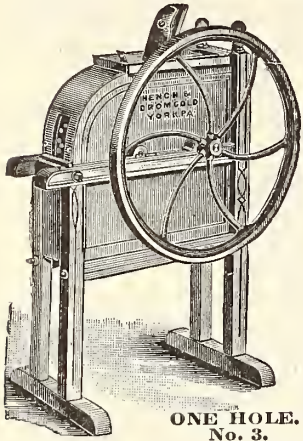

**ONE HOLE.  
No. 3.**

Separates corn and cob. Corn discharged beneath Sheller, cobs at end. Easily adjusted for large or small ears. Capacity, 125 bushels a day. 130 pounds.

**Plain, List Price, \$25.00  
Our Special Price, \$15.00**

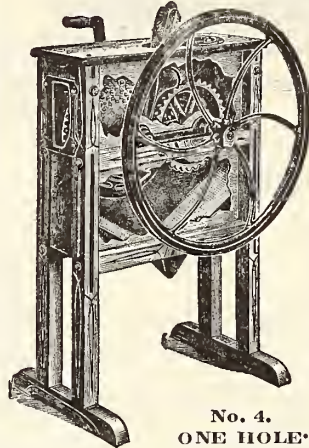

**No. 4.  
ONE HOLE.**

Screens corn; side delivery; light running; strong, steel shafts. Capacity, 125 bushels a day. 130 pounds.

**Plain, List Price, \$25.00  
Our Special Price, \$15.00**

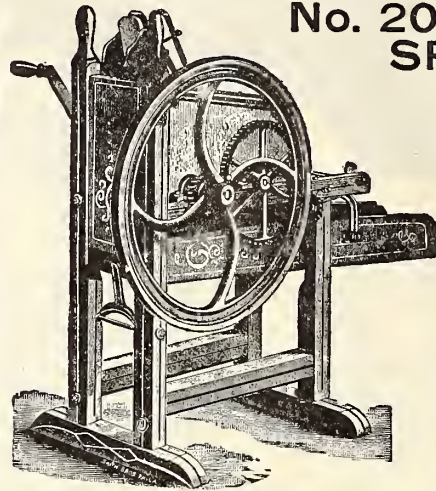

**No. 20 DOUBLE  
SPOUT**

This sheller is built very strong from the best materials, and has a combination fly-wheel and pulley.

Hand and power, with shaker belt and flywheel. Capacity, 200 bushels per day. Capacity by power, 500 to 600 bushels.

Weight, 300 lbs.

**No. 20, with h  
shaker, List Price,  
\$60.00: Our Special  
Price, \$36.00.**

## "BLACK HAWK" Corn Sheller

Weight, 14 lbs.  
Shells Fast, Clean  
and Easy.

Black Hawk is simple, easily adjusted and will shell clean all kinds of field corn.

List Price,  
\$4.50 each.

Our  
Special  
Price,  
Each,  
\$3.00.

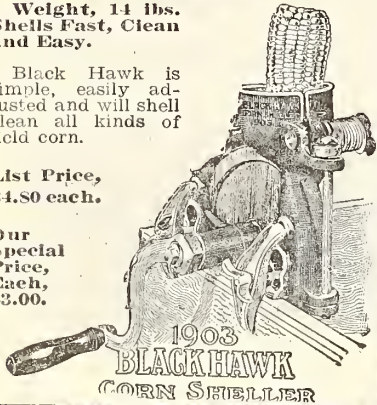

## RED CHIEF CORN SHELLER

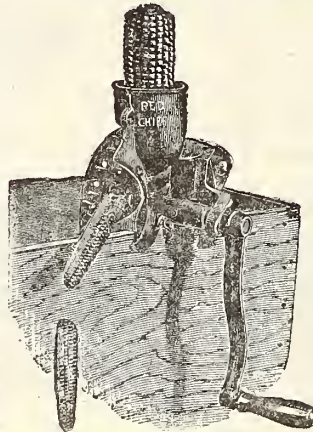

adjusts itself to any size ear.

List Price, each, \$4.50. Our Special Price, each, \$2.75. Weight, 12 pounds.

This sheller is guaranteed to do good work. It is heavy in construction, with patent oval-shaped teeth, which are so arranged to shell more rapidly and avoid injuring the grain, thus making it safe for shelling seed corn. Ad-

## REMOVABLE BASKET HANDLES



These handles are of great assistance in handling fruit and vegetable baskets.

They are automatic in operation, and the grip is sure. Made from high-grade steel, and will last a lifetime. Handles three times as many baskets in the same time.

List Price, 40c. Our Special Price, 30c.

## No. 20 RED CHIEF GRINDING MILLS

COMBINED HAND AND POWER MILL.

No. 20—Power Mill for two-horse engine; tight and loose pulley, best of bronze boxes and cold rolled steel axle, capacity 10 to 20 bushels per day. Has no equal.

Our Special Price.....\$22.00

Corn Sheller Attachment, shells the corn and grinds at the same time, extra.

Our Special Price.....\$10.00

Table Meal Separator, makes fine table meal while grinding stock feed, extra.

All burrs are as hard as can be made, and all of our mills will grind in a satisfactory manner dry borie, oyster shells, old china, etc. New Feed Gauge enables the operator to grind fine without mill turning hard. New Burrs will grind fine and quick.



**No. 20**

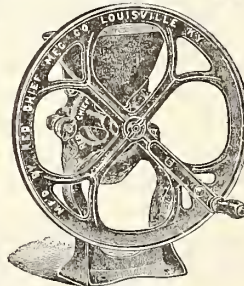

**No. 20**

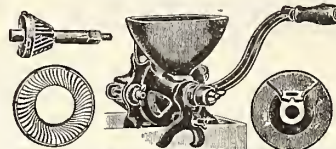

## RED CHIEF GRINDING MILLS

No. 1—For Small Poultry Raisers. Price.....\$ 4.00

No. 2—Best Crank Mill on Earth. Feed gauge to regulate grinding. Price..... 5.50

No. 5—With large capacity, feed gauge and fly wheel. Clamps to box. Price..... 7.75

No. 10—With feed gauge, fly wheel and handsome stand to screw on table. Price.... 9.50

No. 12—Best Hand Mill on Earth; bronze boxes, steel axle, large fly wheel. Price..... 16.00

No. 15—Power Mill for one-horse engine; strong, durable and easy running. Price.. 16.00

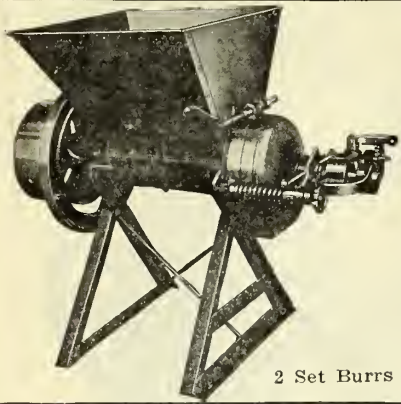

## Nos. 106, 108, Stover Special Feed Grinding Mills

**For Grinding Dry Ear Corn, Shelled Corn, and All of the Small Grains.**  
 Capacity, from 3 to 6 bushels per hour per horse power, depending upon the grinding condition of the grain and the fineness of the feed.  
 These mills, while somewhat lighter in construction, are equipped with the same style of white iron or chilled steel grinding burrs used in the corresponding sized mills.

No.	Speed, R. P. M.	Pulley	Horse Power Required	Weight	Price
106	6 in. 300 to 500	12x4 in.	2 to 5	200 lbs.	\$31.00
108	8 in. 400 to 600	12x6 in.	3 to 8	275 lbs.	42.50
31	6 1/2 in. 200 to 750	12x4 in.	2 to 5	225 lbs	41.50

2 Set Burrs

## No. 68 Stover Combined Grinder

The No. 68 Stover General Purpose Grinding Mill will reduce to a fineness satisfactory for feeding all classes of live stock, poultry, etc., hay, straw, stalks, vines and roughage as well as ear corn with or without the shuck and all of the threshed grains.

Capacity, Grains and Kaffir Corn, 3 to 6 bushels per hour per horse power. Capacity, Hay or Stalks, etc., 3 to 5 tons per day.

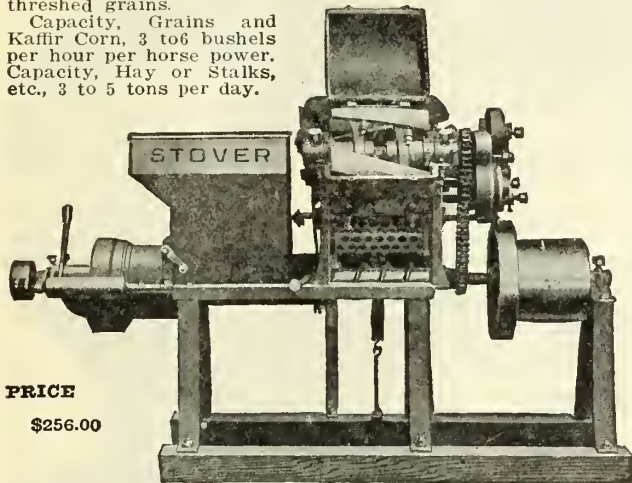

**PRICE**

\$256.00

### SPECIFICATIONS

Power required.....	8 to 20 H. P.
Speed .....	600 to 1,000 R. P. M.
Weight .....	1,000 lbs.
Pulley, regular.....	10 in. x 8 in.
Burrs, diameter.....	8 in.

## NO. 45 STOVER FEED MILLS

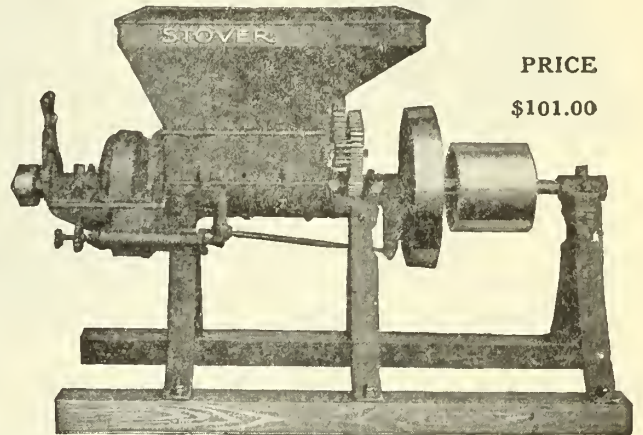

**PRICE**

\$101.00

Capacity, 3 to 6 bushels per hour per horse power, depending upon grinding condition of grain and fineness of feed.

This mill will grind more rapidly and produce a greater capacity per horse power applied than any mill of corresponding size on the market today.

This grinder has many outstanding features, the most prominent being cast iron breaker case, cast iron legs, feed regulator and feed plate, safety spring, safety lever, agitator, one-piece cob breaker, Universal grinding burrs, pivoted rear burr, and especially designed ball bearing cage for taking up end thrust, and all vital parts made of white iron or sometimes called chilled steel.

Regularly equipped with outboard bearing as illustrated above. Lack of space permits only a brief description. Our grinder catalog illustrating and describing all mills in detail, mailed to anyone interested.

### SPECIFICATIONS

Speed, R. P. M.....	400 to 800
Horse power.....	12 to 25
Pulley .....	10 in x 8 in.
Burrs, diameter.....	10 in.
Weight .....	555 pounds

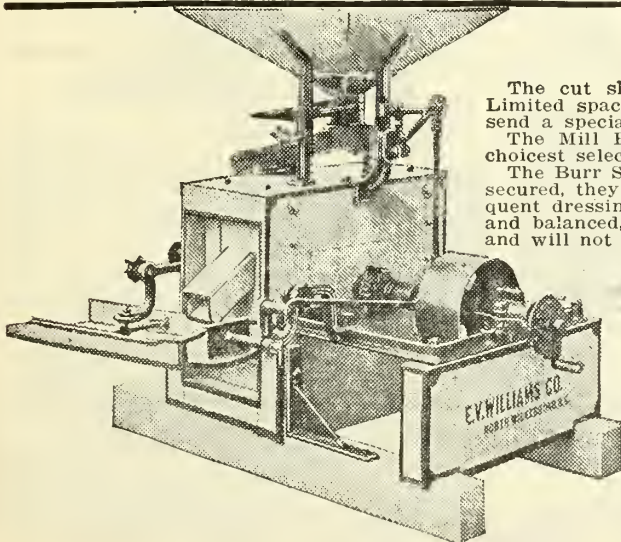

## "Williams" Advance Burr Mill

The cut shows the general design of the "Williams" Advance Burr Mill. Limited space prevents us from giving a full description, but we will gladly send a special circular giving full description and information.

The Mill Body is constructed in the most workmanlike manner, from the choicest selected forest timber, all well dried and very heavy.

The Burr Stones used in these mills are the very best Burr stock that can be secured, they are well mated and will give great service without requiring frequent dressing. They are mounted on large steel spindles and perfectly true and balanced, and are so arranged that they cannot be set too close together, and will not drift together when the grain runs out.

The grain hopper is large, with an improved feeding arrangement.

The high speed cleaning fan, latest improved folding bolter, the latest and most perfect burr adjustment, makes this the lightest running and nicest appearing mill on the market.

No.	Size of Burrs.	Weight.	Speed.	Horsepower.	Capacity per Hour.	Size of Pulley.	Our Special Price.
No. 14"-B	700	900	3 to 6	4 to 8	10 x 5	\$103.00	
No. 16"-B	800	800	3 to 7	6 to 10	12 x 6	113.25	
No. 20"-B	900	750	6 to 12	8 to 14	12 x 6	135.00	
No. 24"-B	1200	700	10 to 15	10 to 20	14 x 6	168.50	
No. 30"-B	1750	550	12 to 25	14 to 30	16 x 8	254.00	

## "JUNIOR" DOUBLE CAGE HAND APPLE MILL

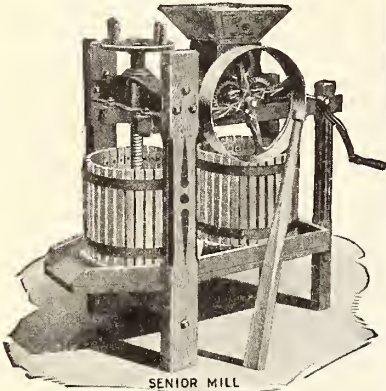

SENIOR MILL

This is a small double cage mill of good capacity, and will work in a very satisfactory manner. It is made of hardwood and, having specially constructed grinders, gives good results. Capacity, 2 to 4 barrels of juice per day. Weight, 220 lbs.

**Our Special Price.....\$30.00**

## "MEDIUM" DOUBLE CAGE HAN APPLE MILL



Is a good size for family use. It is built with iron beam and heavy gearing, and is perfectly adjustable for all sizes of apples. Capacity, 6 to 8 barrels of juice per day. Weight, 240 pounds.

**Our Special Price.....\$35.00**

## BALTIMORE SPECIAL APPLE AND BERRY MILL

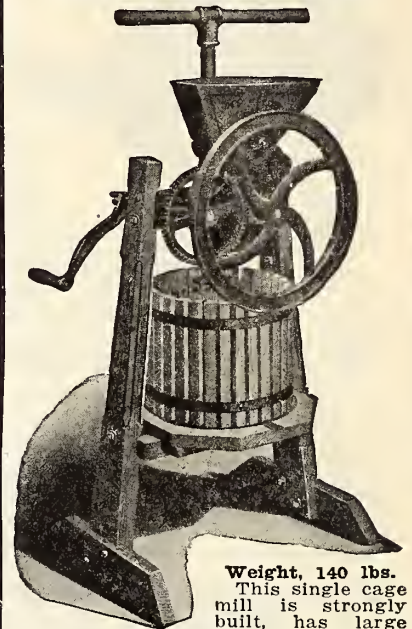

Weight, 140 lbs.

This single cage mill is strongly built, has large Capacity Grinder which will take larger apples, and being a geared mill, will do very rapid work.

**Our Special Price.....\$20.00..**

## WAGNERS FRUIT & LARD PRESS



**Our Price.**  
 2-Quart ..... \$5.00  
 4-Quart ..... \$6.75  
 6-Quart ..... 7.50  
 8-Quart ..... 8.35  
 Stuffing Attachment 1.50

## "Senior" Hand and Power Apple Mill

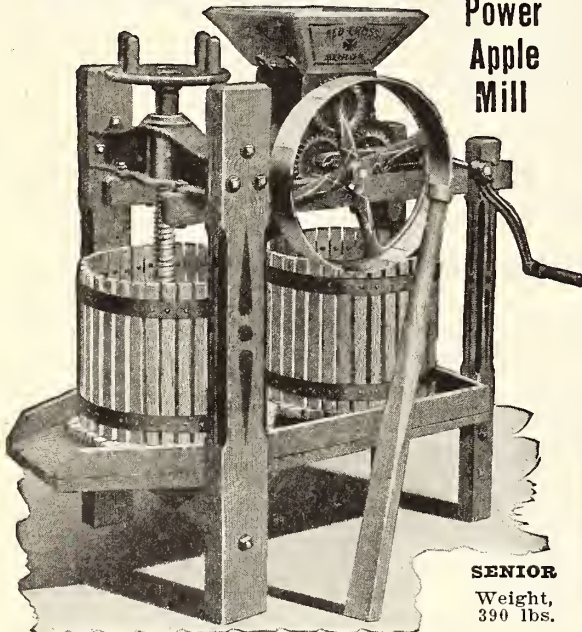

**SENIOR**  
 Weight, 390 lbs.

They have adjustable Rollers and Feed Regulator and Double Crank. In these Mills the lower rollers are cast with alternate rims and grooves interlocking to draw in the Fruit, which is mashed between the smooth segments, thoroughly breaking all the apple cells so that juice is entirely extracted in press. Balance wheels are heavy and mill can be run by power. The mills are very strong. They are made of best material, nicely finished, and are easy to operate. Capacity, 6 to 12 barrels of juice per day. **Our Special Price, \$52.50**

## Grape Crusher

- No. 2. Hoosier Crusher ..\$9.00
- No. 1 Red Cross Crusher ..15.00

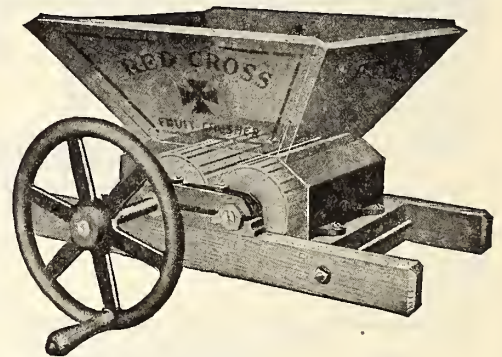

## BERRY PRESS

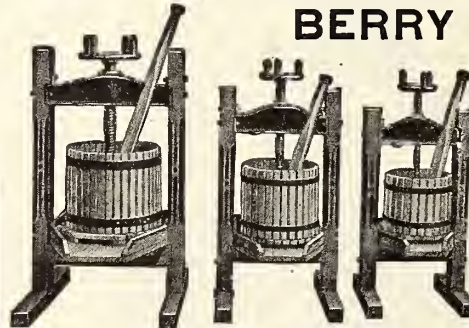

These presses are built heavy like the apple mills. The head block is heavy cast iron, giving it great strength. The frame is strong and rigid. The heavy screw wheel with long lever gives great power in pressing out the juice.

- No. 1.....\$14.00..
- No. 2..... 18.50
- No. 3..... 24.00

## Light Berry Presses

- No. 1 W .....\$ 8.50
- No. 2 W ..... 10.00
- No. 3 W ..... 17.00

**ALL PRICES IN CATALOG SUBJECT TO CHANGE WITHOUT NOTICE.**

## STOVER TILTING TABLE SAW NO. 52

The table is of the slat type, has five flat steel strips or braces bolted to the same and bent at right angles so as to form a rigid guard for the wood. This construction adds materially to the life of the table, as the wood to be sawed does not come in contact with wood part of the table at any part of the frame. When the wood is thrown on the table it rests on the steel strips and when the wood is pushed toward the saw the steel braces carry the strain. The frames are strongly and carefully built and with ordinary care and attention will last indefinitely.

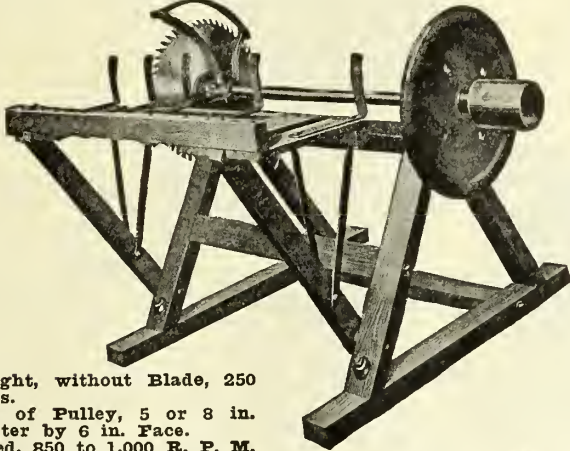

Weight, without Blade, 250 Pounds.  
 Size of Pulley, 5 or 8 in.  
 Diameter by 6 in. Face.  
 Speed, 850 to 1,000 R. P. M.

Without Saw Blade.....\$34.80  
 With 22-inch Saw..... 38.80  
 With 24-inch Saw..... 39.40  
 With 26-inch Saw.....\$40.10  
 With 28-inch Saw..... 41.10  
 With 30-inch Saw..... 42.00

## STOVER POLE SAW NO. 54

No. 54 Stover Pole Saw has the advantage of having the fly wheel underneath where it is out of the way and will permit the sawing of long poles. A compact outfit easy to move and anchor.

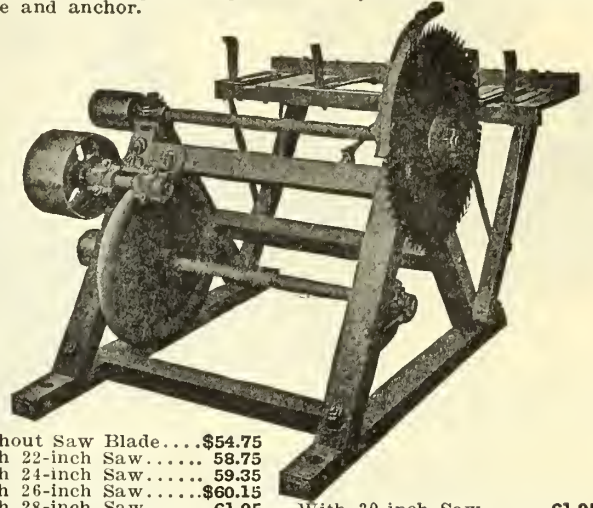

Without Saw Blade....\$54.75  
 With 22-inch Saw..... 58.75  
 With 24-inch Saw..... 59.35  
 With 26-inch Saw.....\$60.15  
 With 28-inch Saw..... 61.05  
 With 30-inch Saw..... 61.95

## STOVER NO. 57 SAW FRAME

### QUICKLY ATTACHED

The frame is carried on four castings attached to the upper and lower ends of the radiator by four bolts that run in front and in back of the radiator. Thus, you attach the Stover Frame without disturbing one snigle bolt or nut on the Fordson, also without drilling any special holes or furnishing any special equipment.

The frame is shipped knocked down with instructions for assembling with all of the equipment illustrated, and which includes the frame, 30-inch saw, sufficient length of 5-inch rubber belt, 8 x 6 inch pulley on saw mandrel, and special starting crank that slips through the frame to permit starting with the frame attached. Shipping weight, knocked down, 250 pounds.

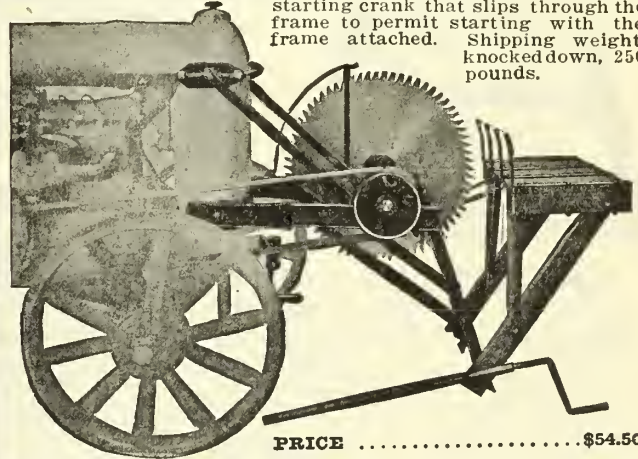

PRICE .....\$54.50

## STOVER PORTABLE SAW RIG

The under carriage is an ordinary farm truck with steel wheels heavy enough to carry our 6 H. P. engine. The channels are steel I-Beams securely bolted to the truck bolsters to which is attached our No. 56 tilting wood sawing table with self-aligning, self-adjusting bearings, that was specially designed by us for mounting on a portable rig of any description for either custom or individual work. The equipment includes plain pulley on the engine, circular saw, belt, belt idler, pole, but no neckyoke or doubletrees.

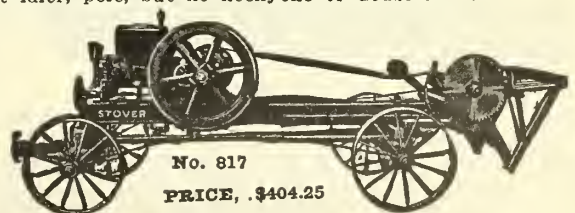

No. 817  
 PRICE, \$404.25



## SLIDING TABLE

Without Saw Blade....\$45.65  
 With 22-inch Saw..... 49.35  
 With 24-inch Saw..... 49.95  
 With 26-inch Saw.....\$50.75  
 With 28-inch Saw..... 51.65  
 With 30-inch Saw..... 52.55

## GRITCO CIRCULAR SAW



These Saws are the result of over 50 years' study and experience. Absolutely the best steel is invariably used and each blade is given a tough, even temper and perfect tension, all of which is essential to the successful running of the saw. The workmanship of these blades is unequalled. The prices given are for saws sharpened and set. All blades with 1 3/8-inch hole.

**Retail**  
 22-inch, No. 12 gauge . \$4.00  
 24-inch, No. 11 gauge . 4.60  
 26-inch, No. 11 gauge . 5.40  
 28-inch, No. 10 gauge . 6.50  
 30-inch, No. 10 gauge . 7.20

## THE AMERICAN VARIABLE FRICTION FEED SAWMILLS

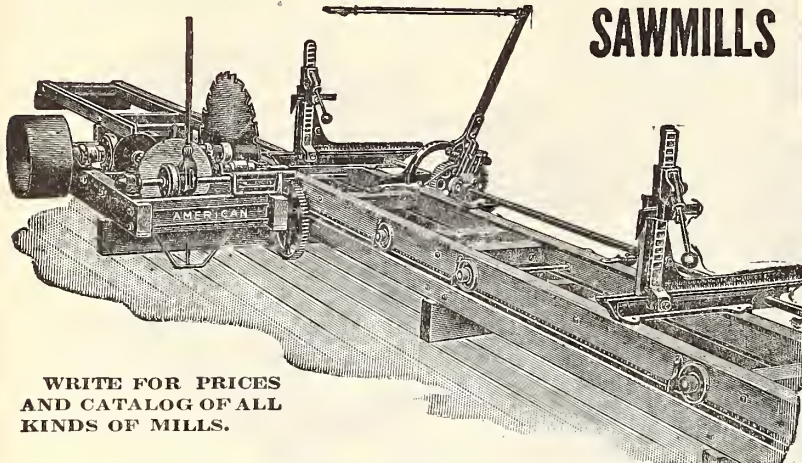

WRITE FOR PRICES AND CATALOG OF ALL KINDS OF MILLS.

American Sawmills are recognized as embodying superior design, the most advanced and up-to-date ideas, superior workmanship, and, in short, they are outfits which have been carefully thought out by designers of wide experience for the purpose of giving to sawmill operators the most practical mills possible.

A complete Standard No. 1 Mill consists of the following: Husk Frame 7 feet by 3 inches, built of 3 1/4-inch by 7 1/2-inch timbers, fitted with Variable Friction Feed, Polished Steel Mandrel 2 1/2 inches by 4 feet 4 inches long. Mandrel Pulley, 20 inches by 10 inches (unless otherwise specified); also Board Roll, Spreader Wheel and Saw Guide.

Carriage 16 feet long, 26 inches wide, built of timbers 3 1/2 inches by 5 1/2 inches, having Feed Rack 22 feet long. Four trucks with 6-inch wheels and 1 1/2-inch steel axles. 40 feet of "V" and Flat Rolled Steel Track, fitted to way timbers framed up in sections. Two head-blocks, opening 34 inches, with Chapman Duplex Dogs. "Ideal" Set Works, with Quick Receder and 14 feet of polished steel Set Shaft; also Belt Tightener, foundation bolts, cant hook, oil can and wrenches

## POWER JACK

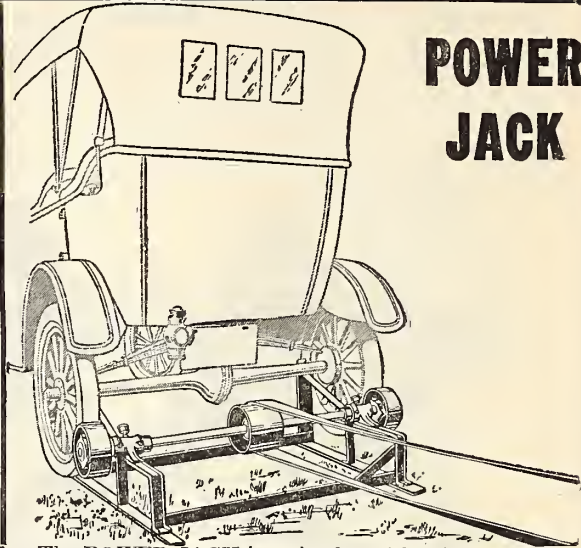

The POWER JACK is a simple and handy device for using the power of a Ford, Chevrolet, Overland or other light car to run power machinery.

It requires no special attachment to the car but is applied by simply sliding it under the rear axle and raising both wheels clear of the ground as shown in the accompanying cut. Does not injure the car or tires any more than driving over a good, level road. Will develop more than 12 H. P. and will drive a saw, feed grinder, pump, fodder cutter, etc., satisfactorily.

Is easily handled by one man and can be carried about on the side of a car.

Driving pulley has 8 in. diameter and 6 1/2 in. face. Weight about 175 lbs. Shipped knocked down.

Price..... \$48.00

## ATKINS CELEBRATED SAWS

Gritco Cross-Cut Saws, Narrow American.



### NARROW AMERICAN.

5 ft.—Our Special Price.....\$2.60  
5 1/2 ft.—Our Special Price..... 2.90  
6 ft.—Our Special Price..... 3.10

### NARROW TUTTLE.

5 ft.—Our Special Price.....\$2.50  
5 1/2 ft.—Our Special Price..... 2.75  
6 ft.—Our Special Price..... 3.00

Special Prices in Quantities.

Price of Cross-Cut Saws is Without Handle. Climax Handles, 40c. per Pair.



### GRITCO CROSS-CUT SAWS, WIDE BACK, AMERICAN.

Wide American Tooth, Silver Steel, 5, 5 1/2 and 6 Feet. Gauge, 14x16.

5 ft.—Our Special Price.....\$4.05  
5 1/2 ft.—Our Special Price..... 4.50  
6 ft.—Our Special Price..... 4.90

Tuttle Tooth, Cast Steel. Gauge, 14x16.

5 ft.—Our Special Price.....\$4.25  
5 1/2 ft.—Our Special Price..... 4.65  
6 ft.—Our Special Price..... 5.05

Special Prices in Quantities. Price of Cross-Cut Saws is Without Handle.

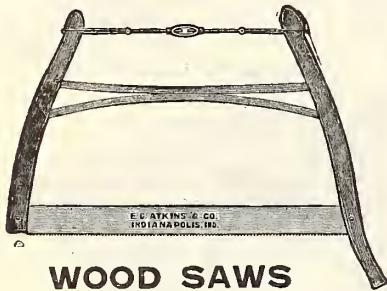

E. C. ATKINS & CO. INDIANAPOLIS, IND.

## WOOD SAWS

No. 617—Wood brace frame; single rivet; painted red; plain tooth; breasted blade; 2 1/4 inches wide. Our Special Price, \$1.10.

No. 523—Wood brace frame; single rivet; selected stock; high finish; painted red; jumbo rod tinned; Tuttle tooth; breasted blade, 2 1/4 inches wide. Our Special Price, \$1.30.

No. 923—Jumbo rod tinned; Tuttle tooth blade breasted, 2 1/4 inches wide. Double brace, double riveted. Painted vermilion and varnished. Our Special Price, \$1.50.

Wood Saw Bucks, 75c.

## HAND SAW.



## HAND SAWS.

No. 46—American straight back; plate on handle. Our Special Price, \$1.40 each.

No. 59—Sheffield Saw Works. Skew back; beech handle; polished edge, 7 to 9 points. Our Special Price, \$1.80 each.

No. 54—Silver steel; beech handle; straight back; polished edge, 7 to 9 points. Our Special Price, \$2.50 each.

No. 53—Silver steel, skew back; carved and polished apple handle, with Atkins' perfection handle. Our Special Price, \$2.85 each. Special Prices in Quantities.

## ONE MAN CROSS-CUT SAW AMERICAN TOOTH.

3 feet.....\$3.00  
3 1/2 feet..... 3.50  
4 feet..... 3.90

## PRUNING SAW.



E. C. ATKINS & CO. INDIANAPOLIS

## PRUNING SAWS.

No. 3 Double. 16-inch.....\$1.35  
18-inch..... 1.45  
20-inch..... 1.55  
No. 1 Single. 16-inch.....\$1.30  
18-inch..... 1.40  
20-inch..... 1.50  
Cant Hooks, No. 318B—2 1/2 in. x 4 ft. Price.....  
Cant Hooks, No. 318B—2 1/2 in. x 4 1/2 ft. Price.....  
Peavies, No. 9—2 3/4 in. x 5 ft. Price.....

## STAR WINDMILLS AND TOWERS

**No. 2 FOR 8 AND 10-FOOT WINDMILLS.**

Bands 5 feet apart.  
Braces 10 feet apart.

**Prices:**

Height, Feet.	Weight, Lbs.
30.....	\$46.50
40.....	67.75
50.....	94.00

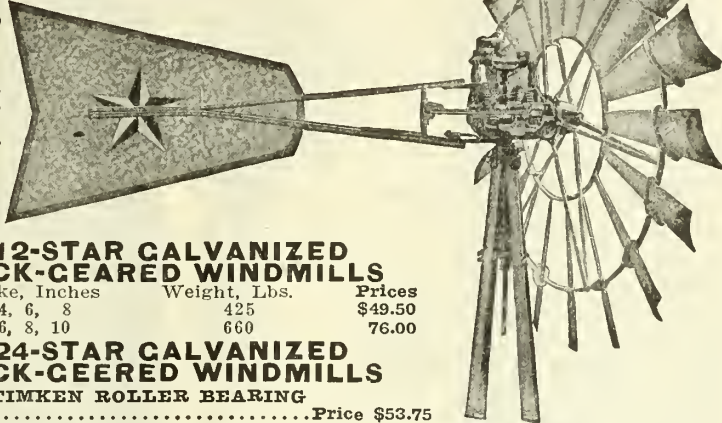

### MODEL 12-STAR GALVANIZED STEEL BACK-GEARED WINDMILLS

Size, Feet	Stroke, Inches	Weight, Lbs.	Prices
8	4, 6, 8	425	\$49.50
10	6, 8, 10	660	76.00

### MODEL 24-STAR GALVANIZED STEEL BACK-GEARED WINDMILLS

WITH TIMKEN ROLLER BEARING

8 Foot only.....Price \$53.75

## STAR GALVANIZED STEEL SUBURBAN TOWERS

FOR 8 OR 10-FOOT WINDMILLS

Star Suburban Towers come complete with anchor posts, plates and heavy steel supports for tank. Tower is of the same construction as the regular windmill towers, except the portion below the tank and the anchor posts are made of heavier material on account of supporting tank.

No.	Height of Tower, Feet	Elevation of Tank, Feet	Capacity of Cypress Tank, Bbls.	Weight of Tower, Lbs.	Price with Tank
T 4	40	20	21	1001	\$265.75
T 5	45	25	21	1186	287.25
T 6	50	30	21	1344	308.75
T 8	60	40	21	1774	364.00
T14	40	15	40	1126	326.75
T16	50	25	40	1495	375.25

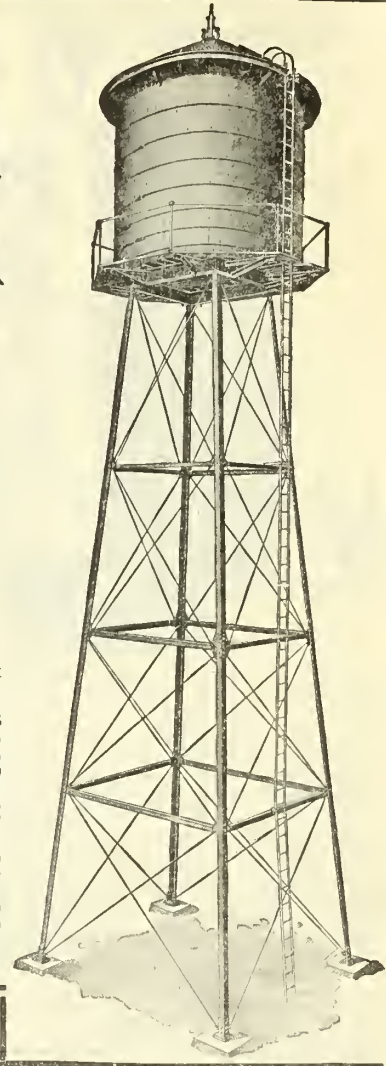

### STANDARD STEEL SUBSTRUCTURES

20-foot Tower for 6x6 Tank.....	\$87.50
30-foot Tower for 6x6 Tank.....	135.00
Steel Platform and Girders.....	17.50
Walkway and Pipe Hand Rail.....	49.50
Outside Steel Tank Ladder.....	4.10
Inside Wood Ladder.....	3.10
Steel Top Girders, only.....	9.00

For Price of Tank, See List Below.



#### ROUND-END GALVANIZED TANKS.

No.	Width, Ft.	Height, Ft.	Length, Ft.	Capacity, Gals.	Weight, Lbs.	Retail.
RE 224	2	2	4	91	74	\$12.40
RE 225	2	2	5	117	88	14.85
RE 226	2	2	6	144	102	17.25
RE2525	2 1/2	2	5	145	93	16.15
RE2526	2 1/2	2	6	178	110	19.15
RE 326	3	2	6	213	134	21.75
RE2528	2 1/2	2	8	245	141	22.90
RE 328	3	2	8	295	156	26.90
RE3210	3	2	10	384	185	31.70
RE 428	4	2	8	386	169	29.35
RE4210	4	2	10	496	203	37.10

#### ROUND GALVANIZED TANKS.

No.	Diam., Ft.	Height, Ft.	Capacity, Gals.	Weight, Lbs.	Retail.
R22	3	2	91	69	\$12.00
R42	4	2	166	97	16.00
S43	4	3	254	115	19.75
S44	4	4	338	145	24.50
S45	4	5	423	168	30.65
S46	4	6	508	191	32.50
S54	5	4	548	181	31.75
S55	5	5	675	211	33.75



### Gulf Cypress Tanks With Round Hoops and Draw Lugs

These storage tanks are made of carefully selected red gulf cypress. We avoid the use of upland or cheaper grade of cypress, and in getting tanks from us you can rely upon high-grade material and workmanship.

Prices on Larger Tanks and Covers on request.

#### PRICE LIST.

Length of Stave, Feet.	Diameter of Bottom, Feet.	No. of Hoops.	Capacity, Gallons.	Price, 1 1/2-inch Cypress.	Price, 2-inch Cypress.
3	3	3	110	\$20.75	\$25.20
3	4	3	220	28.80	36.36
4	4	4	283	36.36	44.64
4	5	4	472	49.68	62.64
5	5	5	598	61.22	76.68
5	6	5	1002	79.80	100.08
7	7	6	1701	113.40	141.64
8	8	7	2646	.....	177.48

## HOOSIER WATER SUPPLY SYSTEM

Fig. 1355-A Pump

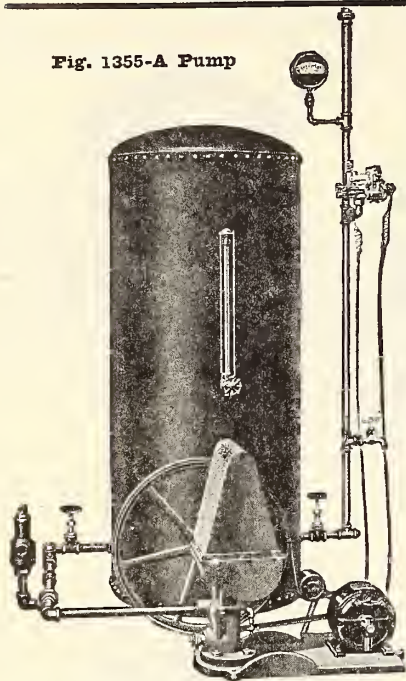

**THE COMPLETE SYSTEM.** This complete Hoosier System consists of Fig. 1341 Hoosier Electric House Pump, with motor, controller and belt, Hoosier Pneumatic Tank, vertical type, Fig. 1200 Pressure Gauge, Fig. 1201 Water Gauge, Fig. 1204 Relief Valve, gate valves, compression hose bibb, together with pipe and close fittings for connecting pump and tank, and tank and service line, as illustrated. Pipe to well or cistern not included as a part of this installation.

### Hoosier Electric House Pump

- Fig. 1341-A—With tank and fittings, 110 volt, ¼ H. P. A. C. Motor .....\$170.00
- Fig. 1341-B—With tank and fittings, 32 volt, ¼ H. P. D. C. Motor; for farm lighting outfits 170.00
- Fig. 1341. No. 1—Pump only, with motor..... 92.00

#### OTHER STYLE MOTORS. PRICES ON APPLICATION.

This Hoosier System is electrically operated, for pumping from wells from 22 to 45 feet in depth.

**THE COMPLETE SYSTEM.** This complete Hoosier System consists of Fig. 1355 Electric Deep Well Pump complete with ¼ horsepower motor for currents as specified in price list, with belt and pump base, Hoosier Pneumatic Tank of vertical type, Fig. 1350 Controller,

Fig. 1200 Pressure Gauge, Fig. 1201 Water Gauge, Fig. 1204 Relief Valve gate valves compression hose bibb, swinging brass check valve, together with pipe and close fittings for connecting pump and tank, and tank and service line, as illustrated. The pumping cylinder and well pipe are not included as a part of this installation.

- Fig. 1355-A—With tank and fittings and ¼ H. P. Motor.....\$175.00
- Fig. 1355—Without tank and fittings, but with ¼ H. P. Motor.....100.00
- Fig. 1360-A—For deep wells, with tank and fittings and ½ H. P. Motor... 235.00
- Fig. 1360—For deep wells, without tank and tank fittings, but with ½ H. P. Motor..... 142.00
- Fig. 1380—With 1 H. P. Motor..... 232.00
- Fig. 1370—Pump only for engine power..... 65.00
- Anti-freezing attachment for any of the above pumps..... 7.10

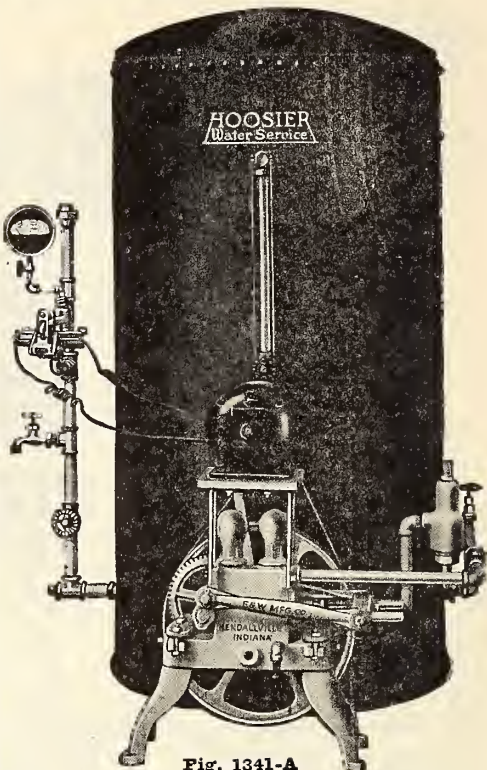

Fig. 1341-A

### Hoosier Automatic Pressure Controller

Fig. 1350—Automatic Pressure Controller is used for automatically controlling electric driven power pumps. It can be adjusted for any pressure up to 75 pounds and for a variation of 20 pounds. For domestic purposes, it is best to have it cut in and out at 30 to 50 pounds, respectively.

**OUR SPECIAL PRICE.....\$10.60**

### The Hoosier Horizontal Double Acting Power Pump

A compact high-grade double acting horizontal pump for pumping from shallow wells to pneumatic water supply systems. The whole design of this pump is with a view to compactness, strength and accurate operation. The load is well equalized.

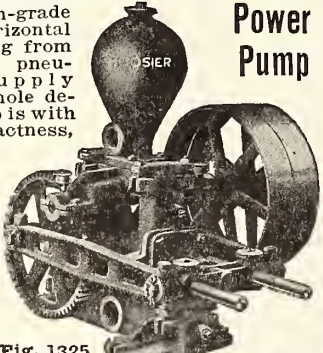

- Size of Pulley.**  
 No. 1.....10x2½  
 No. 2..... 8x3  
 No. 3.....16x3
- Tapped Inlet Outlet.**  
 No. 1 1¼ 1 in.  
 No. 2 1½ 1¼ in.  
 No. 3 2 1½ in. Fig. 1325

Fig.	Cylinder.	Capacity.	Price.
1325 No. 1.....	2½x4	510 gal.	\$50.00
1325 No. 2.....	3x5	850 gal.	85.00
1325 No. 3.....	5x5	1200 gal.	175.00
Hand Pumping attachment for No. 1.....			3.35

### Hoosier Deep Well Outfit 1370A

The complete system consists of Fig. 1370 Deep Well Pump with floor base, Hoosier Pneumatic Tank of horizontal type, with wood supports, 1½ horsepower gasoline engine, with Webster Magneto equipment, 15 feet rubber belting, Fig. 1287 Circuit Breaker, Fig. 1200 Pressure Gauge, Fig. 1201 Water Gauge, Fig. 1204 Relief Valve, gate valves, compression hose bibb, swinging brass check valve, together with pipe and close fittings to connect pump and tank, and tank and service line, as illustrated. Pumping cylinder and well pipe are not included as a part of this installation.

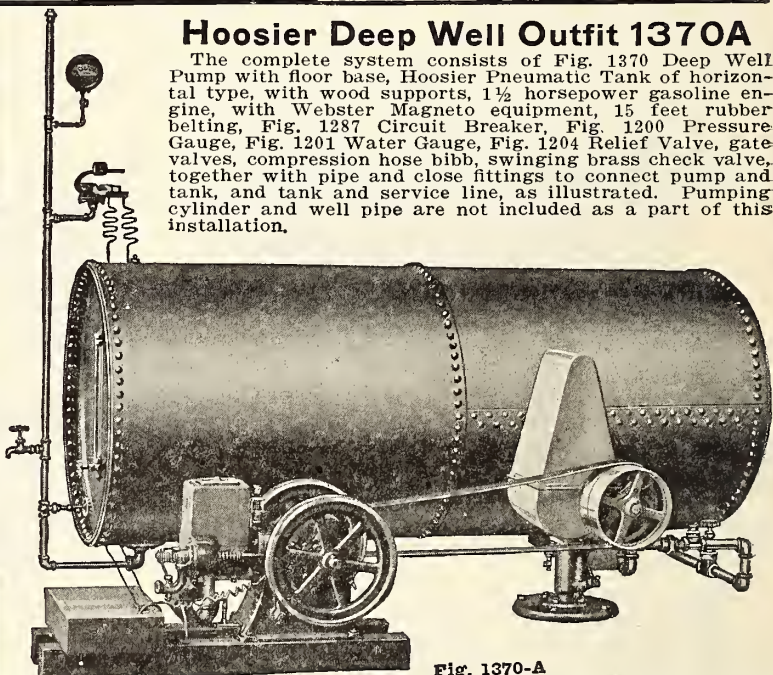

Fig. 1370-A

### Hoosier Shallow Well Outfit 1325A—With Fig. 1325 Pump

Fig.	Description	Capacity of Tank, Gallons	Weight	Price
1325-A	Complete Hoosier System, as above described, with 30-inch by 8-foot Hoosier Pneumatic Tank....	295	1125	\$267.00
1326-A	With ¼ H. P. Motor.....	295	1030	308.50

Fig.	Description	Capacity of Tank, Gallons	Weight	Price
1370-A	Complete Hoosier System, as above described, with 30-inch by 8-foot Hoosier Pneumatic Tank....	295	1150	\$283.50



## Arrow Pneumatic Tanks



**LIST OF PNEUMATIC TANKS. (Plain Tanks Without Fittings.)**

Diameter in Inches.	Length in Feet.	Weight.	Capacity in Gallons.	List Price.	Our Price.
*24	5	260	120	\$ 80.00	\$ 52.00
*24	10	645	245	130.00	84.50
*30	6	600	220	113.00	73.45
*30	10	850	365	165.00	107.25
*36	6	750	315	137.00	89.05
*36	10	1075	525	197.00	127.05

Tanks marked \* thus are vertical.  
Can furnish galvanized tanks. Prices on application.

### ACCESSORIES FOR PNEUMATIC TANK

	Our Price.
Water Gauge.....	\$5.50
Pressure Gauge.....	4.50

## Hoosier Tank Pump

Hoosier Double Acting Tank Pumps are strongly built, of very large capacity, and especially adapted for threshermen's use. The Cylinder is carefully bored and polished. The cylinder has five-inch stroke, the valves have brass valve seats, and the valves are accessible through hand-holes by removing the plugs. The suction and discharge have 2-inch openings with swivel connections. Furnished with suction connection for 2-inch pipe or 2-inch hose, and the discharge connection for 2-inch pipe or 1-inch hose.

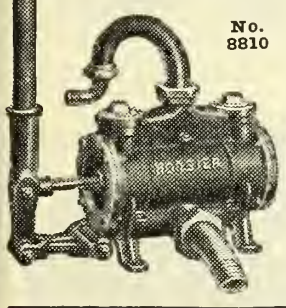

No. 8810

As the pump heads are reversible, the handle can be attached to either end of the pump.

By opening the upper and lower drainage plug, water can be drawn off the pump to prevent freezing.  
**Price, \$15.50**

## Columbia Hot Shot Battery

**COLUMBIA HOT SHOT BATTERY** is a unit battery in an attractive, moisture proof cover. Soldered copper strips connect the individually tested cells, which are entirely surrounded by a water-proof insulating compound. It is only necessary to connect two wires to the binding posts. The battery is then ready to operate. **Hot Shot** is particularly useful for ignition where the variety of sizes makes it adaptable for motors of all sorts—stationary, vehicle or motor-boat. It is very satisfactory for carriage lighting outfits. Most popular sizes—



- No. 1461M—6 volts; length 16 3/4 ins.; width 2 3/4 ins. .... \$2.25
- No. 1462 —6 volts; length 5 3/4 ins.; width 5 3/4 ins. .... 2.25
- No. 1562M—7 1/2 volts; length 8 ins.; width 5 ins. .... 2.70
- No. 1662 —9 volts; length 8 ins.; width 5 3/4 ins. .... 3.25

Other sizes quoted on application.

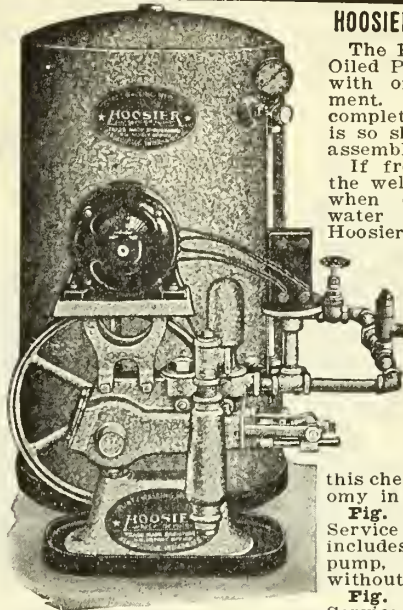

## HOOSIER GALVAZINK OILED PUMP

The **HOOSIER GALVAZINK Oiled Pump** may be had either with or without tank equipment. When supplied as a complete water service unit, it is so shipped that it is easily assembled.

If fresh water, direct from the well, is desired, so specify when ordering, and fresh water attachment, including Hoosier Silent Check Valve will be supplied at a small additional charge.

When using the Hoosier Galvazink Oiled Pump on a suction greater than 15 feet, we recommend the use of Hoosier Silent Check Valve placed vertically in the suction line, as the use of this check valve will effect economy in current consumption.

**Fig. 1950**, Hoosier Water Service Galvazink Oiled Pump, includes motor, belt, controller, pump, and vacuum chamber, without tank.

**Fig. 1952**, Hoosier Water Service Galvazink Oiled Pump, consists of **Fig. 1950** pump, motor, controller, belt and vacuum chamber, together with 18 in x 30 in. galvanized tank, capacity 33 gallons, base, gate valve, relief valve, combined pressure and water gauges, and necessary fittings for connecting pump and tank.

### SPECIFICATIONS

Fig.	Floor Space	Height	Weight Crated	Price
1950	13" x 20"	22 1/2"	113 lbs.	\$80.00
1952	20" x 32"	34"	252 lbs.	117.50

## Hoosier Horizontal Double Acting Hand Pump For Shallow Wells

**Fig. 1248**—Hoosier Horizontal Hand Pump, double acting, for general purpose work or pneumatic water service, for use where the suction is not more than 18 or 20 feet. Pump is equipped with large air chamber and rack head insuring ease of operation. It has 3 x 5 inch Brass Lined Cylinder and a 3 to 5 inch adjustable stroke. The pump is tested to 100 pounds pressure. All valve caps including suction cap, are on the outside and easily accessible. The body is detachable from the body of the pump and in case of breakage of the base it is unnecessary to purchase an entire new pump.

FIGURE 1248

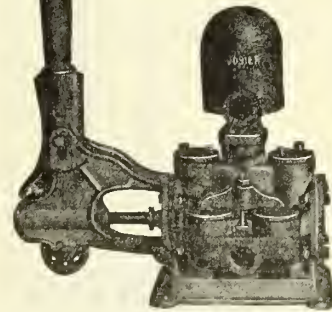

It is fitted with an intake air valve and it can pump both air and water at the same time.

Price of Pump.....\$21.25

## Columbia Dry Cell Batteries

These batteries have been the standard for quality for many years. Wherever dry batteries are used the **COLUMBIA** is known to give better service than any other make, regularly furnished in round cartons, as illustrated, but can be furnished in square cartons if desired. Where spring connections are preferred they can be furnished at the same price as the screw connections.

No. 6.

### COLUMBIA IGNITOR.

It is the highest-grade battery on the market. It is unexcelled for any service. It is particularly satisfactory for ignition, or where the current drain is high.

Price, 40 cents each.



**STOVER GASOLINE ENGINES**

**1½ H. P.**

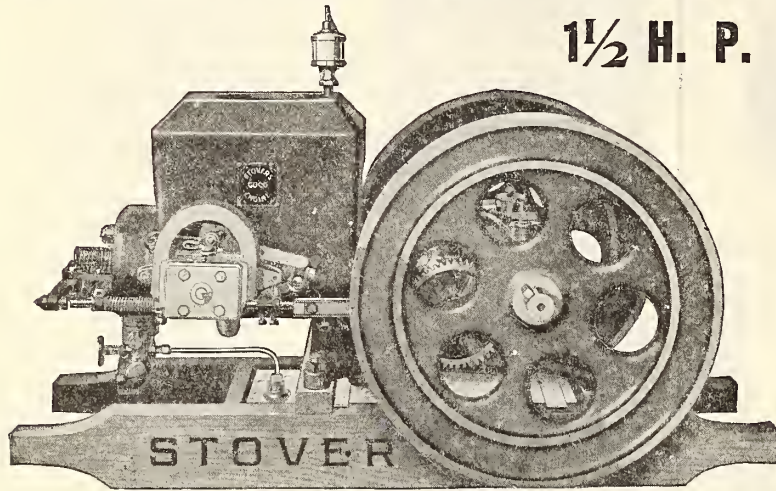

**Stover 1½ H. P. Stationary Engine. Built in Hopper Cooled Type Only. Furnished in Hit and Miss Type for Gasoline.**

The 1½ H. P. Engine is shown in the illustration. The same care and construction is given this engine as any other size, insuring the purchaser of Stover quality regardless of size. It is distinctive in design, has many outstanding features, such as water cooled cylinder head, removable die cast bearings in main frame and connecting rod with metal shims for taking up wear, grease cups on the main frame bearings, drop forge connecting rod, ground crank shaft, ground piston pin, large capacity hopper and fuel tank, speed changer and safety flywheel.

The illustration represents the hit and miss engine for gasoline. Can be conveniently mounted on hand portable truck. Suction feed.

Style No. Hit and Miss Engines	Horse Power	Speed Rev. per Min.	Flywheel		Standard Plain Pulley		Fuel Tank Capacity Gallons	Hopper Tank Capacity Gallons	†Floor Space in Inches	Approx. Domestic Shipping Weight Complete	Price
			Dia. In.	Face In.	Dia. In.	In.					
808	3	500	23	2	8	4	2½	4½	30x40	525	3 H. P. \$128.50
803	1½	550	17	1¾	5	4	1¾	2½	22x42	250	1½ H. P. \$70.00

**FULLER AND JOHNSON FARM PUMP ENGINE**

Thousands of these outfits are in daily service and giving satisfaction. The illustration shows the outfit as it comes complete ready to attach to almost any make of wind-will head pump. In designing this outfit, the manufacturers had in mind a pumping engine simple, convenient and reliable and as near trouble proof as possible. Being an air-cooled engine there is no likelihood of it freezing and the way it is constructed is cools properly while doing its work. It comes complete as illustrated (pump stand not included). Engine will pump water from an ordinary well at a rate of 35 five-inch strokes per minute and has power to lift 550 gallons of water against a total lift of 100 feet or 240 gallons of water against a total lift of 200 feet. If longer stroke is desired the engine can be adjusted to 7½- or 16-inch stroke.

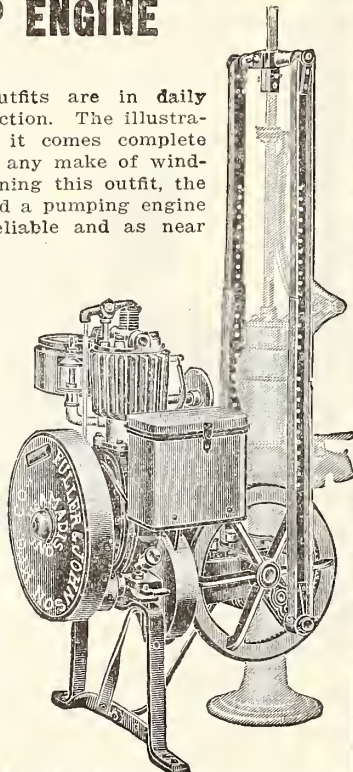

**PRICE .....\$95.00**

**STOVER 6 H. P. TYPE "K" STATIONARY GASOLINE ENGINE**

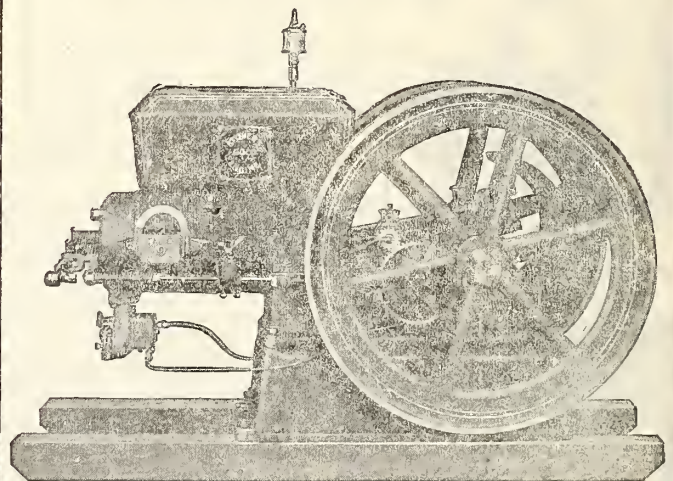

The same principle in construction is followed on the 6 H. P. type "K" engine as on the 1½ and 3 H. P. It contains all the special features of the two smaller sizes and which are clearly set out in the description under the 1½ and 3 H. P. sizes.

The only noticeable difference in the design of any particular part is the flywheels which are of the spoke type on the 6 H. P. and the web type on the smaller sizes.

H. P.	Rev. Per Min.	Plain Pulley Dia. In.	Face In.	Weight	Price
6	450	16	6	950 lbs.	\$218.75

## Gould's Well Force Pumps

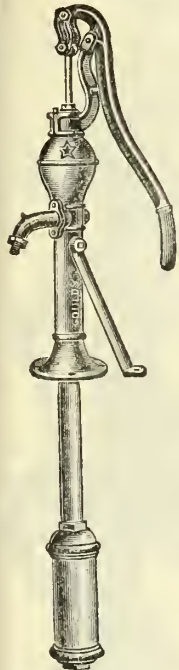

Fig. 852 1/2.  
"STAR" FORCE  
PUMP.

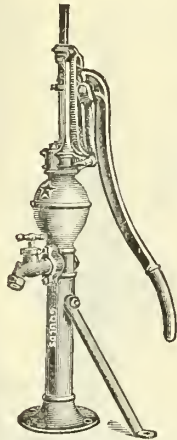

Fig. 1654. STAND.

This cut shows stand only. We can furnish this pump with cylinder extended 4 ft. below platform same as on Fig. 852 1/2.



Fig. 1625

Fig. 852 1/2—Has 3-inch cylinder, 6-inch stroke; recommended for wells 40 feet deep and less. With brass lined cylinder.

OUR SPECIAL PRICE.....\$12.80

Fig. 1654—Star Windmill Force Pump Stand, 6 or 10-inch adjustable stroke. Stand is provided with cock spout, tapped at the back for discharge or can place T under platform. Has a revolving tight top fitted with air chamber tube and brass packing gland. Our Price, \$12.00.

Fig. 1664—Same Pump Stand as Fig. 1654, but fitted with four-foot set length and with 3x14 brass-lined cylinder. Our Price, \$16.35.

Fig. 1625—Star Anti-Freezing Lift Pump, made with an iron pipe stock and adjustable base. The base is made extra high giving rigid support to the stock. Has 3 x 10 iron cylinder, 5-inch stroke and tapped for 1 1/4-inch pipe. Price, \$8.60.

## GOULD'S UNIVERSAL HOUSE FORCE PUMP

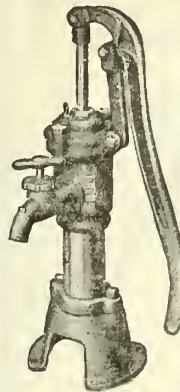

Fig. 1169

No. 2, Fig. 1168—With Plain Spout.....\$ 7.50  
No. 2, Fig. 1169—With Cock Spout..... 9.50

The **Universal House Force Pump** is an easy working, compact and substantial pump. It is well adapted to house pumping, furnishing water either at the spout or through opening to storage tank. Can be used outdoor over wells and cisterns. Pump should not be placed over 22 feet above the water. Has 2 1/2-inch cylinder and 4-inch stroke. Tapped for 1 1/4-inch pipe.

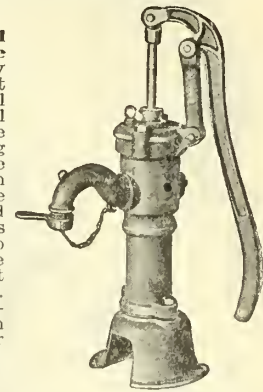
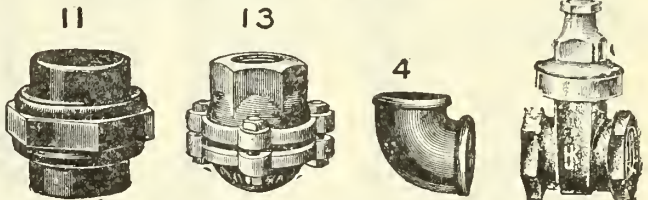

Fig. 1168

## BRASS VALVES



	1/2 in.	3/4 in.	1 in.	1 1/4 in.	1 1/2 in.
Globe & Angle Valves.....	\$1.35	\$1.65	\$2.40	\$3.35	\$4.65
Gate Valves.....	1.60	1.95	2.60	3.50	4.75
Swing Check Valves.....	1.50	1.70	2.10	2.75	3.60
Lever Handle Stop.....	.90	1.65	2.50	.....	.....
Stop and Waste.....	1.00	1.70	2.60	.....	.....
Compression Bibbs.....	.70	1.50	2.65	.....	.....
Hose Bibbs.....	1.15	1.95	2.85	.....	.....
Galv. Foot Valves.....	.....	.....	.....	1.25	.....
Iron Body Ft. Valves.....	.....	.....	.....	1.75	.....

### GALVANIZED PIPE FITTINGS.

	1/2	3/4	1	1 1/4	1 1/2	2
Elbows.....	12	20	22	36	44	.76
Tees.....	17	26	28	52	64	1.02
Street Elbows.....	12	18	22	32	44	.72
45-Degree ".....	12	18	20	30	40	.68
Cross.....	20	32	33	56	70	1.18
Bushings.....	10	10	12	13	15	.20
Lock Nuts.....	05	05	06	10	12	.18
Caps.....	06	10	12	20	28	.42
Reducers.....	10	13	14	20	30	.50
Couplings.....	10	14	16	28	34	.60
Galv. Unions.....	36	42	52	74	94	1.42

### GALVANIZED NIPPLES.

	1/2 x 1 or 1 1/2	.....
1/2 x 2, 2 1/2, 3, 3 1/2.....	\$0.06	.....
3/4 x 1 1/2 or 2.....	.10	.....
3/4 x 2 1/2, 3, 3 1/2, 4.....	.12	.....
1 x 1 1/2 or 2.....	.12	.....
1 x 2 1/2, 3, 3 1/2, 4.....	.15	.....
1 1/4 x 1 1/2 or 2 1/2.....	.15	.....
1 1/4 x 3, 3 1/2, 4, 4 1/2.....	.20	.....
1 1/2 x 1 3/4 or 2 1/2.....	.20	.....
1 1/2 x 3, 3 1/2, 4, 4 1/2.....	.25	.....

## ADDITIONAL FOR FITTING PUMPS

We give below a table of the additional charge for fitting, and the amount stated in table has to be added to the price of the pump selected. In fitting pumps we use galvanized pipe and galvanized pump rod and a strainer foot valve. For wells 26 feet deep or less we leave the cylinder 5 feet below platform. For wells deeper than 26 feet we place the cylinder close to the bottom of the well.

Prices Subject To Change Without Notice Depth of Well.	With 1 1/4-in. Pipe for 2 1/2-in. and 3-in. Cylinder Pumps.		With 2-in. Pipe for 4-in. Cylinder Pumps.		With 2-in. Pipe fitted with 1 1/4-in. Wood Rod.		We Use an Extra Good Foot Valve Depth of Well.	With 1 1/4-in. Pipe for 2 1/2-in. and 3-in. Cylinder Pumps.		With 2-in. Pipe for 4-in. Cylinder Pumps.		With 2-in. Pipe fitted with 1 1/4-in. Wood Rod.	
10 feet.....	\$3.55	\$5.45	.....	.....	.....	.....	32 feet.....	\$ 9.50	\$14.30	.....	\$18.50	.....	.....
12 feet.....	4.00	6.10	.....	.....	.....	.....	34 feet.....	10.00	15.10	.....	19.60	.....	.....
14 feet.....	4.40	6.85	.....	.....	.....	.....	36 feet.....	10.60	15.95	.....	20.75	.....	.....
16 feet.....	4.85	7.55	.....	.....	.....	.....	38 feet.....	11.10	17.55	.....	22.65	.....	.....
18 feet.....	5.30	8.25	.....	.....	.....	.....	40 feet.....	11.70	18.30	.....	23.70	.....	.....
20 feet.....	5.75	9.00	.....	.....	.....	.....	42 feet.....	12.25	19.20	.....	24.80	.....	.....
22 feet.....	6.20	9.65	.....	.....	.....	.....	44 feet.....	12.75	20.00	.....	26.00	.....	.....
24 feet.....	7.30	11.00	14.00	.....	.....	.....	46 feet.....	13.30	20.80	.....	27.10	.....	.....
26 feet.....	7.80	11.85	15.15	.....	.....	.....	48 feet.....	13.85	21.65	.....	28.25	.....	.....
28 feet.....	8.36	12.65	16.25	.....	.....	.....	50 feet.....	14.40	22.40	.....	29.30	.....	.....
30 feet.....	8.90	13.50	17.40	.....	.....	.....	Each additional ft.	.27	.40	.....	.....	.....	.....

## HOOSIER PUMPS

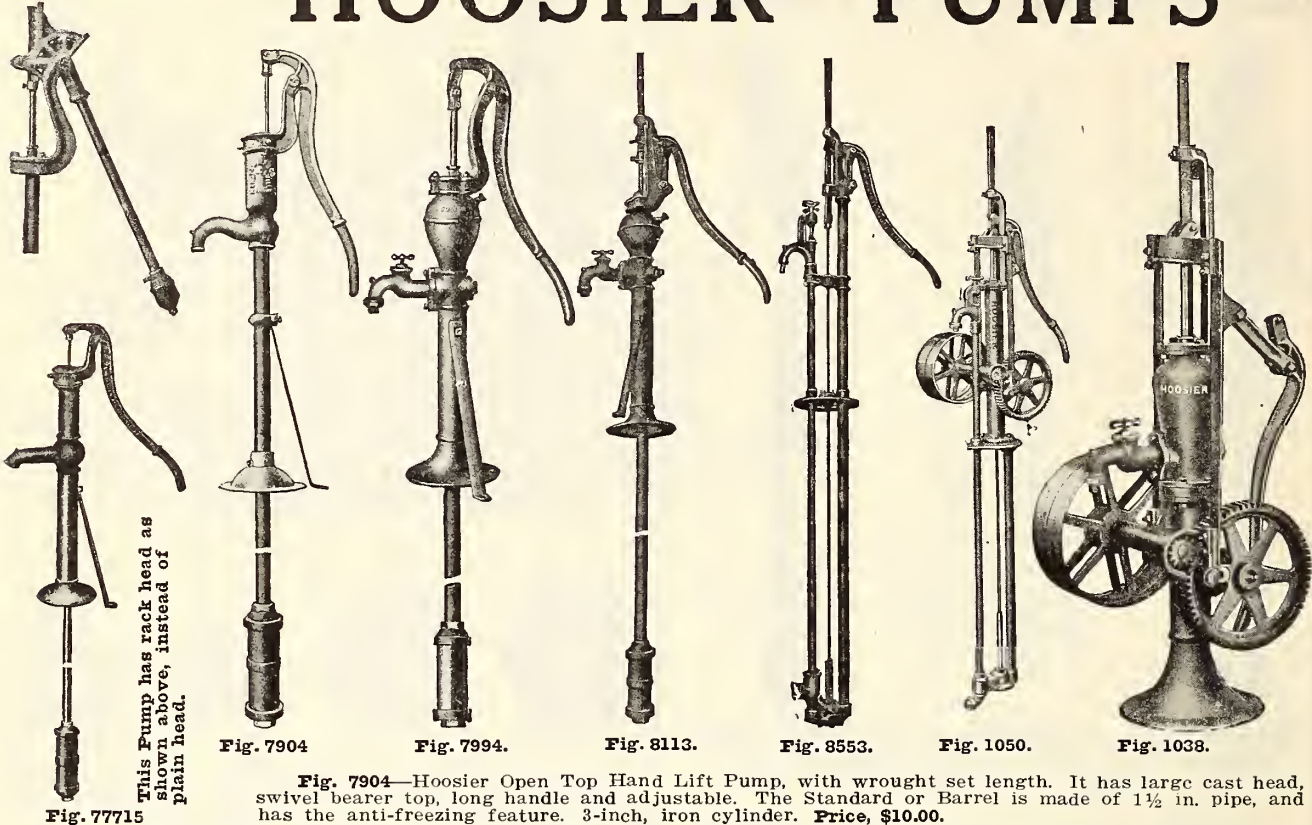
Showing  
Rack Head

This Pump has rack head as shown above, instead of plain head.

Fig. 77715

Fig. 7904

Fig. 7994.

Fig. 8113.

Fig. 8553.

Fig. 1050.

Fig. 1038.

**Fig. 7904**—Hoosier Open Top Hand Lift Pump, with wrought set length. It has large cast head, swivel bearer top, long handle and adjustable. The Standard or Barrel is made of  $1\frac{1}{2}$  in. pipe, and has the anti-freezing feature. 3-inch, iron cylinder. **Price, \$10.00.**

**Fig. 77715**—Hoosier Open Top Hand Lift Pump with wrought set length. The swivel bearer top permits of the handle being set in any direction. The standard is tapped for pipe immediately below spout, and with the usual drip hole in the set length pipe just above the cylinder, makes the pump anti-freezing. A substantial and serviceable pump for open and driven wells not exceeding 30 feet in depth. 3 inch Brass Lined Cylinder. **Price, \$12.25.**

**Fig. 7994**—Hoosier Hand Force Pump, wrought set length, anti-freezing, has swivel bearer top, polished steel piston rod, brass stuffing box, compression cock spout and back inlet. Standard is tapped for pipe just below spout, and with the usual drip hole directly above cylinder makes the pump anti-freezing. Fitted with 3 inch brass lined cylinder. **Price, \$15.25.**

**Fig. 7995**—Same pump as Fig. 7794, with the exception that it is equipped with Hoosier Hand Rack Head instead of Plain Head. **Price, \$17.25.**

**Fig. 8113**—Hoosier Windmill Force Pump, wrought set length, anti-freezing; has detachable polished piston rod, brass stuffing box, swivel bearer top, back outlet and detachable compression cock spout. The bearer top has removable guide bushing to prevent pump rod wearing directly on bearer guide.  $2\frac{1}{2}$  inch Brass Lined Cylinder, 6 inch stroke, weighs 81 pounds. **Price, \$17.25.**

**Fig. 8553**—Hoosier Windmill Underground Force Pump, double acting, with wrought set length, anti-freezing. The pump has brass upper cylinder, positive three-way cock with union connection. Has adjustable platform base, fitted with 1 inch goose neck spout, and 1 inch three-way discharge. By removing upper cylinder and cap, the plunger valve can be withdrawn without disturbing the pump. Suitable for well from 25 to 125 feet in depth. Without Cylinder, **Price, \$20.50.**

**Fig. 1050**—Hoosier Combination Set Length Pump and Jack. For hand, windmill or belt power. For shallow or deep wells. In this pump you get a true alignment of the jack and pump, with no side strain or uneven wear on the parts. Has cast gears and strong pitmans. Tight and loose pulleys. By removing upper cylinder and cap, the plunger valve can be withdrawn without disturbing the pump. Can be used with  $1\frac{1}{4}$ ,  $1\frac{1}{2}$ , 2,  $2\frac{1}{2}$  or 3 inch pipe. **Price, \$50.00.**

**Fig. 1038**—Hoosier Combination Pump Standard and Jack. Back geared 5 to 1, is designed to be operated by hand, windmill or belt power, for shallow or deep wells. This combined pump and jack is compact, strong and easy to install. Built in two sections, between which is a detachable flange, the upper section being the large air chamber with flanged top to which is bolted the flange bearer, making a firm connection; the lower section or barrel and main frame of the jack are of one-piece construction. This gives a true and permanent alignment of the jack and pump. Equipped with cast gears. The pinion shaft is extra long. Pitmans are made of heavy angle steel. The pitmans, gears, pinions and all wearing parts have No-Oil-Em Bearings. Has tight and loose pulleys. Adjustable stroke, 6 to 10 inches. One piece 11-16 inch piston rod, brass covered; brass stuffing box; compression cock spout with hose connection and back outlet. The jack has sufficient clearance above floor to admit of pulley being used as large as 30 inches. Suitable for wells from 25 to 200 feet. Weighs 190 pounds. **Price, \$43.50.**

**Fig. 8583**—Hoosier Easy-Fix Windmill Force Pump. Single Acting, with detachable cast standard, for heavy service. Has positive Three Way discharge and brass hand wheel screw for regulating the three way distributing valve. Underground discharge elbow as union connection, Brass Stuffing Box and Brass Covered Piston Rod, fitted with  $1\frac{1}{2}$  inch pipe air barrel.

The stuffing box is set in extra cap or flange which screws into the bottom casting. By removing stuffing box cap the plunger may be withdrawn without disconnecting the pump. Bearer is provided with removable pump rod guide bushing to prevent wear directly on the bearer guide.

The bottom flange is interchangeable for the size cylinder or pipe to be used. Price of pump without cylinder, **\$21.75.**

Artesian Well Cylinders—See Page 154.

ALL PRICES IN CATALOG SUBJECT TO CHANGE WITHOUT NOTICE.

## CLOSED TOP PITCHER SPOUT PUMP

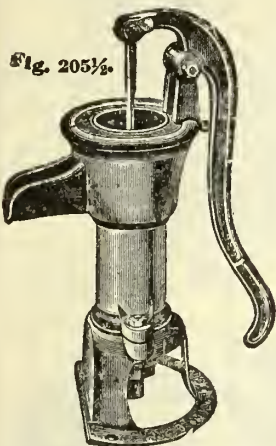

**SIZES AND PRICES.**  
 No. 2—Diameter of Cylinder, 3 in.; Suction, 1¼ in. Polished Iron Cylinder. Retail, \$2.50.

No. 3—Diameter of Cylinder, 3½ in.; Suction, 1¼ in. Polished Iron Cylinder. Retail, \$2.75.

For 1½-in. Couplings add 15c.  
**PITCHER PUMP LEATHERS.**

No. 2—Valve and flat Plunger Leathers, each, 16c.

No. 3—Valve and flat Plunger Leathers, each, 20c.

No. 2—3-inch Leather Cups, 19c.

No. 3—3½-inch Leather Cups, 25c.

## BRASS JACKET DRIVE WELL POINTS

No.	Diameter of Pipe.	Length.	No. 60 Gauge, List Price, Per Doz.	Retail Price Each.
90	1¼	24 in.	\$36.00	\$1.70
94	1¼	30 in.	46.00	2.15
98	1¼	36 in.	56.00	2.60
102	1¼	48 in.	76.00	3.55
136	1½	24 in.	48.00	2.25
140	1½	30 in.	60.00	2.80
144	1½	36 in.	72.00	3.35
148	1½	48 in.	96.00	4.45

Malleable Drive Caps, Hexagon-shaped, for 1¼-inch Pipe, 55c.  
 Malleable Drive Caps, Hexagon-shaped, for 1½-inch Pipe, 55c.

## IXL GALVANIZED STEEL CHAIN PUMP

Being made of No. 24 gauge galvanized steel, this pump will not rot, rust nor accumulate filth like pumps of less desirable construction, and it makes the water clear and pure. It is anti-freezing, as the reservoir piece has a small hole, which allows the water to run out. This style of pump is practical for use in wells as deep as 40 feet. The term curb means the complete upper part of pump with fixtures.

### PRICES.

IXL Curb	\$ 6.50
Gem Curb	5.50
Tubing, per foot	.15
Coupling	.50
Rubber Buckets	.10
Iron Platform	9.00
Chain, per lb.	.12

### DIRECTIONS FOR FITTING UP CHAIN PUMPS

1. Use one foot more tubing than depth of well.
2. Multiply length of tubing by two and add 3 feet 6 inches to get proper length of chain.
3. Rubber buckets should be placed 6 or 7 feet apart.
4. See that tubing is held secure—by tubing brace at bottom of curb.

## No. 30 STAR WATER ELEVATOR AND PURIFIER

Similar to the No. 2 Water Elevator, except that the buckets are slightly smaller, and there is a slight difference in the way the buckets are coupled together. On account of the smaller bucket, it is considered by some better for deep wells.

**Price:**—Elevator and 25-foot chain and japanned bottom wheel for 10-foot cistern, \$13.50. Extra chain, per foot, 25c.

## E. Z. BUCKET PUMP OR WATER ELEVATOR

The strongest bucket pump built. It is made of the best No. 24 galvanized steel, painted two coats best gray paint, and varnished. It has roller bearings, and they make the pump work easier, wear longer and run practically noiseless.

It has steel top and bottom bands. The buckets are made from the best galvanized steel, roll locked seams throughout.

Fixtures are put on the pump complete, avoiding all trouble in fitting.

**Price:**—Elevator, with 25-foot chain and galvanized bottom wheel for 10-foot cistern, \$13.50

**IXL Rubber Bucket.**      **The Queen Rubber Bucket.**      **Victor Anti-Freezing.**      **Crosby Swivel Link Bucket, 12c.**

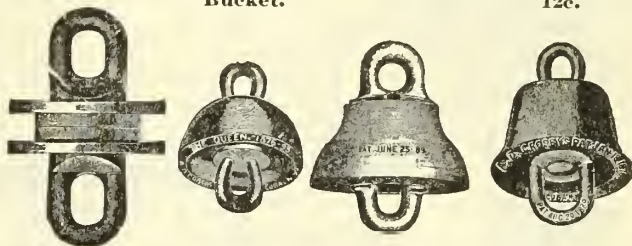

**Price, 10c.**      **Price, 10c.**      **Price, 10c.**      **Crosby Plain, 10c.**

## PUMP LEATHERS

Our pump leathers are cut from the best grade of selected Oak Tan leather. We offer only such leathers as we can recommend as being absolutely high grade.



Plunger Leather Crimped.



Suction Valve Leather.

### CRIMPED PLUNGER OR CUP LEATHERS

1 inch	\$.08	2½ inch	\$.15	4 inch	\$.35
1¼ inch	.08	3 inch	.18	4¼ inch	.38
1½ inch	.10	3½ inch	.19	4½ inch	.40
1¾ inch	.10	3¾ inch	.22	4¾ inch	.45
2 inch	.11	3½ inch	.25	5 inch	.50
2¼ inch	.12	3¾ inch	.31		

### PLUNGER AND LOWER VALVE LEATHERS AND RING PACKING

Outside Diam.	Cylinder Diam.	Each	Outside Diam.	Cylinder Diam.	Each
2 inch	1½ inch	\$0.10	3½ inch	3 inch	\$0.16
2¼ inch	1¾ inch	.10	3¾ inch	3¼ inch	.17
2½ inch	2 inch	.11	4 inch	3½ inch	.20
2¾ inch	2¼ inch	.12	4½ inch	3¾ inch	.25
3 inch	2½ inch	.13	5 inch	4 inch	.30
3¼ inch	2¾ inch	.15			

## PUMP CYLINDERS

	Iron Our Price.	Brass Lined. Our Price.	Brass. Our Price.
2½x12		\$ 4.90	\$ 5.55
2½x16		5.65	6.30
3x10	\$2.25		
3x12		5.30	6.25
3x16		6.15	6.90
3½x10	3.00		
3½x12		6.25	7.00
3½x16		7.35	9.50
4x12		8.50	10.00
4x16		9.75	11.25

2½ and 3-in. cylinders take 1¼-in. pipe; 3½-in. cylinders take 1½-in. pipe; 4-in. cylinders take 2-in. pipe.

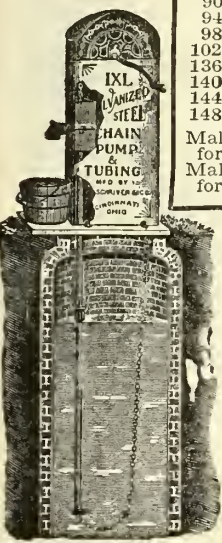

IXL CURB.



GEM CURB.

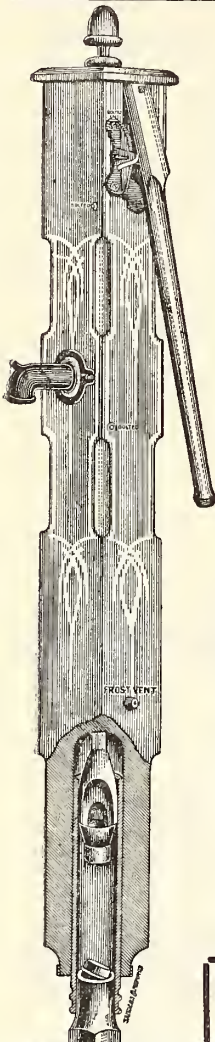

## Baltimore Wood Pumps

PRICES OF PUMPS FITTED COMPLETE.  
With and Without Porcelain Cylinder.

Depth of Well.	6x6 Unlined. Price.	6x6 Lined. Price.	7x7 Lined Price.
10 feet.....	\$9.90	\$12.50	\$14.55
12 feet.....	11.25	13.05	15.10
14 feet.....	11.80	13.60	15.55
16 feet.....	13.15	15.40	17.40
18 feet.....	13.70	16.05	18.15
20 feet.....	14.15	16.50	18.60
23 feet.....		17.40	19.80
25 feet.....		19.20	21.90
28 feet.....		21.24	24.57
30 feet.....		23.05	27.00
33 feet.....		25.80	28.15
35 feet.....		29.50	31.90
40 feet.....		34.10	36.50
45 feet.....		39.50	41.85
50 feet.....		44.00	46.45

## Baltimore Wood Pumps

NOT FITTED.

"No. 0."—STOCK PUMPS. 7x7 Inches, 4-inch Bore.  
Porc. Lined.

6 feet long.....	\$12.75
7 feet long.....	13.75
8 feet long.....	14.75
10 feet long.....	16.75
12 feet long.....	18.75
6 feet long, reamed for 6x6 extension pipe, unlined.....	10.50

## "No. 1"—The Favorite House Pumps

6x6 in., 3½-in. Bore. Porc. Lined.

6 feet long.....	\$10.50
7 feet long.....	11.25
8 feet long.....	12.50
10 feet long.....	13.50
12 feet long.....	15.00
6 feet long, reamed for 6x6 extension pipe, unlined.....	8.50

## Pump For Drive Wells

To Fit 1¼, 1½, or 2-inch Iron Pipe.

Special No. 1 House, 5 feet wood, Porcelain-lined  
Cylinder, entire length 6 feet.

PRICE.....\$11.50

## Tubing and Miscellaneous

Price.  
Retail

4x4, 10 feet long and under, per foot.....	\$0.30
4x4, over 10 feet, per foot.....	.32
6x6 Extension Tubing, per foot.....	.80

Cylinder Block, Porcelain Lined, 3 feet long.....	4.90
Cylinder Block, Porcelain Lined, 4 feet long.....	5.70
Cylinder Block, Porcelain Lined, 5 feet long.....	6.50
Cylinder Block, Porcelain Lined, 6 feet long.....	7.30
Cylinder Block, Porcelain Lined, 7 feet long.....	8.10
Cylinder Block, Porcelain Lined, 8 feet long.....	8.90
6x6 Couplings for 4x4 Tubing.....	.90
Buckets, 5-in., each, No. 00, Price, \$1.75; 4-in., each, No. 0.....	1.50
Buckets, 3½-in., No. 1, each, Price, \$1.25; 3-in., No. 2, each.....	1.00
Handle, any size, each, Price, 40c.; Handle Links or Knuckles.....	.50
Check Valves, per dozen.....	2.00
Iron Connection for Drive Wells, fitted for 1¼-inch and 1½-inch iron pipe.....	1.50
Extra Iron Spout, with loose collar.....	.50
Extra Wood Spouts, each, Price, 20c.; Extra Spout Braces, each.....	.40
Extra Bands, each.....	.15
Extra Bars or Brackets, Nos. 35 and 36, each.....	.50
1-in. Rod Couplings, pair.....	.50
Plunger Rod, per foot.....	.05

### GALVANIZED PUMP RODS AND COUPLINGS

¾-inch Round Galvanized Pump Rod in 20-foot lengths, not threaded, per foot, 5c.

7-16 in., 6c.

Threaded with coupling, add 1c. per foot; cut lengths, add 3c.

Galvanized Pump Rod Couplings for ¾ or 7-16 in. rod. 10c. each.

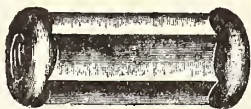

### OCTAGON WOOD PUMP RODS.

Wood Pump Rod for artesian wells is made of selected material and fitted with galvanized forged couplings.

Size of Rod	Size of Artesian Well Cylinder	Price, Per Ft.
1½ in.	1½ in. to 2¼ in.	\$0.25

The above prices are for rod in standard lengths or from 16 to 20 feet, couplings included.

### WOOD PUMP ROD.

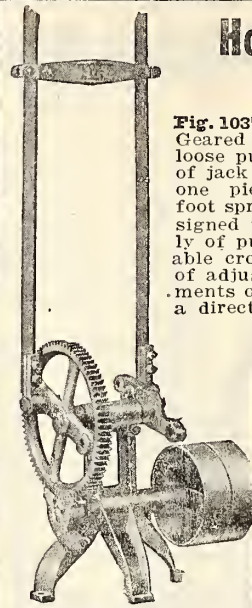

## Hoosier Jack Pump

**Fig. 1037**—Hoosier Pump Jack. Geared 6 to 1, with tight and loose pulley. The main frame of jack and tripod base are of one piece construction. The foot spread is extra wide. Designed to operate independently of pump standard. Adjustable cross head with wide range of adjustments. The arrangements of gear and pinion gives a direct even lift.

Weight 95 pounds.  
Price, \$18.35.

**Fig. 1031.**  
**HOOSIER PUMP JACK**  
Price, \$9.75.

**Fig. 1037.**  
Pump Jack

## Brass Lined Artesian Well Cylinders

A galvanized steel cased brass lined artesian well cylinder for deep wells. It can be used inside of cased or open wells.

It is fitted with bronze ball tubular well valves.

The check valve is seated on a shoulder in a special coupling at the lower end of cylinder. The plunger and lower valve can be inserted or removed through the connecting pipe which is larger in diameter than the bore of the cylinder.

2 in. Diameter, 16 in. Stroke, 26 in. Length of Cylinder, Plunger fitted for ¾ pipe thread.....\$12.00

2½ in. Diameter, 16 in. Stroke, 26 in. Length of Cylinder, Plunger fitted for ¾ in. pipe thread..... 19.75

3 in. Diameter, 16 in. Stroke, 28 in. Length of Cylinder, Plunger fitted for ½ in. pipe thread..... 26.25

No. 9171—Deep Well Brass Cylinder 1½ for 1 in. pipe to be used in connection with 1355 and similar outfits. 6 in. Stroke, \$5.50.



Artesian Well Cylinder No. 445

## Bestway Well Cleaner

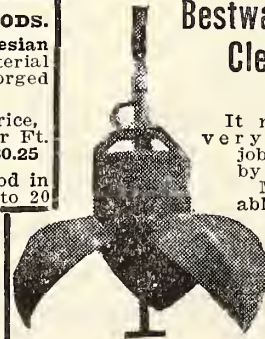

It makes this very important job easy. Designed to operate by one person from platform. Made very strong and durable, will last indefinitely, the price is so small and the results so effective, that several jobs will more than pay for it. Keep your water pure and healthy, clean the well often, with a Bestway..... \$12.50

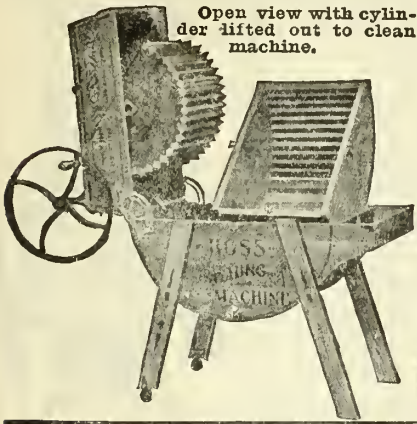

Open view with cylinder lifted out to clean machine.

## "BOSS" WASHING MACHINE

When the top is down and the "BOSS" is operated, the two rub-boards oscillate in opposite directions twice to every revolution of the crank, or 180 times to every turn of the wheel—90 forward and backward strokes every minute. It is this quick double action, and the pressure to the upper rub-board that produces the action similar to the rubbing and squeezing process of washing by the hand method. The clothes, being placed between the two rub-boards, are rubbed and squeezed, rubbed and squeezed, many pieces at a time.

Made in three sizes—

	Capacity	Weight	Our Special Price
No. 1—Small Family .....	10 Shirts	100 Lbs.	\$14.75
No. 2—Medium Family .....	12 Shirts	105 Lbs.	16.00
No. 5—Large Family or Hotel.....	15 Shirts	110 Lbs.	17.75

### BANNER GEARLESS MOTOR FOR CITY WATER POWER—Guaranteed for any pressure over 20 pounds.

Motor is constructed on the turbine principle of direct action—no gears or racks—only two self-lubricating bearings—only two well-protected and practically indestructible springs—heavy brass cylinder—and parts perfectly machined—perforated metal screen before intake port to prevent anything getting into the cylinder. Consumes less water than most washer motors, and will operate on very low pressure. Dasher post adjusts through top of motor—no projection below dasher.

Furnished with high-grade intake and exhaust hose. Large cypress tub—natural finish—with all improved features. Capacity 8 shirts. Shipping weight 60 lbs. Our Special Price .....

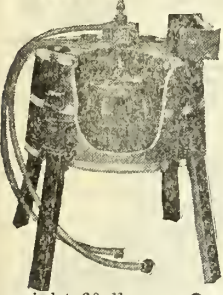

weight 60 lbs. Our Special Price .....

### CINCY HIGH SPEED WASHER FOR HAND OR MOTOR

Is operated by lever with high-speed flywheel geared to make 300 revolutions per minute—this terrific momentum creating sufficient power to practically run the washer without exerting the operator. The flywheel is grooved so a belt may be used on it, making this a hand and power washer in one. Machine can be directly belted to an engine or line shaft and can be opened or closed without shutting off the power or throwing off the belt. Large cypress tub—natural finish and all improved features.

Capacity, 8 shirts. Shipping weight, 90 lbs. Belt Pulleys, extra, \$3.50. OUR SPECIAL PRICE .....

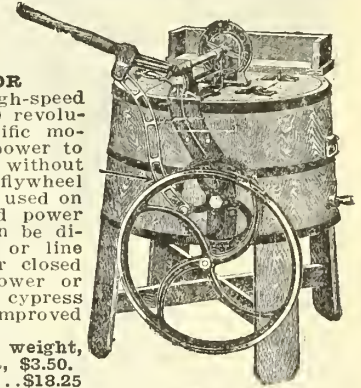

### MAJESTIC

**ROTARY WASHER  
ELECTRIC WELDED  
WIRE HOOPS.  
VIRGINIA WHITE  
CEDAR TUB.  
ROLLER BEARINGS.**

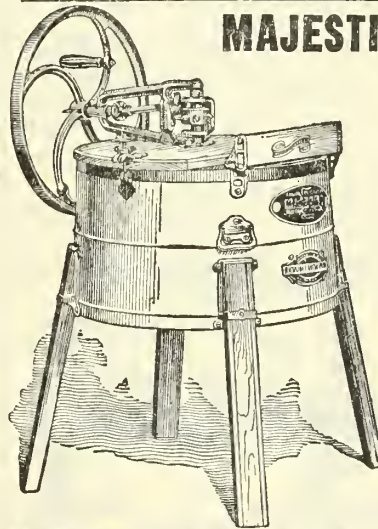

This is the lightest-running and easiest-working Washing Machine made. Roller bearings; no friction. Works in both directions. Very simple; nothing to get out of order. Nicely corrugated on sides and bottom. Hoops are galvanized wire and are welded by electricity; these are much stronger than the old-style flat hoops, and CANNOT DROP OFF, being sunk in grooves.

OUR SPECIAL PRICE,  
\$13.50.

### QUEEN CONVERTIBLE WASHER MOTOR



The lever can be fastened on top of the motor and used as a hand washer. This is often desirable in winter when surface drainage would result in ice.

In case of moving where there is no water pressure, it can be made into a hand-power machine and, of course, hand-power Queens can easily be changed to power washers.

**Durability**—While its extreme simplicity adds greatly to its durability, no expense is spared to secure the very best materials, of which the White Cedar Tub, which never rots, is an important item.

Malleable castings, wrought iron or steel, and bolts instead of screws, all are made durably rust proof.

are used wherever necessary and all are made durably rust proof. Price .....

### THE R. C. W. WATER MOTOR WASHER

**THE R. C. W. WATER MOTOR WASHER** is equipped with the Horizontal, Piston Type of Water Motor, some users prefer this type of motor, which is a very good one.

The tub is made from first-grade white cedar, which is the best material obtainable for this purpose.

The construction of this machine is the best, and with proper care should last many years, and give the very best service. PRICE \$21.50

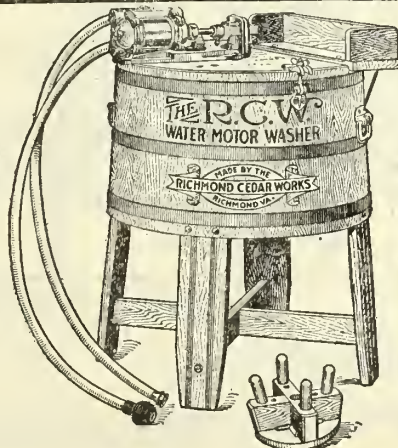

### BALTIMORE CEDAR WASHER ELECTRIC WELDED WIRE HOOPS, \$10.50

Constructed of best white cedar; improved gearings; all castings japanned. Inside fully corrugated like a washboard; no nails; no crevices for dirt, and allowing no steam to escape or water to leak. A square galvanized-iron rod, instead of wood, to work the dolly; this can be lowered or raised without moving tops. Accommodates itself automatically to quantity of clothes. Impossible to tear the most delicate fabric. OUR SPECIAL PRICE .....

### STANDARD PERFECTION

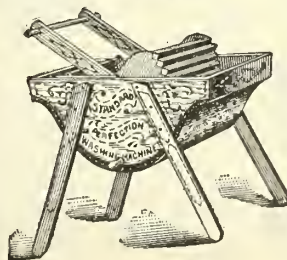

An excellent moderate-price washer, constructed on the rubbing-suction principle—with adjustable cylinder above—removable rubboard below. Made of cypress; natural finish. Galvanized castings and hardwood.

No. 4—Medium size.....\$6.75  
No. 6—Large size..... 8.75

## RICHMOND HIGHSPEED WASHING MACHINE

The mechanical principle of this machine is positive in its action, and as you will see from the cut—the segment lever directly drives the dolly pinion, and all gears are incased in accident-proof covers, reducing danger to minimum.

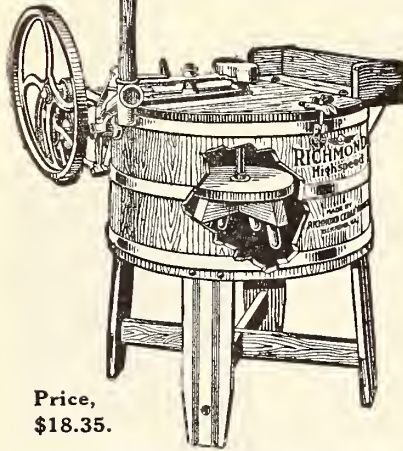

Price,  
\$18.35.

We use cut gears on this machine, and a heavy fly wheel hung parallel with the hinge line, so that the lid can be raised easily, while the mechanism does not get out of gear. You will note the segment lever has a piston type head, ending in a ball which travels in the machined race-way, so arranged as to produce the reverse action of the dolly.

We fit this machine with a well balanced fly wheel, running on ten roller bearings, and geared direct with the cut tooth gears so as to produce a

washing machine mechanism with no dead center.

Please note the lever socket is designed with two different positions to permit the operator to change the angle of the lever, and so assist in lightening the laundry work. You will also note that we equip this machine with a flat rim fly wheel, which can be belted up, if desired.

The tubs are made of EVERLASTING VIRGINIA WHITE CEDAR, the wood best suited to resist decay, and to withstand the damaging effect of shrinkage and expansion, due to the use of hot and cold water in washing machines.

Tubs are corrugated on inside only, and are equipped with tight-fitting lids—double crossed for strength, and to prevent warping.

We use hardwood legs, well bolted to the machine and securely braced.

### FINISH AND GUARANTEE

This machine is finished with a coat of Mahogany stain, and completed with a coat of high quality Coach varnish. Each machine is guaranteed as to quality, material and workmanship.

## RELIEF WRINGER

Thumb-nuts and spiral springs; pressure can be adjusted quickly for either heavy or light work; rolls never overstrained; wear longer than ordinary iron-frame wringer; cog wheels. Packed four and six in a case.

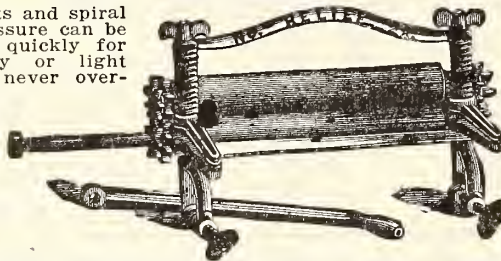

- No. 330—SMALL FAMILY—Size of Rolls, 10x1 3/4-in.... \$4.75
- No. 331—LARGE FAMILY—Size of Rolls, 11x1 3/4-in. ... 5.00
- No. 330—Rolls, 10-inch, each..... 1.50
- No. 331—Rolls, 11-inch, each..... 1.75

## UNIVERSAL WRINGER

The Universal Wood Frame Wringer has Thumb Screw and leaf spring pressure which is quickly adjusted.

The rolls are the best quality and are warranted for family use for three years.

- No. 350—Size of Rolls, 10x1 3/4 ..... \$5.10
- No. 351—Size of Rolls, 11x1 3/4 ..... 5.50
- No. 352—Size of Rolls, 12x1 3/4 ..... 5.75

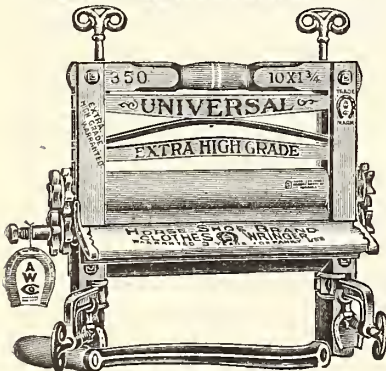

## HAPPY DAY ELECTRIC WASHER

IN CONSTRUCTION AND FINISH this machine is unexcelled. It is very simple and every part of the mechanism is not only carefully fitted, but of great strength. With proper care the "Happy Day" Electric Home Laundry Machine will last for many years. The tub is made of selected Southern Cypress—the wood everlasting—finely finished with good quality varnish. All of the mechanism and gearing, together with the motor, is placed underneath the tub on a heavy iron bracket, which also acts as a strong brace for the legs. Every metal part of this machine is sherrardized—a finish that is far more attractive than paint and as it will not peel or check, will last for a life-time and effectually prevent rust. Each one of these machines is fitted with strong, easy-running casters, which allow it to be moved easily from place to place and the motor is protected from any possibility of splashing water, by a guard or cover.



- No. 44—ELECTRIC WASHER... \$68.75
  - No. 43—Happy Day Engine Power Washer. Price..... \$52.00
- Above have Swinging Wringers.

## POWER WASHER

The Electric Washer and the Power Washer are the same construction, the difference being the the power used.

THE FRAME, OR STANDARD is made of angle steel, the different pieces being securely riveted to each other, forming an exceedingly strong and rigid frame, which at the same time, is not heavy nor cumbersome. The entire frame has electro galvanized, non-rust finish, and is mounted on strong steel casters which allow the machine to be readily moved from place to place.

THE STEEL EXTENSIONS for holding three extra tubs are hinged to the sides of frame, and provide substantial supports for the tubs. When not in use

these extensions are folded up close against the tub and are entirely out of the way. The complete machine then occupies no more space than the ordinary one-tub electric.

- No. 34—PRICE, \$85.00. Without Extension Table, \$3.00 Less.
- No. 33—Gasoline Power Washer..... \$61.50

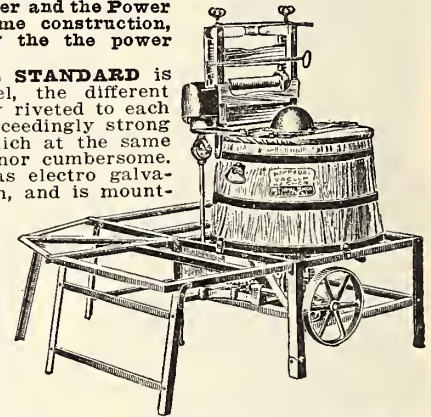

## Boss Electric Washer

The Boss Electric is furnished complete with motor, as illustrated, and is ready for use by simply screwing the attachment plug into the nearest electric light socket and turning the switch. The machine needs no attention whatever while running, and is absolutely trouble-proof, but in case of emergency it can be operated by hand by simply attaching the wheel-handle furnished for the purpose.

- No. 40—Regular Family Size. \$103.50
- No. 41—Large Size ..... 110.00

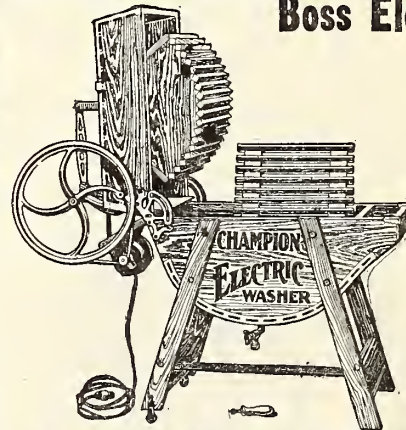

## SUPERIOR WRINGERS

- | Name.                  | Size of Rolls.     | Price. |
|------------------------|--------------------|--------|
| Superior, No. 210..... | 10x1 3/4-inch..... | \$4.75 |
| <b>EXTRA ROLLS—</b>    |                    |        |
| Superior .....         | 10-inch.....       | 1.50   |
| Superior .....         | 11-inch.....       | 1.75   |

ALL PRICES IN CATALOG SUBJECT TO CHANGE WITHOUT NOTICE.



## G. & T. Co.'s Farmers Handy Outfit of Blacksmith's Tools

Consists of the following: 1 100-LB. EAGLE STEEL FACE ANVIL, 1 35-LB. WROUGHT IRON SOLID BOX BLACKSMITH'S VISE, 1 (No. 102) 60-LB. DOUBLE GEARED SELF-FEED HAND POST DRILL; 1 (No. 85) PORTABLE FORGE, 33" high, 22" hearth, 9 1/2" fan. Fireplace separate from hearth, which saves breakage in expansion and shrinkage, heats 2" diameter iron to welding heat; one set of stocks and dies to cut 1/4 to 1/2", 1 3/8" hot cutter, 1 3/8" cold cutter, 1 hardie, 1 2-lb. blacksmith's hand hammer, 1 farrier's hammer, 1 20" straight lip tongs, 1 20" bolt tongs, 1 14" pincers and 1 IXL farrier's knife.

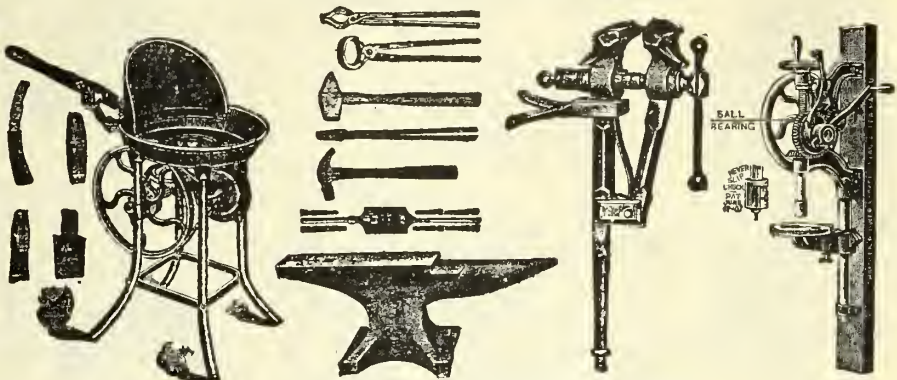

**SPECIAL PRICE ON COMPLETE OUT-FIT AS DESCRIBED, \$84.00.**

- STOCKS AND DIES.**  
 No. 1B—Cuts 1/4"—20; 5-16"—18; 3/8"—16; 7-16"—14; 1/2"—13; right hand; 5 taps and 5 sets dies. Each.....\$12.50
- BLACKSMITH'S HARDIES.**  
 No. 18—Shank, 7/8-inch. Each..... .75
- BLACKSMITH'S HOT CHISELS.**  
 No. 6—Each..... .85
- BLACKSMITH'S COLD CHISELS.**  
 No. 5—Each..... .85

- SOLID BOX VISES.**  
 No. 35—Width of Jaw, 4 inches. Each..... \$9.00
- FARRIER'S KNIVES.**  
 Each..... 1.00
- BLACKSMITH'S TONGS.**  
 Straight Lip, 20 inches. Each..... .95  
 Round Jaw or Bolt, 20 inches. Each..... 1.25
- BLACKSMITH'S PINCERS.**  
 14 inches. Each..... 1.50
- BLACKSMITH'S HAND HAMMERS.**  
 No. 191—2 lbs., with Handle. Each..... .80
- FARRIER'S HAMMERS.**  
 No. 160—Each..... 1.00

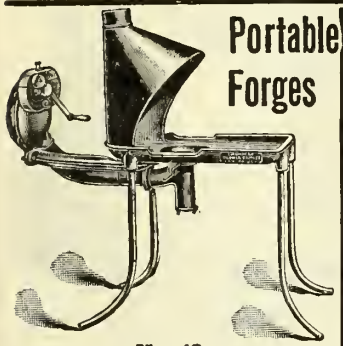

**Portable Forges**

**The Champion Easy Screw Plates**



- No. 43**  
 No. 150 Hearth—18 in.; Height, 30 in.; Fan, 8 in.; Weight, 80 lbs. \$13.50.  
 No. 85 Hearth—22 in.; Height, 33 in.; Fan, 9 1/2 in.; Weight, 100 lbs. \$18.75.  
 No. 43 Hearth—23 1/2 in.; Height, 33 in.; Fan, 12 in.; Weight, 110 lbs. \$33.00.  
 No. 150 and 85 Forges are like one shown with Blacksmith's Outfit.

No. 1 Plate Complete in box. Length of stock, 18 inches. Cutting 1/4, 5-16, 3/8, 7-16 and 1/2 inch. Standard threads. Weight, 12 lbs. Price, \$12.50.

**FIG. NO. 102—DRILL PRESS.**  
 Floor space over all, 3x16 inches; total height, 37 inches; upright column, 1 3/4 inches diameter; drive gear wheel, 8 inches diameter; table, 6 inches diameter; greatest distance from spindle to table, 10 1/2 inches; fly-wheel diameter, 14 1/2 inches. Has extension crank and adjustable feed. Uses 1/2-inch straight shank drills. Each \$11.25. 102 drill with tight and loose pulleys for power, \$15.00.  
 No. 91—Drill Press.....\$16.00

### SILVER & DEMING DRILLS



**No. 112.**

Fitting Boynton & Plumer and Silver & Deming Blacksmith's Drill Presses, Nos. 1 and 2, with shanks 1/2-inch diameter.

Length, List		Retail	Length, List		Retail
Diam.	in.	Pr. ea.	Diam.	in.	Pr. ea.
1-8	6	\$0.45	1-2	6	\$1.00
3-16	6	.50	5-8	6	1.30
1-4	6	.60	3-4	6	1.70
5-16	6	.70	7-8	6	2.10
3-8	6	.80	1	6	2.50
7-16	6	.90			1.90

### ROCK ISLAND OVAL SLIDE VISE

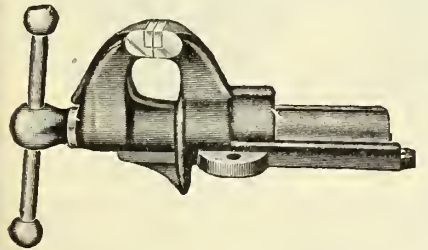

A superior vise in this style. Has top steel jaws.

No.	Size.	Opens.	Weight.	Retail Price.
361	2 1/2 in.	3 3/4 in.	8 lbs.	\$3.10
362	3 in.	4 in.	14 lbs.	3.75
363	3 1/2 in.	4 1/2 in.	22 lbs.	4.60
364	4 in.	4 1/2 in.	30 lbs.	7.25
365	5 in.	4 1/2 in.	35 lbs.	10.00

### ROCK ISLAND ANVIL VISE

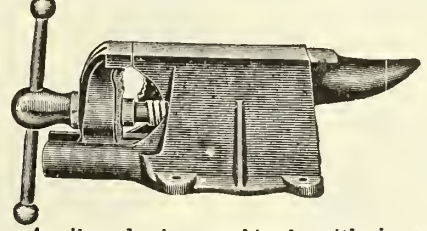

Anvil and vise combined, with jaws for holding pipe.  
 This vise is intended only for light work. This is the best finished vise of this type on the market. Has steel screw with cut threads, steel nut, and cold-rolled steel handle. Anvil and all finished parts highly polished and lacquered.  
 No. 380—Width jaw, 3 inches; opens 5 inches; weight, 26 pounds. Retail Price, \$4.00.

### ANVILS

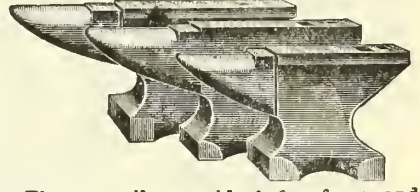

These anvils are ideal for farm and shop use.  
 Eagle cast steel with steel face. 100 lbs., per lb., 23c.  
 Rock Island Semi-Steel, each, 50 lbs., \$6.00; 75 lbs., \$9.60; 100 lbs., \$12.00.

- BLACKSMITH SLEDGES.**  
 10 lbs., 15 lbs., 20 lbs. Per lb.....15c.
- STONE SLEDGES.**  
 10 lbs., 15 lbs., 20 lbs. Per lb.....15c.
- NAPPING HAMMERS.**  
 1 1/2 to 4 pounds. Per lb.....25c.

## COLEMAN QUICK-LITE

### LAMPS AND LANTERNS

"Lights of a Thousand Uses."

It is always ready, safe and dependable. Gives 300 candle power of wonderful white light.

It is economical—48 hours' light on one gallon of gasoline.

Makes and burns its own gas from common motor gasoline.

Lights with matches.

Wind proof; storm proof; bug proof; wildest gale can't blow it out.

Can't spill fuel or explode even if tipped over.

No wicks to trim, no chimneys to wash; no daily filling necessary.

No smoke; no soot; no odor.

Built of brass, inspected, tested, guaranteed. Will last a life time.

Lamp is used daily in over a million homes. "Just the Thing" wherever light is needed about the house—reading, sewing, studying, playing and the evening "get-together."

Lantern is "Just the Thing" for all kinds of outdoor night work—hunting, fishing, camping, harvesting, feeding, milking, plowing, repairing.

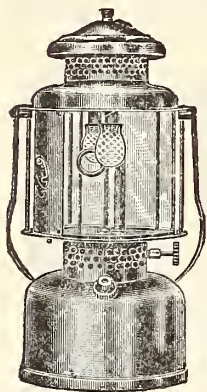

No. 1Q 327.  
Price of  
Lantern, \$7.50.

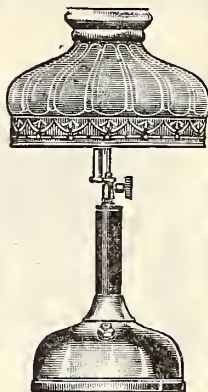

No. CQ 329.  
Price of Lamp,  
\$9.00.

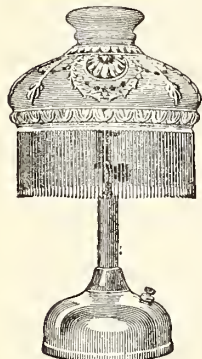

No. CQ 335A.  
Price, \$12.00.



No. CQ 333.  
PRICE,  
\$10.00.



GENERATORS  
40c. each.

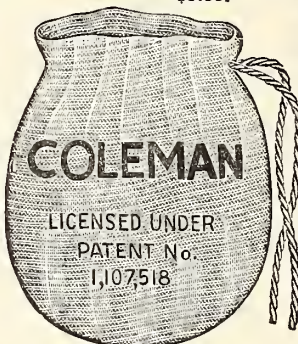

COLEMAN MANTLES  
Two for..... \$0.20  
Per Dozen..... 1.20

## THE STANDARD EARTH AUGER

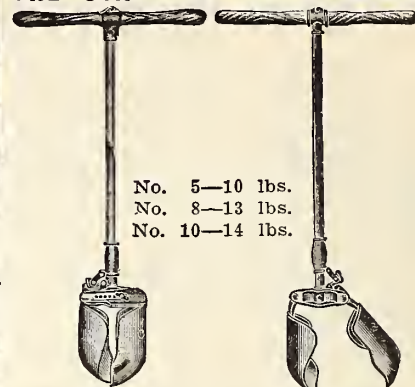

No. 5—10 lbs.  
No. 8—13 lbs.  
No. 10—14 lbs.

Closed.

Open.

Prices.

No. 5 bores four different size holes, 5, 6, 7 and 8 inches in diameter, 3½ feet deep. Each, \$6.00.

No. 8 bores seven different size holes, 8, 9, 10, 11, 12, 13 and 14 inches in diameter, 3½ feet deep. Each, \$7.00.

No. 10 bores nine different size holes, 8, 9, 10, 11, 12, 13, 14, 15 and 16 inches in diameter, 3½ feet deep. Each, \$8.00.

3-inch Iwan Post Hole Augur..... \$4.00  
4-inch Iwan Post Hole Augur..... 4.50

## GIBBS' POST-HOLE DIGGER



Digs faster, works easier than any other on the market. All wearing parts have steel pins. Makes a hole of any desired diameter. First-class for tree-planting.

PRICE .....\$2.50

**SNOW SCRAPER BLADES** made of high carbon shovel steel. Will wear a long time. Castings of the best malleable fastened to blades and handle; Handles of ash, tough, strong and smoothed. All metal parts given a coat of black paint.

15-inch wide.....\$1.25  
24-inch wide..... 1.50

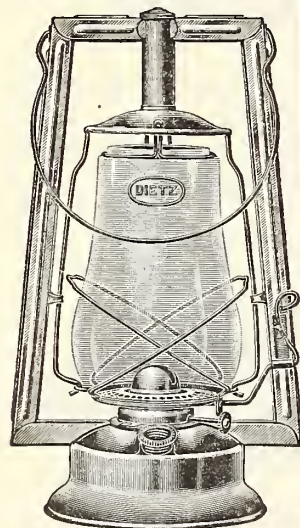

No. 0 DIETZ VICTOR.

"The "Victor" meets every requirement in situations where dependable lighting power is required, it gives the best light obtainable in a hot blast lantern with ¾-inch wick. It has strong, beaded, square ribbed tubes and is a constant burner in any weather. Price, \$0.90.

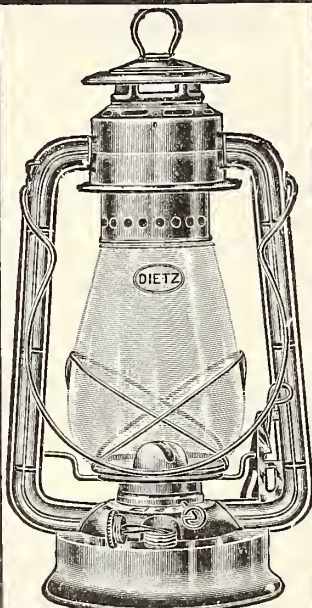

No. 2 DIETZ BLIZZARD

The No. 2 "Blizzard" signifies the best to be had in large lanterns of high globe, cold blast type. It has patented reinforced tubes, with a specially braced lift guide. Price, \$1.35.

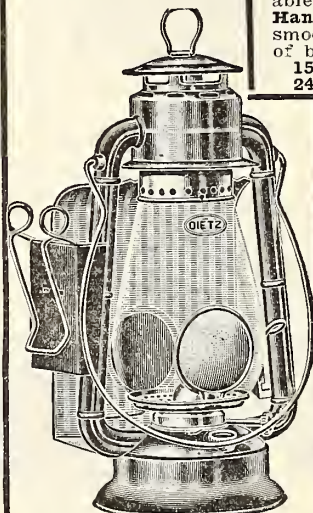

DIETZ JUNIOR WAGON LANTERN.

Dietz "Junior" Wagon Lantern is much in demand because of its fine appearance, small size and cold blast light, which equals in power that of much larger lanterns of ordinary construction.

It has a law-abiding ruby rear lens and fits round or flat holders. Price, \$1.90.

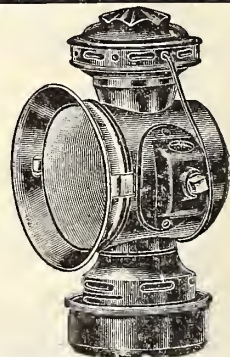

DIETZ EUREKA DRIVING LANTERN.

Dietz "Eureka" is a highly dependable small Driving Lantern, ideal for any light vehicle.

It is made of cold rolled steel, with positive locking oil fount and lawful ruby rear lens. The Eureka is also used as an automobile parking lamp to save battery current. Its handy bail makes it a very convenient portable light in case of mishaps on the road. Price, \$2.00.

## HAY FORKS



- |  |      |        |
|--|------|--------|
| No. 26—Two-tine hay, common ferrule, 6-foot straight handle..... | Each | \$1.35 |
| No. 026—Two-tine, strap ferrule, 6-foot straight handle..        |      | 1.50   |
| No. 027—Two-tine, strap ferrule, 7-foot straight handle..        |      | 1.75   |
| No. 028—Two-tine, strap ferrule, 8-foot straight handle..        |      | 1.95   |
| No. 36—Three-tine, 6-foot handle, common ferrule.....            |      | 1.40   |
| No. 036—Three-tine, 6-foot handle, strap ferrule.....            |      | 1.60   |
| No. 037—Three-tine, 7-foot handle, strap ferrule.....            |      | 1.80   |
| No. 038—Three-tine, 8-foot handle, strap ferrule.....            |      | 2.00   |

## Long Handle Manure Forks



- |   |      |        |
|---|------|--------|
| No. 044½ Z—Four-tine, 4½-foot handle, strap ferrule.... | Each | \$1.30 |
| No. 054½ X—Five-tine, ferrule, long handle.....         |      | 1.65   |
| No. 064½ X—Six-tine, ferrule, long handle.....          |      | 1.85   |

### BACHELOR FORK.

- |   |        |
|---|--------|
| No. 044—Four-tine, 4-foot handle, strap ferrule.....                | \$1.60 |
| No. 44—Batchelor Fork, four-tine, 4-foot handle, plain ferrule..... | 1.40   |

### D-HANDLE MANURE FORKS.

- |  |        |
|--|--------|
| No. 04 DZ—D Handle, four-tine.....                                 | \$1.30 |
| No. 4 W—D Handle, four-tine, plain ferrule.....                    | 1.85   |
| No. 05 D—D Handle, five-tine, cap ferrule.....                     | 1.80   |
| No. 06 D—D Handle, six-tine, cap ferrule.....                      | 2.10   |
| No. 151—Four-tine, diamond tine, heavy, malleable D handle.....    | 2.15   |
| No. 153—Four 16-inch extra heavy tines. 27-inch iron D handle..... | 2.35   |
| No. 157—Five 16-inch extra heavy tines. 27-inch iron D handle..... | 3.05   |

## SPADING FORKS

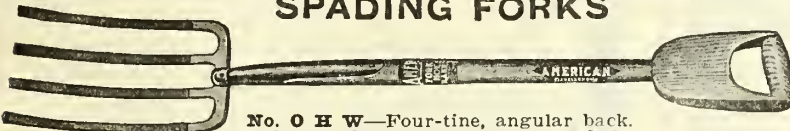

No. O H W—Four-tine, angular back.  
Price, each..... \$2 10

- |  |        |
|--|--------|
| No. O L D—Medium weight, angular tine, malleable D handle, strap ferrule. Price.....       | \$1.60 |
| No. J O W—Jumbo, 4 polished tines, extra heavy strapped ferrule, wood D handle. Price..... | 2.25   |
| No. J O 4—4 polished tines, extra heavy strapped ferrule, 4-foot handle. Price.....        | 1.80   |
| No. B 4 D—Boys' four-tine. Price.....  | .95    |

## SCUFFLE HOES



4-in., Eng...\$0.70      8-in., Eng...\$0.90  
6-in., Eng... .80      10-in., Eng... 1.00  
No. X G S Brace or Shank Scuffle Hoe.  
8-inch Steel Blade, with Handle.... 1.05

## EDGING KNIFE

No. 040—Solid Steel Turf Edger, \$1.15



### WITH PLAIN AND STRAP FERRULE.

- No. X.—4½ ft., with plain ferrule, with cap. List, Doz., \$5.55; Retail, Each, 45c.  
No. X.—4½ ft., with strap ferrule and cap, List, Doz., \$7.70; Retail, Each, 60c.

### MANURE FORK HANDLES.

- |                              |               |
|------------------------------|---------------|
| Plain. List, Ret'l, Doz. Ea. |               |
| No. X—4½ ft. ....            | \$4.40 \$0.35 |
| <b>HAY FORK HANDLES.</b>     |               |
| Plain. Doz. Ea.              |               |
| No. X—6 ft. ....             | \$6.70 \$0.55 |
| No. X—7 ft. ....             | 10.00 .75     |
| No. X—8 ft. ....             | 14.20 1.10    |

## GENERAL UTILITY FORK

- No. 910—Ten-tine, scoop shape, malleable D handle, strap ferrule. Each.....\$2.70  
No. 912—Twelve-tine, scoop shape, malleable D handle, strap ferrule. Each.....\$3.15

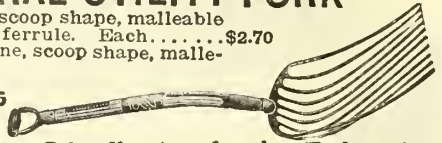

- No. 714 — Coke Forks, fourteen-tine, D handle, strap ferrule. Each... \$3.70  
No. 100 S—Ten-tine, D handle, stone fork.....2.80  
No. 102 S—Twelve-tine, D handle, stone fork..... 3.25

## WIRE POTATO SCOOP



CHAMPION SCOOP.....\$2.50

## STEEL BARLEY FORKS

- No. B 0185—Four 18-inch oval tines, strap ferrule, 5-foot bent handle..... \$2.20

## ENSILAGE FORKS

- |  |      |        |
|--|------|--------|
| No. 508—Eight 16-in. tines, strap ferrule, iron D handle.. | Each | \$2.50 |
| No. 510—Ten 17-in. tines, strap ferrule, iron D handle..   |      | \$2.90 |

## GARDEN SETS

- 5-T Rake, Shovel and  
No. 3 P F—Three-piece, Shovel and Hoe, \$1.70

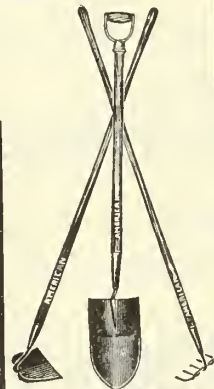

## MULTITOOl

The MULTITOOl consists of 5 Reversible and Interchangeable blades, combining 18 cutting edges, together with a Universal joint at the end of a 5 foot handle.

The Universal ball and socket joint makes a possible adjustment of the handle in any direction up to 50 degrees from the vertical, considering the blade as a horizontal plane.



Price complete, \$3.75.

## Invincible Garden Cultivators

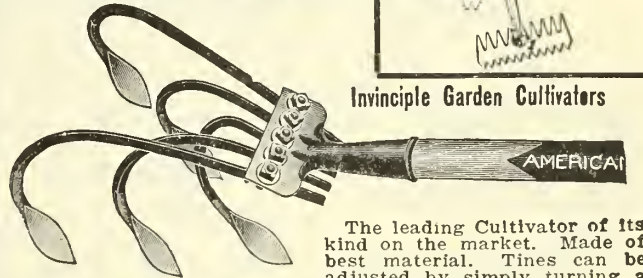

The leading Cultivator of its kind on the market. Made of best material. Tines can be adjusted by simply turning a nut. Price.....95c.

## SIDEWALK CLEANERS

- |  |        |
|--|--------|
| No. O S C—7-inch Solid Socket; Handle..... | .95    |
| No. X 8—8-inch Steel Blade.....            | \$0.90 |

### SHOVEL HANDLES.

- |                             |               |
|-----------------------------|---------------|
| Doz. Ea.                    |               |
| No. X.—L. H., 4½ feet ..... | \$5.70 \$0.45 |
| No. X.—D. H.....            | 9.00 .60      |

### GARDEN HOE HANDLES.

- |            |               |
|------------|---------------|
| Doz. Ea.   |               |
| No. X..... | \$3.40 \$0.25 |

### EYE HOE HANDLES.

- |                              |               |
|------------------------------|---------------|
| List, Ret'l, Doz. Ea.        |               |
| No. X.—5 ft. 2 in. butt..... | \$5.40 \$0.40 |

### RAKE HANDLES.

- |                       |               |
|-----------------------|---------------|
| List, Ret'l, Doz. Ea. |               |
| No. X—5 ft.....       | \$3.90 \$0.30 |

## STEEL RAKES



- No. 10 C—Curved tooth, 10-tooth...\$0.90
- No. 12 C—Curved tooth, 12-tooth... .95
- No. 14 C—Curved tooth, 14-tooth... 1.00
- No. 16 C—Curved tooth, 16-tooth... 1.10

- No. 10—Straight tooth, 10-tooth...\$0.75
- No. 12—Straight tooth, 12-tooth... .85
- No. 14—Straight tooth, 14-tooth... .90
- No. 16—Straight tooth, 16-tooth... 1.00
- No. 18—Straight tooth, 18-tooth... 1.10

### BOW STEEL RAKES

- No. B 12—Prize bow-braced rake, solid steel, 12 teeth. Price, \$1.10 each.
- No. B 14—Prize bow-braced rake, solid steel, 14 teeth. Price, \$1.20 each.
- No. B 16—Solid bow-braced rake, solid steel, 16 teeth. Price, \$1.30 each.

## PRESSED STEEL RAKES

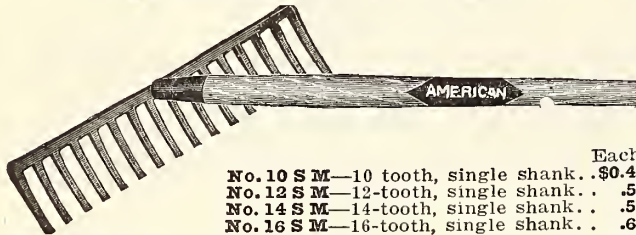

- No. 10 S M—10 tooth, single shank. . . . . \$0.45
- No. 12 S M—12-tooth, single shank. . . . . .50
- No. 14 S M—14-tooth, single shank. . . . . .55
- No. 16 S M—16-tooth, single shank. . . . . .60

- No. 10 B M—10-tooth, braced shank. . . . . 50c.
- No. 12 B M—12-tooth, braced shank. . . . . 55c.
- No. 14 B M—14-tooth, braced shank. . . . . 60c.
- No. 16 B M—16-tooth, braced shank. . . . . 65c.

## EXTRA HEAVY STEEL ROAD RAKES

- No. X 14—14-tooth. . . . . \$1.35
- No. X 16—16-tooth. . . . . 1.45

## STEEL ASPHALT RAKES

- No. 1014—14-tooth, strap ferrule. . . . . \$2.05

## WIRE LAWN RAKES No. 220



As can be seen by the shape of the teeth, these rakes run smooth and will not dig in the sod. By reversing the double teeth are used for leaves and rubbish. 21-inch head. 24 Teeth, with Handle, 80c. each.

## GRITCO WOOD RAKE

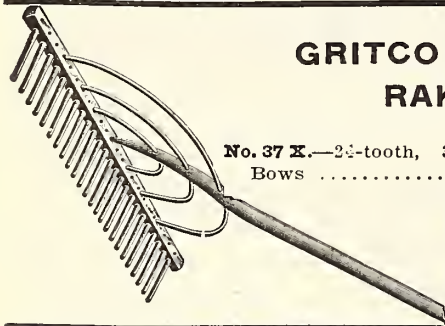

- No. 37 X.—23-tooth, 3 Steel Tube Bows . . . . . \$0.75

**Dig-Easy Mattock Hoes**

- This Hoe is similar to Crescent Double-Bit Hoe, and is made in three sizes.
- No. D E 2—1 1/2-inch and 2-inch blades. . . . . \$0.90
- No. D E 3—1 3/4-inch and 3-inch blades. . . . . .95
- No. D E 3 1/2—1 3/4-inch and 3 1/2-inch blades. . . . . 1.00

ALL PRICES IN CATALOG SUBJECT TO CHANGE WITHOUT NOTICE.

## GARDEN HOES



- No. G 67—Solid Steel Garden Socket Hoe, XX Handle; each. . . . . \$1.05
- No. G 67—Solid Steel Garden Shank Hoe, XX Handle; each. . . . . \$0.95
- No. L Y 5—Solid Steel Lady's Shank Hoe, XX Handle; each. . . . . \$0.75
- No. 2 P—Two-Point Solid Steel Weed Hoe; each . . . . . \$0.45
- No. 1 P—Sharp-Point Steel Blade Weed Hoe; each. . . . . \$0.40

## PLANTER HOES

- No. P 75—Heavy-Handled Planter Shank Hoe, 7-in. blade. . \$1.00
- No. P 7 1/2, 5 1/2—Heavy-Handled Planter Shank Hoe, 7 1/2-inch blade . . . . . 1.05
- No. P 85 1/2—Heavy-Handled Planter Shank Hoe, 8-inch blade . . . . . 1.10

## COTTON HOES

- No. C 75—7-inch-Handled Cotton Hoe. . . . . \$0.90
- No. C 85 1/2—8-inch-Handled Cotton Hoe. . . . . 1.10

## MORTAR HOES

- No. 9—9-inch Blade, Solid Steel Shank, 5 1/2-foot Handle. . \$1.10
- No. 10—10-inch Blade, Solid Steel Shank, 6-foot Handle. . 1.25
- No. S 9—9-inch Blade, Solid Socket, 5 1/2-foot Handle. . . 1.25
- No. S 10—10-inch Blade, Solid Socket, 6-foot Handle. . . 1.30

## WARREN HOE

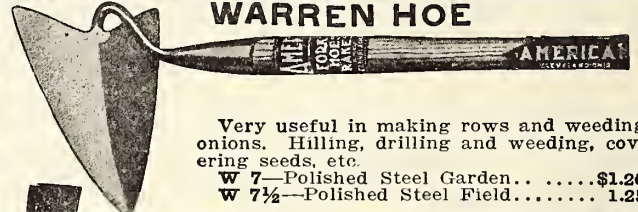

Very useful in making rows and weeding onions. Hilling, drilling and weeding, covering seeds, etc.  
 W 7—Polished Steel Garden. . . . . \$1.20  
 W 7 1/2—Polished Steel Field. . . . . 1.25

## CRESENT CULTIVATOR HOE

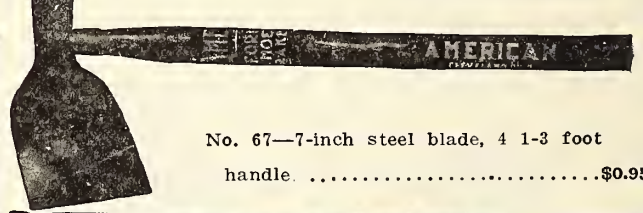

- No. 67—7-inch steel blade, 4 1-3 foot handle. . . . . \$0.95

## SPROUTING HOE

- No. H S 64 1/2—Heavy-Handled Sprouting Hoe, 4 1/2-in. blade, special temper. . . \$1.10

## STREET HOE

- No. 12 S—12-inch blade, steel shank, 6-foot handle . . . . . \$1.65

## HOE AND RAKE COMBINED

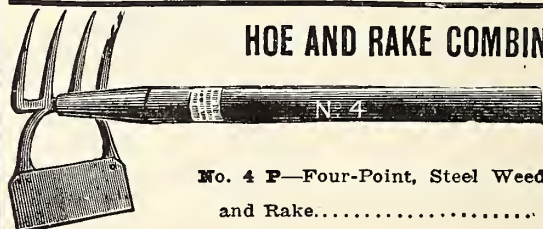

- No. 4 P—Four-Point, Steel Weed Hoe and Rake. . . . . \$1.00

## Bush and Brier Hooks

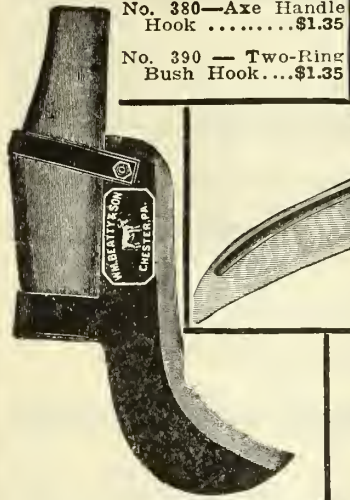

No. 380—Axe Handle Hook .....\$1.35  
 No. 390 — Two-Ring Bush Hook....\$1.35

American—No. 23.....	\$1.70
Backs polished, polished web.	
American Grain Scythe No. 60.....	2.00
No. 52—Weed, Beaded.....	1.75
No. 50—Best Bush or Briar Scythe, Beaded, American Pointed.....	\$1.75
Austrian Scythes.....	\$2.25

English T. Waldron, 36 in.....	\$2.85	English T. Waldron, 40 in.....	\$3.06
English T. Waldron, 38 in.....	2.95	Eng. Waldron Grain Scythes, 52 in.	3.60

## SCYTHE SNATHS

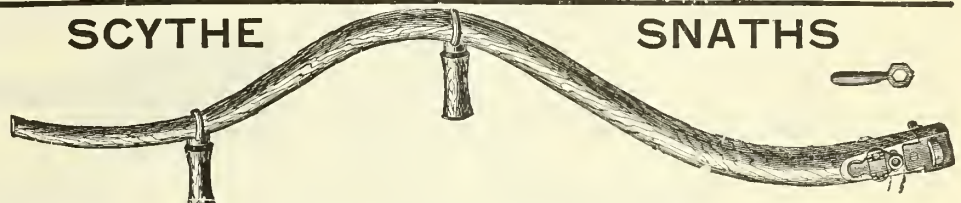

No. 55—Patent Loop, solid plate, iron trimmed. Retail price.....\$1.45  
 No. 100—Two Rings, Bush Snath. Retail price ..... 1.65  
 No. 105—Patent Bush Snath. Retail price ..... 1.65

## Scythe Stones



Each  
 Western Red End.....10c.  
 Quinnebog .....15c.  
 English Round .....25c.  
 Darby Creek .....20c.

## Lightning Pattern Hay Knife

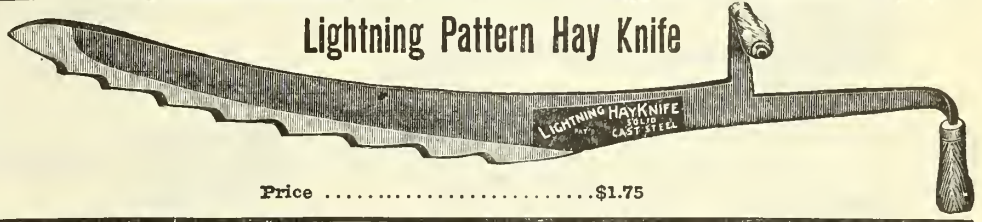

Price .....\$1.75

## The American Sickle Edge Hay Knife

The best cutting knife made. Right of left hand. Section can be easily replaced. Price.....\$2.00

### CORN HOOKS

No. 2—Cast Steel, not finished..	\$0.35
No. 1—Tempered Steel, full polish....	.40
No. 5—Serrated Edge, not adjustable....	.50
No. 6—Serrated Edge, adjustable.....	.55
Quynn Corn Chopper.....	.65

## CORN KNIVES

No. 21—"Will Cut" or Clipper.....\$0.50

## POTATO HOOKS

No. 4 B. O. H.—Heavy Broad Oval Tines, Bent Head, 5-Foot Handle .....	\$1.20
No. 5 B. O. H.—5 Tines, Heavy, Broad Oval Tines, Bent Head, 5-Foot Handle .....	1.45

## Premium Balance Long Sweep Grain Cradle

The Premium Balance Cradle is made from best material and nicely finished with English Waldron Blade. Four-finger, \$7.25; Five-finger, \$7.75; with Four-finger American Blade, \$5.50; Five-finger, \$6.00.  
 Oil Sprung Cradle Fingers, 30c. each.

## MANURE HOOKS

No. M 40—Four Oval Tines, Bent Head, Plain Ferrule, 5-Foot Handle .....\$1.25  
 No. M 60—Six Oval Tines, Bent Head, Plain Ferrule, 6-Foot Handle ..... 1.50

### HOLLOW BACK SCOOPES.



	List	Retail
274 Oriole—D Handle, West. Pattern, Size No. 4..	\$29.76	\$1.55
276 Oriole—D Handle, West. Pattern, Size No. 6..	31.68	1.65
278 Oriole—D Handle, West. Pattern, Size No. 8..	34.56	1.80
264 Oriole—D Handle, East. Pattern, Size No. 4..	28.80	1.50
265 Oriole—D Handle, East. Pattern, Size No. 5..	29.76	1.55
266 Oriole—D Handle, East. Pattern, Size No. 6..	30.72	1.60

### PLAIN BACK SHOVELS—Carbon Steel.



	List	Retail
512 Gritco—D Handle, Square Point, Size No. 2..	\$30.72	\$1.60
513 Gritco—D Handle, Square Point, Size No. 3..	31.68	1.65
514 Gritco—D Handle, Square Point, Size No. 4..	32.64	1.70
712 Balto.—D Handle, Square Point, Size No. 2..	24.96	1.30
713 Balto.—D Handle, Square Point, Size No. 3..	25.92	1.35
714 Balto.—D Handle, Square Point, Size No. 4..	26.88	1.40

### HOLLOW BACK SHOVELS—Carbon Steel.

	List	Retail
212 Oriole—D Handle, Square Point, Size No. 2..	\$24.00	\$1.25
213 Oriole—D Handle, Square Point, Size No. 3..	24.96	1.30
214 Oriole—D Handle, Square Point, Size No. 4..	25.92	1.35
215 Oriole—D Handle, Square Point, Size No. 5..	26.88	1.40
216 Oriole—D Handle, Square Point, Size No. 6..	27.84	1.45

### PLAIN BACK SHOVELS—Carbon Steel.



	List	Retail
532 Gritco—D Handle, Round Point, Size No. 2..	\$30.72	\$1.60
533 Gritco—D Handle, Round Point, Size No. 3..	31.68	1.65
732 Balto.—D Handle, Round Point, Size No. 2..	24.96	1.30

### PLAIN BACK SPADES.



	List	Retail
552 Gritco—D Handle Spades, Size No. 2 .....	\$33.60	\$1.60
752 Balto.—D Handle Spades, Size No. 2.....	24.96	1.30

### SNOW SHOVELS.

	List	Retail
Long Handle, Steel Socket.....	\$12.50	\$0.75

## PICKS, MATTOCKS AND GRUB HOES

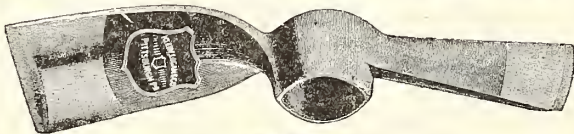

No. 1 Gritco—6 to 7, 7 to 8 and 8 to 9 lbs., Best Quality Warranted Steel Railroad Picks.....	1.35
No. 2—6 to 7, 7 to 8 and 8 to 9 lbs., Regular Iron Railroad Picks.....	1.05
No. 1—Gritco—5-lb. Best Quality War. Steel Mattocks.....	\$1.15
1—Gritco—6-lb. Best Quality War. Steel Mattocks.....	\$1.35
2—5 and 6-lb. Best Refined Iron Mattocks (Steel Cutters).....	Each, 1.05
1 and 2 Gritco—Warranted Steel Grub Hoes.....	Each, 1.00

### PICK AND MATTOCK HANDLES

	List	Retail
First Quality Hickory Pick Handles.....	\$0.50	
1—Good Quality White and Red Hickory Pick Handles...	.45	
2—Mixed White and Red Hickory Pick Handles.....	.40	

### PLAIN BACK SHOVELS—Carbon Steel.



No.	List	Retail
542 Gritco—Long Handle, Round Pt., Size No. 2..	\$33.60	\$1.60
742 Balto.—Long Handle, Round Pt., Size No. 2..	24.96	1.30

### HOLLOW BACK SHOVELS—Carbon Steel.



	List	Retail
722 Balto.—Long Handle, Square Pt., Size No. 2..	\$24.96	\$1.30

### HOLLOW BACK SCOOPS.



	List	Retail
264 Oriole—Long Handle, East. Pat., Size No. 4..	\$28.80	\$1.50
265 Oriole—Long Handle, East. Pat., Size No. 5..	27.76	1.55
266 Oriole—Long Handle, East. Pat., Size No. 6..	30.72	1.60
274 Oriole—Long Handle, West. Pat., Size No. 4..	29.76	1.55
276 Oriole—Long Handle, West. Pat., Size No. 6..	31.68	1.65
278 Oriole—Long Handle, West. Pat., Size No. 8..	34.56	1.80

### FURNACE SCOOP

D Handle.....	\$ .75
---------------	--------

### PLAIN BACK SPADES.



	List	Retail
554 Gritco—Long Handle Spades, Size No. 2.....	\$33.60	\$1.60
754 Balto.—Long Handle Spades, Size No. 2.....	24.96	1.30

### DITCHING SPADE



	List	Retail
818—18-inch Blade .....	\$33.60	\$1.75

## AXES HANDLE

No. Excelsior—Extra Selected Second Growth. All White Hickory Axe Handles.....	\$0.45
No. 1—Selected White Hickory Axe Handles.....	.40
No. 2—White and Red Hickory Axe Handles.....	.35
No. 3—White and Red Hickory Axe Handles.....	.20

## KELLY AXES



Our Axes are of best quality. We only sell those we know to be first class, and have an established reputation.

Kelly, Single Bit—3 to 4 lbs., 3 1/2 to 4 1/2 lbs., 4 to 5 lbs., 4 1/2 to 5 1/2 lbs. Each, \$1.75.

Kelly, Single Bit Axes, Handled... \$2.25

No. 2—First Quality Half Hatchet 1.25

## ICE HOOKS

No. I H 6—6-ft. Handle, Strapped Ferrule.....	\$1.25
No. I H 7—7-ft. Handle, Strapped Ferrule.....	1.50
No. I H 8—8-ft. Handle, Strapped Ferrule.....	2.00

### WROUGHT SCREW AGRICULTURAL WRENCHES.



	6 in.	8 in.	10 in.	12 in.	15 in.
Retail price, each.....	\$0.50	\$0.60	\$0.80	\$0.85	\$1.20
List price, per dozen.....	10.00	12.00	14.00	17.00	24.00

### MACHINISTS' KNIFE HANDLE WRENCHES.



	6 in.	8 in.	10 in.	12 in.	15 in.	18 in.	21 in.
Retail price, each....	\$1.15	\$1.35	\$1.65	\$2.10	\$2.55	\$3.60	\$4.55
List price, doz..	15.00	18.00	22.00	28.00	38.00	48.00	58.00

### STILLSON WRENCHES.



Size.	Grips.	List.	Retail.
6 in.	1/8 wire to 1/2 pipe.	\$2.00	\$0.95
8 in.	1/8 wire to 3/4 pipe.	2.25	1.05
10 in.	1/8 wire to 1 pipe.	2.50	1.20
14 in.	1/4 wire to 1 1/2 pipe.	3.50	1.65
18 in.	1/4 wire to 2 pipe.	5.00	2.30
24 in.	1/4 wire to 2 1/2 pipe.	7.25	3.45
36 in.	1/4 pipe to 3 1/2 pipe.	13.50	6.25
48 in.	1 pipe to 5 pipe.	20.00	9.25

### COMBINATION WRENCH.



	List.	Retail
15—Wire or pipe from 1/2 to 2 1/4 in. outside diameter	40.50	\$2.50
18—Wire or pipe from 1/2 to 3 in. outside diameter..	72.00	3.50

### TWIN WRENCHES.



Twin, 10 in. long. List, per doz., \$13.00. Retail, 75c. each.

## MACHINE BOLTS



Length, Inches.	1/4		5/16		3/8		1/2	
	List, 100.	Retail, Each.	List, 100.	Retail, Each.	List, 100.	Retail, Each.	List, 100.	Retail, Each.
1 1/2	\$1.70	\$.03	\$2.00	\$.03	\$2.40	\$.03	\$3.70	\$.04
2	1.80	.03	2.15	.03	2.60	.03	4.00	.04
2 1/2	1.90	.03	2.31	.03	2.80	.03	4.30	.05
3	2.00	.03	2.45	.03	3.00	.04	4.60	.05
3 1/2	2.10	.03	2.60	.03	3.20	.04	4.90	.05
4	2.20	.03	2.75	.03	3.40	.04	5.20	.05
4 1/2	2.30	.04	2.90	.04	3.60	.05	5.50	.06
5	2.40	.04	3.05	.04	3.80	.05	5.80	.06
5 1/2	2.50	.04	3.20	.04	4.00	.05	6.10	.06
6	2.60	.04	3.35	.04	4.20	.05	6.40	.06
6 1/2	2.70	.04	3.50	.04	4.40	.05	6.70	.07
7	2.80	.04	3.65	.04	4.60	.05	7.00	.07
7 1/2	2.90	.04	3.80	.04	4.80	.05	7.30	.07
8	3.00	.05	3.95	.05	5.00	.06	8.30	.07
9	3.20	.05	4.20	.05	5.40	.06	9.20	.07
10	3.40	.05	4.50	.05	5.80	.06	10.00	.07
11	3.60	.05	4.80	.05	6.20	.06	11.00	.08
12	3.80	.05	5.10	.05	6.60	.06	12.00	.10
13	4.00	.05	5.40	.05	7.00	.06	13.00	.10
14	4.20	.05	5.70	.05	7.40	.06	14.00	.12
15	4.40	.05	6.00	.05	7.80	.06	15.00	.12
16	4.60	.05	6.30	.05	8.20	.06	16.00	.12
17	4.80	.05	6.60	.05	8.60	.06	17.00	.15
18					9.00	.06	18.00	.15
19							19.00	.15
20							20.00	.15

All 1/4-inch bolts are packed 100 in package. All 5/16-inch, 3/8-inch and 1/2-inch bolts are packed 50 in package.

### COLD CHISEL.



### PUNCH.



Retail price, each.....	1/8 in.	5/8 in.
	\$0.20	\$0.25

## BELT PUNCHES

REVOLVING

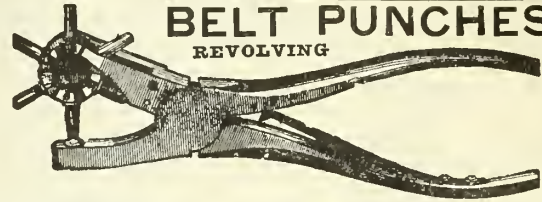

Retail Price, Each, Four-tube, \$0.95. Six-tube, \$1.15. Single-tube, \$0.50.

## ROCK ISLAND, Combination Forge, Anvil, Vise, Drill and Pipe Vise

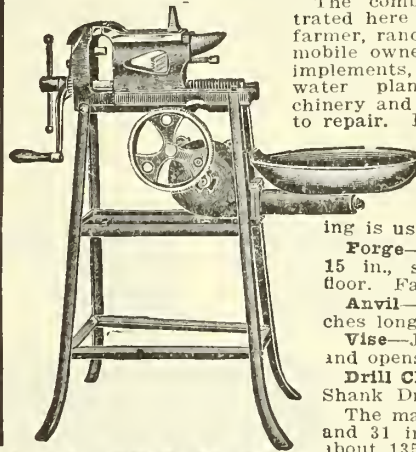

The combination machine illustrated here is indispensable to the farmer, ranchman, contractor, automobile owner and others who have implements, tractors, heating and water plants, automobiles, machinery and equipment of any kind to repair. In compactness and accessibility to the various tools it is unexcelled.

**Frame**—The frame is steel, center casting is used for shelf for tools.

**Forge**—Pan in oval shape, 12x 15 in., stands 27 inches from floor. Pan is 7 inches.

**Anvil**—3 1/2 inches wide, 12 inches long.

**Vise**—Jaws are 3 1/2 inches wide and opens 11 inches.

**Drill Chuck** takes 1/2-in. Round Shank Drill.

The machine is 36 inches high and 31 inches long, and weighs about 135 pounds.

## CARRIAGE BOLTS



Length, Inches.	1/4		5/16		3/8		1/2	
	List, 100.	Retail, Each.	List, 100.	Retail, Each.	List, 100.	Retail, Each.	List, 100.	Retail, Each.
1 1/2	\$1.00	\$.03	\$1.40	\$.03	\$1.90	\$.03	\$3.25	\$.04
2	1.10	.03	1.55	.03	2.10	.03	3.25	.04
2 1/2	1.20	.03	1.70	.03	2.30	.03	3.25	.05
3	1.30	.03	1.85	.03	2.50	.04	3.55	.05
3 1/2	1.40	.03	2.00	.03	2.70	.04	3.85	.05
4	1.50	.03	2.15	.03	2.90	.04	4.15	.05
4 1/2	1.60	.04	2.30	.04	3.16	.04	4.45	.06
5	1.70	.04	2.45	.04	3.30	.04	4.75	.06
5 1/2	1.80	.04	2.60	.04	3.50	.04	5.05	.06
6	1.90	.04	2.75	.04	3.70	.04	5.35	.06
6 1/2	2.00	.04	2.90	.04	3.90	.04	5.65	.07
7	2.10	.04	3.05	.04	4.10	.04	5.95	.07
7 1/2	2.20	.04	3.20	.04	4.30	.04	6.25	.07
8	2.30	.05	3.35	.05	4.50	.05	6.55	.07
8 1/2	2.40	.05	3.50	.05	4.70	.05	6.85	.07
9	2.50	.05	3.65	.05	4.90	.05	7.15	.07
9 1/2	2.60	.05	3.80	.05	5.10	.05	7.45	.07
10	2.70	.05	3.95	.05	5.30	.05	7.75	.07
11	2.80	.05	4.10	.05	5.50	.05	8.05	.07

OUR SPECIAL PRICE..... \$26.00

Champion Combination Tool, same as above, but has grinding attachment.

OUR SPECIAL PRICE..... \$28.50

## Monarch Riveting Machine

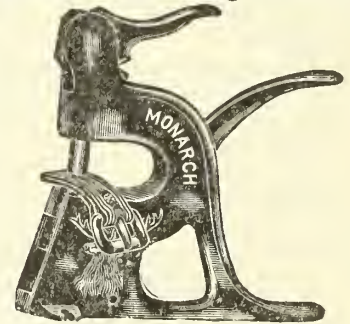

This is the best lowest-priced Riveting Machine made. Warranted to set Tubular Rivets perfectly.

PRICE .....85c.

### Tubular Rivets

100 .....15c.

ALL PRICES IN CATALOG SUBJECT TO CHANGE WITHOUT NOTICE.

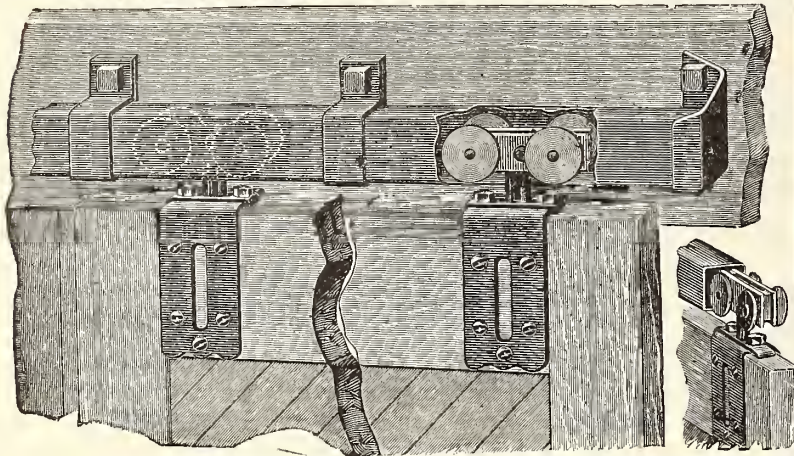

**TROLLEY ROLLER-BEARING STEEL BARN DOOR HANGER No. 20**

The only difference between the No. 25 and 20 is the No. 25 has return apron, as shown in No. 25 cut below, and the No. 20 has not.  
 Weight, per pair, 10 lbs. Pendant, 6 inches long, 3½ inches wide, 3-16 inch thick. These Hangers have lateral adjustments, and are suitable for doors from 1½ to 2¼ inches thick. Hangers and track are sold separately. A pair of Hangers consists of two hangers and carriers, one right-end bracket, No. 51; one left-hand bracket, No. 50, and one center bracket, No. 52, complete with wood screws for hangers and lag screws for brackets. When ordering always give thickness of doors, the exact width of opening, and state whether for double or single doors. No. 31 track, No. 16 gauge, price, per foot, 25c. Hangers, No. 20, per pair, \$2.30.

**No. 25 Trolley Roller-Steel Barn Door**

Has two adjustments—vertical and lateral. Has return apron. (See cut). Pendant 9 inches long, 3½ inches wide, 3-16 inch thick. Suitable for doors 2 to 3 inches thick and weighing from 400 to 600 pounds. Made to run on No. 31 track. A pair of hangers consists of two hangers and carriers, one right and one left-hand bracket, complete with screws for hangers and lag screws for brackets. Hangers and track sold separately. When ordering always give thickness of door, exact width of opening, and state whether for single or double door.  
 Per pair, \$2.70. No. 31 Track, per foot, 25c.

**Anti-Friction Barn Door Hanger No. 2**

PRICE, PER PAIR, \$1.20.

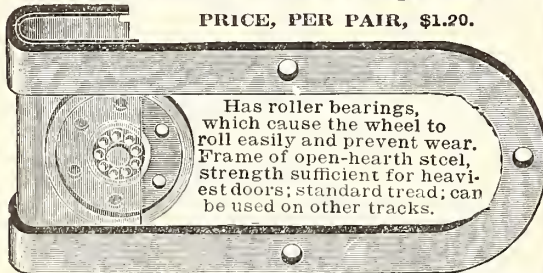

Has roller bearings, which cause the wheel to roll easily and prevent wear. Frame of open-hearth steel, strength sufficient for heaviest doors; standard tread; can be used on other tracks.

The track is made of special carbon open-hearth steel, 1x3-16 stock, has heavy brackets well and substantially riveted every 12 inches. Ends made with tongue and groove to match. Track made in 4, 6, 8 and 10-foot lengths. Price, per foot, 10c.

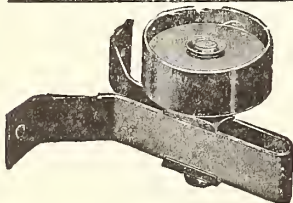

**STAY ROLLERS**

For use with Barn Door Hangers. Price, each, 20c.

**Bearing Hanger**

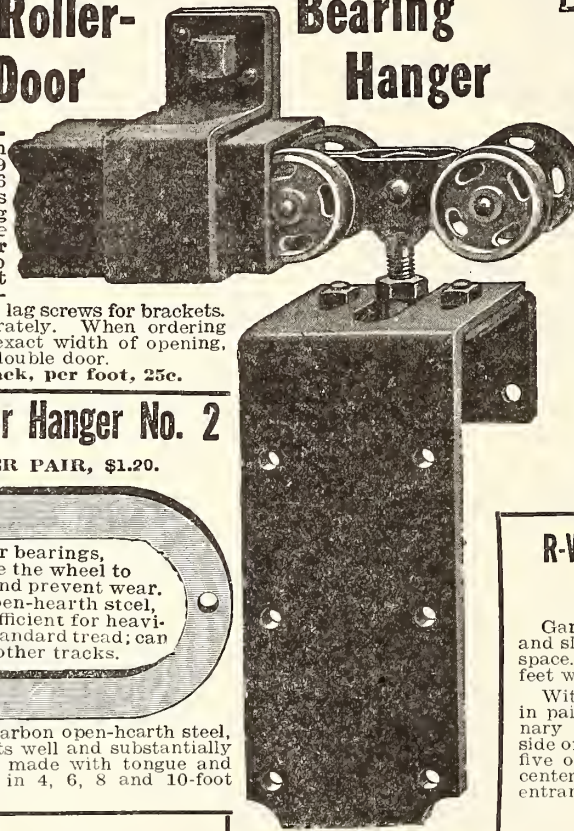

Extra Brackets for Trolley Track, each, 22 cents.

One Bracket should be placed every three feet.

Double Brackets, each, 70c.

**No. 24**

**Roller-Bearing Steel Bar and Fire Door Hanger**



A pair of hangers consists of two hangers, one each right and left-hand brackets, and one center bracket, complete with wood and lag screws. The only Adjustable Double Apron made Suitable for doors weighing

400 to 600 lbs. Adjustment lateral only. No. 1—For doors, 1¾ to 2¼ inches thick; weight, 12 lbs. No. 2—For doors 2¼ to 3 inches thick; weight, 12 lbs. This Hanger has return or double apron. Per pair, \$2.60. No. 31 Track, per foot, 25c.

**FLEXIBLE HINGE BARN DOOR HANGER**

No. 991.

The door can be swung out from the bottom at any angle. The flexible feature allows the top of the door to move away from the building at least one-half an inch. The track is heavy special high-carbon flexible steel, 3-16x1¼ inch, supported by a heavy steel bracket with square shoulder mortised through the track every 17 inches. Weight, dozen pairs, 70 lbs. Weight, track, per 100 feet, 105 lbs. Retail, per pair, \$1.25. Track, Retail, 12c.

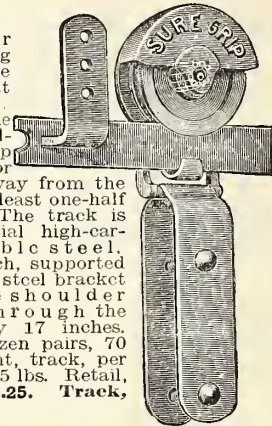

**R-W SLIDETITE GARAGE DOOR ROLLER BEARING HANGERS**

Garage doors equipped with this fixture fold and slide inside building, requiring only minimum space. Recommended for doors not over three feet wide.

With this equipment, four doors hinged together in pairs make an ideal arrangement for the ordinary garage doorway, one pair folding to each side of the opening. When desired, however, three, five or six doors can be used, in which case the center doors swing free, making convenient entrance doors.

**SETS**

- Up to 9-ft. opening . . . . . \$11.60
- Up to 12-ft. opening . . . . . 13.50
- Up to 15-ft. opening . . . . . 20.00

**SAMPSON HANGERS**

- No. 121—Sampson Hangers, per pair . . . . . \$5.80
- No. 33—Sampson Track, per foot . . . . . .70
- Sampson Brackets, each . . . . . .70



## Cannon Ball Barn Door Hanger

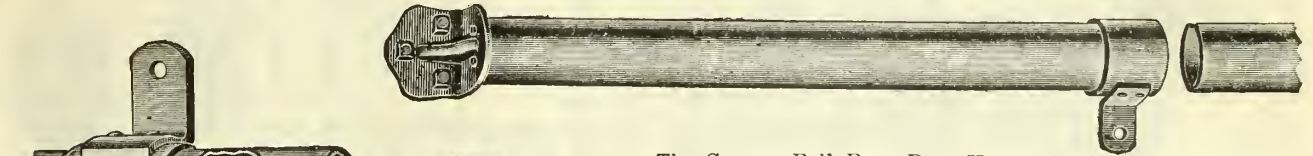

The Cannon Ball Barn Door Hanger is the most widely sold hanger in America. Its heavy sales speak volumes for the merits of the hanger.

Cannon Ball Hangers are the standard by which all others are judged. They represent the height of perfection in design, construction and operation.

Special designed steel ball wheels, light running and with a wide tread, are mounted on a strong steel truss frame. The frame with wheels run completely enclosed in a tubular track; nothing exposed.

Cannon Ball Barn Door Hangers are tandem, flexible, frictionless, noiseless and built with long roller bearings, and are positively bird, water and weather proof.

Track Brackets are not included in the price of Door Hangers.

No. 384—Non-Adjustable Genuine Cannon Ball Hangers, per pair.....	\$2.25
No. 440—Adjustable Genuine Cannon Ball Door Hangers, per pair.....	2.65
Cannon Ball Track, in 3, 4, 6 or 8-foot lengths, per foot.....	.31
Track Brackets, each.....	.20
Track Brackets for end of track.....	.18
Lag Screws for Brackets, each.....	.02

Flexo No. 397 for 1 1/4-in. Flat Track.....	\$1.50
Flexo No. 949 for 1 1/4-in. Flat Track.....	2.30
1 1/4-in. Track for 947 and 949 Hangers, per foot.....	.11 1/2

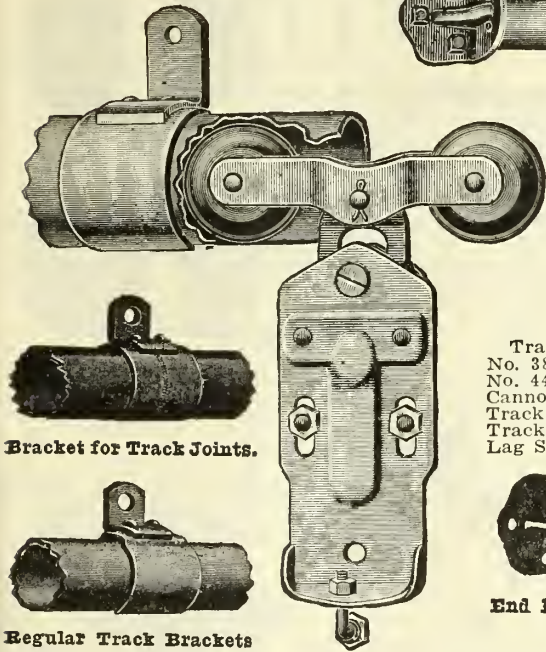

Bracket for Track Joints.

Regular Track Brackets



End Bracket.

### STRAP HINGES



Light Strap.		Heavy Strap.	
	Retail, Per Pair.		Retail, Per Pair.
4 inch	.19	4 inch	\$.14
6 inch	.26	6 inch	.22
8 inch	.45	8 inch	.36
10 inch	.70	10 inch	.55
12 inch	.83	12 inch	.83

### HINGE HASPS



	Retail, Each
3-inch.....	15c.
4-inch.....	18c.
6-inch.....	20c.
8-inch.....	30c.

### SCREW HINGES



6 to 12 inches, per lb.....	10 c.
14 to 20 inches, per lb.....	9 1/2 c.
22 to 36 inches, per lb.....	9 c.

### T-HINGES

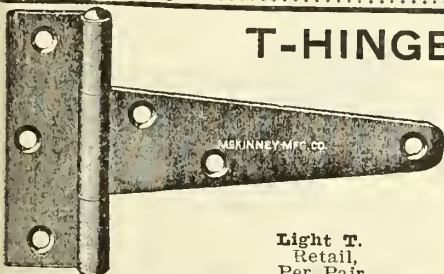

Light T.		Ex. Heavy T.	
	Retail, Per Pair.		Retail, Per Pair.
4 inch	\$.13	4 inch	\$.20
6 inch	.18	6 inch	.27
8 inch	.23	8 inch	.45
10 inch	.35	10 inch	.65
12 inch	.50	12 inch	.90

### IRON, FLAT HEAD WOOD SCREWS

1/2-inch			3/4-inch		
	List, Gross.	Retail, Dozen.		List, Gross.	Retail, Dozen.
No. 4	\$.75	\$.05	No. 6	\$.85	.07
No. 5	.78	.05	No. 7	.90	.07
No. 6	.80	.07	No. 8	.95	.08
No. 7	.84	.07	No. 9	1.00	.08
1-inch			1 1/4-inch		
	List, Gross.	Retail, Dozen.		List, Gross.	Retail, Dozen.
No. 8	\$1.05	\$0.08	No. 10	\$1.30	\$.10
No. 9	1.10	.08	No. 11	1.40	.10
No. 10	1.20	.09	No. 12	1.55	.10
No. 11	1.30	.09			
No. 12	1.40	.09			
1 1/2-inch			2-inch		
	List, Gross.	Retail, Dozen.		List, Gross.	Retail, Dozen.
No. 11	\$1.50	\$.10	No. 12	\$2.00	\$.16
No. 12	1.65	.11	No. 13	2.20	.18
No. 13	1.80	.14	No. 14	2.45	.20

In Gross Lots, Retail, 40 Per Cent. from List.

### CROWBARS

Crowbars with Pinch Point, from 20 to 25 lbs., per lb., 10c.  
 Crowbars with Wedge Point, from 20 to 25 lbs., per lb., 10c.  
 Digging Bar and Rammer combined, each \$2.20.  
 Digging Bar with Loop Handle, each, \$2.20.

### WEDGES

Strong steel wedges for splitting wood, have the right taper and will stick in the wood.  
 Weight from three to six pounds.  
 Price, per pound..... 11c.

## GRITCO SWIVEL REVERSIBLE STEEL TRACK HAY CARRIER No. 4



### Gritco Steel Track Hay Carrier

Car is easily and quickly reversed from the floor, contains no lugs or pins to break; heavier than cars ordinarily sold through this section.

Entirely of malleable iron and high grade. Track traveler and rope pulley sheaves revolve on turned iron bushing. Car will not pass the trip-block while in operation.  
**Steel Track Carrier.**  
 Our Special Price, \$9.00.  
**Steel Track for Gritco Car.** Per Ft., 23c.

### GRITCO WOOD TRACK HAY CARRIER

Wood Track Carrier.  
 Our Special Price, \$9.00

## Harpoon Hay Fork



No. 1—Double Harpoon Hay Fork, 25-in. tines. Retail, \$2.75.

No. 1½—Double Harpoon Hay Fork, 31-in. tines. Retail, \$3.00.

G. & T. No. 1.

No. 2—Nellis Single Harpoon Fork. Retail, \$5.50.

No. 2



## PULLEYS

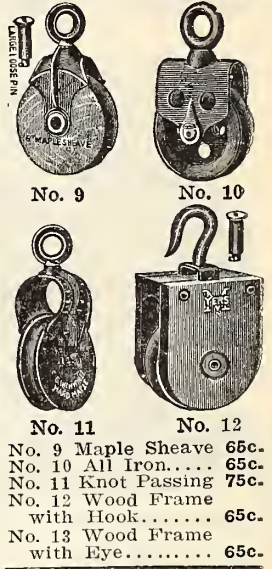

No. 9  
 No. 10  
 No. 11  
 No. 12  
 No. 13  
 No. 9 Maple Sheave 65c.  
 No. 10 All Iron.... 65c.  
 No. 11 Knot Passing 75c.  
 No. 12 Wood Frame with Hook..... 65c.  
 No. 13 Wood Frame with Eye..... 65c.

### GRAPPLE FORKS.

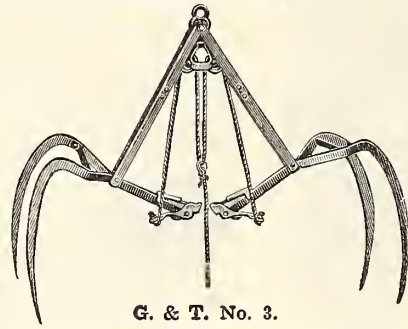

G. & T. No. 3.

No. 3—4-Tine Aut. Grapple Fork. Retail, \$12.50.  
 No. 3—6-Tine Aut. Grapple Fork. Retail, \$14.50.



G. & T. No. 14.  
**SWIVEL ROPE HITCH**  
 No. 14—Swivel Rope Hitch. Retail, each, 40c.

## Hudson No. 326 Adjustable Hay Carrier

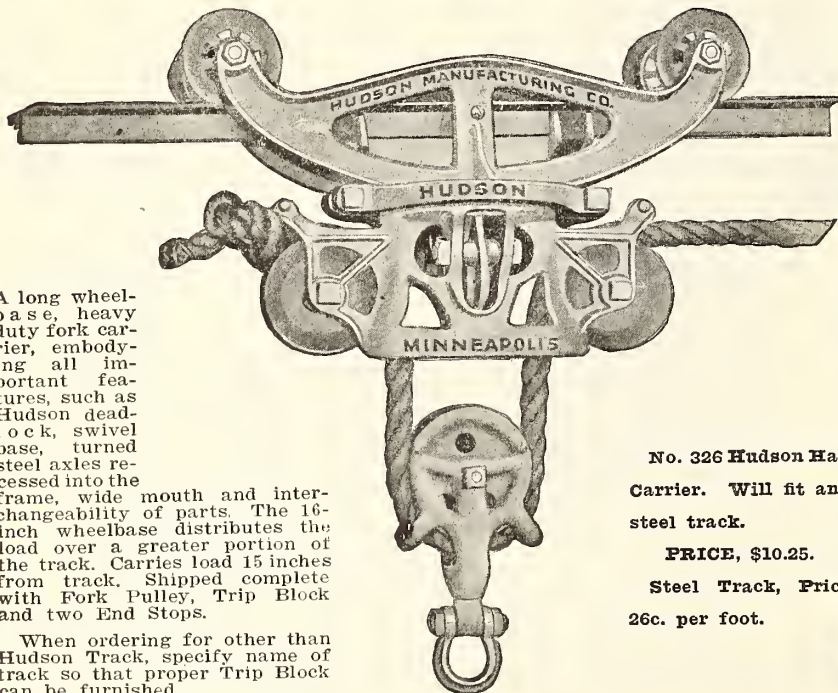

A long wheelbase, heavy duty fork carrier, embodying all important features, such as Hudson deadlock, swivel base, turned steel axles recessed into the frame, wide mouth and interchangeability of parts. The 16-inch wheelbase distributes the load over a greater portion of the track. Carries load 15 inches from track. Shipped complete with Fork Pulley, Trip Block and two End Stops.

When ordering for other than Hudson Track, specify name of track so that proper Trip Block can be furnished.

No. 326 Hudson Hay Carrier. Will fit any steel track.  
**PRICE, \$10.25.**  
 Steel Track, Price 26c. per foot.

## Rafters Brackets

G. & T. No. 4.  
 No. 4—Rafters Bracket, steel. Retail, each, 6c.  
 No. 4—Rafters Bracket, malleable. Retail, each, 6c.

### FLOOR HOOKS.



G. & T. No. 5.  
 No. 5—Floor Hook, ¾-inch. Retail Price, 18c. each.  
 No. 5—Floor Hook, ½-inch. Retail Price, 15c. each.

### HUDSON TRACK HANGERS.



G. & T. No. 6.  
 No. 6—Hanging Hook, steel track. Retail, 18c. each.

### WOOD TRACK HANGERS

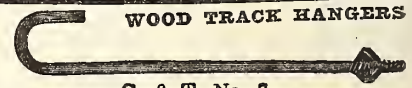

G. & T. No. 7.  
 No. 7—14-in. Hanging Hook, wood track. 15c. each.

### GRITCO TRACK HANGERS.

G. & T. No. 8.  
 No. 8—Hanging Hook Steel Track. Retail, 15c. each.

## SLINGS

Made adjustable to suit any length of rack, from 17 to 20 feet.  
G. & T. No. 15.



- No. 15—Center Trip Sling, 4-foot bars.....\$4.75
- No. 15—Center Trip Sling, 5-foot bars..... 6.50

Our  
Special  
Price.  
Each.

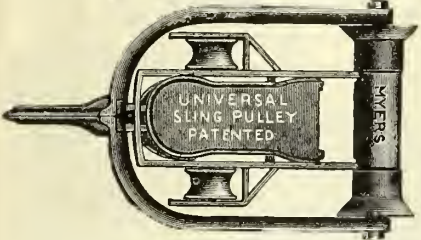

## Sling Pulleys

G. & T. No. 16.

Our  
Special  
Price.  
Each.

- No. 16—Universal Sling Pulley.....\$4.50
- No. 16—Ideal Sling Pulley..... 4.50
- No. 16—Baltimore Sling Pulley..... 4.50

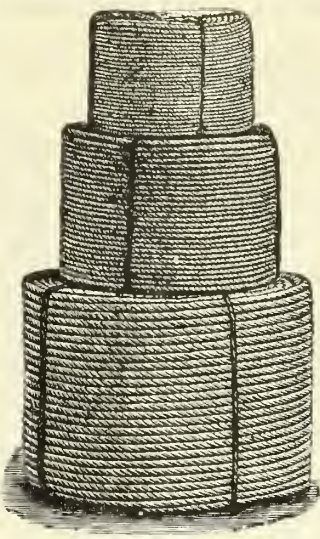

## ROPE

Our stock of rope includes all sizes, from 3-16-inch up to 1 inch. These sizes we carry in stock and can furnish same in full coils or by the piece as desired. The quality of our rope is the best, and we will be pleased to name you the best possible price consistent with quality. We are unable to give prices here, as the market changes.

For Hay Forks we recommend 3/4-in., 13-16-in. and 1/2-in., according to the length of rope.

Approximate length of Manila rope per pound, 3/4-in., 6 feet to pound; 13-16-in., 5 feet to pound, and 1/2-in., 4 feet 3 inches to the pound.

Write for Prices.

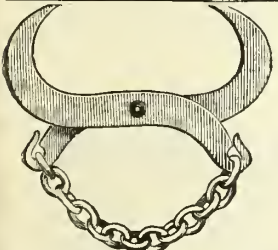

## RAFTER GRAPPLE

G. T. No. 17.

No. 17—Rafter Grapple, Steel,  
\$1.25 each.

Our  
Special Price.

- No. 18—Hoisting Single Tree.....Each, \$2.00
- No. 19—Snatch Blocks.....Each, 1.35
- No. 20—Extra Trips or Stops for Cars.....Each, 1.00
- No. 21—Coupling for Tracks.....Each, .35
- Rafter Nails, per pound.....Each, .15
- Steel Track, per foot.....Each, .26

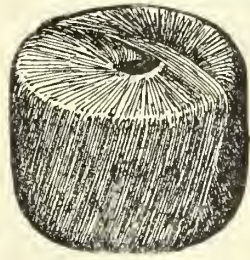

## Binder Twine

It is impossible to give the price of Binder Twine in advance, as the price is subject to market changes.

WRITE FOR PRICES.

## FODDER YARN

PRICES ON APPLICATION.

## Material Required for a Steel Track Outfit

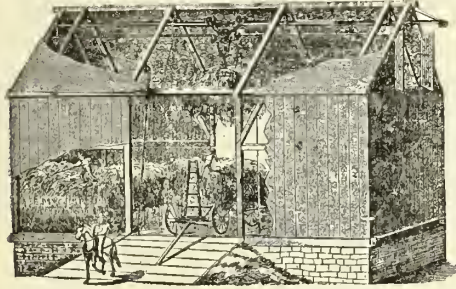

**For a 40-foot Barn**—One Carrier, 40 feet of steel track, 21 hanging hooks, 21 rafter brackets, 5 knot passing pulleys, 1 D. H. Fork, 6 floor hooks, 110 feet 13-16-inch manila rope, 40 feet 3/8-inch reverse rope.

**For a 50-foot Barn**—One Carrier, 50 feet of steel track, 25 hanging hooks, 25 rafter brackets, 5 knot passing pulleys, 6 floor hooks, 130 feet 13-16-inch manila rope, 50 feet 3/8-inch reverse rope.

**For a 60-foot Barn**—One Carrier, 60 feet of steel track, 31 hanging hooks, 31 rafter brackets, 5 knot passing pulleys, 6 floor hooks, 160 feet 13-16-inch manila ropw, 60 feet 3/8-inch reverse rope.

## IRON-STRAPPED BLOCKS



		Common Iron Bushed.							
Size of Sheave. Inches.	Diam. Rope. Inches.	Length Shell. Inches.	Single.		Double.		Triple.		
			List Price	Retail Price	List Price	Retail Price	List Price	Retail Price	
3 1/2 x 1 1/2	3/4	6	\$1.10	\$ .88	\$2.00	\$1.60	\$ 2.90	\$2.37	
4 3/4 x 1 1/2	7/8	7	1.30	1.04	2.40	1.92	3.50	2.80	
4 3/4 x 1 3/8	1	8	1.65	1.32	2.85	2.28	4.25	3.40	
5 1/2 x 1 3/8	1 1/4	9	1.85	1.48	3.40	2.72	4.75	3.80	
6 1/2 x 1 3/8	1 1/2	10	2.75	2.20	4.50	3.60	6.25	5.00	
7 1/2 x 1 3/8	1 3/4	11	4.45	3.56	7.50	6.00	10.65	8.52	
8 x 1 3/8	1 3/4	12	4.45	3.56	7.50	6.00	10.65	8.52	
		Patent Roller Bushed.							
3 1/2 x 1 1/2	3/4	6	\$1.50	\$1.20	\$2.85	\$2.28	\$ 4.40	\$3.52	
4 1/4 x 1 1/2	7/8	7	1.70	1.36	3.35	2.68	5.00	4.00	
4 3/4 x 1 3/8	1	8	2.25	1.80	4.15	3.32	6.00	4.80	
5 1/2 x 1 3/8	1 1/4	9	2.50	2.00	4.70	3.76	7.25	5.80	
6 1/2 x 1 3/8	1 1/2	10	3.50	2.80	6.00	4.80	8.50	6.80	
7 1/2 x 1 3/8	1 3/4	11	5.30	4.24	9.20	7.36	13.20	10.56	
8 x 1 3/8	1 3/4	12	5.30	4.24	9.20	7.36	13.20	10.56	

## GRITCO HOIST

No. 40.—Two sheaves above, two sheaves below; for 3/4-inch rope; capacity, 1500 lbs. One man can lift 400 lbs. 3-inch sheaves.

**Factory List, \$4.00. Our Special Price, \$2.80.**

No. 34.—Two sheaves above, 2 sheaves below; for 1/2 inch to 3/4 inch rope; capacity, 3000 pounds. One man can lift 500 pounds 4-inch sheaves. **Factory list, \$6.00. Our Special Price, \$4.20.**

No. 28.—Two sheaves above, 2 sheaves below; for 3/4 inch to 1 inch rope; capacity, 4000 pounds. One man can lift 600 pounds 5-inch sheaves. **Factory list, \$10.00. Our Special Price, \$7.00.**

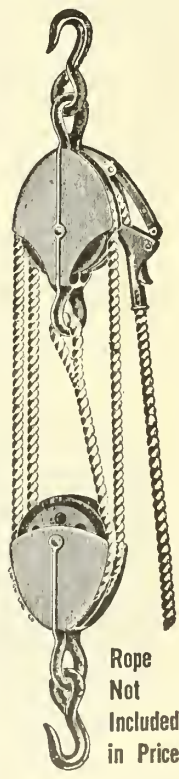

Rope Not Included in Price

## HUDSON COW STALLS AND STANCHIONS

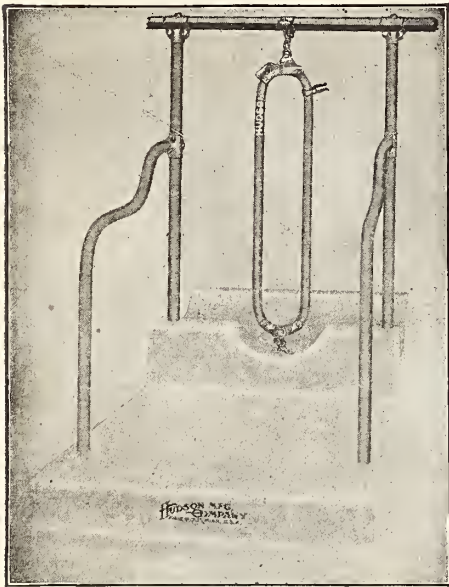

**No. 1A66 Stall.**  
 No. 1A66—One Post Stall, with No. 66 Tubular Steel Stanchion. **Price, \$10.00**  
 No. 1A5—One Post Stall, with No. 5 Wood Lined Steel Stanchion. **Price, \$10.25**

All Hudson Stalls are furnished with long Angle Iron Base Anchors as illustrated on this page, unless otherwise ordered. When anchor is not desired a slight reduction from regular list price of stalls is allowed the purchaser.

As may be seen from the illustration, the two angle iron anchors extend the full length of the stall row. To the front one are bolted all the stall uprights and pipe anchors for stanchions, and the partitions are bolted to the one at the rear.

This makes it possible to ship the stalls in batteries of 2 or 3 stalls each all set up ready to install. The entire row can be put together and will stand without the maze of props and braces which are such a nuisance when setting up many other makes of stalls. Think of the possibility of having your entire installation bolted together and standing in position, enabling you to judge of the final suitability of your layout before beginning to pour cement. For should this "size-up" indicate the desirability of a slight shift, one way or the other, it can be made before it is too late.

After the cement has been poured, the stalls will never become loosened in the cement, while the anchors and tubing furnish a re-inforcement between the floor and curb. We are fully convinced by the results during the year we have used it that our methods of anchoring is the very best that can be devised.

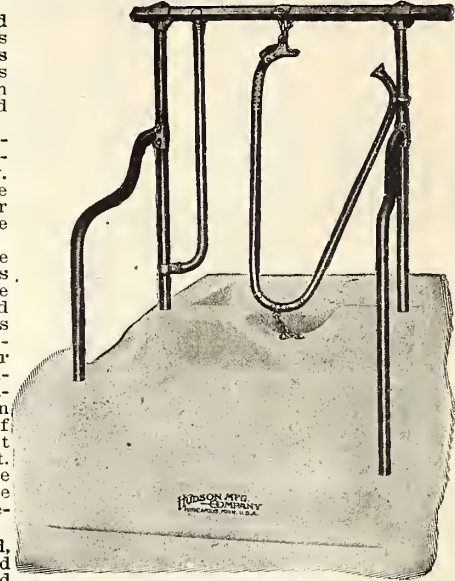

**No. 2A66 Stall.**  
 No. 2A66—Stall with No. 66 Tubular Stanchion. **Price.....\$11.00**  
 No. 2A5—Stall with No. 5 Wood Lined Stanchion. **Price..... 11.20**

**SHOWING HUDSON STALLS AS SHIPPED**

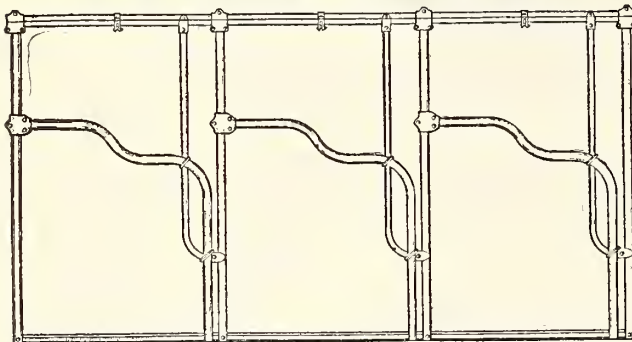

Assembled at the factory instead of on the farm. No chance for shortage. Job always complete.

**SHOWING METHOD OF INSTALLING HUDSON STALLS**

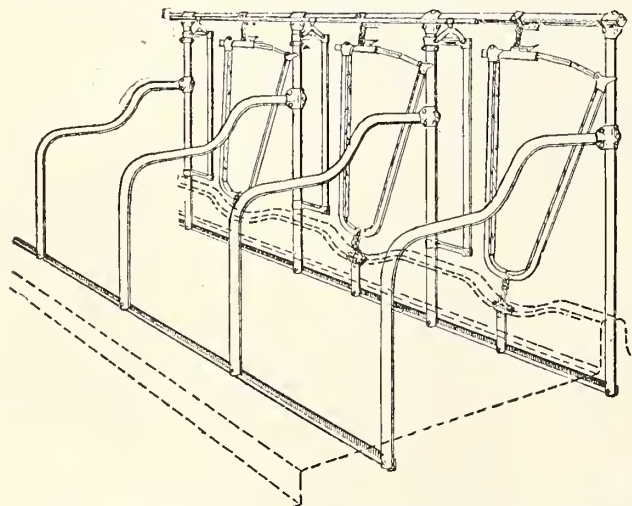

All uprights and partitions securely bolted to angle iron anchor. Angle also acts as base to hold uprights and partitions in proper place, and reinforces the concrete.

### No. 4B 10 STALL

with swinging sure stop and with No. 10 adjustable, wood lined stanchion. **Price \$13.50**

**No. 4B5 Stall with swinging sure stop and No. 5 stanchion. Price \$12.50**

**No. 4B66—Stall with swinging sure stop and No. 66 Tubular steel stanchion. Price \$12.30**

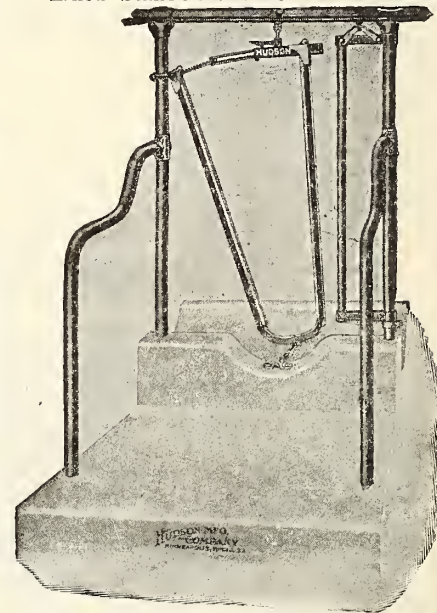

### HUDSON STANCHIONS

No. 66—Plain Tubular Steel Stanchion, improved strong malleable fittings, cow proof latch, specially designed lower hinge that does away with all the necessity for lead. A serviceable stanchion of proven worth. Weight, 20 lbs.

**Price .....\$4.20**  
 No. 5—Wood lined, chain lead stanchion with a chain lead. Weight, 22 lbs.

**Price .....\$4.25**  
 No. 10—Adjustable, wood lined stanchion. Chain Hung.  
**Price .....\$4.85**

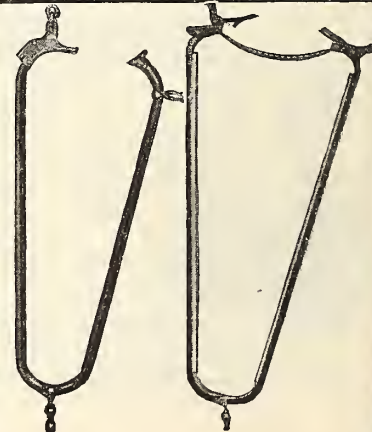

## HUDSON WATER BOWLS

### STEEL WATER BOWL



The Hudson New Steel Water Bowl will not break. The bowl has a greater capacity and is easier handled; made of one piece of heavy gauge steel, galvanized, and attached by means of a special designed clamp, which grips the bowl so firmly that there is no possibility of it being knocked off by the cow.

Made of 14-gauge steel; formed with a heavy rolled rim and galvanized afterwards, so that the galvanizing will not be cracked in the process of manufacture.

Size, 4½ inches deep, 10 inches across the top.

Best Malleable Fittings, Brass Valve Fitted with standard size

Rubber Fuller Ball, same as used in any ordinary water faucet; easily replaced. Valve seat of brass; will not rust. Pressure plate made of Malleable Iron, and rests low in the bowl, thus avoiding interference with the cow's muzzle in drinking. 1-inch pipe should be used for main supply pipe and ¾-inch for the short length to connect the bowl to the main supply pipe.

Bowl weighs 6½ pounds each.

Price .....\$3.85

### QUICK DETACHABLE BOWL



It is easy to install and can be attached to either wood or steel stalls.

It is easy to operate; the slightest pressure of the cow's nose opens the valve and allows the water to flow as fast as she drinks. As soon as she raises her nose the water stops instantly.

**No chance to overflow.**

The pressure plate is arranged so it can be easily removed to prevent the animal drinking.

(Quick Detachable, Automatic)

**Specifications:** The Bowl is 9½ inches across top, 4½ inches deep, and is made of the best quality gray iron.

The intake casting and bracket, valve housing and pressure plate are all made of malleable iron.

The Valve is Fuller Ball Type, consisting of brass plunger, brass spring and hard rubber head. The valve seat is brass bushed. Size of intake pipe, ¾ inch.

Weight, 11 lbs.

Price .....\$3.65

## HUDSON SANITARY STEEL PENS

No. 58A—Steel Cow Pen illustrated below is ideal for a maternity pen and can be used for a testing or feeding pen.

**Specifications:** The panel bars of the No. 58A Pen are 11-16" O. D. High Carbon Steel Tubing, spaced not over 6" on center with strong malleable iron fittings. Corner posts, Intermediate Posts, Gate Posts, Top and Bottom Rails and Gate Frame are 1½" O. D. High Carbon Steel Tubing. The gate is furnished with heavy malleable hinges and is supplied with a latch that has a gravity lock, which can only be opened by the operator. The Pen is 4' 9" high.

Hudson Cow Pens can be furnished with any style corner or square manger, and with adjustable stanchion built in panel if desired. Weight, 22 lbs. per lineal foot. Price, per foot, \$2.85.

Cow Pen Gate Fittings and Arch, per set.....\$6.35

Cow Stanchion Built in Panel, Each ..... 4.55

No. 62 Cow Pen, Galvanized Titting Manger.....18.25

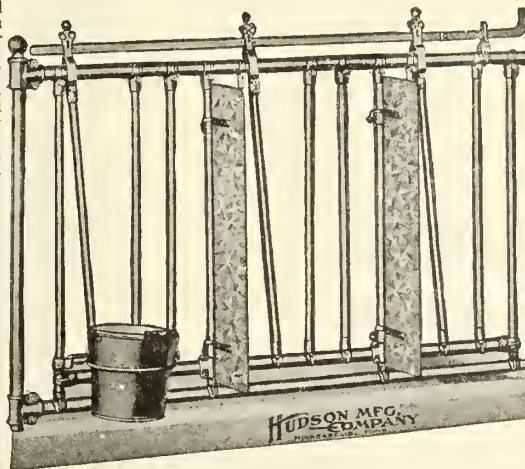

**HUDSON CALF PEN.**

The Bull Pen shown in the cut below is our No. 63 with No. 65B corner manger. Hudson Bull Pens can be equipped with high or low corner mangers with or without gate, or square manger can be furnished if desired. An adjustable, wood lined, tubular steel stanchion built in the panel can be had when specified. All posts, top rail and panel bars in the Hudson Bull Pens are 1½" O. D. High Carbon Steel Tubing. The filler bars or spindles in the manger rail are 15-16" O. D. tubing. Hudson Bull Pens are made only in curb construction with each filler bar running into the cement and bolted to angle iron anchor which runs the full length of panel. This construction provides a pen of unsurpassed strength. Weight, 29½ lbs. per lineal foot. Price, per foot, \$4.00.

Bull Pen Gate Fittings and Post to ceiling, set.....\$8.35

Bull Pen Stanchion Built in Panel ..... 4.70

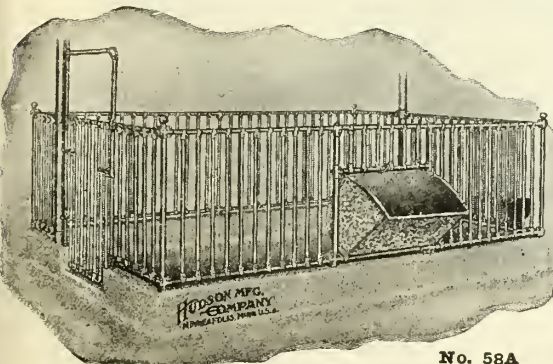

**No. 58A**

Shown above with adjustable lever operating calf stanchions built in panel. Each stanchion can be operated singly. Pen equipped if desired with head guards, pail holders, etc. Specifications same as cow pen except that Hudson Calf Pens are 4' 6" high. Weight, per foot, 15 lbs. Price, per foot, \$2.25.

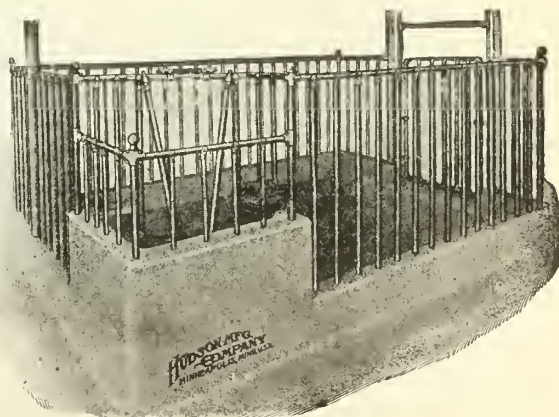

Calf Pen Gate Fittings and Arch, per set.....\$6.40  
 Calf Pen Stanchions Built in Panel, each..... 1.15  
 Calf Pen Head Guards, each..... 2.30  
 Calf Pen Pail Holder, each..... 1.45

# Hudson Chain Hoist Litter Carrier

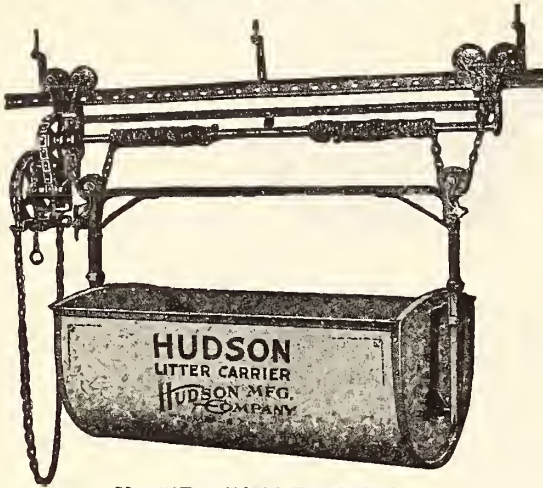

No. 58B.—Rigid Track Only.

This Hudson Heavy Duty Back Geared Litter Carrier is the result of long years experience in the carrier business. This carrier combines great strength and rapid action. It will carry the heaviest loads with perfect ease. The hoisting chain is of special strength and is of a length to correspond with the shaft on which it winds. Longer chains furnished if specified for special jobs. Carrier is equipped with friction brake. The tub is made of heavy galvanized sheet steel reinforced around the top and ends with 1 inch angle iron closely riveted. The carrier locks at both ends, which increases the life of the carrier. The bale is constructed of 1 inch by 1½ inch channel steel strongly reinforced. The chain shaft is 1 inch cold rolled steel. Full swiveled, tandem trucks which give greater bearing on the track and ease in turning corners.

No. 58B—Tub, 44 inches long, 26 inches wide, 22 inches deep, inside measurements, capacity, 13 bu. Weight, 200 lbs. Price, \$47.00.

# HUDSON FEED CARRIER

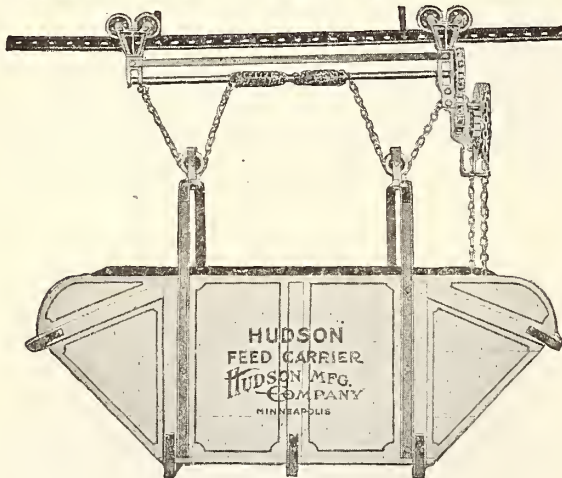

No. 40C.

The Hudson Raising and Lowering Feed Carrier has all the track operating features found in our celebrated line of litter carriers, and is furnished with a tub or a carrier box, that is made of selected materials, and shaped so that the operator can work from either end when feeding.

Equipment can be furnished for the installation of a system of trackage in connection with the litter carrier system. Capacity, 16 bushels. Weight, 225 pounds. Price, \$8.00.

# Hudson Track Equipment

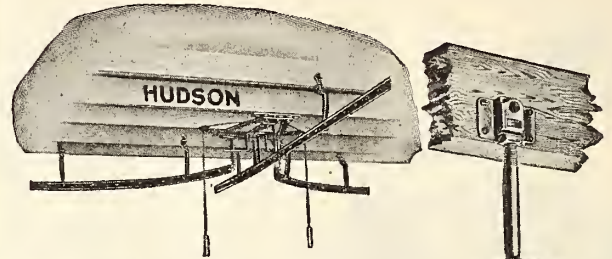

No. 104.



No. 102.

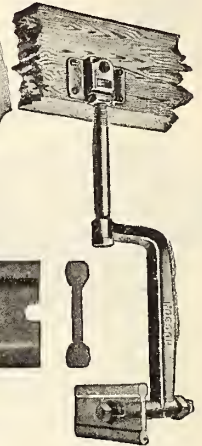

No. 103.

No. 102—I-Beam Track—This track with hangers placed two feet apart will carry many times the load it will ever be called upon to sustain. It is not necessary to have bends made at the factory as the track can be curved to fit when being installed, extension desired.

No. 103—Two Way all Steel Mounted Switch.  
No. 104—Three Way all Steel Mounted Switch.

High quality steel and malleable iron are used in the construction of these switches, insuring durability.

Mounted and ready for installation—need no assembling on the job.

Either two or three way switches, right or left hand, can be furnished. Both styles operate in same manner.

No. 102—Track per foot.....	\$ .23
No. 90B—Hangers, 4 inch, each.....	.33
No. 90F—Hangers, 8 inch, each.....	.37
No. 90L—Hangers, 12 inch, each.....	.40
No. 90P—Hangers, 16 inch, each.....	.45
No. 103—Two Way Switch.....	8.00
No. 104—Three Way Switch.....	9.65

# Hudson Floor Feed Truck

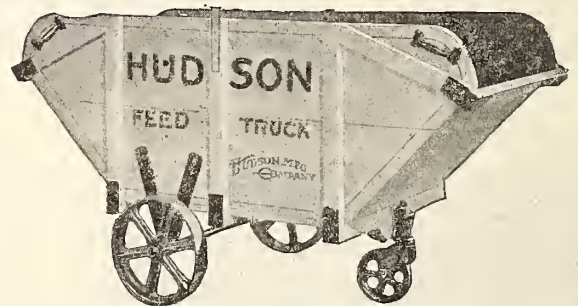

This a very convenient and durable truck, built of selected lumber well put together and strongly reinforced.

Load is evenly balanced on wheels, making truck easy to handle. Wheels are located so that truck may be turned in its own length.

Main wheels are fourteen inches high with a two inch face. Castor wheel is seven inches in diameter. Axle is one inch cold rolled steel shafting. Capacity sixteen bushels.

This truck can be furnished with or without the Hudson Scale Arch.

No. 41 Hudson Floor Feed Truck, galvanized steel bottom. Weight, 210 pounds. Price, \$37.50.

## GALVANIZED STEEL STOCK TROUGHS

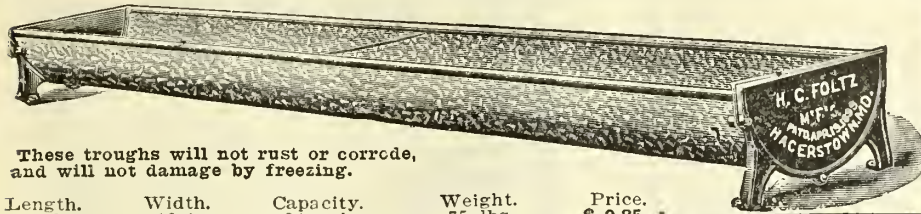

These troughs will not rust or corrode, and will not damage by freezing.

Length.	Width.	Capacity.	Weight.	Price.
4 ft.	16 in.	24 gals.	75 lbs.	\$ 9.85
6 ft.	16 in.	36 gals.	95 lbs.	10.85
8 ft.	16 in.	48 gals.	115 lbs.	12.65
10 ft.	16 in.	60 gals.	135 lbs.	15.20
12 ft.	16 in.	72 gals.	155 lbs.	18.00
4 ft.	20 in.	40 gals.	100 lbs.	11.20
6 ft.	20 in.	60 gals.	125 lbs.	13.50
8 ft.	20 in.	80 gals.	150 lbs.	15.75
10 ft.	20 in.	100 gals.	170 lbs.	19.20
12 ft.	20 in.	120 gals.	195 lbs.	22.25
14 ft.	20 in.	140 gals.	220 lbs.	24.00
6 ft.	24 in.	84 gals.	155 lbs.	18.00
8 ft.	24 in.	112 gals.	185 lbs.	21.40
10 ft.	24 in.	140 gals.	215 lbs.	24.75
12 ft.	24 in.	168 gals.	240 lbs.	28.25
14 ft.	24 in.	196 gals.	270 lbs.	33.15

## GALVANIZED HOG TROUGHS

Width, 10 in.; depth, 5 in.; and the lengths, 2, 3, 4, 5, 6, 7, 8, 9, 10 and 12 feet. The capacity is 2 gallons per running foot.

3 Ft.	.....	\$4.50	6 Ft.	.....	\$6.20
4 Ft.	.....	5.10	8 Ft.	.....	7.35
5 Ft.	.....	5.65	10 Ft.	.....	8.50



Heavy Cast-Iron Hog Troughs.

No danger of them bursting in winter. Twelve inches wide at the top, 2 inches wide at the bottom and 7 inches deep. Made in lengths from 2 feet up to 12 feet, every 12 inches. Weight, 19 pounds to the foot. Price, \$1.00 per foot. We also carry in stock a lighter weight trough like the one illustrated above. Price, \$0.90 per foot.

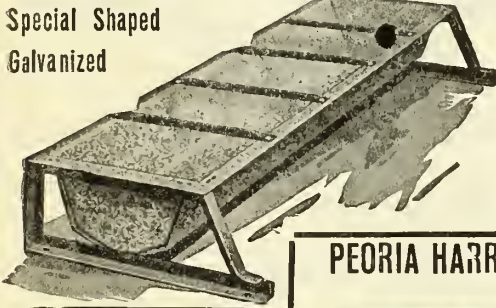

Special Shaped Galvanized

## HOG TROUGHS

## CAST-IRON CORNER MANGERS.

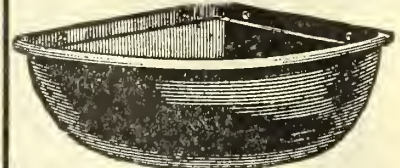

No. 1—15½ in. long, 15½ in. wide, 9 in. deep, flat front. Price, \$3.00.  
No. 2—17 in. long, 17 in. wide, 10 in. deep, roll front. Price, \$3.50.  
Special Prices in Quantities.

## WROUGHT HAY RACKS.

Far superior to cast-iron Racks, as frequently used. Price, \$3.50.

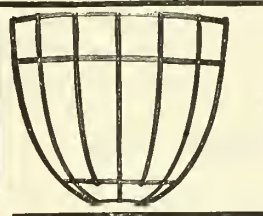

## ROTO SALTS

SALT CAKES. Each, 25c.

ROTO SALT HOLDERS,

50c.

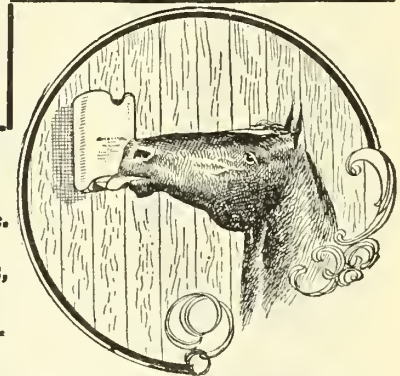
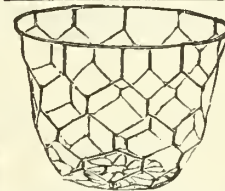

## HORSE MUZZLES

Well made and of good stout wire. No. 18—Plain. List Price, dozen, \$1.20. Our Special Price, each 10c. No. 16—Braced. List Price, dozen, \$2.00. Our Special Price, each, 15c. No. 15—Braced. List Price, dozen, \$2.50. Our Special Price, each, 20c.

The trough is built of 18-gauge galvanized sheet iron, ends are locked seamed, with reinforcing plates on the corners; angle iron dividers across the trough at intervals of 12 inches, riveted to the galvanized sheets.

These angle iron dividers are so strong that a man can stand on them without bending them; they not only give the trough great rigidity and strength so it cannot wrack, but they also separate the hogs, keeping any one hog from monopolizing the entire trough. Hogs cannot tip the trough.

The legs of the trough are on angle steel, fastened to the trough with heavy rivets.

The bottom of the trough is V shaped, and sides have a flare. 4-ft. length, \$8.00. 6-ft. length, \$12.00. 8-ft. length, \$15.00.

## PEORIA HARROW GRASS AND ALFALFA SEEDER

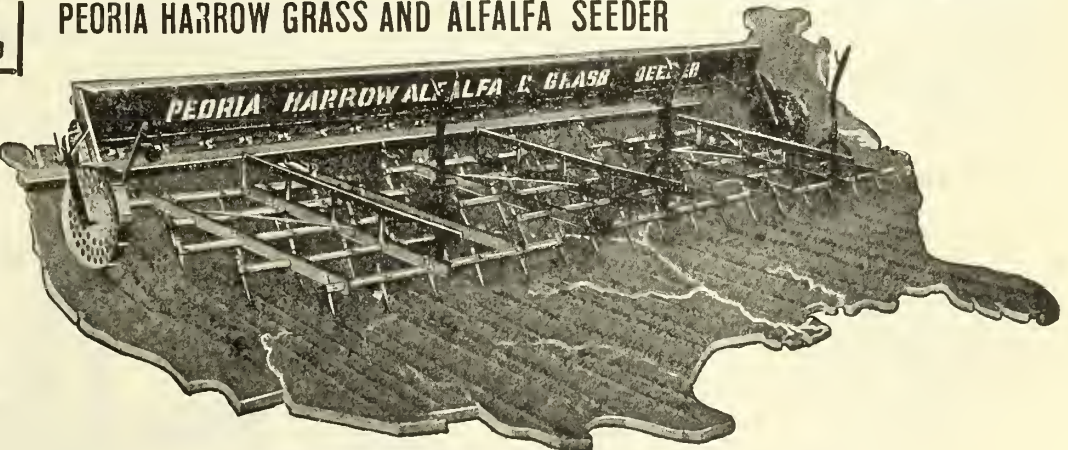

### HARROW AND PLANT AT ONE OPERATION

Save Time—Save Labor  
Save Seed

When renovating old turf or in new construction always harrow after seeding.

Harrowing loosens the top soil; opens up the turf so air and moisture can get in. Gives a healthier, sturdier, closer growing stand of long wearing sod. Livens up the soil, strengthens the plant roots so that divots will fill up quickly, worn and burned spots will come back in record time.

### GIVES THE SEEDS A CHANCE

It cuts fairway seeding labor in half; makes power go twice as far—the only tool of its kind in the world. Attaches to the evenbar of any old or new, wood or steel harrow. Quickly detached by removing coupling pins. Needs little storage space. Sows all grass seeds more uniformly than by any other method. Covers seed to proper depth. The only tool that will not bury seed too deep. Force feed. Adjustable to any desired quantity. Seeds close to the ground. No scattering or wastage from wind. Made in 10, 12, 15 and 16 foot lengths for 2 and 3 section harrows. Feeds are only 4" apart, insuring even distribution.

Greens committees, superintendents and professionals are buying this new machine for the time it saves and the better work it does. Revolutionizes work—cuts it in half. Pays for itself the first time over.

10 ft. .... \$27.00. 12 ft. .... \$29.25. 15 ft. .... \$32.50. 16 ft. .... \$33.50.

### FOLDED DUCK BACK BANDS.



42 and 44 inch...\$0.90  
48 inch.. 1.00

**Boss Back Band Hooks.**  
Per pair, 3 1/2 in....\$0.25  
Per pair, 4 in.... .30

### WEB BACK BANDS.

Less Hooks.  
No. 1—3 1/2-in., 42-in. long....\$0.40  
No. 1—4 -in., 42-in. long.... .45  
No. 2—3 1/2-in., 42-in. long.... .35  
No. 2—4 -in., 42-in. long.... .40

### BACK BAND HOOKS.

3 1/2-in. ....\$0.25  
4 -in. .... .30

### HAME STRINGS. Black.

5/8x42-inch slit, each. ....\$0.20  
3/4x42-inch slit, each. .... .25

### Rawhide.

5/8x42-inch slit, each. ....\$0.20

### HAME STRAPS.

1 inch riveted.....\$0.25  
1 1/2 inch riveted and sewed.. .30  
1 1/4 inch riveted and sewed.. .35

## Sweat Pads

### FELTLESS

Pinked, Felt Edges, Composite Filling, Four Hooks.

Old Gold Drill; best on the market.

18 to 20-inch.....\$0.60  
21 to 24-inch..... .65  
23 to 24-inch..... .75

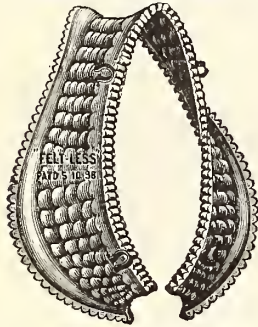

### HORSE COLLARS

No. 61—Team, Split Leather Rim and Back. Blue Tick Face .....\$2.25  
No. 57—Hair Scotch, Split Leather Rim and Back and 1/2 Fender. Red Tick Hair Face ..... 3.00  
No. 83X—Balto. Scotch Split Rim and Back Pop-Stitch, Kip Face..... 3.75  
No. X8—Hair Scotch, Kip Rim and Back and 1/2 Fender. Blue Tick, Hair Face 4.50  
No. X81—Balto. Scotch, all Kip ..... 5.00

### BUGGY WHIPS

No. 50—6 ft..... .60  
No. 17—5 1/2 ft..... 1.00  
No. 100—6 ft..... 1.00

## BUGGY TOPS

**Drill Top**, lined with nice union cloth. Tubular sockets and second-growth bows, wrought rail and joints, stitched front valance, does not show nails or tacks. Will keep in shape. **Side Curtains are included**, making top complete.

**OUR SPECIAL PRICE** .....\$20.00

**Rubber Top**, cloth lined, tubular sockets and second-growth bows, wrought rail and joints, stitched front valance, no nails or tacks exposed. Will keep shape for years. Complete with side curtains. **OUR SPECIAL PRICE** .....\$24.00

## BUGGY BACK

In ordering Backs, give exact measurement of seat at top of rim, from out to out; or, if seat is ready ironed up with back board in position, send paper pattern of the exact size and shape of back wanted.

Enameled Drill, **Retail**, \$8.00. Heavy Rubber, **Retail**, \$10.00.

### CORDED TOP BUGGY CUSHION

**NICELY MADE**—In ordering Cushions, give size of bottom of seat inside, size of fall at top and bottom, and depth from top of sill, or enclose paper pattern.

Union Cloth—**Retail**, \$8.75. Rubber Drill—**Retail**, \$8.75. Imitation Leather—**Retail**, \$10.00.

## WAGON CUSHION

Black Enameled Drill, 20 to 34 inches long, stitched edge. **Our Special Price**.....\$4.75

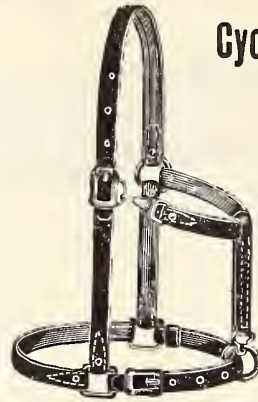

## Cyclone Leather Horse Halters

No. 58

One and one-quarter inch. Stitched, extra strong.  
**Our Special Price**, \$2.00 each.

One and one-half inch. Stitched, extra strong, black leather.  
**Our Special Price**, \$2.25 each.

## Leather Cow Halters

**Our Special Price**, \$1.50 each.

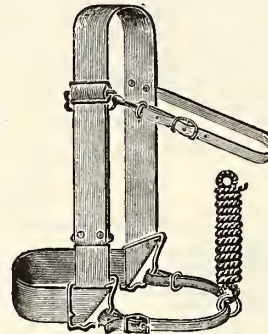

## Colt Halter--Russet Leather

Made especially for Colts; from best leather.

**Our Special Price**, \$1.75 each.

## Adjustable Web Halters, No

Continuous piece, solid color. No. 1 extra quality web, folded through metal corners, adjustable buckle. Leather chin piece with buckle. Rope lead, leather latch, snap.

**Our Special Price**, 75c. each.

**No. 2—WEB HALTERS. PRICE 60c.**

### ROPE CATTLE TIES

No. 652.—Half-inch Manila rope, 6 feet long, single snap. List Price, \$12.00 dozen. **Our Special Price**, 60c. each.  
No. 655.—Half-inch XX Sisal rope, 8 feet long, single snap. List Price, \$8.25 dozen. **Our Special Price**, 50c. each.

### ROPE HORSE TIES

No. 652.—Half-inch Manila, 10 feet long (2 snaps): List Price, \$11.80 dozen. **Our Special Price**, 60c. each.  
No. 667.—Half-inch XX Sisal, 10 feet long (2 snaps). List Price, \$8.50 dozen. **Our Special Price**, 50c. each.

### SHAFTS

Ironed, complete, painted, for Buggies. **List**, \$14.00. **Our Special Price**, \$9.00.

Ironed, complete, painted, for Daytons and Surreys. **Our Special Price**, \$10.00.

### "BALTIMORE" IRON BUGGY POLE

**OUR SPECIAL PRICE** .....\$12.50

### DAYTON POLE

**OUR SPECIAL PRICE**.....\$15.00

## CARRIAGE AND WAGON HARNESS DUMP CART HARNESS

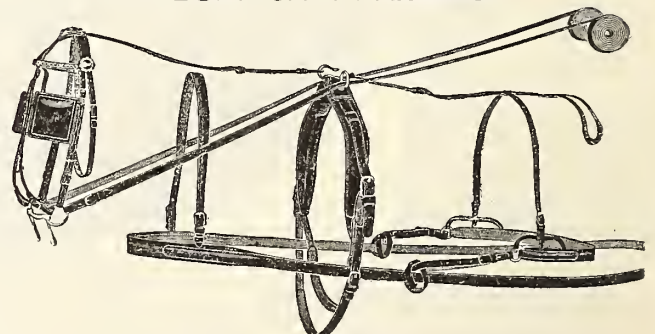

**PRICES ON HARNESS ON APPLICATION.**



## BALTIMORE STRAP HAME

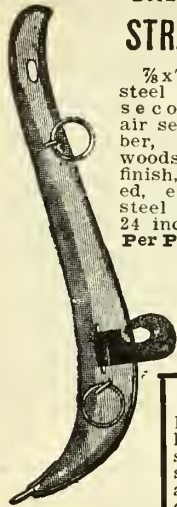

$\frac{3}{8}$  x 7/32-in. flat steel selected second growth, air seasoned timber, extra wide woods, superior finish, hand forged, extra heavy steel hook, 17 to 24 inches.  
Per Pair...\$2.25

**No. 1 HAME**  
An excellent light hame and has three top strap loops instead of two as shown in cut. **PRICE, per pair, \$1.25**

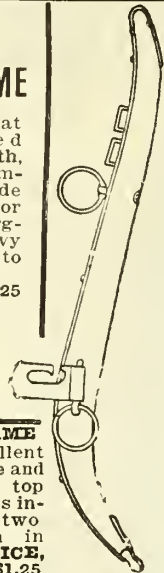

## VIRGINIA CART

No. 61

Rock elm or ash wood.  $\frac{1}{8}$ -inch stiff-bottom loops.  $\frac{3}{4}$  x  $\frac{1}{4}$ -in. steel backs. Three mortise to p loops. Heavy wrought steel hooks. Var-nished, polished irons. Size, 19- to 22-inch.

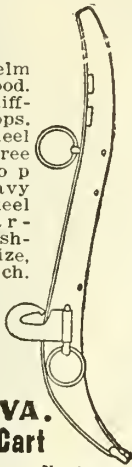

**PRICE,**  
Per  
Pair, **VA. Cart**  
\$2.25

No. 61.

## COW CHAINS

**TRIUMPH CHAINS**—Very light; possess great strength; all links have equal strength. Do not kink; no welds to give way; no sharp edges.

- No. 3-0—Bulldog Cow Tie (Ohio pat.), each, 30c.
- 4-0.....\$0.40
- No. 3-0—4 1/2-ft. Halter, each, 40c. 6-ft..... .45
- No. 0—20-ft. Bulldog Tethering Chain, each... .80
- No. 00—20-ft. Bulldog Tethering Chain, each... 1.00
- No. 000—20-ft. Bulldog Tethering Chain, each... 1.15
- No. 0—30-ft. Bulldog Tethering Chain, each... 1.00
- No. 00—30-ft. Bulldog Tethering Chain, each... 1.25
- No. 000—30-ft. Bulldog Tethering Chain, each... 1.40

### OPEN SIDE LAP LINKS

- Open Side Lap Links, polished,  $\frac{1}{2}$  x  $2\frac{1}{2}$ .....15c.
- $\frac{5}{8}$  x 3.....20c.       $\frac{3}{4}$  x 3.....25c.

## Chain Repair Links



- Chain Repair Links,  $\frac{1}{4}$  or 10-2, dozen.....\$0.25
- 9-32, or 10-1, dozen..... .30

### REGULAR IRON TRACE CHAINS.

	Retail Price.
6 1/2-10-3.....	\$ .90 pair
7 - 8-2.....	1.00 pair
7 -10-2.....	1.10 pair
7 -12-2.....	1.30 pair
7 -14-2.....	1.50 pair
7 -16-2.....	1.90 pair

### SPREADER CHAINS.

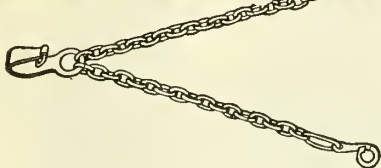

Straight Link Slack Spreader Chain, 11/32. **Our Special Price...\$4.00**  
13/32. **Our Special Price...\$5.00**  
 $\frac{3}{8}$  Close Link Straight Spreader Chain for two horses, with three hooks each.  
**Our Special Price.....\$7.00**

### TUG CHAINS.

Cart Tug Chains, 18-10-1. **Our Special Price, 60c. per pair.**

### BUTT CHAINS.

	Retail
3 ft.—8-2, Per Pair.....	\$1.00
3 ft.—10-2, Per Pair.....	1.10

### LOG CHAINS.

Long Link Log or Ox Chain, 5/16 in., 12 or 14 ft. **Retail Price, 16c. lb.**  
Long Link Log or Ox Chain,  $\frac{3}{8}$  in., 12 or 14 ft. **Retail Price, 15c. lb.**  
Long Link Log or Ox Chain,  $\frac{1}{2}$  in., 12 or 14 ft. **Retail Price, 14c. lb.**

### BREAST CHAINS.

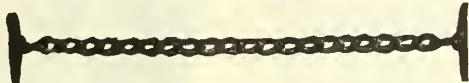

Single Slack.

- 27—5-16 to  $\frac{1}{4}$  Taper Slack.....\$1.00
- 27— $\frac{3}{8}$  to 5-16 Taper Slack..... 1.25
- 28 in. No. 10-2—Single Slack, pair..... 1.00
- 28 in. Double Slack, pair..... 1.10

### FIFTH CHAINS WITH SPREADER.

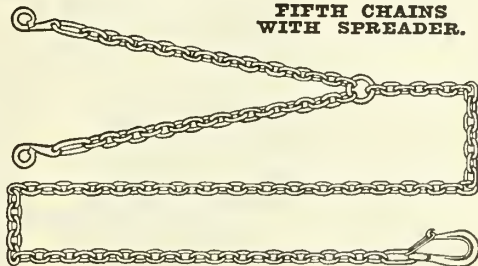

No. 67—**FIFTH CHAIN**—Round hook, ring and swivel; black; made with spreader 8 1/2 ft. long to spreader 13-32. **Our Special Price, \$7.00.**

## KINNEL EMERGENCY CHAIN OVERSHOE FOR HORSES

**NO EXCUSE FOR HORSES SLIPPING**



**Put the Kinnel Emergency Shoe on Your Horses. Prevents suffering and loss.** Just the thing to prevent horses from breaking legs, causing innumerable falls, delay, suffering and financial loss on account of icy, snowy weather.

Special Chain Shoes for Mules; small, medium and large. The average 1400-lb. horse requires a No. 5. The average 1600-lb. horse requires a No. 6.  
**Price, per Set of 4, \$6.00. Pair, \$3.00**

## CURRY COMB

### ALL-STEEL CLOSED BACK

No. 800.



**Our Special Price, 30c. ea.**

No. 800—

All Steel closed back, lacquered, extra size, oval face, curved knockers, braced shank, extending through handle and riveted, enameled handle, brass ferrule, 8 bars.

No. 167—All steel, closed back, 6 bars.

**Our Special Price, 25c. each.**



No. 167

No. 083—Open Back Curry Comb.  
**Our Special Price, 20c. each.**

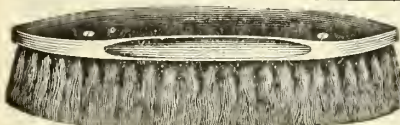

## DANDY BRUSHES

- No. 985—Oval Brush.....\$0.60 each
- No. 940—Palmetto Dandy..... .45 each
- No. 965—Palmetto Dandy..... .55 each
- Leather Back Bristle Army Brush..... 1.00 each

## BADGER TIRES and TUBES

**DOUBLE-CABLE-BASE CONSTRUCTION.**

A patented type of construction, consisting of a "flexible bead filler" carrying unstretchable and unbreakable cables in each bead of the base of the tire. The strong double cables provide perfect "heel and toe" anchorage of the tire base to the rim makes it impossible for the bead to break or stretch, or permit the tire to blow over the rim. **Double-Cable-Base** construction is found in all Badger tires except the regular clincher type.

Sizes	Badger Nonskid Fabric	Beaver Nonskid Cord	Badger Nonskid Cord	Tubes Gray
*30x3	\$7.20	.....	.....	\$1.20
*30x3 1/2	8.35	.....	\$13.25	1.40
32x3 1/2	.....	10.35	13.62	1.65
31x4	.....	13.40	15.05	2.05
32x4	.....	14.15	16.95	2.10
33x4	.....	14.75	17.55	2.15
34x4	.....	15.30	18.15	2.20
32x4 1/2	.....	19.00	22.40	2.90
33x4 1/2	.....	19.60	23.00	2.95
34x4 1/2	.....	.....	23.55	3.05
33x5	.....	.....	29.85	3.75
35x5	.....	.....	31.00	4.00

\*Sizes and Styles marked (\*) furnished in Clincher Type only. Other sizes and styles furnished in S. S. Type Only.



Nonskid Fabric.



Nonskid Cord.

## BADGER CORD TIRES For Commercial Cars

A patented type of construction, consisting of a "flexible bead filler" carrying unstretchable and unbreakable cables in each bead of the base of the tire. The strong double cables provide perfect "heel and toe" anchorage of the tire base to the rim makes it impossible for the bead to break or stretch, or permit the tire to blow over the rim. **Double-Cable-Base** construction is found in all Badger tires except the regular clincher type.

Sizes	Price
32x4 1/2	\$27.00
34x4 1/2	28.25
33x5	34.50
34x5	35.25
35x5	36.15
36x6	55.55
36x6 Inner Tube	12.00

## The Springfield Tire Pump

**SINGLE ACTING DOUBLE BARREL**

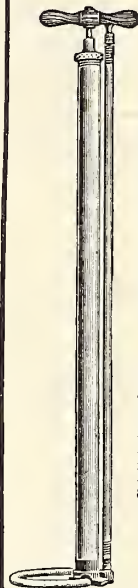

This pump is nearly twice the length of the ordinary double or triple acting pumps. We can, therefore, safely guarantee it to deliver as much air to the single stroke, and besides, the operator stands erect and eliminates the tiresome "up pull" which is characteristic of the compound pumps.

Heavy brass valve connection, machined to fit any standard valve stem, malleable iron cap, long rod bearing, five-ply air hose. Test 200 pounds. Length over all 30 inches. Ball air checks and swivel stirrup.

PRICE.....\$3.00

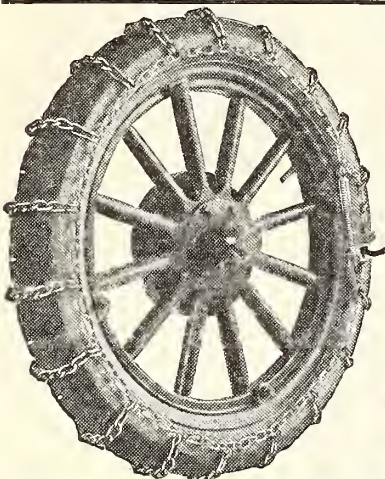

**Hodell First-Aid Tire Chains**, are unequalled in design, construction and general appearance and are being accepted by discriminating motorists as the latest word in anti-skid devices. The Hodell Tire Chains are equipped with Hodell Cross Links which are finished in natural color showing the temper of the steel and likewise constructed with Luminized Side Chains and fitted with Open Easy Fasteners.

Size	Price per set
30 x 3 1/2	\$4.50
32 x 3 1/2	5.00
31 x 4	5.50
32 x 4	5.50
33 x 4	5.75
34 x 4	6.25

Size	Price per set
35 x 4	\$6.75
32 x 4 1/2	6.25
33 x 4 1/2	6.50
34 x 4 1/2	6.75
35 x 4 1/2	7.25

Size	Price
3 1/2 in.	\$0.10
4 in.	.13

Cross Chains.	
Size	Price
5 1/2 in.	\$0.14
5 in.	.16
4 1/2 in.	.18



### PARA-TITE

An all-rubber, self-vulcanizing repair material for inner tubes, and other soft rubber products. Makes a quick, secure and permanent repair.

Price In Screw Top Cans, per can.....\$0.50 (56 sq. in. Para-Tite).

### No. 340 Defender Inside Sleeves

(All Fabric) Made with white face and gray inside frictions with multiple plies heavy square woven duck. Red rubber tipped. Branded Defender. An attractive medium-priced sleeve of excellence and durability.

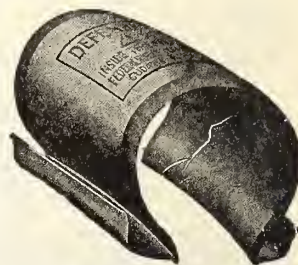

Size	No. Plies	Length	Width Incl. Flaps	Price
3"	3	8"	11 3/4"	\$0.35
3 1/2"	4	9"	12 1/2"	.40
4"	4	10"	13 1/4"	.50
4 1/2"	4	11"	15 1/2"	.55
5"	5	11"	17"	.60

# CHAMPION SPARK PLUGS

DEPENDABLE FOR EVERY ENGINE

Standard For Ford Cars - Ford Trucks  
Fordson Tractors



FOR FORD

X

1/2 Inch. Price 60c



FOR FORD  
X Long  
1/2 Inch Long  
Price 60c

Champion is outselling because it is the better spark plug—better because of its wonderful **double-ribbed sillimanite** core. This core is the finest insulator ever devised. It is exclusively Champion's, because Champion controls the only known commercial supply of **sillimanite**.

It is far superior to ordinary porcelain and is practically immune to breakage. **Sillimanite** resists shocks so well that it makes possible the semi-peticoat tip of Champion cores. This tip becomes so hot in service that it remains free from carbon under the most trying engine conditions. Yet it never causes preignition or mis-firing because of its high heat conductivity.

To this distinct advantage add the Champion two-piece construction, patented gaskets, manganese nickel electrodes and skilled workmanship with most exacting standards of supervision, inspection and thorough test.

## THE SEVEN BLUE BOX TYPES FOR OTHER CARS

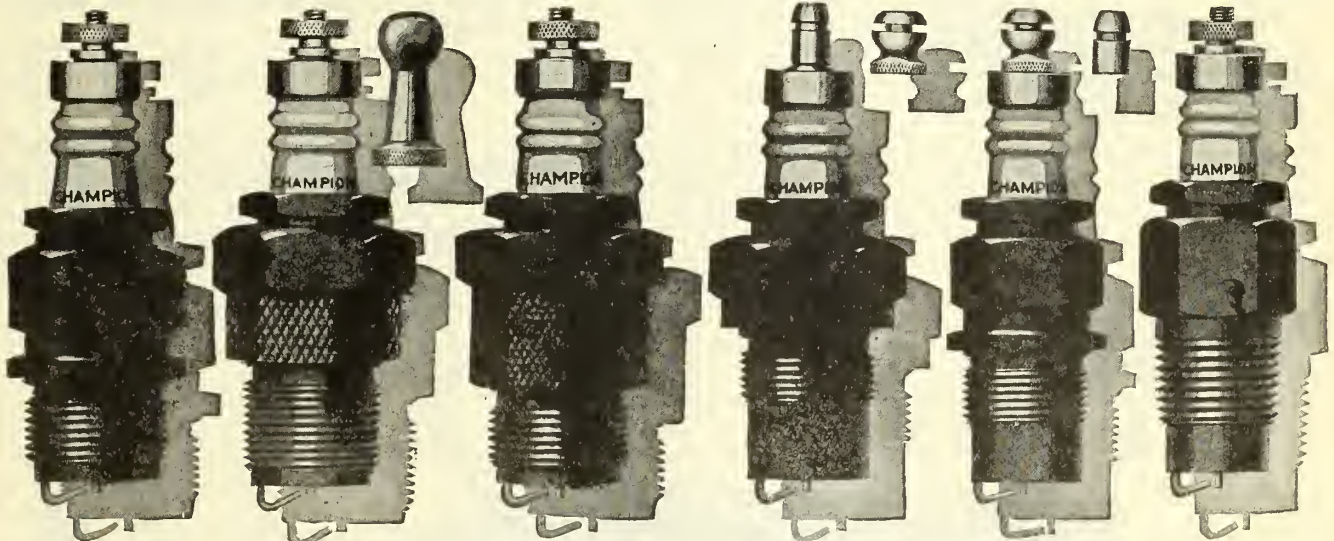

No. 1 No. 2  
3/8 Standard  
Price 75c

No. 3  
3/8 Long Regular  
Price 75c

No. 4  
3/8 Long Body Regular  
Price 75c

No. 5  
3/8 Long Regular  
Price 75c

No. 6  
3/8 Long Standard  
Price 75c

No. 7  
1/2 In. Long Standard  
Price 75c

### PRIMING PLUG



1/2 In.—H-14  
3/8 In.—H-44  
Price \$1.00

We give a partial list of cars the above Champion Plugs are adapted for:

- |  |   |   |   |
|--|---|---|---|
| NO. 1 and 2<br>Columbia<br>Durant 6<br>Haynes<br>Lexington<br>Locomobile<br>Overland 6<br>Saxon<br>Studebaker,<br>Big and<br>Special 6 | Star<br>Stutz 6<br>Willys<br>Knight   | Oldsmobile 8<br>Packard<br>Peerless<br>Pierce Arrow<br>Ranger<br>Roamer<br>Rolls-Royce<br>A 6 | Chevrolet<br>Marmon<br>Oakland 6-24<br>Stutz D. D.<br>Winton to '20   |
| NO. 3<br>Chalmers<br>Dodge Bros.<br>Hupmobile<br>Jewett<br>Liberty<br>Paige<br>Rollins   | NO. 4<br>Cadillac<br>Case<br>Chalmers<br>Chrysler<br>Cleveland<br>Cole<br>Crawford<br>Davis<br>Hudson<br>Jordan<br>Moon<br>Maxwell<br>Lincoln<br>Kissel | R. & V.<br>Knight<br>Standard 8<br>White<br>Wills Ste<br>Claire<br>Winton<br>from '20         | NO. 6<br>Buick from<br>8-1-23<br>Durant 4<br>Kessler<br>Mercer 4<br>Nash<br>Oakland<br>Oldsmobile 4<br>Oldsmobile 6<br>Stearns<br>Knight<br>Studebaker<br>Light 6 |

For Trucks, Tractors, Motorcycles, Farm, Stationary, Marine and Lighting Engines, write for list. A Champion for every service.

### CHAMPION CORES Gaskets Furnished

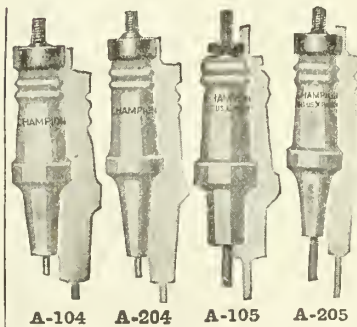

Core	Plug Type	List Price
A-104	No. 1, A74 No. 8, A64...	\$.40
A-105	X-A15	.30
A-205	X Long-A25	.30
A-204	No. 3, No. 4 No. 5, No. 6 No. 7	.40
A-304	A-34	.40
B-103	B-43	.40
H-104	H-14, H-44...	.40
Extra Gaskets		4c each.

ALL PRICES IN CATALOG SUBJECT TO CHANGE  
WITHOUT NOTICE.

## Automobile and Carriage Heaters

### No. 5-B

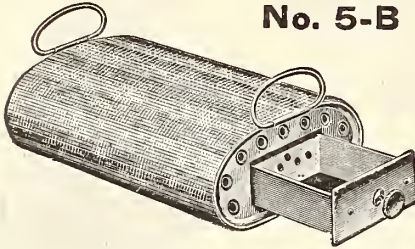

**Strong, Ornamental, Convenient.**

**No. 5B — Clark Heater, 12 inches long, otherwise same as 3D, except carpet is not braid-bound. Weight, 4 lbs. Price, \$3.50.**

### No. 3-D



**No. 3D — Clark Heater 14 inches long, sheet metal case, stamped white metal ends, covering of braid-bound Brussels carpet. Weight, 7 lbs. Price, \$4.00.**

### No. 7-C



**No. 7C — Clark Heater, 14 inches long nickel-plated steel ends, heavily reinforced, covered with Brussels carpet, slanting top, adjustable side and end ventilators. Can be regulated so as to increase or diminish the heat or entirely stop combustion and save coal for future use. Weight, 7 lbs. Price, \$4.00.**

or diminish the heat or entirely stop combustion and save coal for future use. Weight, 7 lbs. Price, \$4.00.

## PREPARED COAL

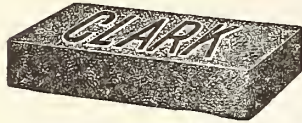

One cake will last 15 to 16 hours. No smoke, odor, flame or gas. **Price, case of one doz. cakes, \$1.20. 100 Bricks in Wood Case, \$9.50.**

## Acme Dump Wagon

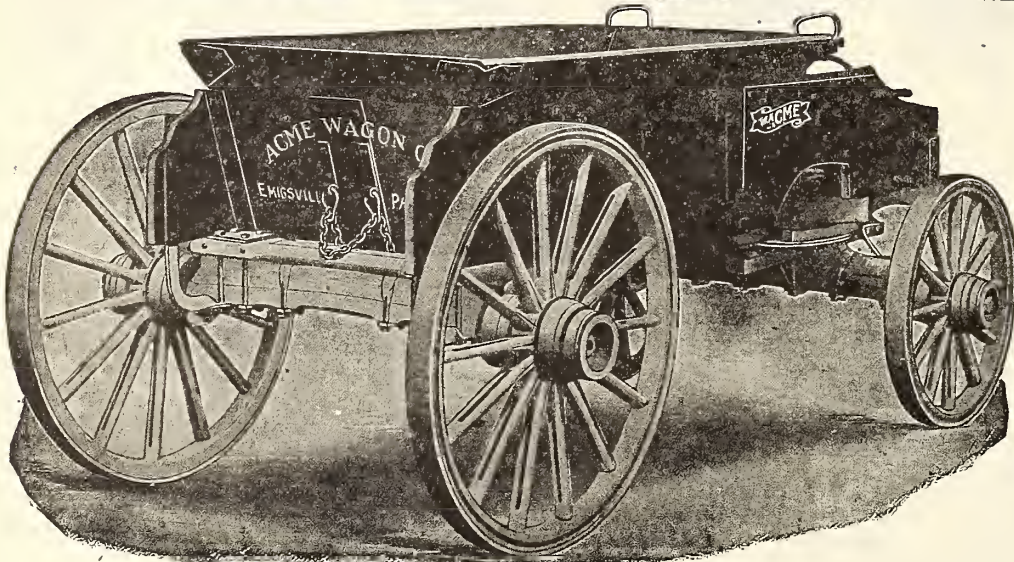

Unequaled for strength, efficiency, durability and ease of operation. The doors overlap each other, thus making it sand-tight.

Heavy steel plates on outside of body over wheel house, making it very strong, and making it practically unbreakable at this point.

With Brake, 3-in. Tires. **1½-Yd. Wagon....\$230.00**

## Improved Sampson Jack

**MALLEABLE IRON.**

Best Jack on the market. Can be used for any height axle. Standard cannot drop back on cogs when raised to extreme height. No breaking of cogs and standards.

- No. 1—Will raise vehicles weighing 2 tons .....\$5.00
  - No. 2—Will raise vehicles weighing 5 tons ..... 6.25
  - No. 3—Will raise vehicles weighing 5 tons, with drop hook..... 7.25
- Can also furnish other Jacks. **Prices on application.**

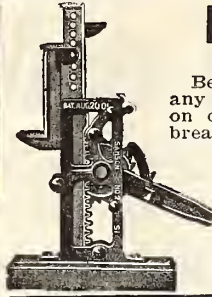

## BELL BOTTOM JACK SCREWS

These Jack Screws have cast-iron stands, with forged head screws. For workmanship and durability they cannot be excelled. Our

Diam. Screw	Height Stand	Height over all	Special Price
1½ in.	12 in.	15 in.	\$4.00
1½ in.	14 in.	17 in.	4.50
1½ in.	16 in.	19 in.	5.10
2 in.	10 in.	14 in.	5.10
2 in.	12 in.	16 in.	5.65
2 in.	14 in.	18 in.	6.20
2 in.	16 in.	20 in.	7.00
2 in.	18 in.	22 in.	7.70
2 in.	20 in.	24 in.	

Capacity 1½-in. diameter screw, 10 tons.  
Capacity 2-in diameter screw, 12 tons.

**Other sizes. Prices on Application.**

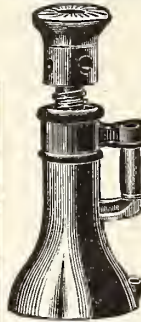

## WOOD WAGON JACK

No. 1—Adapted for buggies or light work. Capacity, 1000 lbs. **\$1.50.**

No. 2—For heavy wagons, trucks, etc. Capacity, 3000 lbs. **\$2.00**

No. 3—**\$2.50.**

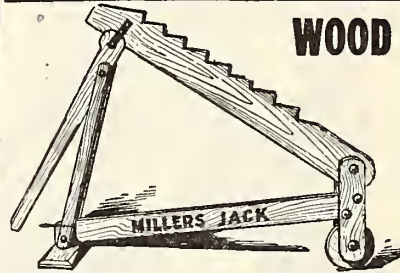

## AUTOMOBILE JACK

This Jack is made from best quality refined malleable iron, with high-grade Steel Screw, aluminum finish, and by single turn of the pawl raises or lowers. It is compact, neat and has sufficient strength to raise any automobile made.

No.	Capacity, Pounds.	Height, Lowered, Inches.	Raises, Inches.	Wgt., Lbs.	Price, Each.
1...	2000	10	6	5	\$1.50
2...	5000	10	6	8	3.00



## GRIFFITH & TURNER

Best Wagons on the Market  
for the Money.

SOLID STEEL AXLE,  
STEEL SKEIN AND  
TUBULAR AXLE  
WAGONS



**1-HORSE  
WAGON**

We carry the Solid Steel and Steel Skein Wagons in stock, and can furnish the Tubular Axle Wagons at short notice.

Size of S'tl Axle	Size of Tubular Axle	Size of Tires	Height Wheels		Dimensions of Body			Weight	Capacity	Wagon Complete No Brakes		Wagon Complete With Brakes		Gears Only With Brakes		Gears Only No Brakes						
			Front Ft. In.	Rear Ft. In.	Length Ft. In.	Width Ft. In.	Depth In. In.			List	Retail	List	Retail	List	Retail	List	Retail					
1 1/4	1 1/2	1 1/4 x 5-16	3	2	3	8	9	0	3	2	9	4	500	1000 to 1200	\$137.24	\$82.35	\$150.74	\$90.50	\$119.24	\$71.55	\$105.74	\$63.35

**No. 40 ONE-HORSE WAGON.**

Size of Nos. S'tl Axle	Size of Tubular Axle	Size of Tires	Height Wheels		Dimensions of Body			Weight	Capacity	Wagon Complete No Brakes		Wagon Complete With Brakes		Gears Only With Brakes		Gears Only No Brakes						
			Front Ft. In.	Rear Ft. In.	Length Ft. In.	Width Ft. In.	Depth In. In.			List	Retail	List	Retail	List	Retail	List	Retail					
1 3/4	1 5/8	1 3/8 x 5-16	3	2	3	8	9	0	3	2	10	4	650	1500 to 1800	\$150.74	\$90.50	\$164.24	\$98.55	\$136.74	\$80.00	\$119.24	\$71.55

For G. & T. One-Horse and No. 40 Wagons with 2-inch tires, add List, \$9.00; Retail, \$5.40.  
For G. & T. One-Horse and No. 40 Wagons with tongue instead of shafts, add List, \$11.25; Retail, \$6.75.

## 2-HORSE WAGON

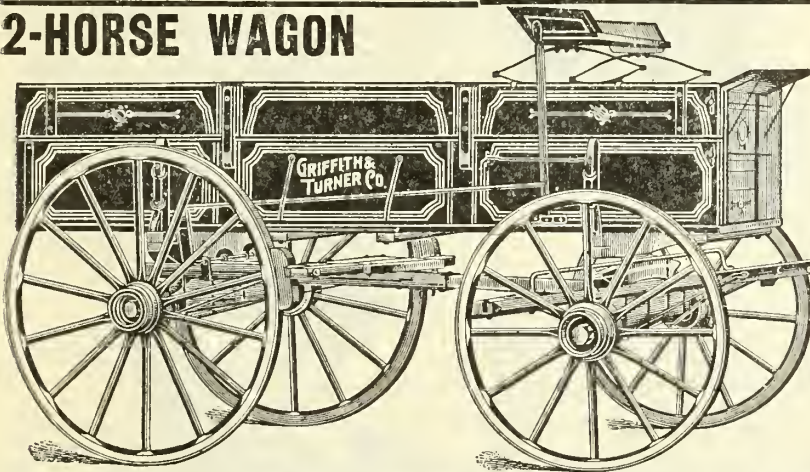

THESE WAGONS ARE HEAVILY IRON AND BRACED. THEY ARE MADE OF THE BEST MATERIAL THROUGHOUT. THE WHEELS ARE DIPPED IN BOILING OIL. HAVE ROUND EDGE TIRES, WHICH PROTECT THE FELLOES AND PAINT. THEY ARE VERY LIGHT RUNNING.

FOR TIRES OF EXTRA WIDTH AND THICKNESS, ADD THE FOLLOWING AMOUNTS TO WAGON PRICES BELOW:

For tires wider than regular on Nos. 42, 44 and 46, add List, \$13.50; Retail, \$8.10 per inch or fractional part thereof. On Nos. 48, 50 and 52, add List, \$18.00; Retail, \$10.80 per inch or fractional part thereof.

For tires thicker than regular, add List, \$11.24; Retail, \$6.75, for every 1/4 inch additional thickness on 3 inches wide and upwards.

Size of S'tl Axle	Size of Tubular Axle	Size of Tires	Height Wheels		Dimensions of Body			Weight	Capacity	Wagon Complete No Brakes		Wagon Complete With Brakes		Gears Only With Brakes		Gears Only No Brakes						
			Front Ft. In.	Rear Ft. In.	Length Ft. In.	Width Ft. In.	Depth In. In.			List	Retail	List	Retail	List	Retail	List	Retail					
42	1 1/4	1 3/8 x 8	3	8	4	0	9	6	3	6	12	6	.....	2000 to 2500	\$211.50	126.90	\$229.50	137.70	\$191.24	114.75	173.24	104.00
44	1 5/8	2 3/8 x 8	3	8	4	0	10	6	3	6	12	6	900	2500 to 3000	227.24	136.35	249.74	149.85	204.50	122.70	186.74	112.00
46	1 3/4	2 3/8 x 9	3	8	4	0	10	6	3	6	12	8	1000	3000 to 3500	252.00	151.20	270.00	162.00	229.50	137.70	211.50	126.90
48	2	2 3/8 x 10	3	8	4	0	10	6	3	6	14	8	1200	4000 to 4500	274.50	164.70	292.50	176.50	257.50	149.50	229.50	137.70
50	2 1/4	2 7/8 x 11	3	8	4	0	Running Gear	1200	6000	.....	.....	.....	.....	.....	.....	.....	.....	270.00	162.00	252.00	151.20	
52	2 1/2	3 3/8 x 12	3	8	4	0	Running Gear	.....	8000	.....	.....	.....	.....	.....	.....	.....	.....	285.74	171.50	267.74	160.65	

Nos.	Size of Axles	Size of Tires	Height Wheels		Dimensions of Body			Weight	Capacity	Wagon Complete No Brakes		Wagon Complete With Brakes		Gears Only With Brakes		Gears Only No Brakes								
			Front Ft. In.	Rear Ft. In.	Length Ft. In.	Width Ft. In.	Depth In. In.			List	Retail	List	Retail	List	Retail	List	Retail							
1...	2 3/4 x 8 1/2	2 x 3 3/8	3	2	3	8	9	6	3	6	12	6	800	2000 to 2500	\$223.74	133.75	\$240.74	144.45	\$202.50	121.50	\$184.50	\$110.70		
2...	3 x 9	2 x 1 1/2	3	6	4	0	10	6	3	6	12	6	1100	2500 to 3000	238.50	143.10	260.74	156.45	.....	.....	240.74	144.45	233.74	133.75
3...	3 1/4 x 10	2 x 5/8	3	6	4	0	10	6	3	6	12	6	1200	3000 to 4000	.....	.....	.....	.....	.....	.....	240.74	144.45	233.74	133.75
4...	3 1/2 x 11	2 x 3/4	3	6	4	0	10	6	3	6	12	8	1400	4000 to 5000	.....	.....	.....	.....	.....	.....	259.74	155.35	240.74	144.45

**EXTRAS FOR G. & T. WAGONS.**

	Special One-Horse		No. 40		No. 42		No. 44		No. 46		No. 48		No. 50		No. 52	
	List	Retail	List	Retail	List	Retail	List	Retail	List	Retail	List	Retail	List	Retail	List	Retail
Bodies	\$40.50	\$24.50	\$40.05	\$24.50	\$47.24	\$28.50	\$47.24	\$28.50	\$49.50	\$29.75	\$54.00	\$32.50	\$67.50	\$40.50	.....	.....
Spring Seat	9.00	5.40	9.00	5.40	9.00	5.40	9.00	5.40	9.00	5.40	9.00	5.40	9.00	5.40	.....	.....
Tongues	18.00	10.80	18.00	10.80	.....	.....	.....	.....	.....	.....	.....	.....	.....	.....	.....	.....
Shafts	15.20	9.50	15.20	9.50	.....	.....	.....	.....	.....	.....	.....	.....	.....	.....	.....	.....
Wheels, Reg., per set	54.56	33.75	60.74	36.56	88.86	53.50	97.30	58.50	105.18	61.25	113.62	68.25	141.74	85.00	154.12	92.50
Solid Steel Axles.	11.24	6.75	12.10	7.25	13.22	8.00	16.40	9.75	19.42	11.75	23.92	14.50	27.30	16.50	.....	.....

## THREE SPRING DELIVERY WAGON

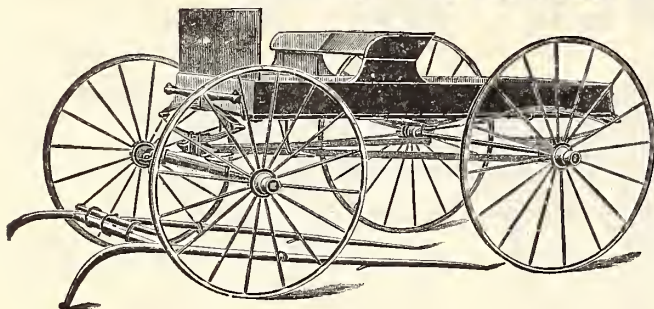

Size	Height		Dimensions of Body			List	Retail	Wagon Complete No Brakes							
	Front	Rear	L'gth	Width	Depth										
Steel	Ft	In	Ft	In	In	Wght	Cap								
1	1	x 1/4	3	3	3	8	7	0	3	1	9	400	800	\$157.50	\$94.50
1 1/2	1 1/2	x 5-16	3	3	3	8	7	0	3	1	9	500	1000	164.25	98.55
Brake for above.....													List, \$13.50;	Retail, \$ 8.10	
Tops for above.....													List, 63.00;	Retail, 37.80	

## Duplex Spring Delivery Wagon

Similar to above, except it has a duplex spring gear.

Size	Height		Dimensions of Body			List	Retail	Wagon Complete No Brakes							
	Front	Rear	L'gth	Width	Depth										
Steel	Ft	In	Ft	In	In	Wght	Cap								
1	1	x 1/4	3	3	3	8	7	0	3	1	9	400	800	\$146.25	\$87.75
1 1/2	1 1/2	x 5-16	3	3	3	8	7	0	3	1	9	500	1000	153.50	91.85
Brake for above.....													List, \$13.50;	Retail, \$ 8.10	
Tops for above.....													List, 63.00;	Retail, 37.80	

## METAL TRUCK WHEELS

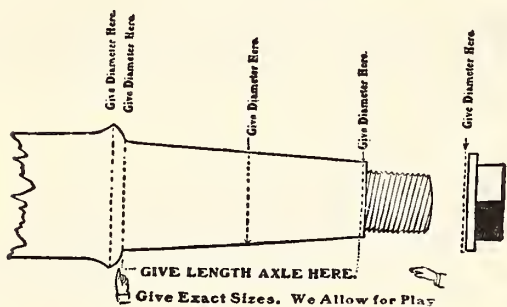

Diagram Showing How To Measure Your Skelns.

As nearly every set of steel wheels we sell has to be made especially to correspond with measurements of axles for which it is intended, we generally make shipment direct from factory.

### PRICES PER WHEEL WITH 4x 3/8 TIRES.

24-inch—Our Special Price.....	\$6.60
26-inch—Our Special Price.....	6.90
28-inch—Our Special Price.....	7.30
30-inch—Our Special Price.....	7.70
32-inch—Our Special Price.....	8.40
34-inch—Our Special Price.....	8.80
36-inch—Our Special Price.....	9.50

For 4x 1/2 Tire, prices on application. Wood Wheels, prices on application. Prices on other sizes quoted on application.

## HAND TRUCKS

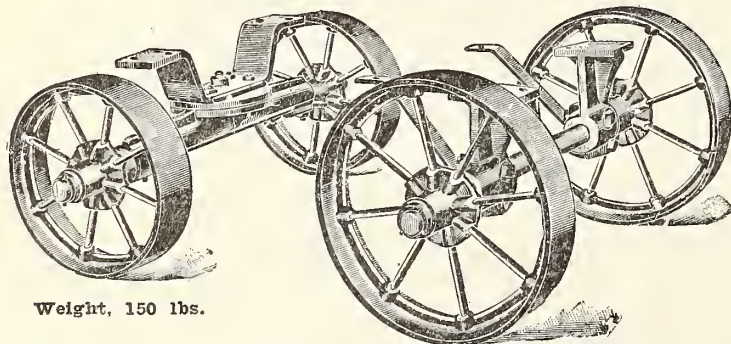

Weight, 150 lbs.

For mounting small engines. Wheels 12x14 inches high, with 2- or 3-inch tread; steel axles, 1 1/4-inch round; hubs, 4 1/2-inch long; capacity, 2000 pounds. This gear can be bolted to the skids of engine or a platform may be bolted on. A tongue is furnished with each truck.

Hand Truck, with 2-inch tires, Our Special Price.....	\$18.25
Hand Truck, with 3-inch tires, Our Special Price.....	20.35

## HEAVY STUDEBAKER ROAD CART

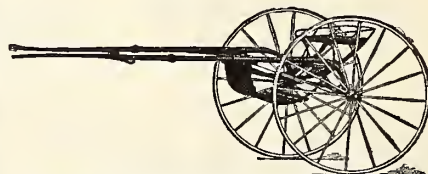

No. 178 Heavy Road Cart has two-passenger slat seat, slat foot-rack, 1-inch double collar steel axle, 7/8-inch wheels, 46 inches high, and hickory shafts. Shipping weight, 125 pounds. List Price, \$50.00. Our Special Price, \$32.00.

## LIGHT ROAD CART

No. 4 1/2 Light Road Cart has low seat support, two-passenger slat seat spring hung in swinging shackles, 7/8-inch wheels, 46 inches high, 1-inch double collar steel axle and hickory shafts. Shipping weight, 125 pounds. List Price, \$48.00. Our Special Price, \$30.00.

## BUGGY



### DESCRIPTION.

**Gear**—Arched Axle, Four plate graded and tempered springs. Reaches ironed full length.  
**Wheels**—Best grade split hickory, 3/4 or 7/8 inch tread.  
**Shafts**—XXX Hickory, ironed to heel, 36 inch genuine leather points.  
**Body**—Piano, with high panel back seat.  
**Trimmings**—Soft leather throughout.  
**Painting**—Body and seat black, gear red or black.  
**Top**—Leather Quarter.

<b>PRICE</b> .....	\$125.00
Cheaper Buggy with Art Leather Trimmings .....	\$108.75

# OUR HANDY STEEL WHEEL FARM TRUCKS

All wood parts hardwood and well painted. Note the grooved tire, which protects the spokes of the wheel, and they last much longer than flat tire wheels. Made in two sizes. No. 22 with 3x9 skeins, capacity 3,000 lbs. No. 24 with 3 1/4 x 10 skeins, capacity 4,000 lbs.

Both Nos. 22 and 24 Trucks have 28-inch front and 30-inch rear wheels, 4x 3/8 tires. Weights—No. 22, 475 lbs.; No. 24, 510 lbs. No. 22 Truck—List Price, \$83.00; Our Special Price, \$50.00. No. 24 Truck—List Price, \$84.00. Our Special Price, \$51.50.

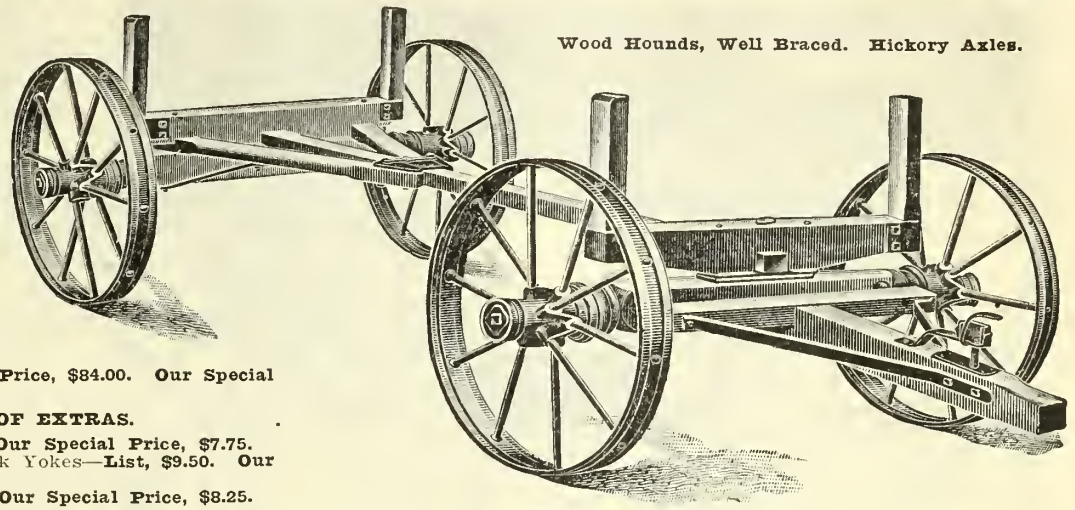

Wood Hounds, Well Braced. Hickory Axles.

**PRICES OF EXTRAS.**

Brake—List, \$12.50. Our Special Price, \$7.75.  
 Double Trees and Neck Yokes—List, \$9.50. Our Special Price, \$6.00.  
 Shafts—List, \$14.50. Our Special Price, \$8.25.

## OUR NO. 34 LOW-DOWN WOOD WHEEL FARM TRUCK

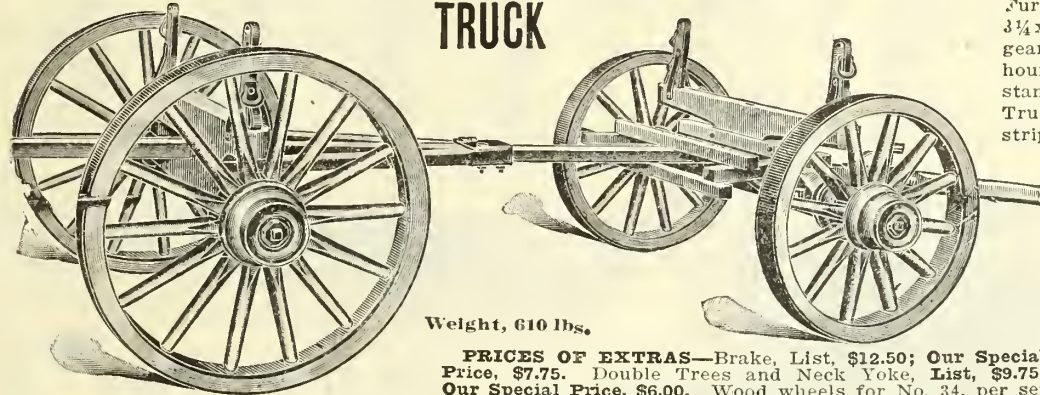

Weight, 610 lbs.

This truck has low-down wood wheels 32 and 36 inches in height, with 4-inch tires. Furnished with hickory axles. 3 1/4 x 10-inch skeins, hardwood gear parts; both front and rear hounds, and has regular wagon standards, ironed and ringed. Truck nicely painted and striped. Capacity 4000 lbs.

With 3-inch tires—	
List Price,	Our Price,
\$126.00	\$77.00
With 4-inch tires—	
List Price,	Our Price,
\$137.50	\$82.50

**PRICES OF EXTRAS**—Brake, List, \$12.50; Our Special Price, \$7.75. Double Trees and Neck Yoke, List, \$9.75; Our Special Price, \$6.00. Wood wheels for No. 34, per set of 4, List Price, \$96.00; Our Special Price, \$55.00.

# THE OLD DOMINION WAGON

3 1/4 x 10-inch hickory axle, wood-wheels, 36-in. front, 42-in. rear, 3 x 3/8-in. tire. A serviceable wagon at a low price.



Weight, 675 Lbs.

List Price, \$160.00      Our Price, \$100.00

**PRICES OF EXTRAS**—  
 1/2 Brake, List, \$12.50. Our Special Price, \$7.75.

Double Trees and Neck Yoke. List, \$9.75. Our Special Price, \$6.00.

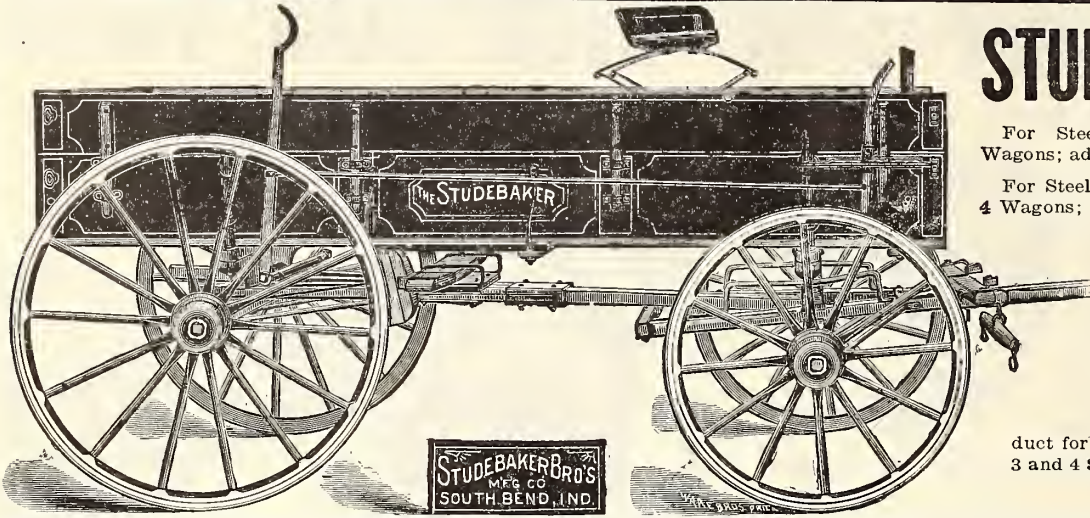

## STUDEBAKER

For Steel Skeins on No. 2 Wagons; add to Retail, \$8.00.

For Steel Skeins on No. 4 Wagons; add to Retail, \$9.00.

If WAGONS are wanted without brake, deduct on No. 2, \$7.25. On Nos. 3 and 4, deduct \$7.65. On No. 5, deduct \$8.10. If GEARS are wanted without brake, deduct for No. 2 \$6.30. For Nos. 3 and 4 \$6.75. For No. 5 \$7.25.

Size of Skeins	Height of Wheels		Size of Tire	Dimensions of Box			Approximate		Wagon complete with brake	Gear only with brake			
	Front	Hind		Lower	Top	Length	Weight	Capacity					
Inches	Ft.	In.	Ft.	In.	In.	In.	Ft.	In.	Lbs.	Lbs.	Retail Price	Retail Price	
2 1/2 x 8	3	6	3	10	2 x 3/8	12	8	10	0	825	2000	\$139.50	\$109.80
2 1/2 x 8	3	6	3	10	2 1/2 x 3/8	12	8	10	0	825	2000	144.00	117.00
2 1/2 x 8	3	6	3	10	3 x 3/8	12	8	10	0	825	2000	150.30	121.50
2 3/4 x 8	3	6	3	10	2 x 7-16	12	8	10	0	850	3000	146.70	115.20
2 3/4 x 8	3	6	3	10	2 1/2 x 7-16	12	8	10	0	850	3000	150.30	121.50
2 3/4 x 8	3	6	3	10	3 x 7/8	12	8	10	0	850	3000	158.40	123.75
2 3/4 x 8	3	6	3	10	4 x 7/8	12	8	10	0	850	3000	166.50	137.25
3 x 9	3	6	3	10	2 x 1 1/2	13	8	10	6	1000	4000	150.30	121.50
3 x 9	3	6	3	10	2 1/2 x 1 1/2	13	8	10	6	1000	4000	157.50	124.00
3 x 9	3	6	3	10	3 x 1 1/2	13	8	10	6	1000	4000	159.75	127.25
3 x 9	3	6	3	10	4 x 1 1/2	13	8	10	6	1000	4000	171.00	141.75
3 1/4 x 10	3	6	3	10	2 x 5/8	14	10	10	6	1100	4500	157.50	126.00
3 1/4 x 10	3	6	3	10	2 1/2 x 1 1/2	14	10	10	6	1100	4500	161.10	131.40
3 1/4 x 10	3	6	3	10	3 x 1 1/2	14	10	10	6	1100	4500	163.80	135.00
3 1/4 x 10	3	6	3	10	4 x 1 1/2	14	10	10	6	1100	4500	173.25	144.00

### RURAL TEAM TRUCK WITH DROP TONGUE.

No. 415 1/4 - 3 1/4 x 10-in. Cast Skeins    Front Wheel. 30 inches    Rear Wheel. 36 inches    Drop Tongue    Tires 4 x 3/4 in., wood wheels,    Gear Only, No Brake \$83.25

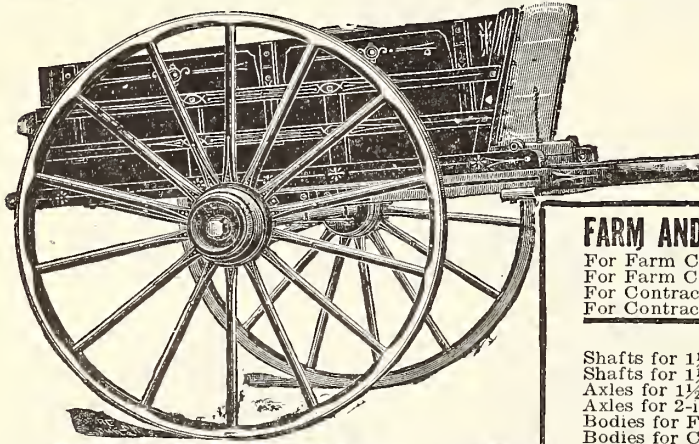

### FARM AND CONTRACTOR'S CARTS

With 5 and 6-inch Tires and extra heavy Contractor's Carts made specially to order when wanted. These Carts are very strong, heavily ironed nicely painted, striped and varnished.

	List Price	Our Special Price
1 1/2 inches. 3 inches. 4 ft. 8 in.	\$130.56	\$ 78.30
1 1/2 inches. 4 inches. 4 ft. 8 in.	146.24	87.75
2 inches. 3 inches. 4 ft. 8 in.	150.74	90.55
2 inches. 4 inches. 4 ft. 8 in.	166.50	100.00

### FARM AND CONTRACTOR'S CART WHEELS

	List Price, Per Pair.	Ret'l Price, Per Pair.
For Farm Cart, 1 1/2-inch axle, 3-inch tire.....	\$54.56	\$33.75
For Farm Cart, 1 1/2-inch axle, 4-inch tire.....	73.56	39.15
For Contractors' Carts, 2-inch axle, 3-inch tire.....	66.94	40.25
For Contractors' Carts, 2-inch axle, 4-inch tire.....	75.94	45.65

	List Price, Per Pair.	Ret'l Price, Per Pair.
Shafts for 1 1/2 or 2-in. Axle Farm Cart, no irons, per pair.....	\$15.18	\$9.10
Shafts for 1 1/2 or 2-in. Axle Farm Cart, with irons.....	22.56	14.00
Axles for 1 1/2-inch Axle Farm Cart.....	17.44	10.50
Axles for 2-inch Contractor's Cart.....	23.62	14.25
Bodies for Farm Cart.....	60.74	36.50
Bodies for Contractors' Cart.....	60.74	36.50

### HARVEY XXX BOLSTER SPRINGS

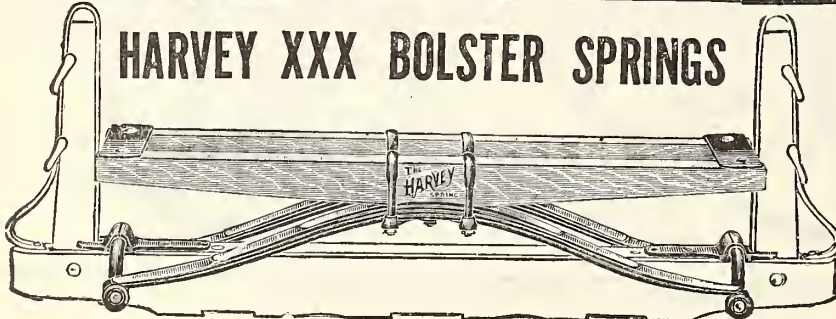

These springs are made from select steel, tempered under the manufacturers' personal supervision. Twenty years' experience back of every Harvey Bolster Spring. They raise the box but a few inches, which decreases as the load is increased. The only spring that can be completely shut down without crushing.

Capacity	42-inch	Capacity	42-inch
1500.....	\$10.50	5000.....	\$21.00
2500.....	13.65	6000.....	23.00
3000.....	15.75	8000.....	27.15
4000.....	18.90	10000.....	31.50



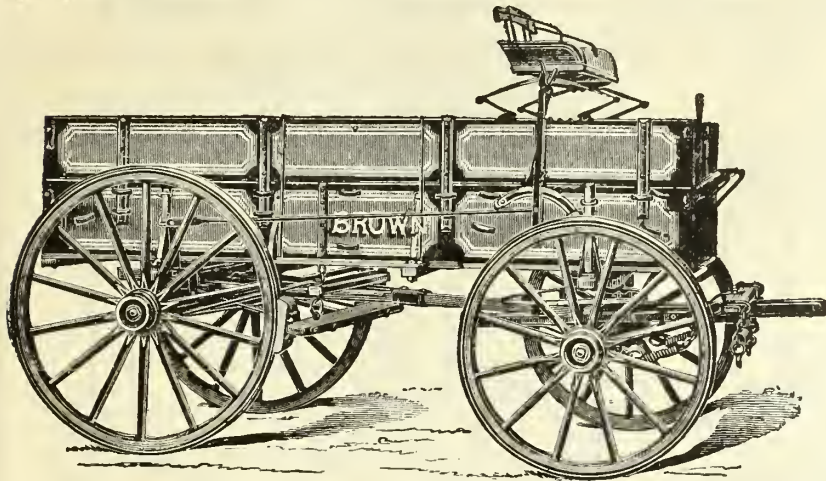

## BROWN WAGON

Axles are made of dried selected hickory. Brown's Patent Extension Chilled Skeins. These Skeins support the axle where it has the greatest load to bear. Tongue Chains and Stay Chains fitted with springs. The Tongue Chains have a branch chain to prevent jerking and switching of the tongue, and eases the draft on the horses' necks. Wheels all positively soaked in hot oil. Tires never get loose. Write for special circular fully describing these Wagons.

Coil springs are applied to tongue—eases draft on team's neck when chains are forced to control tongue or hold back. They supply the place of the vibrating neck yoke. Yield to pull of chain or branch chain, saving team from jerking of tongue. Branch chains are added to each tongue, practically destroying side jerking and whipping motion. Acts same as neck yoke.

No.	Size of Cast Skein.	Height of Front Wheels.	Height of Rear Wheels.	Size of Tire.	Depth of Box.	Capacity, Pounds.	Wagon Complete with Brake.		Gear only with Brake.	
							Price.	Price.		
000	2 1/2 x 8	3 1/4"	3'8"	2 1/2 x 1 1/2	20"	2000	\$156.75		\$120.65	
000	2 1/2 x 8	3 1/4"	3'8"	3 x 1 1/2	20"	2000	161.80		125.70	
00	2 3/4 x 8 1/2	3 1/4"	3'8"	2 1/2 x 1 1/2	22"	2500	159.50		123.30	
00	2 3/4 x 8 1/2	3 1/4"	3'8"	3 x 1 1/2	22"	2500	164.60		128.50	
1	3 x 9	3 1/4"	3'8"	2 1/2 x 1 1/2	24"	4000	165.10		127.15	
1	3 x 9	3 1/4"	3'8"	3 x 1 1/2	24"	4000	170.30		132.40	
1	3 x 9	3 1/4"	3'8"	4 x 1 1/2	24"	4000	181.30		144.60	
2	3 1/4 x 10	3 1/4"	3'8"	2 1/2 x 3/4	26"	4500	178.70		140.75	
2	3 1/4 x 10	3 1/4"	3'8"	3 x 5/8	26"	4500	189.50		146.90	
2	3 1/4 x 10	3 1/4"	3'8"	4 x 5/8	26"	4500	197.10		159.15	

All of above Complete Wagons have Seats and Gear Brakes. Following Special Gears have Linch Pin Steel Skeins, Gear Brakes, and Nos. 3, 4 and 5 have Side and Back Action Brakes with Round Coupling Poles:

2	3 1/4 x 10	3'8"	4'4"	4 x 5/8	...	4500	.....	\$173.75
3	3 1/2 x 11	3'8"	4'4"	4 x 3/4	...	5500	.....	202.10
4	3 3/4 x 12	3'8"	4'4"	4 x 7/8	...	6500	.....	231.10
5	4 x 12	3'8"	4'4"	4 x 1	...	7500	.....	247.50

### Patent Steel Skeins

Revised Price List PATENT STEEL SKEINS.



No.	Size.	Skeins with Boxes, per Set.	
		With Nuts, Price.	Boxes Only, per Set, Price.
2	2 1/2 x 8"	\$15.70	\$2.20
3	2 3/4 x 8"	16.25	2.65
6	3 x 9"	17.60	2.80
9	3 1/4 x 10"	20.35	3.30
11	3 1/2 x 11"	23.10	3.75
14	3 3/4 x 12"	27.50	4.40
15	4 x 12"	31.90	5.25
17	4 1/2 x 13"	47.50	7.70

With Linch Pins.	
No.	Price.
21	3 1/4 x 10" \$20.35
23	3 1/2 x 11" 23.10
25	3 3/4 x 12" 27.50
26	4 x 12" 31.90

Made of the best grade of plate steel. Solid extension back of the collar keeps the wet and grease from working in on axle. Extension back of collar covers all tapering portions and more of the wood of the axle than any other skein.

#### STEEL SKEINS FOR PETER SHUTTLE WAGONS.

	Skein Only with Nut or Linch Pin, each.	Box Only, each.
3 1/4 x 10"	\$4.50	\$1.15
3 1/2 x 11"	5.40	1.35
3 3/4 x 12"	5.85	1.80
4 x 12"	6.75	2.05
4 1/2 x 12"	7.65	2.50
4 1/2 x 13"	10.80	3.00

### S. B. Trade Cast Skeins

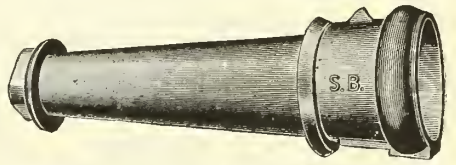

All sizes, from 2 1/2 x 8 to 4 x 12, inclusive, are made with truss attachment, as shown in cut. These skeins are made of a better quality of iron than the ordinary trade cast skeins.

No.	Size.	Cast Skeins, with Boxes.	
		Our Special Price, Per Set.	Boxes Only, Our Special Price, Per Set.
9	2 1/2 x 8"	\$6.00	\$2.00
10	2 3/4 x 8"	6.50	2.20
13	3 x 9"	7.35	2.45
16	3 1/4 x 10"	9.00	3.00
19	3 1/2 x 11"	10.50	3.50
22	3 3/4 x 12"	11.55	3.85
23	4 x 12"	13.15	4.40

#### D. V. TRADE SKEINS FOR STEEL WHEEL TRUCK

	Skeins With Boxes, Set.	Boxes Only, Set.
3x9	\$7.35	\$2.45
3 1/4 x 10	9.00	3.00

#### PATENT TRUSS CAST SKEINS AND BOXES FOR STUDEBAKER WAGONS.

No.	Size.	with nuts, per set.	Our Special Price.
No. 3	Size, 2 1/2 x 8"	.....	\$7.60
No. 4	Size, 2 3/4 x 8"	.....	8.25
No. 5	Size, 3 x 9"	.....	9.35
No. 6	Size, 3 1/4 x 10"	.....	11.35
No. 7	Size, 3 1/2 x 11"	.....	13.35

#### CAST AND STEEL SKEINS FOR BROWN WAGONS.

	Each.
2 3/4" Cast Skeins, pat. extension for bolt or clip, no box..	\$2.40
3" Cast Skeins, pat. extension for bolt or clip, no box..	2.75
3 1/4" Cast Skeins, pat. extension for bolt or clip, no box..	3.00
3 1/2" Steel Skeins, long sleeve, no box.....	6.50
3 3/4" Steel Skeins, long sleeve, no box.....	7.65
4" Steel Skeins, long sleeve, no box.....	9.00

ALL PRICES IN CATALOG SUBJECT TO CHANGE WITHOUT NOTICE.

## STEWART HORSE CLIPPING MACHINES—STANDARD OF THE WORLD

**THE STEWART No. 1 BALL BEARING HORSE CLIPPING MACHINE.**  
Standard of the World.

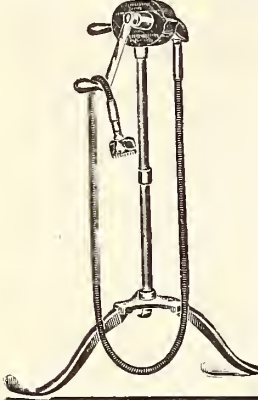

A rigid and very durable machine. Shipped, knocked down in compact box, weighing, complete, 36 lbs. Anyone can set it up. Gears enclosed in dust-proof metal box are cut from special steel and hardened. Has six-foot easy-running flexible shaft and famous Stewart clipping head. Price, complete, \$14.00.

**THE STEWART No. 2 CHICAGO HORSE CLIPPING MACHINE.**

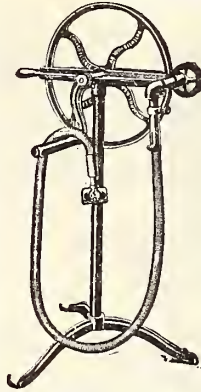

**For Large Stables.**  
A strong and powerful machine for large stables and custom clipping. Extra rigid construction throughout. Wearing parts all hardened tool steel. Has 6½-foot flexible shaft and Stewart clipping head. The most powerful and durable clipping machine ever made. Shipped, knocked down in strong box. Weight, 70 lbs. Price, complete, \$20

**THE STEWART No. 3 SHEEP SHEARING MACHINE.**

A high-grade, durable Shearing Machine. Made to wear and do good work. Gears all cut from solid tool steel and run in oil in dust-proof case. Turns easy and shears fast. Equipped with the well-known Stewart No. 5 Shear and four pairs of blades. Shipped knocked down in strong box. Weight, 36 lbs.

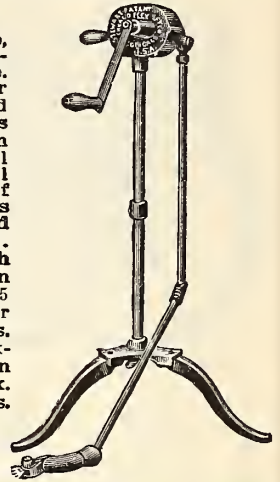

Price, \$17.50.

### Sheep-Shearing Attachment

For Use on Our No. 1 or No. 2 Horse-Clipping Machines.

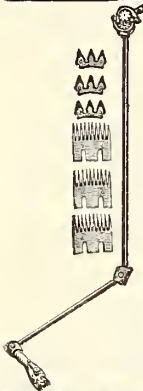

This attachment consists of complete No. 5 Stewart Shear Head, four sets of shearing knives, the solid core, universal jointed shaft and cogs, as shown here. Weight, boxed, 15 lbs.. Price of complete attachment, as described, \$14.00.

### Horse Clipping Attachment

Will fit any Stewart Sheep-Shearing Machine.

Consists of eye spindle and six feet of high quality flexible shaft. Also the famous Stewart clipping head. Can be attached in a few seconds. Owners of a Stewart Sheep-Shearing Machine who have horses should have this attachment. Packed in box. Price, \$10.50.

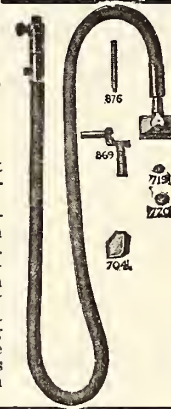

### The Stewart No. 9 Ball-Bearing Sheep Shearing Machine

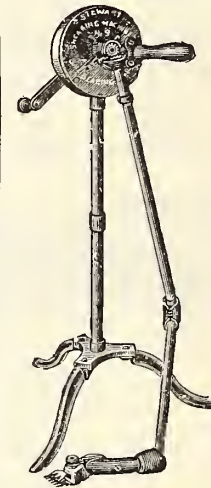

A very strong and durable machine, shipped, knocked down in compact case. Gears are all cut from solid tool steel, are hardened and are enclosed in dust-proof metal box. Has large balance wheel to assist in easy running. Every joint in the shaft and shearing head is fitted with ball-bearings, producing the most easy running and efficient shearing machine ever made. This is the machine to buy. Fitted with No. 7 ball-bearing shear, four combs and four cutters. Weight, 50 lbs.

Price, \$24.00.

### Stewart Automatic Grinder

For Horse-Clipping and Sheep-Shearing Knives.

Grinds the knives in a few seconds to cut equal to new. Knives are placed in holder, so no skill is required; weight, 36 lbs.

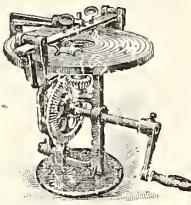

Price:

Fitted for Horse Knives, \$16.00;  
Fitted for Sheep Knives, \$16.00;  
Fitted for both, \$16.50.

Stewart Improved Grinder Attachment

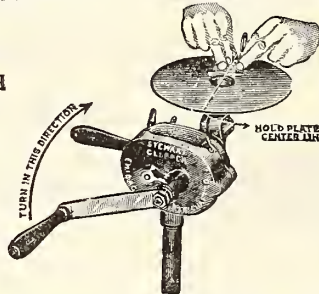

Attaches to a No. 1 Stewart Horse-Clipping Machine or Stewart No. 8 or No. 9 Sheep-Shearing Machine. Puts a perfect edge on horse-clipping or sheep-shearing knives. Every user of a horse-clipping or sheep-shearing machine should have one. Price, \$6.75.

### Part of Handle and Knife Used on All Stewart

Horse Clipping Machines Before Jan. 1st, 1915

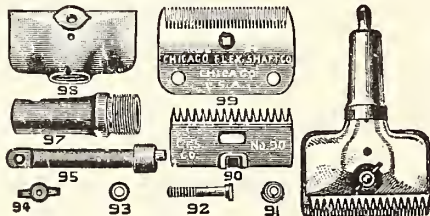

No.	Net Weight and List.
C-1	Stewart horse clipper handle and knife, complete 20 oz. \$4.50
C-2	Pair Stewart horse clipper blades, top and bottom 8 oz. 3.50
C-3	Horse clipper handle, complete, without knives. 10 oz. 1.00
90	Top plate 3 oz. 1.50
91	Tension spring of handle 1-16 oz. .15
92	Tension bolt of handle 1-6 oz. .10
93	Eccentric roll of handle 1-15 oz. .15
94	Tension nut of handle 1-6 oz. .10
95	Pin and shaft of handle 2½ oz. .35
97	Shank of handle 3¾ oz. .50
98	Front part of handle 4 oz. .60
99	Bottom plate of handle 5 oz. 2.00

### PARTS FOR STEWART LATEST MODEL CUTTING HEAD

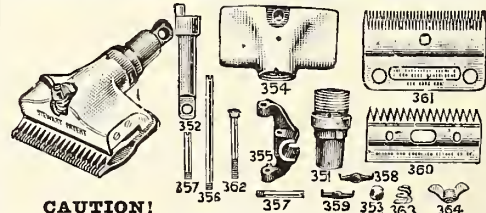

**FOR HORSE-CLIPPING MACHINES.**  
Patented.

As supplied on all Stewart horse-clipping machines since January 1, 1915.

**CAUTION!**  
Do not file or grind any part of the clipping head in any way. It is exactly right to cut best. The only grinding to be done is to resharpen the cutting plates when they get dull, and that must be done right.

Be sure to let parts Nos. 358 and 359 alone. If they should be removed in any way, do not attempt to use the clipper head until they are properly replaced. Remove before grinding and replace after.

No.	Part.	Price, each	Weight	No.	Part.	Price, each	Weight
351	Taper sleeve	\$.50	2 oz.	358	Ball boss	\$.05	1-7 oz.
352	Drive pin	\$.35	2 oz.	359	Socket boss	\$.10	1-7 oz.
353	Drive ball	\$.15	1-16 oz.	360	Top plate	1.50	2 oz.
354	Brace	\$.75	5 oz.	361	Bottom plate	2.00	3 oz.
355	Cross head	\$.50	1 oz.	362	Tension bolt	\$.10	1-5 oz.
356	Cross head pin	1.5	1-3 oz.	363	Tension spring	15	1-16 oz.
357	Guide pins	\$.10	1-7 oz.	364	Tension nut	\$.10	1-7 oz.

## Baltimore Garden Barrows

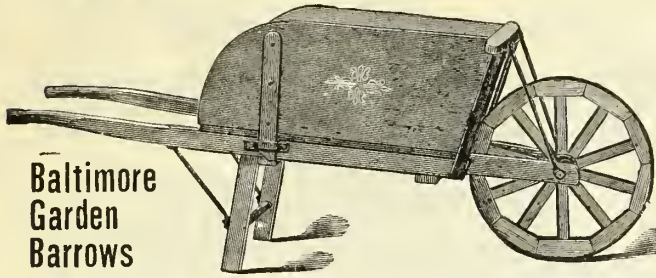

Made of seasoned wood, double frames, firmly bolted, iron braced and so constructed that by removing one bolt (the axle) and two nuts they can be folded flat down and shipped at lowest rate of freight.

### No. 4, MEDIUM SIZE OR MAN'S BARROW.

Inside measurement of box—Width at wheel, 19½ inches; depth, 11 inches; width at handles, 23¾ inches. Length of handles, 48 inches; wheel, diameter, 18 inches; tire, 1¾x3-16-inch; spokes, 1x1 inch; 8 spokes. Sides painted green, balance of barrow red, sides striped. Weight, 50 lbs.

Steel Wheel, List Price, \$12.00. Our Special Price, \$7.50.

### No. 5, LARGE SIZE OR MAN'S BARROW.

Inside measurement of box—Width at wheel, 21 inches; depth, 12 inches; width at handles, 23¾ inches. Length at handles, 51 inches. Wheel diameter, 18 inches; tire, 1¾x3-16 inches; spokes, 1x1¼ inches. Weight, 60 lbs. Finished as above.

Steel Wheel, List Price, \$13.00. Our Special Price, \$8.00.

## No. 1 SPECIAL GARDEN BARROW

Size—30 inches long, 24 inches wide in front, 25 inches in back. Sideboards—12 inches high, 30 inches long. Handles—5½ feet long, 2¾x1¾ inches. Wheel—21 inches diameter, 6 spokes. Hub—3-inch diameter in center. 2-inch diameter at ends.

No. 1 Barrow, with 1½-inch tread. Weight, 60 lbs. Six crated in one package, 56½ cubic feet.

Steel Wheel, List Price, \$14.40. Our Special Price, \$9.00.

## THE BALTIMORE CANAL BARROW

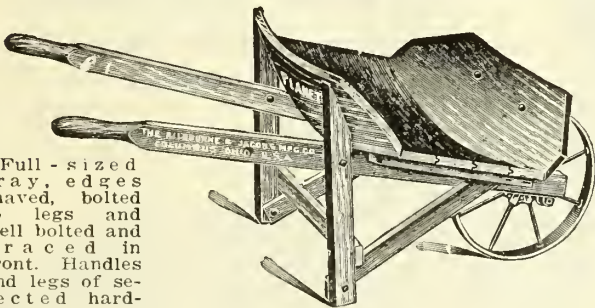

Full-sized tray, edges shaved, bolted to legs and well bolted and braced in front. Handles and legs of selected hardwood, wheels painted. Furnished in steel wheel.

Steel Wheel, List Price, \$8.00. Our Special Price, \$5.00. Weight, with steel wheel, 48 lbs.

### THE PLAIN BOLTED CANAL BARROWS.

Ordinary size; bent tray; legs bolted to handles and well braced. Furnished with steel wheel. Weight, with steel wheel, 45 lbs.

Steel Wheel, List Price, \$6.40. Our Special Price, \$4.00.

## WHARF OR OYSTER BARROW

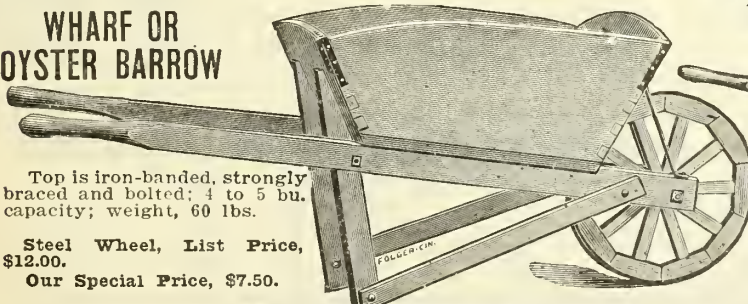

Top is iron-banded, strongly braced and bolted; 4 to 5 bu. capacity; weight, 60 lbs.

Steel Wheel, List Price, \$12.00.

Our Special Price, \$7.50.

## SOLID PRESSED STEEL TRAY BARROW

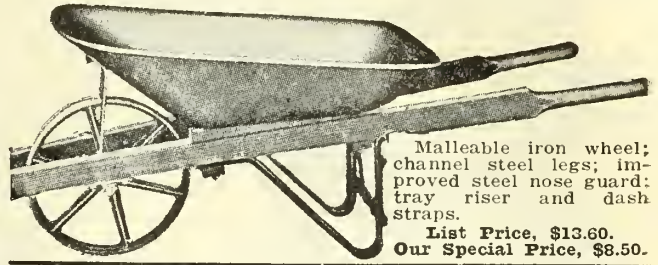

Malleable iron wheel; channel steel legs; improved steel nose guard; tray riser and dash straps.

List Price, \$13.60. Our Special Price, \$8.50.

## RIVETED STEEL TRAY BARROW

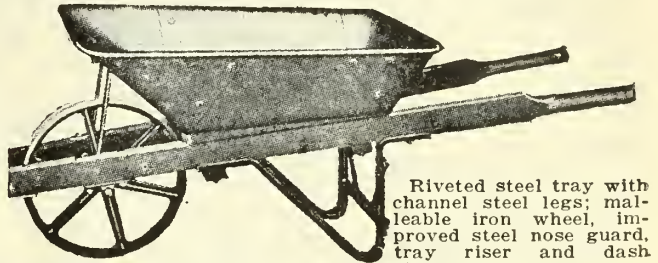

Riveted steel tray with channel steel legs; malleable iron wheel, improved steel nose guard, tray riser and dash straps.

Capacity, 4 cubic feet; weight about 65 pounds.

List Price, \$14.40. Our Special Price, \$9.00

## ALL STEEL BARROW



No. AX All-Steel Tubular Frame Barrow.

List Price... \$10.60

Our Special Price, \$7.25.

## TUBULAR FRAME SOLID PRESSED STEEL TRAY BARROW

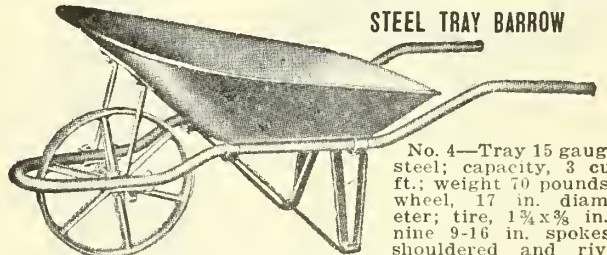

No. 4—Tray 15 gauge steel; capacity, 3 cu. ft.; weight 70 pounds; wheel, 17 in. diameter; tire, 1¾x¾ in.; nine 9-16 in. spokes, shouldered and riveted;

axle, ¾ in. For moving earth, ashes and light work.

List Price, \$14.00. Our Special Price, \$8.75

No. 5—Tray, 14 gauge, steel; capacity, 5 cubic feet; weight, 85 lbs.; mounted on same frame and wheel as No. 4. For general purposes and light running. It will stand hard usage.

List Price, \$16.80. Our Special Price, \$10.50

## ATTA BOY STEEL TRAY BARROW

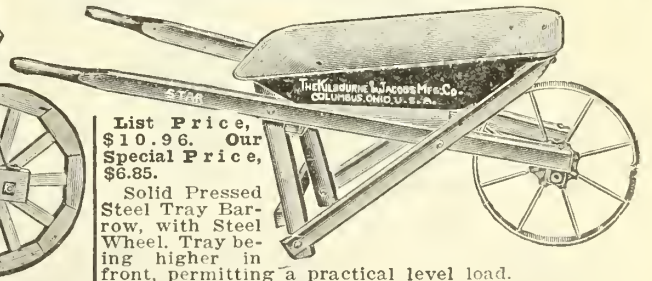

List Price, \$10.96. Our Special Price, \$6.85.

Solid PRESSED Steel Tray Barrow, with Steel Wheel. Tray being higher in front, permitting a practical level load.

## Solid Pressed Steel Tray Coal and Coke Barrow No. 10

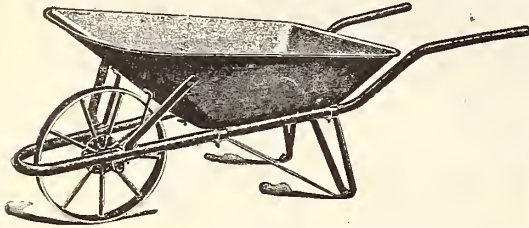

One-piece tubular steel frame extending around in front of wheel. Frame strongly braced and well ironed. Tray of best quality steel, with wired edge. Size No. 10—Gauge of steel in tray, 13; length of top of tray, 41½ in.; width of top of tray, 33 in.; depth at wheel, 12 in.; depth at handle, 6 in.; capacity, 6 cubic feet; weight, 110 lbs. **List Price, \$20.00. Retail, \$12.50.**

Steel Wheels. **List Price, \$4.00; Retail, \$2.50.**  
Extra Trays. **List Price, \$11.50; Retail, \$7.00.**

## Straight Handle Stone Barrow

Strong, well made, iron strapped over bottom, and well bolted together. Handles 6 feet long; legs, 12 inches long; bottom, 1¼ inches thick by 23 inches wide by 27 inches long; dash, 10 inches high; weight, 64 pounds. **List Price, \$13.60; Retail, \$8.25.**

## Straight Handle Brick Barrow

**List Price, \$17.20. Retail, \$10.75.**

## Plain Platform Truck

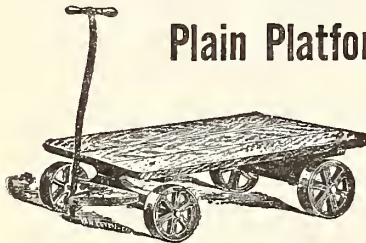

We are prepared to quote special prices on Trucks of every description. If you want anything special, write us for prices.

No.	Size of Platform.	Wgt. Lbs.	Diam. Wks. Ins.	List.	Retail.
82	2 ft. 4 in. by 3 ft. 4 in.	100	7½	\$33.60	\$21.00
83	2 ft. 6 in. by 3 ft. 6 in.	115	7½	36.00	22.50
84	3 ft. by 4 ft.	125	8½	40.80	25.50

Can furnish Special Trucks at lowest prices; also Truck Wheels. Write for prices.

## Improved Four-Wheel Platform Truck

For Can-  
ning House,  
Railroad  
Stations and  
Warehouse.  
Cheap,  
strong and  
well made.

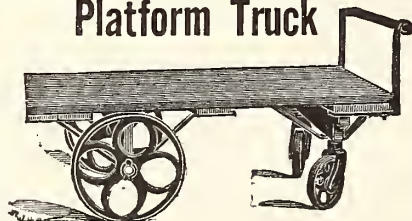

No.	Size Platform	Diam. Wks.	Diam. Caster	Weight	List	Retail
No. 1	2x4 ft.	12 in.	6 in.	152 lbs.	\$53.36	\$33.35
No. 21	3x5 ft.	18 in.	9 in.	255 lbs.	75.20	47.00

## Concrete and Mortar Barrow

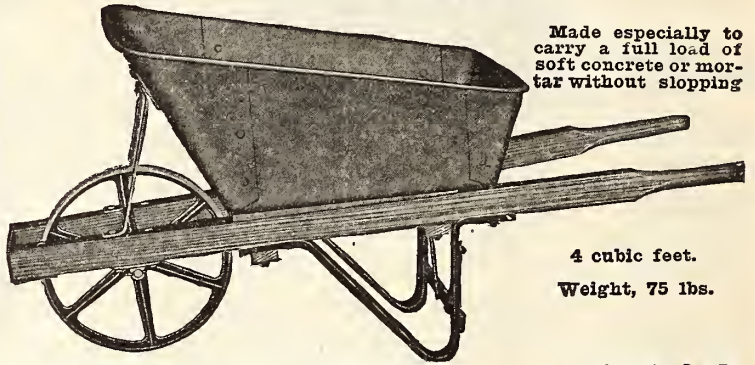

Made especially to carry a full load of soft concrete or mortar without slopping

4 cubic feet.  
Weight, 75 lbs.

No. 115—Deep, Narrow Tray, straight front ..... **\$15.60 \$ 9.75**  
No. 444—Deep, Narrow Tray, rounded front and corners.. **16.00 10.00**

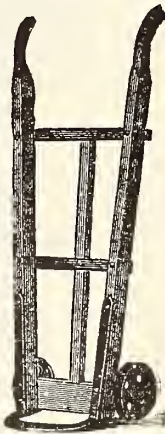

### EXTRAS FOR BARROWS.

	List Price.	Our Spec'l Price.
Wood Wheels for Nos. 4 and 5 Garden Barrows .....	\$4.00	\$2.50
Steel Wheels for Nos. 4 and 5 Garden Barrows .....	3.50	2.25
Wood Wheels for No. 1 Garden Barrow..	4.50	3.00
Steel Wheels for No. 1 Garden Barrow..	4.00	2.75
Steel Wheels for Nos. A4 and B5 Barrows	3.50	2.25
Steel Wheels' for Solid Pressed Steel Tray Barrow.....	3.50	2.25
Steel Wheels for No. 10 Barrow.....	4.00	2.50
Wood Wheels for Canal Barrow.....	3.00	2.00
Steel Wheels for Canal Barrow.....	3.60	2.00
Tray—No. 4 (All Steel Barrow).....	8.00	5.00
Tray—No. 5 (All Steel Barrow).....	9.00	5.75

## STORE TRUCKS

### Baltimore Store Trucks

BALTIMORE STORE TRUCK. **LIST PRICE, \$6.40. RETAIL, \$4.00.**

## NEW YORK PATTERN

HALF STRAPPED.		FULL STRAPPED.	
No.	List Price.	No.	List Price.
No. 1....	\$14.00	No. 1....	\$14.56
No. 2....	14.40	No. 2....	15.36
No. 3....	16.40	No. 3....	18.48
No. 4....	18.80	No. 4....	21.60

### BARREL AND WESTERN PATTERN TRUCKS. PRICE ON APPLICATION.

#### NEW YORK PATTERN.—SIZES.

No.	Length Handles	Width Nose	Width at Upper Bar	Diam. Wks.	Weight
No. 1	4'0"	12½"	18"	8"	42 lbs.
No. 2	4'5"	14"	19½"	9½"	44 lbs.
No. 3	4'8"	15"	21"	9½"	72 lbs.
No. 4	5'0"	16"	22½"	11"	85 lbs.
No. 5	5'3"	17"	24"	11"	90 lbs.



## Dimensions and Prices Cast-Iron Truck Wheels

No.	Lbs. Wt.	Hgt. In.	Face. In.	Hub. In.	Bore. In.
No. 0 .....	4½	6½	1½	2¼	¾ x ¾
Nos. 1 and 2.....	7½	8	2	2½	¾ x ¾
Nos. 4 and 5.....	17½	11	3	3¼	1x1½
No. 3 .....	12¾	9½	2½	3¼	¾ x 1
Heavy .....	25	12	3	3¼	1x1½

## COASTER WAGONS

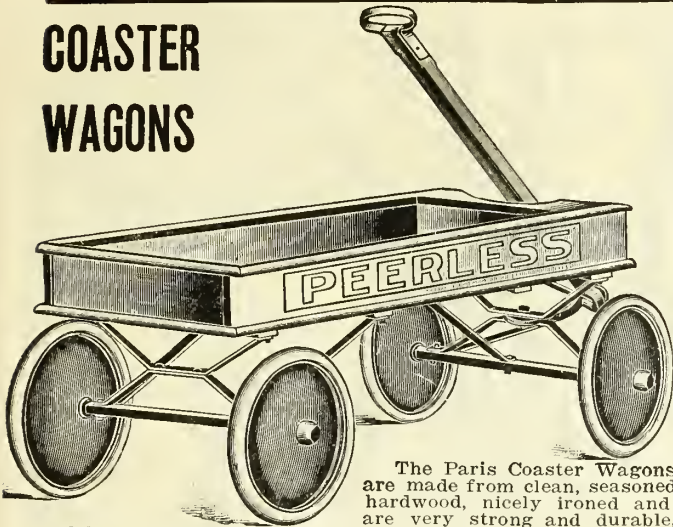

The Paris Coaster Wagons are made from clean, seasoned hardwood, nicely ironed and are very strong and durable, and have become the favorite of all boys. The bodies and underworks are made of birch or maple, and bottoms of clear basswood which is light and strong.

- |  |         |
|--|---------|
| No. 400—All Steel Gear, Wood Body, 36" x 15" Rubber Tired Disc Wheels, Roller Bearing..... | 6.00    |
| No. 419—16x38 Removable Body, 10 in. Rubber Tired Wheels, Ball Bearing.....                | \$11.00 |
| No. 420—18x40 Removable Body, 12 in. Rubber Tired Wheels, Ball Bearing.....                | 12.25   |
| No. 404A—14x34 Body, 8 in. Rubber Tired Wheels, Ball Bearing.....                          | 8.75    |
| No. 19—16x38 Removable Body, 11 in. Spoke Wheels, Roller Bearing.....                      | 9.05    |
| No. 20—18x40 Removable Body, 12 in. Spoke Wheels, Roller Bearing.....                      | 10.25   |

All sizes are fitted with smooth, cold-rolled steel axles rigidly fastened to gear. The wheels are the latest type of Disc or Artillery style, nicely enameled and are fitted with nickel plated hub caps.

They have heavy, strong King Bolts and strong, well-braced draw irons, making them a real wagon.

## THE VACUUM TANK WATERER

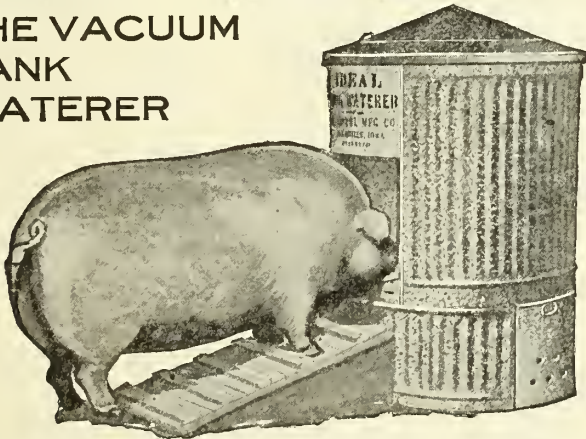

Nos. 3, 4, 5 and 6. The simplest and most efficient Hog Waterer that can be built. Made of corrugated, galvanized steel, giving it strength to stand the hard knocks which hogs will give it.

Tank is reinforced with heavy strap iron braces. A full bottom in the casing makes a lamp chamber that cannot be disturbed by the rooting of the hogs, and also permits a center support of the inner tank.

- |                       |         |  |         |
|-----------------------|---------|--|---------|
| No. 3—15-Gallon.....  | \$20.00 | No. 52—Fitted with two Drinking Troughs. . . | \$35.00 |
| No. 4—30-Gallon.....  | 24.00   | No. 62—Fitted with two Drinking Troughs. . . | 42.50   |
| No. 5—60-Gallon.....  | 30.00   |  |         |
| No. 6—100-Gallon..... | 40.00   |  |         |

Ideal Waterer for Poultry, 5 gallons.....\$6.50

## IDEAL HOG FEEDERS

- |  |         |
|--|---------|
| No. 12—8 to 10 bushels.....            | \$27.50 |
| No. 14—18 bushels.....                 | 37.50   |
| Extension Tops, 12 bushels.....        | 6.50    |
| Hopper for Tankage, 2 1/2 bushels..... | 4.50    |

## GRITCO WAGONS

Entire wagon made of selected hardwood. Construction closely follows that of regular farm wagon, having bent hounds and adjustable reach. All parts heavily braced and ironed.



	List.	Price.
Acme Jr. Wagon, with pole.....	\$20.00	\$12.50
Gritco No. 356, with hand pole.....	19.20	12.00
Shafts.....	2.50	1.50
Wheels.....	2.30	1.35

## THE GRITCO HOG OILER

**SIMPLE IN CONSTRUCTION.**

You may see by the picture that the Gritco Hog Oiling Machine is very simple and that there is no possible chance for waste of oil nor is there any chance for dirt to interfere with the working principles of this machine. You will notice there are three rubbing bars, making it possible for two or three hogs to rub on the Oiler at the same time.

As soon as the hog starts to rub on the bar this will open the feed allowing the oil to run down the bar placing oil on the infected part. The bars are held firmly in place by guides and the opening which gauges the feed is governed by a spring, which prevents all possible chance for waste of oil.

There is nothing to break or get out of order. This machine will last a life time.

**DON'T TAKE CHANCES.**

For years the successful hog raisers have been looking for an Oiler that would work perfectly. There have been a large number of Hog Oilers placed on the market, each and every one has its merits, while at the same time there are with a great many of them a host of disadvantages which the manufacturers cannot avoid.

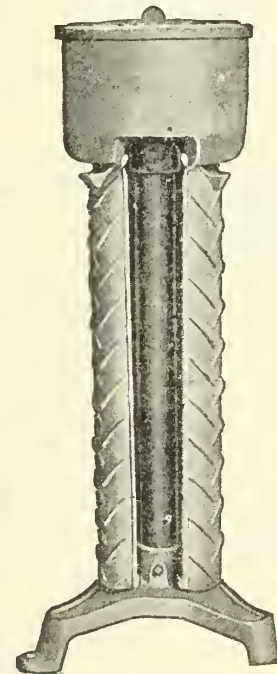

Made of Cast Iron—  
Weighs 45 Pounds.

In considering the advisability purchasing the **GRITCO HOG OILER** we want you to feel perfectly satisfied before placing your order that you are giving your patronage with the right concern, and that you may confidently expect in return the best of service and that you are buying an article that is thoroughly reliable, desire any further information we respectfully solicit your inquiry for such and your request shall have our immediate attention. **PRICE OF HOG OILER COMPLETE... \$10.00**

**SPECIAL OIL FOR HOG OILERS.**

- |                                      |            |                     |        |
|--------------------------------------|------------|---------------------|--------|
| 5-Gallon Cans.....                   | \$4.50     | 10-Gallon Cans..... | \$8.00 |
| Barrels, 50 gallons, per gallon..... | .50 cents. |                     |        |

**ALL PRICES IN CATALOG SUBJECT TO CHANGE  
WITHOUT NOTICE**

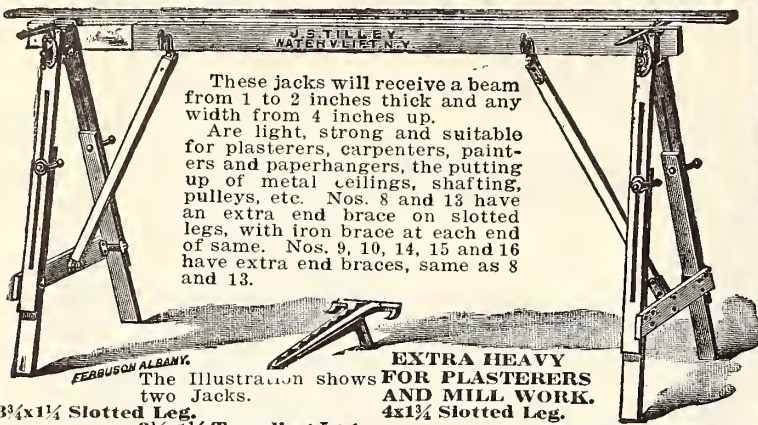

These jacks will receive a beam from 1 to 2 inches thick and any width from 4 inches up. Are light, strong and suitable for plasterers, carpenters, painters and paperhangers, the putting up of metal ceilings, shafting, pulleys, etc. Nos. 8 and 13 have an extra end brace on slotted legs, with iron brace at each end of same. Nos. 9, 10, 14, 15 and 16 have extra end braces, same as 8 and 13.

The illustration shows two Jacks.

<b>3 3/4 x 1 1/4 Slotted Leg.</b>	<b>3 3/4 x 1 1/4 Travelling Leg.</b>	<b>EXTRA HEAVY FOR PLASTERERS AND MILL WORK.</b>	<b>4 x 1 3/4 Slotted Leg.</b>	<b>3 3/4 x 1 1/4 Travelling Leg.</b>
Per Jack		Per Jack		
No. 6—4 ft. extends 6 ft. ....	\$6.60	No. 13—6 ft. extends 9 ft. ...	\$9.40	
No. 7—5 ft. extends 8 ft. ....	7.60	No. 14—7 ft. extends 11 ft. ...	10.20	
No. 8—6 ft. extends 9 ft. ....	8.20	No. 15—8 ft. extends 12 1/2 ft. ...	11.20	
No. 9—7 ft. extends 11 ft. ....	9.40	No. 16—10 ft. extends 15 ft. ...	16.00	
Brackets, per set of four, net....	2.00	No. 17—12 ft. extends 20 ft. ...	20.00	

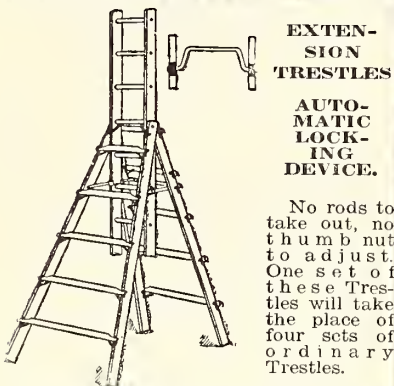

**EXTENSION TRESTLES**  
**AUTOMATIC LOCKING DEVICE.**

No rods to take out, no thumb nut to adjust. One set of these Trestles will take the place of four sets of ordinary Trestles.

6 ft. extends to about 9 ft. ....	\$12.00
8 ft. extends to about 13 ft. ....	14.00
10 ft. extends to about 17 ft. ....	18.00
12 ft. extends to about 21 ft. ....	22.00
14 ft. extends to about 25 ft. ....	26.00



**TILLEY ELECTRICIANS' STEP LADDER.**

Constructed as shown in cut above. Strictly first class in every respect. A combination Step Ladder and Trestle. Just the ladder for Electricians, Painters, Plumbers and mill work. A combination knee, tie and regular brace (as shown in detached cut) under each end of each step, which passes down through the step out through the sides.

6-Step... \$ 5.40	14-Step... \$14.00
8-Step... 7.20	16-Step... 16.00
10-Step... 9.00	18-Step... 21.60
12-Step... 10.80	20-Step... 24.00

**TILLEY UMPIRE STEP LADDER.**  
A light, strong, well-made ladder braced under each step with strips which support the steps, tie the sides together and stiffen the entire ladder. Best ladder made for the money. Sizes 4, 5, 6, 7, 8 and 10, 60c. per step.

**WINDOW BRACKET PAINTERS CRIPPLE**

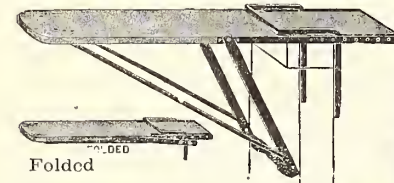

Regular Size, 4 ft. 4-in. board, \$10.00  
Extra Size, 6-foot board, \$12.00 each.

**Decorators' Ladders**

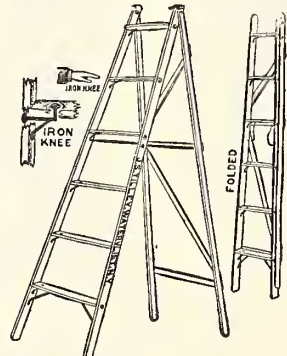

4-Step... \$2.40	8-Step... \$4.80
6-Step... 3.60	10-Step... 6.00



These ladders are stiff, strong and well built. Have improved patent spring locks attached to traveling sections, and are automatic in action. These locks are fastened securely to the inner sides of upper section, and made of the best malleable iron. They are also provided with a durable spring, which keeps the hook thrown forward and grasps each round of the stationary ladder as the traveling ladder passes upward. A tripper forces the hook back, allowing it to pass the rounds when descending.

OUR IMPROVED TILLEY EXTENSION LADDERS.

**PRICES.**

24 ft., 2-12 ft. sec., extends 21 ft. ....	\$14.40
26 ft., 2-13 ft. sec., extends 23 ft. ....	15.60
28 ft., 2-14 ft. sec., extends 25 ft. ....	16.80
30 ft., 2-15 ft. sec., extends 27 ft. ....	18.00
32 ft., 2-16 ft. sec., extends 29 ft. ....	19.20
36 ft., 2-18 ft. sec., extends 33 ft. ....	21.60
40 ft., 2-20 ft. sec., extends 36 ft. ....	28.00
44 ft. ....	30.80
48 ft. ....	38.40

**Other Lengths Given on Application.**  
Windlass Ladders can be furnished if desired.  
Prices on Application.  
Tilley Liberty Extension Spread Bottom Ladder or with Parallel Sides.

**PRICES.**

24 ft. extends 21 ft. ....	\$12.00
26 ft. extends 23 ft. ....	13.00
28 ft. extends 25 ft. ....	14.00
32 ft. extends 29 ft. ....	16.00
36 ft. extends 33 ft. ....	18.00
40 ft. extends 36 ft. ....	24.00
44 ft. extends 40 ft. ....	26.40

**Tilley Trojan Step Ladder**

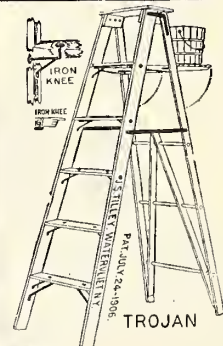

Light, strong and stiff. Iron knees under ends of each step. These knees pass entirely through the steps and side bars, holding ladders firmly together and insuring a strong brace to the steps. Pail rests on all sizes of 5 feet and over. Furnished in 6, 7, 8, 10 and 12-foot lengths.

**Price, 70c. per foot.**

**Bumper and Hooks**

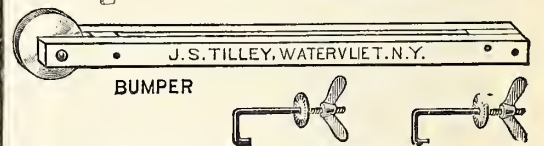

The cut above shows one Bumper and two Hooks. It requires two Bumpers and four complete Hooks. Nuts and Washers for each set to be used on swing stage ladders. Bumpers, pair, with 4 Hooks. .... \$5.00

**Swing Stage Ladders**



are made from selected stock and rodded with iron rods with or without flooring.  
**Swinging Stage Ladders**  
18-20-22-24-ft. without Floor ..... \$0.70 per foot  
With Floor ..... 1.20 per foot

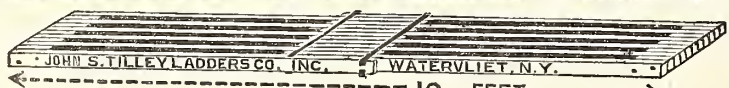

**EXTENDED 10 FEET**  
JOINTS NEAR THE BEARING POINTS MAKING A STIFF PLANK.  
6 feet extends to 10 ft. .... \$6.00  
8 feet extends to 14 feet. .... \$9.00

## Gritco Combination Extension Ladder and Trestle

This is a first-class ladder, with rope and pulley attachment above 18 feet. Has automatic Hooks, and can be used as an Extension Ladder, or can be converted into a Trestle, which also serves as a Stepladder. Can be taken apart. Always made in equal sections; 12 to 28 feet. **Price, per foot, 45c.**

Above 24-ft. we prefer the Rope and Pulley Extension.

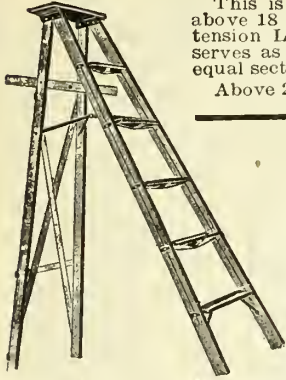

## Gritco "Security" Step Ladder

WITH ALL-STEEL LOCK.

Made from strictly clear seasoned wood. Extra wide steps and top. Has very strong, full-looped, galvanized steel hinge or ear, with right angle flange to which top is riveted. **Every step is rodded and trussed**, so that it is constantly being drawn together when there is weight upon the steps; cannot get rickety. Braces are all-steel bound; secure in every point.

4 to 10 ft., per ft., 65c. 12 to 14 ft., extra heavy, per ft., 71c.

## Gritco PULLEY EXTENSION LADDER

There is not a finer ladder on the market.

White spruce sides; 1 1/4-inch straight, air-dried First-Class Hickory rounds.

Spread at base; 6 to 10 inches more than regular width of ladder.

Has Automatic Hooks and is operated by the rope. It can be easily and quickly taken apart and put together.

20 to 30 ft., per ft., 42c.

32 to 40 ft., per ft., 46c.

42 and 44 ft., 50c.

Allow 2 feet for lap on ladders 32 feet and under, and 3 feet on ladders over 32 feet.

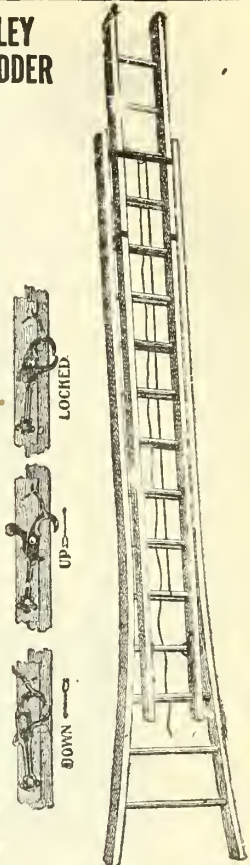

## TILLEY LADDER HOOK

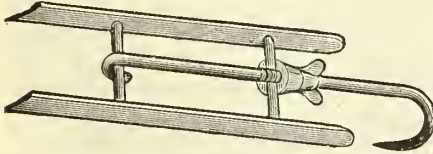

This old reliable and well-known ladder hook needs very little explanation. The cut explains all its merits and utility for a roof ladder. It can be quickly attached or detached.

Price \$1.50

## Gritco "Winner" Step Ladder

An excellent ladder at a low cost. This ladder will last a long time. It is strong, stiff and durable. Has solid board shelf. Sizes: 4, 5, 6, 7, 8, 10 steps, 60c. per step. 12 steps 65c. per step.

### TILLEY IMPROVED SECTIONAL LADDERS.

Sections 6 feet 5 inches long. Either plate and pin lock or lock nut fastening.

Per Section, \$3.50.

## TRIANGLE

24 1/2-in. and 30 1/2-in. wide, inside measurement.

\$8.00 per pair.

## TRIANGLE FOR GUARD RAIL

20 1/2-in., 24 1/2-in. and 30 1/2-in. wide, measurement.

\$12.00 per pair.

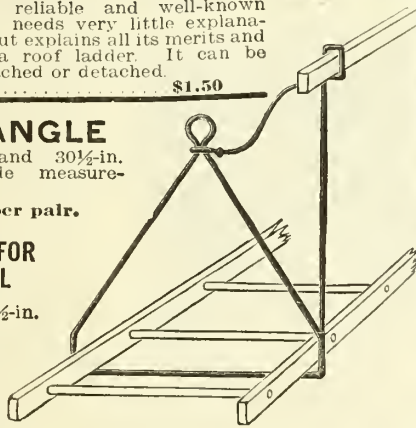

## "A" SHAPED TRESTLES



STRONG AND LIGHT.

Made in All Sizes, From 6 Feet to 12 Feet.

Pair.

6-ft. . . \$12.00  
8-ft. . . 16.00  
10-ft. . . 20.00  
12-ft. . . 24.00

## Window Cleaners' and Fruit Pickers' Ladders

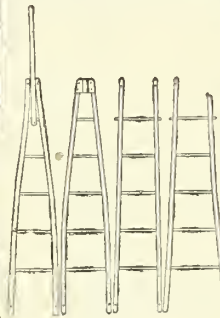

Nos. 1, 2, 3, 4

No. 1—Bottom or floor section . . . \$2.50

No. 2—Regular or middle section . . . \$2.50

No. 3—Top window cleaners' section . . \$3.00

No. 4—Top fruit pickers' section . . \$3.00

## SINGLE LADDERS

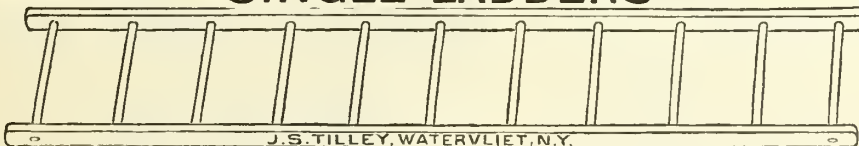

J.S. TILLEY, WATERVLIET, N.Y.

Made of spruce, with hand-shaved oak rounds; first class in every particular. **Price, 12, 14, 16, 18 feet, 36c. per foot.** Ladders over 18 ft., 4c. per foot extra. Also have a cheaper ladder, 4c. per foot less than above prices. Masons' or Bricklayers' Heavy Parallel Sides Straight Ladders, 16 to 18 feet, 50c. per ft.; 20 to 26 feet, 60c. per ft.

FULL RODDED STEPLADDER FOR HOUSEHOLD USE PER FT. .40c.

## ROOF AND GUTTER HOOKS

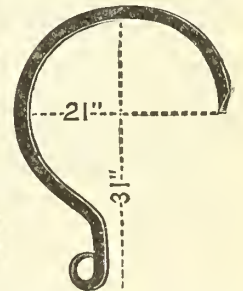

For Hanging Swing-ing Stages or can be used for many other purposes, strong and durable.

Price, per pair. \$8.00

Pronounced "RU" as in RUBY  
**RU-BER-OID**  
**ROOFING**  
 COSTS MORE - WEARS LONGER

FOR OVER 23 YEARS THE STANDARD.

**RU-BER-OID** is the original ready-to-lay roofing, and was for several years the only roofing of this character. Different from and superior to all other prepared roofing, in that **RU-BER-OID** compound or gum, an exclusive combination of high-grade, water-proof, acid- and fire-resisting ingredients is used in its manufacture. This gum is used in no other roofing. That the first roofs of **RU-BER-OID** applied in 1892 are still giving satisfactory service is indisputable evidence of unequalled durability. **RU-BER-OID** contains no rubber. It contains no tar. It contains no paper. It contains no asbestos. It is not an asphalt roofing. **RU-BER-OID** is tasteless. It is odorless. It can be used on roofs from which drinking water is conserved. **RU-BER-OID** is fire-resisting. Hot coals thrown on a roof covered with it do not set fire to the fabric, nor to the boarding underneath. **RU-BER-OID** is a non-conductor of heat. It keeps the heat in in winter, and the heat out in summer. **RU-BER-OID** will outlast tin, iron or shingles. It has outlasted its upwards of 300 imitations, variously known as "rubber" roofings, "asphalt" roofings, "asbestos" roofings, etc. Put up in rolls 36 inches wide, containing 108 square feet.

Medium (1-ply), 108 sq. ft.; weight 45 lbs. Price.....\$3.25  
 Heavy (2-ply), 108 sq. ft.; weight 55 lbs. Price..... 3.75  
 Extra heavy (3-ply), 108 sq. ft.; weight 65 lbs. Price.. 4.50

**RU-BER-OID STRIP SHINGLES**

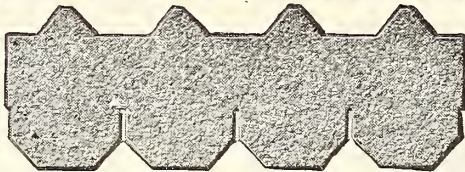

Enduring quality, economy, low application cost, attractive appearance—these are the chief attributes of the Ruberoid Strip-shingle. You have in this shingle all that you can ask.

Ruberoid quality, the quality that has been tested on thousands of roofs during the past thirty years, is reflected in this shingle. Otherwise it would not bear the name Ruberoid.

In appearance Ruberoid Strip-shingles leave nothing to be desired. Unusual thickness, coupled with a pleasing surface of red or green crushed slate, imparts massiveness and character to the roof on which this shingle is laid.

PRICE, PER SQUARE.....\$7.00

**Certain-tee'd Asphalt Roof Coating**

1 Gallon Cans.....\$0.90  
 5 Gallon Cans..... 3.00  
 50 Gallon Barrels.....27.50

**Certain-tee'd Asbestos Roof Coating**

1 Gallon Cans.....\$1.00  
 5 Gallon Cans..... 3.50  
 50 Gallon Barrels.....30.00

**Certain-tee'd Plastic Cement**

Leaks in new or old roofs of wood, metal, slate, tile or prepared roofing may be repaired quickly, easily and permanently with **Certain-tee'd Plastic Cement**. It is excellent also for flashing around chimneys, metal cornices and skylights; for relining old gutters and metal valleys; and for use at all other points where there are leaks, holes, breaks, or cracks caused by contraction or expansion, or where the material has worn out or broken away.

1 lb. Packages.....\$ .20  
 10 lb. Packages..... 1.25  
 25 lb. Packages..... 2.50  
 50 lb. Packages..... 4.75  
 275 lb. Packages.....13.75  
 450 lb. Packages.....20.00

**Safety First Winans Ladder Jack**



The **Winans Ladder Jack** is absolutely the strongest and best made; all other ladder Jacks are only as strong as the weakest rung of the ladder. Attaching these Jacks on the standard of the ladder instead of the rungs, gives it much greater strength. It can be raised or lowered to any desired height or angle, or reversed to either the outside or under side of the ladder in a minute's time without removing the plank or scaffolding from the Jack. They are self-locking and adjust themselves to any standard make of ladder. Being made of "Best Grade" 1 1/2 x

1 1/2 angle steel we guarantee them to support one thousand pounds; yet weigh but 4 1/2 pounds each, and can be folded into a small compass for convenient carrying.

PRICE PAIR, \$4.50.

**Seaman Safety Ladder Brackets**



Prevent the top of the ladder from sliding, rolling or being blown over by the wind. Insure safety; save labor (about 2 hours per day per man); make handy place for pots. A valuable aid to carpenters, painters, tinners, millwrights, employees of light, power and telephone companies and, in fact, to everyone who uses a ladder.

Quickly and easily adjusted; fit any ladder; work equally well on wood, brick or stone. Span, 42 inches; hold ladder out 14 inches. Made of best quality malleable iron. Packed one set in a carton (weight 8 lbs.) **Our Special Price, \$5.00 a set.**

**Galvanized Steel Corrugated Roofing**

1 1/4 and 2 1/2-inch corrugations, standard 29 gauge open hearth steel thoroughly galvanized. Made in sheets 26 inches wide; 6, 7, 8, 9 and 10 feet long. Can also furnish same in 26 gauge. 12 foot sheets **25c.** a square extra.

Galvanized Ridge Roll, both in corrugated and plain.  
 No. 29 Gauge, Per Square.....\$5.75  
 No. 27 Gauge, Per Square..... 6.25  
 Ridge Roll, Plain per Foot..... .10  
 Ridge Roll, Corrugated per Foot..... .12

**LEAD WASHERS**

Per Pound.....\$0.30

**GALVANIZED ROOFING NAILS**

With extra large heads, per pound.....\$0.12

**ROOFING CAPS**

Per Pound.....\$0.06



# Certain-teed Roofing

## CERTAIN-TEED ROOFING



When you want a smooth surfaced Roofing for your House, Barn, Garage, Factory, Warehouse, Sky-scraper, Church, Apartment Building, or Farm Building, get

### CERTAIN-TEED

—guaranteed 5, 10 or 15 years for No. 1, 2 or 3 respectively—backed by the responsibility of the World's greatest and biggest Roofing and Building Mills. The **Certain-teed** label on this Roofing stands for a definite guaranteed service—a protection for you. Why try to save a dollar or two by putting on a cheap Roof that is not guaranteed when you can buy **Certain-teed** for just a little more money and get much longer service on your Roof. In the long run it's less expensive to buy **Certain-teed**.

- No. 1, 108 square feet.....\$2.00
- No. 2, 108 square feet..... 2.50
- No. 3, 108 square feet..... 3.00

## Major Roll Roofing—Standard Quality

Major roofing is of a very high standard, equalling the highest grades in other makes. Uniform, strong and durable, giving the kind of service expected from high grade roofing.

Major roofing gives the protection exacted from a roofing of high merit.

- No. 1 Light, 108 Square Feet..... \$1.80
- No. 2 Medium, 108 Square Feet..... 2.25
- No. 3 Heavy, 108 Square Feet..... 2.75

## GUARD ROOFING

### GUARD (Special Quality)

This roofing is offered as a good average quality product. It will give good service on the roof. Where the highest quality roofing is not necessary this product is recommended.

- No. 1—Light, about 35 lbs., per square...\$1.60
- No. 2—Medium, about 45 lbs., per square.. 2.00
- No. 3—Heavy, about 55 lbs., per square... 2.25

### CORPORAL (Competition Quality)

Not a quality product.

Made to meet price competition. Should be sold only where price is the principal consideration.

- No. 1—Light, about 35 lbs., per square...\$1.15
- No. 2—Medium, about 45 lbs., per square... 1.50
- No. 3—Heavy, about 55 lbs., per square... 1.75

## ROOFING SLATE SURFACED

**CERTAIN-TEED (Extra Quality)**  
Blue-Black, Red or Green.

Weight, 90 lbs., guaranteed 10 years, per square.....\$2.75

**MAJOR (Standard Quality)**  
Blue-Black, Red or Green.

Weight, 80 lbs., guaranteed 8 years, per square.....\$2.25

## SHINGLES SLATE SURFACED

**CERTAIN-TEED (Extra Quality)**

Individual—Blue-Black, Red or Green.

Marked for spacing and nailing.  
Weight about 245 lbs. Size 8"x12½". Put up four packages per square.

Guaranteed 10 years, per square.....\$7.00

## Certain-teed 4-Width Shingle

Blue-Black, Red or Green.

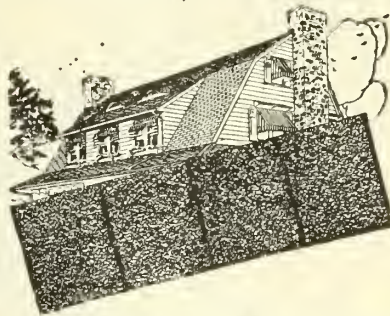

These shingles, when properly laid, offer weather protection in all climates. They are unaffected by atmospheric changes or by heavy rain or snow. Extreme heat or cold will not materially cause them to expand or contract. As an insulator they keep the house cooler in summer and warmer in winter.

Marked exactly 4 in. from the butt for spacing.

Weight about 196 lbs. Size 10"x32". Put up two packages per square.

Guaranteed 10 years, per square .....\$6.50

## CERTAIN-TEED STRIP SHINGLES

RED, BLUE,  
BLACK and  
GREEN



SURFACED  
SLATE

These shingles possess all the durability, attractiveness, weather protection and fire-resisting qualities of the modern asphalt shingle—plus 50 per cent. or more saving in the cost of application, because they can be laid so quickly.

Four shingles laid at a time—no spacing—no chalk line—one-half less nails—one-half less nail holes—four-fifths less cracks—no painting—no repairs.

**CERTAINTEED STRIP SHINGLES** are water-proofed, with pure refined asphalt. The wearing surface is natural chipped slate in handsome blue-black red and green colors. The colors are absolutely permanent.

Price, per square.....\$7.25

## TARRED FELT

No. 3—  
Rolls 500  
square feet.  
60 lbs.  
\$2.50



## Slater's Felt

500 sq. ft. rolls, 30 lbs.. \$1.50

## Insulating Paper

Heavy—500 square feet rolls, 30 lbs..\$2.50

## ROSIN SIZED SHEATHING PAPER

In Rolls of 500 Square Feet Each.

- 20-lb. Sheathing Paper, per roll of 500 square feet..... \$1.00
- 30-lb. Sheathing Paper, per roll of 500 square feet..... 1.50
- 40-lb. Sheathing Paper, per roll of 500 square feet..... 2.00

Special Prices in 10-roll lots; also by the ton.



# Certain-teed PAINT



### CERTAIN-TEED HOUSE PAINTS

For painting the exteriors and interiors of both old and new buildings, where the best of service is required. Certain-teed House Paints offer maximum protective and decorative value. They possess excellent working qualities, great hiding power, durability, uniformity and permanency of color. Covering capacity about 350 sq. ft. per gallon, two coats.

	Gals.	Qts.
403 Pearl Gray	\$3.50	\$0.98
407 French Gray	3.50	.98
409 Slate Color	3.50	.98
412 Light Blue	3.50	.98
418 Ivory	3.50	.98
419 Primrose Yellow	3.50	.98
426 Black	2.15	.63
435 Bungalow Brown	2.90	.80
437 Brown	2.50	.72
445 Olive Green	2.75	.79
443 Window Blind Green	3.15	.88
448 Outside White	3.70	1.03
449 Inside White	3.10	.87



### CERTAIN-TEED FLAT WALL PAINT

A washable sanitary, germ-proof paint for producing artistic effects on interior walls and ceilings of wood, wall board, plaster, metal, burlap or canvas. Covering capacity, one coat, about 700 to 800 sq. ft. per gallon on smooth plaster, and about 500 to 600 sq. ft. per gallon on rough plaster.

	Gals.	Qts.
471 Twilight Gray	\$2.25	\$0.67
472 Turquoise Blue	2.25	.67
474 Golden Buff	2.30	.68
476 Royal Tan	2.15	.63
477 Harvest Brown	2.20	.64
483 Leaf Green	2.40	.69
486 Ivory	2.20	.64
487 Silver Gray	2.25	.67
490 White	2.20	.64

### MOTOR CAR ENAMELS

High grade product for refinishing automobiles. Made in all the most popular shades. Easily applied and gives a beautiful, hard, lustrous finish. Under ordinary conditions will dry over night. One quart sufficient for average car.

	½ Gal.	Qts.	Pts.
963 Dark Red	\$2.30	\$1.19	\$0.66
964 Blue	2.45	1.27	.69
965 Gray	1.85	.98	.54
968 Dark Green	2.15	1.12	.60
970 Black	1.70	.88	.49
972 Flat Black Primer	1.15	.62	.35
973 Black Fender Enamel	1.90	.88	.49

### CERTAIN-TEED BARN, BRIDGE & ROOF PAINT

An exceptional value for the purposes designated and far superior in quality to most paint sold under the name of Barn Paint. For outdoor purposes only.

	PRICE PER GALLON	
	5-Gal. Cans	1-Gal. Cans
460 Slate	\$2.20	\$2.25
461 Red	1.15	1.20
462 Green	1.15	1.20
466 Bright Red	1.70	1.75



### CERTAIN-TEED VARNISH STAIN

For floors, furniture and woodwork. Stains and varnishes at one operation, producing natural hardwood effects. Possesses the best of wearing qualities. Does not scratch white or show heel marks, or "bloom" when subjected to moisture. Covering capacity about 500 to 600 sq. ft. per gallon, one coat.

	Gals.	Qts.	Pts.	½ Pts.
30 Ground Color	\$2.90	\$0.85	\$0.45	\$0.28
31 Mahogany	2.35	.68	.39	.24
32 Light Oak	2.35	.68	.39	.24
33 Dark Oak	2.25	.67	.38	.24
34 Walnut	2.20	.63	.38	.24
35 Cherry Red	2.40	.69	.39	.24
36 Golden Oak	2.35	.68	.34	.24



### CERTAIN-TEED INSIDE FLOOR PAINT

For use on interior floors, stairs, etc. Will withstand hard usage and may be repeatedly washed. Covering capacity about 250 to 300 sq. ft. per gallon, two coats.

	Gals.	Qts.
720 Drab	\$2.50	\$0.73
722 Silver Gray	2.50	.71
723 Lead Color	2.50	.71
724 French Yellow	2.80	.77
725 Dark Oak	2.40	.69

### CERTAIN-TEED INTERIOR ENAMEL

General purpose enamel for finishing or refinishing interior woodwork, iron beds, furniture, picture frames, etc.

	Gals.	Qts.	½ Pts.
600 Gloss White	\$3.50	\$0.95	\$0.32
602 Gloss Black	2.85	.80	.28
603 Flat Black	2.20	.65	.23
604 Ivory	3.50	.95	.32
606 Puritan Gray	3.50	.95	.32
608 Light Blue	3.50	.95	.32
610 Green Tint	3.50	.95	.32



### CERTAIN-TEED METAL PAINT (Asphalt Base)

An asphalt product for use on exterior metal surfaces, such as bridges, metal roofs, smoke stacks, etc. Withstands heat. Dries in about six hours. Covering capacity about 400 sq. ft. per gallon.

	PRICE PER GALLON	
	5-Gal. Cans	1-Gal. Cans
941 Metal Paint	\$1.05	\$1.10

### CERTAIN-TEED UNIVERSAL VARNISH

For all exterior and interior purposes. Will stand as severe tests as any other varnish on the market. Covering capacity about 600 to 700 square feet per gallon, one coat.

	When ordering specify No. 900		
	Gals.	Qts.	Pts.
900 Universal Varnish	\$3.10	\$0.90	\$0.50

LET YOUR COWS GIVE TWICE THE MILK

# Don't Wonder Why the Milk Yield Drops Off in Summer

—Learn How To Stop The Loss Now

F. C. Bishopp, *World Famous Entomologist and Dairy Authority* States the Stable Fly Causes a LOSS of Milk of

from 40 to 60%

Extract from "HERMS Medical and Veterinary Entomology."

**READ AND THINK**

apparent that the flies must have grown in order to develop eggs.

**As a Cattle Pest.**—In a most useful and interesting paper on the stable fly, as a live stock pest, Bishopp<sup>1</sup> regards this fly as very important. Injury is brought about in various ways, *e.g.* worry, due to the attacks of myriads of flies; loss of blood; lessening of the milk supply from 40 to 60 per cent; loss of flesh; bringing on attacks of acute Texas fever if the cattle are already parasitized; etc.

**Surra.**—Surra is one of the most important diseases of horses in

William B. Herms is Associate Professor of Parasitology in the University of California, Consulting Parasitologist for the California State Board of Health, and formerly Professor of Zoology and Parasitology in the San Francisco Veterinary College.

*Which shall it be? Keep on losing half your milk — or double your milk money?*

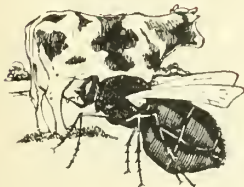

NOTE—The picture is overdrawn, but the idea it is meant to give you is *not exaggerated* as you will see by reading this page.

If an animal this size were to suck your cows every day, you would manage to kill him quickly.

Suppose you heard from a reliable source, that something was robbing you of from one-third to more than one-half of your milk money, you would make it your business to immediately get rid of the loss.

There is little doubt that the fly is a great factor in disease transmission.

In many cases swollen and stiff joints of both horses and cattle are caused from standing in water where they seek protection from flies.

Numerous instances are reported of animals becoming frantic from the painful stings and receiving serious injuries from running into barbed wire fences.

## There's One Way of Ridding All Your Stock from the Fly

There is a real genuine fly repellent which has been saving money for stockmen and dairymen everywhere for more than 25 years. It's the So-Bos-So Kilfly.

It will relieve your animals of the torture and pay many dollars in increased profits for every few cents that you spend for it. Even your satisfaction is guaranteed.

Applying So-Bos-So is a short job—just spray once or twice a day. Many thousands of dairymen can testify to the easy method and great results.

Made of highest grade materials, it's effective, absolutely harmless and most economical. A little goes a long way—sprays on fine, spreads fast and lasts long.



20% More Milk!



SPRAY Before Milking



SPRAY Before They Go Out to Pasture



GET MORE Milk - Flesh - Work!

## Be Prepared at Fly Time — Act Now

Does it pay to wait until you and your stock have felt the discomforts of fly season? When the cow drops off in milk flow it's hard and takes long to get her back to the same producing point. When the cow, mule, horse or calf has dropped off in flesh how much harder it is to bring 'em back than to have kept 'em in condition!

Prepare now with a drum of So-Bos-So Kilfly and our So-Bos-So Sprayer. Be ready for the pesky flies when they come.

It is a pure, oily liquid that sprays on in a fine spray, spreads and permeates quickly. A little goes a long ways. That's why we say that it's the cheapest fly repellent made. We guarantee So-Bos-So Kilfly to be absolutely harmless, not to taint milk, gum hair or blister the skin.

It is oil, not water, and will stand quite a heavy shower.

# SO-BOS-SO

TRADE **KILFLY** MARK  
REG. U. S. PAT. OFF.

**It Means Money in Your Pocket to Spray all Stock, every day, in Fly Time**

Systematic spraying, twice a day, rids stock of the annoyance and insures profits that flies would otherwise get.

The horse, the mule, the calf have blood that tastes good to flies. The more helpless they are; the shorter the tail; the more securely they are harnessed; that's when flies get after 'em most.

Many Uses of

# SO-BOS-SO

TRADE **KILFLY** MARK

REG. U. S. PAT. OFF.

- (1)—Spraying cows, horses, mules and other stock in fly time.
- (2)—Used in pig pens, poultry houses, etc.,—gets rid of lice and vermin.
- (3)—A thorough disinfectant.
- (4)—Sprayed in the barn and yard, it kills breeding flies and mosquito larvae. Kills the stench of rotting vegetable matter and manure.

The H. E. ALLEN MFG. CO., Inc.  
Carthage, N. Y.

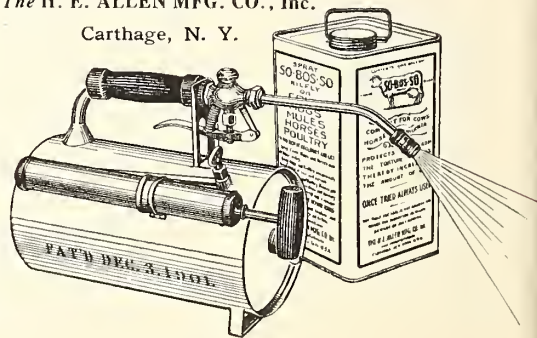

All Drums Are Provided  
With Faucets

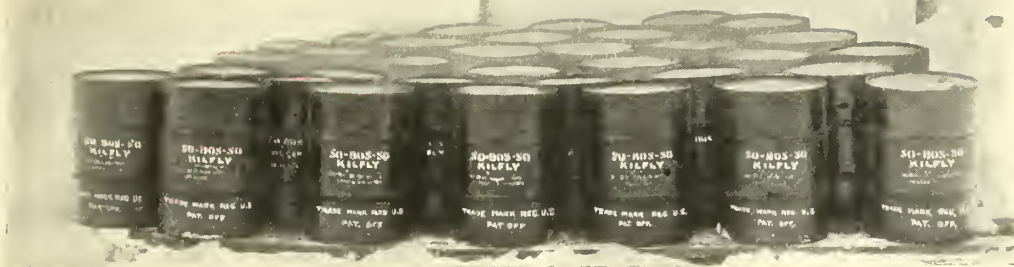

# SO-BOS-SO Sells in Carload Lots

TRADE **KILFLY** MARK  
REG. U. S. PAT. OFF.

## Why Buy Fly Spray in Drums?

- 1st—No waste whatever. Sprayer is held under the faucet and quickly and easily filled. You haven't spilled half a cup of spray which often happens when pouring a can.
- 2nd—Economical. Costs farmer \$1.00 per gallon; whereas in gallon cans it is \$1.40 or \$1.50.
- 3rd—Avoids running out of spray several times during the season. The supply for the summer is right on hand and the milk production will be increased 20 per cent by REGULAR spraying.

### "PROFIT FOR FARMER"

Cows sprayed regularly with So-Bos-So Kilfly during June, July, August and September, the milk production will be increased at least 20 per cent or 600 pounds for each average cow. It takes one gallon of So-Bos-So Kilfly to spray one cow for the four months. Cost of that gallon bought in a steel drum is \$1.00. The value of 600 pounds of milk,—well, at \$1.75 a cwt. it is \$10.50. That leaves for the farmer a net gain of \$9.50 on each cow. If he has thirty cows it amounts to \$285.00. Worth spending \$3000 to make, isn't it?

### YOUR Satisfaction-or-Money-Back GUARANTEE

SO-BOS-SO Kilfly is guaranteed to give each and every user entire satisfaction or his money will be refunded.

*The* H. E. ALLEN MFG. CO., Inc., Carthage, N. Y.

# The "Say-So" of Others on SO-BOS-SO

## It's Proven—We're Convinced

Naumburg, N. Y., October 5, 1923.

The H. E. Allen Mfg. Co., Inc.,  
Carthage, N. Y.

Dear Sirs:

Your So-Bos-So Kilfly has given such good results on my dairy this summer that I want to tell you about it. I wanted to use it a year ago, but the man on my farm did not believe in fly sprays and I couldn't get him to use it. This year I have a man who was willing to try it and we started spraying the cows just as soon as the flies appeared and he sprayed them thoroughly right through the fly season. We soon found out from Coon's factory where we drew our milk and also from other farmers near us, that our cows were giving more milk. They had just as good cows and their pastures were as good as ours so the only difference was our using So-Bos-So Kilfly. I took pains to inquire several times during the summer and we were still getting more milk. Naturally, both my tenant and myself are convinced of the value of So-Bos-So Kilfly for it has been proven to us that it increases the milk production.

A. E. ZAHN.

\* \* \*

## Breeder Has Used It Several Years

BREEDERS OF REGISTERED GUERNSEYS

Pure Guernsey Milk and Cream.  
Groton, Mass., July 8, 1920.

Please find enclosed money order for which please send me ½ gallon can of So-Bos-So and Sprayer. Our dealer, H. P. Taintor, here does not keep this spray and I have been unable to find the same in Boston. I used your spray several years in other herds and like it very much. Please give me price on half a dozen cans or tell me where I can procure the same.

(Signed) W. E. BURDICK.

\* \* \*

## Unnecessary to Sample It

R. 2, Elk River, Minn., July 19, 1920.

Enclosed find check for \$6.50 for which please send me another 5 gallon can of So-Bos-So. I tried to buy it here but they don't keep it and don't intend to. I inquired at every store in Elk River and every one has two or three different brands. I asked for So-Bos-So and they all have the same story. (Take a gallon of this home and use it and if you don't find it as good as So-Bos-So, or better, bring it back and we will refund your money.) But I don't care to do that if I can get what I want. So if you would please be so kind and send me another can I will sure be glad to have it as I know it is good and don't have to sample it.

(Signed) DAVID P. DEHEN.

## "Tell Your Friends"

East Templeton, Mass., July 14, 1920.

Have been using So-Bos-So Kilfly for the past few weeks and want you to know that I consider it wonderful and a great help around the barn. Have recommended it to all my friends.

HARRY F. TURNEY.

\* \* \*

## Does the Work

Nunica, Mich., R.F.D. No. 2, August 16, 1920

Is there any store in Muskegon, Mich. that sells So-Bos-So? Have tried here and they always want to sell something else. I want So-Bos-So for it does the work.

M. S. PETT.

\* \* \*

## Kills Flies At Once

Avoca, Mich., R.F.D. No. 1, June 30, 1919.

Received my sprayer and So-Bos-So and will say it is great, kills the flies at once. Have had to only spray once a day and for lice it can't be beat.

MRS. LULA DEEMERT.

\* \* \*

## Nothing Else Equal to It

Maybe, Mich., August 15, 1923.

Please quote me price on one gallon So-Bos-So Kilfly prepaid to this place. Have used So-Bos-So for four seasons and can't find anything equal to it for the purpose. Dealers of whom I have been getting it, are now selling other brands that are not satisfactory to me so thought I would order direct.

J. A. KELLIE.

\* \* \*

## Can't Do Without It

Cold Spring, R.F.D., Putnam County, N. Y.

February 28, 1922.

Please let me know the price of your So-Bos-So Kilfly gallon cans. I have been using it for a number of years and cannot do without it.

WALTER WALLACE.

\* \* \*

## Does Wonders

Maltby, Mich., Dec. 4, 1923.

I have used So-Bos-So Kilfly on both our horses and cows and think it is the very best there is. I have also used it on my poultry and in the poultry houses and other outbuildings and it sure does wonders. I also used it to spray on my screen doors to keep flies away.

MRS. P. LINCE.

**Convince Yourself By A Trial**

Distributors

GRIFFITH & TURNER CO.  
Baltimore, Md.

# The "Little Wonder"

TRADE MARK REG. U. S. PAT. OFF.

## Hedge Trimmer

PAT. MAY 26, 1914. OTHER PAT. PEND.



SHOWING USE ON LOW HEDGES

### *Revolutionizes Hedge Trimming*

Reduces Cost of Hedge Trimming to  
a small fraction

Distributed by

The "Little Wonder" Hedge Trimmer entirely revolutionizes hedge trimming.

Trims every variety of hedge grown.

Various adjustments and attachments suit to every shape and cut desired.

It is wonderful how quick it cuts, (actually as fast as you walk), and how smooth a job it makes and how easy it operates. A lady can easily operate.

An amateur becomes proficient almost immediately.



SHOWING USE ON HIGH HEDGES

Can you afford to shut your eyes to this tremendous saving?

To get a beautiful thick hedge it is necessary to trim often, at least every three weeks. Every time a hedge is cut, new shoots sprout out immediately back of the fresh cut. The "Little Wonder" makes the frequent cutting possible without practically any expense. Anyone can operate it. It is a toy for the big boy.



Side cuts on hedges as high as four feet are made in this fashion. Adjustments compensate for short or tall operators. For side or fancy cuts on high hedges, method as shown on opposite page is employed. Holding machine in horizontal position

Will cut sides high as ten feet right from ground, by one person assisting.



The 30 inch size is an all around one man machine, cutting hedges 4 feet wide and 4 feet high.

Made in 3 sizes, 30, 40 and 60 inch cutting bars.

It cuts from five to ten times as fast as by hand and does better work, as letter on last page indicates.

Guarantee for one year and complete instructions (so simple that a child can assemble), accompanies each machine.

Weight 12 to 16 pounds according to attachments used.

May be sent by parcel post.

HARMON AUGUST  
347 MADISON AVENUE  
AT 45TH STREET  
CITY OF NEW YORK

September 15, 1921.

Gentlemen:

Perhaps you may care to have a word from me as to the splendid results I am obtaining from your "Little Wonder" hedge cutting machine at my country place in Harrison.

It not only does as good work as we formerly did by hand but we keep our hedges in much better shape because of being able to trim them often enough and we succeed in cutting in about three hours that which it formerly took about three days to do by hand.

As Vice President of the May Department Stores Co., I am going to recommend the machine when the season is at hand in our house furnishing and gardening departments, and also at the Repetti Estate at Lake Mohegan, N. Y., which I am now using as Camp Josephine for working girls.

Wishing you the success your machine so well merits, I am

Very truly yours,

HA\*S

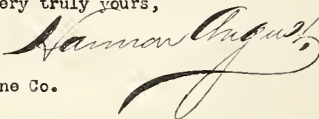

John C. Dettra Machine Co.  
Oaks,  
Montgomery Co., Pa.

---

The above is a sample of hundreds of expressions that came to us telling of the durability of the machine and how wonderful it performs.

**SEEDS.**

Asparagus Bunchers 1  
 Asparagus Knives 1  
 Asparagus Roots 1  
 Barley 44  
 Broom Corn 46  
 Buckwheat 44  
 Caladiums 51  
 Canada Field Peas 46  
 Canna Roots 53  
 Cannas 53  
 Chrysanthemums 54  
 Clover Seeds 43  
 Corn, Sugar 14-15  
 Corn, Field 44  
 Cow Peas 45  
 Dahlia Roots 55-56  
 Dahlias 55-56  
 Flax Seed 46  
 Flower Seed 47-50  
 Forage and Silo Seed 45  
 Geraniums 53  
 Gladiolus 51  
 Grass Seeds 42-43  
 Herbs 30  
 Kafir Corn 45  
 Lawn Grass 44  
 Maderia Vine Roots 51  
 Millet 46  
 Mushroom Spawn 25  
 Nasturtiums 49  
 Oats 44

**Parcel Post Rates—  
 (Front Cover)**

Plant Department 53-56  
 Potatoes 39  
 Raffia 1  
 Rape 46  
 Roots 1-25  
 Sunflower Seed 46  
 Sweet Peas 51  
 Teosinte 46  
 Tube Roses 51  
 Vegetable Plants 52  
 Vegetable Seeds 1-38  
 Vetches 46  
 Wheat 41  
 White Clover 44

**A**

Acid for Testers 102  
 Alfalfa, Meal 82  
 American Horse Tonic 83  
 Anvils 157  
 Aphis Pank 79  
 Apple Mills 144  
 Apple Parer 101  
 Arsenate of Lead 78  
 Arsenate of Zinc 78  
 Artesian Well Cylinders 154  
 Ash Cans 101  
 Ash Sifter 101  
 Asparagus Bunchers 61  
 Asparagus Knives 61  
 Atomic Sulphur 78  
 Atomizers 65  
 Auto Jacks 176  
 Automobile Accessories 174-175  
 Automobile Heaters 176  
 Automobile Tires 174  
 Auto Sprayers 67  
 Avicol 82  
 Axe Handles 162  
 Axes 162  
 Axle Grease 114  
 Axle Washers 175

**B**

Back Band Hooks 172  
 Back Bands 172  
 Bag Balm 83  
 Bale Ties 139  
 Baling Presses 136-139  
 Barley Forks 159  
 Barn Door Hangers 164-165  
 Barn Equipment 168-170  
 Barrel Headers 193  
 Basket Handles 142  
 Baskets 101  
 Batteries 149  
 Battery Testers 175  
 Bean Threshers 139  
 Beef Scrap 82  
 Beef Scrap Hoppers 90  
 Belts 122  
 Belting Canvas 141  
 Belting Link Chain 136  
 Belting Rubber 141  
 Belt Lacing 141  
 Belt Punches 163  
 Berry Presses 144  
 Binder Repairs 136-137  
 Binders 135

Binder Twine 167  
 Bits 157  
 B. K. 84  
 Black Leaf 40 79  
 Blackmans Salt Bricks 83  
 Blacksmith Outfits 157  
 Blatchford's Calf Meal 82-83  
 Blatchford's Chick Mash 82  
 Blatchford's Egg Mash 82  
 Blatchford's Lamb Food 81  
 Blatchford's Pig Meal 81  
 Blocks and Tackle 167  
 Bluestone 78  
 Boilers 94  
 Bolster Springs 180  
 Bolts, Carriage & Machine 163  
 Bolts, Plow 118  
 Bone and Shell Mills 85  
 Books 58  
 Bordeaux Mixture 78  
 Border Shears 62  
 Bourbon Remedies 81  
 Bowls, Cow 169  
 Breast Chains 173  
 Brood Coops 91  
 Brooders 86-87  
 Brooder Stoves 86-87  
 Brooms 103  
 Brushes, Horse 173  
 Brushes, Separator 103  
 B. T. S. 77  
 Budding Knives 61  
 Bug Death 79  
 Bug Death Shaker 65  
 Buggies 178  
 Buggy Cushions 172  
 Buggy Poles 172  
 Buggy Shafts 172  
 Buggy Tops 172  
 Bull Leader Snaps 103  
 Bull Rings 103  
 Bull Tongues 129  
 Bush Hooks 161  
 Butter Boxes 99  
 Butt Chains 173  
 Butter Bowls 98  
 Butter Coloring 102  
 Butter Ladles 98  
 Butter Paper 90  
 Butter Printers 98  
 Butter Spades 98  
 Butter Workers 98

**C**

Calf Feeders 103  
 Calf Meal 83  
 Calf Weaners 91  
 Canning Boilers 92  
 Cane Stakes 64  
 Can Sealer 92  
 Cant Hooks 146  
 Caponizing Tools 91  
 Carbola 59  
 Carbolineum 84  
 Carriage Heaters 176  
 Carriage Poles 172  
 Carts 180  
 Cattle Ties 172  
 Cement Palls 100  
 Chain Horse Shoes 173  
 Chains 173  
 Charcoal 82  
 Check Rower Wire 124  
 Cherry Seeders 101  
 Chick Feed 82  
 Chick Fount 90  
 Chick Manna 82  
 Chisels, Cold 163  
 Church Bells 122  
 Churns 96  
 Cider Mills 141  
 Circular Saws 145  
 Cleanser Dominion 99  
 Clevises 120  
 Clippers 63-182  
 Clothes Dryers 112  
 Clothes Line Posts 112  
 Clover Cutter 85  
 Coal, Prepared 176  
 Coal Sifters 201  
 Coaster Wagons 185  
 Columbia Batteries 149  
 Consumers 111  
 Contractors' Carts 180  
 Contractors' Plows 121  
 Cookers 91  
 Coops 91  
 Corn Binders 135  
 Corn Crushers 143  
 Corner Mangers 171  
 Corn Grader 124  
 Corn Hooks 161  
 Corn Huskers 127  
 Corn Knives 161  
 Corn Mills 143  
 Corn Planter Runners 125

Corn Planters 124-125-126  
 Corn Shellers 142  
 Copper Sulphate 78  
 Cotton Hoes 160  
 Cotlers, Spring 136  
 Coulters, Rolling 119  
 Cow Bowls 169  
 Cow Ease 84  
 Cow Remedies 83  
 Cradles, Grain 161  
 Cream Pails 97  
 Cream Separator 95  
 Creonoid 84  
 Creosote 84  
 Crow Bars 165  
 Crushed Oyster Shell 82  
 Cultipackers 107  
 Cultivator Repairs 129  
 Cultivators 128-130  
 Cultivators, Hand 113-159  
 Cultivators, Horse 119-128-130-131  
 Cultivator Steels 129  
 Cultivators, Walking 128  
 Curry Combs 173  
 Cut Worm Powder 79

**D**

Dairy Thermometers 102  
 Dairy Scales 99  
 Dairy Supplies 95-103  
 Dehorning Clippers 103  
 Delivery Wagons 178  
 Dethol 79  
 Developing Food 82  
 Dibbers 61  
 Digging Bars 165  
 Disk Harrows 132-133  
 Ditchers 134  
 Diverse Cultivators 128  
 Dog Remedies 83  
 Dominion Cleanser 99  
 Dominion Fly Spray 84  
 Don Sung 82  
 Door Hangers 164-165  
 Doubletrees 120  
 Drag Scrapers 121  
 Drills, Grain 124  
 Drills, Hand 113  
 Drills, Machinists 157  
 Drill Points 124  
 Drill Tubes 124  
 Drinking Fountains 89-90  
 Drive Well Points 153  
 Dry Mash Hoppers 90  
 Dusters 65  
 Dump Wagon 176

**E**

Earth Augers 158  
 Economy Oat Sprouters 91  
 Edging Knives 61-159  
 Egg Boxes 88-97  
 Egg Testers 86  
 Electric Pumps 148  
 Engines 150  
 Engine Trucks 178  
 Ensilage Cutters 140-141  
 Ensilage Forks 159  
 Extension Rods 71  
 Equalizers 120

**F**

Fanning Mills 140  
 Farm Bells 122  
 Farm Carts 180  
 Farm Ditchers 134  
 Farmogerm 60  
 Feed Carriers 170  
 Feed Cookers 94  
 Feed Cutters 140  
 Feed and Drinking Cups 90  
 Feed Mills 143  
 Feed Racks 171  
 Feed Trucks 170  
 Fence Posts 111  
 Fence Wire 109-112  
 Fertilizer 193  
 Fertilizer Distributor 126  
 Fertilizer Drill 124  
 Fifth Chains 173  
 Fire Extinguishers 69  
 Fish Oil Soap 78  
 Fittings, Brass 151  
 Fittings, Galvanized 151  
 Flower Bed Guard 109  
 Flower Scissors 61  
 Flower Tubs 73  
 Fly Spray 84  
 Fodder Yarn 167  
 Food Choppers 92  
 Forges 157-163  
 Forks 159  
 Formaldehyde 79  
 Fruit Dryers 92

Fruit Pickers 64  
 Fruit Presses 144  
 Fumigators 79  
 Furnaces 104

**G**

Gang Plows 116  
 Gape Cure 82  
 Gape Worm Extractors 91  
 Garage Door Hangers 164  
 Garbage Cans 101  
 Garden Cultivators 113-159  
 Garden Hoes 160  
 Garden Hose 72  
 Garden Line 61  
 Garden Rakes 160  
 Garden Reels 61  
 Garden Sets 159  
 Garden Tools 159-161  
 Garden Trowels 61  
 Garget Remedy 83  
 Gasoline Engines 150  
 Gates 109-110-112  
 Glazing Machines 63  
 Glazing Points 63  
 Glazing Putty 63  
 Grafting Wax 63  
 Grain Cradles 161  
 Grain Drills 124  
 Grain Fans 140  
 Granulated Milk for Poultry 82  
 Grape Dust 78  
 Grape Scissors 61  
 Grass Catchers 106  
 Grass Hooks 61  
 Grass Seeders 115-171  
 Grass Shears 62  
 Green Bone Cutters 85  
 Grinding Mills, Hand 85-142  
 Grinding Mills, Power 143  
 Grindstones 138  
 Grit for Poultry 82  
 Grit and Shell Boxes 90  
 Grub Hoes 162  
 Grub Plows 116

**H**

Hackets' Gape Cure 82  
 Halter Chains 173  
 Halters 172  
 Hames 173  
 Hame Strings 172  
 Hammers 157  
 Hand Corn Planters 124  
 Handles 159  
 Hand Trucks 178  
 Harness 172  
 Harrow and Cultivators Combined 130  
 Harrows 131-134  
 Harrow Teeth Spikes 129  
 Harrow Teeth Springs 131  
 Harrow Teeth Points 131  
 Hasps 165  
 Hatches 162  
 Hay Presses 139  
 Hay Forks 159  
 Hay Knives 161  
 Hay Loaders 135  
 Hay Racks 171  
 Hay Rakes, Horse 135  
 Hay Tedders 135  
 Hay Tools 166-167  
 Hedge Shears 62  
 Hedge Trimmers 62  
 Hellebore 79  
 Hen Feed 82  
 Hens' Nest 91  
 Hess & Clark Poultry and Stock Preparations 81  
 Hinges 165  
 Hoes 160  
 Hog Feeders 185  
 Hog Oil 185  
 Hog Oilers 185  
 Hog Remedies 80-81  
 Hog Rings 103  
 Hog Scaiders 94  
 Hog Troughs 171  
 Hog Waterers 185  
 Hoist 167  
 Home Canning Boilers 92  
 Horse Brushes 173  
 Horse and Cattle Remedies 83  
 Horse Clippers 63-182  
 Horse Collar 172  
 Horse Comfort 83  
 Horse and Dog Clippers 63-182  
 Horse Lawn Boots 106  
 Horse Lawn Mowers 105  
 Horse Muzzles 171  
 Horse Over Shoes 173  
 Horse Radish Graters 92  
 Horse Rakes 135

# GRIFFITH & TURNER CO.

## FARM AND GARDEN SUPPLIES

"GRITCO" RUNNER AND WHEEL HARROWS

"POMONA" SPRAY PUMP

WATER CART

FEED GRINDING MILLS

GRIFFITH & TURNER STUDEBAKER AND BROWN

THE BEST PLOW IN THE WORLD  
GENUINE OLIVER CHILLED PLOW

CUTAWAY CLARK HARROWS

RIDING AND WALKING CULTIVATORS

ONE AND TWO HORSE FIELD MOWER

BLATCHFORD'S CALF MEAL  
THE MILK SUBSTITUTE  
GRIFFITH & TURNER CO.  
GENERAL AGENTS  
BALTIMORE, MD.

GRIFFITH AND TURNER CO'S ANIMAL BONE PHOSPHATE

# LEMON OIL CO'S INSECTICIDE

IS RECOMMENDED AND IN USE BY THE LEADING SEEDSMEN AND FLORISTS.