

2244
D33P7

EX LIBRIS UNIVERSITY OF CALIFORNIA



JOHN HENRY NASH LIBRARY
 ♦ SAN FRANCISCO ♦
 PRESENTED TO THE
 UNIVERSITY OF CALIFORNIA
 ROBERT GORDON SPROUL, PRESIDENT.
 ♦ BY ♦
 MR. AND MRS. MILTON S. RAY
 CECILY, VIRGINIA AND ROSALYN RAY
 AND THE
 RAY OIL BURNER COMPANY
 SAN FRANCISCO
 NEW YORK

M495001

THE PRACTICE OF
TYPOGRAPHY



Digitized by the Internet Archive
in 2007 with funding from
Microsoft Corporation

THE PRACTICE OF
TYPOGRAPHY

A TREATISE ON THE
PROCESSES OF TYPE-MAKING
THE POINT SYSTEM, THE NAMES, SIZES
STYLES AND PRICES OF

PLAIN PRINTING TYPES

BY
THEODORE LOW DE VINNE

//



NEW YORK
THE CENTURY CO.
1900

Copyright, 1899, by
THEODORE LOW DE VINNE.

THE DE VINNE PRESS.



PREFACE

THIS treatise is a summary of detached notes collected by the writer since 1860. A desire to make it complete and exact has prevented its earlier publication. As an aid to this result each chapter has been revised recently by experts in different branches of printing. In its present corrected form it is believed that it will be found of use to all who seek for information about types which cannot be compressed within the ordinary manual of printing, or be gleaned quickly from the specimen books of many type-founders. The scope of the book has to be limited to plain types. Remarks concerning newspaper types, typographic decorations, and recent fashions in book-work, have to be postponed. The composition of title-pages may be the subject of another treatise.

In making the numerous corrections demanded by changes of fashion and new methods of manufacture, I have not considered it judicious to change the earlier and best-known name of any type-

foundry which has introduced a new face of type. Many of them are now branches of the American Type Founders Company. To accredit each face of type to a great company which has branches in many widely separated cities would not properly specify the maker or the place of manufacture.

Acknowledgments for valuable information in the preparation of this matter are due, and are here gratefully made, to the late David Bruce, Jr., the late James Lindsay, and their successor Mr. V. B. Munson, of the New York Type Foundry; to Mr. J. W. Phinney of Boston, Mr. L. S. Benton of New York, and Mr. Henry Barth of Cincinnati, of the American Type Founders Company; to Mr. Charles T. Jacobi of the Chiswick Press, and Mr. T. W. Smith of H. W. Caslon & Company, London; to Messrs. Theodor Goebel of Stuttgart, Claude Motteroz of Paris, V. Deslandes of the Imprensa Nacional of Lisbon, and William E. Loy of San Francisco.

CONTENTS

| CHAPTER | PAGE |
|--|------|
| I The Processes of Type-making | 9 |
| II The Names of the Leading Sizes of Types | 53 |
| III The Point System | 123 |
| IV A Font of Type | 165 |
| v Faces or Styles of Type. Old-style Roman | 182 |
| VI Modern Faces of Roman Letter | 209 |
| VII Condensed Roman Types | 255 |
| VIII Italic Types | 269 |
| IX Fat-face or Title-types | 281 |
| x Black-letter | 291 |
| XI Gothic | 315 |
| XII Antique Types, Runic, Celtic, and Italian . | 323 |
| XIII The Classes and Prices of Printing-types . . | 336 |
| XIV Large Types. Wood Types. The Panto- graph. Benton's Punch-cutting Machine | 345 |
| xv Recent Quaint Styles of Plain Type . . . | 359 |



PLAIN PRINTING-TYPES

I

The Processes of Type-making

PRINTING-TYPES are made from an alloy of melted lead, tin, antimony, and sometimes copper, that fills the mould exactly and shrinks but little in cooling. The utility of typography depends upon the accuracy of each type, and the consequent squareness of a thousand or a hundred thousand types in any combination. This accuracy is most certainly secured by founding each type singly in a mould. Experiments in cutting or swaging them from cold metal have hitherto been unsuccessful. Nor is there any practical substitute for type-metal: brass and copper melt at a great heat that soon wears out the mould; lead and tin are too soft for the service required; glass is too brittle, and will

Types must
be founded
in moulds

not entirely fill the matrix; gutta-percha and celluloid cost more and have disadvantages that outweigh their merits. Large types for posting-bills

Large types are made from close-grained wood like
made from that of the box, maple, or pear tree: for
hard woods this branch of printing, types of wood
 are preferred, as lighter and cheaper than those
 made from metal. Types of wood are seldom
 smaller as to height of face than one inch. They
 can be made smaller, but small pieces of wood
 warp after heat or swell after moisture and are
 unfit for practical work.

As now practised, type-making has six distinct
 departments: (1) Punch-cutting, or the art of de-
six depart- signing and engraving the model char-
ments in acters from which types are made; (2)
type-making Fitting-up, or the art of adjusting the
 matrices to the moulds; (3) Electrotyping, or the
 art of making matrices by electrolysis; (4) Mould-
 making, or the art of constructing the moulds in
 which types are cast, and the exact tools by which
 their accuracy is tested; (5) Type-casting, or the
 art of founding types in moulds; (6) Type-dress-
 ing, or the art of finishing the incomplete work
 of the type-caster. The breaking-off of surplus
 metal from the cast types, the rubbing-down of
 the feather edge made in casting, the kerning or
 adjusting of overhanging letters, and the final in-
 spection of each finished type are additional oper-
 ations. Every large foundry has a few workmen

who are expert in two or three of these departments, but the ordinary workman has knowledge and practice in one department only.

Punch-cutting is the first process, which must be preceded by a careful drawing of the characters.

No operation in typography requires more skill than this, and in none is error more disastrous.¹ The modern

Punch-cutting is the first process

punch-cutter is not fettered by arbitrary rules: he does not conform to the models devised by Albert Dürer, nor those subsequently made by French theorists in type-founding. He is at liberty to design characters that may be taller or broader, thicker or thinner, than any heretofore made, but he is required to make all the characters of a full font uniform as to style, so as to show perfect correlation.

The characters must seem uniform as to height, line, stroke, serif, curve, and angle; they should be in

Types must be drawn accurately

proper relative proportion as to size, and as to nearness and distance in all combinations. The beauty of text-types is in their precision. That freedom of drawing which is permitted, and some-

¹Type-founding is not like other arts, in which imperfect workmanship may find a use proportionate to its relative value. Printing should tolerate nothing that is bad, nor even that which is mediocre, since it costs as much to found and print bad types as it does to found and print perfect ones.

If the punch-cutter has not the requisite ability for the work, the founder, who gives metal, and the printer, who gives paper, cannot retrieve his errors. They are obliged to perpetuate these evidences of his mean ability, and to dishonor typography. Fournier, "Manuel Typographique," vol. i, p. 3.

times approved, in the letters of a good penman, or in engraving, or in the types of job printers, is not tolerated in the text-types of books, which must be precise.¹

The assortment of characters known to printers as a font of roman book-type requires the engraving of 150 punches: 29 large capitals, including &, Æ, and Œ; 29 small capitals, including &, Æ, and Œ; 33 lower-case characters, including fi, fl, ff, ffi, ffl, æ, and œ; 19 figures and fractions; 22 points, references, and signs; 18 other characters. Accents and the special signs required for some books are not furnished in the regular assortment.

These characters are divided into six classes of irregular heights of face: (1) Full-bodied letters, like Q and j—that occupy the entire body of the

¹ Dürer's rules and diagrams for the formation of letters, in his "Unterweysung der Messung" of 1524, are reprinted in "Die Initialen der Renaissance," by Camillo Sitte and Josef Salb (folio, Vienna, 1882). Geoffrey Tory of Paris, in his "Champfleury" of 1529; Ycair of Saragossa, in his "Orthographia Practica" of 1548; and Paccioli of Venice, in his "De Divina Proportionone" of 1509, have also devised geometrical formulas for letters. Moxon's scheme for the plotting out of each letter in little squares 42 wide and 42 high is illustrated in the text (p. 13), and detailed ex-

planations of it are given in his "Regulæ Trium Ordinum Literarum Typographicarum" of 1676. The extreme of scientific precision was attempted by a commission of the "Académie des Sciences" of Paris, appointed in 1694, of which M. Jaugeon was the chief. He recommended the projection of every roman capital on a framework of 2304 little squares, and on a congeries of squares and rhomboids and curves for lower-case and italic letters. These rules and diagrams no doubt are of some use to designers of letters, but they have never been fully adopted by any punch-cutter.

type; (2) Ascending letters, like A, b, h, d, that occupy the upper three-fourths of the body; (3) Descending letters, like p, y, g, q, that occupy the lower three-fourths of the body; (4) Short letters like a, o, that occupy about one-half of the body in the middle part; (5) Small capitals, that are sometimes in height more than one-half of the body, but not as high as the ascending letters; (6) Irregular characters, like the *, that have no arbitrary height, but do have a definite position.

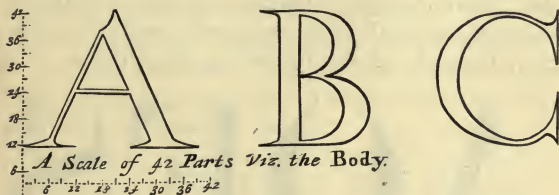

Moxon's method of designing letters.

The punch-cutter begins his work of practical design by drawing a geometrical framework, on which he determines the proper position of every line and the height of each character. A small margin is left at top and bottom of the face to prevent the touching of a descending letter against an ascending letter in the next line, as well as to prevent the wear of exposed lines cut flush to the edge of the body.

Letters are first drawn on paper

The relative heights of the short and long letters vary greatly: in some styles the short letters are but one-third of the body; in other styles, nearly two-thirds, and the ascending and descending letters are correspondingly taller or shorter.

Measuring instruments of precision are needed, but they cannot be used servilely or thoughtlessly.

Optical delusions are humored To give the type the needed appearance of uniformity, some of the lines must be laid down in directions that transgress the rules. Some types have to be drawn longer than their fellows. Optical delusions must be humored, as will be more clearly shown in the curved letters of the following illustration.

A O E S

If a straight-edge be laid against the foot of this line, one can see that the letters which curve at the foot fall below the line. If they did not project they would seem too short. The angles of capital letters like A Y M N Z have to be varied for each letter. These are conspicuous examples, but there are many more; a large proportion of the characters for every font of roman or italic contain lines that are departures from the rules

which must be observed in their mated characters. Deviations have to be made occasionally, not only to deceive the eye, but to make each letter pleasing and generally acceptable in any combination with other letters. The effect of letters in combination must be studied.

These irregularities cannot be formulated in a system; they vary with every new style of face, and to some extent with every new size of body. The knowledge of what is needed in the forms of types can be acquired only by long practice, and by a careful study of the combinations of different letters. American type-founders say that there are not a dozen men in the United States who can make acceptable drawings for a symmetrical font of roman and italic types.

When the proportions of the letters have been determined, the punch-cutter begins his work by making a counter-punch of steel. The illustration adjoining shows the form of a counter-punch for the letter H of

A counter-punch the first work

 the size of double english. It is an engraving in high relief of the counter or hollow part of the type, that is, of that part which appears white in the printed letter. These counter-punches have little resemblance to the letters for which they are intended. When approved, the counter-punch is impressed, to a proper depth, into the end of a short bar of soft steel. The depth is necessarily shallow for small types and

deeper for large types.¹ Properly impressed or struck, this counter-punch finishes, at one stroke, the interior part of the model letter, and does it more quickly and neatly than it could be done with cutting tools.

This bar of soft steel is known as the punch.

When it has received the impress of the counter-punch, the engraver cuts away the outer edges until the letter is adjudged perfect.

The punch is the model type—the pattern from which it is intended that thousands of printing-types shall be made. To make this model letter on the punch faultlessly, all the measurements of the drawing on paper are repeated on the steel, gauges are frequently used, and trial proofs are taken while the work is in progress. To get these trial proofs the cutter puts the punch into the flame of a flaring gas-burner until its face is covered with soot. Then, after breathing repeatedly on a bit of paper until its surface is softened by moisture, he firmly presses the punch on the paper. In this way he



Punch of letter H.

¹ Fournier, in his "Manuel Typographique" (vol. i, p. 12), recommends one-fourth of a geometric line, or about the forty-eighth of an inch, as the proper depth for small type. This makes the counter too shallow, and sufficiently justifies the objection of Fertel, an early French printer, who said that the counters of small French types filled up with ink too quickly, and thus prevented good presswork.

gets a sharper proof of his work than can be had from any impression made from black mixed with oil or upon paper sodden with water.

When the engraver has finished the cutting of the punch, its soft steel is hardened until it has strength to penetrate copper. This done, it is then punched in a flat, narrow bar of cold-rolled copper, which makes a reversed duplicate of the letter on the punch. In this state the copper bar is known as a drive, a strike, or an unjustified matrix. It is only when the drive has been made perfect that it is known as the matrix. This matrix is really the mould for the face of the letter.

Striking
of the
matrix

The drive is a shapeless bit of copper, which must be accurately fitted to the mould. During the operation of casting, it must move freely to and from the mould, and yet be snugly fitted thereto. Its outer surface must be in exact parallel with the face of the sunken letter below.

Fitting
of the
matrix

Not only this matrix, but all matrices of the same font, must be of the same depth from the surface to the sunken face; each must be accurately square on the sides, and all must have the sunken letters relatively in the same position. If

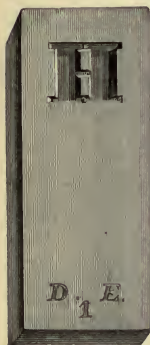

Matrix of letter H.

The letters ^{D, 1, E} are private marks of the founder which cannot appear on the type.

this is badly done, the founded types will not stand true in line or have true spaces on the sides. The process of converting a drive into an available matrix, known among type-founders as fitting-up, or justifying, is one of the nicest of operations. When perfected the matrix is stamped at the foot with letters or figures which enable the caster to identify it.

Matrices are also made by processes of electrotyping,¹ for which the punch of steel and the operation of striking are not required. The model letters are cut on type-metal, and, after preparation, are suspended in a battery containing a solution of sulphate of copper. The action of the electric current on the submerged zinc and copper plates liberates atoms

¹ Joseph A. Adams of New York was the first American to experiment in electrotypes for printing cuts. In 1839 he was engraving the woodcuts for Harper's "Pictorial Bible," at that date the most elaborately illustrated book that had been planned in this country. In overseeing the printing of this work he had practical evidence both of the weakness of the woodcut and the imperfection of stereotype, which suggested to him the value of a better process. In 1841 he furnished to "Mapes's Magazine" an electrotype of one of his engravings, which was successfully printed. In 1840 Profes-

sor Jacobi of St. Petersburg, Thomas Spencer of Liverpool, and J. C. Jordan of London, who seem to have been making experiments without any knowledge of one another's attempts, succeeded in making electrotype plates. The first electrotype matrix for types was made by Edwin Starr of Philadelphia in 1845, and used in the foundry of James Conner of New York. This innovation was not then received with favor, for the new matrices were inferior. The objections made against the first electrotyped matrices do not apply to all that are made now, because they are used for large types in all type-foundries.

of copper which are attracted and adhere to all the suspended model letters. When these letters have received a thick deposit of copper they are taken out of the battery and their thick coats or shells of copper are removed. The shells are then backed up or strengthened, and converted by the fitter-up into movable matrices. Matrices can be made by the electrotype process from engraved type-metal as readily as from punches.

Every character in the ordinary font of roman and italic has its own matrix, but all these matrices are adjusted to one mould. This mould must not only be true for its own work, so that every type cast from it will readily combine with its mates, but must be true in all points to the standard mould, and all other moulds for that body. A printer requires of the founder that types cast to-day shall be of exactly the same body as types cast twenty years ago, regardless of the wear of the mould during this long interval. If types were as uniform in width as they are in height, the task would not be so difficult; but letters vary irregularly in width from the *i* to the *W*, and the spaces vary regularly from the hair-space | to the three-em  quadrat. It follows that the mould must be made adjustable, and that nearly every change of matrix will compel a readjustment of the mould.

The type-mould is of two pieces, apparently a right and a left counterpart. The matrix pro-

vided for the face is regarded as an attachment. Each piece consists of a number of firmly screwed bits of polished steel. When the two counterparts are properly brought together their interior sides are in exact parallel at a fixed and unalterable distance. The upper end of the mould is provided with a seat for the matrix; the lower end is open for the inflow of melted type-metal. Between these ends is the hollow to be filled with the melted metal that makes the type. Although the mould when joined is immovable in the direction that determines the body of the type, it has great liberty of motion and ease of adjustment in the direction that determines the thickness or the width of the type. The counterparts, when properly adjusted, slide to and fro on broad and solid bearings that prevent their getting out of square.¹

Moulds are now made to be attached to type-casting machines, for casting by hand exclusively has not been done in any American foundry since 1845. At the base of the machine is a small furnace, the heat of which keeps fluid the metal in the pot above. Suspended over this pot is a flat-faced

¹ The type-mould now in use does not materially differ from that shown by Fournier, in his "Manuel Typographique" of 1764, or by Moxon in his "Mechanick Exercises" of 1683, who

does not write of it as a recent invention. Its more important features are as old as the invention of typography. Moxon's moulds were of iron; those of the early founders were of brass.

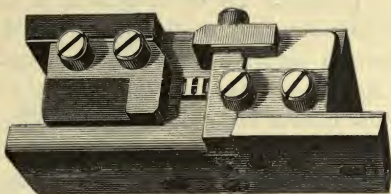

Type-mould without matrix, and with a type of the letter H in the mould.

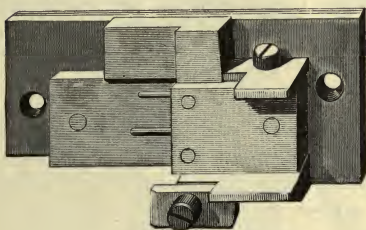

One half of the mould.

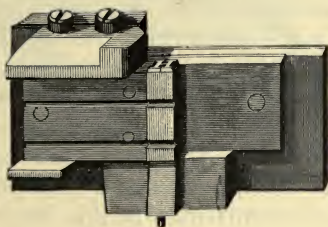

The other half of the mould.

piston, or plunger. Every revolution of the crank gives to this plunger a sudden thrust which injects through an unseen aperture enough of the melted metal to instantly fill the mould and the matrix, the matrix being held in place by a lever. As soon as the mould receives the metal it opens at an obtuse angle, as a door upon hinges. At the same instant the pressure on the lever that binds the matrix close to the mould is released, and then the matrix springs backward. The type is held in the upper half of the mould by a blunt pin, and when it raises, by the assistance of a rod which is connected with the apron, the stool hits the face end at the back and releases the type. As soon as the type is dislodged the mould closes automatically, and the plunger injects a new supply of metal, which is thrown out as before in the shape of a type.

Although types are cast singly they can be made rapidly; the rate of one hundred in a minute is not an uncommon production of the Types rapidly made smaller sizes. The large types, which cool slowly, are cast slowly. The degree of heat required varies with the size of the body and the hardness of the metal. As a rule the smaller sizes are cast of harder metal and require greater heat.

Efforts have frequently been made to cast many types at one operation from a multiple mould. The most successful effort in this direction was made by Henri Didot of Paris, who in 1819 in-

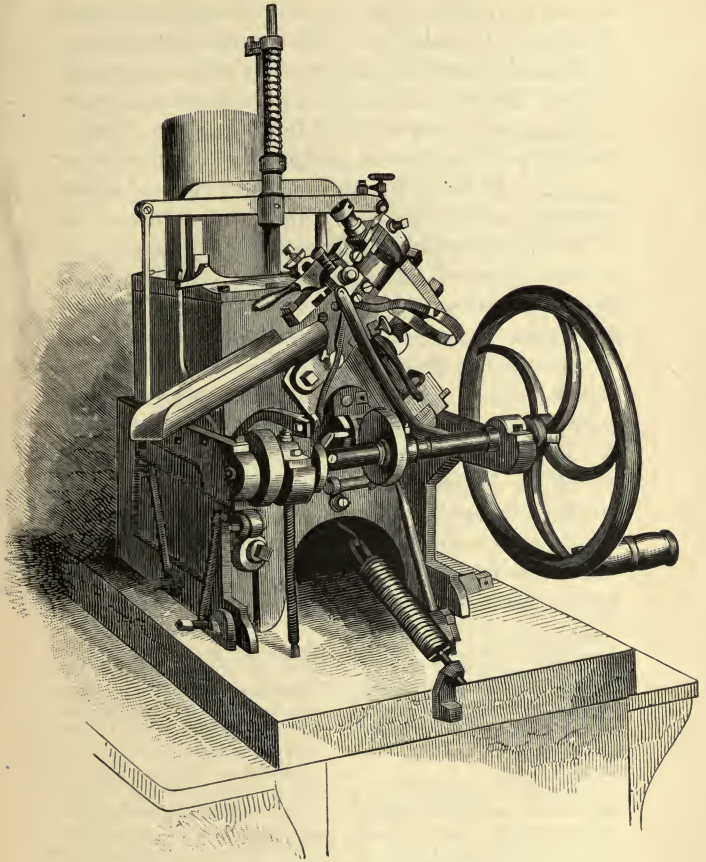

The Bruce type-casting machine.

vented a "polymatype" mould for casting a font of extremely small type ;¹ but this mould, although occasionally used by his successors for very small bodies, has not been adopted by other founders.

The types thrown out of the mould are for the greater part perfect as to face, but unfinished as to body, for an unformed strip of metal called the jet, which cools outside of the mould, is attached to the lower end of each type. The bodies of the types have on their corners burs,² or sharp edges of metal. These and other imperfections have to be removed by the rubber and dresser, or finisher.³ The jets are broken off, and the burs rubbed off on a grindstone, or dressing machine. Types with projections, like the f or j, are known as kerned letters, and are smoothed on the sides with a file, or by a machine in which a rapidly revolving wheel cuts away the superfluous metal without touching the projecting face. The types are then set up in a long row, and firmly fastened, face down, in a grooved channel

¹ British Patent No. 4826 to Louis John Pouchée. See the "Abridgement of Specifications relating to Printing," printed by order of the Commissioners of Patents, London, 1859, p. 165.

² The bur is produced by a slight and unavoidable leakage of metal at the angles of the mould. If the mould were set so tight that air could not escape

from the corners, the types cast therefrom would be porous with air bubbles. Provision must be made for escape of air when the mould is suddenly filled with a spurt of hot metal.

³ In 1838 and 1868 two patents were granted to David Bruce, Jr., for mechanisms which automatically broke the jet and removed the bur, but they were not adopted by type-founders.

called the dressing rod, so that a plane, working in carefully adjusted side bearings, can cut away the irregular fracture made by the broken jet. This operation leaves the types with a shallow groove between the feet, which allows each body to rest on its feet, thereby securing uniformity as to height. The dresser then reverses the position of the row, bringing the faces upward, and scrapes or files the front and back of the types, deftly changing them from one rod to another, so that front and back may be exposed in succession. This operation ends the smoothing of the types; their sides having been rubbed before they were set in the dressing rod. The line or rod of types is then critically examined under a magnifying glass, and every type that shows an imperfection is thrown out and destroyed. This inspection completes the work. The perfect types are then packed in paper convenient for handling.

This method of making types has been the method of all type-founders before the year 1850. Since 1890 new machines have been invented which do some of the work automatically. It is mainly in the department of casting the type that the greatest improvement has been developed.

Dressing or
finishing
of types

The earliest
method of
hand-casting

All types were formerly cast by hand. The caster took in his left hand the mould, which was imbedded in wood and shielded to protect him from being burned with hot metal. Then, taking a

spoon in his right hand, he poured the fluid metal into the mouthpiece of the mould.¹ At the same instant, with a sudden and violent jerk, he threw up his left hand to aid the melted metal in making a forcible splash against the matrix. If the mould was not thrown upward quickly, the metal would not penetrate the matrix. Hand-casting was hard and slow work: Fournier says that the production of a French hand-caster was from two to three thousand types a day; Moxon says the English caster cast four thousand.

Type-founding in some of its processes is but one of the many forms of printing. The counter-punch impresses the punch; the punch impresses the matrix; the matrix impresses the fluid metal.

¹ In 1811, Archibald Binny of Philadelphia devised the first improvement in hand-casting. He attached a spring lever to the mould, giving it a quick return movement, which enabled the type-caster to double the old production. In 1828, William Johnson of Long Island invented a type-casting machine which received the active support of Elihu White of New York; but the types made by it were too porous, and the mechanism, after fair trial, was abandoned. About 1834, David Bruce, Jr., of New York invented a hand force-pump attachment to the mould,

for the purpose of obtaining a more perfect face to ornamental type than was possible with the regular mould. This attachment was known as the squirt machine. Large ornamental types owe their popularity to this simple contrivance. In 1838, the same founder invented a type-casting machine, which was successfully used for many years in New York, Boston, and Philadelphia. In 1843 he added other improvements of recognized value. Most of the type-casting machines in Europe and America are modifications and adaptations of Mr. Bruce's invention.

For more than forty years the Bruce type-casting machine or some modification of it maintained its popularity, and furnished nearly all the type made during this period. Improvements of real value were gradually added to it in different foundries, but the changes did not materially increase its productiveness. Yet it has never been regarded as a perfect machine. Its great defect is its inability to make the types perfect. To break the jet off, to rub down the feather-edges, and to plough out the feet, manual labor has to be employed, as in the days of hand-casting. At different times Johnson & Atkinson of England, Foucher Frères of France, Hepburn of England, and Küstermann of Germany, invented new forms of type-casting machines that were intended to produce perfect types, but these machines have not been found entirely satisfactory by the type-founders of the United States. They have been most efficient in making spaces and quadrats.

The nearest approach to success has been made by Henry Barth, who was granted a patent January 24, 1888, for a complete type-casting machine. He claims that this machine produces one half more than the older machines; that it does its work with more accuracy, and that it permits the use of a harder quality of metal. Its construction and its processes differ radically from those of the Bruce machine. One half of the mould and the matrix

The complete
machine of
Henry Barth

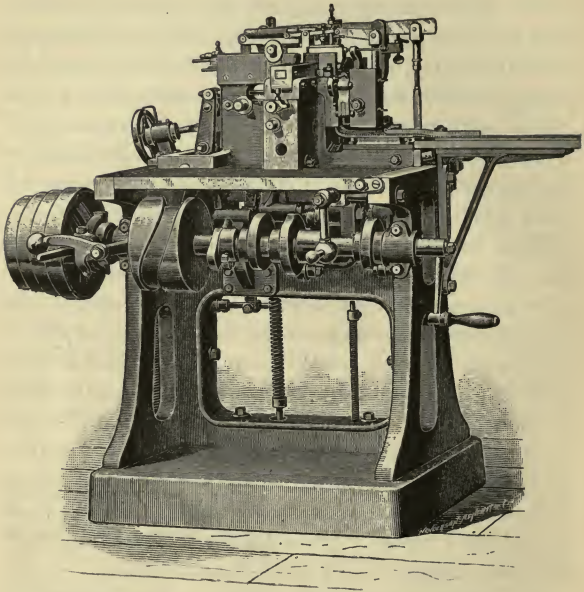

The Barth complete type-casting machine.

are fixed upright and made immovable; the other half of the mould rapidly slides to and fro on broad bearings, releasing the type that has been founded and closing again before the hot metal is injected for a new type. It breaks off the jet, ploughs a groove between the feet, rubs down the feather-edges at the angles, and delivers the types on the channel in lines ready for inspection.

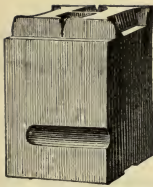

View of body inclined to show the face.



Letter H, from a type of canon body.

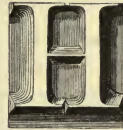

Face of the letter on the body.

- 1 counter.
- 2 hair-line.
- 3 serif.
- 4 stem, or body-mark.
- 5 neck, or beard.

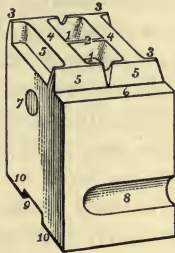

- 6 shoulder.
- 7 pin-mark.
- 8 nick.
- 9 groove.
- 10 feet.

Spaces of Pica

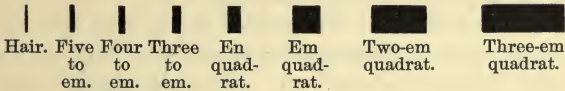

Dimensions of Bodies

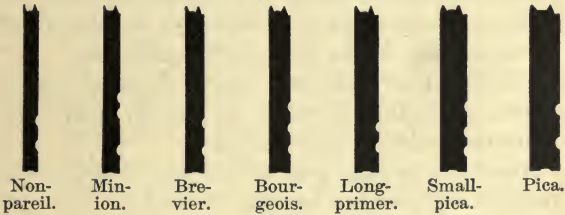

The face is the letter or character on the upper end of the type which receives impression. As its most notable feature, the word face is also used to distinguish one style of type from another, as broad-face or bold-face.

The beard, or neck, is the slope between the outer edge of the face and the shoulder.

The shoulder is the flat top of the small rectangle at the upper extremity of the body, which upholds the neck and face of the type.

The counter is the depression between the lines of the face. When the lines are in high relief, the counter is said to be deep; when low, the counter is shallow.

The body-mark, or stem, is the thick line of the face which most clearly indicates the character and the height of the letter. It is better known among printers as the thick-stroke.

The serif is the short cross-line put as a finish at the ends of unconnected lines. Its form varies with the style of face: in old-style lower-case letters it is a blunt spur or a stubby triangle; in the French styles it is a weak and delicate hair-line; in modern Scotch-faces it is curved or bracketed on the inner side, where it meets the main line.

The hair-line is the thin line of the face — as is shown noticeably in the C, H, and M — that connects or prolongs body-marks.

The kern is that part of the face which, on a few letters, projects beyond the body. The end,

or beak of the lower-case *f* and *j* and many italic letters have kerns, and are known as kerned letters. Kerns are also made on the descending letters of some forms of bastard faces.

The pin-mark is the small indentation on the upper part of the body made by the pin which is of service in dislodging the type from the mould.

The body is that part of the type which is between the shoulder and the feet. Early foundrymen and printers called it the shank. The word body is also used to define sizes or thicknesses of types, rules, leads, or furniture: Pica body means a thickness of about one-sixth of an inch. The sizes or bodies of type are now more accurately defined by numerical points.

The feet of the type are the two slight projections upon which the body rests. It is between these feet that the jet of the type-caster is made.

The groove is the hollow left between the feet by the planing tool that removes every trace of the broken jet.

The nicks are the shallow grooves across the lower part of the body. In American, English, and German types the nicks are on the front of the body; in French types on the back. Nicks are needed as plain guides to the position in which the types should be composed, and to prevent the mixing of different faces of the same body. Roman types of the same foundry and of the same body, but of different faces, usually have different nicks.

A font of type is a complete assortment of all the characters that will be required in the composition of an ordinary text.

Sorts is the name given to a partial collection of one or more of the characters of a font. It is most frequently applied to the types that are deficient.

Type-metal is an alloy of lead, antimony, and tin, and sometimes of copper and of other metals.

Every type-founder has his own formula which he keeps secret. Ordinary type-metal consists of one hundred pounds of lead, forty pounds of antimony, and twenty pounds of tin.¹ The metal for small type is harder than that used for large type; leads, spaces, and stereotype plates are always softer; the backing of electrotype plates is nearly all lead. Soft metal is also used to prevent the breaking of kerned letters. Ornamental types, which face or fill the matrices with difficulty, are also cast of a soft metal.

Lead is always the chief constituent of type-metal. Its specific gravity is 11.352; it melts at 617° Fahrenheit. Its density, ductility, and low fusibility make it easy-working, but types of pure lead are too soft for service.

¹ Fournier says his hard type-metal contained one-fifth of antimony to four-fifths of lead; his soft type-metal had one-eighth of antimony to seven-eighths of lead. He does not name tin. "Manuel Typographique," vol. i. p. 111.

In Germany the formula for cheap metal is seventy pounds of lead, twenty-eight pounds of antimony, and two pounds of tin; the formula for good metal is fifty pounds of lead, forty pounds of antimony, and ten pounds of tin.

Antimony, a brittle and fibrous metal that can be crushed to fine powder, is used to supply the hardness. Its specific gravity is 6.715; it melts at 806° Fahrenheit. Type-founders use the form of the metal known in commerce as the regulus of antimony, or standard antimony.

Tin is a crystalline but malleable metal, which has a specific gravity of 7.293, and melts at 442° Fahrenheit. It is used to give toughness to type-metal. It serves as a solder between metals fusing at varying temperatures. It oxidizes slowly, and prevents oxidization in its alloys.

Copper is used in small quantity to give still greater tenacity. Its specific gravity varies from 8.8 to 8.95; its melting point is estimated at 1996° Fahrenheit. A very small amount of copper in type-metal will give it a yellowish pink tint.

Moxon says that iron was an ingredient of the type-metal made in his time. Although melted with lead and antimony, its most efficient service was its extraction of the sulphur found in crude antimony; as then melted, it did not in any appreciable quantity mix with the other metals.¹

¹ The Mettal Founders make Printing Letters of, is Lead hardend with Iron: Thus they chuse stub-Nails for the best Iron to Melt, as well because they are assured stub-Nails are made of good soft and tough Iron, as because (they being in small pieces of Iron) will Melt

the sooner. To make the Iron Run, they mingle an equal weight of Antimony beaten in an Iron-Morter into small pieces and stub-Nails together they put for every three Pound of Iron about five and twenty pounds of Lead. "Mechanick Exercises," pp. 164, 167.

Zinc and some of the newly discovered metals have been tried as ingredients of type-metal, but in no case with success. Zinc is especially objectionable to type-founders. It has been found that an addition of one per cent. will make the alloy so refractory and so stringy that the metal cannot be founded.¹

The most remarkable peculiarity of type-metal is that it shrinks so little after being cast, a property not found to so great a degree in any other useful alloy. Harder metals, which must be melted at more intense heat, must necessarily shrink in a corresponding ratio, and this shrinking is injurious to accuracy. Nor do the harder metals so truly fill the mould, or make perfect casts.

The density of type-metal is a real advantage. Although melted at a comparatively low heat, it fills the mould and matrix with remarkable solidity, and reproduces the finer lines of the matrix with great exactness.

Another great merit in type-metal is its ability to resist oxidization. It takes much usage to dim its brightness; it does not rust like iron or steel, nor show corrosion like copper and brass. Types are necessarily exposed to the action of air, water, heat, lye, oils, inks, and alkaline solutions, but none of these agents works any serious injury.

¹A European type-founder advertises that he will not only refuse types brought to him as old metal that contain any admixture of zinc, but will prosecute the seller for damages.

These useful properties are gained only at the expense of durability. The hardest types soon wear out. When morning newspapers of large circulation were printed from the type, it was often found necessary to renew the fonts after a few months of service. To jobbing type the damage by wear is even greater: the beauty of script and hair-line types is sometimes destroyed by one month of service.

Ever since types were invented, founders have studied to make them harder and more durable. Great improvement has been effected, but a point seems to have been reached beyond which additional hardness is no longer an advantage. Every good founder could make his type harder, but only at vastly increased expense. A harder alloy would require greater heat to melt it; the metals used would be more expensive; the moulds and machines would wear out rapidly; the speed would be slower, and the type not so accurate.¹

Difficulties preventing the use of hard types

¹ French type-metal as made at the beginning of this century had 50 kilogrammes of lead and 18 kilogrammes of regulus of antimony.

Firmin-Didot experimentally made use of a mixture for stereotyping purposes of 20 kilogrammes of copper, 30 kilogrammes of tin, and 50 kilogrammes of regulus of antimony. Types made from this mixture were hard enough to

penetrate the plates of lead which were then made to serve for the stereotype moulds. For printing-types this mixture was materially "modified."

In 1840, M. Colson of Paris added iron and tin as ingredients of type-metal. ("L'Imprimerie, etc. Rapport du XVII^e jury," by M. Ambroise Firmin-Didot, Paris, 1854.) None of these mixtures is now in use in France or elsewhere.

The durability of types is materially affected by size and cut of face. With kind usage a font of pica may receive a million impressions before it will be condemned; with the same treatment a font of pearl may be worn out with less than a hundred thousand impressions. Yet the pearl is always of a harder metal. The difference in durability is caused by the difference in face. In the size of pica, the counters are broad and deep; the hair-line and body-mark will wear down and flatten out to a great degree before the face will show muddiness or illegibility: in the smaller size of pearl, the counters are necessarily shallow; the hair-lines and body-marks are thinner and closer together. It requires more impression to print the pearl properly; this impression, meeting with less resistance, soon wears down the thinner lines.

The amount of wear that types may receive cannot be stated in figures. One printer will consider them worn out when another will think them capable of further service. Brevier and minion have sometimes received two millions of readable impressions upon newspaper work, but the thick press-work from types worn by more than one million of impressions would be accepted only by a newspaper publisher. Many book publishers would reject small types that had received but three hundred thousand impressions. For the finest letter-press work, the limit would be

put very low. Typography with characters entirely faultless can be had only from new type. For type-founder's specimens and for sumptuous books new types are always provided. They are never reset, but are condemned to the melting-kettle after their first use.

The repeated handling of types is as injurious as the impression of the machine. One million of acceptable impressions may be obtained from small types skilfully made-ready if these impressions are taken from one form; but if the types are repeatedly distributed and reset for many different forms they will not furnish one-fifth of that number. The wear of types in the composing-room is much greater than is commonly supposed. They are bruised and battered in distribution and in composition, in making-up, and especially by planing-down and correction. The moulding process of stereotyping is remarkably injurious. Proving with a brush, or moulding by the papier-maché method, is more destructive, in most cases, than any kind of printing machine. Nor can a more destructive agent be found than the stiff scrubbing-brush which is used, often by unskilful hands, to clean the forms from ink after they have left the press.

Cylinder presses and type-revolving machines have been adjudged as very injurious to types. The noticeable wear of types on these presses is due more to the omission of making-ready — which

in the case of a morning newspaper is unavoidable—than to any inherent defect in the machine.

Wear caused
by neglect in
presswork

Cylindrical pressure need not, yet with careless hands it often does, grind off serif and hair-line much quicker than pressure of platens. But types well worn can be

used under cylinders longer than under platens.

Letters that have been rounded on the edges to such an extent that vertical pressure cannot give a readable impression are made fairly legible when they are printed on a rotary or a type-revolving

Rapid wear
avoidable

machine. This wear on types is often avoidable. A careful compositor and

a skilful pressman can make types do twice the service they give under the hands of careless workmen. The modern style of making-ready, which

dispenses with the thick woolen blankets that scrape and grind off the edges of the types, is of as great advantage to them as it is to the appearance of the printed work. On fine work a press-

man is now required to make, by overlays and underlays, the types practically parallel with the impression surface, so that the printed sheet shall show on the back only faint marks of impression. Yet careful making-ready is but a feeble safeguard

if paper has not been well selected and prepared. Rough-faced hand-made linen papers, half-beaten

straw or wood papers, and all papers that are laid, uncalendered, or of rough or ribbed surface, are, when printed dry, especially destructive to types.

The durability of types is also affected by their uncleanliness and the want of care they may receive. If they are not thoroughly cleansed immediately after taking proof or on leaving press, if dust and paper fibers are allowed to settle in the counters and harden with the drying ink, and if the sediment of the lye and turpentine used for cleansing is allowed to collect—a thick, tenacious deposit will soon be formed which cannot be removed without nearly destroying the type. The counters of a font of type so neglectfully treated will soon become filled up, and this may happen before the stems or the serifs have been appreciably thickened by the impression of the press.

The art of stereotyping is used as much to save needless wear of types as to save the expense of repeated composition. It adds nothing to the durability of the types, but it withdraws them from use, and furnishes a cheaper and more serviceable substitute. A mould in plaster or prepared paper is taken from a page of composed type, and this mould, when dry and hard, serves as the matrix for making the stereotype. The mould is then filled with melted type-metal, which, when hard, is a proper duplicate of the face of the composed type. The plate is thinner than the types, and costs much less, both for metal and for labor. It answers every purpose as well, and thus saves the types from needless wear.

Durability
promoted by
cleanliness

Stereotyping
saves wear

A large octavo page of long-primer type weighs about ten pounds and its types are worth about three dollars. The stereotype or electrotype plate taken from it weighs about twenty ounces, and costs about forty cents, but the metal therein has some permanent value. As stereotyping not only saves the type from needless wear, but also saves the expense of recomposition, it is freely made use of by all publishers in America. Its advantages are not confined to book printers; it is of decided economy in the printing of morning newspapers, when duplicated forms have to be put on two or more presses. Large editions of those publications could not be printed at all without the aid of stereotyping. Electrotyping, another process for securing the same result, has practically supplanted the stereotyping of book work.

If the type used in printing a book is distributed before stereotyping, of course the composition is not available for even one more edition; but if the forms have been stereotyped, the labor of composition is saved for any number of editions, because the plates used on the first edition may be used on twenty successive editions without repeating the expense of the original composition. After stereotyping, the types may be distributed and rearranged in many other combinations. The plates are unalterable. The advantages of stereotyping or electrotyping are equally beneficial to both printer and publisher,

saving the type of one and lessening the expenses of the other. In the United States all books that may be reprinted are electrotyped.

The process invented in 1851 by Dr. Newton of New York, which is known as copper-facing, is of value in making types more durable. The faces of the types to be treated are immersed in a solution of copper. Under the influence of a galvanic current atoms of copper are deposited on them, covering every part with a thin film. This deposition continues from three to twelve hours, according to the strength of the battery and the nature of the work. When taken from the bath the types so exposed are ready for use. Types that have been copper-faced are made more durable, not by the superior hardness of the copper, for the coating is too thin to offer any great resistance to impression, but by its superior tenacity. The stems and delicate serifs may be flattened under pressure almost as readily as before the operation of copper-facing, but they cannot be broken or gapped as easily.

The process of copper-facing differs from that of electrotyping in a very important point. In the electrotype, the atoms of copper attach themselves to, and duplicate, the smooth face of the mould, and this smooth-faced duplicate becomes the printing surface. But in copper-facing these atoms attach

Copper-facing
differs from
electrotyping

themselves to the smooth surface of the types, and adhere to it, leaving the rough, crystallized upper side of the deposit as the printing surface. This rough surface is often objectionable. The earliest impressions from copper-faced type are never as perfect as those from the uncoppered type. There is always more or less thickness and unevenness of face, which can be removed only by continued use. For newspapers copper-facing is of great value; for the finest work it is not to be so highly commended. The expense of copper-facing a font of roman types is about one-sixth of the type-founder's charge for the type.

Hardness of metal is usually considered as of great importance in types. The quality of the metal is roughly, but not always accurately, tested by breaking a type. If this bends very much before breaking, showing a ragged fracture, or if it, when whittled, curls up in unbroken rings, the metal is soft. If it breaks off short, after much resistance, showing a close, crystalline fracture, the metal is hard; but if it, when whittled, crumbles at a slight touch the metal may be hard but is deficient in tenacity. Great hardness, without tenacity, is as serious a fault as too much softness. Types that easily break when dropped upon the floor, or that have their serifs and hair-lines gapped by planing-down or by rubbing with a brush, betray an excess of antimony and a deficiency of tin or copper.

The test of
hardness in
type-metal

Solidity is equally important. It is a material fault if the broken types reveal minute bubbles or porousness, either in the face or the ^{solidity} body. This defect was common to all types ^{of type} made by the early casting machines which were imperfect, but it is now exceptional.

As all the characters of a font of type are usually cast in but one mould, which is tested daily and oftener, there is not much liability to inaccuracy in the body of a font so cast.¹ But when a large font of types is cast in haste from two or more matched moulds there is an increased liability to error. Sorts, or additions to a font, made at any time after the first casting, may be slightly inaccurate. Types may be cast thinner at the foot than at the shoulder, and this fault may be increased in rubbing down, or finishing; but bottled types, as these are called, are now unusual.

Every letter in a font should present the appearance of standing even in line with all its fellows. The maintaining of this evenness of ^{Even lining of} line, apparently so simple, is one of ^{importance} the nice parts of a type-founder's work. One reason, but not the only one, why the Latin text, *Quousque tandem abutere, Catilina*, was used so

¹At the International Exhibition of 1851, a prominent type-founder of London exhibited a form of pearl types containing 220,000 characters. For twenty-one weeks this form was kept in a chase in horizontal position, upheld by supports one at each corner of the chase, so that each type was exposed to the air on both face and feet. The casting was so true that no type fell out.

frequently by type-founders in their specimens, was that Latin, as compared with English, had an excess of small and a deficiency of ascending and descending letters. Types composed in Latin had a more symmetrical look and an even line than could be produced from an English text. Modern founders, confident of their superior ability, do not hesitate to show their types in English.

These types show an uneven lining in the letters n and e; the n too high, the e too low.

The deviation in lining here shown is enough to destroy the appearance of the font.

Uneven lining will be most frequently noticed in sorts, or the new letters that are cast to supplement a deficient old font. The new letters may be made out of line by the founders, but this rarely happens when lining letters are sent. The uneven line is more frequently caused by accretions to the body of the old type, which have been made through want of cleansing from dust and ink. Before new types are mixed with old, they should be tested by setting them in vertical lines, between rows of old type, as shown in this illustration.

AAA
AAA
AAA
AAA
AAA
AAA
AAA
AAA
AAA
AAA

The fitting-up of type, which is the founder's term for adjusting the face upon the body, is of highest importance. The set of the mould is altered with almost every change of the matrix, and

In these lines the e has too much space at the left, the a too much at the right; the t is too close at the right, the h too close at the left.

if this alteration is not intelligently done, some types will be too wide, and others too narrow. A font of type so fitted-up will exhibit ungainly gaps between some letters, and a confusing proximity between others, as is shown in illustration above.

Bad fitting is sometimes shown in letters the stems or thick-strokes of which lean slightly from a vertical line, either to the right or to the left.

In these lines the letter t leans to the right, and the letter e leans to the left.

This fault is exceptional in roman, but is not at all infrequent in some of the older fonts of italic.

A bad fitting-up of matrices to the mould is occasionally shown in the unequal heights in line of the different characters of the same font. This irregularity is seldom noticeable in the types of an entirely new font, but it may and often does occur in the sorts or additions cast subsequently.

In these lines the letter o is
too high; the letter t is too
low; the letter h is tilted out
of perpendicular on one side.

Unequal height is a more frequent fault since a recent change in the height to paper of type-bodies from .9166 to .918 inch. The difference of but one five-hundredth of an inch may be almost imperceptible when types of these heights are printed together on damp paper against an elastic impression surface, but it is a fatal fault when these types are printed on dry paper against a hard surface. To bring up the low types the over-high types will be crushed. A new font which contains characters of unequal heights to paper will show from the beginning many of the blemishes of a worn-out font. Unequal heights to paper should be watched for in all types cast from old electrotyped matrices that have been unequally worn. The process of copper-facing tends

to make types of unequal heights by an occasional uneven deposit of copper.

An improper fitting of the face on the body is a very serious fault. For its legibility each character needs a fair relief of white space outside its stems. The distance between the stems of all the types in a word should be reasonably uniform. As a rule this distance is most satisfactory when the space between the stems of meeting letters is about the same as that between the stems of the letter *m*. This is not always practicable, for letters are irregular as to shape, and a nice discretion must be exercised by the fitter-up, who has to consider the combinations of these irregular shapes. As a rule condensed type and small type need close fitting; fat and expanded type a wider fitting.

The types of this column are close-fitted, but they are as readable in solid as in leaded composition. Nor is the appearance of the composition damaged by close or thin spacing. Each letter is distinct, although some letters nearly touch their fellows at extreme points.

The types of this column are wide-fitted. Each letter is separated from its fellows, but the composition has an uninviting appearance. It is not easier to read. It cannot be thin spaced nor set solid to advantage, nor is it improved in any way by wide leading.

The mechanical finish should be of the highest order. Good types should be so carefully rubbed and dressed that there will be no burs or roughness on the edges to cut the fingers of the compositor. The shoulders should be low enough on the body to prevent their being blackened by the inking roller, and to allow the

Good finish is important

kerned letters to lap over without interference. The kerns should be well supported so that they will not break under proper treatment. The nicks should be clearly defined, and different either in number or in position from those of other faces or styles of the same body. The hair-lines and serifs should have a sloping base, to give them a proper support. The counters should be deep enough to prevent their quick filling-up with ink and paper dust.

Italic type needs special examination: blemishes in fitting-up are more frequent in italic than in the roman of which it is the mate. A font of italic should not only be in line with the roman, but should show all its features as far as the change of face will permit. In the early practice of type-making, one face of italic was often made to serve for two or more faces of roman. This practice has not been entirely discontinued. A light-faced italic is sometimes mated with a heavy-faced roman, a condensed italic with a round-faced roman, making a plain change of shade or of shape on the printed page where they are used together.

The choice of the face is usually decided by its appearance on the specimen sheet, but some regard should be paid to its mechanical adaptation to the work for which it is designed. The appearance of a face will vary with methods of presswork. That which is just

bold enough in the carefully printed specimen of the type-founder will be too bold in the newspaper when printed with soft ink and upon coarse and moist paper; and one that seems light enough on damp paper is altogether too light and weak when printed on dry paper.

Whatever face may be selected, it should be mechanically well cut: the angles should be true; the serifs of uniform length; the body-marks of uniform width; and a visible harmony should pervade the font. A perfect font of types should produce a general effect in any combination of characters.

Types must
be pleasing
in a mass

This face wears This endures

It is not enough that each character seems pleasing when examined apart from its mates; it must also be pleasing in composition. This cannot be if all the difficulties of combination and fitting have not been foreseen and provided for. Rudely cut or badly fitted type will mar the effect of the best composition and presswork.

The durability of type is affected by the press on which it is printed. Types with long ascenders

and descenders, and with very long and sharp hair-lines and serifs, are not well suited for cylinders or for type-revolving machines, because all the force of the impression is at regular intervals spent

A face with long and feeble serifs

on the serifs and edges of these projecting letters. To secure the highest durability on cylinder machines, types with short ascenders and descenders, broad faces, and stubby serifs should be selected.

Bold, black-faced types are not, for general use, as durable or even as readable as those that have

A bold-face with hair-lines and serifs too weak

lighter stems, firmer serifs, and a more open appearance. The common opinion that all light-faced types are necessarily fragile is derived from an experience obtained when letter-cutting was not as

skilfully done as it is now. The light-faced types of thirty years ago were made with hair-lines and serifs that were long, sharp, and feebly supported, that gapped with slight abrasion, and that broke off altogether under an uneven impression. Approved modern light-faced types are radically different: the hair-lines are supported by broad bases, and the serifs are strengthened with bracket-like curves where they join the stems or body-marks. These hair-lines will thicken very little with continual wear, and are not liable to gap or to break down.

Bold-faced
and light-
faced types

A light-face that has both firm hair-lines and bracketed serifs

In deciding upon the comparative durability of a light-faced and a heavy-faced type, two points must be considered: the force necessary to secure a perfect impression, and the resistance opposed by the type to that force. They necessarily increase and decrease in inverse ratio. A solid tint-block presents a greater resistance and requires more impression than the same surface of type; a page of antique type cannot be faced with the same impression

Light-faced
types may
be durable

that will fairly print a page of script. The denser or broader the face, the greater is the resistance, and the stronger must be the impression. Upon a page of bold roman type this impression must be felt equally on the hair-lines and body-marks. When an elastic blanket is forced by impression into the counters and around the edges of each face, the hair-lines will be gapped, the serifs will be gradually broken down, and the surface of the body-marks will be rounded off. The resistance of light-faced type is less; so less force is required in

A bold-face with short serifs that soon show wear

impression, and it is more equally divided between hair-lines and body-marks. A light-faced type properly cut will lose its sharpness sooner, but it will wear down with more evenness, and will present a clear outline when the hair-line of a bold-faced letter has been worn out, and the character can be identified only by its stem or body-mark.





II

The Names of the Leading Sizes of Types

WHEN the faces of text-types were limited to roman, italic, and black-letter, one or two words described the size, or body, and another word defined the face. The multiplication of faces now compels founders to make names longer and more descriptive. The features are usually given in this order: (1) The body or size of the type, as "Pica." (2) The style or face of the type, as "Pica gothic." (3) The ornament or fashion of the type, as "Pica gothic ornamented."¹ (4) The shape of the type, as "Pica gothic ornamented condensed."

The names of the more important bodies or sizes of types are given in the following tables:

¹ See a following chapter for remarks on different styles.

| American | | English |
|------------------|--------------------------|-----------------------|
| New Name | Old Name | |
| 60-point | Five-line pica | Five-line pica |
| 48-point | Canon, or four-line . . | Canon, or four-line |
| 44-point | Meridian | Two-line double pica |
| 40-point | Double paragon | |
| 36-point | Double great-primer | Two-line great-primer |
| 32-point | Four-line brevier | |
| 30-point | Five-line nonpareil | |
| 28-point | Double english | Two-line english |
| 24-point | Double pica | Two-line pica |
| 22-point | Double small-pica . . | Double pica |
| 20-point | Paragon | Paragon |
| 18-point | Great-primer | Great-primer |
| 16-point | Columbian | Two-line brevier |
| 14-point | English | English |
| 12-point | Pica | Pica |
| 11-point | Small-pica | Small-pica |
| 10-point | Long-primer | Long-primer |
| 9-point | Bourgeois | Bourgeois |
| 8-point | Brevier | Brevier |
| 7-point | Minion | Minion |
| 6½-point | Minionette | Emerald |
| 6-point | Nonpareil | Nonpareil |
| 5½-point | Agate | Ruby |
| 5-point | Pearl | Pearl |
| 4½-point | Diamond | Diamond |
| 4-point | Brilliant | Brilliant |
| 3½-point | | |
| 3-point | Excelsior | Minikin |

| <i>French</i> | | <i>German</i> |
|------------------|------------------------|---------------------------|
| New Name | Old Name | Old Name |
| Corps 72 | Triple-canon | Kleine Sabon |
| Corps 60 | | Grobe Missal |
| Corps 56 | Double-canon | |
| Corps 52 | | Missal |
| Corps 48 | | Kleine Missal |
| Corps 44 | Gros-canon | |
| Corps 42 | | Grobe Canon |
| Corps 36 | Trismégiste | Canon |
| Corps 32 | | Kleine Canon |
| Corps 28 | Petit-canon | Doppel Mittel |
| Corps 24 | Palestine | Doppel-Cicero |
| Corps 22 | Gros-parangon | |
| Corps 20 | Petit-parangon . . . | Text |
| Corps 18 | Gros-romain | |
| Corps 16 | Gros-texte | Tertia |
| Corps 14 | Saint augustin . . . | Mittel |
| Corps 12 | Cicero | Cicero |
| Corps 11 | Philosophie | Brevier |
| Corps 10 | Petit-romain | Corpus, or Garmond |
| Corps 9 | Gaillarde | Borgis, or Bourgeois |
| Corps 8 | Petit-texte | Petit |
| Corps 7 | Mignone | Colonel |
| Corps 6½ | | |
| Corps 6 | Nompareille | Nonpareille, or Nonpareil |
| Corps 5½ | | |
| Corps 5 | Parisienne | Perl |
| Corps 4½ | Diamant | |
| Corps 4 | | Diamant |
| Corps 3 | Semi-nompareille | |

In France the old names have been out of use for many years, but it seems necessary to repeat them here, for they are to be found in all the early books of typography, and even in some comparatively modern specimen books of French type-founders. In Germany the use of numerical names is limited.

56 *Italian, Spanish, and Dutch Names*

| <i>Italian</i> | <i>Spanish</i> | <i>Dutch</i> |
|---------------------|---------------------|---------------------|
| Imperiale | | |
| Reale | Cinco Lectura | |
| Duale | Cuatro Lectura | |
| Corale | Cánon | Parys Kanon |
| Canone | Doble Parangona . | Groote Kanon |
| Sopracanoncino . | Doble Texto | Kanon |
| Canoncino | Doble Atanasia .. | Dubbelde Augustijn |
| Palestina | Doble Lectura . . . | Dubbelde Mediaan |
| Ascendonica . . . | Doble Lecturita .. | Assendonica |
| Parangone | Parangona | Paragon |
| Testo | Texto | Tekst |
| Soprasilvio | San Agustin | |
| Silvio | Atanasia | Augustijn |
| Lettura | Lectura | Mediaan |
| Filosofia | Lecturita | Dessendiaan |
| Garamone | Entredos | Garmond |
| Garamoncino . . . | Medio Texto | Burgeois, or Galjar |
| Testino | Breviario | Brevier |
| Mignone | Miñona, or Glosilla | Collonel |
| Nompariglia | Nomparell | Nonpareil |
| Parmigianina . . . | Perla | Parel, or Joly |
| Diamante | Diamante | Diamant, or Robijn |
| Oecchio di mosca . | Brillante | |

In Italy, Spain, and Holland the numerical names of types on the point system have been partially adopted, but they are not yet so fully established as to put all old names out of use. These Italian names have been

collected from the "Manuale Tipografico" of Bodoni (Parma, 1818); the Spanish and Dutch names have been gathered from specimen books, and from information given to the author by Spanish compositors.

In the preceding tables an attempt has been made to arrange the names given to types by each nation in line with those given to similar sizes by other nations; but a similarity of name, or position on the same line, does not mean that types so named or placed are of exactly the same body. Large allowances must be made for variations. In making a comparison of types or sizes from various countries, the difference in bodies below pica is too slight to be noticed by an inexperienced, but in those larger than pica the difference may be marked, and the similarity of names may be seriously misleading.

Types have been made and named everywhere without system. The exceptions are few. Paragon and nonpareil have virtually the same name in the foundries of all nations cited; canon, pearl, and diamond are almost as widely known.

The list given comprises all the bodies known by simple names. All sizes above canon are called by their multiples of pica, as five-line, nine-line, etc., names which indicate that the bodies so defined are five or nine times the height of a pica body.

Bastard types are those with faces too large or too small for the body: a minion face upon a nonpareil body, or a brevier face upon a bourgeois body, is a bastard size. A small face is sometimes cast on a large body to give the open appearance of leaded type, and a large face is sometimes cast on a small body to make the print more

compact. The bastard types are not highly esteemed, and are now made only to order. These

Nonpareil on Agate.

The types of this paragraph are upon agate body, but the face is a very large nonpareil. The tails of the descending letters, g, j, p, q, y, have been shortened. Notice the narrowness of the white space between all the lines. This type was made for a directory with an intent to get the largest possible face of type within the smallest space.

Agate on Nonpareil.

The types of this paragraph are of the ordinary agate size, but the space between the lines is less than the thickness of any practicable lead, and shows the body of nonpareil. The object sought in putting agate upon nonpareil is to give it the effect of leaded type without the use of leads, and to make the print more readable.

methods of putting a large face on a small body, or a small face on a large body, make it difficult even for an expert to identify the body of any type so treated. There is no accepted standard of height for the short or round letters of any face, but it may be assumed, as a general rule, that long ascenders and descenders belong to a face which is small for the body, and that short ascenders and descenders belong to a face which is large for the body.

A distinction is made by type-founders between regular and irregular bodies. The regular bodies are pearl, nonpareil, brevier, long-regular and irregular bodies of type primer, pica, great-primer, and all multiples of pica. They are called regular because they are the bodies that have been preferred and have been most in use. The irregular bodies are diamond, agate, minion, bourgeois, small-pica, english, and all their multiples. They are called irregular because most of them were unknown to Moxon and the early English printers.

The distinction is more fanciful than real; in some printing offices the irregular sizes are in greater use. Display and ornamental types are usually cast only on the regular bodies, and for this reason it is of advantage to give them a preference.

American type-founders give separate names to two-line types and double-bodied types. A two-line pica and a double pica have the same body. The face of the two-line type occupies nearly the whole of the body; the capital of a double-bodied type is much shorter, and terminates on a broad shoulder. The

Two-line
types and
double types

Hardy **H**ERE is a
Two-line

Double great-primer
capital and lower-case.

Two-line great-primer capital
with two lines of great-primer.

double-bodied letter is usually accompanied with lower-case, for the descending letters of which this broad shoulder is provided. The two-line letter is usually of capitals only, and is or should be so put on its body that as an initial letter it will line with the second line of the small text-type of which it is the duplicate. In England this distinction is not so well observed. The double pica of English type-founders appears to be the equivalent of our double small-pica; and what they call two-line pica is our double english.

| | | |
|----------------------|---|---|
| Brilliant. | ABCDEFGHIJKLMN OP QRSTUVWXYZ | ■ |
| Diamond. | ABCDEFGHIJKLMN OP QRSTUVWXYZ | ■ |
| Pearl. | ABCDEFGHIJKLMN OP QRSTUVWXYZ | ■ |
| Agate. | ABCDEFGHIJKLMN OP QRSTUVWXYZ | ■ |
| Nonpareil. | ABCDEFGHIJKLMN OP QRSTUVWXYZ | ■ |
| Minion. | ABCDEFGHIJKLMN OP QRSTUVWXYZ | ■ |
| Brevier. | ABCDEFGHIJKLMN OP QRSTUVWXYZ | ■ |
| Bourgeois. | ABCDEFGHIJKLMN OP QRSTUVWXYZ | ■ |
| Long-primer. | ABCDEFGHIJKLMN OP QRSTUVWXYZ | ■ |
| Small-pica. | ABCDEFGHIJKLMN OP QRSTU | ■ |
| Pica. | ABCDEFGHIJKLMN OP QRS | ■ |
| English. | ABCDEFGHIJKLMN OP | ■ |
| Great-primer. | ABCDEFGHIJKLMN C | ■ |
| Double small-pica. | ABCDEFGHIJKL L | ■ |
| Double pica. | ABCDEFGHIJK L | ■ |
| Double english. | ABCDEFGH H | ■ |
| Double great-primer. | ABCDEF C | ■ |
| Double paragon. | ABCDE E | ■ |
| Canon. | ABC CT | ■ |

The black squares show the em, or square of the body.

| | | |
|----------------------|----------------------------|---|
| Brilliant. | abcdefghijklmnopqrstuvwxyz | ■ |
| Diamond. | abcdefghijklmnopqrstuvwxyz | ■ |
| Pearl. | abcdefghijklmnopqrstuvwxyz | ■ |
| Agate. | abcdefghijklmnopqrstuvwxyz | ■ |
| Nonpareil. | abcdefghijklmnopqrstuvwxyz | ■ |
| Minion. | abcdefghijklmnopqrstuvwxyz | ■ |
| Brevier. | abcdefghijklmnopqrstuvwxyz | ■ |
| Bourgeois. | abcdefghijklmnopqrstuvwxyz | ■ |
| Long-primer. | abcdefghijklmnopqrstuvwxyz | ■ |
| Small-pica. | abcdefghijklmnopqrstuvwxyz | ■ |
| Pica. | abcdefghijklmnopqrstuvwxyz | ■ |
| English. | abcdefghijklmnopqrstuvw | ■ |
| Great-primer. | abcdefghijklmnopqrstuv | ■ |
| Double small-pica. | abcdefghijklmnopqr | ■ |
| Double pica. | abcdefghijklmnop | ■ |
| Double english. | abcdefghijklm | ■ |
| Double great-primer. | abcdefghij | ■ |
| Double paragon. | abcdefg | ■ |
| Canon. | abcdefg | ■ |

The black squares show the em, or square of the body.

The alphabets on pages 60 and 61 show the sizes of standard types and their relative proportions.

Canon, or 48-point, is four times the height and sixteen times the area of the standard size of pica.

Canon It was so called from its early employment in the leading lines or paragraphs of the printed canons of the Church, as is also indicated by its German name of missal. The canon of the English type-founders is usually a face of about three lines of pica cast on a four-line pica body. The face of full height on four-line pica body is called four-line.

Meridian (four heights of small-pica), or 44-point, is a body rarely selected for letters, and has but a limited use for combination borders.

Double paragon (four heights of long-primer), or 40-point, was a favorite for ecclesiastical printing. The larger types of the famous "Psalter of 1457" are on this body.

Double great-primer (four heights of bourgeois), or 36-point, is a body largely used for ornamental types.

Four-line brevier, or 32-point, is never used for text-types; only for borders or ornamental faces.

Double english, or 28-point, is a body, seldom selected for text-types, but largely used for script and ornamental letters.

Double pica, or 24-point, is a favored body for all faces. English type-founders describe it as two-line pica.

Double small-pica, or 22-point, is a body in frequent request, but most preferred for ornamental faces. It is known in England as double pica.

Paragon (double long-primer), or 20-point, is a body seldom selected by any American or English founder, yet it has distinction as a size favored by William Caxton as well as by ^{Paragon} the printer of the "Bible of 42 lines." The name of paragon is now out of use in Germany, but 20-point type is there known and much used under the name of text.

Great-primer (double bourgeois), or 18-point, is a favorite body for the text-types of large quartos and folios, as well as for ornamental faces. ^{Great-primer} Its size, one-half more than that of pica, or 12-point, permits it to be freely used with pica and nonpareil in combination borders. The name is of doubtful origin, but it is probably derived from use of the type on a large leaf. Rowe Mores says that great-primer was a favorite size with early English printers, and the size preferred for some large primer of the English Church.¹

¹ It was also known as Bible-text from its frequent use in Bibles. Henry VIII allowed his subjects to use an English Form of Public Prayer, and ordered one to be printed for their use, entitled the "Primer," which contained, besides the prayers, several psalms, lessons, and anthems. "Primers" of the English Church before the Refor-

mation were printed at Paris as early as 1490, and in England in 1537. (Reed, "English Founders," p. 37, note.) Reed suggests that Primer may be from the Latin *primere*, to print, and naturalized in England under the name of "imprimery." Great-primer may be the great print letter. In Holland, Italy, and Spain it was called text.

Columbian (double brevier), or 16-point, is a neglected body, first made in text-type by George Bruce of New York to supply a size that seemed to be needed between english and great-primer. It is not a regular body for book-type.

English (double minion), or 14-point, is one of the oldest of bodies, the one selected for the "Letters of Indulgence of 1453," by some un-^{English} known printer at Mentz, and also by an early printer in the Netherlands. It has the name english because it was so extensively used by early English printers for their law books, acts of Parliament, and exclusively English work. Germans call it mittel because it is the middle or intermediate of the seven sizes of type in greatest use. It has been a body of marked irregularity; before the adoption of the system of points in France and Germany it varied from 15 to 13 points.

Pica (double nonpareil), or 12-point, is a favorite body for important works in octavo. The pica ^{Pica} body has been, and still is, the standard unit for determining sizes. All the larger sizes of type above four-line, and all the more important widths of furniture, are made to bodies that are regular multiples of pica; all thicknesses of leads, and sometimes of brass rules, are graduated to divisions of pica, and are called by the divisors, as four, six, eight, or ten to pica. Like great-primer, it takes its name from its early use as a text-letter. "The Pie" (of which the word Pica

is the Latin name¹), writes Mores, "was a table showing the course of the services of the Church in the times of darkness. It was called the Pie because it was written in letters of black and red, as the *Friars de Pica* were so named from their parti-coloured raiment black and white, the plumage of a magpie."

Small-pica (double agate), or 11-point, is one of the so-called irregular bodies which an early writer on printing thought unworthy of a place in any printing office; but type-founders now find that it is in greater request in book-printing offices than the regular body of pica.

Long-primer (double pearl), or 10-point, is another body which takes its name from its early use in ecclesiastical books.² The name was probably given first to the size of the leaf, the long duodecimo, on which the services of the Church were printed without abbreviation, and secondly,

¹ Mores gives this quotation from a Breviary of Sarum, as printed in 1555:

¶ Incipit ordo breviarij feu portiforij fecundum morem & confuetudinem ecclesie Sarum Anglicane: vna cum ordinalifuo quod visitato vocabolo dicitur *Pica* five directorium sacerdotum in tempore paschali.— Pars Hyemalis. (Rowe Mores, "English Founders," p. 23.) He also gives on p. 24 the title of the *Directorium sacerdotum quem [librum] Pica Sarum vulgo vocitat*

clerus, as a book frequently reprinted by the English printers. Caxton advertised the "Pyes of Salisbury use." Reed suggests that Pica may refer to the black-and-white appearance of a printed page.

² Rowe Mores quotes the title "A Prymer of Salisbury use set out a long by Robert Valentine at Rouen, in the year 1555," as explaining its origin. But the type of this book is pica, and not long-primer. ("English Founders and Founderies," p. 26.)

to the smaller type, which was more serviceable for a leaf of this shape. It continues to be the body preferred for duodecimos.

Bourgeois (double diamond), or 9-point, possibly gets its name, as Reed suggests, from the French city of Bourges. Bourgeois was not first made there, for it is the body of the text-letter of the "Compilatio Decretalium" of Pope Gregory IX, printed by Torresani, at Venice, in the year 1498. The name may be derived from the frequent selection of this body for the small and cheap books made for the bourgeoisie.

Brevier (double brilliant), or 8-point, carries a name that suggests its early employment in the printing of breviaries.¹ The notes of the Decretals referred to in the previous paragraph are in types of brevier body.

Minion, or 7-point, is one of the irregular sizes, and is now in small request, except for newspaper work. Its name indicates the esteem in which it was once held, not only by English, but by French and Italian typographers, as a small and valued darling of a type.

Minionette, or 6½ point, is a body largely used in France for combination borders. The adoption of the borders in the United States compelled the

¹ Reed says that most of the breviaries are in types of larger size, but this remark can apply only to the finely printed ones which have been preserved. Many of the cheap and more popular editions must have been worn out by long usage; some of these editions must be unknown to bibliographers.

adoption of the same body, but it is now passing out of use. It seems to be the equivalent of the English emerald, which is used as a text-type.

Nonpareil, or 6-point (the half of pica), is the most used of the small bodies. It seems to have been made for the first time in 1490 by John Froben of Basle, for a black-letter ^{Nonpareil} octavo edition of the Bible. It first appeared with a fine roman face in a beautiful manual of services of the Roman Catholic Church printed at Venice in 1501. It was probably adjudged a marvel of skill in letter-cutting, for it has preserved its name in all countries.

Agate, or 5½-point (the half of small-pica), is a favorite size for newspaper advertisements, and for all kinds of printing in which great compactness is desired. It is known in England as ruby.

Pearl, or 5-point (the half of long-primer), finds employment in pocket editions of the Bible, prayer-books, and small manuals, as well as for side and cut-in notes and references. The celebrated printer Jannon made it famous by selecting it in 1627 as the text-type of his so-called "Diamond" editions, printed by him at Sedan.

Diamond, or 4½ point (the half of bourgeois), seems to have been made for the first time by Voskens of Amsterdam, who cut a full font of ^{Diamond} it about the year 1700. Van Dijk, the type-founder for Daniel Elzevir, had shown in 1681 a size smaller than pearl, but it was not so small as

Voskens's diamond. Pickering of London selected this body for his miniature editions of the classics.

Brilliant, or 4-point (the half of brevier), is a size of this century. One square inch of ordinary composition in brilliant contains about 1200 pieces of metal: of the lower-case i, 3456 are needed to make one pound in weight; of the thinnest space, nearly twice as many.

Excelsior, or 3-point (the half of nonpareil), is a body used in America for music, piece-fractions, and borders only. It seems to be the same body as the English "minikin."

Yet there is a text-type still smaller. In 1827 Henri Didot of Paris, then sixty-six years old, cut with his own hands a font of type on the body of $2\frac{1}{2}$ points by the Didot system, which he called "microscopique." Twenty-five lines of this type apparently fill the space of one American inch.

The founder Gronau of Berlin shows three text-types (roman, italic, fractur) cut for a 3-point body but cast for convenience on that of a 4-point.

The Enschedé Foundry of Haarlem has cut a still smaller face, a "non-plus-ultra," on a 2-point body, but it is cast on a 4-point body.

These types are wonderful as evidences of skill; but they are of slight value in the practice of printing.

The general effect of the sizes most used in ordinary composition is shown in the following illustrations.

Oldest
verified
print is
(The woodcut of St. Christopher)
of date
1423

The old-
est type
Printing
(Letters of Indulgence)
has writ-
ten date
of 1454 

The earliest
types are of
English and
Double pica
bodies: they
were found-
ed in moulds

❖ The earliest book bearing a printed date is the famous Psalter (1457) published by John Fust and his son-in-law P. Schœffer ❖

The types of the PSALTER made in 1457 were cast on the bodies of double paragon and double great primer, and the book was decorated with red ink and large initials.

❖ A Bible in types of paragon body, 42 lines to a page, has a certificate that its illumination was done at Mentz, A. D. 1456. Another Bible, of 36 lines, from types of double pica body, is believed to have been printed between the years 1450 and 1459, at the same old city.

¶ Certain books known to have been printed at or near Mentz and before the year 1460, and in different sizes of type from double paragon down to english, show that the methods of type-making and printing were in regular use. The imprint of the Psalter of 1457 says that book was made by the “masterly invention of printing and also of type-making.” ¶

What was this invention of type-making? Ulric Zell, writing in 1499, says that this masterly and subtile invention was “the art as it is now used.” Trithemius, in 1514, declared that this invention was “the method of founding the forms of all the letters which they called matrices, from which they cast the metal types.” Peter Schœffer, in the “Grammatica” printed by him at Mentz, says metaphorically of the book, “I [this book] am cast at Mentz.”

Bernard Cennini of Florence, writing in 1471, declares that the characters of his books were first cut and then cast. Nicholas Jenson of Venice, in a book dated 1485, says that the types of his book were cut and cast by a divine art. An account book of the Ripoli Press at Florence, 1474—1483, specifies the metals and the materials now used in type-foundries. The art then practised was “the art as it is now used.”

Ulric Zell says that John Gutenberg, a citizen of Mentz, was the inventor of printing. Trithemius says "the admirable and till then unheard-of art of printing books by types was planned and invented by John Gutenberg." John Schœffer, the son of Peter, in 1505 declared that the admirable art of typography was invented in the year 1450 by the ingenious John Gutenberg. A tablet near his tomb, put up soon after his death, is inscribed to John Genszfleisch [Gutenberg], inventor of the art of printing. A second tablet, 1508, is to John Gutenberg of Mentz, who, first of all, invented printing letters in metal. 

Many writings of the fifteenth century testify that John Gutenberg was then regarded as the inventor of typography. In the *Catholicon* of 1460, a book attributed to Gutenberg, is the statement that the merit of the new art is shown in the "admirable proportion, harmony and connection of the punches and matrices." The key to the invention of typography was the discovery of the only proper art of making the types, "the art as it is now used," for there is no other. The legends of a Dutch invention by Koster in 1440 did not appear in print before 1546.

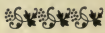
Punches and matrices were frequently sold at the close of the fifteenth century. In the year 1476 John Peter from Mentz was selling matrices to some printers of Florence. The goldsmiths of Florence and Venice were cutting punches for printers. Aldus Manutius of Venice complained that Francis of Bologna, who cut the punches for his new italic, had also cut duplicates for the Giunta. When he began to print at Alost in 1474 John of Westphalia announced that he had the genuine Venetian characters. The types of Jenson of Venice were copied in books printed in France. Caxton of London and Mansion of Bruges used a similar face of type. So did Leeu and Bellaert, and Machlinia and Veldener, of the Netherlands. 

¶ All early type-founding was without system. The printer who directed his punch-cutter to copy the letters in a manuscript had no perception of the beauty of a series of uniform faces and graduated bodies. Gutenberg used pointed gothic and round gothic faces. Jenson made roman and round gothic. Other printers had cut for them mongrel faces which are now entirely disused. Type-casting was always done by the printers, who had a simple form of mould in which they cast several bodies of types, as is shown in the two bodies of english made by Gutenberg and the four bodies of english made by the unknown printer of the Netherlands. ©

All the early printed books were copies, more or less faithful, of the manuscript model. They were fair copies of its form of letter, of its size of page and width of margin, and its arrangement of text and notes. Large blanks were left for initial letters that should grace the beginning of every chapter or other important division, and for the decorative border that should enclose the text. After the printing of the text-type had been entirely done, the initials and borders were added by a professional illuminator who sometimes closed the work of which he was justly proud with a written statement to which he added his name as the decorator. The most direct proof that the Bible of 42 lines was printed before 1456 is the certificate, in one copy, of Albech, the illuminator. *The Psalter of 1457* contains great initials which had been engraved on nested blocks for printing in two colors. The blocks were separated, inked, and then joined and printed by one impression.

Other printers of that age found it less troublesome to leave these spaces for borders and initials blank, to be filled in by the buyer of the book. But few of these book-buyers had the time or the ability to do this work. Only the wealthy could pay the prices asked by illuminators. Consequently not one book in a hundred had its unsightly blanks filled with the decorations intended. Then book-buyers began to question the utility of the white gaps and the broad margins; they began to ask for more print and less paper, for books that were perfect when sold by the printers. To meet this demand, the printers of Augsburg at an early date undertook to furnish small ornamental initials, but Ratdolt of Venice seems to have been the first, in 1477, to make the true decorative initials, or the *literæ florentes*, as he called them.

Ratdolt's initials were probably cut in high relief on metal, for it was not then economical, perhaps not even practicable, to found large ornamental letters in a mould. Much of the so-called engraving on wood of this period, especially of engravings noticeable for their fine or delicate lines, was really engraving on brass, copper, or type-metal. Jean Dupré of Paris says, in a devotional book (entirely typographic) printed by him in 1488, that his engravings of Bible stories and pictures were "printed upon copper." The largest text-types, on a body of about $4\frac{1}{2}$ picas, were founded for John Sensenschmidt, and printed by him in the Bamberg Missal of 1481. Stock of Nuremberg, and some unknown printer in Spain, made types nearly as large, but most buyers of books preferred smaller types and volumes. The printers tried to adapt the old fashions of decorating the books to the new art by engraving full-page borders, and initials designed to show white letters upon a gray groundwork. It was then expected that the book-buyer would illuminate the page by painting red the letters in white. This fashion of making white letters has been continued to this time, although the supposed necessity for them does not now exist.

Typography received its most valuable improvements from the printers of Italy, in which country the three text-letters of greatest usefulness were first made: (1) *Roman*, first founded by Sweinheym and Pannartz in 1465, and afterward perfected by Jenson at Venice in 1471; (2) *Italic* and (3) *Small Capitals*, introduced together by Aldus Manutius at Venice in 1501. The first volume entirely in *Greek* was printed at Milan in 1476; the first book entirely in *Hebrew*, at Soncino in 1488. The forms then adopted have not been seriously changed; modern taste is now drifting back to a closer adherence to the models first made by the more skilful of the early Italian founders. Title-pages, copperplate maps and illustrations, engraved initials and borders, smoother and thinner papers, smaller types and simpler arrangements of types on the page, narrower margins, handier sizes of books, and inexpensive forms of binding—all these, and most of the minor improvements which make books more attractive, were first introduced or were most skilfully executed in Italy.

In the art of making books attractive, France soon became the superior of Italy. For books of devotion and for the literature of romance, early French printers preferred the black-letter character, which they had cast for them in many admirable forms. Not content with beauty in types, Verard, Pigouchet, Kerver, Vostre, and other eminent publishers and printers, secured the coöperation of many able designers, who provided initials and borders of marked merit which are still regarded as masterpieces of typographical decoration. Geoffrey Tory, one of the ablest of early French designers, in his book of "Champfleury" tried to bring into more general use the roman form of letter, which was even then preferred by French scholars, and which ultimately became the accepted text-letter of the nation. Claude Garamond, one of his pupils, seems to have devoted himself entirely to designing and casting types for the printing trade. He carried out in a practical manner many of the reforms in typography which had been proposed by his master. His roman characters, based upon the models of Jenson, and his italics, which he improved by inclining the capital letters, were much admired and eagerly bought by printers in foreign countries. They earned for him the distinction he has had ever since as the "father of letter-founders." Type-founding was made a distinct art in France before it was in any other country. At Paris, Lyons, and Rouen were foundries who supplied printers of all countries with punches, matrices,

or fonts of type. Guillaume Le Bé (1525–1598) succeeded Garamond as the leading type-founder at Paris, cutting many forms of orientals for the Royal Printing House, for printers of Venice, and Christopher Plantin of Antwerp. During three generations his descendants maintained the high reputation of French type-founding. After the death of the last Le Bé in 1707, the foundry was bought and ably sustained by Fournier the elder. The house of Sanlecque, almost as famous, was founded by Jacques de Sanlecque, a pupil of Le Bé. He was celebrated for his music types and for the oriental types he made for Le Jay's Polyglot Bible. Pierre Moreau, who began his work in 1640, Jean Cot, who began in 1670, and Pierre Esclassant, who began in 1666, were other notable founders of Paris, but they were dwarfed by the reputation and fast growth of the Royal Printing House, which was then making fashions for types. In 1704, M. Jaugeon of the Royal Academy of Sciences, working under a commission from the king (Louis XIV.) to make a truly "royal" type, introduced the fashion of extended and almost conjoined hair-line serifs. This feminine fashion added nothing to the beauty of types, but it did largely diminish their legibility and durability. Nine sizes of characters were made in this style.

Louis Luce, the punch-cutter of the Royal Printing House between the years 1740 and 1771, further disfigured the roman character by putting flat, extended serifs upon the tops of some lower-case letters, and by adding a needless side-spur to the lower-case d as is here shown.

During all the changes of government and of name (for it has been called Royal, Imperial, and National), this printing house of the French government has steadily maintained a high reputation for the wealth of its material and the general beauty of its productions. It has been made richer in many ways. Napoleon, exercising the arrogated right of a conqueror, in 1799 robbed the printing office of the Propaganda at Rome, and in 1808 that of the Medicis at Florence, of their valuable collections of punches and matrices. In 1815 the new government of France ordered them to be restored, which was partially done. It afterward enlisted the services of the ablest punch-cutters of all nations in cutting characters for all languages that have a written literature. The official history of this office, published in 1861, states that it then owned 361,000 punches and matrices. Among them are the Greek characters of Garamond made under the direction of Robert Stephens, and the romans modeled after the designs of Jenson. The punches of Grandjean, Alexandre of 1693, and Luce; the borders of Fagnon, the ornaments of Papillon, and some of the work of Fournier the elder; the collection of orientals cut in Constantinople under the direction of Savary de Brèves — these and others are all to be found in the punch closets of this National Printing House. Firmin-Didot added new styles of roman in 1811; Jacquemin in 1818, and Marcellin Legrand between 1825 and 1847, designed new and peculiar faces. The work of other punch-cutters of high reputation — among them Leger-Didot, Delafond, Dresler and Rost-Fingerlin of Frank-

fort, Bodoni of Parma, and Vibert and Bopp of Berlin — is exhibited at length in the large specimen book of 1861. In 1848 it had distinct characters for fifty-two different languages, many of them on different bodies. Although the National Printing House at Paris has a deservedly high reputation, many important improvements in French types and typography were made by founders and printers who were never in its service. At Lyons the type-foundry of Lacolonge, which passed from father to son for many generations, had an enviable reputation for three hundred years. Its earliest and ablest punch-cutter, Robert Granjon, showed more boldness and originality than any other designer of his time. Some connoisseurs in typography hold that an early form of light-faced roman capitals, first shown at Lyons in the xvth century, presumably by Granjon, is really superior in design to the roman of Jenson, or of Garamond, or any of their successors. The type-foundry of Pierre Simon Fournier (or, as he is better known, Fournier the younger) began its work at Paris in 1736. In his "Manuel Typographique" he shows one hundred alphabets, ancient and modern, of great merit, a large part of which was made by his own hands. His greatest service to typography was his invention of the point system of type-bodies, which is more fully described in another chapter. Jacques Charles Derriey (1808-1877), whose specimen album of 1868 is one of the masterpieces of typography, is deservedly honored as one of the most skilful of modern type-founders. He gave his best attention to borders and ornaments.

Italian typography began to show signs of its decadence early in the xvith century. After the death of the earlier printers and designers the types of Venice did not sustain their reputation. But one Venetian type-foundry of the xviiith century, that of the Deucheni, had any celebrity for its productions. The most notable Italian foundry was the one established in 1578 by the order of Pope Gregory XIII., which, with its printing house, has been called the "Apostolic Printing Establishment," the "Printing House of the Vatican," and the "Press of the Propaganda de Fide." Its first punch-cutter was the Frenchman Robert Granjon, invited there from Lyons, who began the series of orientals which, continued by other hands, has made the house famous. Its specimen book of 1628 showed the largest collection of foreign characters. The press of the Propaganda still does a limited quantity of valuable work, but it is much surpassed by the national printing houses at Paris and Vienna. Type-foundries did not flourish in Italy; in 1742 there was but one in Turin, under the management of the Royal Printing House, and but one in 1719 at Milan, under the direction of the printer Bellagata. All the large Italian cities now have type-foundries, yet they have done but little for the improvement of the national printing. Giambattista Bodoni (1740-1813) is the only Italian founder and printer of modern times who has fairly earned the highest honors. As the superintendent of the Press of the Propaganda he showed the ability which caused him to be invited to reconstruct and manage the Ducal Printing House at Parma. Assuming this position in 1766 he soon made the Ducal Printing House the first in Europe. His "Manuale Tipografico," in two quarto volumes, begun by him but completed by his widow in 1818, contains 279 pages of specimens which are good evidences of his skill and industry. These specimens include the alphabets of about thirty foreign languages, some of them in two or more sizes. He is most celebrated for his peculiar styles of roman and italic, which were cut on a new system and with great clearness and delicacy. His styles are now out of fashion, but the stimulus he gave to the founders of all other countries still endures.

Type-founding did not improve in Germany as it did in France and in the Netherlands. The able printers of classic texts at Strasburg, and in other cities, supported as they were by the authority of Albert Dürer, could not induce German readers to accept the roman character. They preferred pointed letters, but were not agreed, even at the beginning of the xvith century, as to the superior merit of any one of the many styles made by the type-founders. The bible-text of Gutenberg, which is the basis of modern black-letter; the profusely ornamented and flourished letters of the "Theuerdanck," which is the model of modern "german-text"; the round-gothic, or the semi-gothic, of Schœffer, a hybrid of roman and black-letter; the schwabacher and the fractur—all these had admirers. The fractur was at last accepted as the standard form of text-type, but it has never found favor with the Latin races or with English-speaking peoples. This adherence of Germans to pointed letters has prevented interchanges of matrices, which has damaged German type-founding by limiting the sale of its types and books. Before 1700 little was known abroad of German type-foundries, though they were more numerous than those of any other part of Europe. That of John Gottlob Immanuel Breitkopf of Leipsic, which was established in 1719, and celebrated its 150th anniversary in 1869, was the first to obtain a wide reputation. The brothers Walbaum of Weimar demand notice as reformers of the German character. The Imperial Printing House of Vienna is celebrated for its large collection of foreign types. Woellmer at Berlin, Schelten and Giesecke at Leipsic, Meyer and Schleicher, and Poppelbaum at Vienna, are eminent as founders. The house of W. Drugulin (Johs. Baensch) of Leipsic is noted for its admirable printing.

Type-founding in the Netherlands during the latter half of the xvth century exhibits the best and the worst of workmanship. Blades believes that there were two schools or two methods: one casting its types in moulds of sand, and the other in moulds of metal; one, the method of an experimenter, or a badly taught pupil; the other, our method, or the "art as it is now used." The type-founding of the alleged Koster and of his school is bad; that of the printer of the "Book of the Golden Thrones" (Haarlem, 1484) is excellent. The types of Thierry Martens of Alost, and of some of his rivals and followers, are equal to any from France or Italy. Some of the punches and matrices must have been bought in France or Italy, but more must have been made at home by able engravers who are now entirely unknown. Christopher Plantin of Antwerp had many of his newer styles made by François Guyot and his son (educated at Paris, but residents of Antwerp). Laurent Van Everbroeck, Jacques Sorbon, Aimé Tavernier, and Gerard d'Emden were type-founders at Antwerp who worked for the Plantin establishment. Plantin was also supplied with punches and matrices by Le Bé, Garamond, Haultin of Paris, Bomberghe of Cologne, and Robert Granjon of Lyons. Of all these designers he seems to have preferred Granjon. Plantin's Flemish characters were made by Henry van den Keere of Gand, who, with his successor Thomas de Vechter, did much work for his house between 1567 and 1589. The most notable of the earlier Dutch founders was Christoffel Van Dijk of Amsterdam, of whom little is known except that he cut punches for the Elzevirs. His types, of which his successor Athias of the "Jewish Foundry" issued a specimen of about twenty faces (including Greek, Hebrew, Italic, Roman, Black, and Music), have been warmly praised by Moxon and Willems. Athias (1683) was succeeded by Schipper, Clyberg (1705), and Roman (1767). Dirck Voskens of Amsterdam was equally prominent in 1677 as a type-founder. He and his descendants largely supplied English printers with types that were highly commended by Luckombe in his book on printing. In 1780 the name of the house was Voskens & Clerk, afterward A. G. Mappa of Rotterdam. The Wetsteins (R. & H. F.) were German founders who began in Amsterdam before 1740, and who for many years maintained a good reputation for their small types. The firm of Enschedé, formed by Isaac Enschedé in 1703, bought out the Wetsteins and made the beginning of the celebrated Haarlem type-foundry, which from time to time absorbed the foundries of Dirck Voskens, J. Blaew, Hendrick de Bruyn, Van den Putte, Van der Velde, and Ploos von Amstel. It is still the largest type-foundry in Holland, and is celebrated for the merit of its oriental characters.

Caxton, the first English printer, began his work with types that show Flemish mannerisms. They were probably made at Bruges, for they closely resemble the curious characters of Colard Mansion and those of John Brito of that city. Garrulous enough in other matters, Caxton is very reticent concerning the operations of typography. In none of his many books does he say anything about the origin of the eight different fonts he used. It is probable that he, like the other printers of his time, bought the punches and matrices where he could, and cast the types in his own printing office. The lower-case letters of one of his later types are exact copies of those made by Fust and Schoeffer, and are equally well executed; but the capitals for this lower-case retain the peculiarities of the Flemish *grosse bâtarde*, or secretary. Wynkyn de Worde, pupil and successor of Caxton, used many of his master's types, but the styles he adopted later, and those of his fellow-pupil and business rival, Richard Pynson, were cut by French artists who modified or suppressed all of the Flemish mannerisms. The form of black-letter preferred by these early English printers is still accepted as the best. It has suffered no transforming change which conceals its derivation. The old english black-letter of our day adheres more closely to the models of the first printers than does the Flemish black or the German *fraktur*. The introduction of the Roman form of letter by Richard Pynson in 1518 did not suppress the black-letter, which remained the favorite letter of the people for more than a century afterward. Reed says: "The Black being employed in England to a late date, not only for Bibles, but for law books, and royal proclamations, and acts of parliament, has never wholly fallen in disuse among us. The most beautiful typography of which we as a nation can boast during the sixteenth and seventeenth centuries, is to be found in the black-letter impressions of our printers." For many years after the introduction of printing England seems to have been dependent on France. Caxton and his successors had books printed at Paris and Rouen. De Worde, Pynson, Faques, Berthelet, and Copeland got many of their punches and types from Rouen.

John Day of London (born 1522, died 1584) was the first English type-founder of marked ability. He was not a founder to the trade: he made types only for the needs of his own printing office, which was patronized by Archbishop Parker. For that dignitary he made the first distinctively English type, a full font of Saxon, which was intended for Ælfric's Saxon Homily and the Saxon Gospels. Reed says that "the accuracy and regularity with which this fount was cut was highly creditable to Day's excellence as a founder." About 1572 he cut a font of double pica italic and roman, which was fully equal to any then in use on the Continent. Archbishop Parker, in a letter to Lord Burleigh, dated December 13, 1572, writes: "To the better accomplishment of this worke and other that shall followe, I have spoken to Daie the printer to cast a new Italian letter, which he is doinge, and it will cost him xl marks; and loth he and other printers be to printe any Lattin booke, because they will not heare be uttered, and for that Bookes printed in Englande be in suspition abroad." Another writer adds that "our Black English letter was not proper for the printing of a Latin book." These fonts of roman and italic were made to line with each other, a nicety too often disregarded by other printers. Day's services to typography were many: he improved the shapes of the Greek letter of his day; he made types for music, "lozenge-shaped and hollow"; he cut types on wood for Hebrew when they were needed in his texts; he made signs, mathematical and other, not before cast in type; while his works abound with handsome woodcut initials, vignettes and portraits, besides a considerable variety of metal "flowers" or border ornaments. Some of the woodcuts he had made for his books, of exceptional merit, have never received the consideration they deserve. His most noticeable work was Fox's "Book of Martyrs," or as it was then called, "Acts and Monuments," of which he printed many editions. His device was a pun on his name — a sleeping man aroused by his friend and by the rising sun — with the words, "Arise, for it is Day." Day seems to have been one of the few prosperous early printers. Strype, in his life of Archbishop Parker, has this notice: "And with the Archbishop's engravers we may join his printer Day, who printed 'British Antiquities' and divers other books by his order . . . for whom the Archbishop had a particular kindness. . . . Day was more ingenious and industrious in his art, and probably richer too, than the rest, and so became envied by the rest of his fraternity, who hindered what they could the sale of his books; and he had, in the year 1572, upon his hands, to the value of two or three thousand pounds worth, a great sum in those days. His friends procured [for] him from the Dean and Chapter of St. Paul's a lease of a little shop in St. Paul's Churchyard." The tablet to his memory has a long inscription from which these lines are selected: | Two wyves he had, pertakers of his payne, | Each wyfe twelve babes, and each of them one more. | Day published about 250 works. Dibdin says, "(if we except Grafton) Day seems indeed the Plantin of old English typographers, while his character and reputation scarcely suffer diminution from a comparison with those of his illustrious contemporary."

English typography entered upon a period of distinct decadence after the death of John Day. Christopher Barker, who was queen's printer in 1582, made this report upon the condition of the trade. "In King Edward the Sixth his Dayes, Printers and printing began greatly to increase; but the provision of letter, and of many other things belonging to printing was so exceeding chargeable that most of those printers were Dryven throughe necessitie, to com-pounde before with the booksellers at so low value, as the printers themselves were most tymes small gayners and often loosers. The Booksellers now keep no printing house, neither beare any charge of letter, or other furniture, but onlie pay for the workmanship . . . so that the artificer printer, growing every Daye more and more unable to provide letter and other furniture . . . will in time be an occasion of great discredit to the professours of the arte." Barker says there were in 1582 "twenty-two printing howses in London, where eight or ten at the most would suffice for all England, yea, and Scotland too." The first English type-founder to the trade seems to have been Benjamin Sympson of London, who in 1597 was enjoined by the Stationers' Company "not to cast any types or to deliver them without advertising the master and wardens in writing, with the names of the parties for whom they were intended." This is the only record concerning Sympson. In the decree of Star Chamber made July 11, 1637, these four type-founders are named, John Grismand, Thomas Wright, Arthur Nichols, Alexander Fifield, who have recently been known as the Star Chamber founders. Of Wright and Fifield nothing more is known. In 1649 John Grismand entered into a bond of £300 with two sureties not to print seditious work. In the same year Arthur Nichols, writing to the Archbishop of Canterbury, complained that "of so small benefitt hath his Art bine, that for four years worke and practice he hath not taken above forty-eight pounds, and had it not bine for other employmente he might have perisht." It is supposed, but not certainly known, that these four founders contributed the types for the London Polyglot of 1657, the fourth great Bible of the world, and the best specimen of English typography in the seventeenth century. They are consequently now known as the Polyglot founders. Nicholas Nichols, son of the Arthur Nichols previously mentioned, in 1665 petitioned to be appointed "Letter Founder to your Majesties Presses." The petition was granted, but there is no evidence that he was a skilled founder.

Joseph Moxon, a type-founder of London from 1659, to 1683, has distinction as the first English writer on the practice of typography. He had been a maker of mathematical instruments, and by reason of his skill and scientific attainments was appointed hydrographer to the king. In 1676 he published his first book: "Regulæ Trium Ordinum Literarum Typographicarum, or the Rules of the Three Orders of Print Letters, viz: the Roman, Italick, English, — Capitals and Small; showing how they are compounded of Geometrick Figures and mostly made by Rule and Compass." In 1683 he published "Mechanick Exercises, or the Doctrine of Handy-Works, applied to the Art of Printing." These volumes are thoroughly illustrated expositions of every branch of typography from punch-cutting to presswork. Moxon says that letter-cutting had been "kept so concealed among the Artificers of it, that I cannot learne anyone hath taught it any other, but every one that has used it Learnt it of his own Genuine Inclination." This leads his reader to infer that he was entirely self-taught. His early rude types, and his models for types as laid down in his first book, strengthen this inference; but the careful engravings of the tools of the punch-cutter and his explanations of all the processes of type-founding, contained in his second book, show that he was then thoroughly instructed in every branch of typography and had right to speak with authority. He was deeply impressed with the great beauty of the Van Dijk types, and makes use of them as models to enforce his theories of the value of geometrical rules in designing letters. No type-founder of his time, or afterward, accepted his geometrical formulas, which all founders say are impracticable, but the information he gives about the practice of other branches can be read now with pleasure and profit. It does not appear that he made any reformation in English typography. The printers of London continued to prefer the types of Dutch founders. Robert Andrews succeeded Moxon, after 1683, and continued the business of type-founding to 1733. His foundry was probably the richest in matrices of all in England, but he was not regarded a good workman. A font of Saxon cut by him for the University Press at Oxford was found unsatisfactory and put away. Most of the types of learned languages for which the University foundry was famous were cast in matrices made abroad. Their romans and italics were largely of Dutch manufacture, and they depended on French founders for Greek, Hebrew, and Oriental types. In 1700, when the University of Cambridge wished to buy in Paris a font of the Greek types known as the King's Greek, the French Academy made it a condition of purchase that all books printed therefrom should bear an imprint setting forth that the types were from the French king's royal printing house — a condition which was refused by the University. The Oxford University had a press of its own as early as 1478, but this press did little work of value before 1585. Dr. John Fell, the vice-chancellor, presented it with a complete type-foundry in 1667. Ten years after Mr. Francis Junius enriched the University Press with a valuable collection of punches and matrices. Most of them are now obsolete, but Reed says that under able management the foundry is in active operation, and that the University Press possesses the largest collection of polyglot matrices of any foundry in the kingdom. The only notable founder at Oxford during the seventeenth century was Peter Walpergen, a Hollander. He was succeeded by Sylvester Andrews (before 1714), who was the son of Robert Andrews, the London founder. James Grover, who began business about 1675, and Thomas Grover, his son, were successors to one of the old polyglot founders. They were the first English founders who made the size diamond. They introduced "Scriptorials," "Cursives," "Court-Hand," and several forms of ornamental letters. In 1728 Thomas Grover's daughters, who were his heirs, tried unsuccessfully to sell the foundry in bulk. William Caslon's offer for it was refused as too small. For thirty years the foundry was neglected, and locked up in the house of Nutt the printer, who seems to have made use of it for his own benefit. After the death of the last of Grover's daughters, the foundry was sold to John James.

Thomas James, one of the apprentices of Robert Andrews, began business in London as a type-founder about the year 1710. There is no evidence that he had any skill as a punch-cutter. It was, probably, a conviction of his own inability, and of corresponding inability on the part of the few punch-cutters then in London, that induced him to go to Holland to buy the punches and matrices he needed to equip his foundry. Rowe Mores, in his "Dissertation on English Founders," has reprinted some of the curious letters then written from Holland by Thomas to his brother John who was to be his associate in the business. From these letters it appears that the Dutch founders, willing to sell types, were not so ready to sell matrices, and proposed to part only with those they esteemed the least. Voskens, with whom James tried to deal, saw in him a future competitor and gave him scant civility. Cupi and Rolij, two punch-cutters for Dutch founders, were the men from whom he bought most of his materials. The price paid for those he got are not stated, but James seems to have been well satisfied with his purchases, which were effected only after a deal of suspicion and higgling on both sides. With these matrices the brothers commenced and for many years maintained a successful business in London. Thomas James earned an unenviable prominence as the first antagonist to stereotyping. In 1729 William Ged of Edinburgh, who had invented a useful process of stereotyping, was induced to associate with him Thomas James as a partner. James played false from the beginning, and supplied him with worn types to bring the invention into discredit. By his connivance the compositors made errors, and the pressmen bruised the plates. After three years of hopeless struggle with these covert enemies Ged abandoned his work in London and returned to Edinburgh, where he printed from stereotype plates an edition of Sallust before his death in 1749. In 1781 Dr. Tilloch of Edinburgh, with Foulis, then printer to the University at Glasgow, reinvented a new process of stereotype with which they printed several books. Van der May in 1705, and Firmin-Didot, in 1795, also made practicable plates, but the art of stereotype was not really successful until it was perfected by Stanhope in 1800. The business of James declined before his death in 1736. His son John continued the policy of his father in buying matrices from other small foundries, but with a steadily diminishing hold on English printers. Nearly all of the types of this foundry were out of fashion. At his death in 1772 all the material passed by purchase into the hands of the antiquary, Rowe Mores, who did not choose to continue the business and who found it difficult to sell the matrices. Mores says that the "waste and pye" of this foundry contained upwards of six thousand matrices, the assorting of which gave him great trouble, but that he was gratified to find in the rubbish of punches some originals of Wynkyn de Worde. "They are truly *vetustate formâque et squalore venerabiles*." At the auction sale in 1782 the contents of the foundry were dispersed, Dr. Fry buying the matrices of the curious characters. "With this sale," says Reed, "disappeared the last of the old English foundries."

William Caslon of London (born 1692, died 1766), the ablest type-founder of the eighteenth century, was one of many eminent punch-cutters who never served a regular apprenticeship to the trade. In his boyhood he had been taught the art of a general engraver on metal, and was employed for most of his time at engraving gun locks and barrels, and letters and ornaments for bookbinders' stamps. About the year 1719, when he was twenty-seven years of age, his marked ability in making letters attracted the attention of the printers John Watts and William Bowyer, who advised him to devote himself to making punches for types. His first commission was the cutting of punches for a font of Arabic, which was so well done that Bowyer, Watts, and Bettenham, another printer, lent him £500 to establish him in business as a type-founder. His next task was the cutting of a font of Coptic, which he did with equal ability. A full font of pica with its mated italic perfected by him, and issued to the trade about the year 1721, was so much better than any then in use, either English or Dutch, that his superior abilities as a founder were admitted without question by all printers and publishers. How he organized his foundry, how he secured proper workmen, and obtained a full knowledge of the technicalities of this jealously guarded trade, has never been fully told, but the work was well done. In 1734 he issued a sheet of specimens showing twelve faces of roman and italic, seven faces of two-lines, seven faces of flowers, and seventeen faces of foreign letters — all of which, with three exceptions, were cut by his own hands in fourteen years. Many of the roman and italic faces are now in use under the name of Old-style. Nichols wisely says: "For clearness and uniformity, for the use of the reader and the student, it is doubtful whether it [the Caslon fashion of letter] has been excelled by any modern production." In 1742 Caslon's eldest son William (known in the trade as Caslon II) was admitted to partnership, and continued the business until his death in 1778. The son was a good founder and fully maintained the reputation of the house, but he showed an ungenerous depreciation of the work of his father's old apprentice, Joseph Jackson. The quality of its productions is fairly shown in the "Specimen of Printing Types, by W. Caslon & Sons, letter-founders in London," which is inserted in Luckombe's "Concise History of the Origin and Progress of Printing," of 1770. No other foundry of that period, nor for a long time after, showed a series of faces so symmetrical. William Caslon III succeeded to the management of the business, but in 1792 he sold his share in it to his mother and his brother Henry's widow, and bought the foundry of the deceased Joseph Jackson. Under his management the Jackson foundry was much enlarged and improved. About the year 1803 the fourth William Caslon was admitted to partnership, and the name of the firm became W. Caslon & Son. In 1807 the senior partner retired, dying in 1833. His son William Caslon IV added to the stock and extended the business of the foundry, but to some extent damaged his reputation as an intelligent founder by an unsuccessful attempt at making short, wedge-shaped types, intended to be fitted and fastened on the periphery of a cylindrical printing machine. In 1819 he sold his foundry to Blake, Garnett & Co., who removed the material to Sheffield, where its work was afterward done under the name of Stephenson, Blake & Co. The older Caslon foundry continued to be managed by Mrs. William Caslon, mother to Caslon III. She was an active member of the Association of Type-founders, and of marked business sagacity. Her great error was her unwillingness to conform to the fashions of the day in type. She died in 1795. The business was carried on with ability by Mrs. Henry Caslon until her death in 1809. Her son Henry, in partnership with John Catherwood until 1821, and afterward with Martin W. Livermore, continued as the nominal head of the house until his death in 1874. This fifth generation was the last of the Caslons, but the house is still flourishing, as successful and as highly esteemed as ever, under the management of T. W. Smith. After a neglect of nearly fifty years the Caslon cut of letter was restored to favor. In 1843 Whittingham of the Chiswick Press was requested by the publisher Pickering to reprint "The Diary of Lady Willoughby," a fiction of the seventeenth century, in an appropriate old-style dress of letter for which he had no suitable face of type. At his request the Caslon Foundry took out of its vaults the matrices for great-primer cut by the first Caslon, and cast a small font for this book. This old-style face met with such approval that all the other matrices of the Caslon old-style were revived.

John Baskerville of Birmingham (born 1706, died 1775) was Caslon's ablest rival. Like him he served no apprenticeship to type-making. His first serious business was that of a writing master, and a designer and cutter of letters on tablets and tombstones. Afterward he began the manufacture of japanned wares, in the sale of which he was remarkably successful. In 1750 he began to cut punches, and to create typographic material for printing a book which he intended should more clearly show his notions about types and printing. He says he spent six years and six hundred pounds before he made a satisfactory type. His first book, "Virgil," in great-primer letter, established his reputation as an able designer of types, yet it met with much hostile criticism as unnecessarily slender and delicate. His second attempt, a "Greek Testament" in great-primer, was generally condemned. The types of this book were too stiff and too condensed to please tastes formed on earlier models. His editions of the "Paradise Lost," the Bible, and the "Common Prayer," fully regained for him the reputation he had damaged by his Greek. In 1758 he had cut eight fonts of the more used sizes of roman, and was then ready to receive orders from the printing trade. Although his types and his printing were much admired by critics, his types were not bought by printers, who objected to them as weak and unfit for wear. They preferred the stronger ones of Caslon. In 1760 he tried ineffectually to sell his types, and to retire from the business of printing, because he was heartily tired of it, and repented that he had ever attempted it. Four years after Baskerville's death, his widow sold all his types and type-making material to the Société Littéraire-Typographique, who removed them to Kehl, near Strasburg, where, under the management of Beaumarchais, they made use of some of the types for a complete edition in seventy volumes of the works of Voltaire. So ended the labors of one of the great British type-founders. Alexander Wilson of Glasgow was another competitor of the Caslons. His education had been that of a "surgeon's assistant or apothecary," but a chance visit to a type-foundry in London led him to consider, and finally to attempt, the making of types by a new method. In this plan he associated with him John Baine. What the new method was has never been told, but it must have been impracticable, for their first types, sold at St. Andrew's in 1742, were made by the old approved method. The partners seem to have been very successful, selling types not only in Scotland but in Ireland and North America. In 1749 Baine withdrew and established a separate foundry at Dublin. Wilson's best production was a font of double pica Greek, specially cut for an edition of Homer, in four folio volumes, admirably printed by Robert and Andrew Foulis, and intended for Flaxman's celebrated illustrations. In 1760 Wilson was appointed a professor of practical astronomy in the University of Glasgow. The type-foundry was removed to that city, and its management devolved upon Wilson's elder sons. This Glasgow foundry soon became a formidable rival to the London founders, for it undersold them in England. In 1825 the proprietors of the foundry were Andrew and Alexander Wilson, son and grandson of the originator. In 1830 Andrew Wilson died. His sons Alexander and Patrick decided in 1832 to establish a branch in Edinburgh. In 1834 the Glasgow foundry was transferred to London, where, after many vicissitudes, it was finally merged in that of the Caslons. The Edinburgh branch, known as Marr, Gallie, & Co., was also transferred to London, and did business as the Marr Type-Founding Company.

Thomas Cottrell, one of the apprentices of the Caslon house, began a type business on his own account in 1757, in partnership with a fellow-apprentice, Joseph Jackson; but Jackson left him in 1759 to go to sea. Cottrell's first specimen book was probably published in 1766. It shows roman and italic in sizes from five-line to brevier, with a new form of engraving, Domesday, and five pages of "flowers" or border ornaments. His styles were of the approved Caslon model, but not equal to those of his master. Mores says he made "types of great bulk, as high as twelve-line pica." Cottrell died in 1785. In 1794 his foundry became the property of Robert Thorne, one of his apprentices, who, in his specimen book of 1798, appears to have discarded all of his master's fonts, and to have created an entirely new series, remarkable for their lightness, grace, and uniformity. But great changes had been going on in public taste. Light faces were disapproved; bold and black faces were demanded. To meet this demand, Thorne showed in 1803 a full series of "improved types" of the bold-face which so seriously vulgarized the book printing of the first half of this century. Subsequent specimens from his foundry showed still blacker and more unsightly faces of large romans, but they were much admired and freely bought by job printers in quest of novelty. Thorne died in 1820. His business was bought and carried on by William Thorowgood, who materially enlarged the foundry with new fonts of foreign characters—some cut under his own direction, some bought abroad, but most of them were from the very full collection of the modern Polyglot Foundry of Dr. Fry. In 1838 Thorowgood admitted Robert Besley to partnership. On Thorowgood's retirement in 1849, Benjamin Fox, a punch-cutter of ability, was admitted, and the firm was known as Robert Besley & Co. Mr. (afterward Sir) Charles Reed, a printer, succeeded in 1861, and the foundry was then known as that of Reed & Fox. Sir Charles Reed died in 1881, and the business was continued by his sons, one of whom was Talbot Baines Reed, the author of "A History of the Old English Letter Foundries," to whom the writer is indebted for much of the information given in these pages concerning English founders.

Joseph Fry began business in 1764 as a type-founder in Bristol. He had been educated as a physician, and had distinction as a ripe scholar, but he was impelled to the mechanical trade of type-founding as Moxon had been—by "genuine inclination," and a strong desire to emulate the achievements of Baskerville, whose styles of letter he made the models of his earlier types. His first partners were William Pine, a printer, and Isaac Moore, a whitesmith. Bristol was found too small a field for the new enterprise, and they moved the foundry to London. Here they met a serious disappointment. The Baskerville style of face was decidedly rejected by the

printing trade, and Fry was compelled, much against his will, to cut an entirely new series of faces. The Caslon style was selected as the most salable, but before the cutting of the series had been completed, a fickle public taste had put the Caslon style aside, and showed its preference for newer forms. In 1782 Fry bought the larger part of the old James foundry, which was rich in foreign and learned characters. He died in 1787, and was succeeded by his son Edmund Fry, who afterward admitted as partners Isaac Steele and George Knowles. In 1799 this foundry published "Pantographia: containing accurate copies of all the known Alphabets in the World," in which were shown the characters of nearly two hundred languages. Although this foundry attained a high rank for its oriental and "learned" types, it never achieved a commercial success. In 1828 it was sold to William Thorowgood, through whom it ultimately became a part of the present Fann street letter-foundry of Sir Charles Reed's Sons.

Joseph Jackson began the work of type-founding as an apprentice of Caslon I. He was taught every branch of the business but that of punch-cutting. This jealously guarded mystery was practised only by Caslon and his son in a private room; but Jackson bored a hole in the wainscot of an adjoining room at different times, and carefully watched every process. When Jackson thought he was able to do the work, he cut a punch, which he showed with great pride to his master, expecting to get his approval. But Caslon was much displeased; instead of commendation he gave him a blow and abuse, and threatened to send him to jail if he repeated his offense. Jackson's mother soothed his wounded feelings, bought him new tools, and encouraged him to continue his punch-cutting studies. Here it may be said that nearly every one of the eminent English punch-cutters attained his proficiency in this art, not by the smooth road of apprenticeship and special instruction, but by breaking through the obstructions made by masters and fellow-workmen. Jackson served his time as an apprentice, but again offended his master by a request for more wages, for which offense he was discharged from the foundry. Then he and his fellow-apprentice Cottrell formed a copartnership and began business for themselves in 1757. They did not find enough profit in their venture for two, and Jackson soon abandoned the work and went to sea as an armorer. On his return he made a new attempt at establishing a type-foundry, not with Cottrell, but through the aid of two fellow-workmen, who allowed him £62 8s. per annum for his living expenses. On this narrow money basis he laid the foundation of what afterward became one of the largest of British type-foundries. His first work, in 1763, met the approval of Bowyer, the great printer of London, who told him that he had been the means of old Caslon riding in his coach, and that perhaps he

might be the means of doing the same for Jackson. Even the elder Caslon unbent his austerity, and told his disparaging son that Jackson's art and skill would yet command respect. In 1773 he had organized a small but valuable foundry, and had earned reputation as a skilful mechanic and punch-cutter. The types he made for a facsimile edition of the "Domesday Book," admirably printed by Nichols in two folio volumes, extorted praise from every type-founder and every man of letters. He was equally successful in his facsimiles of the Greek types of the "Codex Bezae." His most important work was the double english roman made for the "Macklin Bible," in seven volumes royal folio. Jackson did not live to see the conclusion of this work, which had to be supplemented by the labor of a former apprentice; but the design of the letter was his, and Nichols says it was a pattern of the most perfect symmetry to which the art had arrived. He died in 1792, and his foundry was bought by William Caslon III.

Baskerville's ablest successor, not to his foundry or business, but to his skill and style, was his apprentice Robert Martin, whose brother William, in 1790, became the head of a small but famous foundry. Boydell and Nicol had matured plans for their great edition of "Shakespeare," to be printed by Bulmer, and William Martin was engaged by them to make "imitations of the sharp and fine letter used by the French and Italian printers." The appearance of this book, soon followed by an equally admirable edition of Milton, was an unexpected revelation of the possibilities of typography. Under the able management of Bulmer, the Shakespeare Press printed many admirable books, of which these are the most esteemed: Dibdin's "Typographical Antiquities," the "Decameron," M'Creery's "The Press," and the "Poems" of Goldsmith and Barnell, for most of which Martin provided the types. All were based on the Baskerville models. But these types were admirable only when carefully printed. Martin was not able to change the incoming fashion for fat and bold faces. He died in 1815, and his foundry came to an end, the Caslons taking the more valuable portions of his collections.

Vincent Figgins was the favored apprentice of and expected successor to Joseph Jackson, but he was prevented from being

his successor by Caslon's purchase of the foundry. John Nichols, the printer, lent young Figgins the money needed to establish him in business. He began, in 1792, with a great undertaking—the cutting of the double english (commenced by Joseph Jackson) intended for the Macklin "Bible." Reed says: "Of the excellence of the performance both as a facsimile and as a work of art, a reference to the splendid Bible itself, and the no less splendid edition of Thomson's 'Seasons,' in which the same type was used in 1797, is the most eloquent testimony. Mr. Figgins received the honour of being named on the title-page of the latter work, which still remains one of the finest achievements of English typography." He was as remarkable for his industry as for his skill. No foundry of the time equaled his in the number or general merit of its productions. He cut a new face of Greek for the Oxford Press, new forms of Persian, Telugu, Domesday, Hebrew with points, a facsimile of Caxton's first letter, and a series of intricate German-texts. After a general commendation of his work, Hansard adds: "I feel it particularly incumbent on me to add . . . that he has strayed less into the folly of fat-faced preposterous disproportions than either Thorne, Fry, or Caslon." Mr. Figgins relinquished business in 1836, and died in 1844. His two sons, Vincent Figgins II. and James Figgins, succeeded in 1836. Vincent Figgins II. died in 1860, leaving the business to be carried on by James Figgins I. and his son James Figgins II., the latter being the present proprietor.

William Miller, once the foreman of the Wilson Foundry at Glasgow, began business on his own account at Edinburgh in 1809. From the beginning his foundry had a remarkable success; it was a rival not only of the Glasgow, but of the London founders. In 1832 William Richard was admitted as partner; in 1838 the name of the firm was changed to Miller & Richard. Reed says that this foundry was the first to introduce successfully type-casting machinery in Great Britain. William Miller died in 1843, and the business was carried on by Richard and his son until 1868. Since the retirement of Richard, senior, the foundry has been managed by his sons J. M. Richard and W. M. Richard.

Anthony Bessemer, the inventor, was a founder of marked ability, in London, between the years 1821 and 1832.

In his twentieth year, Bessemer had distinguished himself by the erection at Haarlem in Holland of pumping engines. Before he was twenty-five years of age he was elected a member of the Académie at Paris for his improvements in the microscope. He cut the diamond type used by Pickering for his diamond editions. The foundry was dispersed in 1832. His son Henry was a master of the mechanics of the trade, and patented improvements in type-founding before he was twenty-five years old.

Richard Austin, a noted punch-cutter, had a foundry in London before 1819. George Austin, his son, succeeded him in 1824. After his death the foundry was owned by R. M. Wood, who in partnership with S. and T. Sharwood continued the business. After their death the business ceased, and their collection was dispersed.

Louis John Pouché was a type-founder by Didot's polymatype method at London in 1819, but was unsuccessful. In 1830 he abandoned the business, and sold at auction twenty thousand matrices, punches, etc., and thirty-five tons of type.

Abel Buell of Killingworth, Connecticut, is accredited, on imperfect evidence, as one of the early type-founders in the United States. His regular business was that of a whitesmith. It does not appear that he was ever in a type-foundry, or that he ever received any instruction in the art, but in 1769 he petitioned the General Assembly of his State for money to establish a type-foundry. To prove his ability to make types, he appended to his petition impressions from types that he said he had made. The petition was granted, but his foundry did not prosper, and was soon extinct.

In 1768 David Mitchelson, a die-sinker from London, attempted to establish a type-foundry at Boston, but did not succeed. It is possible that Buell got his slender knowledge of type-founding from Mitchelson.

In 1772 Christopher Sauer (or Sower, as he spelled it in English), second of the name, established a type-foundry at Germantown, near Philadelphia. This foundry was managed by Justus Fox, who seems to have been expert in many mechanical arts. In 1784 Fox purchased the foundry, and with his son continued the business until his death in 1805. In 1806 Fox's son sold the foundry to Samuel Sower, son of Christopher Sauer, who had previously tried to establish a type-foundry at Baltimore, which attempt was successfully renewed by him in 1815.

Jacob Bey, a German, began a second foundry at Germantown about 1774.

Benjamin Franklin when in Paris bought from P. S. Fournier, the inventor of the point system of type-bodies, a complete equipment for a type-foundry which he intended should be established at Philadelphia. To this end he had his grandson B. F. Bache receive instruction from Fournier, that he might be qualified to manage the foundry. Franklin and his grandson arrived in Philadelphia in 1775, and began the business of type-founding, but they were not successful. Thomas says that they did not or could not make good types. The foundry was neglected, and Bache turned his attention to printing.

John Baine (once partner with Alexander Wilson of Glasgow) and his grandson began a type-foundry in Philadelphia in the year 1785. They were the first skilled founders in the city, and soon had full employment, one of their most important orders being a large font of types for an encyclopedia to be printed by Dobson. In 1790 the elder Baine died. Soon after the grandson abandoned the business and removed to Augusta, Georgia, where he died in 1799.

About the year 1775 Benjamin Mecom, a printer and nephew of Benjamin Franklin, attempted to make stereotype plates. He cast plates for a number of pages of the New Testament, but never completed the work, and finally abandoned the undertaking. The first book stereotyped in the United States was "The Larger Catechism," of 142 pages. It bears the imprint of J. Watts & Co., New York, 1813. B. & J. Collins and Collins & Hanway were the successors of Watts, who returned to England in 1815.

The first type-founder in New York was Adam G. Mappa, who had successfully practised type-making in Holland. He was obliged to leave his country for political causes. His name appears in the New York Directory for 1792. His foundry was fairly equipped with Dutch faces, but his stock of romans was poor. He was not successful. In 1795 he entered the service of Binny & Ronaldson, and was with them three years. Some of his faces appear in their book of specimens. He then went into the service of the Holland Company. He died in 1828.

The first founder in the United States of marked ability was Archibald Binny of Scotland, who had made types in a small way at Edinburgh. In 1796, in connection with James Ronaldson, he established a type-foundry at Philadelphia, which soon took the lead of the other foundries in that city. In 1811 he patented a valuable improvement to the moul — a spring lever which gave a quick return motion to the matrix, and enabled the type-caster to make more types with less exertion. He made a machine for the automatic rubbing of type, but it was not successful. He retired in 1819. James Ronaldson and Richard Ronaldson continued the business.

In 1820 Lawrence Johnson, a printer and native of England, established a stereotype foundry in Philadelphia. In 1833 he formed a partnership with George F. Smith for the purpose of buying the type-foundry of Richard Ronaldson. Under the new management the operations of the foundry were largely extended. In 1843 George F. Smith withdrew. In 1845 Johnson admitted to partnership Thomas MacKellar, John F. Smith, and Richard Smith, who had been trusted employees of this house. Peter A. Jordan was added afterward. Before his death in 1860 Johnson sold the foundry to his junior partners, who continued the business under the name of MacKellar, Smiths & Jordan, and afterward of MacKellar, Smiths & Jordan Company, but the house has not lost its old name of the Johnson Foundry. John F. Smith was born January 20, 1815, and died November 1, 1889. Peter A. Jordan was born in Philadelphia, 30th of May, 1822, and died there 25th of March, 1884. Richard Smith died September 8, 1894. In 1892 the MacKellar, Smiths & Jordan Company became the Philadelphia branch of the American Type Founders Company.

In 1804 Elisha White and William Wing of Hartford, Connecticut, undertook to make types without any experience in type-founding, and even without any knowledge whatever of the construction of the approved form of type-mould. After repeated failures they were obliged to send one of their workmen to the foundry of Binny & Ronaldson of Philadelphia, but he failed to get the knowledge needed. After doing a limited business in Hartford, White separated from Wing, moved his foundry to New York in 1810, and made type in an old building on Beach street. Foreseeing the rapid growth of cities in what was then the Far West, he established branch foundries in Buffalo and Cincinnati. Dying in 1836, the business was continued by his son John T. White. He was succeeded by Norman White, and when his son was admitted to partnership the firm-name was changed to Charles T. White & Co. Charles T. White retired in 1854, after selling the type-foundry to his employees, A. D. Farmer, Andrew Little, and John Bentley, who carried on business under the name of Farmer, Little & Co. Andrew Little and John Bentley retired in 1892. A. D. Farmer died in 1895. The business is now carried on by William Farmer, under the name of A. D. Farmer's Son Type Founding Co.

In 1806 Robert Lothian of Scotland tried and failed to establish a type-foundry in New York. His son George B. Lothian, who had been taught the trade of stereotyping in the stereotype foundries of John Watts of New York and B. & J. Collins of Philadelphia, and had also received instruction from his father and from Elisha White in type-founding, undertook to establish a type-foundry in Pittsburgh, Pennsylvania. It was an unsuccessful enterprise, and Lothian returned to New York. In 1822 he undertook to make type for

the firm of Harper & Brothers. The faces of Greek which he cut for the Anthon Classical Series were very much admired. After his death in 1851 the Lothian foundry was sold to Peter C. Cortelyou and W. H. Giffing. When Cortelyou died in 1875, the business of this foundry ceased, and its contents were dispersed.

Edwin and Richard Starr, who had been inducted in the trade by Elishu White, made an unsuccessful attempt to establish a type-foundry in Pittsburgh, Pennsylvania. Equally unfortunate in other attempts in Albany and New York, they were afterward employees in the foundries of New York and Boston.

James Conner, a printer of New York, began business as a stereotyper in that city in the year 1827. He made the first stereotype edition of the New Testament. He also earned a good reputation as the publisher in the United States of the Bible in folio form. To the business of stereotyping he soon after added that of type-founding, in which he was remarkably successful. By the aid of Edwin Starr, then in his employ, he made the electrotype matrices which enabled him largely to increase the faces of his foundry. The Conner Foundry was the first in this country to introduce light faces. After the death of James Conner in 1861 the foundry was managed by his sons under the name of James Conner's Sons. William Crawford Conner, the eldest son, was born in New York, 4th of December, 1821, and died there on the 26th of April, 1881. James Madison Conner was born in Boston the 2d of November, 1825, and died in New York on the 14th of July, 1887. The grandsons of the founder, Benjamin F. and Charles S., managed affairs for the five years preceding 1892, when they merged the business in that of the American Type Founders Company.

William Hagar, who had been an employee and afterward a partner in the firm of Charles T. White & Co., began business as a type-founder in New York about 1840. At one time he owned the patent right of the Bruce type-casting machine, and devoted much of his time to its introduction in the United States and in foreign countries. He died in 1863, leaving the foundry to be managed by his sons, who afterward abandoned the business. The foundry is now extinct.

David Bruce (born in Scotland, 1770; died in New York, 1857) was the head of a type-founding family which has done much for the improvement of the arts of stereotyping and type-making. After serving an apprenticeship to printing in Edinburgh, he emigrated to New York in 1793, where he followed his trade as a pressman. In partnership with his younger brother George Bruce, he began business in New York as a master printer in 1806. Rumors having reached them of the advantages of the new art of stereotyping, David went to London in 1812, and ineffectually tried to get the information he desired from the inventor, Earl Stanhope. From other persons he got, as he thought, enough of hints or suggestions to warrant him beginning the work. On his return to New York he added stereotyping to his business, in which he made a marked success. Three of the most valuable aids to stereotyping are his unquestioned inventions: the shaving machine, which enables the stereotyper to make all plates of even thickness; the "patent-block" of mahog-

any, which firmly holds the stereotype plate, and yet allows its ready release or change to any new position; the dove-tailed packing box with sliding cover, which secures plates from injury and permits rough handling in transportation. In 1822 he withdrew from business, but continued to experiment in type-founding with useful results.

David Bruce, Jr., son of David, at an early age gave great attention to the mechanics of type-casting. The machines of Wing & White, of Starr & Struveant of Boston, and William M. Johnson of Hempstead, had been tried and rejected by the trade. The first machines of Bruce were equally unsatisfactory, but in 1833 he made a machine which was generally adopted and had no worthy rival for more than fifty years. He also invented a type-rubbing and dressing machine of merit, and was fairly successful as a punch-cutter. Many meritorious forms of script and ornamental letter now put aside as old-fashioned were designed and engraved by his hand.

George Bruce (born in Edinburgh, in 1781; died in New York, 1866) emigrated to this country in 1795. After serving apprenticeship as a printer in Philadelphia and working as a compositor in New York, he became the business partner of his brother David. Their new enterprise of stereotyping was seriously hindered by the shapes of the types they had to use. Types as then made had no shoulder. The beard or neck sloped at a very long angle from face to shank. The plaster used in stereotyping filled these sharp angles, from which it was removed with difficulty. Breakages which defaced the mould and spoiled the cast were frequent. After many unsuccessful efforts to induce type-founders to make types with square shoulders, the brothers undertook to make types for themselves. They began with the materials unsuccessfully used by the brothers Starr. Their first specimen book is dated 1815. George Bruce was an enthusiastic and indefatigable punch-cutter, who found his greatest pleasure, even at advanced age, in cutting letters, many of which are still admired as models of good form. His services to type-founding by his system of geometrical bodies are related in this book in the chapter on the Point System.

David Wolfe Bruce (born in New York, in 1823), the youngest son of George, succeeded to the business of George Bruce, which he continued, in partnership with James Lindsay, under the name of George Bruce's Son & Co. Between the years 1868 and 1876 he produced an unusually complete series of "penman" scripts, the most difficult and the most expensive feat of type-founding ever undertaken in this country. David Wolfe Bruce retired from business in 1890, transferring the entire foundry to his employees Henry M. Hall, Vilander B. Munson, and Robert Lindsay. The younger Lindsay died in the same year; Hall retired in 1896. The business is now conducted by Munson, under the name of V. B. Munson.

James Lindsay was born in Glasgow, Scotland, in 1825, and was taught the trade in the foundry of Alexander Wilson of Edinburgh. He died in Brooklyn on the 20th of September, 1879. He was a thoroughly educated type-founder and a punch-cutter of admitted ability.

Peter C. Cortelyou, a type-founder of New York, was born in New Jersey in 1800, and died in Staten Island on the 24th of September, 1878. His first knowledge of type-founding was received in Pittsburgh in the year 1820. Returning to New York, he became an employe and afterward a partner of George Bruce. At his death he was proprietor of the plant of George B. Lothian.

Samuel Nelson Dickinson (born 1801, died 1848) was a notable type-founder of Boston. He was taught the trade of a printer in the State of New York, but afterward worked as a compositor in the Boston Type and Stereotype Foundry. In 1829 he began business as a master printer. Unable to get from any type-foundry of his city the types his taste demanded, he undertook to have them made. The style known as the Scotch-face was modelled by him in 1837, but cut and cast to his order by Alexander Wilson & Son, of Edinburgh. The matrices imported by him were the first types of the Dickinson Foundry in 1838, and were received with marked favor. The first specimen-book of the Dickinson Foundry, published in 1842, shows a refined taste and marked ability, and served as a stimulus to other founders. At his death the foundry passed to other hands, and for some years did business under the name of Phelps, Dalton & Co. It is now managed by J. W. Phinney, of the old firm, and is an important branch of the American Type Founders Company.

Michael Dalton, of the old firm of Phelps & Dalton, and afterward of the Dickinson Type Foundry of Boston, was born in Boston the 23d of May, 1800, and died there on the 24th of October, 1878. He practised type-founding for nearly sixty years.

Nathan Lyman, born in Coventry, Conn., in 1790, became an employe of Ethiu White, of Hartford, in 1810. In 1829 he was connected with the Albany type-foundry of R. Starr & Co. In 1836 he removed to Buffalo, and there began a business afterward known as the Buffalo Type Foundry. He died at Buffalo on the 16th of February, 1873. The Lyman Foundry is now a branch of the American Type Founders Company.

A. W. Kinsey & Co. were type-founders and stereotypers in Albany between the years 1835 and 1831. After 1831 this firm-name disappears from the Albany Directory. Richard Starr & Co. issued a specimen book of the Albany Type Foundry under the date of October 20, 1836. In the circular-letter it is claimed that "one of this concern has been engaged in letter-cutting for more than fifteen years, and that he has cut more than one-half of all the letter now cast by all the American Founders." They offer nonpareil at one dollar and twenty cents a pound, brevier at seventy cents, and other sizes at proportionate rates. In 1830-31 the business of this foundry was carried on under the name of Starr, Little & Co. In 1833 Starr and Little had separated, each conducting a separate business. Starr's name disappears from the Directory in 1840, and Little's in 1846.

O. B. Van Benthuysen (born 1786, died 1845), who had been apprenticed to a bookbinder, associated with Robert Peckard in 1813, and they began business as printers. About 1832 they added the new branch of stereotyping, and soon after type-founding. They put in type-casting machines, which were driven by steam-power from a small upright steam-engine of German silver of domestic manufacture. From 1824 to 1833 Van Benthuysen & Peckard were joint proprietors of the "Albany Argus" and State printers. Type-founding (of text-types only) was continued, but only for the needs of that house, by the successor, Charles Van Benthuysen.

James Fowdick Starr, Jr. stereotyper in New York, Boston, and Philadelphia, between 1824 and 1832, died in Illinois in 1853. Richard (born 1788, died 1849) was a type-founder for nearly fifty years. Henry S., twin brother of Richard, was a punch-cutter. The date of his death is unknown. Edwin, a younger brother, a punch-cutter and inventor of ability, died in 1838. In partnership with his son Thomas W. he carried on the business of type-founding in Baltimore and Philadelphia under the name of E. Starr & Son. This foundry was afterward sold to Collins & M'Leester of Philadelphia.

Andrew Foreman, previously of the Bruce Foundry of New York, was engaged by William Faulkner to establish a type-foundry in San Francisco, which he did in 1838, building the first machines and casting the first types made in California. This foundry, aided by Conner's Sons of New York, did business under the name of Faulkner & Son until 1850, when it was sold to Painter & Co. and incorporated with their foundry. Then Foreman established a new foundry, which now does business under the name of Foreman & Son.

Painter & Son established a type-foundry at San Francisco in 1838, with machines and moulds from the Johnson Foundry of Philadelphia. J. B. Painter died in 1883. The business closed in 1884, the plant going to the American Type Founders Company.

Hawks & Shattuck began to make type in San Francisco in 1833, under the name of the Pacific States Type

Foundry. When Hawks retired the business was reorganized as an incorporated company.

Luse & Co. established a type-foundry in San Francisco in 1878, of which N. C. Hawks was resident partner and manager. In 1884 the foundry was sold to Palmer & Ray.

John Ryan began a type-foundry at Halliday street, Baltimore, in 1854. In 1857 a corporation was formed under the title of the John Ryan Co. John Ryan, the founder of the business and first president of the company, died May 8, 1888. It is now a branch of the American Type Founders Company.

Holmes & Curtis began a type-foundry in Devonshire street, Boston, in 1847. Holmes retired in 1852. E. A. Curtis continued the business for ten or twelve years, when E. Z. Mitchell was admitted as partner. Mitchell died in 1880; Curtis died in 1888. The foundry was continued by Caroline Curtis, executrix, under the name of Curtis & Mitchell, but it afterward continued under the name of Palmer & Pruden.

Samuel C. Collins and Alexander M'Leester began the business of type-founding at Philadelphia in April, 1823. Collins died July 13, 1883. His interest was bought by Thomas A. Wiley. In March, 1887, M'Leester bought Wiley's interest. The business was carried on under the management of Eugene H. Munday until it was merged in the American Type Founders Company.

Barnhart Bros. & Spindler (A. M. Barnhart, Warren Barnhart, and Charles E. Spindler) began type-founding at 105 East Madison street, Chicago, in the year 1868. They made four branches: The St. Louis Printers' Supply Company; The Great Western Type Foundry, Omaha; The Great Western Type Foundry, Kansas City; The Minnesota Type Foundry Company, St. Paul. In 1891 the proprietors were: A. M. Barnhart, E. Barnhart, A. S. Barnhart, B. G. Stein, Charles E. Spindler, Charles Murray, and W. H. French. Since 1891 branches have been established in Seattle and San Francisco.

The type-foundry of Marder, Luse & Co. of Chicago was established in the year 1855 by Charles T. White & Co. of New York, and was then called the Chicago Type Foundry. On the first day of October, 1863, the firm was changed to D. Schofield & Co., and the next year to Schofield, Marder & Co. (David Schofield, John Marder, Henry Porter), Portland, who had his interest in John Collins and retired in 1865. In 1869 Collins retired, selling his interest to A. P. Luse, and the firm became Marder, Luse & Co. After the great fire of 1870, Carl Mueller became a partner, and so remained until July, 1883, when he sold his interest to Marder & Luse. In 1880 Schofield sold his interest to the remaining partners. In July, 1883, the business was reorganized as a stock company, of which John Marder was president, A. P. Luse, vice-president, and John W. Marder, secretary. Collins died in 1873; Mueller in 1885; Luse in 1891. It is now a branch of the American Type Founders Company.

The Central Type Foundry was established at St. Louis, Missouri, in the year 1875, by C. Schraubstaeder and J. A. St. John, formerly of the Boston Type Foundry. In 1892 St. John retired, and the business was sold to the American Type Founders Company.

The type-foundry of John F. Reton & Son at Kansas City, Missouri, was there established in the year 1872 by John Reton. His son John B. Reton was admitted as partner in 1892. It is now a branch of the American Type Founders Company.

The type-foundry of Lewis Pelous & Co., Philadelphia, was there established in the year 1841 by Edward Pelous; in the same year the foundry was sold to Lewis Pelous. In 1870 the firm-name was changed to Lewis Pelous & Co., by sale of interest to H. L. Hartshorn. Lewis Pelous died in 1878, and H. L. Hartshorn became sole owner. In 1876 William M. Hartshorn became a partner. In 1878 John K. Telfow was admitted as partner. In 1880 W. M. Hartshorn retired; in 1883 J. K. Telfow retired, leaving H. L. Hartshorn sole proprietor. Between the years 1865 and 1875 H. L. Hartshorn managed the business of Lewis Pelous & Co. at Richmond, Virginia. It is now a branch of the American Type Founders Company.

The Keystone Type Foundry was established at Philadelphia in 1888 by the Mather Manufacturing Company, who continue as proprietors. The manager is Walter J. McKee.

The Cleveland Type Foundry was established at Cleveland, Ohio, in the year 1876, by the H. H. Thorp Manufacturing Company (H. H. Thorp, president; F. J. Berry, secretary; L. Hickman, treasurer; and F. H. Bultman, superintendent). It is now a branch of the American Type Founders Company.

The Union Type Foundry of Chicago was established in that city in the year 1872 under the name of the Mechanics' Type Foundry, by former employes of Marder, Luse & Co., and controlled by different managers until 1884, when it was incorporated under its present name. In 1888 it bought out the Manhattan Type Foundry of New York, taking all their material. It is now managed under

the general direction of the American Type Founders Company.

The Cincinnati Type Foundry was established in that city in the year 1817 by Oliver Wells, Horace Wells, and John White. After several changes in partnership, in 1830 it was made a stock company. Its managers since 1861 have been Charles Wells, Henry Barth, and W. F. Hunt. Charles Wells died in 1895. It is now a branch of the American Type Founders Company.

John G. Mengel & Co. began a type-founding business at Baltimore in 1881. John G. Mengel, Jr., had been a partner of John Ryan. John G. Mengel, Sr., became a partner in February, 1883. This foundry is now a branch of the American Type Founders Company.

The St. Louis Type Foundry was established at St. Louis in 1840 by George Charles of the Johnson Foundry of Philadelphia. In 1844 he sold it to A. P. Ladew of Albany, N. Y. In 1847 Ladew sold one-half to T. F. Purcell of Louisville. In 1855 Purcell sold his interest to V. J. Peers of St. Louis. In 1860 Ladew became sole owner, but in 1861 he sold out to the Cincinnati Type Foundry. In 1861 the business was incorporated as the St. Louis Type Foundry. It is now a branch of the American Type Founders Company.

In 1856 Lawrence Johnson of Philadelphia established a branch foundry in Cincinnati, and put it under the management of Robert Allison, an employee, who afterward became its owner. It was then known as the Franklin Type Foundry. In 1868 M. Smith became a partner. In 1892 it was merged in the American Type Founders Company, and is now known as Branch 10 of that concern.

The Boston Type Foundry began in 1817. It undertook to cast types, set types, and make stereotype plates. Its first specimen book of 1830 announces Timothy Beddington and Charles Ewer as proprietors, who offer to sell nonpareil at one dollar and forty cents and pearl at one dollar and seventy-five cents per pound. Between 1830 and 1838 the Boston Type Foundry gave much encouragement to David Bruce, Jr., who was then experimenting with his type-casting machine. Before it was organized as a corporation in 1840, James Conner had been the manager of the stereotyping and Michael Dalton of the type-founding departments. Its first president was C. C. Little, and its first agent John Gorham Rogers. Sewall Phelps was then at the head of the stereotype foundry. James Shute succeeded J. G. Rogers. About 1849 the stereotype branch of the business was sold. Soon after the type-foundry was sold to John K. Rogers, David Watson, and Edward Pelouse, who did business under the name of John K. Rogers & Co. After Pelouse retired in 1871 the business was carried on under the name of the Boston Type Foundry. Soon after a branch at St. Louis was established under the charge of two employees of the house, James A. St. John and Carl Schraubstadter. John K. Rogers' interest was bought by St. John and Schraubstadter, who afterward sold the business to the American Type Founders Company.

John Kimball Rogers, once a prominent member of the Boston Type Foundry, was born at Gloucester, Mass., on the 31st of January, 1821. He died at Longwood, Mass., on the 27th of January, 1886.

The type-foundry of C. J. Cary & Co. of Baltimore was here established in 1804 by Robert Sower. Its subsequent proprietors were: R. B. Spaulding, 1818; F. Lucas, Jr., 1832; Lucas Brothers, 1854; Henry Lucas, 1860; F. H. Lucas, 1872; Henry L. Pelouse & Son, 1879; C. J. Cary & Co., 1893.

The Washington Type Foundry was established in 1869 as a branch of the Richmond Type Foundry, then under the management of H. L. Pelouse. It was afterward managed by different members of the Pelouse family. It is now managed by J. H. Mills & Co.

Philip Heinrich, a type-founder of Frankfort, Germany, came to this country in 1849. For ten years after he was in the employ of type-founders of New York and Philadelphia. In 1859 he began business as a master type-founder. He died in 1893.

In 1872 the New York Printing Co. was making text-types for its own use, but this branch of its business is not done now by its successors. George Munro is the only printer of New York who undertakes to make types for his own needs.

In 1856 S. R. Walker and H. L. Pelouse of New York added type-founding to their previous business of lead-casting. In 1856 they established a small type-foundry in Richmond, Virginia. In 1860 the partnership was dissolved, Pelouse taking the Richmond foundry. After Walker's death in 1866, the business was continued by his son Samuel B. Walker, and R. F. Cole. Theodore Tuthill and P. H. Bresnan were subsequent partners. Since 1883 the firm-name has been Walker & Bresnan.

Robert and John Lindsay (brothers to James) began type-founding in New York in 1852. Another brother, Alexander W., became a third partner in 1856, in the new firm of R. & J. & A. W. Lindsay. Alexander W. subsequently established a separate business which was continued for many years. In 1892 he merged it in the American Type Founders Company. The older Lindsay Type Foundry afterward continued the business under the name of Robert Lindsay & Co.

In the autumn of 1882 the American Type Founders Company was established, with a capital stock of nine million dollars, which was afterward reduced.

The company was formed to acquire and carry on the business of the following firms and corporations:

Mackellar, Smiths & Jordan Co., Philadelphia.

Collins & M'Leester, Philadelphia.

Pelouse & Co., Philadelphia.

James Conner's Sons, New York.

P. H. Heinrich, New York.

A. W. Lindsay, New York.

Charles J. Cary & Co., Baltimore.

The John Ryan Co., Baltimore.

J. G. Mengel & Co., Baltimore.

Hooper, Wilson & Co., Baltimore.

Boston Type Foundry, Boston.

Phelps, Dalton & Co., Boston.

Lyman & Son, Buffalo.

Allison & Smith, Cincinnati.

Cincinnati Type Foundry, Cincinnati.

Cleveland Type Foundry, Cleveland.

Marder, Luse & Co., Chicago.

Union Type Foundry, Chicago.

Boston, Waldo & Co., Milwaukee.

Central Type Foundry, St. Louis.

St. Louis Type Foundry, St. Louis.

Kansas City Type Foundry, Kansas City.

Palmer & Ray, San Francisco.

In the prospectus of the company it was claimed that the above-named twenty-three companies and firms manufacture and sell about eighty-five per cent. of the entire output of type in the United States.

The principal foundries that declined to be merged in the company were:

Farmer, Little & Co., New York.

George Bruce's Son & Co., New York.

Barnhart Bros. & Spindler, Chicago.

The types most used on daily newspapers are now (1899) made by many of the offices on the linotype machine. The diversion of this branch of type-founding to the new process has not apparently affected the output of the American Type Founders Company, who still continue to make book and job types by the older method for a steadily increasing demand.

In the preceding illustrations, twenty-two distinct sizes are shown, ranging from the large size of six-line pica, which is nearly one inch in height of body, and the small size of brilliant, which is about one-twentieth of an inch in height of body. Between the sizes of nonpareil and pica, the difference of each body from its proximate body is about one seventy-second part of an inch; between all proximate sizes below nonpareil, about one one-hundred-and-forty-fourth of an inch. The inexpert may say that there are too many bodies, but there is need for all of them. The early printers, who printed books with half the number, worked to great disadvantage. The so-called irregular sizes, which are almost as common as the regular, enable modern publishers to make books and newspapers to suit every taste. A book in small-pica costs less than one in pica, yet it is equally readable. The advertisements in nonpareil that overcrowd a newspaper are quite as acceptable when set in agate, even if they occupy a smaller space.

In the illustrations of sizes shown on pages 76 to 105, the types of the facing pages are precisely the same. The difference in their appearance is produced by leading. The lines of the even page are "solid," or as close together as they can be brought; the lines of the odd page have been separated by the insertion of thin pieces of soft type-metal known as leads.

These leads, like the quadrats and spaces which separate words, are not quite type-high; they do not appear in print, not being touched by the inking rollers. Leading between lines of composed matter makes print more readable, by giving more white space in a place where relief is of advantage. The selection of the thickness of the lead is usually a matter of taste, but to some extent it should be determined by the face of type with which the lead is used. Large types need thick leads; small types, thin leads.

Thickness of a three-to-pica lead.



Thickness of a four-to-pica lead.



Thickness of a six-to-pica lead.



Thickness of an eight-to-pica lead.



Thickness of a ten-to-pica lead.



Thickness of a twelve-to-pica lead.



Two forms of leads are made: high leads, about seven-eighths of an inch high, which reach to the shoulder of the type, and are employed only in fine stereotype or electrotype work; low leads, about three-fourths of an inch high, or of the same height as ordinary quadrats, which are used only in letter-press work. They are usually cast in a mould, in strips about eleven inches long, which are afterward cut to

Leads made
of different
forms

prescribed lengths. Some leads are made by rolling machines. In many daily newspaper offices the strips, which are there subject to harder usage than in book offices, are made of rolled brass. These are called brass-leads or brasses; the latter is better. The size most used is that known as six-to-pica, but founders furnish them of any thickness from three- to fourteen-to-pica. The thickness of two-to-pica is known as a nonpareil slug, and all other thicknesses that correspond with the regular bodies of type are known by the names of their bodies, as pica slugs or brevier slugs. Slugs are often used by book printers as the foot-lines to pages, and also to separate the columns of pages.

Old-style faces had to be selected as the illustrations of sizes, for it was not possible to show a harmonious series of faces in roman of modern cut. Many American founders can show in gothic, antique, or other forms of display letter, a harmonious series from pearl to six-line pica, but they cannot show this harmony in any complete series of roman book-letter. The smaller sizes made by the type-founders are extra wide, or narrow, or bold, or light, to suit the needs of their largest customers, the publishers of newspapers. The larger sizes, above great-primer, are usually made extra bold and black, to suit the needs of job printers. Sizes larger than great-primer are so rarely used for book-work, and yet so largely used for posting-

Modern book-
types seldom
cut in series

bills, that founders are led to make only those faces that are most serviceable for job printing.

The illustrations of the sizes of type set forth on pages 76 to 105 are also intended to exhibit the number of words and the number of ems that fill the fixed space of one full page of this size, or of 15 square inches. They show the loss in lines and words that follows the insertion of leads, and the gain in words made by the change from a larger to a smaller type. Yet they show but imperfectly the relative proportions of type-bodies, and the exact relations of the bodies to their faces. The sizes meridian and paragon were omitted, because suitable faces of book-types are not made upon these bodies. The sizes from double small-pica to five-line pica, inclusive, are from the old foundry of MacKellar, Smiths & Jordan Co., and are mainly true old-styles of Caslon design. The sizes english to nonpareil, inclusive, are from the old foundry of George Bruce's Son & Co., and are all old-styles of modern design. The illustrations of columbian, agate, diamond, and brilliant, from several foundries, are also of modern design, but are destitute of all old-style features. Coming from different foundries, cut by different punch-cutters at widely distant periods, and cast upon bodies graded by different systems, these illustrations of sizes do not show relative proportions with a becoming precision. The columbian seems larger than the

110 *Difficult to Identify Bodies by Faces*

great-primer; the agate seems to be larger than the nonpareil; the bourgeois does not appear, as it should, the true intermediate of brevier and long-primer. These irregularities of type face are the results of attempts to make for printers special faces suiting special purposes, for one size only, and not for a full series of sizes. Founders have been persuaded to cut mongrels of new forms: as large a face as can be got upon the body, or nearly as large as the next larger size, or but very little larger than the next smaller size, or faces that are wider or thinner than the standard forms. Types so made, and there are too many of them, break the regularity of a graded series of sizes. The agate with shortened ascenders and descenders is really of a larger face than the nonpareil, but is called agate because it is on an agate body. The bourgeois may be nearly as large as a long-primer, but it is called bourgeois because it is on a bourgeois body. The body determines the name. As the exact size of the body is not seen in the print, it is often difficult, even for the expert, to accurately name the body of a type from a hasty inspection of its face.

The body of the text-type used in any piece of print that has been "set solid" or without leads, can be approximately ascertained by measuring it with a rule. One inch should cover 6 lines of pica, 7 of small-pica, 8 of long-primer, 9 of bourgeois,

10 of brevier, 11 of minion, 12 of nonpareil, 14 of agate, 16 of pearl, and 18 of diamond.¹ For longer measurements than one inch, a type-measurer should be used. The body of solid type can also be determined by finding a quadrat which will completely span the distance between the foot of the first line and the foot of the second one. When the lines of type are leaded, the identification of an unknown body is more difficult. The width of the lead and of the space between lines cannot be measured or safely conjectured. The only test is to put an em quadrat of the supposed body over a full-bodied letter like Q or j. If this quadrat touches or nearly touches the letter at its extreme points, it should be, and probably is, of the same body.

| | | |
|--------|---|---|
| g | y | p |
| d | l | b |
| Solid. | | |

| | | |
|---------|---|---|
| g | y | p |
| d | l | b |
| Leaded. | | |

Types are sometimes leaded with very thin leads, like twelve- fourteen- or sixteen-to-pica, for which all these methods of measurement will be found unsatisfactory. With the ordinary thickness of six-to-pica, the detection of leading is not so uncertain. If there is a decided space of white between the approaching points of ascending and descending letters, the type is probably leaded.²

¹ These figures can be safely used only in a measurement of one inch. Consult tables in the chapter on the Point System.

² Reservation has to be made for the bastard bodies, to which these observations do not apply; but bastard bodies are rare.

112 *Relations of Types to Each Other.*

The relations which each body of the book-types shown in the preceding pages bears to other bodies in solid composition are arithmetically shown by the figures in the following table :

| Sizes of Type. | Ems to the alpha- bet. ¹ | Ems to the line. | Lines in the page, solid. | Ems in the page. | Words in a page, solid. |
|-----------------|--|---------------------|------------------------------------|------------------------|----------------------------------|
| Great-primer | 12 | 12½ | 20 | 250 | 105 |
| Columbian . | 13½ | 14 | 23 | 322 | 122 |
| English . . . | 12½ | 16 | 26 | 416 | 170 |
| Pica | 12½ | 18 | 29 | 532 | 209 |
| Small-pica . | 12½ | 20 | 32 | 640 | 249 |
| Long-primer | 12 | 22½ | 36 | 810 | 319 |
| Bourgeois . . | 12½ | 25 | 40 | 1000 | 383 |
| Brevier. . . . | 13 | 28 | 46 | 1288 | 490 |
| Minion | 13⅔ | 31½ | 51 | 1607 | 588 |
| Nonpareil . . | 14 | 36 | 57 | 2052 | 734 |
| Agate | 16 | 40 | 65 | 2400 | 852 |
| Pearl | 15¾ | 45 | 72 | 3240 | 1015 |
| Diamond. . . . | 13⅔ | 50 | 81 | 4050 | 1391 |
| Brilliant . . . | 15 | 56 | 92 | 5152 | 1763 |

¹ The figures in this column show the relative fatness or leanness of each face of type by specifying the number of em-quadrats of its own body that equal the length of the twenty-six lower-case letters of the alphabet. See page 115.

An em of any type is the square body of that type. As it is impracticable to count all the bits of metal in a page, the em is made a unit of superficial measure. The space that can be covered by one thousand em-quadrats is reckoned as one thousand ems. This method of measuring is never changed for open or leaded composition. One thousand ems may contain three thousand bits of metal if the matter be solid, or only one thousand bits if the matter be leaded and full of quadrats; but in either case the composition is computed as one thousand ems.

In the measurement of the width of a line of composition no account is taken of any smaller fraction than the en quadrat. If the width of the line exceeds even ems by one third of an em, this excess of one third is not counted; if it is an en, or but little less, it is counted as an en; if it exceeds an en, the excess is counted as a full em.

The em quadrat is also made the unit for measuring the fatness or leanness of any face of type, which fatness or leanness is determined by the number of ems that equal in length the alphabet of twenty-six lower-case letters.

The widths of different faces are defined by the number of ems to the lower-case alphabets and by the words standard, lean, condensed, and extra condensed, to specify their progressive decrease in width; and by the words fat, broad-faced, ex-

panded, and extended, to specify their progressive increase in width.

The standard of width is variable. The International Typographical Union has determined the proper width or standard of pica, small-pica, long-primer, and bourgeois at 13 ems; of brevier and minion at 14 ems; nonpareil 15 ems; agate 16 ems; pearl 17 ems; diamond 18 ems. Faces that fall below these standards are unfairly measured by the em quadrat of the next smaller body.

M

Standard.

M

Lean.

M

Condensed.

M

Extra condensed.

M

Standard.

M

Fat.

M

Broad-faced.

M

Expanded.

A lean letter has an alphabet of lower-case letters that is below the standards here given. The bourgeois of 13 ems is up to the standard; the brevier of 13 ems is below the standard.

Condensed letters are now rarely used for the text-types of books or newspapers. There is no rule that limits the use of the word condensed to any specified width, but it may be fairly applied to any face of which the lower-case alphabet measures 10 or 11 ems of its body.

Illustrations of the Widths of Faces 115

| | | Ems. |
|-------------|---------------------------------------|------------------|
| Nonpareil . | abcdefghijklmnopqrstuvwxyz | 16 $\frac{1}{4}$ |
| | abcdefghijklmnopqrstuvwxyz | 14 |
| Lean . . . | abcdefghijklmnopqrstuvwxyz | 13 $\frac{1}{4}$ |
| Fat . . . | abcdefghijklmnopqrstuvwxyz | 19 $\frac{3}{4}$ |
| Expanded. | abcdefghijklmnopqrstuvwxyz | 23 $\frac{1}{2}$ |
| Minion . . | abcdefghijklmnopqrstuvwxyz | 14 $\frac{3}{8}$ |
| | abcdefghijklmnopqrstuvwxyz | 13 $\frac{3}{8}$ |
| Brevier . . | abcdefghijklmnopqrstuvwxyz | 14 $\frac{1}{2}$ |
| | abcdefghijklmnopqrstuvwxyz | 13 |
| Lean . . . | abcdefghijklmnopqrstuvwxyz | 11 $\frac{1}{2}$ |
| Condensed | abcdefghijklmnopqrstuvwxyz | 11 |
| Ex. Cond. | abcdefghijklmnopqrstuvwxyz | 8 $\frac{5}{8}$ |
| Bourgeois . | abcdefghijklmnopqrstuvwxyz | 13 $\frac{3}{8}$ |
| | abcdefghijklmnopqrstuvwxyz | 12 $\frac{1}{2}$ |
| Long-prim. | abcdefghijklmnopqrstuvwxyz | 13 $\frac{1}{2}$ |
| | abcdefghijklmnopqrstuvwxyz | 12 |
| Condensed | abcdefghijklmnopqrstuvwxyz | 10 $\frac{3}{8}$ |
| Small-pica | abcdefghijklmnopqrstuvwxyz | 13 $\frac{3}{8}$ |
| | abcdefghijklmnopqrstuvwxyz | 12 $\frac{1}{2}$ |
| Pica . . . | abcdefghijklmnopqrstuvwxyz | 13 $\frac{1}{2}$ |
| | abcdefghijklmnopqrstuvwxyz | 12 $\frac{1}{2}$ |

An extra condensed letter has an alphabet less than 10 ems in width.

A fat letter has an alphabet but a trifle wider than that of its standard.¹

A broad-faced letter has an alphabet fifteen or twenty per cent. wider than that of its standard.

An expanded letter has an alphabet thirty or forty per cent. wider than that of its standard.

An extended letter has an alphabet fifty per cent. (or more) wider than that of its standard.

¹ The standard of width is of recent introduction. The "London Scale of Prices" of 1810 and the "New York Scale of Prices" of 1833 gave no rules as to a standard, even when lean types were in frequent use. The first American rule (probably 1851) makes the standard 12 ems for all bodies. About 1864 higher standards were determined on for the smaller bodies. In 1886 the standards of all bodies were again increased.

The Caslon old-style faces, marked lean in the previous illustration, fairly represent the average width of the lower-case letters of the last century. The rounder and wider faces that were subsequently introduced by Thorne, Jackson, Bodoni, and Didot did not prove a permanent fashion. They were supplanted by the Scotch-face, and other cuts of letter decidedly below the present standards, and these leaner faces were preferred for

newspapers as well as for books. The modern broad-faces now made for newspapers were sparingly made and little used before 1860. They seem to have been accepted by newspaper publishers because they were a mechanical necessity, for it had been found that stereotyping by the papier-mâché process and presswork on rotary machines could not be done well from the lean types then in use, for they moulded badly, wore out quickly, and made printing muddy and indistinct. To prevent these faults it was necessary to make use of wider types, with broader stems and deeper counters; but these broader faces were accepted reluctantly, for they wasted space. Publishers of books favor the broad-faces for juvenile school-books only; for all standard books in large type they prefer the lean faces. In England and France the faces most used are thinner than the American.

In a comparison of composition done with two distinct faces of type, one of which is 12 and the other 15 ems in width, there will be a corresponding difference in the number of words making one thousand ems; but this difference in the count does not modify the rule. Irregularities in the thickness of types should be allowed for in all computations of space or proportion. In every exact calculation as to the space that will be occupied by a proposed type, its number of ems to the alphabet should be ascertained.

The unfairness of measuring composition by the em quadrat is shown by the illustration on the next leaf. The four faces there shown are on long-primer body, and the measure of each is twenty ems of long-primer. The composition in each face is now measured as one hundred ems, but the number of words set are respectively 44, 42, 38, 25. The compositor of the thin type has then to do much more labor to have his composition counted as one hundred ems.

The progressive widening of letters for small bodies was not a whim of the punch-cutter: it was really obligatory. In cutting a series of uniform faces the type-founder has to widen each smaller alphabet, to make it seem uniform with the larger size, and to maintain a proper degree of clearness and durability. A small type cut to the same geometrical proportion as a large type would seem condensed and

not of the same style. The legibility of a small text-type depends more upon the width of its letters than upon their height. A wide or broad-faced letter is always more readable than a condensed letter, because it seems of a larger body. The increased width now given to the small sizes may have been thought sufficient justification for the new standards, but they have destroyed the value of the em as a unit of measure. The term one thousand ems, as now used, does not fairly describe the amount of a compositor's labor, or even approximately the number of words in his composition. Under present standards the compositor of books has to set from one fifth to one half more matter than the news compositor to have it rated as one thousand ems. At the same rate and on the same copy a slow compositor can earn more on agate than a quick compositor can on long-primer. The standard of 13 ems for book-types practically puts a penalty on the use of the Caslon-face, the French-face, the Scotch-face, and nearly every popular face made before 1860, to the great damage of the type-founders and printers who have these styles. No doubt the new standards were made in the belief that the broad faces of the newspapers would be accepted by publishers of books, but the opposition of publishers is as strong now as it was thirty years ago.

A new method of measuring composition has recently been offered.

11½ em quadrats to the lower-case alphabet.
26½ lower-case ems to the measure.

Open your watch and look at the little wheels, springs and screws, each an indispensable part of the wonderful machine. Notice the busy little balance-wheel as it flies to and fro, day and night, year in and year out. This wonderful machine is

12⅛ em quadrats to the lower-case alphabet.
25¼ lower-case ems to the measure.

Open your watch and look at the little wheels, springs and screws, each an indispensable part of the wonderful machine. Notice the busy little balance-wheel as it flies to and fro, day and night, year in and year out. This wonderful

13⅝ em quadrats to the lower-case alphabet.
23¼ lower-case ems to the measure.

Open your watch and look at the little wheels, springs and screws, each an indispensable part of the wonderful machine. Notice the busy little balance-wheel as it flies to and fro, day and night, year in and

18⅓ em quadrats to the lower-case alphabet.
16⅞ lower-case ems to the measure.

Open your watch and look at the little wheels, springs and screws, each an indispensable part of the wonderful machine. Notice the busy little balance-

Alexander Spencer proposes that the ten lower-case letters most used should be selected as the basis for a system of measuring composition by letters. These ten letters, e, t, a, i, s, o, n, h, r, d,¹ are to be set up repeatedly in the line to be measured until the line is full. The number of letters that can be put in the stick, including the final justifying space if any, is to be accepted as the proper number of letters of count for width.

The letters selected are thin, but the gain therefrom is not so great as might be expected. It will vary with the width of the measure, making from five to eight per cent. more than would be had from the older method of measuring with all the letters. The merit of this system is in its removal of restrictions on type-founders, but the selection of the ten most used letters and a possible added space is a factitious basis for a system of measurement that is intended to be equitable.

In the French method the space taken by the twenty-four letters of their alphabet is computed as twenty-four letters. The number of letters is determined by filling the line to be measured with repetitions of the alphabet, and counting the letters that can be put in the stick. The number of

¹ Mr. Spencer selects his ten letters from a table in Brewer's "Dictionary of Phrase and Fable" (p. 507), which gives the following figures as the proportionate use of lower-case letters:

| | | | | | | | |
|---|------|---|------|---|------|---|-----|
| e | 1000 | h | .540 | f | .236 | v | 120 |
| t | .770 | r | .528 | w | .190 | k | .88 |
| a | .728 | d | .392 | y | .184 | j | .55 |
| i | .704 | l | .360 | p | .168 | q | .50 |
| s | .680 | u | .296 | g | .168 | x | .46 |
| o | .672 | c | .280 | b | .158 | z | .22 |
| n | .670 | m | .272 | | | | |

letters so ascertained in one line is multiplied by the number of solid lines in the length of the matter composed. This method is as elastic The French method as it is correct. The compositor gains nothing by thick and loses nothing by thin letters. As the entire lower-case alphabet is made the basis of count, no unfairness can be practised with any unduly thickened letter.

The English unit for measuring composed matter is the en quadrat. The number of ens in the line to be measured is multiplied by The English method the number of solid lines. The unit is different, but the method of measurement is the same as that of the United States. One thousand ens English equal five hundred ems American.

The International Typographical Union of North America recently formulated a new New rules for width method for determining the correlative widths of lower-case types, and as a proper basis for the measurement of composition. The lower-case alphabet must be divided in two equal parts, with thirteen letters in each part. The part that contains the letters c, d, e, i, s, m, n, h, o, u, a, t, z, must be of the same length as the part containing the other thirteen letters. This new regulation, which seems to have been made as a safeguard to prevent the capricious thickening of the width of any one type to the disadvantage of the piece compositor, is of doubtful general utility. Since the introduction in composing-rooms of the Linotype

and Lanston, and of other type-casting machines, there has been a marked decline in the practice of piece composition. All the new type-making and type-setting machines are constructed to favor the production of types on a wider set. The nominal or measurable production of these machines is largely increased by greater fatness in the types, which are rarely less than ten per cent. (and are sometimes twenty per cent.) fatter than types made after the old standards of good form.

Set is the word used by type-founders to define the set or adjustment of the mould, which determines the width of each type. An en quadrat is on the en set; a three-to-em space is on the three-to-em set; the period is usually on the five-to-em set. When a printer wishes a character cast to a prescribed width, he should define its proposed width by the word set.





III

The Point System

ONE of the defects of the old system of naming types was this—the old names did not define the bodies. Small-pica was intended for a body half-way

Old names
did not de-
fine bodies

between pica and long-primer, but in one foundry it might be of nearer approach to long-primer, and in another but little smaller than pica. There was no agreement among founders as to the exact dimensions of small-pica, long-primer, or any other body. Hansard says: "In one office I knew of eight fonts of pica which bore the following proportions to a foot measure: $71\frac{1}{4}$, $71\frac{1}{8}$, $70\frac{3}{4}$, $71\frac{1}{8}$, 71, $71\frac{1}{4}$, $71\frac{1}{2}$, $71\frac{1}{4}$."¹

To the novice these irregularities seem trifling. The variation between a pica 71 lines to the foot

¹ "Typographia," p. 385.

and another pica $71\frac{1}{4}$ lines to the foot is not a three-hundredth part of an inch—a variation that cannot be seen and that can scarcely be felt. If two bodies like these could always be kept apart, each body being used in detached lines or in distinct work, this variation might be trifling. But an entire separation of the different bodies in the same office is practically impossible. Types of different bodies sometimes have to be used in the same work—to be made up, side by side, in pages of fifty lines or in columns of two hundred lines. They often have to be used together in the same line. If the type-body of one page of fifty lines is one three-hundredth part of an inch shorter than that of another page, then the first page will be one-sixth of an inch shorter than its mate. In a column of two hundred lines, the difference will be two-thirds of an inch. If the two discrepant bodies be put in the same line, as they have to be in the displayed words of a catalogue or a dictionary, the difference in bodies which is unnoticed in the first line makes a serious crookedness in the tenth line, and this crookedness will keep increasing with every succeeding line.

In all offices the rule prevails that there must be no mixing of types from different foundries, even if they are apparently of the same face and body. To disobey this rule is to create disorder; to mix the types of two fonts spoils both fonts.

The contrasting, side by side, of a composition of twenty or more lines of two fonts that seem alike will prove that they are seriously unlike. This dissimilarity may be noticeable not only in the bodies of different foundries, but even in bodies that have been made by the same founder at different times.

It is of the first importance that types should be accurate, yet it is difficult to make them of unvarying accuracy. The mould of steel will swell and wear; the matrix of copper is extremely liable to imperceptible displacements. Changes in the composition of the metal, and in the degrees of heat, produce corresponding changes in the dimensions of founded types. A little more or a little less pressure in rubbing the type will make corresponding differences in the size of the body. In all reputable type-foundries these tendencies to irregularity are kept under control, and seldom lead to faults serious enough to justify complaint. A printer can order sorts to-day to supplement a font cast twenty-five years ago, with confidence that the new and the old can be safely used together. But this rigid accuracy is maintained only by testing the types as they are cast with instruments of precision that were not used by type-foundries a hundred years ago. The accuracy of the exactest founder who cast type under old systems was only of partial benefit to the printing trade. As a rule, his sizes

Difficult to
make type
accurate

differed, and in some instances purposely differed, from those of other founders. The printer who had to buy from all foundries could not use the types of two or more foundries in the same line or even on facing pages; he could not safely mix the spaces and quadrats of different fonts; he could not even determine an exact measurement by the count of ems. There was no standard.

These irregularities are the inherited misfortunes of printing. They can be seen in the types of the first printers, who were their own founders, who cast their types in a rude adjustable mould (now entirely out of use), which could be made larger or smaller so as to cast two or more bodies. For the sake of its cheapness the early printer preferred the mould which made many bodies to that which made one body only. In the continued readjustments of this mould for different castings, the inexpert founder made unintended deviations and irregularities of body which he and his successors were obliged to perpetuate.

Moxon,¹ writing in 1683, named ten bodies as those most used in England. He admits that the Dutch had several other bodies, but he did not think them worth naming, as they differed but little from the English bodies. "Yet we have one Body more which is sometimes used in England: that is the Small-Pica, but I

¹ "Mechanick Exercises," pp. 13, 14.

account it no discretion in a Master Printer to use it because it differs so little from the Pica." He gives us this table, "wherein is set down the number of each Body that is contained in one Foot."

| | | | |
|-------------------|-----|----------------------|-----|
| Pearl..... | 184 | English..... | 66 |
| Nomparel | 150 | Great-Primmer | 50 |
| Brevier..... | 112 | Double-Pica | 38 |
| Long-Primmer..... | 92 | Two-Lin'd English... | 33 |
| Pica..... | 75 | Great-Cannon | 17½ |

Luckombe,¹ writing in 1770, gives another table of the proper dimensions of bodies (probably those of the first Caslon), which shows that the bodies then made deviated largely from the standards that had been laid down by Moxon:

| | | |
|---------------------------|-----------------|--------------|
| French Canon..... | 18 and a | Great Primer |
| Two Lines Double Pica.... | 20 and ¾ | |
| Two Lines Great Primer... | 25 and an n | |
| Two Lines English..... | 32 | |
| Two Lines Pica | 35 and ¾ | |
| Double Pica..... | 41 and an n | |
| Paragon..... | 44 and an n | |
| Great Primer..... | 51 and an r | |
| English | 64 | |
| Pica | 71 and an n | |
| Small Pica | 83 | |
| Long Primer | 89 | |
| Burjois..... | 102 and a space | |
| Brevier | 112 and an n | |
| Minion..... | 128 | |
| Nonpareil | 143 | |
| Pearl..... | 178 | |

¹ "History of Printing," p. 222.

From this it appears that six new sizes had been introduced which Luckombe declared were not really needed. He says: "How much less value, therefore, would Mr. Moxon have set upon Minion, Burjois, and Paragon had he ever seen them."¹

The old Caslon foundry, from which Luckombe probably obtained his measurements, was justly considered the first in England, but its inability to be true to its own standards and others is shown by Hansard's² comparison of the Caslon bodies of 1770 with those made in 1824. In 1825 he published in his "Typographia" a carefully engraved diagram of the sizes most used, printed on dry paper to prevent shrinkage; this showed decided variations from the standards of 1770. In 1842 Savage, for his "Dictionary of Printing," procured from the same foundry the

¹ Luckombe intimates that all these so-called irregular bodies are but accidents; that when a new face had been cut too large for the body for which it was intended, and too small for another, this new face was put on an intermediate body. It is evident that the early founders made types to suit themselves, with no regard for the needs of printers. Luckombe describes the "saving way" of a "Mr. Jaleson, who was a letter-founder from Germany, and lived here in the Old Bailey," who with three sets of punches offered to make brevier and long-primer from

one set, pica and english from another, and great-primer and double pica from the third set. "History of Printing," p. 225.

² Hansard, while admitting that the irregularities of type originated in the want of some generally understood standard, puts the greater blame on those printers, who "from a love of singularity and a desire to avoid the inconvenience of lending sorts . . . still order their fonts to be cast on an irregular body." "Typographia," p. 384. This lending was also avoided in another way by printers who had their types made low to paper.

Savage's Comparison of Standards 129

measurements of the bodies as then made, which did not exactly agree with those that had been given by Hansard in 1825. Savage also gave the following table of the measurements of the bodies made by the leading founders of Great Britain.

*Lines of Different Sized Type in One Foot.*¹

| Bodies. | Moxon, 1683. | Caslon, 1841. | V. & J. Figgins, 1841. | Thorow- good & Besley, 1841. | Alex. Wilson & Sons, 1841. |
|-------------------------------|-----------------|------------------|------------------------------|---------------------------------------|-------------------------------------|
| Diamond | ... | 204 | 205 | 210 | 204 |
| Pearl | 184 | 178 | 180 | 184 | 178 |
| Ruby | ... | 166 | 165 | 163 | 166 |
| Nonpareil | 150 | 144 | 144 | 144 | 144 |
| Emerald | ... | ... | 128 | ... | 128 |
| Minion | ... | 122 | 122 | 122 | 122 |
| Brevier | 112 | 111 | 107 | 112 | 111 |
| Bourgeois | ... | 102 | 101½ | 103 | 102 |
| Long Primer | 92 | 89 | 90 | 92 | 89 |
| Small Pica | ... | 83 | 82 | 82 | 83 |
| Pica | 75 | 72 | 72½ | 72 | 72 |
| English | 66 | 64 | 64 | 64½ | 64 |
| Great Primer | 50 | 51 | 51 | 52 | 51 |
| Paragon | ... | 44½ | 44½ | ... | 44½ |
| Double Pica | 38 | 41½ | 41½ | 41 | 41½ |
| Two-line Pica | ... | 36 | 36 | 36 | 36 |
| Two-line English | 33 | 32 | 32 | 32¼ | 32 |
| Two-line Gt. Primer | ... | 25½ | 25½ | 26 | 25½ |
| Two-line Dbl. Pica | ... | 20¾ | 20¾ | 20½ | 20¾ |
| Trafalgar | ... | 20 | 20 | ... | 20 |
| Canon | 17½ | 18 | 18 | 18 | 18 |

¹ Savage's "Dictionary of Printing," p. 802.

The deviations of leading type-founders in the United States in the year 1856 were as serious, as will be seen in the following table. From these figures it does not appear that any American founder had copied the standards of any British founder.

*Comparative Scale of Ems in the Linear Foot.*¹

| Bodies. | A London foundry. | Bruce's New York foundry. | A Phila. foundry. | A New York foundry. | A Boston foundry. |
|---------------------------|-------------------------|---------------------------------|-------------------------|---------------------------|-------------------------|
| Diamond | 205 | 201.58 | 204.50 | | |
| Pearl | 178 | 179.59 | 179 | | |
| Agate | | 160 | 165 | | |
| Nonpareil | 143 | 142.54 | 145 | | |
| Minion | 122 | 126.99 | 119 | 128 | 124.50 |
| Brevier | 112.50 | 113.13 | 109 | 112 | 115.66 |
| Bourgeois | 102.50 | 100.79 | 103.25 | 102.50 | 104.50 |
| Long Primer | 89 | 89.79 | 90 | 90.50 | 90 |
| Small Pica | 83 | 80 | 83 | 86.25 | 84.50 |
| Pica | 71.50 | 71.27 | 73 | 72 | 72 |
| English | 64 | 63.49 | | | |
| Columbian | 56.25 | 56.56 | | | |
| Great Primer | 51.25 | 50.39 | | | |
| Paragon | 44.50 | 44.89 | | | |
| Dbl. Small Pica | 41.50 | 40 | | | |
| Dbl. Pica | 35.75 | 35.63 | | | |
| Dbl. English | 32 | 31.74 | | | |
| Dbl. Columbian | | 28.28 | | | |
| Dbl. Gt. Primer | 25.62 | 25.19 | | | |
| Dbl. Paragon | | 22.44 | | | |
| Meridian | 20.75 | 20 | | | |
| Canon | 18.33 | 17.81 | | | |

¹ "Printer's Miscellany," New York, July, 1857.

Variations in the height of types have not been as marked as variations in body. English and American founders came to a practical agreement at the beginning of this century that the standard of height should be eleven-twelfths of an English inch. George Bruce of New York made the only exception; his standard was a little higher. In France the height of type had been fixed by law at ten and a half geometric lines, a fraction less than eighty-eight one-hundredths of the old French inch. Modern French types are higher than American types; the two heights cannot be used together. German types were still higher, but are now made to the French standard.¹ The types of Russia and Poland, once more than one inch in height, are now made to conform to the Berthold system.

Attempts have been made to reduce the height, but a mass of types much shorter than those now in use could not be made secure in a chase.

While it does not appear that any founder's sizes of types were based upon a generally recognized measure, there was some understanding that the bodies from nonpareil to small-pica, inclusive, should be limited to six. It was found that these six bodies were enough to make all the gradations

¹ This reform was made by Heinrich Berthold, a prominent type-founder of Berlin, under the guidance of professors of the Berlin Astronomical Observatory. He modelled and had constructed several standards of steel and sent one gratuitously to every German type-founder.

in size demanded by printer, publisher, or reader. There also seems to have been an understanding that all larger and smaller bodies should be made by halving or doubling the six standard sizes. Pica was the double of nonpareil, and english the double of minion. Pearl was the half of long-primer, and diamond the half of bourgeois. The English names of double pica, double english, and double great-primer show that these dimensions were or should have been determined by the three smaller bodies. But these three small bodies were often inexact, or out of proportion with each other, and the doubling and redoubling of their bodies exaggerated the fault. If the small-pica had been made but little larger than long-primer, then the double small-pica would be but little larger than paragon. There would be a wide gap between the double small-pica and the double pica, and this gap would be still more conspicuous in the redoubled size of meridian when contrasted with canon.

A simple plan for securing uniformity in bodies was proposed in 1824 by James Fergusson of Scotland, in the following words:

Plain and Accurate Rules for obtaining Permanent Uniformity in the Sizes of the Bodies of Types, and in their Height to Paper.

1. Let the fount called Nonpareil be made the fundamental standard, and make 12 lines of Nonpareil measure exactly one inch.

2. Let 14 lines of Nonpareil be the common measure for all other founts; this measure to take in 5 lines of Great Primer, 6 of English, 7 of Pica, 8 of Small Pica, 9 of Long Primer, 10 of Bourgeois, 11 of Brevier, and 12 of Minion.

3. Let 11 lines of Nonpareil be the standard of height to paper.

A conformity with these rules would evidently prove of great benefit to Printers and might ultimately not be less so to Letter-founders. If adopted, the bodies of English, Pica and Small Pica will be a little enlarged; Long Primer and Brevier a little diminished.¹

Fergusson's plan was never adopted. In 1841 Bower, a type-founder of Sheffield, proposed the establishment of a graduated scale of sizes based upon pica as the common standard, but his proposal was never accepted by the trade.

The first practical attempt at uniformity was made in France by the type-founder Pierre Simon Fournier, about the year 1737. In his "*Manuel Typographique*" of 1764 he gives this explanation of his system of Typographic Points:²

This subject needs special explanation because it is new and unknown. I place it here to show the new proportions which I have given to the bodies of type by means of the fixed measures that I call Typographic Points.

The last regulation of the Library, made in 1723, fixed the height-to-paper at ten and a half geometrical lines. This rule is as easy to give as to practise; but it

¹ Hansard, "*Typographia*," p. 389.

² Vol. i, p. 125.

was quite another matter when this regulation undertook to establish laws that should govern the dimensions of the bodies. When this regulation was made, no one, apparently, had been found who was competent to give correct information concerning this matter. A proper person was much needed, for he could have corrected abuses, and could have created order and precision where there never had been any. In the absence of better knowledge on this subject, a master printer gave for a standard, with all their imperfections, such types as he found in his own printing office. The regulation based on this standard, not being founded on any proper basis, has not been complied with. This is the reason why the bodies of types have never had fixed and accurate dimensions, and why the irregularity is just as great now as it was before the regulation.

In article LIX of this regulation, it is stated that, to be of proper dimensions, Petit-canon [about double english] should be equal to two bodies of Saint-augustin [english]; that Gros-parangon [double small-pica] should be equal to one Cicéro [pica] and one Petit-romain [long-primer], etc.; but the dimensions which the Saint-augustin, the Cicéro, and the Petit-romain should have, in order to make, by combination, the Petit-canon or the Gros-parangon, are not given. Consequently, any one has opportunity to evade the regulation, and it is done at pleasure, without liability to penalty. One may make a Saint-augustin body smaller than another, and may contract the Petit-canon to double this thickness, but he will comply with the regulation. Another may make this Saint-augustin body more or less too large, and from two of these bodies he may make his Petit-canon; but in this case also the letter of the regulation will be complied with, although it is a clear violation of

the intention. In this way confusion is perpetuated to such an extent that it is sometimes difficult to perceive the distinction between two bodies of type of which the larger size is below the standard, and the smaller size is above it. Then, again, it sometimes happens that in two fonts of the same name the bodies vary more or less, and when they are found in the same printing house, the workmen mix together the quadrats and spaces to the ruin of both fonts.

It may be said that the regulation has provided for this fault, by the rule which obliges founders to receive a certain number of types of each body, to the dimensions of which they are required to conform, under penalty. But these model types, which were only proposed in theory, and which have never been given, would not have remedied the evil that should have been avoided; for bodies so given would have been of undetermined dimensions, without correct proportion, without exact relation, and, in fine, without scientific basis. These pretentious regulations, instead of producing accuracy and order, on the contrary have increased the confusion by multiplying types for which there was no need. Thus we have, according to the regulation, bodies like *Petit-canon*, *Gros-parangon*, *Gros-romain*, *Cicéro*, *Philosophie*, *Gaillarde*, and *Mignone*, without double bodies for the two-line letters, all of which are virtually unauthorized. Here there are seven or eight bodies [of two-line letters only] without names, useless for every other purpose, and a needless expense to the printing office. Moreover, these combinations of bodies — of a *Cicéro* and a *Petit-romain* to make a *Gros-parangon*; of a *Petit-romain* and a *Petit-texte* to make a *Gros-romain*; of a *Petit-texte* and a *Nompareillé* to make a *Saint-augustin* — indicate but slender experience

and capacity in those who proposed them. Why divide these bodies in unequal parts, which lead to nothing, and for which there can be no explanation? This part of the regulation has never been executed.

The defects of existing usages have been perceived, but no one has tried to find the remedy. The printers, who are the only parties who have been consulted on this subject, have not been sufficiently educated as typographers to discuss the question critically, or to make rules for a branch of the art which they do not practise, and of which they often know but little more than the name.

To clear this chaos, and to give this branch of typography an order which never before reigned there, is the subject that has engaged my attention. By the invention of the Typographic Points, I think that I have had the pleasure to be successful, with an accuracy and precision that leave nothing to be desired. This invention is nothing more than the separation of the bodies of types by equal and determinate degrees, which I call Points. By this method, the degrees of separation and the degrees of proximity in the bodies of types may be comprehended with exactness. Types may be combined like arithmetical figures, as, for example, two and two make four; add two, and there will be six; double this, and there will be twelve, etc. In like manner, a Nompaille, which has six points, when added to another Nompaille will make a Cicéro, which has a dozen points; to this add another Nompaille, and there will be eighteen points, or a Gros-romain; double all this, which will make thirty-six points, and there will be a Trismégiste, which has this number. Similar results may be had from all the other bodies, as may be seen in the table of proportions annexed.

To combine the bodies, it is enough to know only the number of typographic points of which they are composed. For this purpose it is of the first importance that these points, or given units, should be invariable, so that they may serve as rules or measures in the printing office, just as the foot [pied-du-roi], the inch, and the line serve in geometry. With this object in view, I have fixed these points of the exact sizes they should have, in the scale which is at the head of the table of proportions; and to make unvaryingly exact the casting of the types, I have devised an instrument which I call a prototype, of which an illustration and description will be given on another page.

At the head of this table is a fixed and standard scale. I have divided it in 2 inches; the inch in 12 lines, and the line in 6 of these typographic points; making altogether 144 points. The first minute divisions are of two points, which is the distance between the body of a *Petit-texte* and of a *Petit-romain*, or from this latter size to the body of a *Cicéro*. The number of points which I allot to each of the bodies should be taken by measure on this scale. If the measures are accurately and specially taken for each body, and are verified upon the prototype, they will establish a systematic gradation of sizes for all bodies of types, as will be demonstrated by the following combinations.

The invention of these points in 1737 is the first service that I rendered to typography. Compelled then to begin a tedious, painful, and laborious task, in the engraving of all the punches needed for the establishment of my foundry, I found no standard rule that could guide me in determining the bodies of the types I had to make. I was thus obliged to make a system

for my own use. That I have done this will be apparent by the following table.

This scale contains in its entirety twelve bodies of Cicéro. After printing and publishing this table in 1737, I noticed that the paper in drying had shrunk a little below the proper dimensions of the scale. In this print I have prevented this error, by making a proper provision for the shrinkage of the paper.

The table appended to Fournier's diagram shows his allotment of typographic points to the bodies then in greatest use. In similar manner the table proceeds through all sizes to eight-line, or Gros-nompaille of 96 points. Each of the larger sizes is not only an exact double of a smaller size, but is the sum of two or more smaller sizes. Every body is an exact multiple of the point; all bodies can consequently be combined with facility and without justification.

After this statement of the evils of irregularity, and of the need of precise standards, the reader properly expects to see a careful print from a copperplate of this standard scale of 144 points, and a statement that the two inches of this scale are inches of a legal standard French measure. Instead of this he is referred to a roughly constructed diagram, undeniably made of bits of rule, badly jointed, and put together so clumsily as to provoke a suspicion of its accuracy. This suspicion is not allayed by the statement of Fournier that he had

The point was not based on legal measure

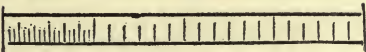
| <p>TABLE GÉNÉRALE DE LA PROPORTION <i>des différens Corps de Caractères.</i></p> | | |
|---|--|--------|
| <p>ÉCHELLE FIXE <i>de 144 points Typographiques.</i></p> | | |
|  | | |
| Nomb. | CORPS. | Points |
| 1 | PARISIENNE. | 5 |
| 2 | NOMPAREILLE. | 6 |
| 3 | MIGNONE. | 7 |
| 4 | PETIT-TEXTE. | 8 |
| 5 | GAILLARDE. | 9 |
| 6 | PETIT-ROMAIN. — 2 Parisiennes, | 10 |
| 7 | PHILOSOPHIE. = 1 Paris, 1 Nomp- pareille. | 11 |
| 8 | CICÉRO. — 2 Nomp. = 1 Parisienne, 1 Mignone. | 12 |
| 9 | SAINT-AUGUSTIN. — 2 Mignones. = 1 Nompareille, 1 Petit-texte. | 14 |

“Manuel Typographique,” facsimile of p. 125, vol. i.

“made provision” (by conjecture?) for a possible alteration in the scale from the shrinkage of wet paper. It is still more astonishing to learn that this rude scale and the prototype (a larger measure of 240 points) are the only standards offered



The height-gauge and its type-support.

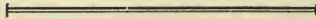

The measuring rod of 240 points.

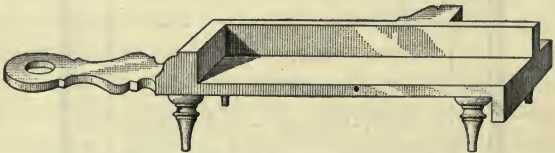

The prototype of 240 points, in reduced facsimile.

for the determination of the bodies. In another part¹ of his book Fournier illustrates his prototype and its measuring rod, his height-gauge and its type-support. He does not minutely describe the use of these tools. We have to infer that accuracy was proved, or inaccuracy detected, by

¹ “Manuel Typographique,” vol. i, p. 303; vol. ii, plate VIII.

feeling with the fingers the types in the prototype, or the height-gauge. In no part of his book does he allude to a micrometer, or to any similar instrument of precision. It is certain that these 240 points were not an even fraction of the standard French foot. They approach more nearly to English measures, but Fournier does not refer to any standard measure for the verification of the accuracy of his scale or prototype. The only standard of appeal is a diagram printed from brass rules, purposely made over large to compensate for the shrinkage of wet paper.¹

Imperfect as it was, Fournier's system promised advantages of real value to printers and founders. The subdivisions made by him permitted the readjustment of the sizes then in use without any serious departure from established bodies. It required but little contraction or expansion of any body to bring it within the bounds of his typographic points. So the system of points was welcomed by printers as a valuable improvement in typography; and in due time it was adopted by all the French type-founders.

Fournier states that his object was to separate the bodies of types at equal and fixed distances,

¹ It is probable that Fournier found some insuperable obstacle in trying to make his point a regular fraction of the French foot; and that he fixed the point so that it would not seriously alter the dimensions of existing sizes, hoping that for this reason it would be accepted by printers and founders.

but it should be noticed that the types themselves, although at equal degrees of distance, are in unequal degrees of proportion as to body. Body 5 is one-fourth larger than body 4; body 6 is one-fifth larger than body 5; and this decrease continues with advancing sizes: body 11 is but one-tenth larger than body 10.

Not long after the death of Fournier, François-Ambroise Didot, the celebrated type-founder of Paris, undertook to improve the system of typographic points. His first step to this end was to base the points upon an authorized lineal measure. For this purpose he selected the royal foot of France (*pied-du-roi*), which is equal to 12.7892 American inches. He preserved intact the subdivisions used by Fournier: the foot contained 12 inches; the inch, 12 lines; the line, 6 typographic points; making, as before, 72 points to the inch.

In the readjustment of bodies made necessary by this alteration the smaller faces of type presented but little difficulty. The *parisienne* and *nompaille* of Fournier could be respectively adjusted on bodies of five and six points of slightly increased dimensions without impropriety. As to the middle sizes, like *gaillarde*, *petit-texte*, and *mignone*, the expansion of the new points was too much. The faces previously made for these sizes were found too large for one body and too small for another. In some instances they

The point
system of
F.A. Didot

Compelled
important
changes

were crowded on smaller bodies; in others they were put on larger bodies; and in still other cases in which the faces could not be transferred, new fractional sizes, like $6\frac{1}{2}$, $7\frac{1}{2}$, and $8\frac{1}{2}$, had to be made. One alteration was especially unfortunate. The *cicéro*, which in Fournier's system was on a body of 12 points, in Didot's system was put on a body of 11 points. The difference was more in name than in fact, nine-sixtieths of a point—an inappreciable difference on a single body; but it was quite enough to destroy the value of the old body of *cicéro*, or *pica*, as the established standard for determining the thickness of leads and furniture.

That each body might be identified with precision, Didot rejected the old names, and gave to each size a numerical name: *parisienne* was called *corps 5*; *nompaille*, *corps 6*; *mignone*, *corps 7*; *cicéro*, *corps 11*, etc. The name defined the body and showed its relations to other bodies.

The simplicity of this numerical classification, the real need of a better standard for bodies than Fournier's prototype, and, more than all, the authority of such an eminent typographer as Didot, were sufficient to constrain many French type-founders to adopt the new system. It was not, however, sufficiently meritorious to overcome every objection. Many printers, some in Paris, but more in the provinces, adhered to the system of Fournier. To the great injury of master printers the two systems were for

Concurrent
use of the
two systems

a long time in concurrent use. A recent French writer on typography states that they were so confounded in 1867 that it was almost impossible in a Parisian office to make an exact measure from a calculation by points.¹

Fournier's system is also known in France as the System Eleven, or the Bastard System, or the Indivisible System. The allotment by Didot of eleven points to the old standard size of cicéro or pica has been wrongly attributed to Fournier, and is supposed to have some mysterious value, for eleven is practically an indivisible number.²

| | Fournier. | Didot. | | Fournier. | Didot. |
|----------------|-----------|--------|------------------|-----------|--------|
| Parisienne .. | 5 | .. 5 | Petit-romain .. | 10 | .. 9 |
| Nompareille . | 6 | .. 6 | Philosophie.... | 11 | .. 10 |
| Mignone..... | 7 | .. 7 | Cicéro..... | 12 | .. 11 |
| Petit-texte .. | 8 | .. 7½ | Saint-augustin . | 14 | .. 12 |
| Gaillarde | 9 | .. 8 | Gros-texte..... | 16 | .. 14 |

This table, published by a type-founder³ at Brussels, for the purpose of illustrating his ability to furnish bodies of types made by both systems, will

¹ "Sous l'influence de la confusion déplorable qui, en permettant aux deux systèmes de s'introduire concurremment à l'insu des maîtres imprimeurs, a jeté une véritable perturbation dans le matériel de presque toutes les imprimeries, en sorte qu'il y est devenu à peu près impossible de rien établir de juste en calculant par points." Lechap, "L'Imprimerie," No. 44.

² The rival claims made for Fournier and Didot as inventors of the point system have been carefully examined by M. Cusset of Paris, and published by him in the "Procès-verbaux de la Société fraternelle des Protes des Imprimeries de Paris." Reprinted in "L'Imprimerie," No. 108, 1873.

³ "Specimen Book of M. T. Vanderborght," Brussels, 1861.

serve also to show the relations that the bodies of the two systems bear to each other.

It is a misfortune that these scientific systems should have been perfected before the introduction of the French metrical system. Fournier's is imperfect in its want of basis on an established measure. Didot's is imperfect in its selection of a disused measure for a basis. Neither of them has any direct relation to the metrical system. That of Didot is at complete variance with the metre in every part.¹ The accident that 100 points of Fournier accord with 35 millimetres has led to no practical result in France: a standard of 35 millimetres has not been used by the French founders as a scale or measure for subdivision.

Before Fournier and Didot had introduced their systems, cicéro (or pica) served for a unitary standard, as it continues to serve in England and America. Its dimensions were variable, yet it was a convenient unit for calculation. Leads, reglets, furniture, brass rules, cuts, large wood and metal types, were made on

The systems prematurely introduced

A defect in the Didot system

¹ This defect in the Didot system has been the occasion of many attempts to bring Didot's points in accord with the metrical system of France. One of these attempts was that of Charles Verneuil, who proposed that the unitary point should be made equal to two millimetres. This would make the point

much smaller than the one now in use — smaller even than that of Fournier or of the American system. This is a practical confession that the Didot point is too large, and that the distance between the bodies is too great. It is not probable that this new plan will be accepted. "L'Imprimerie," No. 161.

bodies that were the multiples or divisors of pica. By Fournier's method, pica or cicéro was made of twelve points, which was a divisible number. When Didot accommodated this pica to an even division of the royal foot, and put it on body 11 of his system of points, he made it virtually an indivisible unit. It is not practicable to make leads or brass to the fractions of eleven. Intelligent Parisian typographers admit that this is a real fault, and do not hesitate to avow their preference for the system of Fournier¹ as the more natural and more advantageous of the two, inasmuch as it graduates the bodies of type in infinitesimal proportions more available than those of Didot.

The first practical attempt in America at the establishment of correct proportions between the

¹ On the contrary, M. Laboulaye, in his "Dictionary of Arts and Manufactures," objects to any change in the Didot point. He makes these observations in the article on *Fonderie en Caractères*, § 8: "Attempts have been recently made to return to the Fournier point by making it in accord with the new measures. The base declared is that 100 points Fournier make exactly 35 millimetres, or that the point be equal to about 0^{mm} 35. Now would it be wise or advantageous, when the greater part of printing houses have been fully equipped, often at great cost, with types on the Didot point, to reduce the size of the

type bodies? What is the point Didot in millimetres? 'L'Annuaire' of the Bureau of Longitudes makes the line of the pied-du-roi 0^{mm} 2,256, of which one-sixth is 0^{mm} 376. Should this great revolution in sizes be made because the point should be 0^{mm} 35 instead of 0^{mm} 376? The first decimal division is not better than the second. An exact millimetric division should be established on another basis, on one which would not upset all the materials now in use, and do it for so little benefit." These observations are given at length to show that the point system of Didot is not, even in Paris, accepted as a perfect system.

proximate bodies of types was made by the late George Bruce of New York in 1822. It does not appear that he meant to establish a new series of sizes. His object was to make all types properly correlated with a little disturbance as possible to the bodies then in regular use.

The Bruce
system of
progression

As the most used bodies of brevier, long-primer, and pica were, in most foundries, very nearly correct in their relations to each other, these bodies were taken as the ones which should be least disturbed, and to which the others should be made to conform; but the intermediate and so-called irregular sizes were adjusted to the regular sizes without regard to old usage. Bruce began his change by determining the exact size of the six standard bodies from pica to minion. This done, the dimensions of larger or smaller bodies were determined by the multiplication or division of the six standard bodies. Conformity was obtained by making the bodies increase by the rule of geometrical progression. Small-pica was made as much larger than long-primer as bourgeois was made larger than brevier. Each body was made a certain percentage larger than its proximate smaller body. This percentage expressed in figures is the decimal .122462, which, when increased six times in a series of expanding bodies, doubles on the seventh progression the size of the body first selected. The Bruce system provides for uniformity of increase

148 *Bruce's System of Progression*

The Relation of Different Bodies of Type to each other and to standard linear measures by the Bruce System of Geometrical Progression.

| Bodies. | Size in decimals of a linear inch. | Body larger than that preceding it, in decimals of a linear inch. | Ems and decimals of an em in a linear foot. | Ems and decimals of an em in a square foot. |
|----------------------------|------------------------------------|---|---|---|
| Diamond | .0595+ | | 201.587+ | 40,637.46+ |
| Pearl | .0668+ | .0072+ | 179.593+ | 32,253.97+ |
| Agate | .075 | .0081+ | 160. | 25,600. |
| Nonpareil | .0841+ | .0091+ | 142.543+ | 20,318.73+ |
| Minion | .0994+ | .0103+ | 126.992+ | 16,126.98+ |
| Brevier | .1060+ | .0115+ | 113.137+ | 12,800. |
| Bourgeois | .1190+ | .0129+ | 100.793+ | 10,159.36+ |
| Long-primer | .1336+ | .0145+ | 89.796+ | 8,063.49+ |
| Small-pica | .15 | .0163+ | 80. | 6,400. |
| Pica | .1683+ | .0183+ | 71.271+ | 5,079.68+ |
| English | .1889+ | .0206+ | 63.496+ | 4,031.74+ |
| Columbian | .2121+ | .0231+ | 56.568+ | 3,200. |
| Great-primer | .2381+ | .0259+ | 50.396+ | 2,539.84+ |
| Paragon | .2672+ | .0291+ | 44.898+ | 2,015.87+ |
| Double sm.-pica | .3 | .0327+ | 40. | 1,600. |
| Double pica | .3367+ | .0367+ | 35.635+ | 1,269.92+ |
| Double english | .3779+ | .0412+ | 31.748+ | 1,007.93+ |
| Double columb. | .4242+ | .0462+ | 28.284+ | 800. |
| Doub. gt.-primer | .4762+ | .0519+ | 25.198+ | 634.96+ |
| Double paragon | .5345+ | .0583+ | 22.449+ | 503.96+ |
| Meridian | .6 | .0654+ | 20. | 400. |
| Canon | .6734+ | .0734+ | 17.817+ | 317.48+ |

From the Bruce Specimen Book of 1882.

of bodies; it brings under the rule of geometrical progression not only the bodies but the distances between the bodies. It is ingenious and scientific, but has not been adopted by any other American type-foundry. For sizes larger than canon it is not so well adapted. All American and English founders, as well as all the manufacturers of wood types, make their larger bodies multiples of pica. Printers prefer this system for large types, not for its superior facility of combination, but for its nicer division of sizes. For the smaller types the rule of geometrical progression brings bodies too near together.

After a fire, which destroyed their materials, Marder, Luse & Co., type-founders at Chicago, planned a system of bodies based on The American six picas to the American inch. point system Before they had made types by the new plan, they perceived that its adoption would compel the making not only of new bodies, but of new faces which would disagree with the types of all other foundries. Abandoning the system of six picas to the inch, they took for their standard the pica of the MacKellar, Smiths & Jordan Co. as the one which would be preferred by the greater number of printers and founders. Upon this basis they regraded all smaller and larger sizes after the methods of Fournier. In 1878 they put on sale types made by this system, which they called the American System of Interchangeable Type Bodies.

At a meeting of the United States Type Founders' Association, held at Niagara in 1886, a committee was appointed to examine into and to report upon the new system. Several founders objected to its basis upon a pica capriciously selected, and not a regular division of the foot or metre, but the result of the examination was the adoption of its leading features by a majority of founders. It was found that the pica which had been selected could be put in accord with the metric system, although in an irregular manner. Eighty-three picas were equal to thirty-five centimetres. By dividing the pica into twelve equal parts, and accepting one of these parts as the unit, a base was made for the determination of every body. This twelfth part of a pica was called a point. All bodies of types were placed on multiples of this point and called by numerical names: pica was 12-point; double-pica, 24-point; four-line pica, 48-point. The numerical names defined the bodies and the relation that each body had to the rest. This American system follows the methods of Fournier and Didot, differing from them only in its selection of another body of pica as its basis.

The following table gives the sizes, as near as they can be expressed in decimals of the American inch and the French metre, of the American point system of type-bodies, as they were adopted by the United States Type Founders' Association.

| Bodies. | Size in inches. | Size in centimetres. | No. of ems per foot. | No. of ems per metre. |
|---------------|-----------------|----------------------|----------------------|-----------------------|
| 1-point..... | 0.0138 | 0.0351 | 867.4699 | 2845.7143 |
| 1½-point..... | .0207 | .0527 | 578.3132 | 1897.1428 |
| 2-point..... | .0277 | .0703 | 433.7349 | 1422.8572 |
| 2½-point..... | .0346 | .0878 | 346.9880 | 1138.2856 |
| 3-point..... | .0415 | .1054 | 289.1566 | 948.5714 |
| 3½-point..... | .0484 | .1230 | 247.8486 | 813.0612 |
| 4-point..... | .0553 | .1406 | 216.8675 | 711.4286 |
| 4½-point..... | .0622 | .1581 | 192.7711 | 632.3810 |
| 5-point..... | .0692 | .1757 | 173.4940 | 569.1428 |
| 5½-point..... | .0761 | .1933 | 157.7218 | 517.4026 |
| 6-point..... | .083 | .2108 | 144.5783 | 474.2857 |
| 7-point..... | .0968 | .2460 | 123.9243 | 406.5306 |
| 8-point..... | .1107 | .2811 | 108.4337 | 355.7142 |
| 9-point..... | .1245 | .3163 | 96.3855 | 316.1905 |
| 10-point..... | .1383 | .3514 | 86.7470 | 284.5714 |
| 11-point..... | .1522 | .3865 | 78.8609 | 258.7013 |
| 12-point..... | .166 | .4217 | 72.2892 | 237.1429 |
| 14-point..... | .1937 | .4920 | 61.9621 | 203.2653 |
| 15-point..... | .2075 | .5271 | 57.8313 | 189.7143 |
| 16-point..... | .2213 | .5622 | 54.2170 | 177.8571 |
| 18-point..... | .249 | .6325 | 48.1928 | 158.0952 |
| 20-point..... | .2767 | .7028 | 43.3735 | 142.2857 |
| 22-point..... | .3044 | .7730 | 39.4304 | 129.3506 |
| 24-point..... | .332 | .8434 | 36.1446 | 118.5714 |
| 28-point..... | .3874 | .9840 | 30.9810 | 101.6326 |
| 30-point..... | .415 | 1.0542 | 28.9157 | 94.8571 |
| 32-point..... | .4426 | 1.1244 | 27.1085 | 88.9280 |
| 36-point..... | .498 | 1.2651 | 24.0964 | 79.0476 |
| 40-point..... | .5534 | 1.4056 | 21.6867 | 71.1428 |
| 42-point..... | .581 | 1.4759 | 20.6540 | 67.7551 |
| 44-point..... | .6088 | 1.5460 | 19.7152 | 64.6753 |
| 48-point..... | .664 | 1.6867 | 18.0723 | 59.2857 |
| 54-point..... | .747 | 1.8975 | 16.0642 | 52.6984 |
| 60-point..... | .83 | 2.1084 | 14.4578 | 47.4285 |
| 72-point..... | .996 | 2.5301 | 12.0482 | 39.5238 |

The methods agreed upon by the United States Type Founders' Association for the purpose of securing uniformity under the new system seem to be practically satisfactory. A graduated measuring rod of steel, 35 centimetres or 83 picas in length, is made a common measure for all bodies of type. It does not appear, however, that every type-founder who has adopted this system has ready access to an official metre, on which the measure of 35 centimetres depends. Some of them seem to trust the testing of their types to the

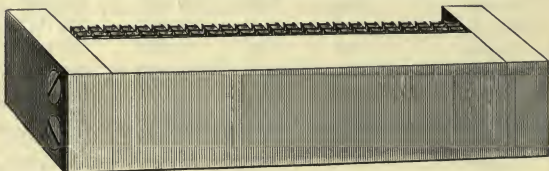

A gauge for type-bodies.

This gauge or smaller measure consists of three bars of steel accurately fitted and firmly connected as is shown in the illustration. The space between the short side bars is exactly 288 points, which admits 24 bodies of pica, 36 bodies of brevier, and 48 bodies of nonpareil. Of the intermediate sizes, it takes 26 bodies and 2 points of small-pica; 28 bodies, 8 points of long-primer; 32 bodies, 8 points of bourgeois; 42 bodies, 1 point of minion.

smaller measure. It has been claimed that there is no reason why an official metre should be used, as the fixed and unalterable length of the metre can be determined by mathematical calculation.¹

¹The metre is the ten-millionth part of the arc of a meridian between the pole and the equator, or 3.2808992 feet.

The measuring rod of 35 centimetres was also suggested as a good standard for determining the height-to-paper of type. By this plan fifteen type-heights were made equal to 35 centimetres. This is a serious deviation from the old standard of eleven-twelfths, or .9166 of an inch. One-fifteenth of 35 centimetres is .9186 of an inch. The difference of $\frac{20}{100000}$ or $\frac{1}{5000}$ part of an inch may seem very trivial, but it is enough to prevent the use of the different heights in the same line.

Some founders claim to have adhered to the old standard of height; others have adopted the new. Those who have adopted the new bodies without a special refitting of all their old matrices are giving to printers a greater annoyance than was

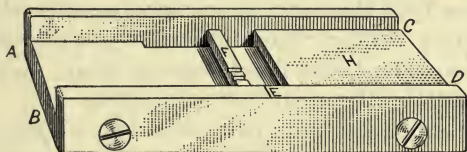

A gauge for height-to-paper.

Types can be tested by printers for height-to-paper by this simple instrument of steel, recently invented by Henry Barth, of the Cincinnati Type Foundry. The line A C is very slightly out of parallel with the line B D. A type of proper height will pass freely in the channel toward the mark E, in which channel it is

held straight and square by the movable brass H that slides in a slot. The type that stops in the channel before it reaches the slot is too high; the type that passes the slot or the mark E is too low. Type-founders make use of a more complicated instrument which will show a deviation of less than $\frac{1}{3000}$ inch.

ever received from irregular bodies. Soon after the new point system was adopted, complaints were heard from press-rooms that some types were high-to-paper. The fault was noticeable in lines in which were sorts of newly cast types. Compositors were blamed for a bad planing-down of forms, and electrotypers for their bad moulding, and the office for permitting a mixture of old type with new sorts; but a testing of the unworn type of the first casting with those that were newly cast plainly showed that the real fault was in the altered standard of height.

It would be a great benefit if the types of France, Germany, and America were uniform as to body, so that types bought in one country could be used in another. The United States Type Founders' Association considered this question, but they were obliged to reject the French system: the Didot point was too large; it made the distance between bodies too great.

To adopt the Didot point would have compelled the retirement not only of the greater part of the moulds and matrices now in use, but also the re-cutting of new punches for many sizes. It would have been a forsaking of the better for the worse; a rejection of a system of convenient divisions for one of larger divisions that were not as convenient. The point adopted by the United States Type Founders' Association is .0351 + centimetre. This deviates but little from the point devised in

1737 by Fournier, the true inventor of the point system. The point substituted by Ambroise Firmin-Didot is .0376+ centimetre, eleven points of which are almost as large as twelve American points.¹

The explanatory diagram which follows this page is from the foundry of the MacKellar, Smiths & Jordan Co. It may be accepted as an official representation of the bodies of the American system.

¹ In the Fournier system 1000 points make 35 centimetres; in the American system 996 points make 35 centimetres. It is probable that the American system, based on the pica of the MacKellar, Smiths & Jordan Co., was unwittingly derived from Fournier. Thomas says, in his "History of Printing in America" (vol. i, p. 29, second edition), that Benjamin Franklin purchased of P. S. Fournier "the materials of an old foundry," and had his grandson, B. F. Bache, instructed in the art by Fournier, with intent to establish an extensive foundry in Philadelphia. The foundry so established did not thrive; it was neglected and abandoned by Bache, but after Franklin's death the type-founding tools became the property of his relative Duane, who kindly offered to lend them all to Binny & Ronaldson, then the only founders of importance in that city. Ronaldson was struck with their superiority, and fearing that Duane might change his mind,

at once got a wheelbarrow and trundled them to his own foundry. Binny acknowledged that he received many valuable suggestions from these tools. With this testimony as to the value of the tools, added to our knowledge of Franklin's interest in scientific instruments of every kind, it may be assumed that Fournier sold not old but new tools, and that he had provided everything needed to establish his point system in America, in the equipment which he furnished to Bache. There can be no doubt that Binny & Ronaldson had, and made use of, the Fournier mould for pica, and that the standard they fixed for this body was accepted by their successors, L. Johnson & Co. and the MacKellar, Smiths & Jordan Co. The slight deviation from the Fournier standard of four points in one thousand may be accepted as the consequence of unintended and gradually imperceptible changes which would occur after a long use of moulds in early days.

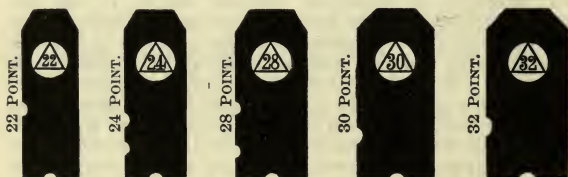

Three Scientific Systems Contrasted 157

Number of Ems to Linear Foot.

| American system. | Bruce system. | Didot system. |
|-------------------|----------------------|-------------------|
| 3-point... 289.15 | | Body 3... 270.23 |
| 3½-point 247.84 | | Body 3½... 231.62 |
| 4-point... 216.86 | Diamond... 201.58 | Body 4... 202.67 |
| 4½-point. 192.77 | Pearl 179.59 | Body 4½... 180.14 |
| 5-point... 173.49 | Agate 160. | Body 5... 162.13 |
| 5½-point. 157.72 | Nonpareil... 142.54 | Body 5½... 147.38 |
| 6-point... 144.57 | Minion 126.99 | Body 6... 135.11 |
| 7-point... 123.92 | Brevier 113.13 | Body 6½... 124.72 |
| 8-point... 108.43 | Bourgeois... 100.79 | Body 7... 115.81 |
| 9-point... 96.38 | Long-primer 89.79 | Body 7½... 108.09 |
| 10-point... 86.74 | Small-pica .. 80. | Body 8... 101.33 |
| 11-point... 78.86 | Pica 71.27 | Body 9... 90.07 |
| 12-point... 72.28 | English 63.49 | Body 10... 81.06 |
| 14-point... 61.96 | Columbian .. 56.56 | Body 11... 73.69 |
| 15-point... 57.83 | Great-primer 50.39 | Body 12... 67.55 |
| 16-point... 54.21 | Paragon 44.89 | Body 13... 62.36 |
| 18-point... 48.19 | Dbl. sm.-pica 40. | Body 14... 57.90 |
| 20-point... 43.37 | Double pica . 35.63 | Body 16... 50.66 |
| 22-point... 39.43 | Dbl. english. 31.74 | Body 18... 45.03 |
| 24-point... 36.14 | Dbl. columb. 28.28 | Body 20... 40.53 |
| 28-point... 30.98 | Dbl. gt.-prim. 25.19 | Body 22... 36.84 |
| 30-point... 28.91 | Dbl. paragon 22.44 | Body 24... 33.77 |
| 32-point... 27.10 | Meridian 20. | Body 26... 31.18 |
| 36-point... 24.09 | Canon 17.81 | Body 32... 25.33 |
| 40-point... 21.68 | | Body 40... 20.26 |
| 42-point... 20.65 | | Body 48... 16.89 |
| 44-point... 19.71 | | |
| 48-point... 18.07 | | |

The bodies of English types have been changed since they were reported in Savage's Dictionary.¹

*English Sizes : Ems to the linear foot.*²

| Sizes. | Miller and Richard. | Stephen-son and Blake. | Figgins. | Caslon. | Sir Charles Reed's Sons. |
|-------------------|---------------------|------------------------|----------|---------|--------------------------|
| Pica | 71½ | 72 | 72 | 72 | 72 |
| Small-pica | 83 | 83 | 83 | 83.2 | 83 |
| Long-primer | 89 | 89 | 90 | 89.5 | 91 |
| Bourgeois | 102½ | 102½ | 102 | 102 | 102 |
| Brevier | 111 | 111 | 108½ | 111.3 | 111 |
| Minion | 122 | 123 | 122 | 122.4 | 122 |
| Emerald | 138 | 129 | 128 | 128.5 | 128 |
| Nonpareil | 143 | 144 | 144 | 144 | 144 |
| Ruby-nonpareil .. | 160 | 161 | 160 | ... | 160 |
| Ruby | 166 | 166 | 166 | ... | 166 |
| Pearl | 178 | 179 | 183 | 178.6 | 181 |
| Diamond | 207 | | 204 | 203 | 204 |
| Gem | 222 | | ... | | |
| Brilliant | 237 | | ... | | |
| Semi-nonpareil .. | 286 | | 288 | | |

If the point of the American system had been based on the plan of six picas to the inch, it is possible that English and American bodies could have been brought to agreement, and that a system of points on this basis would not have met with any determined opposition in England.

¹ See p. 128 of this work.

² Oldfield, "Manual of Typography," p. 98. He says that the

figures given in this table were verified for its own type by each foundry named therein.

This American point system has been adopted by many founders, and in time will probably supplant all other systems in America. Although it is of great advantage to the printing trade to get more uniformity, too much has been expected from this point system. It reduces but does not entirely prevent irregularities. That it will ever be so perfect that types of the same body from different founders can unhesitatingly be mixed and used together is not probable. System alone is not enough. Perfection in theory will not make skill in manufacture a matter of secondary importance. Under the new system good type-founding will exact as much watchfulness as ever. The irregularities that are caused by overheated metal, sprung or untested moulds, or careless rubbing, are as possible now as they ever were. The founder who has been careless under the old system will probably be equally careless under the new.

An improved
system does
not insure
perfect type

The advantages that may accrue from uniform bodies will be more than nullified if general uniformity in height is not secured. If some type-founders continue to adhere to the old standard of height, while others attempt to introduce the new, without a careful refitting of special matrices to the new moulds, the printing trade will be more damaged than benefited by the change.

Printers can test their types, chiefly as to body, but also as to height-to-paper, by means of the

type-gauge, of which an illustration is here given. The two jaws or graduated faces are very slightly out of parallel, at an angle so slender as to be unperceived until they are held against the light. The thumb-piece allows the under jaw to be adjusted on the slide to fit any body. When

set to the proper gauge, a type too small will pass in it beyond the gauge line; a type too large will not reach to the gauge line. Type-founders usually test the distrusted bodies by putting four of the type-bodies between the jaws, first at the shoulder and then at the foot of the types. An exceedingly slight inaccuracy that may escape notice on one body will be detected when four bodies are together.

One of the advantages claimed for all systems of typographic points is their helpfulness in justifying. But this advantage is much overrated. Quite as much special justification seems to be done in French as in American offices. Unless the leads, brass rules, and other material of composition are true frac-

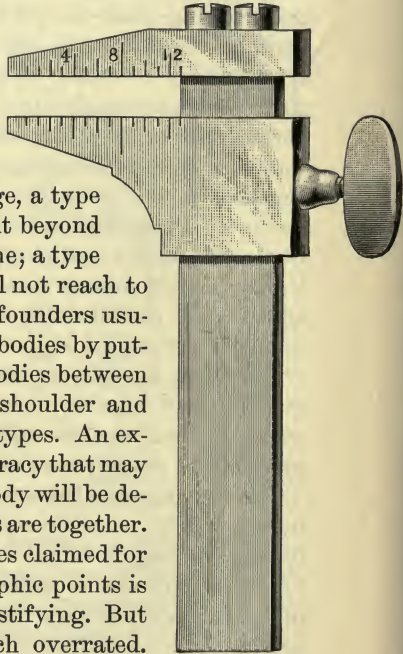

Type-gauge.

tions of the point, this facility in justification is defeated.¹ Those who have experience in composition, and who know how the bodies of types, leads, and rules are bent and thickened by usage, by dust, rust, and imperfect cleaning, and how much allowance must be made, both in the width and length of a column or page, for the "spring" of types or their contraction in the process of locking-up, will acknowledge that types do not combine in practice as easily as in theory.

Old types
difficult
to justify

In the composition of algebraic work, the point system is helpful. A twelve-to-pica lead will make justification between proximate bodies of ordinary size. It is not enough to secure exact justification in the composition of good book and job work; where two sizes have to be used together exact lining is required, but this is rarely accomplished by the use of the twelve-to-pica lead. For the justification of the proximate sizes smaller than nonpareil, a twenty-four-to-pica is required, for which thickness there are no leads. The compositor will have to justify these bodies, as he did before, with strips of paper and cardboard.

New system
is helpful
in algebra

The point system, or a modification of it, has been applied to the set or width of types. The inventors of various forms of type-writing ma-

¹The "Scale of Prices" of the Parisian compositors for 1868 and 1878 contains many articles that price special justification.

chines had previously discovered the importance of types that were of one width. The first practical attempt at systematic uniformity in the set of printing types was made in 1883, by Benton, Waldo & Co., type-founders at Milwaukee, who introduced the system as that of "self-spacing" types. Their plan was to put every type, on all the bodies from agate to pica inclusive, on some set which was an even division of the standard pica em. These divisions varied according to size of body, from an eighth to a thirteenth of the pica em. The object sought was the quickening of composition by providing better facilities for spacing. As a composed line of types and spaces made on this system is but a combination of the regular divisions of pica, it was claimed that the types so composed must end evenly on every line, and thereby prevent much of the trouble of spacing.

In placing the characters of the font on even divisions of the pica, many difficulties were met. The form of one character might be too narrow for one set but the next might be too wide. The alternatives were to give this character a too broad or a too narrow set, or to recut the punch so as to keep the character on the prescribed set. The result of the earlier experiments was not satisfactory: the general effect of the composed types was that of neglected fitting. Later efforts at improvement have removed many

Points applied to the set of type

Defects of the system

of the earlier infelicities, but the publishers and printers who are critical do not accept the "self-spacing" types as proper models of form. More improvement is needed, but there is every reason to believe that this improvement can be made.

The advantages of "self-spacing" types to compositors are beyond question; the new method largely reduces the labor of spacing.

The Point System applied to Spaces.¹

| Bodies. | Six-to-em space. | Five-to-em space. | Four-to-em space. | Three-to-em space. | Patent space. $\frac{5}{12}$ of em. | En quad-rats. | Em quad-rats. |
|------------------------|------------------|-------------------|-------------------|--------------------|-------------------------------------|-----------------|-----------------|
| 5-point.. | | 1 | *1 $\frac{1}{2}$ | *2 | | 2 $\frac{1}{2}$ | 5 |
| 5 $\frac{1}{2}$ -point | | *1 | *1 $\frac{1}{2}$ | *2 | *2 $\frac{1}{2}$ | *3 | 5 $\frac{1}{2}$ |
| 6-point.. | 1 | | 1 $\frac{1}{2}$ | 2 | *2 $\frac{1}{2}$ | 3 | 6 |
| 7-point.. | *1 | *1 $\frac{1}{2}$ | *2 | *2 $\frac{1}{2}$ | *3 | 3 $\frac{1}{2}$ | 7 |
| 8-point.. | *1 | *1 $\frac{1}{2}$ | 2 | *2 $\frac{1}{2}$ | *3 | 4 | 8 |
| 9-point.. | 1 $\frac{1}{2}$ | *2 | *2 $\frac{1}{2}$ | 3 | *3 $\frac{1}{2}$ | 4 $\frac{1}{2}$ | 9 |
| 10-point.. | *1 $\frac{1}{2}$ | 2 | 2 $\frac{1}{2}$ | *3 | *4 | 5 | 10 |
| 11-point | *2 | *2 $\frac{1}{2}$ | *3 | *3 $\frac{1}{2}$ | *4 $\frac{1}{2}$ | 5 $\frac{1}{2}$ | 11 |
| 12-point.. | 2 | *2 $\frac{1}{2}$ | 3 | 4 | *5 | 6 | 12 |
| 14-point.. | *2 | *3 | *4 | *5 | *6 | 7 | 14 |
| 18-point . | *2 | *3 | *4 | 6 | | 9 | 18 |

The Central Type Foundry of St. Louis have proposed to apply the point system to spaces only, by putting every space of every body on the set of one point or on the multiples of the point. As the point is but about $\frac{1}{7\frac{1}{2}}$ and the

¹ "Price-list of Central Type Foundry," p. 5.

half point about $\frac{1}{144}$ of an inch, the divisions are sufficiently minute. Rigid adherence to this system will compel the making of some new widths of spaces, and possibly in some fonts the making of figures on new sets, but spaces on point sets will be a valuable aid to justification, especially in the narrow columns of table-work.

The changes from the old sets now in use are marked in the table with a *.

The patent space is intended to be the intermediate between a three-to-em space and an en quadrat—or about five-twelfths of the em body. It has been in use for years in some large book offices.

The only en quadrat changed is that of the $5\frac{1}{2}$ -point, which is made a trifle thicker. This should compel the putting of figures on a set of the same thickness or the retention of the en quadrat of the old form.





IV

A Font of Type



FONT of type is a complete collection, with a proper apportionment to each character, of the mated types required for an ordinary text. The letters are in unequal request : a and e appear repeatedly in long sentences ; z and q may not be found in a page. The type-founder tries to supply each character in proportion to its frequency of use, so that the printer shall have enough of every and not too much of any character.

The written or printed summary of the proper quantity of types for each character is known in the United States as a scheme, and in A scheme Great Britain as a bill, of type. For large of type metal types, or for wood types that are used only for single lines of display, the scheme is made by a count of the characters, as may be seen in the

| 122 Letters. 5-A Capitals. | | 104 Letters. 5-a Lower-case. | |
|-------------------------------------|---|---------------------------------------|---|
| A | 5 | a | 5 |
| B | 3 | b | 3 |
| C | 4 | c | 4 |
| D | 4 | d | 4 |
| E | 6 | e | 6 |
| F | 3 | f | 3 |
| G | 3 | g | 3 |
| H | 4 | h | 4 |
| I | 5 | i | 5 |
| J | 3 | j | 2 |
| K | 2 | k | 2 |
| L | 6 | l | 5 |
| M | 4 | m | 4 |
| N | 5 | n | 5 |
| O | 5 | o | 5 |
| P | 3 | p | 3 |
| Q | 2 | q | 2 |
| R | 5 | r | 5 |
| S | 6 | s | 5 |
| T | 5 | t | 5 |
| U | 4 | u | 4 |
| V | 3 | v | 3 |
| W | 3 | w | 3 |
| X | 2 | x | 2 |
| Y | 3 | y | 3 |
| Z | 2 | z | 2 |
| & | 2 | æ | 1 |
| . | 4 | œ | 1 |
| , | 4 | fi | 1 |
| ; | 2 | fl | 1 |
| : | 2 | ff | 1 |
| - | 1 | ffi | 1 |
| ' | 2 | ffl | 1 |
| ! | 3 | | |

Æ and Œ are seldom provided.

annexed scheme for a 5-A and 5-a font of wood type:

Figures are not provided for all fonts of large type. When provided, they are furnished for a 5-a font in the proportion of two types each of characters 2, 3, 4, 5, 6, 7, 8, 9, \$; three types for figure 1; five types for figure 0. Fonts of 3-A are sometimes made for very large types, but for ordinary types the 5-A font is the smallest.

The font of 5-A, with figures, has two hundred and fifty characters, but it seldom happens that more than fifty of them can be used at one time. If these fifty letters contain six of E and five of A, no more lines can be set that call for A or E. But the provision in the scheme for two hundred other characters is necessary; some of them or all of them will be needed on other work or at another time. In fonts of metal type of large sizes, and in all fonts of display letter, the schemes do not include spaces or quadrats.

Wood types are sold at a fixed price for every letter ; metal types at a fixed price by the pound.

For larger fonts of wood type or jobbing letter, different apportionments are made, as is shown in the annexed scheme for a 36-A and 70-a font.

In the United States the apportionment of each character in fonts intended for book or newspaper work is made by weight. In Great Britain the apportionment is made, nominally at least, by a count of characters.

The apportionment of characters is necessarily varied for different languages. The English printer who buys a French font of type soon discovers its deficiency of k and w, and its excess of q and '. The French printer who bought an English font would object to the excess of the k and w, and the deficiency of the q and '. Italian calls for a larger supply of

| | 70-a. | 36-A. |
|-----|-------|-------|
| a | 70 | A 36 |
| b | 28 | B 15 |
| c | 37 | C 24 |
| d | 42 | D 19 |
| e | 92 | E 43 |
| f | 28 | F 17 |
| g | 24 | G 17 |
| h | 47 | H 19 |
| i | 70 | I 36 |
| j | 14 | J 9 |
| k | 14 | K 9 |
| l | 47 | L 24 |
| m | 37 | M 19 |
| n | 70 | N 36 |
| o | 70 | O 36 |
| p | 28 | P 19 |
| q | 10 | Q 6 |
| r | 70 | R 36 |
| s | 70 | S 36 |
| t | 70 | T 36 |
| u | 37 | U 19 |
| v | 14 | V 9 |
| w | 28 | W 15 |
| x | 10 | X 6 |
| y | 28 | Y 15 |
| z | 10 | Z 6 |
| æ | 5 | & 6 |
| œ | 5 | Æ 3 |
| fi | 8 | Œ 3 |
| ff | 8 | 1 16 |
| fl | 5 | 2 12 |
| ffl | 5 | 3 12 |
| ffh | 5 | 4 12 |
| , | 37 | 5 12 |
| ; | 5 | 6 12 |
| : | 5 | 7 12 |
| . | 37 | 8 12 |
| - | 8 | 9 12 |
| ' | 10 | 0 16 |
| ! | 5 | |
| ? | 8 | |
| \$ | 10 | |
| £ | 3 | |

c and z; Spanish, for more of d, t, and all the vowels; Latin, for more of c, m, n, u, and q. For any language but English the scheme of the American or English type-founder is unsuitable.

The scheme is not, and cannot be, nicely adapted to every kind of literary composition in English. For poetry there must be a large excess of quadrats; for the personal narrative, an excess of I; for tables or statistics, an excess of figures; for dictionaries and catalogues, an excess of capitals, signs, and points. Even in plain descriptive matter, apparently free from any peculiarity, the compositor will note that a latinized style will use an excess of one kind of sorts, and a colloquial style an excess of other sorts. For peculiar work the printer must select and order an excess of the characters that are most needed.

The object of the scheme is so to apportion each character that all the types in the font may be set out of case, leaving no surplus. This object of a scheme is never attained. When a compositor reports that a new font of text-type has been set out, as a rule about one-third of the weight of the font remains unused in case. The purchase and use of more of the deficient characters may reduce the surplus to one-fourth — perhaps one-fifth — but it is not probable that it can ever be made any less. There will always be a large surplus. It follows that the printer must provide from one-fourth to one-half more type than he can put to use at one time.

Scheme for one thousand pounds of roman and italic as made by George Bruce's Son & Co.

| Roman lower-case. | Roman capitals. | Points. | Italic lower-case. |
|-------------------|-----------------|------------|--------------------|
| lbs. oz. | lbs. oz. | lbs. oz. | lbs. oz. |
| a .. 37 | A .. 5 | , .. 10 | a .. 5 |
| b .. 10 | B .. 3 12 | ; .. 2 8 | b .. 1 4 |
| c .. 17 | C .. 3 12 | : .. 1 14 | c .. 2 6 |
| d .. 25 | D .. 3 12 | . .. 5 | d .. 3 2 |
| e .. 57 | E .. 5 | - .. 5 | e .. 6 4 |
| f .. 11 4 | F .. 3 12 | ' .. 1 14 | f .. 1 14 |
| g .. 11 4 | G .. 3 12 | ! .. 10 | g .. 1 14 |
| h .. 32 8 | H .. 3 12 | ? .. 10 | h .. 4 6 |
| i .. 25 | I .. 2 8 | (.. 10 | i .. 3 2 |
| j .. 1 14 | J .. 1 14 | [.. 10 | j .. 7 |
| k .. 3 12 | K .. 1 14 | | k .. 10 |
| l .. 12 8 | L .. 3 12 | | l .. 1 14 |
| m .. 25 | M .. 3 12 | | m .. 3 2 |
| n .. 37 | N .. 3 12 | | n .. 5 |
| o .. 37 | O .. 3 12 | Figures. | o .. 4 6 |
| p .. 11 4 | P .. 3 12 | 1 .. 5 | p .. 1 14 |
| q .. 4 | Q .. 1 14 | 2 .. 4 6 | q .. 10 |
| r .. 25 | R .. 3 12 | 3 .. 3 12 | r .. 3 12 |
| s .. 30 | S .. 3 12 | 4 .. 3 12 | s .. 4 4 |
| t .. 31 | T .. 5 | 5 .. 3 12 | t .. 4 4 |
| u .. 18 4 | U .. 2 8 | 6 .. 3 2 | u .. 2 10 |
| v .. 7 8 | V .. 1 14 | 7 .. 3 2 | v .. 1 4 |
| w .. 15 8 | W .. 3 12 | 8 .. 3 2 | w .. 2 8 |
| x .. 1 14 | X .. 10 | 9 .. 3 2 | x .. 7 |
| y .. 11 4 | Y .. 2 8 | 0 .. 5 | y .. 1 14 |
| z .. 1 14 | Z .. 10 | \$.. 1 4 | z .. 7 |
| æ .. 10 | Æ .. 6 | £ .. 10 | æ .. 4 |
| œ .. 10 | Œ .. 6 | | œ .. 4 |
| fi .. 3 12 | & .. 1 14 | | fi .. 14 |
| ff .. 2 8 | | | ffi .. 14 |
| ffi .. 2 8 | | | ffl .. 14 |
| fl .. 1 14 | Quadrats. | Spaces. | fl .. 10 |
| ffl .. 1 14 | n .. 20 | 3m .. 60 | ffl .. 10 |
| | m .. 13 | 4m .. 15 | |
| | 2m .. 44 8 | 5m .. 8 4 | |
| | 3m .. 44 8 | hair. 1 14 | |

Scheme for one thousand pounds of roman and italic as made by George Bruce's Son & Co.

| Italic capitals. | References. | Small capitals. | Roman accents. | Italic accents. |
|------------------|-------------|-----------------|------------------------|-------------------|
| oz. | lbs. oz. | oz. | oz. | oz. |
| A .. 18 | * .. 7 | A .. 18 | á .. 10 | á .. 4 |
| B .. 14 | † .. 7 | B .. 14 | â .. 14 | â .. 4 |
| C .. 14 | ‡ .. 7 | C .. 14 | ã .. 14 | ã .. 4 |
| D .. 14 | § .. 7 | D .. 14 | ä .. 4 | ä .. 4 |
| E .. 18 | ¶ .. 7 | E .. 18 | é .. 14 | é .. 4 |
| F .. 14 | ¶ .. 7 | F .. 14 | è .. 12 | è .. 4 |
| G .. 14 | ☞ 14 | G .. 14 | ê .. 10 | ê .. 4 |
| H .. 14 | | H .. 14 | ë .. 4 | ë .. 4 |
| I .. 10 | Braces. | I .. 10 | í .. 7 | í .. 4 |
| J .. 7 | ⌒ .. 4 | J .. 7 | ì .. 4 | ì .. 4 |
| K .. 7 | ⌒ .. 4 | K .. 7 | î .. 4 | î .. 4 |
| L .. 14 | ⌒ .. 4 | L .. 14 | ï .. 4 | ï .. 4 |
| M .. 14 | 2m .. 1 4 | M .. 14 | ó .. 10 | ó .. 4 |
| N .. 14 | 3m .. 1 4 | N .. 14 | ò .. 4 | ò .. 4 |
| O .. 14 | | O .. 14 | ô .. 4 | ô .. 4 |
| P .. 14 | Dashes. | P .. 14 | ö .. 4 | ö .. 4 |
| Q .. 7 | n .. 6 | Q .. 7 | ú .. 10 | ú .. 4 |
| R .. 14 | m .. 2 8 | R .. 14 | ù .. 4 | ù .. 4 |
| S .. 14 | 2m .. 2 8 | S .. 14 | û .. 10 | û .. 4 |
| T .. 18 | 3m .. 2 8 | T .. 18 | ü .. 4 | ü .. 4 |
| U .. 10 | | U .. 10 | ç .. 4 | ç .. 4 |
| V .. 7 | Leaders. | V .. 7 | ñ .. 6 | ñ .. 4 |
| W .. 14 | n .. 1 4 | W .. 14 | Ñ .. 4 | Ñ .. 4 |
| X .. 4 | m .. 2 8 | X .. 4 | Ñ .. 4 | ã .. 4 |
| Y .. 10 | 2m .. 5 | Y .. 10 | ã .. 10 | õ .. 4 |
| Z .. 4 | 3m .. 7 8 | Z .. 4 | õ .. 10 | ð .. 4 |
| Æ .. 4 | | Æ .. 4 | â .. 4 | |
| Œ .. 4 | Fractions. | Œ .. 4 | | |
| Œ .. 4 | ¼ .. 14 | & .. 6 | | |
| Œ .. 6 | ½ .. 14 | | | |
| | ¾ .. 14 | | | |
| | ⅞ .. 7 | | | |
| | ⅝ .. 7 | | | |
| | ⅜ .. 7 | | | |
| | ⅓ .. 7 | | | |
| | ⅔ .. 7 | | | |
| | ⅕ .. 7 | | | |
| | ⅖ .. 7 | | | |
| | ⅗ .. 7 | | | |
| | ⅘ .. 7 | | | |
| | ⅙ .. 7 | | | |
| | ⅚ .. 7 | | | |
| | ⅛ .. 7 | | | |
| | ⅜ .. 7 | | | |
| | ⅝ .. 7 | | | |
| | ⅞ .. 7 | | | |
| | 1 .. 7 | | | |
| Italic points. | | | Commer- cial marks. | Spanish marks. |
| ; .. 8 | | | @ .. 20 | à .. 10 |
| : .. 8 | | | Ⓔ .. 20 | ó .. 10 |
| ! .. 4 | | | Ⓕ .. 20 | Ⓔ .. 20 |
| ? .. 4 | | | Ⓖ .. 20 | Ⓔ .. 20 |
| (.. 4 | | | ° .. 10 | Ⓔ .. 20 |
| | | | ' .. 10 | Ⓔ .. 20 |

The full font of roman text-type as provided by the founder is always accompanied with italic, which should be of the same face or style as the roman. The apportionment for italic does not give as many characters as for the roman. Small capitals for italic are made only to order. Figures, fractions, references, and some of the points of the roman serve for the italic. Italic figures are furnished to some fonts by some foundries, but only on special order.

All the characters specified are furnished by the larger foundries with every entire font of roman from agate to pica. In english and sizes above, many of the minor sorts and all the accents are omitted. For sizes above great-primer, small capitals are not provided. Brilliant has no small capitals, or fractions, or accents, and few of the minor sorts. Although rated as complete, the regular font of roman has no accents for roman capitals or small capitals, and none for italic capitals, which are furnished only to order, in small quantities of one or two ounces to each character.

The list includes all the characters needed for ordinary work, but for foreign languages, or for scientific books, other characters must be used. All educational works require a large list of long and short vowels; dictionaries, a large number of diacritical marks, most of which have to be designed and cut to

Characters
deficient
in italic

Characters
deficient
in roman

Accents are
not always
provided

order; Portuguese, Danish and other languages have peculiar marks which must also be made to order. As a rule, even the ordinary accents are to be had only in the larger foundries.

The number of characters in this scheme is 253, but if characters were furnished for all the accents of foreign languages, for the signs and marks used in dictionaries, and books about mathematics, chemistry, bibliography, astronomy, etc., the number might exceed five hundred. No type-founder pretends to keep these peculiar characters for every font; probably no printer has a complete assortment of all of them for any one font.

Accents and signs of but limited use

For the sizes between and including pica and nonpareil small separate fonts of accents, for the French and Spanish languages only, are kept in stock by the leading type-foundries. It should be noted that these fonts are for lower-case only, and do not include the long and short vowel accents. Few foundries have accents for agate or smaller bodies or for english and larger bodies.

Fractions on the en-body are usually furnished with roman fonts from pearl to pica, inclusive. They are rarely provided for larger and smaller bodies of type. Fractions on the em body, mostly used in newspapers, are usually made of the smaller sizes only, by this scheme:

Scheme of fractions

| | | | | | | | | |
|---------------|---------------|---------------|---------------|---------------|---------------|---------------|---------------|---------------|
| $\frac{1}{2}$ | $\frac{1}{4}$ | $\frac{3}{4}$ | $\frac{1}{3}$ | $\frac{2}{3}$ | $\frac{1}{8}$ | $\frac{3}{8}$ | $\frac{5}{8}$ | $\frac{7}{8}$ |
| 50 | 50 | 40 | 25 | 25 | 25 | 20 | 20 | 20 |

Piece fractions, or split fractions in two pieces, or on two bodies, are not proper parts of the font, and are sold in separate fonts at higher rates.

Superiors of figures or of letters, like ¹ or ^a, are furnished only to order. These also are not considered as proper parts of the font. The superior characters first figures or letters of these superiors are furnished in great excess because they are most used. Superiors and piece fractions are made only for the larger sizes.

When a font of new type has been put in case, it should be set up until one sort is exhausted. If after composition there be left in case a large surplus, a list of the characters most needed should be ordered from the founder to make the assortment even. But after a repeated re-sorting of the cases it will always be found that a large surplus is unavoidably left.

One pound of metal type, as packed and sold by type-founders, covers a space of about three and six-tenths square inches. To find the space occupied by type weight of one page of type¹ composed in high spaces, divide its number of square inches by the figures 3.6. To find the weight of a font required to compose a given number of pages, provision must be made for a large surplusage of

¹ Example. This page is set up with high spaces and leads: it contains 15 square inches, which divided by 3.6 shows a weight of 4.27 pounds. If it were composed with low spaces and leads, the weight would be a trifle less. Changes in sizes of type make but little difference in the weight per square inch.

types. The proportion of this surplus is variable. For a small font, the type-founder's rule is to add one-half to the computed weight of the composed types. For a font of two thousand pounds or more, this surplus need not be relatively as great; an addition of one-fourth to the weight of the composed matter may be enough. All calculations of this kind are but guesses. No printer or type-founder can exactly foresee how unequally copy yet to be written will exhaust sorts.

For all work that has to be done in haste, for newspapers and magazines that have to keep in type postponed articles or alternated advertisements, a font of twice the weight of the composed matter will not be enough. Morning newspapers that frequently issue supplements of four or more pages, and that keep in type large quantities of matter, determine the size of the fonts by the number of their compositors, allowing three, six, and sometimes ten days' supply of type to each compositor. Quadrats are the sorts most frequently deficient in the ordinary font when it is applied to general book-work. Next in liability to excessive demand are figures, which are soon exhausted by a series of tables. Every large book or newspaper office doubles, and sometimes quadruples, the amount apportioned to some characters of the scheme.

A large and well-sorted font is always economical as to service. It enables a master printer to com-

A surplus
is needed

How weights
of fonts are
calculated

plete work quickly without delays or stoppages for sorts. It wears better. One font of one thousand pounds will give more service than two fonts of five hundred pounds bought and used successively.

The following table gives the probable capacity of fonts of different weights when used for plain descriptive matter that does not call for an extra supply of peculiar sorts:

The number of solid pages that may be composed with fonts of different weights.

| Allow for surplus in cases. | Weight of font. | Square inches of composition. | Page of 40 square inches. | Page of 30 square inches. | Page of 25 square inches. | Page of 20 square inches. | Page of 15 square inches. |
|-----------------------------|-----------------|-------------------------------|---------------------------|---------------------------|---------------------------|---------------------------|---------------------------|
| 40 | 100 | 216 | 5.40 | 7.20 | 8.64 | 10.80 | 14.44 |
| 70 | 200 | 468 | 11.70 | 15.60 | 18.72 | 23.40 | 31.20 |
| 100 | 300 | 720 | 18.00 | 24.00 | 28.80 | 36.00 | 48.00 |
| 133 | 400 | 861 | 21.52 | 28.70 | 34.40 | 43.04 | 57.40 |
| 160 | 500 | 1164 | 29.10 | 38.80 | 46.40 | 58.20 | 77.60 |
| 180 | 600 | 1512 | 37.80 | 50.40 | 60.48 | 75.60 | 100.80 |
| 225 | 750 | 1890 | 47.25 | 63.00 | 75.60 | 94.50 | 126.00 |
| 300 | 1000 | 2520 | 63.00 | 84.00 | 100.80 | 126.00 | 168.00 |
| 375 | 1500 | 4050 | 102.25 | 135.00 | 162.00 | 204.50 | 270.00 |
| 500 | 2000 | 5400 | 135.00 | 180.00 | 216.00 | 270.00 | 360.00 |

Favored by suitable copy, one may compose more pages than are specified in these calculations, but it is unsafe to plan on the probability of a greater production. For copy that has appar-

ently but a slight excess of figures, small capitals, italic, or quadrats, the fonts will not compose the number of pages specified in the foregoing table.

One pound of type composed solid contains in ems :

| | | | |
|---------------------------|-----|----------------------------|------|
| Pica, or 12-point..... | 131 | Nonpareil, or 6-point... | 524 |
| Small-pica, or 11-point. | 155 | Agate, or 5½-point..... | 620 |
| Long-primer, or 10-point | 188 | Pearl, or 5-point | 752 |
| Bourgeois, or 9-point... | 233 | Diamond, or 4½-point.. | 932 |
| Brevier, or 8-point | 294 | Brilliant, or 4-point | 1176 |
| Minion, or 7-point..... | 384 | | |

The capacity of a font is largely extended by the use of leads. One pound of low leads, standing upright as they do in composed matter, occupies a space of about 4 square inches; one pound of stereotype or high leads occupies a space of not less than 3½ square inches. To find the weight of leads required to fill a defined vacant space, divide the square inches of that space by the figure 4 for low leads, and 3½ for high leads. The thickness of the leads for this purpose must be determined by a count of the composed lines. The addition of a six-to-pica lead in a composition of pica increases the amount of composed matter one-sixth; in a composition of nonpareil, one-third; in any composition from intermediate sizes of type, the increase is by intermediate fractions.

The weight of six-to-pica leads needed for one thousand ems that have already been composed

solid in the copy to be reprinted will vary with different sizes of type, as is specified in the following table. The weights given are in ounces :

| | | | |
|-------------------------|-----|----------------|-----|
| Pica ¹ | 19 | Minion..... | 11½ |
| Small-pica | 16½ | Nonpareil..... | 9½ |
| Long-primer | 15½ | Agate | 8½ |
| Bourgeois | 13½ | Pearl | 7½ |
| Brevier | 13 | Diamond | 6½ |

The weights of the six-to-pica leads in one thousand ems of leaded composition are, in ounces :

| | | | |
|-------------------------|-----|----------------|----|
| Pica ² | 16½ | Minion..... | 9 |
| Small-pica | 14 | Nonpareil..... | 8¼ |
| Long-primer | 12½ | Agate..... | 7 |
| Bourgeois | 11 | Pearl | 6 |
| Brevier | 10½ | Diamond..... | 5½ |

The lead most used is of the thickness six-to-pica. For the larger sizes of long-primer, small-pica, and pica, two of these leads are often used when it is desired to produce the appearance of greater clearness or elegance. For bourgeois, brevier, minion, and nonpareil, the eight-to-pica lead is more freely used. For sizes

¹ To find the weight of six-to-pica leads required for 20 pages of solid pica of 1200 ems each : 20 pages \times 1200 ems = 24,000 ems \times 19 = 456 ounces, or 28½ pounds. The addition of lead expands the composition one-sixth : making 23%, or practically 24 pages.

² To find the weight of leads required for 100 pages of pica, each page containing 800 ems : 800 ems are four-fifths of 1000 ems, and four-fifths of 16½ ounces or 13¼ ounces, which multiplied by 100 pages makes 1320 ounces, or 82½ pounds.

below nonpareil, ten-to-pica leads are thick enough to make the desired relief.

Space occupied by 1000 ems solid, in square inches :

| | | | |
|-------------------------|-------|--------------------------|------|
| English, or 14-point .. | 38.48 | Minion, or 7-point.... | 9.37 |
| Pica, or 12-point | 27.55 | Nonpareil, or 6-point.. | 6.89 |
| Small-pica, or 11-point | 23.16 | Agate, or 5½-point... | 5.79 |
| Long-primer, or 10-pt. | 19.12 | Pearl, or 5-point..... | 4.78 |
| Bourgeois, or 9-point.. | 15.50 | Diamond, or 4½-point. | 3.87 |
| Brevier, or 8-point.... | 12.25 | Brilliant, or 4-point... | 3.06 |

This table will be found of value in determining the size of type that must be selected to make a definite amount of matter fill a prescribed space.

The relations which one thousand solid ems of any body bear to all other bodies are given in the table on the next page.¹

¹ Inexperts in the calculations of space required for a reprint in any change of size of type should carefully study the relations of the bodies as they are shown in these tables. It is a common error to assume, because the bodies of the point system are put apart at fixed and regular distances, that the increase of ems in every change from a larger to a smaller body will be in a similar form of even and exact progression. On the contrary, the progression is uneven and inexact. In the space of 27.55 square inches occupied by 1000 ems of pica can be put 1190 ems of small-pica. This is an increase of 19 per cent. In the

9.37 square inches occupied by 1000 ems of minion can be put 1361 ems of nonpareil. This is an increase of 36 per cent. A comparison of bodies on half-points, as between 5½- and 5-point, will show a similar irregularity. It is not possible, in the American point system, to name one factor which will show the increase or decrease between proximate bodies. Every body is increased or diminished in uneven proportion. The system of points, which seems so regular and exact in its progression by lines, is quite as irregular as any of the old methods when it attempts progression by ems or squares.

The relation that one body bears to other bodies in a composition of 1000 ems solid: showing the gain of ems in a prescribed space by a change from a larger to a smaller body, and the loss of ems by a change from a smaller to a larger body. Calculations made for bodies on the American point system.

| 1000 ems. | 12 point Fica. | 11 point Small-pica. | 10 point Long-primer | 9 point Bourgeois. | 8 point Brevier. | 7 point Minion. | 6 point Nonpareil. | 5½ point Agate. | 5 point Pearl. | 4½ point Diamond. | 4 point Brilliant. | 3½ point Excelsior. | 3 point Excelsior. |
|----------------------|-------------------|-------------------------|-------------------------|-----------------------|---------------------|--------------------|-----------------------|--------------------|-------------------|----------------------|-----------------------|------------------------|-----------------------|
| 12-point Fica | 1000 | 1190 | 1440 | 1778 | 2250 | 2939 | 4000 | 4760 | 5760 | 7111 | 9000 | 11755 | 16000 |
| 11-point Small-pica | 840 | 1000 | 1210 | 1494 | 1891 | 2469 | 3361 | 4000 | 4840 | 5975 | 7563 | 9878 | 13444 |
| 10-point Long-primer | 694 | 826 | 1000 | 1235 | 1563 | 2041 | 2778 | 3306 | 4000 | 4938 | 6250 | 8163 | 11111 |
| 9-point Bourgeois | 563 | 669 | 810 | 1000 | 1266 | 1653 | 2250 | 2678 | 3240 | 4000 | 5063 | 6612 | 9000 |
| 8-point Brevier | 444 | 529 | 640 | 790 | 1000 | 1306 | 1778 | 2116 | 2560 | 3160 | 4000 | 5224 | 7133 |
| 7-point Minion | 340 | 405 | 490 | 605 | 766 | 1000 | 1361 | 1620 | 1960 | 2420 | 3063 | 4000 | 5444 |
| 6-point Nonpareil | 250 | 298 | 360 | 444 | 563 | 735 | 1000 | 1190 | 1440 | 1778 | 2250 | 2939 | 4000 |
| 5½-point Agate | 211 | 250 | 303 | 373 | 473 | 618 | 840 | 1000 | 1210 | 1494 | 1891 | 2469 | 3361 |
| 5-point Pearl | 174 | 207 | 250 | 309 | 391 | 511 | 694 | 826 | 1000 | 1235 | 1563 | 2041 | 2778 |
| 4½-point Diamond | 141 | 167 | 203 | 250 | 316 | 414 | 563 | 669 | 810 | 1000 | 1266 | 1653 | 2250 |
| 4-point Brilliant | 111 | 132 | 160 | 198 | 250 | 327 | 444 | 529 | 640 | 790 | 1000 | 1306 | 1778 |
| 3½-point Excelsior | 85 | 101 | 123 | 151 | 191 | 250 | 340 | 405 | 490 | 605 | 766 | 1000 | 1361 |
| 3-point Excelsior | 63 | 74 | 90 | 111 | 141 | 184 | 250 | 298 | 360 | 444 | 563 | 735 | 1000 |

The irregular progression of bodies made on the system of points is shown by the diagram on the right side. The straight hair-line by the side of this column of em quadrats does not touch each quadrat on its corner, as it should. It diverges at an increasing angle, which proves an irregular progression of the smaller bodies.

The hair-line by the side of the column on the left side of this diagram touches every em quadrat at its corner, and proves that each body has been regularly increased or decreased by geometrical rules. In an ascending scale Bruce's pica is about $12\frac{1}{4}$ per cent. (.122462) larger than the small-pica. In a descending scale, small-pica is but $10\frac{7}{8}$ per cent. (.108723) smaller than the pica. These factors can be applied to all proximate bodies: $12\frac{1}{4}$ per cent. for the increase, and $10\frac{7}{8}$ per cent. for decrease. See table on page 148.

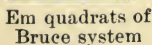

Em quadrats of
Bruce system

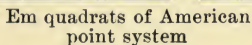

Em quadrats of American
point system



V

The Faces or Styles of Type Old-style Roman

UNDER the American system of points the bodies of type are clearly described by numerical names. Faces and styles have to be described by a ruder method, with long names of two, three, or four words. The first word always describes the body. If no other word is added, this single word is always understood as the name of a body with roman face: *pica* is *pica roman*. The second word more plainly describes the face or style, as *pica antique* or *pica gothic*. The third word usually describes its form as to thickness or thinness: *pica antique extended* is a thick type, and *pica antique condensed* is a thin type. The fourth word is intended to describe its fashion of ornament, as *pica antique condensed outline*; but all ornamental types, and indeed many

The methods
observed in
naming faces

plain types, are named and classified in an unsatisfactory manner. The names given to many of them are fanciful and not at all descriptive. When made by different founders, the same face may be labeled by each founder with a different name. The antique of the United States is the egyptian of Great Britain; the antiqua of Germany is the roman of England and the United States.

Arbitrary or fanciful names are seldom given to roman types. Every distinctive face or style is labeled by the founder with a number arbitrarily selected. One type-foundry uses numbers for all faces, roman or ornamental.

The type-founders of the United States, in their price-lists, arrange printing-types in three distinct classes. Roman and italic are put in the first class; plain faces of display type, like antique, gothic, and clarendon, are in the second class; ornamental types of every kind are in the third class. Greek and orientals, music and some faces of script, are properly put in another distinct class; but types of this fourth class, having but a limited sale, seldom appear in the ordinary price-list.

Within the limits prescribed for this volume it is not practicable to illustrate or even enumerate all the faces that have been made for the first and second classes. All of them are based on the roman model, which is still accepted as the simplest and best for a readable text-type.

Script types are imitations of different styles of handwriting, but every one of them, even the most flourished, was modeled on some fashion of roman letter preferred or used by early copyists.

Italic is but a simplified style of disconnected script. Its capitals differ from roman mostly in their inclination.

Black-letter is a degenerate form of roman, in which angles are substituted for curves. Its capitals are probably imitations of the hasty flourishes of an inexpert penman.

Gothic, without serifs, the simplest and rudest of all styles, seems an imitation of roman capitals cut in stone.

Italian is a roman in which the positions of hair-line and thick stroke have been transposed.

Title, or fat-face, is a broad style of roman with over-thick body-marks.

Antique is a roman in which the lines of all the characters are nearly uniform as to thickness, with square corners and of greatly increased boldness.

Ornamentals of every style, and even the newest varieties of eccentric types, show some conformity to the roman model.

The roman face is always in most request, for roman is the character preferred as a text-letter by all English-speaking peoples and most used all the Latin races. Its only serious rival in general literature is the fractur, or the popular face of German type; but even in Ger-

many roman is largely used as the text-letter for scientific books, and for inscriptions on coins and medals. Not one of the many new faces introduced by the type-founders of this century has ever been considered an improvement on or accepted as a substitute for roman.

Every complete font of roman type between and including the most-used sizes of pearl and great-primer is provided with three series of characters: capitals, small capitals, and lower-case or small letters.¹ Small capitals are not made for the smallest size of brilliant, nor for the sizes above great-primer. Italic, although of a distinct face, is always made a part of every large font of roman type, and must be regarded as its inseparable mate, for the italic of every approved roman should have been cut to line with its accompanying roman and to illustrate its peculiarity of style.

Has three series of characters

With italic capitals and italic lower-case added, there are five series in every complete font of our selected text-letter. This is a peculiarity not to be found in any other literary character. The older forms of orientals have one series only; the modern forms of Greek, German, and Russian have but two. The capitals of German are too complex to be used alone as

With italic there are five series

¹ The phrase small letters is objectionable for its vagueness; lower-case is technical and not generally understood. Dr. Taylor uses instead the word minuscule, which is exactly descriptive to bibliographers, but not to the ordinary reader.

a display letter for titles or headings. Emphasis or display in German is made in the text, either by hair-spacing the emphatic words, or by the use of an entirely different font of thick-faced letter. The poverty of all other alphabets in single or double series is in marked contrast with the affluence of the five correlated series of the roman alphabet, which enable the writer or printer to make emphasis, display, or distinction without a change of size or the violation of typographical propriety. The judicious alternation of capitals, small capitals, italic, and lower-case makes printed matter readable and rememberable. The greatest merits of the roman letter are its simplicity and perspicuity: it has no useless or unmeaning lines. One has but to compare it with any other character, modern or ancient, to see how much simpler and more readable it is.

Roman capitals, as now made by type-founders, are imitations of the lapidary letters used by the Romans. Three characters only have been added: the **J**, to distinguish it from the Latin **I**, and the **U**, to distinguish it from the **V**. The **W** is a gothic addition. The lower-case letters are imitations of the characters made by early French and Italian copyists, which characters are described by Dr. Taylor as the Caroline minuscule, in use in France as early as the ninth century.¹

Derivation
of the roman
character

¹ "The Alphabet," vol. ii, pp. 164, 181.

The capital and lower-case letters were first made in type in the year 1465 by Sweinheim and Pannartz at Subiaco, near Rome, but the form made by Jenson of Venice in 1471 has ever since served as the model for all type-founders.

Small capitals and italic were made in type for Aldus Manutius of Venice, and first shown by him in his octavo edition of Virgil, dated 1501. The model selected was the handwriting of Petrarch. Following his fashion the capital letters used for italic were not inclined: they were made but little larger than the round letters of the lower-case, and were separated from the text by a perceptible white space.¹ The italic of this Virgil had little inclination, and seems free from kerned letters; but ligatures and double letters and different forms of the same letter were made. Aldus and his sons used italic as the text-letter for many books.

Earliest use of
small capitals
and italic

A B D M N P R T U

Swash letters.

The printers of France seriously altered the italic of Aldus; they gave the lower-case letters more inclination, and made free use of kerns. Garamond made the capitals of full height, and filled up the gaps made by the inclination with little flourishes. The capitals so altered are known as swash letters.

¹This fashion was not peculiar to Petrarch. It was observed by all Italian copyists of that time, nor is it yet obsolete in Italy.

The roman form of type is subdivided by printers and foundryers into the two classes of old-style and modern-face. Many varieties of each style are made; in some of them the distinctive peculiarities of the style are discerned with difficulty. The points of difference may be seen in the contrasted forms of each letter as shown on the following page. The faces selected are "Caslon" old-style, from the type-foundry of the MacKellar, Smiths & Jordan Co., and the No. 3 modern-face is from the foundry of George Bruce's Son & Co.

In the old-style the so-called hair-line is comparatively thick and short; the stem is protracted to great length before it tapers to the hair-line. In the modern-face the hair-line is sharp and quite long, and the stem is relatively short. Contrast the capital C and the lower-case m in the forms of each style. In the old-style the serif is short, angular, and stubby; in the modern-face the serif is longer, lighter, and more gracefully curved or bracketed. The general effect of the old-style is that of angularity; smoothness in curves and gracefully tapering lines are not attempted. The general effect of the modern-face is that of roundness, precision, and symmetry. As a bit of drawing each letter of a well-made modern-face is exact, and carefully finished in all its details; but when any letter is seen with its mates in a mass of composed types,

| | | | |
|-----|-----|-----|-----|
| A A | a a | N N | n n |
| B B | b b | O O | o o |
| C C | c c | P P | p p |
| D D | d d | Q Q | q q |
| E E | e e | R R | r r |
| F F | f f | S S | s s |
| G G | g g | T T | t t |
| H H | h h | U U | u u |
| I I | i i | V V | v v |
| J J | j j | W W | w w |
| K K | k k | X X | x x |
| L L | l l | Y Y | y y |
| M M | m m | Z Z | z z |

its high finish does not seem to be a merit. A letter of modern-cut is really not so distinct as the same letter in the old-style. The old punch-cutter and the modern punch-cutter worked to reach different ends. The old cutter put readability first; he would make his types graceful if he could, but he must first of all make them distinct and readable in a mass. His object was to aid the reader. The modern punch-cutter thinks it his first duty to make every letter of graceful shape, but his notion of grace is largely mechanical: the hair-line must be sharp and tend to its invisibility; the curving stem must dwindle to its hair-line with a faultless taper; the slender serif must be neatly bracketed to the stem. Every curve and angle is painfully correct and precise, but the general effect of types so made, when put in a mass, is that of the extreme of delicacy, and of the corresponding weakness of an overwrought delicacy. To use a painter's phrase, the work is niggled, or overdone. Without intending to do so, the punch-cutter has been more intent on showing his own really admirable skill than he has been in helping the reader. His letters, undeniably graceful when viewed singly, are not so effective when seen in the combinations of a page or a column.¹

¹ The superior distinctness of the old-style can be proved by this simple experiment. Select equally well-printed pages of old-style and modern-cut, of uniform body and thickness of stem, and place them in a favorable light. Then, moving away from them, note how much sooner types of modern-cut become indistinct.

Roman letter has been an object of experiment with type-founders for nearly four centuries, but it is impossible to illustrate or even mention one-quarter of these experiments. Many forms once popular have gone out of use, and have been forgotten. It is not at all important that these old fashions should be described. For the purpose of this work, it is enough to illustrate only the types that are now made and most used.

It is a misfortune that the illustrations of the different cuts of modern-faces about to be shown have to be made in types of comparatively small size. Few roman faces of a decided character are made on bodies larger than great-primer; more of them are on bodies smaller than small-pica. A face on double-pica body would show the peculiarities of its style more clearly than the same face on pica body. In the larger sizes the mannerisms that produce a certain general effect are apparent at a glance; in the smaller sizes they are discerned only by study.

The peculiarities of the Caslon style, as shown on pages 69 to 77, need little explanation. Note the greater breadth of the stems of each letter and their protraction before they change to a hair-line or connect with another stem, as may be plainly seen in the arch of the **M** and **N**, and the curve of the **C**, **E**, and **O**. The hair-lines are firmer, although shorter than in modern-cut; the serifs at the foot are shorter and

stronger, but seldom bracketed; the serifs at the top, as in the **l**, **d**, **p**, **h**, are angled and strongly bracketed.

The defects of this style are: too long a beak to the **f** and **j**; unnecessary narrowness in the **S** and **a**, and in some capitals; too great width of the **C**, **O**, and **V**. But these are trifles. In general effect the Caslon is bold, but not black; clear and open, but not weak or delicate. There are few noteworthy faults of lining or fitting-up. It was made to be read and to withstand wear. Some variations in style may be detected in a comparison of different sizes of this cut, but it is fairly uniform as to general effect throughout the series.

The modern-face is in strong contrast to the Caslon style. The stems are sometimes relatively thicker, but in all curved lines they are shorter. The serifs are much longer; in many of the capitals they are strongly, and in all the lower-case but feebly, connected with the stems. The hair-lines are sharper, but of greater length and greater weakness. Lining and fitting-up are admirable; drawing and cutting, excellent. It is a remarkably graceful and beautiful face of type when entirely new, yet it is not a good type for reading, for the sharp hair-lines are readily seen only by readers of excellent eyesight. Nor is it a good form to withstand wear. The force of impression needed to print the thick stems soon gaps or crushes the unprotected hair-

lines. When the serifs have been thickened and the hair-lines gapped by wear, the beauty of the best cuts of modern-face soon disappears.

The modernized old-style here shown is an attempt to accommodate the old fashion to newer notions of symmetry. The objection-
 Features of
 the modern-
 ized old-style
 able features in the letters a, g, W, S, O, C have been removed. The body-
 marks have been made slightly narrower and the hair-lines a little sharper, but, as some think, not to their improvement. The protracted stem, the short hair-line and serif, have been preserved. The greatest change has been made in shortening

The Old-style of this modernized form was first made for Miller & Richard, Edinburgh, about the year 1860.

Modernized old-style on double small-pica body, solid.¹

George Bruce's Son & Co., New-York.

ascenders and descenders, and in the consequent enlarging of the small or round letters. The

¹ This modernized old-style & Richard by Phemister, then designed and cut for Miller of Edinburgh, later of Boston.

modernized old-style pica seems larger than the pica of Caslon. It is a broader letter, yet it does not have a similar relief of white space between the lines. This feature is most noticeably shown in this specimen of double small-pica, which in a large page is much improved by leading.

The general effect of the smaller sizes of this style (which is more fully illustrated on pages 82 is restful to the eye to 97 of this work) is that of a pleasing and a restful monotony. It does not irritate the eye with sharp contrasts of bristling angles and thick and thin lines; it does not challenge the reader's attention to a study of its individual characters. For this reason it is preferred by many authors for serious books, and by many publishers as the best form of colorless text-letter to put around engravings on wood that show strong contrasts of black and white.

Other foundries have made new faces of the old-style character which show their notions of commendable improvements. Few of these new faces are firm or bold; in nearly all, the angular features are rounded or softened. Large faces with thin body-marks and hair-lines are preferred. There seems to be a real avoidance of the firmness of line which is the best feature of this character. An old-style so treated is often a graceful character; it has, or may have, the contour of the best old model, but it does not produce the strong effect of the true old-style letter.

One of the first, if not the first, of the modernized old-styles produced in this country was designed and cut in 1863 by A. C. Phemister, to the order of Phelps & Dalton, who called the new letter the "Franklin face." It is a trifle wider as to

BENJAMIN FRANKLIN was born in Boston, 17th of January, 1706, and died in Philadelphia, 17th of April, 1790. He began his apprenticeship as printer in 1718, and worked as a journeyman in Philadelphia in 1724, and in London in 1725. He returned to Philadelphia in 1726, and there began as master printer in 1729. As editor and publisher he soon made himself a man of note. He invented the Franklin stove in 1742; he proved the identity of lightning and electricity in 1752; he was made clerk of the Assembly in 1736; postmaster of Philadelphia in 1737; deputy postmaster-general for the colonies in 1753; representative of Pennsylvania before the council of England in 1757 and again in 1764; delegate to Congress in 1775; ambassador to France in 1776; commissioner to England in 1783; president of Pennsylvania from 1785 to 1787; delegate to the constitutional convention in 1787. ~~~~~

Franklin old-style on long-primer body, solid.
Phelps, Dalton & Co.

form and larger as to face, and consequently more open and perhaps a little more inviting to the eye than his first attempt, as shown by Miller & Richard. Some characters have been much improved;

they show an evident leaning to the forms that are most approved in modern-cut letter.

THURLOW WEED was born in Cairo, Greene County, New York, 15th November, 1797, and died in New York city 22d November, 1882. He entered a printing office when but twelve years of age. In 1815 he was a journeyman in New York city, working by the side of James Harper in the office of Paul & Thomas. In 1819 he established a weekly newspaper in Norwich, Chenango County, New York. In 1830 he established the "Albany Evening Journal," which soon became a power in politics. He never held any public office, yet he exerted a wonderful influence in the management of men and in the direction of public affairs. He did good service to the United States in defending national interests abroad during the civil war.

Large-faced old-style on long-primer body, solid.
Phelps, Dalton & Co.

To supply a demand for a still larger face, the same foundry had cut for it by the same punch-cutter a large-faced old-style in a full series of book sizes. The specimen here presented is on long-primer body, but it seems quite as large as the small-pica shown upon page 86 of this work. This enlargement was made by shortening the descenders and ascenders, and pushing them to the verge of the body. It will be noted that long

types in adjacent lines often touch and seem to connect. It is a well-cut and readable letter, but it is neither true old-style nor modern-cut.

The Binny face and the Bradford face made by MacKellar, Smiths & Jordan Co. are other meritorious forms of modernized old-style.

To meet a demand for a "real" old-style, a series of book sizes has been produced, either from refurbished old punches, or from new punches in faithful imitation of the English or Dutch roman letter in general use during the first half of the

WILLIAM JANSEN BLAEW, a distinguished printer of Holland, was born in 1571 and died at Amsterdam in 1638. He had been taught the trade of a joiner, at which work he made himself efficient as an assistant to the astronomer Tycho Brahe. After receiving instruction from Brahe, he went to Amsterdam, and there distinguished himself by the publication of maps and the making of geographical globes. His frequent visits to the printing office taught him something about printing, and led him to establish an office for his own work. Dissatisfied with the old form of hand-prefs, he reconstructed it, and made many valuable improvements which were gradually accepted by printers everywhere. His "Theatrum Mundi," in fourteen volumes folio, is one of the best specimens of the printing and engraving of the seventeenth century.

Original old-style on long-primer body, solid.
MacKellar, Smiths & Jordan Co.

seventeenth century. It is a lean letter with a small face, and has many characters now regarded as uncouth. The **Et**, the long **f** with its train of doublets, and other obsolete forms are conspicuous. For the reprints of many English books published in the eighteenth century this original old-style is the most appropriate, but its meagreness and quaintness have often prejudiced many readers against all forms of old-style.

There are authors who are not content with the moderate rudeness of the "original" old-style, but want an earlier and cruder form. For this taste, types have been made in imitation of the roman used by printers in France, Italy, and Holland during the sixteenth and seventeenth centuries.

The Chiswick Press has an old-style which is a reproduction of a bold face once used by printers of Basle and by some early Italian printers. It was made about 1887 exclusively for the books of the Chiswick Press, and has been employed by that house as a choice letter for works of merit. It is a bold and readable letter. Its most noticeable features are an upward slope of the cross-bar in the **e**, greater thickness of the stems, avoidance of hair-lines, stubbiness of serifs, obliqueness of the thick strokes in rounded letters like **O**, **C**, **p**, **q**, large small-capitals, and an increased width of many of the large capitals. It is one of the modern old-styles that retains characteristic peculiarities. At

this date (1891), it has been made only on a small-pica body, and has as yet no appropriate italic.¹

¶ CHARLES WHITTINGHAM, first of the name in the annals of printing, was born in 1767, at Calledon, in the county of Warwick, England. About 1790 he began business at London as a master printer. In 1810 he removed to Chiswick, and there founded the CHISWICK PRESS, which ever since has maintained the highest reputation for good book printing. He died in 1840. His nephew Charles (born in 1795), succeeded to the business and to the friendship and confidence of the publisher, Pickering, for whom he made many admirable books. After his death in 1876, the business was continued by his executors. ~~~~~

The Basle old-style of the Chiswick Press.

The seventeenth-century style, or, as it is often called in this country, the Elzevir² style, was re-

¹ The peculiarities of this Basle style are more strikingly presented in some books printed at Venice at the close of the fifteenth century.

² The name Elzevir is unwisely chosen, for this face is unlike the Van Dijk face, largely used by the Elzevir family. Who then did make it? Didot ("Essai sur la Typographie," p. 699) says that Garamond and Sanlecque made types for the Elzevirs. A

recently published book, "Tipo Italiano non Elzeviriano," appunti di B. L. Centenari, Rome, 1879, intimates that the Elzevirs were provided with Italian types. The author gives us no satisfactory evidence in support of this intimation, and Willems ridicules it, but it must be admitted that this so-called Elzevir letter has features unlike those of any seventeenth-century face made in France or Holland.

LOUIS ELZEVIR was a publisher at Leyden from 1583 to 1617. His sons Matthew, Louis, Josse, Gilles, and Bonaventure were also publishers: Matthew at Leyden, Louis and Gilles at La Haye, Josse at Utrecht, Bonaventure, who also was a printer, at Leyden. . . . Abraham and Isaac, sons of Matthew, were printers and publishers at Leyden. Jacob, another son, was a publisher at La Haye. . . . Daniel, ablest of the family (son of Bonaventure), was printer and publisher, first at Leyden, and afterward at Amsterdam, between the years 1652 and 1680.

Seventeenth-century old-style on body 10, solid.

Gustave Mayeur, Paris.¹

vived in 1878 by Gustave Mayeur of Paris, who says that he selected for his model the types of a The Elzevir old-style book printed in 1634 by the Elzevirs of Leyden. It is a compressed letter, with a large open face, with very short ascenders and descenders, and thin stems, plainly made to withstand wear, for the few hair-lines are of unusual thickness and all the serifs are short and stubby.

¹ Mayeur finds this style in a complete book series, on all bodies from body 5 to body 14, including a specially cut and properly mated italic; and in the form of two-line capitals only on several bodies between body 10 and body 72. Farmer, Little & Co., of New York, who

have drives from the original punches, found complete fonts of this face, with its italic on 6-8-10- and 12-point bodies. Several American foundries make some of these larger sizes with an appropriate lower-case. Three lines of a larger size can be seen on page 51.

Although fitted with unusual closeness it is a readable letter, and popular, not only with publishers and authors, but with job printers. Its full series of durable two-line letter makes it especially valuable for book titles and open display.

Phelps, Dalton & Co. of Boston make a variation of this face which has the characteristics of the original in the features of firm hair-lines, close set, stubby serif, and ability to withstand wear, with the added feature of greater compression.

SAMUEL NELSON DICKINSON was born in the town of Phelps, Ontario County, New York, 11th December, 1801. After learning the trade of a printer in the Palladium office, Geneva, N. Y., he worked as a compositor in New York city and Boston. In 1829 he began business as a master printer. Inability to get the types he needed led him to type-making, in which he soon acquired distinction, his styles being preferred by the printers of New England. He died in Roxbury, Mass., on the 16th day of December, 1848. He was succeeded by Sewall Phelps, a proof-reader of education, and Michael Dalton, an expert type-founder. After the death of Phelps in 1863, and of Dalton in 1879, new members were admitted, of whom now remain George J. Pierce, Alexander Phemister, A. C. Converse, and J. W. Phinney, trading under the firm-name of Phelps, Dalton & Co. 

Elzevir old-style on long-primer body, solid.
No. 19 of Phelps, Dalton & Co.

The "Ronaldson old-style" was designed and made in 1884 by the MacKellar, Smiths & Jordan Ronaldson Co. In this face the squared or angled old-style shoulder of the m and n, and all other peculiarities of old-style, are strongly emphasized. Note the angled serifs of the lower-case, and the added angles given to many of the capitals. It

JAMES RONALDSON was born in 1768, at Gorgie, near Edinburgh. In 1794 he went to Philadelphia and there followed the business of biscuit-baking. When the bakery was destroyed by fire, in 1796, he sought a new business, which he found in a partnership with ARCHIBALD BINNY, a practical type-founder. Ronaldson contributed the money; Binny the tools and the practical knowledge. The partnership, which lasted for many years, was of mutual advantage. Ronaldson died in Philadelphia in 1842. ~~~~~

Ronaldson old-style, on pica body, solid.
MacKellar, Smiths & Jordan Co.

is a remarkably clean-cut letter; the counters are deep, and each character has a notable sharpness and clearness. It is a very popular letter with job printers.

The form of modernized old-style most used in France, Belgium, and Italy is rounder, fatter, and more open than the popular old-styles of England or America. Usually it is of light face, with firm and visible hair-lines. Its most pronounced peculiarities are the great width of the rounded capitals and an apparently fanciful rearrangement of stems and hair-lines. The small capitals are often weak and inconspicuous. Some French founders give their small capitals a wider set, so that they seem hair-spaced, but this treatment more plainly exhibits their meagreness. The quotation marks

FRANÇOIS DIDOT, the first of a long line of French typographers, was born in Paris in 1689. He served apprenticeship to ANDRÉ PRALARD, printer and publisher of that city. In 1713 he was established as a master printer, choosing for his sign and trade-mark the «Golden Bible.» He soon acquired a good reputation for the beauty of his typography, of which «l'Histoire générale des voyages» in twenty quarto volumes is an excellent example. In middle age he was made syndic of the corporation of booksellers and printers. He died 2d November, 1759. 

French old-style on body 11, solid.
Fonderie Turlot, Paris.

are more distinct and of better form than those used in the English language.

For dictionaries and catalogues in old-style face that have extended notes or explanations, French ^{Condensed} printers prefer a condensed form of old-^{old-style} style, with lower-case large and capital letters exceedingly small, in which the stem is but little thicker than the hair-line. The capitals are often low of height to allow the addition of accents. This condensed form of letter, known by the name poetic-face, is still preferred in France for poetry. Its thinness prevents the turning over of long lines.

The Portuguese old-style on page 206 was cut about 1804 by Joaquim Carneiro Silva, then an engraver attached to the Typographia Regia de Lisboa, now known as the Imprensa Nacional de Lisboa. It has never been used out of this office, and is not for sale. Although a distinct old-style character, it betrays, in the mannerisms of some of the letters, traces of fashions then prevailing. Note the thinness of the E, the crossed bars of the W, and the greater width of the rounded capital letters. The peculiarities of its cut may be discerned more plainly in the capitals that follow.

| | | | | | | | | | | | | | |
|---|---|---|---|---|---|---|---|---|---|---|---|---|---|
| A | B | C | D | E | F | G | H | I | J | K | L | M | N |
| O | P | Q | R | S | T | U | V | W | X | Y | Z | | |

N^o.

XXXIV.

32

CICÉRO POÉTIQUE.

UN Général d'armée recevant de toutes parts des plaintes contre un Munitionnaire , le fit venir , & pour premier compliment le menaça de le faire pendre. Monseigneur , répondit froidement le Munitionnaire , on ne pend pas quelqu'un qui peut disposer de cent mille écus ; & là-dessus ils passèrent dans le cabinet. Un instant après , Monsieur le Général en sortit persuadé que c'étoit un fort honnête-homme.

Ceci nous apprend qu'on ne doit pas juger trop précipitamment de la conduite du prochain , ni le condamner sans l'entendre. Il est bien aisé de dire que certaines gens sont des fripons , mais il faut le prouver.

From Fournier's "Manuel Typographique."

THOMAS BEWICK, the reviver of the art of engraving on wood, was born at Cherryburn, England, 12th August, 1753, and died at Gateshead, 8th November, 1828. In 1775 he took the first prize for the best woodcut. In 1790 he published a "History of Quadrupeds" with illustrations drawn and engraved by his own hand. In 1797 appeared the "British Birds," which at once established his reputation as a great master in the art of engraving on wood.

Portuguese old-style, on body 14, solid.

From the Imprensa Nacional de Lisboa, by permission of the manager, Dr. V. Deslandes.

When William Morris determined to make a new style of roman type, he selected for his model the roman type on great-primer body of Nicolas Jenson. Morris put his adaptation on english or 14-point body, but he made it very much bolder and blacker. The Golden type, for so Morris named it, approximates the thickened face known in



THE Kelm-
scott Press
began work
at Hammer-
smith in Fe-
bruary 1891.
The design-
er of the type
W. Morris,
took as his

model Nicholas Jenson's Roman letter used in Venice in the 15th Century, and which unites in the fullest degree the necessary qualities of purity of line and legibility. Jenson gives us the high-water mark of the Roman character: from his death onwards typography declined till it reached its lowest depth in the ugliness of Bodoni. Since then the English typographers following more or less in the footsteps of Caslon, have recovered much of the lost ground; but as their work is almost always adapted for machine printing it has a tendency to exaggeration of lightness and thinness, which may well be corrected, in work printed by the hand-press.

America as antique, and in England as egyptian, more closely than it does any style now known by the name of roman. It first appeared in 1891, in "The Story of the Glittering Plain." Bibliophiles welcomed the new style as a pleasing return to the simplicity of the early printers, and as a vindication of the superior merit of old-fashioned masculine printing. Publishers did not entirely approve; they acknowledged its merit, but said that the Golden type was too black and rude for the ordinary book. This seems to have been intended, for Morris made it in one size only, and refused to sell types or matrices, or give the right to reproduce. Imitations have been made, but they are seldom used for texts, and mainly for the headings of newspaper articles, or for lines of display in advertisements and pamphlets.

The merit of the Golden type is not in its sturdy medievalism, but in its simplicity and legibility, and these are features which will be maintained in future imitations, but perhaps not so emphatically, when our effeminate style of roman shall have been discarded. The text of the illustration on page 207 was written by William Morris, and composed in the printing room of the Kelmscott Press in 1894. It was kindly sent as a contribution to this book.



VI

Modern Faces of Roman Letter

NOT one of the styles approved in England and France at the close of the last and the beginning of this century is now in favor. The forms of Jackson, Fry, and Baskerville are never imitated. Even in Italy and France the styles of Bodoni and Didot had but a brief popularity. The recently revived taste in Paris for the Didot faces is restricted to a few fine books, and promises to be but a passing fancy. The only style that lasted for many years was the fat-face of Robert Thorne, shown on the following page.

Changes in
the fashion
of types

This is the "fat-faced, preposterous disproportion" stigmatized by Hansard. Between 1810 and 1840 it was a popular style, made in all sizes from pearl to canon. In many printing houses it supplanted the better styles of Caslon, Baskerville, and Jackson. Its passport to favor was the general

**William Rittenhouse,
a Hollander, establish-
ed a Paper Mill near
Philadelphia, Pa., and
there made Paper for
printing about 1690.**

Fat-face on paragon body, leaded.
George Bruce's Son & Co.

belief that it was more readable and more durable than any of the older styles. This belief was not confirmed by experience. To get a clear print from this face required more ink and more impression, but excess of ink on the small sizes filled the low counters and strong impression ruined the fine lines. When it had received but one-half the usual amount of wear each character was discerned mainly by its body-marks. It soon went out of fashion as a book-type, and is used by job printers now only in the larger sizes. Blackness and boldness of stem are not enough to make a type readable and durable; width of counter, firmness of hair-line and serif, and proper relief of white, are really more important.

The face shown on this page is as bold a face of roman as will be found acceptable for a book-text. It is carefully drawn and well cut, is not over black, and has fair relief of white space, with many other pleasing features which commend it to job printers for catalogues, law work, and documents; but publishers seldom select it for a standard book. Its strong contrast of long and sharp hair-lines with thick and black stems makes the print dazzling and somewhat irritating to the eye. It is not a restful type; it attracts attention, but proves wearisome when diligently read.

WILLIAM BRADFORD, the first printer in New York, was born in Leicester, England, in 1658, and began business as a master printer in Philadelphia in 1682. Many disagreements with the ruling authorities compelled him to go to New York, where, in 1693, he published his first print. He printed in New York for over fifty years. In 1725 he published the "New York Gazette." In 1728 he had a paper mill in Elizabethtown, N.J. He died at New York in 1752.

Modern bold-face on pica body, solid.
George Bruce's Son & Co.

ISAIAH THOMAS was born in Boston, 19th January, 1749, and died in Worcester, 4th April, 1831. At six years of age he was apprenticed to Zachariah Fowles, printer, for eleven years. In 1770 he began the publication of the "Massachusetts Spy," which he was soon after obliged to remove to Worcester for fear of the destruction of his printing office by the Tories. He soon became eminent as a publisher; the "Farmer's Museum," the "Massachusetts Magazine," a folio Bible, and most of the hymn books and school books of New England came from his presses. He was the first American printer who imported music types, and printed a text in Greek. He was the founder of the Antiquarian Society of Worcester, and the author of a valuable history of printing in two volumes.

Scotch-face on long-primer body, solid.

Phelps, Dalton & Co.

The plan or design for the peculiar style known as the Scotch-face was first originated in 1837 by Dickinson's S. N. Dickinson of Boston. Alexander Scotch-face Wilson & Son cut the punches to his order and so made the first "Scotch-face" types. Matrices from these punches were imported by the designer, who cast from them in 1839 the first types made in his new foundry. The illustration on this page is a specimen of the types cast from these matrices.

As first made the Scotch-face was a small, neat, round letter, with long ascenders, and not noticeably condensed or compressed. A complete series

of the Scotch-face seems to have been shown first in America by James Conner of New York. Printers acknowledged the superior grace of this novel style, which gradually supplanted every other. After thirty years of popularity complaints of it were heard. Newspaper publishers said that the first face was too small for the body; and the reprinters of cheap books declared the enlarged face to be too round, which prevented the frequent use of it in poetry. These objections led to the making of a more condensed form.

HORACE GREELEY was born in Amherst, New Hampshire, 3d February, 1811, and died in Pleasantville, Westchester County, New York, 29th November, 1872. His earliest training as a printer began in East Poultney, Vermont, in 1825. In 1831 he went to New York. In 1833 he began as a master printer; in 1834 he established the "New Yorker," in 1840 the "Log Cabin," and in 1841 the "New York Tribune," which, during his long term of editorship, became a journal of unprecedented influence in politics. He was a clear thinker, and a ready writer in a style of remarkable strength. A fearless opponent of slavery he made many enemies, but all hostilities ended with his death. By general consent he takes a rightful place in the annals of typography as "our later Franklin."

Scotch-face on 10-point body, solid.

James Conner's Sons.

The peculiarities of the condensed Scotch-face may more clearly be seen in this specimen of a size A condensed cut in 1854 by James Lindsay. Note Scotch-face the extension and slenderness of hair-line in the arch of m, n, p, c, a, r; the length of the serifs, and the general elongation of all the characters after the fashion of French types.

JOEL MUNSELL, a publisher and printer of eminence was born in Northfield, Mass., 14th April, 1808, and began as master printer in Albany, New York, about 1827. Munsell was an industrious collector of books on typography, the author or the compiler of several books on paper and printing, the publisher of books on American history, and a founder of the Albany Institute. He died in Albany 15th January, 1880.

A condensed Scotch-face on english body, solid.
George Bruce's Son & Co.

The condensed form of Scotch-face is now out of fashion, for its long serifs and short hair-lines and its feminine delicacy of cut are not pleasing when the letter has received ordinary wear. The rounder faces of this style retain their popularity.

FRANÇOIS-AMBROISE DIDOT, son of François, was born in Paris, 7th January, 1730, and died 10th July, 1804. He gave much attention to the improvement of type-founding and paper-making. His system of typographic points supplanted that of Fournier. At his suggestion, and by his aid, the paper-maker Johannot first made the *papier vélin* or calendered paper. His most celebrated works are the "DAUPHIN" edition of the classics, in thirty-two volumes, 4to, and the "ARROIS" edition of sixty-four volumes, 18mo, which are highly prized by collectors.

The condensed French-face on body 12, solid.
Gustave Mayeur, Paris.

This form but not this face of thin letter, which was probably the model for the condensed Scotch-face, was introduced to French printers by Fournier in 1776 as a type "in the Dutch style." François-Ambroise Didot preferred the rounder forms, but condensed faces have always been popular in France. The French old-style, the English-face and the Elzevir are often preferred by French publishers for books, but the thin form is still selected for newspapers, pamphlets, magazines, and all the ordinary forms of printing. Modern French taste inclines to a

greater lightness of stem, but the general form of the condensed style has not been seriously changed. One variety, having ascenders and descenders of great length, known as the poetic-face, had a great popularity when Lamartine, Hugo, and De Musset wrote in verse. The merit of the letter was in its delicacy and thinness, which enabled the printer to put on a narrow page twelve syllables in one line of large-faced type. Although not in fashion as it has been, it is still used in many French offices.

The face shown on this page is an American adaptation of a prevailing French fashion. The lower-case letters are over high, necessarily mak-

ALEXANDER ANDERSON, the father of wood engraving in America, was born in New York, 21st April, 1775. Although a qualified student and a licensed practitioner of medicine, he preferred the art of engraving, beginning his work when but twelve years of age on bits of copper and type-metal. He was entirely self-taught; but he accepted the blocks of Bewick as his models of style. For eighty years he was a diligent worker. He made many blocks of more than ordinary merit. LANSING, MORGAN and HALL were his pupils. He died in Jersey City, 17th January, 1870.~~~~~

Compressed-face on long-primer body, leaded.
George Bruce's Son & Co.

ing short ascenders, dwarfing the capitals, and enlarging small capitals. The characters are closely fitted; the serifs of contiguous stems often connect; the stems are thin, and the hair-lines are needlessly protracted. Although this style is preferred in France and Spanish America, it is not a favorite in the United States. Yet it is a remarkably readable letter, and were it not for the delicacy of its connecting serifs would be durable. The lower-case letters are large and clear even in their compressed form. To English and American eyes its great defect is the reduced height of the capital letters. Its grayness of color makes it a good letter for contrast in texts that have wood-cut illustrations.

No type-founder has changed the form and effect of roman letter more than Bodoni of Parma. His first specimen of 1771 shows that he New forms had carefully studied the best French of Bodoni types of that period, but it shows also the hand of an innovator. He made his new faces rounder and lighter, and of greater openness and delicacy. The round letters of the lower-case were unusually short for the body, with ascenders and descenders so long that the composed types had the appearance of leaded matter. Excessive care was given to the correct drawing of curves and ovals. Serifs were long and flat; hair-lines had unusual length and sharpness. He delighted in little graces which struck every reader by their novelty. These

mannerisms prevented other founders from faithfully copying his forms, but all of them have been influenced by his style. He set the fashion for light-faces and round forms, and for that imitation of copperplate effects which has so seriously damaged the appearance of the books of this century.

Firmin-Didot of Paris, equally able as printer and type-founder, undertook the difficult task of

FIRMIN-DIDOT, the second son of Ambroise, and brother to Pierre, was born in Paris, 14th April, 1764, and died 24th April, 1836. He was an expert type-founder, and a skilled printer. The neat types of several of his father's editions were cut by his hand. He did good work for the development of stereotyping and map-making. He was appointed printer to the King and to the French Institute, and was decorated with the medal of the Legion of Honor. His portrait is in the gallery of the Louvre, and his bust is in the hall of the National Printing Office, Paris.

Eighteenth-century French-face on body 12, solid.
Gustave Mayeur, Paris.

making a bolder type with the round form, sharp lines, and true curves of Bodoni. His first face was an obese letter of harsh contrasts, for it opposed thick stems to feeble hair-lines and fragile serifs. After being out of fashion for sixty years, this Didot style was revived by Mayeur, who has faithfully reproduced its general effect. Other reproductions of the different styles proposed by Didot are made by several founders of Paris.

JOSEPH ALEXANDER ADAMS, engraver on wood, was born at New Germantown, New Jersey, in 1803. He died about 1870. In his boyhood he was taught the trade of a printer in which he excelled; but he preferred and followed the business of engraving on wood. About 1840 he arranged with HARPER & BROTHERS for publication by that firm of an edition of the Bible, he to furnish the engravings and control the printing. On this work he developed the method of overlaying and making-ready woodcuts that now prevails in the United States. For this work he invented the process of electrotyping woodcuts. Four- and six-roller Adams presses were first made at his suggestion.

Engraver's hair-line on long-primer body, solid.
George Bruce's Son & Co.

The engraver's hair-line was often used in books about fifty years ago for quoted mottos in titles, for summaries of chapters, and for sub-headings in books and pamphlets intended to show a feminine elegance or refinement. Although a well-drawn

and carefully cut letter, it has been supplanted by other forms of light-face much inferior in merit.

Condensed forms of letter have always found most favor with publishers of small-margined and double-columned octavos, with the re-
 Decline of thin and con- printers of standard books in shabby
 densed faces forms, and with inexperienced news-
 paper proprietors who mistakenly attempt to crowd too much matter into a given space. Their judgment has been overruled. Intelligent book-buyers resent this parsimony in type and margin, and call for the round and open faces which are now regarded as the more suitable for books of merit. The illustrations on these facing pages

GEORGE CLYMER, inventor and manufacturer of the once celebrated Columbian printing press, was born in Bucks County, Pennsylvania, in the year 1754. Clymer at a very early age had earned good repute as a scientific and skilful mechanic. In 1817 he introduced his Columbian press in England, where it was highly commended. He died in London in 1834. ~~~~~

Round-face on pica body, leaded.
 George Bruce's Son & Co.

HORACE WELLS, the pioneer of type-founding in Cincinnati, was born at Hartford in 1797, and at the age of sixteen was apprenticed to a cabinet-maker. In 1820 he was selected to superintend the wood-working department of the foundry established in Cincinnati by Elihu White, and now known as the Cincinnati Type Foundry, the first types in which were cast July 4 of that year. In this foundry he gradually acquired a practical knowledge of the details of type-making, and also attained some distinction as a punch-cutter. He became the general manager, and ultimately the proprietor, of the foundry. He died in 1851.

Round-face on long-primer body, leaded.
Farmer, Little & Co.

are fair exhibits of a prevailing fancy for round-faces. When new, carefully printed and judiciously used, the round-faces produce a pleasing effect, but many of them are too frail for general use. Sharp and thin lines are not in so much favor as they were thirty years ago. The round-faces with sharp lines are effective only when printed in the form of leaded or double-leaded composition with broad white margins. When set solid and printed on ordinary paper with narrow margins they are displeasing.

The illustration on this page is of an extremely light face of decided merit, but which is too thin A skeleton round-face and too light to be used as a text-type for descriptive matter set solid. It shows to best advantage in leaded or double-leaded poetry, or in any work which has broad margins and large spaces of white. It finds frequent employment in the titles or descriptions of plates when these titles are printed, as is the fashion, on thin paper facing the plate, but in any place it is a strain on ordinary eyesight.

ELIHU WHITE, who established the type-foundry now known as that of Farmer, Little & Co., was born at Bolton, Connecticut, 27th July, 1773. His first business was that of a bookseller and publisher. In association with a Mr. Wing he undertook to make type, without any knowledge whatever of the theory or practice of the art. In 1810 he took his undeveloped type-making tools to New York, and soon after began a prosperous business. With William M. Johnson of Hempstead, he gave much time to the development of a type-casting machine. He established foundries in Buffalo and Cincinnati. He died in 1836.

Light-face on small-pica body, leaded.
Farmer, Little & Co.

RICHARD MARCH HOE was born in New York, 12th September, 1812, and died in Florence, Italy, 7th June, 1886. At the age of fifteen he began to work in his father's printing-press manufactory; at twenty-one he was the head of the business. He made many improvements in printing machinery. His first notable invention was the Type-revolving Rotary-printing machine, patented in 1847. His latest achievement was the Web-perfecting printing machine, which prints from an endless roll, cuts, folds, and delivers perfect papers at rates of speed, varying with the size of the sheet, from fifteen to sixty thousand copies an hour. ☆☆☆☆☆

Broad form of light-face on brevier body, double leaded.
Farmer, Little & Co.

The face on this page, which is as broad as it is light, is seldom used as a text-letter for standard books. Its delicacy disqualifies it for general use, but it is an effective letter in fine pamphlets, catalogues, and ornamental job-work, when the composed lines have been liberally widened with leads. The larger sizes are used for book titles, running head lines, and as a display letter.

The prevailing fashion of light-face in France is entirely distinct from any used in Great Britain or America. French type-founders of the present time lean to English forms, but that they have not freed themselves entirely from the mannerisms of the old French masters may be seen in the square, trim, and compact appearance of the specimen subjoined. Note that the y, s, a, and r seem to be entirely new forms.

AMBROISE FIRMIN-DIDOT, the son of Firmin, and a great-grandson of the founder of the house, was born at Paris, 20th December, 1790, and died 22d February, 1876. He was eminent as a printer and as the publisher of famous books; was a punch-cutter and type-founder, the president of several typographical societies, printer to the Institute, a diligent and intelligent collector of books, a member of the Municipal Council of Paris, repeatedly juror at Universal Expositions, officer of the Legion of Honor, author and translator of many books and pamphlets of authority, and beyond question the most learned and ablest typographer of France.

Modern French light-face on body 10, leaded.
Gustave Mayeur, Paris.

Publishers of newspapers have had unsatisfactory experience with every variety of condensed face. They testify, as do all book printers, that condensed types wear out too soon, and show their wear when but half worn in muddy presswork and indistinct figures and characters. Fair trial has thoroughly demonstrated that the saving of space made by the selection of a lean letter is not a sufficient offset to bad presswork and needless wear. Publishers now go to the other extreme, and require faces of unusual breadth, which American type-foundries furnish in great variety. The specimen here shown is a fair example of a recent style.

Why broad-faces were introduced

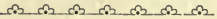
GEORGE P. GORDON, printer and inventor, was born in Salem, New Hampshire, 21st April, 1810, and died in Brooklyn, N. Y., 27th January, 1878. The needs of his business, as a master-printer of New York city, induced him to make improvements on the inefficient small printing machines then in general use. In August, 1851, he patented the first form of the machine now known as the Gordon Press, which ever since has been approved of in this country, and under other names in Europe. He was granted more than fifty patents for improvements in printing machinery. 

A broad-face on 10-point body, solid.

James Conner's Sons.

Many broad-faces have short descenders and long serifs to fill the gaps made by widely separated stems. In some of them the expansion of the letter is so great that there is no fair relief of white space between the lines. The impression required for all over-broad faces, with shortened ascenders and without due relief of white between lines, must be nearly as severe as that given to the old fat-faces. Book printers and publishers have always objected to over-broad faces as mechanically incorrect. The wide separation of stems required by this style makes more difficult the proper fitting of bodies.

JAMES HARPER, the founder of the printing and publishing firm now known as that of HARPER & BROTHERS, was born in Newtown, Long Island, N. Y., 13th April, 1795, and died in the city of New York, 27th March, 1869. For many years the business was managed by James and his three brothers: JOHN, who was born 22d January, 1797, and died 22d April, 1875; JOSEPH WESLEY, who was born 25th December, 1801, and died 14th February, 1870; FLETCHER, who was born 31st January, 1806, and died 29th May, 1877. James Harper was elected mayor of the city of New York in 1844. The business is now managed by their sons and grandsons.

Broad-face on 10-point body, solid.
MacKellar, Smiths & Jordan Co.

ISAAC ADAMS, inventor of the Adams power printing press, was born in Rochester, New Hampshire, in 1803, and died in Sandwich, New Hampshire, 19th July, 1883. His first press, with frame of wood, was made in 1828. It received many improvements in 1834, and was even then accepted as the best press for book printing. About 1836 he formed a partnership with his brother Seth (born in 1807, died in 1873) for the manufacture of the presses, which partnership ended in 1856. ❖ ❖ ❖

Expanded-face on brevier body, double leaded.

George Bruce's Son & Co.

Although very broad or expanded faces are unacceptable to publishers of books, they are really needed in any form of composition in which it seems necessary to fill the space as to width more than as to height. They give a clearness to print which is not to be had by the use of capitals or of any other form of letter, and they are entirely free from the appearance of bold or vulgar display. Job printers use them to good advantage in circulars, catalogues, and fine pamphlets.

Some publishers and many printers have tired of light-faces. Book critics have rightfully complained of a deficiency in blackness of ink in recent books. In much of this objectionable presswork the fault is due more to weak types than to weak ink. Under the conditions that control ordinary presswork it is not possible to show vivid blackness on thin lines that will not hold the needed ink. Surrounded by an excess of white the thin lines must seem comparatively gray. Printers have also objected to types with sharp hair-lines that are soon flawed or crushed. The desire of the proprietor of the Riverside Press for a bolder-faced type which would receive a proper amount of black, and yield a fair

Weak types
make weak
presswork

HENRY O. HOUGHTON, printer and publisher, was born in Sutton, Vermont, 30th April, 1823. He was taught printing in Burlington, but devoted his spare hours to study. In 1846 he graduated from the University of Vermont. After service as a reporter on a Boston newspaper he established, in 1852, the "Riverside Press" at Cambridge, Massachusetts, under the name of Henry O. Houghton & Co. In 1872 he was elected mayor of Cambridge. In 1878 he acquired the ownership of the business of the old publishing house of Ticknor & Fields. The business is now carried on under the name of Houghton, Mifflin & Co., Boston and New York.

Riverside-face on long-primer body, solid.
Phelps, Dalton & Co.

measure of wear, led to the cutting of this River-side-face. His request for a complete series was refused by one type-foundry for the rea- The River-side-face son that it could not be sold. Another founder cut a full series for book-work which has been used with best results. In this series the stems of the letters are not only thicker but longer, and the hair-line has a visible thickness.

These good features are shown more clearly in a new variety of firm-face of broad form, which is designed for hard usage on newspaper work. The hair-lines are unusually thick, the serifs are short, and will successfully resist the wear of the moulding-brush, the lye-brush, and the proof-planer. It will take ink readily, and make a readable print without undue impression.

THOMAS MACKELLAR was born in the city of New York, 12th August, 1812, and was taught the trade of a printer in the printing house of J. & J. Harper. In 1833 he was proof-reader in the type and stereotype foundry of Johnson & Smith of Philadelphia. When Johnson retired, he became the senior partner in the new firm of MacKellar, Smiths & Jordan. He is the author of the "American Printer," and for many years was the editor of the "Typographic Advertiser," and the witty and wise "Specimen Book" of the MacKellar, Smiths & Jordan Co. Selections from his contributions to journals were published in Philadelphia, 1873, under the title of "Rhymes Atween Times."

Firm-face of broad form on 8-point body, solid.
MacKellar, Smiths & Jordan Co.

Students and book and newspaper printers are fully agreed as to the worthlessness of the sharp hair-line. Punch-cutters and job printers who try to compete with lithographers and copperplate-engravers seem to be the only typographers who care to perpetuate this feminine feature which has so seriously degraded modern printing. To make a readable type the sharp contrast between thin and thick lines should be avoided; the hair-line should have a visible thickness even in small sizes, for this increased thickness is really needed as much to give legibility as to prevent wear. The continued popularity of the old-style is due more to the clearness produced by its strong lines and serifs than to its quaintness of form.

The defects of the ordinary faces of roman type are most noticeable in the smaller sizes. Texts in pearl or diamond are hard to print. Light lines cause weak presswork. Too much ink makes the letters thick and muddy; too little ink makes them gray and indistinct. Even when inked with discretion, the effect of presswork from small types is that of feebleness. Small types show little of the stem and still less of the serif and hair-line; they have not surface enough to carry a good body of ink. To remedy this fault, Quantin of Paris had made for his miniature editions¹ a remodeled light-face antique, in which all the lines were nearly of uniform thickness.

¹ "Horace: odes et épodes," 24mo, illuminated. Paris, 1883.

The introduction of the Riverside-face of the late Henry O. Houghton, the Cushing style, the "Golden type" of William Morris, the Jenson face of Phinney, and the Century face of the De Vinne Press, are the practical protests of experienced printers against the growing effeminacy of modern types. Readers of failing eyesight rightfully ask for types that are plain and unequivocal, that reveal the entire character at a glance, and are not discerned with difficulty by body-marks joined to hair-lines and serifs that are but half seen or not seen at all. The Morris and Jenson styles may be needlessly bold for readers of excellent eyesight, but they are attempts at an improvement in the right direction, which will be maintained.

The Motteroz-face on the next page is another attempt at a letter that may be read more easily. It has too many French peculiarities to commend it to readers who have been used to English models, but every reader must admit the propriety of some of its innovations. It is not too bold or black, and is notably round and clear. Characters like s, a, r, g, which always have been pinched, in deference to type-founding traditions, are here made of full breadth, and are recognized with ease. The high strong arch of the m and n, and other features of the old-style, have been retained. Here its designer's reforms have stopped. He has not thickened the hair-line, which is as sharp as before, nor has he angled or bracketed the serif.

Although the type-founders and printers of France object to its departures from the accepted standards of form, it has been chosen by the Municipal Council of Paris as the most readable letter for its school-books and official publications. It is made for and used by Motteroz only, and is not for sale.

CLAUDE MOTTEROZ was born in 1830, at Romanèche (Saône-et-Loire). As the descendant of an old family of printers he was taught printing, to which he added the practice of other crafts. In 1874 he established in Paris a large atelier for photographic reproductions by lithography, about which he has written two treatises deemed of high authority. In 1876 he devised this form of roman letter. He is the printer and publisher of many school-books which have been adopted by the Municipal Council of Paris. As proprietor of large printing-houses, and as a contributor to "l'Imprimerie" for many years, he has exercised a marked influence upon the development of French typography. ☆~☆~☆~

The Motteroz-face, on corps 11 (a large small-pica), solid.
By permission of M. Motteroz.

The accompanying illustration is intended to show the different methods pursued by Didot and by Motteroz. In the Didot style note the greater length and sharpness of the hair-line, the shortness of the serif, the stiff uprightness of the stems, especially in the interior of the O. In the Motteroz style note the strength of the arch in n and u, the comparative shortness of hair-line and the greater decision given to the O. M. Motteroz claims that this face on body 5 is more readable than the ordinary faces on body 6.

u n o

As made by Didot.

u n o

As made by Motteroz.

Tous ces grotesques mots, Gaillarde, Trimégiste,
Gros-texte, Gros-canon, fastidieuse liste
De vains noms qu'ont portés tant de types divers,
Et dont le seul récit attristerait mes vers,
Noms qui de leur grosseur et de leur différence
N'ont pu donner encore aucune connaissance,
Il sut les transformer en d'autres plus heureux
Qui marquent clairement tant de rapports entre eux.
Son nouveau typomètre offre une règle sûre:
Chaque type s'accroît par égale mesure,
Et la gradation qu'avec art il suivit
Est aussi juste à l'œil qu'elle est claire à l'esprit.

PIERRE DIDOT. "Épître sur les progrès de l'imprimerie."

Motteroz-face on body 5, leaded.
By permission of M. Motteroz.

The specimens of roman face here shown are necessarily incomplete, for it is not practicable in this work to illustrate all the styles made here and abroad. Every large type-foundry makes at least three, and sometimes twelve distinct faces of roman letter on the bodies most in use. Although distinct, the variations in many of these faces are too slight to be perceived by the inexpert. The illustrations previously presented are sufficient to show the styles that have most character. They show also the drift of popular taste, and the lines on which efforts at improvement are being made.

New styles are not always the outcome of caprice; often they are made to avoid difficulties.

New styles designed to conform to new methods

When book printing had to be done on cylinders the long ascenders of Bodoni were abandoned, for they could not properly resist the force applied.

When stereotyping had to be done by the papier-maché process, which requires the beating of types with a stiff brush, the long and sharp serif was supplanted by one that was short or stubby. The straightened beaks and fewer kerns of modern-faces are so made to insure their proper moulding in wax or plaster. The thicker hair-line, the bracketed serif, the more open form and deeper counter of some modern styles are necessary for a greater durability and legibility.

It is remarkable that the general form of the roman letter has changed so little. There is con-

tinual demand for novelty in letters which type-founders find difficult to meet. Some of the proposed novelties vary but little from the regular models; some have the authority of Bodoni or of Didot; some are clever imitations of the styles of medieval calligraphers of eminent ability, but every attempt at ornamenting roman letter is invariably rejected by authors and experienced printers. For any serious innovation high authority is disregarded; a marked variation of form is enough to forbid its use in books. However meritorious the new form may be, it can be used only by job printers.

All important changes are objectionable

The twenty-six letters of the roman alphabet imperfectly represent the vocal sounds of any language, but every attempt to increase the number of characters has failed. Authors of dictionaries, who best understand the difficulties of the subject, are content when they add accents or diacritical marks to the letters. It is not probable that new characters will be introduced. Phontype utilizes all the old letters and adds several new characters, but there are no indications that its new alphabet will supersede the old.

Some of the characters now provided may be abandoned. The beak given to the *f* compels the making of five distinct characters, *fi*, *fl*, *ff*, *ffi*, *ffl*, to avoid kerns. Some founders are now cutting the *f* without a kern, and this improvement should make all the doublets unnecessary.

Small capitals are often unsatisfactory. According to the rules laid down for emphasis or display, a word in small capitals should be more prominent than one in italic; but small capitals are usually made thin and weak, so that really they are of inferior prominence. Some publishers prohibit all small capitals in the text, preferring to make any distinction they need by using the lighter faces of antique or clarendon. This weakness comes from cutting small capitals of the same height as the round letters of a small lower-case. In this restricted space it is not possible to cut small capitals of becoming prominence without widening the letters to a degree which makes them bad mates for the large capitals. The only remedy is to make them higher. As usually made, small capitals are difficult to cut, as well as ineffective in print. This difficulty tempts founders to make one set of small capitals serve for two or more distinct faces. An inexperienced can seldom detect the mismating. Properly made, after the fashion of the small capitals now provided for some faces of ornamental letter, a higher small capital of roman would be much more freely used in book-work. The difference between the small-capital and the lower-case O, S, W is slight, and to be detected only when the two forms are put in contrast. To prevent a mixing of the two sorts, a special nick ploughed in the body of the small capital would be an important improvement.

Arabic figures have been changed more than any other characters of the font. Some of the forms made by the early printers cannot be deciphered by an unschooled reader. Their oriental irregularities were gradually reduced to a reasonable degree of uniformity, so that the old-style figures made by all founders of the eighteenth century differed but little as to form, and were never misleading or uncertain. Each figure had a distinct form and definite position: the **I**, **2**, and **O** were the short characters, occupying the middle of the line; the **6** and **8** were ascending, and the **3**, **4**, **5**, **7**, and **9** descending characters. In a text of lower-case, or in a large table of figures, one figure could rarely be mistaken for another, even when the figures were worn and bruised. That irregularity of form which makes figures distinct in a text of lower-case is a positive defect when they are put in a mass of even-lined roman capitals. In this position the old-style 1, 2, and 0 are too small: they look like wrong fonts. Perception of this defect prompted the designers of modern-cut letter to make all figures of the same height, and put them in line. This innovation has been accepted as an improvement which will probably endure.

To facilitate the composition of tables, figures have been cast on the n-set, which is wide enough for all the regular characters in texts of lower-case, in brevier and larger bodies. For the frac-

Fashions
in arabic
figures

tions, which are proper adjuncts of the regular figures, this n-set is too narrow. When hurriedly printed as newspapers must be, on weak paper with weak ink, the fractions, and sometimes the figures, of an important table are often choked with ink and made indistinct. Founders were gradually induced to make the fractions of small bodies on the m-set. This was but a partial improvement, for the figures were still too narrow. The difficulty was not overcome until the figures were put on the wider set of two thick spaces or two-thirds of an em. Some founders make them on the body of three-fifths or two-fifths of an em. These broad figures are used chiefly by newspapers, and to some extent by book printers when figures are required in lines of capitals. A broad figure is needed for capitals as much as a narrow figure for lower-case.

Many attempts have been made to improve the form of modern figures. The forms of Didot here shown, 1 2 3 4 5 6 7 8 9 0, are probably the most striking innovation, but they have not been accepted. A far more disagreeable form has been made popular in France, Belgium, and Holland. Here is a figure 3 and a figure 5. The figure 3 has an oblique hair-line; the figure 5 has a straight hair-line. There is no other line of difference. When these hair-lines are attached to fat-face figures, the hair-lines

35

are practically invisible at a short distance, and a confounding¹ of the 3 with the 5 is unavoidable.

The signs of £ for pounds and of \$ for dollars are usually made on an irregular set, which compels unnecessary work in the justification of narrow columns of figures. This needless labor could be avoided by putting them upon the n-set or the set of three-fourths of an em.

The characters required to indicate a quotation (reversed commas at the beginning, and apostrophes at the close) are clumsy. When the commas are on the four-to-em set, and the apostrophes on the five-to-em set, this inequality makes them bad mates. Used singly they are too weak; used in pairs they produce offensive gaps of white space. The French method of using a distinct reversible sign for quotations, which is put in the middle of the face, is preferable in every way.²

Italic points of punctuation are objected to by those who maintain that letters only should be in italic, and that points should not be inclined. To use upright roman points only makes unsightly work. There is a real need for inclined points, although they are too often used unwisely.

¹ These figures are often used to specify paintings in foreign picture-galleries, to the annoyance of visitors, who frequently are led by them to seek a wrong reference in the printed cata-

logue. There is no excuse for these figures. Printers should join with founders in expelling them from typography.

² See these signs of quotation in the French type on page 203.

As usually made, some of the minor signs of the font could be improved: the * is too weak, and so are the †, ‡, §. These signs have Weakness of the minor characters partially been supplanted by superior figures and letters, but they would be more freely used if they were stronger. The (and [provided for bold-faced types are usually feeble. On the contrary, the braces, dashes, and leaders are sometimes too thick and bold, much inferior to the neater forms of the French founders. Superior figures or letters are often too light and of too small size. The diphthongs æ and œ are not needed for words purely English, but their occurrence in Latin compels founders to provide them for the five series of a complete font. These diphthongs, *Æ*, *Œ*, *æ*, *œ*, *æ*, *œ*, *Æ*, *Œ*, *æ*, *œ*, find so little employment that usually they are as good as new when the rest of the font is worn out. The long f, with its doublets, and other abbreviations or logotypes of the early printers, have been abandoned, but the diphthongs seem to be firmly embedded in the modern alphabet.

A series of book-faces should embrace sizes from pica to pearl inclusive; a series of newspaper-faces, A full series of book- and news-faces all sizes from bourgeois to agate inclusive. Not all the faces here shown as specimens are made in complete series for book-work, but those that are most used have bodies enough for an ordinary book-text. It is possible now to set text, preface, extracts,

M notes, and index in different sizes of the same
M face. Sixty years ago a complete series of
M any face of modern-cut (the fat-face excepted)
M was rare. The printer of that period was
M often compelled to use two or more unlike
M faces on the same page; sometimes four or
M more in the same volume, always with dis-
M agreeable effect.¹

M Type-founders of the present time usu-
M ally stop a new series of book sizes with
M the body of pica, alleging that Rarity of
romans of
large size
M there is very little demand for
M the larger sizes. This is true,
M but the deficient demand is largely due
M to the unsatisfactory supply. One can
M buy in series (but not so complete as is
M needed) the Caslon or Elzevir old-styles,
M but these quaint forms can be used with
M propriety in but a limited amount of
M printing. There are one or two series
M of light-faces not so complete which
M are adapted for ornamental typog-
M raphy only, as their long serifs and
M faint hair-lines unfit them for every-
M day practical work. Beyond these

M ¹“The book-printing of the present day is
disgraced by a mixture of fat, lean, and het-
erogeneous types, which to the eye of taste
is truly disgusting; and it may perhaps be
said with truth that a much greater improve-
ment has taken place in the printing of hand-
bills than of books.” Hansard, p. 355.

Elzevir.

M is practically nothing, for the stiff forms of
M Dr. Fry and his imitators, which still keep a
M place in too many specimen books, are prac-
M tically obsolete. This scant supply of large
M sizes seems surprising when one notes the
M profusion of blacks, scripts, and ornamentals
M on large bodies in the specimen books of all
M established type-foundries. The excess of
M display letter shows that job printers buy
M more than book printers, and that their
M wants are more cared for.

M The inadequate provision of large sizes
M of roman capitals is most noticeable in
M the composition of book titles, for which
M capitals only are needed. Book titles, al-
M ways difficult to compose in good form,
M call for many sizes and for a closely
M graded series of uniform face. This
M close grading with strict uniformity is
M rare in a series of modern-cut two-
M line letters. As a rule the two-line
M types provided for books are capri-
M ciously selected by founder and by
M printer, with insufficient attention
M to their possible disagreement of
M face. Some are a trifle fat, others
M a trifle lean; some have thick and
M others thin stems; some have flat
M and long and others short and
M bracketed serifs. That series is

Caslon.

M rated as complete which embraces all the regular bodies from two-line diamond to two-line great-primer, but every compositor of titles soon finds that these are not enough. He needs intermediate sizes that are not made by any type-founder; he needs capitals that are smaller, and two-lines that are larger than any in the series. As substitutes for the deficient faces he has to resort to the capitals and small capitals of ordinary text-types, to two-lines of other series, to condensed faces, to italic capitals, and black-letter. A title composed of incongruous faces is always displeasing. The author is usually quick to notice discord, but he has not the technical knowledge needed to enable him to detect its true cause. He imputes the discord, not always rightfully, to the bad taste of the compositor, when oftener it should be imputed to the scant supply of sizes and the incongruity of faces. Some publishers have been so annoyed by the wide gaps between existing sizes of two-line letters, and the incongruity of any substituted face, that they have ordered special lines, and sometimes the entire title, to be engraved, too frequently, it must be admitted, without improvement.

A modern-cut.

Others have ordered a title for a text in modern-cut to be set either in Elzevir or Caslon old-style, which appear to be the only available styles that have a passably complete grading of sizes. The impropriety of a title in old-style before a text in modern-cut is foreseen and deplored, but it seems a fault not so offensive as the mixing of unrelated two-lines on the same page.¹

For book titles, and also for the initial letters of chapters, two-line capital letters are needed, which should be graded in height and in width so as to show a slight but regular increase in advancing sizes, and this increase should be graded as nicely in width as in height. The preceding illustrations show the range of any ordinary series. Their grading as to height—two points between smaller and four or more points between larger sizes—seems close enough; but their grading as to width is far more irregular, as will be seen by comparing the measurements (in points) of the different sizes in that direction. For many displayed lines

¹ The unconventional book titles of Pickering and Houghton are sometimes a surprise to printers, who have frequently hazarded the assertion that these departures from the established usage are servile imitations of sixteenth-century fashions. Imitation was not the motive: it was the inability to find types suitable in face and body that led to the adoption of the ruder old practice. Many recent books from European presses have the larger lines of display in their titles set in light-faced antique, celtic, or runic. These faces are not preferred by any publisher; they are accepted only because roman capitals of a proper size and firmness of hair-line could not be procured.

in titles the smaller of two proximate sizes is too little and the larger is too big. To space out a

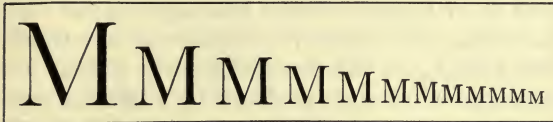

Modernized old-style capitals and two-lines.

short line entirely changes the appearance of the character, and breaks the intended harmony of composition ; to select the size that is needed from another series is a disagreeable alternative, for the type so selected must be of an incongruous face. The illustrations here given in five distinct series of capitals and two-line letters, from four foundries, show plainly the uneven grading of the sizes.

The two-line letters that are now provided are very frequently false to name. They line only with a few sizes of solid type, and seldom line

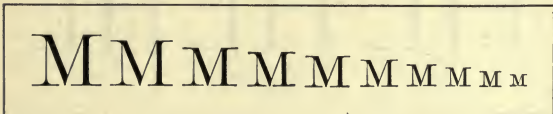

A series of two-lines and capitals of light-face.

at all with leaded type. A strict two-line should line not only with the top of the upper line but with the bottom of the lower line.¹ There is a

¹ See page 59.

real need for two-lines on the bodies of 26-, 30-, 34-, 38-, 42-, and 46-point; and the faces cut for these bodies should be true intermediates, in width as well as in height, of their proximate faces. The new sizes are required to complete the deficiencies now existing in the series of Elzevir, Caslon, and modernized old-style provided by American type-founders. For the still more incomplete series of light-face, Scotch-face, and bold-face, many more sizes and bodies are desirable.

Nor should this improvement stop with added faces and bodies of two-line letters of the standard width. A full series of lean-faces and of fat-faces, to line and mate with the standard-faces, should be provided for each body. The lean-faces should not be noticeably condensed, nor the fat-faces offensively expanded. The variation should be slight, so that



the types of a lean- and a standard-face, or of a fat- and a standard-face, may be used together in the same line if occasion require. Assuming that the standard width of the twenty-six capital

letters is twenty ems of its own body, the full series of lean letters should measure about eighteen ems, and the full series of fat letters should measure about twenty-two ems of the same body. Each series of fat, lean, and standard form should be cut of the same height, thickness of stem, and length of serif. The peculiarity of the style, and the exact lining of all the characters, should be maintained in each series.

With types made after this system the characters of each proximate series could often be used interchangeably. Set in types of standard width, a line that is too long for the measure could be cut down to proper length with types of the lean form. This could be done without any loss of perspicuity, and without provoking any suspicion as to the possible change of face. Provided with a complete series of two-line letters of uniform face, and of three distinct widths, the compositor of book titles would find his task as easy as it is now difficult. The improved appearance of a title-page that has been composed in types of uniform face, that has not been disfigured with spacing, and that gives proper prominence to each line, needs no explanation. The cost of a complete series of two-line letters made after this plan would be great, but the benefit to be had therefrom would be equally great; for the time that is now lost, without any compensating benefit, in futile attempts to compose book titles

with insufficient sizes and faces of type would soon pay for the cutting of many series.

Romans of large size and two-line capitals will be bought more freely when they are made much stronger. Types with protracted hair-lines and long, weak serifs, like those of the fashion now prevailing, are no more adapted for the general work of a printing house than kid gloves are for manual labor. A prudent printer, who foresees the risks of injury that types of this cut have to meet, regards them as a luxury, for they are quite as frail as script, and can be judiciously used only for printing that is intended to be light, delicate, and feminine. No one dares use them for posters or for ordinary job printing.



A six-line roman of light-face.

They find but a limited employment in book titles and newspaper headings: even in this small field of service they are often rejected as unsuitable. The six-line roman here shown, which is of a full series of both roman and a mated italic on many

bodies from agate to ten-line pica, has a remarkable beauty of form, but is relatively weak. It will be found entirely unsuitable if used in a book title for a display line in red ink. Bold as it may seem, there is not surface enough on the larger sizes to show a good color, and it is too feeble to resist ordinary wear. If it be compared with the Elzevir or the Caslon capitals shown on pages 241-2, the reader cannot fail to note the superior fitness for general service of the older forms.

If an approved face of modern-cut capital were made with the thick hair-line and strong serif of these sturdy old-styles, and if this new Why the old-style were cut as has been recommended style is liked for every body in the three distinct series of a lean, a standard, and a fat shape, the preference now given to the old-style character would be largely diminished. The new capitals would have all the strength and readability of the old-style, with a precision of form and a mechanical grace of finish not to be found in any of the earlier models.

The specimens of firmer faces shown on previous pages are indications that the admiration for hair-lines and for emasculated printing is nearing its end. To these specimens may be added another style recently introduced by the American Type Founders Company, which is illustrated on the following page. The stem and hair-line are practically of the same thickness, yet the face is light and inviting. It promises to be a readable letter.

DR. JAVAL'S NOTIONS ABOUT SERIFS. These attachments to the stems were not put on purely as ornament, nor kept there only in obedience to tradition. They can be seen in English manuscripts of the seventh century; they were used by Italian calligraphers; they were adopted by the earliest printers of ROME and of PARIS; they continue to be used to this day for the purpose of increasing the readability of the characters.

10-point Cushing or Monotone.

Some early forms of roman letter have never been reproduced. One style, probably drawn by Robert Granjon, used by the printers of Lyons, and occasionally by Froben of Basle, is really as light as that of the thinnest of modern light-faces, yet it has no sharp hair-line, not even in the smallest capitals.

COPLLEY

Double great-primer Copley.

The Boston Type Foundry makes a few large sizes of roman capitals of quaint form, in imitation of a peculiar style devised by the old sign-painters of that city. This Copley face is provided with small capitals, and is not an unpleasing

variation of the standard form. Although useful for display lines in job-work, modern taste condemns it as too bold for book titles or for initials.

ABCDEFGHIJKL

A bold-face in fashion from 1810 to 1825.

ABCDEFGHIJKLMN

A medium-face with the flat serifs in fashion from 1820 to 1840.

ABCDEFGHIJKLMNO

A light-face with flat serifs, of a later period.

ABCDEFGHIJKLMNO

A medium-face of the present style.

ABCDEFGHIJKLMN

"Half title" of modern cut with bracketed serifs.

ABCDEFGHIJKL

A light-face of modern cut.

Six series of two-line letters on 16-point body.

The illustrations of two-line faces on this page are fair specimens of styles that have successively prevailed in this century. Since the fat-faces went out of fashion the tendency has been toward lightness or delicacy as to face, and frequently to nar-

rowness as to shape. For some styles of text-type not one of these faces is really suitable: the bold-face may be too bold, and the light-face too light, to serve either as an initial or as a letter for the title. There are not sizes enough of any style, but the letters of different styles cannot be used together even in different lines upon the same page.

The conservatism of type-founders is fairly illustrated by these exhibits. In every series, whether Universality of lean or standard shape, of light- or of hair-line bold-face, the sharp hair-line is always maintained. The stem may be twice as thick or



Bold-faced two-line types with weak serifs.

twice as thin as those of old models, but the hair-line is always the same. From the reader's and printer's point of view this mannerism is unfortunate. Putting aside the wear that these types must receive on press, a prudent printer has to ask the question, "How many times can letters like these

be handled by the compositor without injury?" Even upon bodies no smaller than great-primer, these sharp-lined romans are too weak to be distributed pell-mell in the case. The type that falls but six inches and strikes a serif must receive a damaging bruise.

The smaller sizes of light-faced romans are not so liable to injury from handling, but they are objectionable because they are indistinct. Limitations of hair-line Sharp lines and dazzling serifs make all the light-faces hard to read. They have a rightful place in ornamental typography, for they are exceedingly beautiful if judged by a feminine standard of beauty, but they are entirely out of place in serious books, or in any text of importance, in which an indistinct letter or word demands of the reader a straining of the eyes.

The designers of the extreme light-faces seem to have forgotten that the old methods of presswork have been abandoned. Books as made Sharp lines not adapted for wear now are rarely printed on damp paper, or against an elastic impression surface which necessarily thickens the sharp lines: Modern printing needs hair-lines that are thicker and not thinner.¹ Unfortunately the needs of the reader are lightly regarded by the men who make types.

¹ Blades, in a review of the types of the Enschedé Foundry, says that its renowned punch-cutter Fleischmann probably would not recognize his own types were he to see them carefully and delicately printed by modern methods of presswork on sized and calendered paper. "Book-worm" of April, 1870.

- They think more of the display of their own skill. The punch-cutter's straining after a hair-line that stops just before invisibility is ably seconded by the pressman who scantily inks these light-faces with a hard ink-roller, and then with the feeblest possible impression impresses them against an inelastic surface on dry and hard calendered paper. This weak and misty style of printing is vastly admired by many printers, and perhaps by a few publishers, but it is as heartily disliked by all who believe that types should be made for the needs of the reader more than for an exhibition of the skill of the printer or type-founder.

The rights of readers deserve more consideration. The rules that editors and men of business apply to writing should be applied to book-types. The hand-writing that Distinctness is always of first importance cannot easily be read, even if its individual letters have been most daintily and scientifically formed by a master of penmanship, with the sharpest of hair-lines and the greatest profusion of flourishes, is quite as intolerable as that which is slovenly and illegible. No printer desires it for his copy; no merchant tolerates it in his account books; no one wants it in his correspondence. If one seeks a cause for the mercantile and editorial dislike of a so-called "pretty" handwriting, he is sure to find it partially in its needless flourishes and largely in its delicate and unseen "razor-edged" lines.



VII

Condensed Roman Types

T
 HE inflexibility of the types made for titles of books has always been an annoyance to compositors. There are occasions when it seems necessary to put a certain number of letters or words in one line. If there are too many letters in this display line the types will be small and weak; if there are too few letters the types will be too big and too bold. The typographical practice which prevailed before the year 1840 permitted types marked for a prominent line of display to be widely spaced between letters when there were not letters enough in the words to fill the measure. The en and the em quadrat were frequently used as spaces. It was not permitted to set the words for large display in two connected lines of the same size and style of type, either with or without a hyphen.

Need for a condensed character

The words for large display must always be in one line, whether they were few or many. In the early days of printing the division of a prominent line was a common practice, but for a full century at least the division of displayed words in titles has been regarded as a mangling of language and as unworkmanlike in the highest degree.

To avoid what was regarded as the uncouth division of the display lines of titles, or the alternative of a selection of capitals too small for proper display, printers had to resort to condensed capitals, which seem to have first been shown in France about the year 1820. As two-line letters for titles, or as initials, or as headings of chapters, they had a remarkable success. Their slender, symmetrical shapes were an agreeable contrast to the stumpy

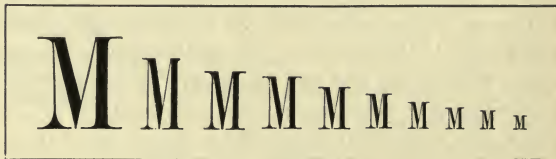

Condensed two-line letters.

forms of the rudely cut two-line fat-faces then in fashion. Every publisher wanted condensed letters in his titles, and they were furnished on many bodies from one-line nonpareil to ten-line pica. Some were but moderately condensed, in

which shape they were not more objectionable than the lean-faced capitals of a thin font; but the shape most popular was that of a character almost one half the width of the standard two-line letter. The legibility and the effectiveness of each letter were diminished with every new degree of narrowness, but this did not prevent the making, and use, of still thinner characters, which were labeled as extra condensed and double extra condensed. In due time came lower-case letters for most of the new capitals, all of which were readily accepted and used by job printers. In English and American book houses the condensed shape never found favor; for a noticeably condensed lower-case has never yet been accepted as a proper text letter for the standard book.

The use of the condensed capitals for book titles was carried to great excess, and a reaction followed. After a sufficient experience it was proved that the appearance of titles was really injured by a decidedly condensed letter. The thin type enabled the printer to get displayed words of many letters in one line, but the letters were necessarily weak, and in violent contrast to the letters of other lines which had to be set in capitals of a standard form. Pinched letters and indistinct lines always seem out of place in the ample white space of the ordinary book title. The only form of condensed two-line letter now approved by critical printers is one which barely

Objected to
as frail and
indistinct

deserves the title of condensed, for it is but little thinner than the capitals of the ordinary lean letter still used for book-texts. Many publishers have gone back to the old form, and refuse to



A recent form of condensed two-line letters.

use any variety of condensed two-line letter for book titles. One reason for this objection is the mechanical feebleness of all the condensed letters. Many of them are copied from French models of great delicacy, in which the hair-line of the six-line pica is almost as sharp as that of the two-line diamond. The specimen that follows is a fair example of a French fashion of two-line letter. Note the slenderness of the hair-line, the exten-

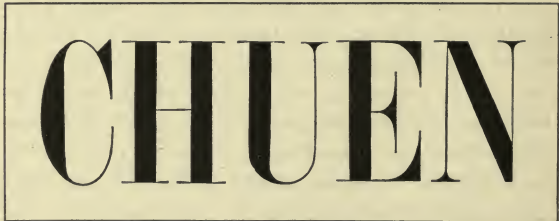

A French form of two-line letter.

sion and flatness of the serif. To every reader of imperfect eyesight these hair-lines are practically invisible; a letter is guessed at by its stems.

There are limits to the narrowing of letters that cannot be safely exceeded. For the bodies of pica, small-pica, long-primer, and bourgeois, the punch-cutter can make a lower-case alphabet readable within the compass of twelve ems of its own body, but he cannot make a satisfactory text-letter under this rule for any smaller body. Even when he proposes to make a symmetrical series of sizes, he cannot reduce size by strict geometrical rule. The alphabet of bourgeois may be kept within twelve ems, but that of agate should have fifteen ems, and that of diamond seventeen ems.¹ The insistence of newspaper publishers, who desired to crowd much reading in a very small space, has frequently induced type-founders to cut types below the standard, but never satisfactorily. Of the larger sizes of brevier and bourgeois the condensed types were not as clear and readable; of the smaller sizes of nonpareil and agate the figures, fractions, and all the characters containing close lines, soon became indistinct and of uncertain meaning after a moderate amount of wear. The slight advantages obtained in one direction were lost in another. A font of lean or

¹ See remarks and illustrations standards of type on pages 114-116 of this volume.

moderately condensed type wore out much sooner than a font of standard-face. When it was demonstrated that lean types of small body were deficient in durability and readability they went out of fashion. A strong reaction to the other extreme soon followed. The smaller types of many of our newspapers are now as much too broad as they were too narrow.

In a recent essay, a French optician¹ lays down the proposition that the diminution of readability in the smaller sizes of roman lower-case is chiefly due to their diminution in height. He says that a small type should not be condensed, for it is too short; but a large type may be moderately condensed without loss of readability, as it is high. As the print is rarely placed in a strictly vertical line for the purpose of reading, but is usually held in the hand or put on the desk at an angle of about forty degrees, it follows that the perception and identification of small letters are somewhat hindered by their shortness. They will not bear the foreshortening made by the inclination of the print.

The condensed faces shown on pages 205 and 215 of this work are about the thinnest that have been used for books in France, but they have not been approved by English or American publishers. Yet there are evidences that the prejudice against

¹M. Javal, "La typographie, illustrated with types in "Revue et l'hygiène de la vue," fully illustrated in "Revue Scientifique," No. 26, June, 1881.

condensed forms of the larger sizes is relaxing. There is need for a thin text-letter in poetry and in the page of two columns. To use a round- or a broad-face in poetry where the comparative narrowness of the measure compels a turn-over of the last syllable or word, or in a double-columned page where the narrowness of the measure compels the compositor to wide-space and thin-space in adjacent lines, is always a serious disfigurement, and an offense to the reader. To select a smaller size of type and to lead or double-lead the composition is an equally objectionable alternative, for this procedure diminishes the readability of the type, increases the cost of composition, and produces the effect of padding by its needless extension of the matter. To make a larger page on a larger leaf increases expense in another direction without benefit to author, publisher, or reader. The only proper treatment of composition in a narrow or contracted space is to select a roman type that has been made for and is adapted to the narrow column or page. For all bodies below 10-point a narrowing that makes their lower-case alphabets thinner than that of the prevailing standards is not to be recommended. Experience has proved its inutility. For bodies between 10-point and 20-point, condensed styles with alphabets of about eleven ems could be used to good advantage in the best book-work. Types larger than 12-point,

Where thin
types are of
service

that are now rejected by publishers as too coarse and sprawling, would be readily accepted if they were made of good cut, in the moderately condensed shape of the style on page 215. A large size of this form, set solid, would be more inviting to the eye and more readable than a smaller size widened by leads. Unfortunately, a full series of moderately condensed face is not made by any American founder on a body larger than 14-point. The face shown on page 214 has to be submitted as the nearest approximation.

**INTRODUCTION TO LOGOGRAPHY, or
the Art of Arranging and Composing for
Printing with Words Intire, their Radices
and Terminations, instead of Single Let-
ters. Henry Johnson, London, 1783.**

An early form of condensed pica, leaded.
George Bruce's Son & Co.

Job printers have always appreciated the serviceability of condensed types. For the display lines of cards, handbills, and advertisements condensed shapes of every style are as freely used now as they were fifty years ago, and there is no reason to believe that they will ever go out of fashion. The condensed face shown on this page,

which was introduced when fat-faced types were in the height of fashion, had all the defects of the text-types of that period—the thick stem and the shallow counter, the flat serif and the over-sharp hair-line.

This style was not made in any size smaller than brevier. It wore out with little use. Its defects were seen and avoided in the cutting of a more popular face of condensed which soon followed.

DR. WILLIAM CHURCH OF AMERICA
received a British Patent, March, 1828,
for "Improved Apparatus for Print-
ing," which was intended to cast and
compose types at an unusual speed.

A later form of condensed pica, leaded.
George Bruce's Son & Co.

In this face the stems are relatively lighter, and the counters are deeper, but the serif and hair-line are as delicate as those of the earlier face. Some fonts of condensed have capitals that are not proper mates for the lower-case alphabet—each series obviously the work of a different punch-cutter. This incongruity properly excludes them from book-work, but even if they were unexceptionably cut, all the early faces on pica and the

smaller bodies are too condensed for a readable text. The merit of roman condensed is best shown by a specimen of the style on a larger body.

A. DELCAMBRE
Composing Machine
March 13, 1840

A modern cut of condensed on double english body.
George Bruce's Son & Co.

This beautiful letter, which is provided by some founders in a full series from pica to six-line pica, would be more largely used if it had been made with stronger lines.

Although the faces previously shown are too condensed for any text of good book-work, they are not condensed enough to meet all the requirements of job printers. For their use a series of extra condensed, ranging from brevier to four-line pica, has been provided.

In the headings or columns of table-work, or in any other place where a large type seems to be required in contracted space, this style is of value, but it is seriously abused when it is inconsider-

ately selected because it enables the compositor to crowd in one line the words or letters that should have been put in two lines with better effect. As the lower-case alphabet of this illustration comes

WILLIAM HASLETT MITCHEL, of Brooklyn, N. Y., received patents in 1853 from the United States and Great Britain for the first practical and efficient type-composing machine. It was kept in use for many years in the office of John F. Trow, of New York, but failed for want of a proper distributor.

Pica extra condensed.
George Bruce's Son & Co.

within eight ems of its own body, it approaches obscureness too closely. It can be used properly in very narrow measures, or in places where no other face of type will serve; yet it is not uncommon to see this face in the titles of French books in which there is abundance of white space.

VICTOR BEAUMONT '53

This style of extra condensed, but in the series of capitals only, is occasionally to be found upon

the covers, and sometimes upon the inner titles, of recent books by Parisian printers. Made in full series from pica to six-line pica, this remarkably pinched style had a brief popularity in this country, but it is now entirely out of use, and deservedly so, for it proved a frail and most unsatisfactory type. The job printer of the present time prefers for condensed letters the newer styles of the antique or gothic class, which are more distinct and more durable.

The old-style character has been pressed, but not without difficulty, into service as a condensed type. The face on this page, without lower-case, was obviously made for a two-line letter. It conforms as closely as its condensed shape will allow to the general outline of the old-style form, but the spirit and the effect of the true old-style model are entirely wanting. The masculine strength and easy legibility of the model have been destroyed; we have instead the feminine curves and the deli-

TIMOTHY ALDEN'S
MACHINE OF 1846

Two-line small-pica condensed old-style.
George Bruce's Son & Co.

cacy of line affected by a teacher of penmanship or an engraver of visiting cards.

A style not so condensed, but with stems a trifle thicker and with hair-lines equally sharp, is shown by the MacKellar, Smiths & Jordan Co. This face, or the one illustrated on the preceding page, is generally preferred for the initial letters and the title-page letters of texts that have been composed in modernized old-style.

NEW OLD-STYLE
M. S. & J. CO., 1880.

Two-line small-pica condensed old-style.

Another variety of condensed modernized old-style, provided with lower-case characters, is made by James Conner's Sons. In this variety the hair-lines are a trifle firmer, but the spirit of the old-style is traced with difficulty in its smaller sizes.

Odd Old-style

Four-line pica old-style condensed.

Old-style condensed letter is made in a greater variety, and is more thoroughly graded, than the established old-style of standard form. From the bodies commonly used a printer can select two or three distinct widths, which mate better than the condensed of modern-face.

An extra condensed old-style is also provided, in which a few of the peculiarities of the old form are somewhat exaggerated while others are entirely neglected. It is largely used as a display letter in advertisements.

Much Pinched Old-style

40-point old-style extra condensed.

In all these attempts to reproduce the strength and simplicity of the old Caslon character, it does not appear that any founder has copied the firm hair-line which is one of its most characteristic features.



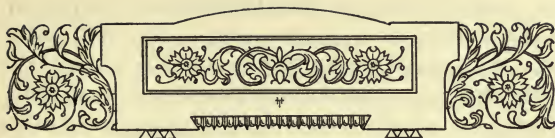

VIII

Italic Types

LTALIC is never selected now as the type for the text of a book, but it may be used with good effect for its preface. Good taste forbids its too frequent employment in its much-abused office of distinguishing emphatic words. An excess of italic spots and disfigures the page, confuses the eye, and really destroys the emphasis it was intended to produce. Yet italic cannot be entirely put aside. There is no other style so well adapted for sub-headings, for names of actors or persons in plays, for titles of books, and for special words not emphatic that should be discriminated at a glance.

Limitations
in the use of
italic types

Although useful, italic is not liked by printers or founders, for it is troublesome to cut and cast, and it has many kerned letters that often break unexpectedly. There are mechanical difficulties

not easily overcome in all attempts to put an inclined face on a square body. The inclination must seem uniform in all letters, but many letters must be cut with varying angles to shorten the unsightly gaps between irregular characters. Kerns are unavoidable, but much ingenuity is often required to prevent one kern from overriding another. There are few forms of faultless italic, but the earlier faces are the most objectionable for uneven workmanship.¹

ALDUS MANUTIUS
exhibited his first form of
Italic type in his octavo edi-
tion of Virgil, Venice, 1501.

Original old-style italic on 22-point body, solid.
 MacKellar, Smiths & Jordan Co.

The italic furnished with the "original" old-style has some capitals which are sprawling and uncouth. They seem badly mated with each other,

¹ Aldus, the inventor of italic, evaded the mechanical difficulties by giving to the characters the slightest possible inclination, by making logotypes of all the interfering letters, and by

using upright capitals of small size instead of inclined capitals of full height. No modern reviver of old letters has ever attempted a faithful reproduction of the Aldine italic.

and with its thick-stemmed and condensed lower-case. In the small sizes of this style the characters of the lower-case are of lighter face, sometimes so light that they are not proper mates for the roman. The larger sizes are frequently selected, more for their quaintness than for their beauty, as a striking display letter for advertisements.¹

There are old-style italics in use that seem to have been made up from a haphazard collection of discarded punches or matrices, gathered from old Dutch and early English type-founders of inferior reputation. When the different sizes so collected are shown on one page, there is a painful discord from the inequality and irregular angularity of the characters. These uncouth types, which were never used by good printers, are often, but erroneously, regarded by readers as of greater age and relatively higher merit.²

The italic designed by Baskerville has capital letters of better form, but they have never been faithfully reproduced by any type-founder of this century. The Baskerville italic is more condensed and more script-like than that of Caslon.

¹ Field & Tuer, of the Leadenhall Press, London, have for their exclusive use an excellent form of old-style italic of bold face, with the swash letters and other features of quaintness, which they use with good effect for initials and for the running titles of books printed in the fashion of the last century.

² One of the rudest and most uncouth forms of old-style italic is shown by Moxon in his "Mechanick Exercises" of 1683, and with larger drawings and more of detail in his earlier book of 1676,—the "Regulæ Trium Ordinum Literarum Typographicarum, or the Rules of the Three Orders of Print Letters."

To the Worshipful

*SIR CHRISTOPHER WREN, Knight,
Surveyor of His Majesty's Buildings.*

Sir,

*To you as to a Lover of Rule and Proportion I
humbly Dedicate these my Observations upon Let-
ters: If they prove Acceptable to you I have my
whole Wish, and shall be careless of the Sleightings
or Censures of the Ignorant Contemners of Order
and Symmetry.*

Sir, I am

Your most Humble Servant,

[London, 1676.]

JOSEPH MOXON.

Modernized old-style italic on long-primer body, leaded.
George Bruce's Son & Co.

The modernized old-style italic follows the general form approved by Caslon, but it is a trifle broader in the lower-case sorts, lighter as to stem, and all the characters have a script-like slenderness of extended hair-line not to be found in the Caslon original. The old forms of *T* and *h* have been properly rejected for *T* and *h*; but what is the reason for the occasional retention of the *f* in place of *J*? The long *f* and its double letters are not completely reproduced. The smaller sizes are sometimes provided with inclined figures. It is largely used for prefaces, and by job printers as a text-letter for circulars in place of script.

This Elzevir italic is the true mate of the Elzevir roman shown on page 200. It is of a bolder face and of closer set, and has thicker stems and firmer hair-lines than the modernized old-style italic. While it reproduces nearly all the peculiar mannerisms of the original—the bold and dashing swashes of the capi-

ABBÉ DE VILLIERS, 1699. I know a man who denies himself the things that are most necessary, so that he can collect in a library, scantily provided with other books, as many little Elzevirs as he can find. In his pangs of hunger he consoles himself with his ability to say: "I have ten copies of each, and all of them have the rubricated letters, and all are of good editions."

Elzevir old-style italic on body 10, leaded.

Gustave Mayeur, Paris.

tals, the conjoined *ct*, and the logotypes of final *s* — *as*, *es*, *is*, *us* — these mannerisms have been so remodeled that they cease to be uncouth or offensive. In most forms of printing they really add to its effectiveness. The Elzevir is largely used in book offices for prefaces, and as a suitable letter for subheadings and running-titles.

Unfortunately this style of italic is not made on any of the larger bodies. There is a real need of larger sizes from 20-point to 72-point.

The French form of old-style italic is more round and open, and is sometimes of wider set than any used by American or English printers of books. Its most pronounced peculiarity is the thickening of the stem in every rounded letter obliquely, or "on its back," as type-founders call it. See the *o*, *a*, *p*, *d*, and other rounded characters. This mannerism, and the old-fashioned models of *v* and *w*, give to this style decided plainness and simplicity. There are other peculiarities of face, especially noticeable in the increased width of the capitals, which stamp this French italic with a distinct character. Its great fault is its frailty: the kerns on *f* and *y* are too long and too weak.

A FRENCH DECREE of 1649. We command that, for the future, printers and publishers shall take one lad only as apprentice. He must be of good life and manners, Catholic, of French birth, qualified to serve the public, well read in Latin, and able to read Greek, of which he shall have a certificate from the rector of the University, under penalty of 300 livres and the cancelling of the license of the offending master printer.

French old-style italic on body 11, leaded.
Fonderie Turlot, Paris.

This bold-faced italic is the mate of the roman on page 80. It has great boldness and blackness, but its hair-lines are slender and too readily worn. It is freely used by job printers as a display letter for circulars, and for book advertisements.

*DANIEL TREADWELL,
born in Ipswich, Massachusetts,
10th October, 1791, invented the
first power platen press made
in the United States. The new
press had merit, but was soon
superseded by the more efficient
Adams press. He died in Cam-
bridge, 10th October, 1872.*

Modern bold-face italic on columbian body, solid.
George Bruce's Son & Co.

Italics of light-face seldom appear in our specimen books. The light-faced romans of American manufacture are too often provided with italics of a thicker stem and of a different style, with which they always make a most unpleasing contrast.

The face shown on the following page is of the round and open form which seems to be preferred by French publishers.

G. A. CRAPELET, a distinguished printer and publisher, was born in Paris in 1789, and died at Nice in 1842. His editions are highly appreciated by connoisseurs for their accuracy and excellent workmanship. He received medals of silver in 1827 and 1834 for his many services to French typography. His writings on the history and practice of printing are of value.

Modern French light-face italic on body 10, leaded.
Gustave Mayeur, Paris.

The form of condensed italic at the foot of this page is of an older fashion that still survives. It is the mate of the French-face shown on page 215.

JULES DIDOT, a son of Pierre, was born August 5, 1794, and died May 18, 1871. He was an expert type-founder and an admirable printer, but not a successful publisher. His presswork on vellum has never been surpassed. For his services to France as an educator in the art of fine printing he was decorated with the medal of the Legion of Honor.

Condensed French-face italic on body 12, solid.
Gustave Mayeur, Paris.

The round and bold-faced italic shown on this page is in the so-called Didot style: it is the mate of the roman shown on page 218.

HYACINTHE DIDOT, a younger brother of Ambroise Firmin-Didot, was born in 1794. After 1857 he became Director of the Didot printing-office. He was a Chevalier of the Legion of Honor, and member of the Municipal Council of the Eure.

Eighteenth-century French-face italic on body 12, solid.
Gustave Mayeur, Paris.

The inclination of italic allows the punch-cutter a much greater freedom of design than he can exercise in the drawing of plain roman Italics of letter. Of this privilege the designers new forms of France have made liberal use. Many of the French-faces have peculiarities of marked merit, but these peculiarities are not accepted by English or American publishers, who object to any deviation from their own standards. French publishers are more tolerant. In standard books and magazines many of them admit such forms of italic as "Venetian" and "engraver's," which are here excluded from good book-work. In America the only form of fanciful italic tolerated in books is the engraver's hair-line, when used for mottos.

BAYARD TAYLOR, author, was born in Kennett Square, Pennsylvania, 11th January, 1825. He began as a printer in 1842. After a service of two years he went abroad, traveling always on foot, supporting himself by contributions to journals. As traveller, lecturer, poet, and translator, he earned a high reputation. At his death, 19th December, 1878, he was the ambassador of the United States at Berlin.

Engraver's hair-line italic on long-primer body, solid.
George Bruce's Son & Co.

The inclined roman shown at foot of this page is one of the many French varieties of italic. It has found ready sale with job printers, but it is an innovation that does not please critical publishers.

WILLIAM A. BULLOCK, inventor of the rotary printing-machine then known as the Bullock press, was born at Greenville, Greene County, New York, in 1813. He was fully taught the trade of machinist, and qualified himself as a mechanician. He made many presses of merit. He died at Philadelphia, 14th April, 1867, from an accident which befell him when he was putting up and adjusting one of his machines in the office of the "Philadelphia Ledger."

Inclined roman on 10-point body, solid.
Benton, Waldo & Co., Milwaukee.

The law italic here shown is broader, clearer, and more easily read than any other. These good qualities have been secured by making each character wider, by giving greater prominence to the round letters, and by shortening the lines of the descending letters. In England and America it is used only as a job-letter; in France it is sometimes used for the running-titles and the sub-headings of standard books.

PIERRE FRANÇOIS DIDOT, son of François, was born at Paris, 9th July, 1732, and there he died, 7th December, 1793. He was a skilful type-founder, a manufacturer of fine bookpaper at Essonne, and the publisher of many books remarkable for their typographical merit.

Law italic on long-primer body, double leaded.
George Bruce's Son & Co.

The line which separates italic from script is not easily drawn. There are many styles of type half italic and half script, but all of them are properly regarded as unsuitable for book-work. This remark can also be applied to faces like the "engraver's," "lithographic," "French," "Harvard," and other styles that are ornamented with flourishes.

280 *Italic Figures and Small Capitals*

The elongated italic is an extremely condensed form of thick-faced italic. It is practically an enlargement of the face shown at foot of page 276. It is cast only of large size, and usually on a rhomboidal body, to prevent the kerning of long characters.

Italic figures are comparatively modern. They are made for many of the standard varieties of old-style letter, but rarely for italic of modern cut. The need of italic figures is clearly shown wherever figures have to be used in lines of italic capitals. The upright small capitals of Aldus by the side of his inclined italic are not more incongruous than the irregular but upright figures of roman when they are embedded in an italic text.

Small capitals of italic are sometimes furnished to some fonts by Scotch type-founders, but they are not made in the United States.

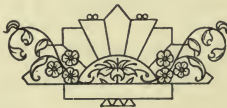



IX

Fat-face or Title-types

SEVENTY years ago fat-face types were in fashion. It was believed that the legibility of a new style could be largely augmented by giving to it greater blackness of face. With this end in view, the designer of the fat-face made the body of each character from one-fourth to one-half wider than that of the ordinary text-letter. Then the body-marks were made extremely thick, to the consequent narrowing of the spaces between the body-marks and a greater shallowness of counter. The hair-lines were cut as sharp as those of the standard roman text-letter. So treated, the fat-face thoroughly deserved its name, for the face covered the body. The relation of black and white was reversed: there was more stem than counter on the body,

Fat-face
made for
display

and more black than white in the print, making it really blacker than the ordinary forms of old black-letter. Job printers and newspaper publishers accepted the new face as suitable for display lines, and for the title lines of newspaper articles. Its frequent employment for these titles made it also known as title-letter. In its day it

PLASTER STEREOTYPING
Done in 1813 by D. & G. Bruce, N. Y.

No. 140.

JOHN WATTS & CO.

Stereotyped in New York, 1813

No. 141.

Fat-face or title of an early cut on long-primer body.
 George Bruce's Son & Co.

was so much admired that it was occasionally used as a text-letter for books.¹ The earlier forms of the fat-face are still shown in the specimen books, but they are seldom bought or used by printers of our time, for they are as unprofitable as they are ineffective. The stronger impression required for the stems is too much for the weak hair-lines,

¹ In 1837, I. Ashmead & Co. of Philadelphia published an edition of "Heavenly Incense, or the Christian's Companion," a chunky octavo of 612 pages. The entire text of this book is in pica fat-face of the boldest form. The forbidding solemnity of every page is indescribable.

which soon break down. A more serious defect is the shallowness of the counters, which often become choked with ink. Fat-face types of the old form are therefore practically obsolete.

The fat-face italic, which is a mate of the fat-face roman, was received by the book printers of the first quarter of this century with Fat-face marked disapproval. Italic had been the italic synonym of all that was light and graceful in type, but when introduced in a form as thick and bold as that of black-letter, all book printers denounced it as an uncouth letter. This prejudice still holds; for standard books fat-face italic is regarded as unsuitable. As a job-letter it is a favorite, and will not go out of fashion. For catalogue work many persons prefer it over all forms of display letter. Recent cuts of this letter are of lighter face and have inclined figures.

STEREOTYPE PLATES**Made by Wm. Ged, in Edinburgh, 1725**

No. 143.

EARL STANHOPE***In 1802 made good plates in London***

No. 144.

Title or bold-face of modern cut on long-primer body.
George Bruce's Son & Co.

In the newer forms, better known now as bold-face, many of the objectionable features have been removed. The stems are thinner, the counters are wider and deeper, the letters are not so fat and are of more pleasing forms. For the side headings of dictionaries and book-catalogues, for which a moderate degree of prominence or display is needed, this new cut of title-type is accepted in books in which no other style of display type would be tolerated. Much to the surprise of many publishers, it has been proved that this lighter-faced style of bold-face is really more readable and more durable than the older styles of over-black fat-faces.

The need, or the supposed need, of a condensed form of bold-face or title-type that will present the greatest boldness in the narrowest compass, has induced all founders to furnish these faces on condensed and extra condensed bodies. Many of them are made in a full series of so-called regular bodies in capitals and lower-case. The over-black styles with

same

An over-black title of an old fashion.

flat and feeble serifs, and without any proper relief of contrasting white space in their counters, are seldom bought. The extra condensed forms of lighter face and better cut are more useful. In the narrow measures of tables, and in some other

forms of printed work, they are of occasional service, but they are grossly misused when they make print indistinct for no other reason than the supposed necessity for crowding many characters in one line. The extra condensed title capitals of the French founders, once much admired by all job printers, are now deservedly neglected.

The most approved form of condensed title is that usually named Aldine. Its condensation is slight, for the larger sizes have letters Aldine not much thinner than those of the ordi- bold-face nary lean text-letter. Having firm hair-lines, with deep and open counters, it is one of the few display types tolerated in fair book-work. The Al-

STEREOTYPING BY PRESSURE

In Semi-fluid Metal, by Carez of Paris, 1786

Aldine.

STEREOTYPING BY PAPIER-MÂCHÉ PROCESS

Done by Genoux of Paris in 1829 for a French Dictionary

Extra condensed title.

Condensed and extra condensed title
on long-primer body.

dine series usually shown in the specimen books of type-founders includes twelve bodies, from pearl to eight-line pica. In the smaller sizes of pearl and nonpareil this style loses much of its clearness.

Title-types are also made of expanded shape. The face first made, then known as extended, or ^{Extended} fat-face extended, is completely and ^{fat-face} de- servedly out of use. The specimens here shown are plain examples of the absurdity of connecting the thickest possible stem with the thinnest

CURVED PLATE

C. Craske, 1853

Two-line pearl extended, No. 181.

STEREOTYPE

Brevier extended, No. 181.

ELECTROTYPING

Joseph A. Adams, in 1839

Long-primer title expanded, No. 182.

Extended and expanded titles.

George Bruce's Son & Co.

possible hair-line. When so made the composed types are deciphered with difficulty. To read a word one has to study carefully the outline of each character. The expanded form of title now in use is not so broad, and is of better cut, but it is at best an uncouth style of letter, and not so popular or so useful as the lighter face of expanded roman shown in the chapter on modern faces of roman text-letter.

Old-style peculiarities do not readily lend themselves to any style of fat-face or title-letter, but they have been made to conform to this Old-style and other fashions with much ingenuity. fat-face
The clear and readable effect of the old-style roman text-letter is produced not so much by its angular peculiarity, or any other mannerism of form, as

STEREOTYPE SHAVER
David Bruce, inventor, 1814.

Pica old-style title.

by its relative monotony of color, its thicker and shortened hair-line, and its comparatively narrow and protracted body-mark. An over-wide fat-face type, that emphasizes the distinction between an over-thick stem and an over-thin hair-line, necessarily destroys the most characteristic feature of the old-style letter. It then becomes necessary to exaggerate the angular mannerisms of the style, but these can be shown with best effect in the capitals only. The stubby serif, the shortened hair-line, and the high-shouldered arch lose much of their distinctive character when affixed to the over-thick stems of the lower-case sorts of an expanded letter. Old-style title so made may be more durable and more readable than the ordinary title, but it cannot be considered as a more

pleasing form of letter. Critical publishers who readily accept for a display letter any cut of old-style antique refuse to take an old-style title.

Old-style title expanded has all of the demerits and but few of the merits of the ordinary form of title expanded. It is never used as a book-type, but only as a fanciful job-letter.

The old-style title condensed, when properly cut, is much more successful in preserving old-style peculiarities; largely so because there is more opportunity in the condensed form for the lengthening of the stems and the shortening of the hair-lines of the lower-case. The large sizes are most effective, but there are cuts of condensed and extra condensed old-styles in frequent use that are especially objectionable for their bad design and bad fitting.

| |
|---|
| <p>ALEXANDER M. TILLOCH Made Stereotypes in Glasgow 1780</p> |
|---|

Pica De Vinne.

The form of title-letter that fairly preserves the distinguishing characteristics of the old-style is that made by the Central Type Foundry, and by that house named "De Vinne." The general form of this new style is mainly based on old-style roman, but it is more expanded, and

has some eccentricities of design in the capital letters. The stems are not over-thick, and the so-called hair-lines have width enough to make each



SMCamdy

Four-line pica De Vinne.

character distinct and in harmony with the thickened stems. It has the undeniable merits of simplicity of form, readability, and durability.

A still bolder form of title-type has been recently introduced under the name of "Atlas" by H. W. Caslon & Co. of London. It is much blacker than any of the early styles of title-type, for its thin lines are fully as firm as those of a doric antique.

The faces on the following page, although of small size and without lower-case, may be fairly classed with title-types. They were made by Barnhart Brothers & Spindler of Chicago, and are known as Engraver's Roman. The names are those of some of the punch-cutters of American type-foundries of the nineteenth century, as I find them in a series of articles on "Designers and Engravers of Type," written by William E. Loy, and published in the "Inland Printer" of Chicago.

290 *Punch-cutters of the United States*

AUGUST E. WOERNER,
BORN AT FRANKFORT-AM-MAIN, DECEMBER 18, 1844.
RESIDENT OF NEW YORK. DIED IN NEW YORK, JULY 27, 1896.

JAMES WEST,
BORN AT EDINBURGH, SCOTLAND, IN 1830.

ALEXANDER PHEMISTER,
BORN AT EDINBURGH, SCOTLAND, IN 1829.
DIED AT CHELSEA, MASSACHUSETTS, IN 1891.

HERMAN IHLENBURG,
BORN AT BERLIN, GERMANY, IN 1843.
RESIDENT OF PHILADELPHIA.

SAMUEL SAWYER KILBURN,
BORN AT BUCKLAND, MASSACHUSETTS, DEC., 1799.
RESIDENT OF BOSTON. DIED DEC., 1864.

GUSTAV F. SCHROEDER,
BORN NEAR BERLIN, GERMANY, IN 1861.

HARRISON T. LOUNSBURY,
BORN NEAR PEEKSKILL, N. Y., IN 1831. DIED IN 1892.

W. F. CAPITAINE,
BORN AT SOUTHGATE, NEAR LONDON, JANUARY, 1851.

DAVID BRUCE,
BORN AT NEW YORK, FEB. 6, 1802.
RESIDENT OF NEW YORK. DIED AT BROOKLYN, SEPT. 13, 1892.

EDWARD RUTHVEN,
BORN IN SCOTLAND, DEC. 31, 1811.

ALEXANDER KAY,
BORN AT EDINBURGH, JUNE 6, 1827.

WILLIAM W. JACKSON,
BORN AT CAMDEN, NEW JERSEY, JULY 25, 1847.
DIED AT ATLANTIC CITY, AUG. 14, 1898.

ANDREW GILBERT,
BORN AT EDINBURGH IN 1821.
DIED AT CHELSEA, MASSACHUSETTS, JULY 25, 1873.

JOHN F. CUMMING,
BORN AT HARRISVILLE, PENNSYLVANIA, MAY 20, 1852.

JULIUS HERBERT, SR.,
BORN AT BRUNSWICK, GERMANY, FEB. 9, 1818.
Four faces on nonpareil body, of which three are here shown.



X

Black-letter

BLACK-LETTER is a degenerate form of the roman character. Its mannerisms probably began with copyists not expert at curved lines, who had to form each letter with repeated strokes of the reed. If the parchment kinked or buckled, if the paper was rough, if the reed sputtered, repeated strokes were all the more obligatory. Under these conditions the portions of a roman letter that were curved in the model would be straightened and made angular at every junction with connecting lines.

Whatever the cause, the angular character which printers call black, and bibliographers call gothic,¹ was the form approved by the copyists of Europe

¹ Bibliographers call it gothic character preferred by all people because it has always been the of Gothic descent.

for some centuries before the invention of printing. Little text-writing was done in any other style. Italian copyists preferred the simple open forms which seem to have served as models for our modern roman and italic, but they were too few in number to change the prevailing fashion. The majority of copyists adhered to black-letter, and readers who knew no other style objected to all attempts at change.

There were many fashions of black-letter, for there was no generally recognized standard of authority as to the correct form of letters, and each copyist made them to suit his own notions of propriety or convenience. A condensed and pointed form was the accepted style for books of devotion; a rounder and more careless form for texts or for writing that did not seem to call for precision. In different manuscripts made before the fourteenth century one finds letters that are condensed, expanded, of light face, of dark face, with plain capitals, with flourished capitals, but all of them are of an angular style. It cannot be said that all of these styles are noticeably black, but most of them, especially the more pointed forms, had lines so thick that more black than white appeared on the written page. The English name of black-letter was given to this character only after the introduction and general use of roman printing-types. The roman type was then called white-letter as a ready

name of distinction, for roman showed more white than black upon the printed page.

To modern readers all the early styles of manuscript black-letter are perplexing. One must study each style to decipher its characters. Obscurity of The world of letters is not conscious early forms of its indebtedness to the art of typography for its enforcement of a simplification of the alphabet.¹ Out of the many styles then in fashion the early printers selected but two; probably because they were of simple forms, popular with readers, and easy to be made in type. One was the pointed black-letter, now known to French bibliographers as the *lettre de forme*.² This was the standard or formal letter which was preferred for all the carefully written books. The other style, the round

¹ "So much beauty or dignity was supposed to be inherent in this distortion of the alphabet, that a treatise of one of the schoolmen, printed at Venice by Giov. di Colonna and J. Manthen, bears with it this commendation, that it is executed *sublimi literarum effigie*; and the "Conciliator Medicinæ" of the year 1483 has this subscription, *characterē jucundissimo M. Joannis Herbort Alemanni, cujus vis et ingenium facile supereminent omnes*. In 1525 Nicolas Prevost at Paris writes of a Gothic impression, *Opus pulchro literarum characterē politissimum*. Another French printer of 1520 commends his book as

Politoribus characterum typis." Greswell, "Annals of Parisian Typography," p. 14. London, 1818.

² The "Bible of Forty-two Lines," supposed to have been printed before 1455 by Gutenberg of Mentz; the "Psalter" of 1457, printed by Fust and Schœffer of Mentz; the small books attributed by some to Coster of Haarlem between 1423 and 1440, and by others to some unknown printer of the Netherlands before 1476; the "Books of Hours" and many other books of merit of the early French printers, are in different sizes and fashions of the *lettre de forme*.

gothic, is known as the *lettre de somme*,¹ and it was the style most approved for ordinary books.

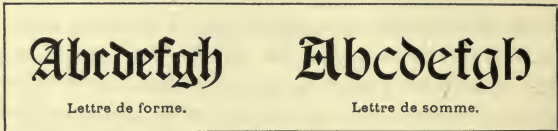

Modern imitations of early styles of black-letter.

The form of black-letter most approved by English readers is the pointed form, which Blades says is modeled on the lower-case letters of Old English the "Bible of Forty-two Lines."² Although it has been supplanted as a text-letter by the roman, it is so identified with early English printing that it fairly deserves its generally accepted name of Old English. The specimen on pica body (page 295) was cast from matrices sunk in the early part of the sixteenth century, probably in Rouen, France, whose type-founders then supplied England with its best types. The larger bodies are old, but of later date. The body-marks of this style are thick, and the characters are so

¹ The "Letters of Indulgence" of 1453 and 1454, and the "Catholicon" of 1460, attributed to Gutenberg, as well as the Latin "Bible of 1462" printed by Peter Schœffer, are in the *lettre de somme*. The ordinary reader of the sixteenth century preferred this style to the pointed gothic and to the roman character.

Even in Italy, Nicholas Jenson, after his introduction of roman types, found it expedient to print books in this round gothic to suit the tastes of unscholarly book-buyers.

² This form was sparingly used by Caxton between 1479 and 1483, but always with capitals in the Flemish style.

closely fitted that it well deserves the name of black. Some of the capitals (not in the Flemish but in the French style) are uncouth, but the general effect of a printed page is pleasing. It is frequently selected for lines or words of prominence by lawyers, and for a formal text by ecclesiastics. The official copy of English statute law continues to be printed in this early style of black-letter.

If it plese any Man
Spirituel or Temporel
to bye any Bpys of two or thre comemo-
ratiōs of Salisburi Use enpnynted after
the Forme of this presēt Lettre, which
ben wel and truly correct late hym come
to Westmonester, in to the Almonestepe,
at the Reed Pale, and he shal haue them
Good Chepe. ❖❖ *Supplicio stet cedula.*

Real Old English on pica and larger bodies, leaded.
Sir Charles Reed's Sons, London.

Pickering selected it for his Victorian edition of the "Book of Common Prayer." Moxon commends it as a style that should be in the stock of

every master printer. It is more in fashion now than it has been at any time during the past century, for the stringent rule that excludes almost every other style from the standard book tolerates and often commends the occasional employment of a good form of black-letter.

For the facsimile reprinting of fifteenth-century books, abbreviations on pica body have been provided, but they are not made for the larger bodies.

¶ ʒ ʒ m& Q ʒ ʒ ʒ ʒ ʒ ā ē ī ō ū m̄ n̄ c̄ ḡ
 ŋ r̄ ā ē ī ō ū ñ f̄ d̄ c̄ c̄ c̄ ḡ p̄ p̄ p̄ p̄ pp̄ p̄ q̄ e

Strictly German styles of black-letter have never been used for book-texts at any period by English publishers. In the beginning English publishers had to buy their best types from foreign founders, and sometimes to get books made by foreign printers, but they never selected the *fraktur*, *schwabacher*, German text, or any of

Theodoric Hood, a German born
 O' the City of Cologne,
 That he this curious Book did print,
 To all Men maketh known.
 And his good Partner Thomas Hunte,
 An Englishman he was.
 Now aid them Heaven! that they may
 Venetian Skill surpass.

Black-letter in the Flemish style on brevier body, solid.
 Sir Charles Reed's Sons.

the German styles. When English printers could not buy from the type-founders of France, they went to those of the Low Countries. The illustration on the previous page shows an early form of English black-letter with some Flemish mannerisms of the sixteenth century. In the modern form of Flemish black-letter these peculiarities are retained. It will be noticed that it is an entirely distinct style, and that it seriously differs from the accepted fashion of German text-letter.

The book in which the English language was first printed¹ is of another Flemish style, made after the design of some unknown copyist, who wrote with a free, flourishing hand. Although printed in English, it was not printed on English soil. The type first used by Caxton in England, and probably made in Bruges, was of the same style, but Blades describes it as "more dashing, picturesque and elaborate." This style was then known in France as the *grosse bâtarde*. It does not appear to have been much liked by English readers, for Caxton did not use it exclusively, and it was not renewed by his suc-

¹ The "Recuyell of the Histories of Troye." Translated in 1469-1471, but without place or date. According to Blades this book was printed by William Caxton about 1474, and probably in the printing-house of Colard Mansion at Bruges. According to J. P. A. Madden, it was

printed before 1474 by Caxton at the monastery of Weidenbach, near Cologne, where Caxton and Mansion were acquiring their knowledge of typography. It is a style of type not at all English. "Lettres d'un bibliographe," quatrième série, pp. 13-30. 8vo. Paris, 1875.

cessors. After long neglect it was revived in 1855 by Vincent Figgins of London for a facsimile edition of Caxton's "Game and Playe of the Chesse."

For I have not Added ne Myn:
 usshed, but have folowed as
 nygge as I can my Coppe, whiche
 was in Dutche, and by me Willm Caxton
 translated in to this rude & symple Eng:
 lyssh in thabbey of Westmonestre. Syn:
 ysshed the vj dape of Junn, the pere of our Lord
 .M.CCC.Lxxj. & the xxj pere of the Regne of
 Kyng Edward the iiijth. Here Endeth the
 Historpe of Reynard the Fox. ~~~~~

Old Flemish black used by Caxton.

It has since been cut by other English or German founders in many sizes, from nonpareil to six-line pica. Printers have reinstated it as a valuable

À B D K M P Q R T W

letter for the reprints of early English or Flemish books, and it is freely used for mottos, quotations, and for title headings in catalogues of books.

The same desire for novelty has led to the revival of the old fashion of round gothic, or *lettre de somme*, which now appears as a more Old black, or carefully cut letter, under the name of round gothic old black. It seems to be a careful reproduction of a style of letter preferred by many Spanish printers of the fifteenth century. It is now made in a full series of sizes, from nonpareil to eight-

Fue impressa la presente Carta de Relacion en la Vmperial Ciudad de Toledo por Gaspar de avila, Acabo se a veynte dias del mes de Octubre. Año del nacimiento de nuestro saluador Jesu Christo de mil 7 quinientos 7 y veynte cinco anos.

Old black on pica and double small-pica bodies.

line pica, but all of them are incompletely provided with abbreviating characters. The round lowercase letters have unusual height; the ascenders, descenders, and capitals are correspondingly shortened. It is a useful letter for reprints of early books, and is frequently selected for headings or display lines in the advertisements of publishers.

For more than three centuries English type-founders adhered with great tenacity to the form of pointed black that had been provided for them by the early French and Flemish founders. The model letters drawn by Moxon in 1676 for his "Rules of the Three Orders of Print Letters"



From Moxon's "Mechanick Exercises."

show no important departure from those used by Pynson and Wynkyn de Worde. Nor was any change made by English founders of the seventeenth or eighteenth century that would justify

The holy and blessed Doctour Saynt Jerom sayth thys Auctoryte, Do alweye somme Good Werke to thende that the Deuyl fynde the not Pdle. And the holy Doctour Saint Austyn sayth in the Book of the Labour of Monks that no Man Stronge or Hyghty to Laboure ought to be Pdle. ❀ ❀ ❀ ❀ ❀ ❀ ❀ ❀ ❀ *Golden Legend.*

Old English black of the sixteenth century, leaded.
Sir Charles Reed's Sons.

the naming of any one of their new cuts as that of a distinct style.

The first novelty attempted in the form of black-letter was that of the fat-faced black, which appeared at or near the beginning of this ^{Fat-faced} century when the fat-faced romans were ^{black-letter} popular. Hansard¹ denounced it as "a fanciful but ridiculous innovation"; Dibdin sneered at it as "gouty and frightful"; but these censures did

Why does he [a famous printer of London] and many other hardly less Distinguished Printers adopt that Frightful, Gouty, Disproportionate, Eye-distracting and Taste-revolting form of Black-letter too frequently visible on the Frontispieces of his Books? Let the Ghost of Wynkin de Worde haunt him till he abandon it.² —————

Fat-faced black on pica and long-primer bodies.

¹ "As a British classic type, it [Old English] must be regarded with veneration in England, as the character in which Wynkyn de Worde . . . first exercised the art, and therefore I shall include Blacks in the Synopsis; but studiously abstaining from

mixing in the list the modern fanciful (but ridiculous) innovations, only called Blacks from the quantity of ink they are capable of carrying." Hansard, "Typographia," p. 404.

² Dibdin, "Bibliographical Decameron," ii, 407.

not prevent its employment. Many of the larger foundries made it in a full series of sizes from brevier to six-line pica. For thirty years or more it was preferred by printers to the older form, which was set aside as uncouth and obsolete.

The designers of the early forms of black-letter avoided hair-lines; the designer of the fat-faced black studiously tried to introduce them in places where they were not needed. He also attempted to make the stems of some of the capitals conform to the shape of the roman capital. These changes are no improvement on the old models.

In France and Germany these fat-faced blacks were never as popular as they were in England.

French form of black-letter The continental founders modernized the early forms in another direction. This is the style now preferred in France, which has also been accepted to some extent in England and the United States, as a proper style for lines of display in good work. At its introduction it had the merit of novelty, but a modern reader

**Of making many Books
there is no End; and much Study
is a Weariness of the Flesh. ♀ ♀**

A French black-letter of modern cut.

fails to see in it any point of superiority when put in comparison with the English black-letter of the sixteenth century; yet it has the negative merit of few serifs at the angles. Unfortunately it has not been made in a full series of sizes.

Neither the precise pointed gothic nor the more careless round gothic seems to have been entirely acceptable to the uncritical German ^{Fraktur and} reader of the fifteenth century. There ^{schwabacher} was a desire for types that should be more careless and unconventional, in imitation of the letters of

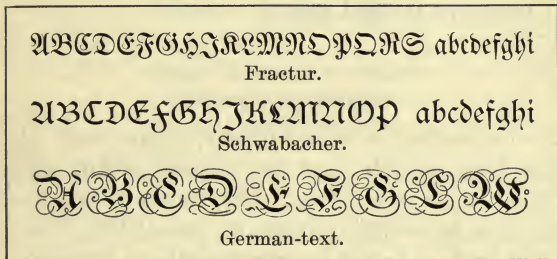

a hasty manuscript. A few of the eccentric styles of black-letter then in fashion were reproduced, of which three still retain their old popularity—the fraktur, the schwabacher, and the German text.¹

¹ The broad-faced style of the schwabacher was first made in a very rude form by Rewichs of Mentz, in 1486, although some of its peculiar characters are noticeable in the types of Peter Schœffer. The slender and extremely condensed fraktur first appeared in a good form in the “Theuerdank” of Hans Schoensperger, Nuremberg, 1517. The text was adorned with flourished initials which have served as the models for modern German text.

The fractur is still the preferred text-letter for the newspapers and ordinary books of Germany. For scientific books the antiqua or roman is usually selected, and it is also more frequently used for the letters of coins, medals, and sign-boards.

Vnderweysung der Messung, mit dem Zirckel
vnd richtscheyt, in Linien Ebenen vñ ganzen
Corporen, durch Albrecht Dürer zusamen ge-
zogen, vñ durch jn selbs nun allen kunst lieb-
habenden in truck geben. 1538.

Fractur on pica body, leaded.
George Bruce's Son & Co.

The schwabacher is a rounder, clearer, and simpler form, largely used for display, and to some extent as a text-letter. The German-text, once popular as a display letter in book titles, is now little used, and only in ornamental job printing.

Ich bin geschicket mit der Press,
So ich aufftrag den firniss ress ;
So bald mein Dienr den Bengel zucht
So ist ein Bogn Papyrs gedruckt.
Hans Sachs.

Schwabacher on pica body, solid.
James Conner's Sons.

German founders have devised other forms of black-letter, which are occasionally seen in Ger-

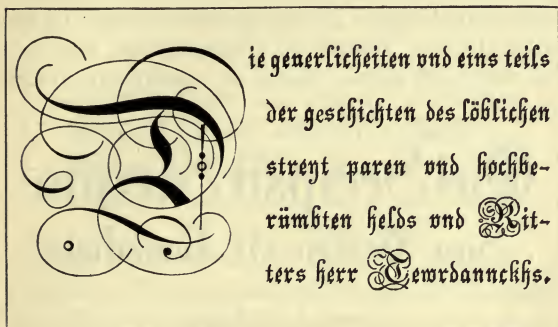

Modern German-text.
George Bruce's Son & Co.

man books. Some of them have been reproduced by our American founders, but only after they have been divested of most of their unacceptable German mannerisms. The composite, Teutonic,

Scriptor scripsissit
Bene; Melius, si potuisset.

Composite.

and Borussian are freely accepted by American printers as useful text-letters or display letters for legal formularies. At least a score of distinct styles can be seen in the specimen books of the large German foundries, most of them cut in a full series of sizes. Many are admirably drawn

**Qui Scripsit Scripta
Sua Dextra sit Benedicta.**

Borussian of bold-face.

and engraved, but they are put aside by American founders as too fantastic for common readers; yet they are not more fantastic than many black-letters of American origin.

During the past thirty years, American type-founders have devised many entirely new forms

Reading maketh a Full Man,
Conference a Ready Man,
Writing an Exact Man.

Borussian of light-face.

of black-letter or pointed text. Card text, Anglo-saxon, Franklin, medieval text, fancy text, title text, eureka text, scribe text, modern text, Italian text, sloping black, expanded black, are the names

**Crafty men Contemn Studies ;
Simple men Admire them ;
Wise men Use them.**

Teutonic on english body.

of but a few of the novelties designed for job printers. Many of these styles are varied by ornamental outlines, or by ruled cross-lines, or shades, or inlays. All have been made in the lithographic or the copperplate style, with very sharp and long hair-lines, most of them with serifs bristling on every angle. Although of simpler form than the German novelties, their overworked delicacy and refinement of cut, and their excess of flourish and ornament, make them so feeble and ineffective that they are properly excluded from book-work.

Exception to this general condemnation may be made in favor of a few new styles. The Augustan black, of as light face as the ordinary roman, is a remarkably graceful letter. Weakness of new styles The same praise must be given to the condensed blacks of light-face and of bold-face. Tested by mechanical standards, they seem faultless in design, spacing, engraving, and fitting-up.

The characters, harmonious in every combination, impress the reader with their honest, painstaking workmanship. Yet they are thoroughly feminine in effect — so made by over-refinement in cutting, and by the needless decorations of flourished serifs

The disrepute into which
 Letter of this cut [Fat-face] has fallen has
 probably arisen from Negligence, Inatten-
 tion and Want of Taste. . . . It is diffi-
 cult to investigate and specify the qualities
 which constitute Beauty: but Fatness
 seems to have been considered by the Let-
 ter-founders as an adequate Substitute for
 all such qualities.¹

Augustan black on pica and double-pica bodies.
 George Bruce's Son & Co.

and hair-lines. One has but to contrast them with the sturdy styles of the old printers to understand why men of letters keep them out of standard books. When these blacks are selected for the headings of a chapter, or for the running-title, their incongruity with the roman text is startling.

¹ Hansard, "Typographia," p. 617.

Fortunate would it be, if the use of its Angles and Straight Strokes, its Points, Bosses, Hooks, Ligatures and Intermingled Letters, as well as its innumerable Abbreviations, Hair Strokes scarcely visible, united with Thick Ones, and its Breaks and Curvatures, were entirely to disappear, and left only as the Type of a period when all Learning had nearly perished, together with Good Sense and Good Taste.¹

Condensed black of bold-face on long-primer body.
George Bruce's Son & Co.

This mischievous tendency to over-refinement in the designing of types has effectually spoiled and kept out of general use two characteristic styles of early black-letter. Obscurity of church text

The church text, as one may still see it upon inscriptions on tombs and tablets in some of the old English and German churches, is an ecclesiastic letter of marked grace. In the types here shown, the general form is above reproach, for every letter has been carefully studied from good models. In these model letters on the stone or in the brass hair-lines were carefully subdued, but in the type the hair-lines and the knobby serifs have been thrust in where they were not needed. The result is disappointing, for the strong character of

¹ Silvestre, "Universal Palæography," translation of Sir Frederick Madden, vol. ii, p. 652. 8vo. London, 1849.

the letter has been destroyed by the addition of these feminine graces. Churchmen who know and esteem this letter for its appropriateness in ecclesiastic work refuse to use it, condemning it for the faults of delicacy and obscurity.

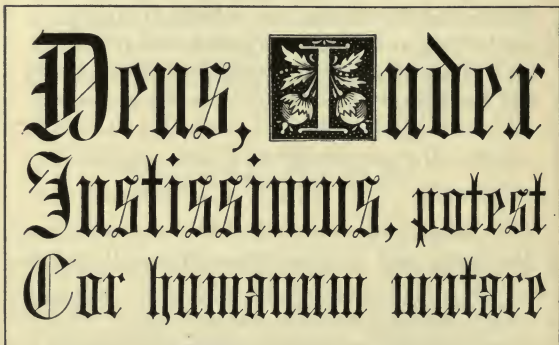

Church text on canon and smaller bodies.
Sir Charles Reed's Sons.

The chapel text is a modern variation of the old church text. It is not so condensed, and should be more easily read. The capitals are not unpleasantly ornamented, for the decorative lines are entirely inside of the letter proper, leaving a sharp and clear outline. This feature should make the capitals useful for the rubrics of liturgical work, but the stems of the capitals, although without hair-lines, are too thin to retain the amount of color that is needed for a

rubric. In the lower-case the punch-cutter has practically conjoined all the letters with angular knobs or serifs where they are not needed, by trying to make the short letters line at the top as well as at the bottom. The entirely unnecessary graces of occasional flourishes, and pendants, and over-sharp hair-lines, have made the weak and obscure lower-case a bad mate for the capitals. Difficult to read in black ink, it becomes almost unreadable, certainly ineffective, when printed in the prescribed scarlet red. Therefore the churchman neglects it, preferring the old form of black-letter, not for the uncouthness of its capitals, but for its legibility, since the broader surface of the character permits it to be easily read, even when printed in the palest of scarlet.



Qui Legit Emendat, et Scrip-
torum non Reprehendat.

Chapel text.

The Saxon is another example of the danger of emasculating a strong letter. The delicate finials and interlaced lines of this style, as they may be seen in early manuscripts, did Saxon black not weaken but intensified the strength of the Saxon style, for these finials and interlacings were

usually in pale color, and were a contrast to the stronger lines or stems of the letter. When cut in outline these ornaments become too prominent, and the strength of the character is destroyed.

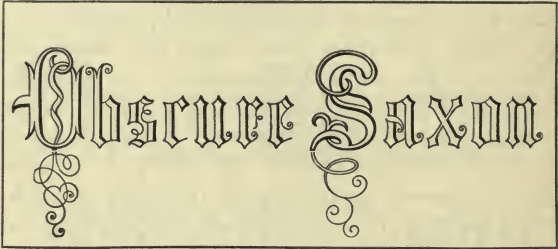

Ornamented Saxon on meridian body.

The designer of the Anglo-black has given a good imitation of an incised letter, in the gothic style, cut in stone by different blows of the chisel. It has no beauty of form to recommend it, but is an appropriate letter for the representation of inscriptions on tombstones.

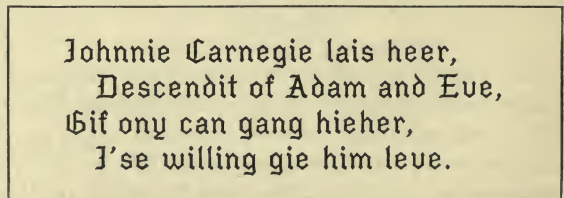

Anglo-black on pica body.

The medieval, although not in the pointed style, is usually classed with black-letter. It is admirably adapted for rubrication, but its use in that field is limited, for it is made in ^{Medieval} _{black} three sizes only. The capitals seem to be the modification of a mongrel type first made by William Le Rouge of Paris in 1512, as a rival to italic. The

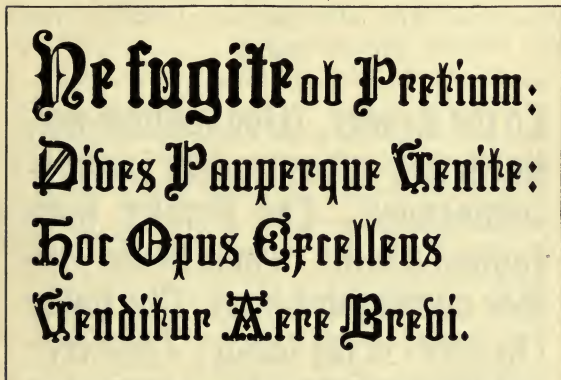

Medieval on meridian and double small-pica bodies.

broad Byzantine capitals were bad mates for the condensed lower-case.

Many meritorious novelties in black-letter have been introduced recently by the type-founders of Germany, but the relatively limited use of the German character in this country does not allow here any more than respectful mention.

A recent novelty in black-letter is the bold-face designed by Mr. Will H. Bradley, which has been introduced to the printing trade by the American Type Founders Company in eight sizes, ranging from 6-point to 48-point, under the name of the Bradley series. The series first made has remarkably bold letters, with peculiarities of form never before attempted. Among job printers, and to some extent with advertisers, the Bradley is rated as a valuable type for display.

**To the Reader. Who faulteth not,
liueth not; who mendeth faults is
commended: The Printer hath
faulted a little: it may be the Au-
thor oversighted more. Thy paine
(Reader) is the leaste; Then erre
not thou most by misconstruing or
by sharpe censuring; lest thou be
more uncharitable than either of
them hath been heedlesse: God
amend and guide us all. ¶ ¶**

Robartes on Tythes, 4to, Cambridge, 1613.



XI

Gothic

OTHIC is a misleading name. Ordinary readers and book-collectors give it to all the older forms of black-letter, but American type-founders apply it to a sturdy type that has neither serif nor hair-line. The gothic of the type-founder was not derived from black-letter, and has no resemblance to it. Its capitals are a rude imitation of the classical Greek and Roman lapidary character. Probably it was called gothic because the style first put in type was as bold and black as that of the black-letter gothic manuscript. Some English type-founders call it sans-serif, but others call it grotesque and also gothic.

Of all styles this is the plainest. It has no useless lines; in its regular or ordinary shape, each character is distinct, and not to be mistaken for

any other. For this reason it is the style selected for the raised letters that are made for the blind, to be read by the sense of touch. Many adverti-

A LIGHTER FACE OF GOTHIC
provided with irregular figures of old-style

No. 1.

A GOTHIC OF MEDIUM FACE
condensed and with a full lower-case

No. 2.

BOLD-FACE GOTHIC
with a rugged lower-case

No. 3.

A GOTHIC NOT SO BLACK
with bold and distinct lower-case

No. 4.

AN EXTENDED GOTHIC
lower-case and figures

No. 5.

Five styles of gothic on pica body.

sers prefer it over all other styles for the purpose of bold display. Many printers prefer it for its greater durability: it has no serifs to be bruised, and no hair-lines to be gapped.

The bold-face gothic, No. 3 of the illustration (on page 316), appears to best advantage in the larger sizes. When the body is small, the thicker lines occupy too much of the face, and letters like **E, A, F, S, a, e, s**, and indeed all characters with a central crossing line, have too little relief of interior white space.

The medium face, No. 4, and the lighter face, No. 2, are much more readable, and are preferred for display.

The old-style figures of the lighter face No. 1 are often selected for tables in which the greatest distinctness is desired.

The extended gothic, No. 5, also has old-style figures, but its lower-case characters are not so popular. Nor can its capitals be used effectively without a special and irregular spacing between single letters. Where letters with perpendicular lines like those in **HIM** meet, one has to put spaces between to keep them apart at proper distance. When letters with angled lines like **LAY** meet, an awkward gap of white space appears between these irregular letters, which should compel the compositor to give a wider spacing to all other letters in the line.¹ Gothic calls for more care in spacing than any other style.

¹ Although this remark can be applied to all letters, even to roman and italic, it is especially applicable to gothic, and to any style that has short and stubby serifs like those of the Elzevir. It is probable that the long serif first made by Jaugeon of Paris was invented to conceal or modify this blemish.

The absence of projecting serifs in the gothic style allows its letters to be compressed with but a moderate loss of readability, as may be seen in

**A CONDENSED GOTHIC BOLD-FACE
lower-case with short descenders**

No. 6.

**THIS GOTHIC CONDENSED
is of a lighter face and on a wider set**

No. 7.

GOTHIC CONDENSED. NO LOWER-CASE

No. 8.

**A PICA GOTHIC, EXTRA CONDENSED AND OF A VERY FLIMSY FACE
in which compression has been made at the expense of legibility**

No. 9.

PICA GOTHIC CONDENSED HAIR-LINE

No. 10.

Five styles of gothic condensed on pica body.

three of the preceding illustrations. The extra condensed gothics and the hair-line gothics on the smaller bodies are a severe strain on eyesight.

The merit of the gothic character is largely in the simplicity and readability of its capitals, but the lower-case sorts furnished with many styles

are often found unsatisfactory, for they are not as symmetrical as the capitals, nor are they always as distinct. There are publishers who forbid the use of gothic if they cannot have letters in capitals only. Yet those who do use capitals only soon find an unpleasing monotony in a succession of lines of gothic capitals all of uniform height. Nor are successive lines of gothic capitals necessarily distinct because the face is bold and black. If the lines are not widely leaded, and if meeting letters with parallel lines are not intelligently spaced, the composition will be huddled and obscure: it will not be as readable as lines that are composed in plain roman capitals.

To enable the compositor to give a proper prominence to special letters or words, type-founders now cast three or more faces of the smaller bodies of gothic capitals on one body, and adjust all the faces on one line.

Usefulness
of lining
gothics

This permits the compositor to make a proper distinction of selected words and letters by a judicious use of large and small capitals. The different faces assist in justification and in the making of lines of even length. These combined faces are sold in series, and are known as lining gothics. They are made of light-face and of bold-face, and in a backslope form, not only for small but for large bodies. The bodies preferred by job printers are those of the smaller sizes. These lining gothics have been found most use-

ful in the composition of panels and headings. They are used also for the legend line of illustrations in places where the smaller sizes of small capitals are rejected as deficient in readability.

THIS LINING GOTHIC OF A BACKSLOPE SHAPE IS PROVIDED WITH FOUR DISTINCT FACES. ALL OF THESE FACES ARE PUT ON NONPAREIL BODY, AND MADE TO LINE SO THAT THERE SHALL BE NO SPECIAL JUSTIFICATION OF THE DIFFERENT FACES.

Four faces.

ESTIENNE, BEST KNOWN TO ENGLISH READERS BY THE NAME OF **STEPHENS**, IS THE FAMILY NAME OF MANY EMINENT FRENCH PRINTERS.

HENRY, FIRST OF THE NAME, WAS A PRINTER IN PARIS FROM 1496 TO 1520.

FRANCIS I, SON OF HENRY, DIED IN PARIS, 1550.

ROBERT I, SON OF HENRY, PRINTED IN PARIS AND GENEVA FROM 1526 TO 1529.

CHARLES I, SON OF HENRY, PRINTED IN PARIS FROM 1536 TO 1550.

HENRY II, SON OF ROBERT I, PRINTED IN GENEVA FROM 1554 TO 1598.

ROBERT II, SON OF ROBERT I, PRINTED IN PARIS, AND DIED THERE IN 1588.

Five faces.

OTHER ESTIENNES, BEST KNOWN TO ENGLISH READERS BY THE NAME OF **STEPHENS**:

FRANCIS II, SON OF ROBERT I, WAS A PRINTER AND PUBLISHER AT GENEVA FROM 1562 TO 1582.

PAUL, SON OF HENRY II, PRINTED IN GENEVA, AND DIED THERE IN 1598.

JOSEPH, SON OF HENRY II, PRINTED IN GENEVA, AND DIED THERE IN 1627.

GERVAIS, AND **ADRIEN**, SONS OF FRANCIS II, PRINTED IN PARIS: THEIR DATES OF DEATH ARE UNKNOWN.

ANTOINE, SON OF PAUL, PRINTED IN PARIS: HIS DATE OF DEATH IS UNKNOWN.

HENRY III, SON OF ANTOINE, WAS A PRINTER IN PARIS IN 1646.

ROBERT III, SON OF ROBERT II, WAS A PRINTER IN PARIS IN 1640, AND THE LAST EMINENT MASTER-PRINTER OF THE FAMILY.

Four faces.

Three styles of lining gothic on nonpareil body.

Gothic types are too simple in form to allow of much ornamentation, but some attempts have been made to give grace to their simple and severe lines, as may be seen in the following illustrations :

ECCENTRIC IN CAPITALS

A GOTHIC WITH SMALL CAPITALS

A GOTHIC CONDENSED AND ORNAMENTED
with very short serifs, after the latin model

The eccentric capitals of the bolder style have some value in lines of display, but for ordinary work their added quirks are positive disfigurements; yet this face, as well as the gothic of lighter face with small capitals, is provided with one set of plain and another of eccentric letters.

The gothic condensed and ornamented has very short serifs, and should be classed as a variety of the so-called latin face. Its slight degree of decoration is most noticeable in the capitals. The lower-case has little irregularity. It is a readable type, and is freely used as a text-letter in job-work.

Gothics of inclined form are made by many founders, and are usually named gothic italic. For advertising purposes a bold-face like that

of the first illustration on this page is preferred. The lighter face that follows, equally close as to set, moderately condensed, and with some old-style

THIS GOTHIC ITALIC CONDENSED
Is of bold-face, is close-set, and very readable

Gothic italic condensed on long-primer body.

features, is a more popular style. It is one of the most readable of condensed letters, and is frequently selected by job printers for a text-letter.

HENRI DIDOT, a son of Pierre François, was born 15th July, 1765, and died in 1852. At the age of sixty-nine he cut the punches for his "microscopique" type on the body of two and one-half points Didot, or about twenty-five lines to the American inch.

Gothic italic condensed on long-primer body, double leaded.



XII

Antique Types, Runic, Celtic, and Italian

ANTIQUE differs from roman in the boldness of its lines: stem, serif, and so-called hair-line are always of greater thickness. The general effect of a composition in this style is that of blackness and squareness. As first made, antique was provided with lines that were too thick and counters too narrow, and the overhang of its descending letters was a bad fault. It was introduced at a time when all forms of roman text-letter were made feeble with protracted hair-lines and frail serifs after the prevailing French fashion. The intent of the designer was to produce, for purposes of display, a bolder style that should be as distinct and easily read as that of the old lapidary characters. For this reason it was called antique by some founders and egyptian

The earliest form of bold display type

AN EARLY ANTIQUE
probably cut before 1820

No. 1.

CAST BY GEORGE BRUCE
as a substitute for the bold-face

No. 2.

THE DORIC ANTIQUE
has features of roman

No. 3.

THE IONIC ANTIQUE
has large face, open counters

No. 4.

THE LIGHT-FACE ANTIQUE
is not much bolder than roman

No. 5.

THE EXPANDED ANTIQUE
has no overhanging descenders

No. 6.

Six faces of antique on pica body.

by others. Copies or imitations of this over-black style are to be found in the specimen books of many American founders. For some years it was the most popular of display types, but the smaller sizes are now out of fashion, for they have been supplanted by others of neater cut. The over-black style is shown on page 324 as specimen No. 1.

BOOKS ARE TEACHERS

whose instructions are unaccompanied by blows or harsh words, and who demand neither food nor wages. You visit them, and they are alert; if you want them, they do not secrete themselves; nor do they ridicule your ignorance, be it ever so gross. Richard de Bury.

Old-style antique on pica body.

Specimen No. 2 is of a style that is not yet out of fashion. The smaller sizes have been discarded, but the larger sizes are popular.

Specimen No. 3, usually called doric, is really a combination of a thick-faced roman and antique. This face, as well as the runic and celtic of the next page, lacks the square serif which is the characteristic of a strict antique.

Specimen No. 4 is often named ionic. It has some of the roundness of the doric style, but is of a lighter face and is not expanded.

Old-style peculiarities have been attached to the antique style. The illustration on the previous page is of medium boldness, but lighter and bolder faces are also made. Old-style antique is the preferred letter for the side heads or displayed words of a text in old-style roman.

The lightest and most open form of the antique style is usually known by the name of celtic. The first illustration below is of a face made in capitals only. Authors and publishers sometimes

A CELTIC OF LIGHT FACE

No. 7, on long-primer body.

BROAD-FACED CELTIC
with lower-case complete

No. 8, on pica body.

A RUNIC OF CONDENSED FORM

No. 9, on pica body.

RUNIC OF SQUARE FORM
has crescent-shaped serifs

No. 10, on pica body.

select it for the title-pages of books in preference to the ordinary form of two-line roman.

Another style of celtic is slightly expanded, and is provided with lower-case characters.

Runic is the name given to another style of antique of light-face, of condensed form, with pointed serifs, and often without lower-case characters.

Another style of runic is made with all lower-case characters, but of slightly expanded form and with the peculiarity of crescent-shaped serifs.

Another style, of bolder face, condensed, and with serifs so short and pointed that it might be classified among gothics, is also known as runic.

**THIS IS RUNIC OF BOLDER FACE
condensed, with lower-case sorts**

The square form of the runic style is usually known by the name of latin.

Other styles of antique are provided by founders, but most of them have peculiarities too trivial to require special illustration. The modern antique, which is but slightly condensed, with a pointed and strongly bracketed or club-footed serif, is perhaps the one with most individuality. The latin, on the contrary, is slightly expanded, and has serifs even shorter and feebler than those of roman—so short that it might fairly be called a variety of gothic.

Other forms of antique, such as geometric, tuscan, concave,¹ etc., and indeed all forms with very strong mannerisms or of eccentric shape, need no

BOOKS AND FURNITURE.

Books are not made for furniture, but nothing else so beautifully furnishes a house. Give us the home furnished with books rather than with furniture. Both if you can, but books at any rate. *Beecher.*

Latin antique.

illustration here, for they cannot be regarded as plain types. They are never selected by printers of good taste for use in standard books, and they are rarely allowed in advertisements. Antiques of small size, of plain form, and of not too bold face, are occasionally selected for texts.

Many varieties of antique condensed are made. The earlier and bolder styles, with flat or unbrack-

¹ It may be necessary to repeat here the caution given on a previous page, that the same name is not always given to the same face or cut of letter. What one founder names celtic, another calls romanesque; one calls caledonian what another calls ionic.

Sometimes the same face has a different name given to it by each of three or more founders. While the names here given are not universally accepted, they are believed to be those most frequently used for the respective styles.

eted serifs, and with kerned descenders, are now used only in the form of capitals and figures:

ANTIQUE CONDENSED, OF OLD FORM
with square and clean-angled serifs

No. 11, on pica body.

CONDENSED ANTIQUE OF CAPITALS ONLY

No. 12, on pica body.

A LIGHT ANTIQUE CONDENSED
of a larger and more open face

No. 13, on pica body.

Antique condensed.

The Cushing antique is a moderately condensed form of the old-style antique character. Unlike

HORSES FIRST, BOOKS LAST.

I say first that we have despised literature. What do we, as a nation, care about our books? How much do you think we spend altogether on our libraries, public or private, as compared with what we spend on horses?

Ruskin.

Cushing old-style antique on pica body.

other series of display letter, the Cushing style has been cut for all bodies, including the so-called irregular bodies of agate, minion, bourgeois, and small-pica. This nicer graduation of sizes augments its usefulness in books for which many sizes of text and of display letter are needed.¹

**THE BASKERVILLE, OR THE LATIN CONDENSED, is
a most useful letter : bold, black, condensed, readable**

No. 14, on pica body.

A more useful letter for side headings or for bold display in the text is a slightly condensed antique of the old form, with flat, unbracketed serifs, of close set and marked compactness.

THIS ANTIQUE CONDENSED is a valuable display type, often used FOR THE SIDE HEADINGS of catalogues and for other emphatic words in a text

No. 15, on brevier body.

¹ Display letter is rarely made for the irregular bodies of agate, minion, bourgeois, and small-pica. But there are many books in text-types of irregular bodies for which it is necessary to use a display letter, like antique, title, or gothic, in the text or as side headings. To do this the compositor has to justify the smaller regular body in the text with thin leads or cardboard. It is always done at extra expense and with bad effect.

PLATEN PRINTING MACHINE. A press that gives instantaneous flat impression on every part of the sheet by one movement of the platen. Many forms are in use. **The Adams Printing Machine** of large size is designed for book-work. **The Gordon**, the **Universal**, and the **Kidder** are of small size, made for job printing.

No. 16, on brevier body.

Clarendon, a popular variety of condensed antique, was first made for the Clarendon Press of Oxford, to serve as a display letter in a mass of text-type, and for side headings in dictionaries or books of reference. Its clearness in the smaller sizes is seriously diminished by the unnecessary boldness of its bracketed serif or turned-in corner.

A BOLD-FACED CLARENDON
with strong bracketed serifs

No. 17, on pica body.

THIS IS CONDENSED CLARENDON
of lighter face and with square angles

No. 18, on pica body.

The lighter and more condensed variety has no descending kerns, but is not as popular.

Extra condensed antiques of thick, medium, and thin faces are made by many founders.

Grecian may be regarded as one of the many varieties of the antique style. In 1840 it was a popular face, but it is now almost out of use. Its

ANTIQUE EXTRA CONDENSED, VERY LIGHT FACE
made on brevier, long-primer, pica, and larger bodies

No. 19, on pica body.

THIS LIGHT FACE OF CAPITALS ONLY

No. 20, on great-primer body.

THIS GRECIAN TYPE IS MADE ON EIGHT BODIES

No. 21, on great-primer body.

marked peculiarity is the angling of those parts of lines that are usually made with curves. It has a lower-case alphabet only in the larger sizes.

Antique italics of the old-fashioned black-face still have a place in some specimen books, but they are out of style. A new form of light-face with lower-case alphabet is a pleasing type.

ANTIQUE ITALIC
one of the oldest forms

No. 22, on pica body.

Antique extended bears expansion without loss of legibility much better than the expanded roman.

**EXTENDED
lower-case**

No. 23, on pica body.

Italian may be classified as a variety of antique. It is a fat-faced roman with transposed stem and hair-line. "To be hated, it needs but to be seen."¹

OLD ITALIAN FACE

No. 24, on pica body.

MODERN ITALIAN CONDENSED
has nine sizes, nonpareil to canon

No. 25, on pica body.

ITALIAN ANTIQUE
provided with lower-case

No. 26, on pica body.

¹ "Oh! sacred shades of Moxon and Van Dijke, of Baskerville and Bodoni! what would ye have said of the typographic *monstrosities* here exhibited, which Fashion in our age has produced?

And those who follow, as many years hence as you have preceded us, to what age or beings will they ascribe the marks here exhibited as a specimen?" Hansard, "Typographia," p. 618.

Italian condensed is a more readable letter, for the so-called hair-lines have ample thickness. The thickening of the face is given mainly to the top and the bottom lines.

Italian antique is of similar design, but it is slightly expanded and of bolder face.

The antique style of type is frequently used in place of roman by job printers, who find it more effective for display work, and especially for single lines that are printed in bolder face colored ink. The weakness of our present fashions of roman is most painfully illustrated when roman types are printed in a scarlet red or an ultramarine blue. The modern method of printing on dry polished paper, too often with weak impression and deficient ink, makes the print hard to read, even when the ink selected is black.

DR. JAVAL ON THE EVOLUTION OF TYPOGRAPHY. There are five important methods of increasing the quantity of matter contained in a page of prescribed size, viz. : 1, to take out the leads; 2, to give a closer set to each letter; 3, to compress or condense each letter so that more letters will come in one line; 4, to put the letters on a smaller body; 5, to cut down the height of long letters and put all on a smaller body. . . . The form of type shown in this paragraph seems to approach the conditions we have named [readability with compactness] more closely than any other type in regular use by the printing trade. When types shall be made to conform still more closely to these conditions they will be well fitted for readable impressions.

No. 27, on corps 5.

French publishers and authors who have satisfactorily made use of celtics and runics for title-pages in red ink have been gradually led to try the effect of a light-faced antique for the text

of small pages, which are always difficult to read when printed upon dry calendered paper in a roman letter of six points or smaller. The illustration on the preceding page is one of a series which is commended by Dr. Javal as a most readable cut of small text-type. It has been used with good results by French publishers for little books of poems in *éditions de luxe*, for this corps 5 is decidedly more readable than ordinary roman on corps 7. Although an improvement, the new face is not beyond criticism: the wide set given to each character does not make the composition more readable. This style is made by the Turlot Foundry on many larger bodies. The monotone shown on a previous page is not quite as distinct, but its lower-case letters are more pleasing to American readers.





XIII

The Classes and Prices of Printing-types



ALL type-founders agree upon the propriety of different prices for the leading classes of roman, display, and ornamental. The line of separation is not fully indicated by their titles. In the class of roman are included italic and the fraktur of the Germans; in the class of plain display are put antique, gothic, celtic, title, and every style of plain face made for display; in the class of ornamental are put decorated letters, black-letter and ornamented text, and all the simpler styles of script and secretary. There are other varieties of type not included in these classes: Greek, Hebrew, and all Orientals; music, accents, signs, superior and inferior references; piece fractions, space rules, and all strange types that require for

The three
classes of
types

the quantities made, a disproportionate expenditure for punches and matrices, are necessarily sold at special and irregular rates.

The rates made for the different sizes represent differences in the value of labor more than of metal. To make a pound of type requires only two or three letters of the larger, but sometimes two or three thousand of the smaller sizes. As each type has to be separately cast and finished, the value of the labor put on the smaller type is greater. The metal in small type is harder and costs more than that in large type, but its value in any size is always less than that of labor. Old type, when bartered for new, is sometimes allowed for at a special rate; when sold for cash, the price allowed never exceeds that of waste lead, and is often less. New type-metal, as sold in pigs by the smelter, varies with the market prices of its constituents, but is always worth more than the metal of old type, which always has much dross.

Fluctuations in the cost of metal often make corresponding changes in the prices of types, but prices have been more affected by improvements in machinery, which invariably reduce the rates. When types were made by hand, as in the first quarter of this century, they were of high price; since they have been made entirely by machine they are furnished at lower rates than were ever known before.

Price List of the American Type Founders Co.¹

| Bodies. | Roman and italic. | Plain display. | Orna- mental display. |
|--|-------------------------|-------------------|-----------------------------|
| Diamond, or 4½-point, per lb. | \$1.20 | . . | . . . |
| Pearl, or 5-point | .90 | . . | . . . |
| Agate, or 5½-point | .52 | .90 | \$2.40 |
| Nonpareil, or 6-point | .45 | .76 | 2.00 |
| Minion, or 7-point | .40 | .66 | 1.80 |
| Brevier, or 8-point | .37 | .62 | 1.60 |
| Bourgeois, or 9-point | .34 | .56 | 1.44 |
| Long-primer, or 10-point | .32 | .52 | 1.30 |
| Small-pica, or 11-point | .31 | .48 | 1.20 |
| Pica, or 12-point | .30 | .46 | 1.16 |
| English, or 14-point | .30 | .44 | 1.12 |
| Columbian, or 16-point | .30 | .42 | 1.06 |
| Great-primer, or 18-point | .30 | .60 | 1.00 |
| Paragon, or 20-point | .30 | .60 | .94 |
| Double small-pica, or 22-point | .30 | .56 | .90 |
| Double pica, or 24-point | .30 | .56 | .90 |
| Double english, or 28-point | .30 | .56 | .86 |
| Double columbian, 32-point | .30 | .56 | .86 |
| Double great-primer, 36-point | .30 | .56 | .82 |
| Double paragon, or 40-point | .30 | .54 | .78 |
| Meridian, or 44-point | .30 | .54 | .78 |
| Canon, or 48-point | .30 | .54 | .72 |
| Five-line pica, or 60-point | .30 | .52 | .64 |

¹ Adopted March, 1893.

These prices are subject to discount, which will vary with fluctuations in the price of labor and metals. The discount in April, 1900, is ^{Discounts} ten per cent. on regular fonts of job type, body type, quadrats, borders, and ornaments; for prompt payment, five per cent. more.

The table rates for roman and italic are for fonts that weigh not less than fifty pounds.

Sorts, or additions to a font, when ordered in reasonable quantities, are usually furnished by American foundry at the same rate as the original font. When ordered in small quantities the rate may be higher. Single lines or letters are always at a higher rate.

Although roman and italic are sold at the lowest rates, the cost of their punches and matrices is greater than that of the punches for ^{Cost of} plain display or ornamental. A full font punches of roman and italic, including accents and signs, requires the cutting of about two hundred and forty punches, and the making of as many matrices, at a cost of about \$1200. Ornamental types may require more labor for each punch, but the total number of punches in a font of this class is always small, rarely exceeding seventy-five characters. The punches for roman type are or should be cut on steel; those made for the larger types are more cheaply cut on type-metal, from which electrotype matrices are made. Steel punches for roman and italic will cost more in the beginning,

but this expense, large as it may seem, becomes a small fraction of the entire cost when the punches serve for the casting of many hundreds of thousands of pounds.

Plain display types are rarely sold in large quantities; fonts of ten and twenty pounds are Sizes of fonts in greatest request. Some fonts on small bodies do not weigh two pounds. Limited sales, and the relatively greater labor that has to be given to the casting, division, preparation, and packing of small fonts, are the reasons given for their greater cost. Ornamental types, required chiefly for occasional lines of display, and always sold in small fonts, have but a brief popularity. As they cost more to produce, and soon go out of fashion, the rate is necessarily high.

The rates for roman and italic in the price-list of English printing types are for fonts of one English methods hundred and twenty pounds and more. Small fonts are at higher rates. Sorts ordered within three months from the time of the delivery of the original font are at regular rates; if ordered afterward at a special higher rate. Quadrats are the only exception; when ordered as sorts they are furnished at lower prices than letters. A discount of ten per cent. from these rates is often given for cash payment.

The bodies of English types differ from those of American foundries (see the table on page 158 of this work). In height English types differ inap-

Price List of English and Scotch Type-founders.¹

| Bodies. | Roman and italic. | Plain display. | Orna- mental display. |
|---------------------------------|-------------------------|-------------------|-----------------------------|
| | <i>s. d.</i> | <i>s. d.</i> | <i>s. d.</i> |
| Diamond, per lb. | 6 0 | 8 0 | 8 6 |
| Pearl | 3 6 | 5 0 | 8 0 |
| Ruby | 2 8 | 4 6 | 7 6 |
| Nonpareil | 2 4 | 3 3 | 6 6 |
| Emerald | 2 0 | 3 0 | 6 4 |
| Minion | 1 7 | 2 4 | 6 0 |
| Brevier | 1 6 | 2 2 | 5 9 |
| Bourgeois | 1 5 | 2 0 | 5 6 |
| Long-primer | 1 3 | 1 10 | 5 0 |
| Small-pica | 1 2 | 1 8 | 4 9 |
| Pica | 1 1 | 1 6 | 4 0 |
| English | 1 0 | 1 4 | 3 9 |
| Great-primer | 1 0 | 1 2 | 3 0 |
| Paragon | . . | . . | . . |
| Two-line pica | 1 0 | 1 2 | 3 0 |
| Two-line english | 1 0 | 1 1 | 2 0 |
| Two-line great-primer | 1 0 | 1 1 | 2 0 |
| Four-line pica | 11 | 1 0 | 2 0 |
| Canon | 11 | 1 0 | 2 0 |
| Five-line pica | 11 | 1 0 | 2 0 |
| Six-line pica | 9 | 9 | 2 0 |
| Seven-line pica | 9 | 9 | 2 0 |

¹ From the specimen books of Reed's Sons of London, and Miller & Richard of Edinburgh. H. W. Caslon & Co. and Sir Chas.

preciably from the American; they can be used together in the same line. The rates for small bodies and ornamental letter are relatively higher in England than in America.

The rates of French and German types are by the kilogram, which is about two and one-fifth (2.2055) American pounds. French and German

*Price List of French Types.*¹

| Bodies. | Ordinary romans. | Plain display. | Scripts and ornamentals. |
|----------------|------------------|----------------|--------------------------|
| | <i>francs.</i> | <i>francs.</i> | <i>francs.</i> |
| Corps 6, kilo. | 8.00 | 12.00 | . . . |
| Corps 7 . . | 6.00 | 11.00 | . . . |
| Corps 8 . . | 5.50 | 10.00 | 30.00 |
| Corps 9 . . | 5.00 | 9.00 | . . . |
| Corps 10 . . | 4.50 | 8.00 | 18.00 |
| Corps 11 . . | 4.25 | 7.50 | 16.00 |
| Corps 12 . . | 4.00 | 7.25 | 14.00 |
| Corps 14 . . | 3.75 | 7.00 | 13.50 |
| Corps 16 . . | 3.50 | 7.00 | 13.00 |
| Corps 18 . . | 3.00 | 6.75 | 12.00 |
| Corps 20 . . | 3.00 | 6.50 | 11.00 |
| Corps 24 . . | 2.90 | 6.00 | 10.00 |
| Corps 28 . . | 2.90 | 6.00 | 9.50 |
| Corps 36 . . | 2.80 | 5.50 | 9.00 |
| Corps 40 . . | 2.80 | 5.00 | 8.00 |
| Corps 48 . . | 2.70 | 5.00 | 8.00 |

¹Compiled from the specimen book of the Turlot Foundry, Paris.

types are of variable height, but are always higher than the American or English. Russian types are more than one inch high. These higher types cannot be used in the same form with American types until the bodies have been cut down at their feet, but this cutting down is rarely done with proper accuracy. Impressions from cut-down types of foreign manufacture always show uneven height and usually make unsatisfactory plates.

*Price List of German Types.*¹

| Bodies. | Roman and fraktur. | Plain display. | Scripts and ornamentals. |
|-----------------|-----------------------|-------------------|-----------------------------|
| | <i>marks.</i> | <i>marks.</i> | <i>marks.</i> |
| Perl, per kilo. | 6.35 | . . | . . |
| Nonpareille . | 4.80 | 8.20 | . . |
| Colonel . . . | 4.08 | . . | . . |
| Petit | 3.18 | 6.20 | 14.00 |
| Bourgeois . . | 2.88 | 6.00 | . . |
| Corpus | 2.58 | 6.00 | 13.00 |
| Cicero | 2.40 | 6.00 | 13.00 |
| Mittel | 3.00 | 5.40 | 12.00 |
| Tertia | 2.90 | 5.20 | 11.00 |
| Text | 2.90 | 4.80 | 10.00 |
| Doppelmittel | 2.90 | 4.60 | 9.00 |
| Kanon I | 2.90 | 4.20 | 8.00 |
| Kanon II . . . | 2.90 | 4.00 | 8.00 |

¹ Compiled from the price-lists of Bauer & Co. of Stuttgart, and Julius Klinkhardt of Leipsic.

The French franc may be rated at 19.3 cents.
The German mark may be rated at 23.8 cents.

The duty levied by the United States Custom House on all importations of type is twenty-five per cent. on the cost as stated in the invoice. When the bill amounts to one hundred dollars or more, the exporter is required to make affidavit before a United States consul as to its correctness. The prices of European types do not tempt American buyers to purchase. Importations of French and German types are practically prohibited by the duty as well as by the delay and cost of transportation, and the damage inflicted on type by cutting down the bodies to the American height.



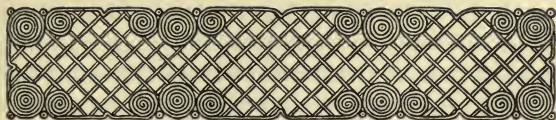

XIV

Large Types Wood Types The Pantograph
Benton's Punch-cutting Machine

LARGE types were sparingly used in old times: they were difficult to cast, and they could not be effectively printed when cast, for the hand-press then in use could not produce the power needed for full impression. The making of large types had to wait for the general adoption of iron hand-presses and cylinder printing-machines.

To make the larger types required, type-founders revived the disused process of casting in sand-moulds. Types made by this process were heavy, expensive, and liable to injury. It was difficult to keep the metal sufficiently fluid: to prevent unequal cooling the caster often had to put a red-hot iron in the core. The unequal cooling of the metal often made the face of the type

concave. The greatest objection to them was their cost. A ten-line antique M would weigh a pound, and the cost of the metal and labor in a type of this size, at rates then prevailing, was forty cents. The price was practically prohibitory.

To save metal, which increased the cost, a new method of casting large types upon high arches was adopted. This economy was pushed on arches too far; types with slender arches often broke in locking-up. The art of stereotyping was then applied. The faces were cast in plates, and these plates were mounted, sometimes on metal and sometimes on wood bodies, but stereotyping did not prove as economical as had been expected. The value of the metal used was less; that of the labor more. After continued failure the manufacturers of large types abandoned metal for the larger sizes.

Not many woods are suitable. Wood for types should be free from knots or cracks, and should have a compact grain or fiber, yet be easy to cut. Mahogany is preferred for its hardness, but it is too porous and has to be "filled." Maple, pear, apple, and cherry are the woods that combine the most good qualities. For types twelve or more inches tall, pine in the form of boards, with the fiber of the wood parallel with the surface plane of the impression, is selected for its cheapness and its easy-working qualities, but it is soft and liable to warp.

The wood types first made in the United States were drawn by the printers who needed them and afterward cut by carpenters. Darius Wells, a printer of New York city, who had a local reputation for good drawing of letters, abandoned printing in 1827, and gave exclusive attention to the manufacture of wood type. At that time it was the usual practice to draw and cut on the flat board. Wells was the first to follow the practice of engravers on wood, by using blocks that had been cut in sections across the fibers. The work of preparing blocks was done entirely by hand; the tools most used were the ordinary saw and slide-plane. Model letters were drawn for all the characters on cardboard, which was then neatly cut to serve for patterns. When the outline of the patterns had been traced by pencil on the surface of the block, a graver was used to cut a wide furrow near the penciled line. This done, the counters and shoulders were cut away by chisels and gouges. Finishing was done with graters and fine files.

Processes
tried by
D. Wells

To abridge the tedious labor of cutting away the counters and shoulders Wells made use of a simple tool which he called the "router." It was a flat-faced and half-round steel bit, made to rotate by steam power at high speed. The bit, suspended vertically over the wood to be cut, had attachments for raising or depressing it at will. The block of wood to be made into a type was

firmly fastened under the router; then the operator, after applying the power, moved the cutter spindle until every part of the counter and shoulder was thoroughly removed.

Other machinery was gradually introduced. Sheet-brass patterns were used instead of cards. Then came cast-brass patterns, with elevated edges which, when pressed in the wood, both marked and engraved the outlines of each type. Improved circular saws and accurately adjusted planing-tools soon followed. More care was also given to the selection and seasoning of the wood. Made by these tools, wood types were preferred to metal types, not merely because they were cheaper but for their lightness and convenience.

In 1834 William Leavenworth of Allentown, New Jersey, adapted the pantograph to the manufacture of wood type. This machine ^{utility of} ~~pantograph~~ made unnecessary all hand-drawings of the letter on the wood. From one set of models attached to the pantograph an unskilled workman could cut on untraced wood various sizes from two-line pica upward, and every size would be a faithful reproduction of the model. The pantograph is a strongly jointed and adjustable open framework of wrought iron and steel, rhomboidal as to shape. When put to work, it is suspended about eight inches over a flat metal table. It has five short projections extending toward this table; some of them are the extreme

angles of the framework. Two of these four projections at opposite extremities reach the table, and serve as rests to steady the action of the machine. One of the four projections is a guiding-rod, or feeler, which follows the outline of the

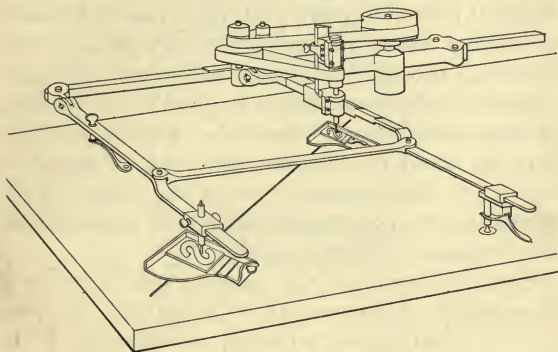

The pantograph for wood type.

pattern letter beneath it (which is practically an enlarged type in high relief), and accurately communicates every deviation of motion in a reduced proportion to the router. The fifth projection is near the center of the framework, and carries the router, which is suspended over the block to be cut, and can be raised or lowered at will. The router, driven by steam, rotates at unusual speed: fourteen thousand revolutions a minute is a common rate. Each movement of the operator's hand

in guiding the index around the pattern letter is followed by a corresponding exactness of movement in the router that cuts the block. The type is often made in as short a time as one could trace the outlines of the pattern by pencil, and it is cut more accurately than a type made by hand. When it leaves the pantograph it is nearly finished; an exacter angling of the corners by the graver is nearly all the additional work required. The pantograph is also successfully applied to the making of large borders and ornaments. Letters and borders as small as two-line pica can be made on wood, but these smaller bodies can claim no superiority over corresponding sizes in metal, either in cheapness or convenience.

Some features of the pantograph have been successfully incorporated in a machine for the cutting of punches, invented by L. B. Benton of Milwaukee. The process of making the letters that serve for the models on the Benton machine begins with a pencil sketch on paper of letters twelve inches high. The drawing is reproduced by the pantograph, but it reappears in the form of a model letter, three inches high, with raised outlines on a metal plate that has been covered with wax. From this wax reproduction an electrotype is taken, which serves as a model for the operator. By a proper adjustment of the leverage (the mechanism for which is too small to be repre-

Methods
used on
the Benton
machine

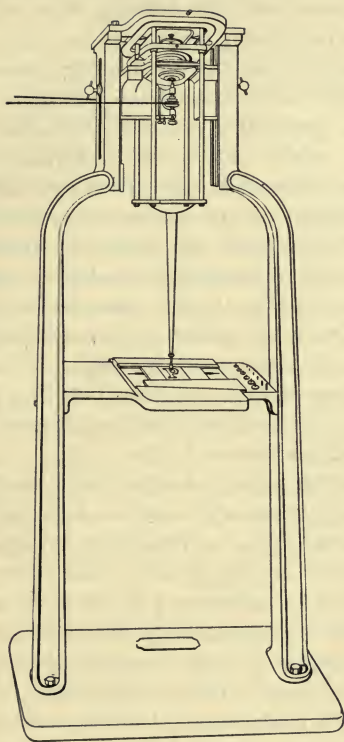

The Benton punch-cutting machine.
Height, 5 feet 4 inches; floor space, 22 x 28 inches.

sented in the illustration), the model letter can be made to serve for the cutting of any body from two-point to seventy-two point.¹

In this machine the electrotyped letter that is accepted as the model of the punch to be cut is firmly fixed on the lower platform over which the movable index or guide is vertically suspended. The four rods attached to the head-plate of this index are connected with gimbals that give to the guide the greatest flexibility with the greatest accuracy of movement. The punch to be cut (also too small to be shown in the drawing) is placed on the small table near the head of the connecting rods. The cutting tools are exceedingly minute, but they are made with the nicest accuracy, and are rotated at high speed by steam power.

The direction given to the index at the will of the operator around the outlines and interior lines of the model letter is faithfully repeated by the cutting tools on the punch. The punches produced by the machine are finished in all points and require no supplemental hand-work. The cutting is necessarily more accurate than that done entirely by hand; the counters are deeper, the bevels truer, and always of uniform slope. When

¹ The facsimile of a signature, consisting of two initials and six lower-case letters, was cut in a script so small that it could not be distinguished without the aid

of a powerful magnifying glass. The total length of the signature did not exceed the thickness of two sheets of writing paper.—“*Inland Printer*,” vol. xii, p. 238.

care has been taken to trim the model letters to correct line and position, the punch will also be cut in corresponding line and position.

The machines for shaping and sharpening the cutting tools, also invented by Mr. Benton, will produce tools of any angle. They are Accuracy of the cutters so constructed that each tool is sharpened with its point in the center of its rotation without removal from its original position.

The inventor claims, and the claim is not disputed, that punches completed by this machine produce matrices that are more readily fitted up and justified than those cut by hand. Models for accents, fractions, and borders can be made in sections, and accurately conjoined in proper position before the cutting of the punch. The punches for accents are always truly flat on the face, and all kinds of kerns can be provided with proper supports. The success of the Linotype (type-making and type-composing) machine is largely due to the accuracy of the matrices made from Benton machine punches. As the counters are deeper and the bevels truer, the types do not show distortion when they have been flattened by wear.

Some type-setting machines recently invented owe their utility to new processes for making types. In many of them the type-set- Automatic type-casters ting apparatus is so closely connected with that of type-making as to make it impracticable to give a clear description of one without

the other. A sketch of the type-making apparatus is all that can be given here.

Mechanical type-setting was long delayed and often entirely defeated by difficulties encountered in the distribution and reuse of the composed types. Most inventors found it expedient to invent a special machine for distribution as a necessary adjunct to the type-setter. In the Mergenthaler Linotype machine this difficulty was overcome by the construction of an apparatus which cast composed types together in the form of solid lines, and made distribution as impossible as it was unnecessary; for the new method promised to make it cheaper to use new types than to distribute and reuse old types. This machine, which assembles, spaces, justifies, and casts the letters needed in composition, is too complex for a detailed description in a treatise on types only, and not on their composition. The following outline of the type-making apparatus is that of the manufacturers.

The Mergenthaler Linotype machine has for its fundamental element about fifteen hundred brass matrices, which respond to the operator's touch upon the keyboard, and thus create the type-matter ready for use. These matrices consist of small, flat plates, having in one edge a female letter, and in the upper end a series of teeth, for distributing purposes. There are in the machine a number of matrices for each letter, also for special characters, and for spaces and quads of definite

thicknesses. Used in connection with the matrices are elongated wedge-shaped spaces, which are inserted between the words.

The machine casts metal slugs, type-high, having upon their upper edge type-characters to print a line. These slugs present the appearance of composed lines of type, and for this reason are called "Linotypes." The machine is so constructed that on manipulating the keyboard it will select matrices in the order in which they are to appear in print, and assemble them in a line with the wedge-shaped spaces.

This line of female type is adapted to produce raised type upon a slug, after which they are returned to the magazine to be again composed in new relations for succeeding lines. The magazine is in an inclined position, and contains channels in which the matrices for any face may be stored, and through which they pass. Each channel is connected with a finger key, representing the character it contains. When a key is depressed, a matrix, or a space, falls upon an inclined travelling belt which carries it into the assembler. This is continued until the assembler contains sufficient characters to represent one line of print. It is then transferred to a mould extending through the mould wheel. The mould is of the exact size of the slug required. The assembled matrix line closes the front of the mould, and the faces of the matrices are brought in line with it. At this point the wedge-shaped spaces are pushed further through the line, and exact spacing and justification are secured. In the rear of the mould is a melting-pot, heated by gas or gasoline, containing molten metal. The pot has a mouthpiece arranged to close the rear of the mould, and contains a pump. While

the matrix line is in position the pump forces the metal into the mould, against and into the female characters of the matrix line. The metal instantly solidifies, regardless of the length or thickness of the slug. The mould wheel then makes a partial revolution, bringing the mould in front of an ejector blade, which pushes the slug out of the mould into a receiving galley, ready for the proof-press.

To insure absolute accuracy in the height and thickness of the slugs knives are arranged to act upon them during their course to the galley. The line of matrices is then lifted from the mould to the distributor bar at the top of the machine, the wedge-shaped spaces being left behind and shifted into the receptacle from which they were discharged.

The ribs of the distributor bar are cut away at different points, thus making a special arrangement over the mouth of each channel. The matrices are pushed upon the bar at its end and made to move slowly along until each one arrives at a point where its teeth bear such relation to the ribs that it disengages and falls into its proper channel, there to remain until all the preceding matrices, bearing the same character, have performed the same duty, when it again makes the circuit.

This circulation permits the operations of composing one line, casting a second, and distributing a third to be carried on concurrently, and enables the machine to run at a speed exceeding that at which any operator can finger the keys. It also makes it unnecessary to have more than three or four matrices of any special sort that may be required, such as accents and other arbitrary characters.

The Lanston Monotype is a machine that makes and sets single types. To use it, copy must be previously prepared on a distinct machine, The Lanston not unlike a type-writer in size and appearance, which punches holes, as directed by the operator, in a narrow strip of rolled paper. The punched holes, like those required for the Jacquard loom, serve as guides for the operations of type-casting and type-setting. As this roll of paper is unwound in the larger machine the punched holes direct the presentation of the proper matrix to the mould. In this mould melted metal is injected, and perfected types are produced at the rapid rate of one hundred and fifty or more a minute. The punching of the holes requires a skilled operator, but the additional operations of casting, setting, and justifying the types are purely automatic. The manufacturers claim that the types so made are fully equal to those made by the older method, and that they can be used again, if required, in subsequent composition by hand, but it is cheaper to make new types than to reuse the old.

There are other machines, still in process of development, but not yet doing practical work, that have been devised for mechanical composition. In one, movable matrices are arranged over a bar of cold metal, and the letters are swaged by pressure. In another, types are cast in little cubes and then securely fastened on a previously prepared bar or line of metal. In another, the type-casting

machine supplies the magazine of the conjoined but distinct type-setter with a regular supply of types.

Considering the many unexpected improvements that have been made in this century, it is hazardous to assume that there can be no more Permanence of the old improvement in type-making; but it is not at all probable that the older methods of type-making will fall into entire disuse. There is and always will be a vast amount of type-setting that must be done from single types and by hand composition. New faces that are always in limited request, and on bodies smaller than agate or larger than pica, will be made by the older casting machine, which holds a position not unlike that of the hand-press; for although cylinder-presses now do nearly all the printing of the world, there are more hand-presses made, sold, and used than ever.





XV

The Quaint Styles of Plain Type

MORE attention has been given to the production of quaint styles of text-type during the last decade of this century than the subject ever received during any similar period. The old craving for highly ornamented letters seems to be dead; it receives no encouragement from type-founders. Printers have been surfeited with ornamented letters that did not ornament and did degrade composition, and that have been found, after many years of use, frail, expensive, and not attractive to buyers. They listen with more respect to the teachings of men who hold that the proper function of types is to convey instruction, and that they are not improved by decoration, any more than a trowel is by painting or a saw by gilding.

More changes have been made in the direction of eccentricity than in that of simplicity. Fantastic letters were never in greater request, but they rarely appear as types in books. To see the wildest freaks of fancy one must seek them not in the specimen books of type-founders, but in the photo-engraved lettering made for displayed advertisements and tradesmen's pamphlets. In a treatise on printing-types further remark on engraved lettering is not needed.

Although there is a demand for quaintness in decorative printing, readers object to any serious departure from the accepted standards of form. For the types of serious books roman letter has been made fat or thin, round or angled, weak or bold, by type-founders of all countries, but vagueness in any character has never been tolerated. The few improvements that have conquered stubborn prejudices met with opposition when they were introduced. Benjamin Franklin, famous as an innovator in many matters, lamented the disuse of italic and of capital letters for the nouns in a text. He pointedly decried the new fashion of substituting the short final s for the long f at the beginning or in the middle of a word. An English bishop compelled the reprinting, to the printer's loss, of his sermon in which the long f had been supplanted by the short s. The writer of this chapter had a similar experience with an author who wanted old-style letter, but refused to accept

the pinched *s* of a Caslon old-style, because it was too narrow to please him. Strong objection was made to truly lined arabic figures; the old form of figure, unequal in height and out of line, was preferred. The present form of & was resisted as inferior to &°. To this day the doubled letters *fi*, *ff*, *fl*, *ffi*, *ffl*, *æ*, *œ* continue to be made by type-founders, when there is no need for these unsightly combinations.

It is the belief of most readers that the great merit of typography is in the unvarying uniformity of every character. On the contrary, it is held by some artists that roman types as now made are too uniform and too monotonous, too "typy," and altogether inartistic. William Morris is reported as saying in 1890 that no good book printing had been done since the middle of the sixteenth century, and that the degradation of the art is largely due to mean types. To reform typography we need better types; we must be more tolerant of quaintness, and must attempt the revival of mediæval methods. It was this conviction that impelled him to design the new form which he called the Golden type, shown on page 207 of this book. It was not his favorite, for he confessed his aversion to classic, and his leaning to Teutonic forms of letters. Not entirely content with his first experiment, he decided that the next should be a new form of black-letter. It was a difficult task, for invention seemed to have been exhausted in the

many varieties of black-letter previously shown by type-founders. He saw that it was impracticable to graft his notions of good form on the condensed fractur of the Germans, or on the angular and equally thin Old English or pointed black-letter. The broad-faced round gothic of the early printers of Germany was accepted as more available, but he made his new Troy type much wider, bolder, and blacker. Most of his lower-case characters, quaint as they may seem, are unexceptionable as to simplicity. In his capital letters he was not as successful: his forms of **O, C, M, N** are practically roman; but his **S, L, V, v, f** are not gothic, nor good mates for the lower-case. A line of capitals in Troy type is not pleasing. Morris made a readable lower-case, but the greater breadth given to all letters for the sake of greater blackness made the spacing of words in a composition of type unusually difficult. To fill the unsightly gaps that were unavoidable, but inconsistent with his notions of thin spacing, he designed the unmeaning and often displeasing bits of ornamentation that appear in the illustration. The Troy type appears to best advantage in the Kelmscott books, for it is there always in harmony with the subject-matter. Morris went too far in the exposition of his theories, but the reading world is indebted to him for his demonstration of the merit of a really masculine style. He has shown as no one ever did before that typography need not imitate photography, lithography, or copperplate.

☞THE TROY TYPE of the Kelmscott Press was designed by William Morris and cut by Emery Walker on the body of great-primer. It was first used in printing the book "The Recuyell of the Historyes of Troye," dated 14th October, 1892. ☞The Chaucer type is a similar face upon a pica body. This Troy type was the model of the type on this page, which is made in the United States by the American Type Founders Co. on many bodies from 6-point to 72-point. ☞It is a composite letter—so made by adding gothic mannerisms to a fat-faced and angled roman.

18-point body.

The Jenson type is the American adaptation of the Golden type. Although the specimen here shown is on a similar body of 14-point, the round letters of the lower-case of the Jenson are a little higher, and the body-marks a trifle thicker. This enlargement and thickening, with more closely fitted types, give more blackness to the print and less relief of white between lines of solid composition. The Jenson type has been successfully used in the United States for the composition of large quarto books that are decorated with broad black or colored borders. It is sometimes used with good effect for small books in octavo or duodecimo, but it occupies too much space and is too sombre for the ordinary book. For dainty little books smaller than an 18mo the smaller sizes of this style are well adapted. When leaded they give a clearness to fine print not to be had from any face of ordinary roman letter. The Jenson capitals are often selected for title-pages that call for bold and large letters; but the close fitting of the capitals makes obligatory an unequal spacing of types too closely fitted. The recent addition of an italic letter having all the peculiarities of the Jenson, lining and mating with it, causes it to be preferred by job printers and advertisers for the display of type. It was planned by J. W. Phinney of the old Dickinson Foundry of Boston. It is founded on many bodies from 6-point to 72-point, and is sold by the American Type Founders Company.

NICOLAS JENSON, an engraver of the mint, was sent to Mainz in 1458 by Charles VII, King of France, to get a knowledge of the new art of printing. He went back to Paris in 1461, but it is not probable that he there did any typographic work. In 1471 he printed four books at Venice, and there continued to print until his death in 1481. Pope Sixtus IV gave him the title of Count Palatine for his services to typography. At different times he had as partners in business John of Cologne and John Herbert of Selingenstadt. Strikes from the punches of the Jenson roman, of which Jenson had made one size only, were acquired after his death by Andrew Torresani of Asola, and they were afterward used by his son-in-law Aldus Manutius. Jenson was not the first printer to make roman types, but his face of roman was regarded as better than that of any rival.

14-point body.

American Type Founders Co.

The Fifteenth Century Style was made to supply a demand for a rude form of roman, which is erroneously supposed to be the form of roman first used by the early printers. The larger sizes are most approved; the smaller sizes are somewhat obscured by the compression of unequally proportioned characters. This series fitly illustrates the impracticability of making types in many sizes by geometrical rules, as was recommended by the old theorists in type-making. Large sizes may be compressed with advantage, but small sizes must be expanded to maintain their legibility.

This style seems to be the clever adaptation of an uncouth type used by Windelin of Speyer in his edition of John Duns Scotus, a thick, quarto ($8\frac{1}{4} \times 6\frac{1}{2}$ inches) of 652 pages, printed at Venice about 1475. The mean type of this book is entirely unlike the beautiful large roman type of the *Livy* printed by John and Windelin of Speyer in 1472, and the reader wonders that this degradation in form could have been made in three years. Brown, in his valuable book on the Venetian Printing Press, suggests the explanation. A short experience had demonstrated to printers that books in large types and of folio form cost too much and found few buyers. To meet the preference of Italian printers for roman types and smaller books, Windelin had made for him a new face of roman on pica body and of condensed shape, with intent to put the matter of a folio on a page of quarto.

THE FIRST ROMAN TYPES

about four lines to the inch, were made at Subiaco, near Rome, in the year 1465 by the German printers Sweynheim and Pannartz. It was not a pleasing character, for the letters were rudely cut with thick lines, condensed as to shape, and were too closely fitted. In its lower case it resembled the gothic more than the roman style. In 1467 the same printers made at Rome a new roman, broader as to shape, and with types not so closely fitted, but it was not acceptable to Italian readers. In 1469 John and Windelin of Speyer made a much lighter and rounder style of roman, but the types were too widely fitted. The true standard of form and proportion, of fitting and lining, was shown for the first time by Nicolas Jenson in 1470, and was readily accepted by Ratdolt and Renner of the same city, and the type-founders of all countries. Mongrel romans, or combinations of roman and gothic, were introduced in Germany, but they were not approved and soon went out of fashion. Disproportioned and uncouth shapes of roman, uneven lining and bad type-founding, were not long tolerated in the fifteenth century.

This XVth-century face was devised by Barnhart Brothers & Spindler, of Chicago, in 1896, and is made by them of roman and italic form in many sizes from 8-point to 48-point. To advertisers who intend to give to print an appearance of early rudeness this face is welcome.

12- and 18-point bodies.

Unfortunately, the new type was badly cut and cast. The types were closely fitted and out of line, and many letters seem high-to-paper, making faults in press-work. The letters are disproportioned; every page swarms with contractions and abbreviations. The new style must have been a failure, for I have never seen it in any other book.

The Renner type, which follows, is a fair copy, but not a servile imitation, of the style of type devised by Franz Renner of Venice, and first used by him in his edition of the "Quadragesimale" of 1472. It was made in 1899 for the service of the De Vinne Press, to exemplify the belief of the writer that the legibility of print does not depend so much upon an increase in the blackness or thickness of its stems as on the entire and instant visibility of every line in every character. It was planned in conformity to the rules observed by all the old printers: the short letters occupy about one-third of the body; the ascenders and descenders, equal in length, give the full relief of white space between the lines which contributes so much to easy reading.

Although the types of William Morris have been put aside by publishers as unfitted for the texts of ordinary books, they have exerted a marked influence on the tastes of many readers. They have demonstrated most successfully the importance of a type that gives fitting expression to the subject-matter. Unfortunately, there are readers who do not fully appreciate the value of this harmony

FRANZ RENNER, of Hailbrun, Germany, was the sixth printer of Venice, in which city he practised his art with success between the years 1470 and 1494. In John and Windelin de Speyer and in Nicolas Jenson, who had preceded him, he found rivals of great ability, who were trying to please Italian readers with new faces. Franz Renner was moved to emulation. The model of roman which he selected had marked grace of form, but it was of much lighter face than the types of his predecessors. This preference of the first Italian printers for large roman characters proved a mistake. Not only Jenson, but Renner and other printers of Venice, found it expedient to print the largest number of subsequent books from gothic types of small size, condensed and of very black face. The large roman was wasteful of space, and made books bulky and dear; the gothic was more compact and enabled the printer to put more words on a page. Roman types were not acceptable until they were made small.

14-point body.

The De Vinne Press.

between type and text; and there are printers who do not see how the merit of these peculiar forms of old-style faces is enhanced by Morris's admirable selection of paper, press, and processes of printing. Some attribute the merit of the Kelm-scott letters to their quaintness of design, but more to the largeness of their type and the blackness of the print. They jump to the conclusion that a readable print must be an over-black print, and that the thickening of the stems and the broadening of the form of ordinary roman type, so that it may receive more ink and impression, are all that is needed for readability. This is a serious mistake, but one that has been repeatedly made. As early as the first half of the sixteenth century thick-stemmed roman types, mainly on pica body, were made and used at Paris and Venice. They were fairly tested, but soon went out of fashion. The fat-faces of Thorne in London and of Didot in Paris, introduced in the first quarter of the nineteenth century, had a fair trial, and have been put aside as complete failures. Something more than blackness and fatness is required to produce the highest legibility.

Types need a generous relief of white space, not only within but without each character, to give proper value to their black lines. Every reader sees that a display line in condensed type is not as readable as in types of standard width, and that leaded is always more attractive than solid

type; yet a title-page set entirely in light-faced roman capitals, even when the displayed lines are condensed and the minor lines are in capitals needlessly small, may be readable and inviting. Its legibility and attractiveness are largely produced by the wide blanks between the lines. Take out these blanks and huddle the lines together, and it will be found that the once pleasing composition has been made as repelling as a squeezed advertisement in a daily newspaper. It may seem unnecessary to repeat this platitude, but there is need for its repetition with emphasis. Publishers of newspapers and books are continually demanding types with faces too large for the bodies, and with short ascenders and descenders that seriously contract the narrow lane of white space between lines. Type-founders, trying to meet this demand, sometimes fit types so closely that the white space between two meeting types of m is less than the space between the stems of each individual m. Even William Morris advises that each type be made so that it shall nearly fill its body; that the white space between lines be made small; that leads be used only when unavoidable; and that the spaces between words always be made thin. This counsel is what might have been expected from a printer whose types were too large for the matter of his books, and who, to avoid added expense, was compelled to publish many of them in quarto form and in two or three volumes, and to treat poetry

as prose, when necessity directed, by running verse together in solid paragraphs. It will be admitted that leads and spaces are often used unwisely, to the damage of good printing, but this admission does not invalidate the general experience that print to be most readable must have more of white than of black within the page. Considerations of economy often compel the publisher to make use of large-faced type, to space close and reject leads; but the reader always prefers types that are not huddled and that are easily read.

THE LARGE CAPITALS

IN THIS ILLUSTRATION ARE

EXHIBITS OF A NEW STYLE OF

ROMAN

SUITABLE FOR BOLD TITLE-PAGES

AND FOR PLAIN PRINTING IN

COLORED INKS

Römische Versalien.
Genzsch & Heyse, Hamburg.

To meet the demand for a bolder face of roman type than any then made for strict book-work, Genzsch & Heyse of Hamburg, Germany, have recently produced a full series of the types partially exhibited on the preceding page. The series with lower-case letters is called by these founders *Römische Antiqua*; the series of capital letters only, *Römische Versalien*. This face is much bolder than that of the Caslon or of any other form of old-style. It is not so bold as the De Vinne, but it does not have the eccentric letters of the latter style, which prevent its employment as a text-letter in all books intended to be severely simple as to style. For the title-pages of large quarto or folio books it is admirably adapted. Its broad lines, but not too bold face, enable the pressman to give to it a generous supply of ink. In an office provided with this series the compositor has no temptation to select light-faced antiques, celtics, or runics for the words of a title that are marked for display in red ink. This style is made by the A. D. Farmer & Son Type Founding Company of New York in complete series of capitals and lower-case, graded from 8-point to 72-point, and is sold by them under the name of the Bradford Face. The capitals maintain their merit in all sizes and combinations, but the lower-case of the smaller sizes does not so fully and advantageously show the peculiarities of the style.

THE MACFARLAND FACE of the St. Louis Type Foundry, presented on this page, is cast on many bodies, from 6-point to 72-point. In boldness and simplicity it is a worthy rival of the Römische; but it has some meritorious peculiarities of its own. The Römische, MacFarland, and Fifteenth Century faces appear to best advantage on the larger bodies. The 8-point seems to be, and probably is, a truly proportioned reduction of a very large size, but it does not produce the same effect. It demonstrates the futility of making types by arbitrary geometrical rules.

18-point body.

St. Louis Type Foundry.

Lines that are not too black in the larger sizes seem too black in the smallest size. The relief of white space that is ample in the solid composition of 24-point is too small for a solid composition on the 8-point body. Nor does leading the lines entirely remove the defect.

How the desired uniformity in effect is to be preserved throughout a series of sizes is still a puzzle to all type-founders. A gradual increase in the width of each type, as types decrease in size, is an aid, but it is not enough; and this experiment is always attended with danger, for a slight expansion may seriously alter the peculiarity of the style. The lengthening of ascenders and descenders is another aid; but no one as yet can lay down any rule as to the proper length. The thinning of the stem or body-mark by a small fraction of a millimetre produces improved lightness; but it is another experiment of risk that may destroy the character of the style. All type-founders know that when equal skill and care have been given to the cutting of every size, and proper precautions have been taken to prevent optical illusions, one size will always seem more pleasing than any other. Reductions of type are as disastrous as reductions of drawings. The design that covers one hundred square inches on paper may be entirely pleasing in light and shade and general effect, but it becomes confused and indistinct when reduced to ten square inches.

THE CENTURY FACE was designed to make for the Century Magazine a blacker and more readable type than the thin and gray-printing old-style letter in which it had been printed for many years. The hair-lines of this Century face were made of a perceptible thickness, the serifs were shortened, and the body-marks protracted a trifle. To secure a proper relief of white space within each character the round letters were made a little taller. To proportion the type for a large page in two columns and with narrow margins, and to give the usual amount of text in the Century page, the characters were compressed a trifle. The lower-case alphabet of the modernized old-style on long-primer body, previously used on this magazine, was twelve and a half ems wide; in this face, which is much larger, it is twelve and an eighth ems wide.

Leaded with twelve-to-pica leads.

The changes from old standards, purposely made by the designer, were not of great importance, but most of them were in directions that had been usually avoided by type-makers. The thickened lines enable the pressman to produce print that is really black and not apparently gray, as was unavoidable in press-work on small sizes of modernized old-style. This face was modelled and cut by Mr. L. B. Benton, and is made on the bodies of 10- 9- and 8-point, by the American Type Founders Company. For long lines of poetry printed in duodecimo or in any smaller size, as well as for all compact composition in a narrow measure, this style of face is properly adapted. THESE ARE THE SMALL CAPITALS and *these the italic characters of this font.*

Solid.

THE CENTURY BROAD-FACE was made by the De Vinne Press for service on books to be set in a broad measure, which do not require a compression of letters for the saving of space. It retains the thickened hair-line, the short serif, and all the characteristics of the face described on the previous page. The purpose of the designer was to give to each letter a larger face than is usual in text-types of this body, with as much boldness of line as would be consistent with the greatest legibility. This desired largeness with boldness has been carried to its fullest extreme. It is a readable letter when it is set solid, but it is made more readable when the lines have been separated by a twelve-to-pica lead.

Leaded with twelve-to-pica leads.

Types are not always made more readable by giving them larger and blacker faces. The attractiveness of a very black-faced type when used in one line or in a few lines becomes repelling when it is used in a mass. A page of fat-faced type compels a greater strain on the eye than a page of ordinary book-type. What a reader needs for pleasurable reading is the instant visibility of every stroke in every letter; but this visibility is dimmed when the types have too much black. The strength of the black is weakened when its relief of white is diminished. THESE ARE THE SMALL CAPITALS and *these the italic characters of this font*. The lower-case alphabet of this face is thirteen and one half ems wide.

Solid.

OLD ROMAN is the name given to this entirely new series of text letter, in which most of the good features of the old-style character have been preserved; the hair-lines and body-marks have been thickened, and the serifs have been shortened, but not pointed or bracketed. Increased width has been given to every character, but without producing any appearance of undue expansion or obesity. It is a most readable type, which can be used with perfect propriety in standard books, for which the bold and black faces of many recent styles are not adapted. It is made by H. W. Caslon & Co., of London, on bodies of Pica, Small Pica, Long Primer, Bourgeois, and Brevier. Unlike a great many new styles, it will bear reduction without loss of legibility. The object the founders had in view when producing this series was to secure greater plainness, and, therefore, facility in reading. Hitherto legibility of type faces has been sacrificed to fine lines and hair serifs.

Designed by T. W. Smith for H. W. Caslon & Co., London.

Many of the quaint types recently introduced, and intended to be very black in print, are a disappointment to publishers. In most instances the disappointment comes not from fault in the type, but from faulty methods of printing. The Jenson or Satanick types (or even the old-style antiques now often used as fair substitutes for older styles of text-types) are relatively ineffective when they are printed dry against a hard impression surface upon coarse and rough laid paper made from badly prepared wood-pulp. Under these conditions no art of the printer can give to the print the solidity of color noticeable in all well-printed old books. The grayness of type so treated is not produced, as is sometimes asserted, by machine printing, for a well-made cylinder printing-machine has more strength than any hand-press, and it can ink the types with more evenness. To make sure of old-style results, old-style methods must be used: the paper must be of hard stock and properly dampened, and the impression must be resisted by an elastic blanket. The press-work must not be hurried; ink must be dry upon one side of the sheet before beginning reiteration on the other side.





INDEX

- Accents, not furnished in regular assortment for font, 12, 172, 173
- Adams, Isaac, inventor of Adams printing-press, sketch of, 227
- Adams, Joseph Alexander, American wood-engraver, successful experiments of, in electrotyping woodcuts, 18 (*note*), 219; develops method of overlaying and making-ready woodcuts, 219; four- and six-roller Adams presses first made at his suggestion, 219
- Agate (5½-point), classed as an irregular body, 58; capital and lower-case alphabets of, 60, 61; a favorite size for newspaper advertisements, 67; known in England as ruby, 67; examples of, solid and leaded, 98, 99; advertisements in, 106; standard width of, 114
- Aldine, an approved form of condensed title, 285
- Alost, announcement of John of Westphalia at, 80; types made at, equal to those of France and Italy, 92
- Alphabet, examples of sizes of, in standard types, 60, 61; various widths of, in different types, 114-116; inadequacy of the roman, 235; limits of size for a readable, 259 (see also *note*); simplification of, due to early printers, 293 (see also *note* 1)
- America, type-casting machines in, 26 (*note*); extensive use of stereotyping by publishers in, 40; excelsior, or 3-point, used for music, etc., in, 68; first practical attempt to establish correct proportions of types in, 146-149; Scotch-face first shown in, 213
- American Type Founders Company. See *Type Founders Company, American*
- Amsterdam, notable type-founders at, 92
- Anderson, Alexander, the father of American wood-engraving, notice of, 216
- Andrews, Robert, the successor of Moxon, unsatisfactory work of, 96
- Anglo-black, description and illustration of, 312
- Antimony, a constituent of type-metal, 9, 32 (see also *note*), 33, 35 (*note*)
- Antique, stronger impression necessary for page of, 51, 52; description of, 184; the lighter faces of, used for distinction in some texts, 236; newer styles of, preferred for condensed letters, 266; firm lines of doric, 289; characteristics of, 323; the earliest form of bold display type, 323; examples of, 324; formerly the most popular of display types, 325; example of old-style, 325; remarks upon different styles of, 325, 326; old-style peculiarities attached to, 326; lightest and most open form of, 326; examples of various faces of, 326, 327; other styles of, 327; examples of latin and condensed, 328, 329; remarks upon,

- and example of, the Cushing old-style, 329, 330; examples of, and remarks upon, other styles, 330-334; effective for display and colored work, 334; example of, and remarks upon, No. 27, corps 5, 334, 335; smaller sizes of light-faced, used with good results for little books, 334, 335
- Antwerp, various type-founders employed by Plantin in, 92
- Ascenders, types with long, 49, 50; types with short, 50; their relation to the type body, 58
- Atlas, a bold form of title-type, 289
- Augsburg, early printers of, undertake to furnish small ornamental initials, 83
- Austin, Richard, a noted English punch-cutter, and his successors, 102
- Baine, John, with his grandson, establishes type-foundry at Philadelphia, 102.
- Bamberg Missal of 1481, largest text-types used in, 84
- Barker, Christopher, queen's printer in 1582, report of, on printing, 95
- Barth, Henry, 'invents a complete type-casting machine, 27, 28; illustration and description of his height-to-paper gauge, 153
- Baskerville, John, an eminent English type-founder, biographical sketch of, 99
- Basle old-style, remarks upon, and example of, 198, 199 (see also *note* 1)
- Battery, use of, in electrotyping, 18
- Beard, in types. See *Neck*
- Beaumarchais, Pierre Augustin Caron de, French author, superintends edition of Voltaire in Baskerville types, 99
- Benton, L. B., of Milwaukee, inventor of punch-cutting machine, 350; his machines for shaping and sharpening its cutting tools, 353; superiority claimed for punches completed by his machine, 353
- Berthold, Heinrich, Berlin type-founder, adjusts height of German types to French standard, 131 (see also *note*)
- Bessemer, Anthony, an English inventor and type-founder, 101, 102
- Bewick, Thomas, eminent wood-engraver, sketch of, 206
- Bey, Jacob, establishes a second foundry at Germantown, Pa., 102
- Bible, the, pearl a favorite type for pocket editions of, 67
- Bible of 36 lines, printed from types of double pica body, 74
- Bible of 42 lines, type on paragon body favored by printer of, 63; illuminated at Mentz in 1456, 74; supposed to have been printed by Gutenberg before 1455, 293 (*note* 2); old English black-letter modeled on lower-case letters of, 294 (see also *note* 2)
- Bible-text, great-primer also known as, 63 (*note*); that of Gutenberg the basis of modern black-letter, 91
- Bill, in typography. See *Scheme*
- Binny, Archibald, Scottish type-founder, devises first improvement in hand-casting, 26 (*note*); forms partnership with Ronaldson and establishes type-foundry at Philadelphia, 102, 202; his inventions and successors, 102; receives valuable suggestions from the type-founding tools formerly owned by Franklin, 155 (*note*)
- Black, early English type-founders adhere to the pointed, 300; example of Old English, 300; introduction of the fat-faced, 301; denunciation of fat-faced, by Hansard and Dibdin, 301 (see also *notes*); examples of fat-faced, 301; fat-faced, in favor for many years, 302; fat-faced, not popular in France and Germany, 302; Augustan, 307; remarks upon the light-face and bold-face condensed, 307, 308, 309; example of Augustan, 308; example of bold-face condensed, 309; remarks upon Saxon, 311, 312; remarks upon, and example of, Anglo-black, 312; remarks upon, and examples of, medieval, 313, 314
- Black-letter, Gutenberg's Bible-text the basis of modern, 91; the form of, preferred by early English printers still regarded as best, 93; a degenerate form of roman, 184, 291; beginning of, 291; called gothic by bibliographers, 291 (see also *note*); form approved by copy-

- ists before invention of printing, 291, 292; old fashions of, 292; used as type-name after introduction of roman, 292; obscurity of early forms of manuscript, 293; one of the two styles selected by early printers, 293 (see also *note* 2); remarks upon pointed, 294 (see also *note* 2), 295; pointed form of, commended by Moxon and selected by Pickering, 295, 296; strictly German styles of, not used for book-texts by English publishers, 296, 297; example of, and remarks upon, Flemish style of, 296; designers of early forms of, avoided hair-lines, 302; remarks upon, and example of, French form of, 302, 303; other forms of, devised by German type-founders, 305; remarks upon new fashions of, introduced by American type-founders, 306, 307; the Morris Troy type a new form of, 361; the Bradley style of, 314
- Blades, William, on type-founding in the Netherlands, 92; his review of the types of the Enschédé Foundry, 253 (*note*); on the business relations of Caxton and Mansion, 297 (*note*)
- Blaw, William Jansen, a distinguished Dutch printer, 197
- Blanket, injurious effect of elastic, under heavy impression, 52
- Bodoni, Giambattista, Italian typographer, "Manuale Tipografico", of, cited, 56 (*note*); ability of, as superintendent of the Press of the Propaganda, 90; makes Ducal Printing House at Parma first in Europe, 90; his peculiar styles of roman and italic, 90; styles of, disliked by Morris, 207; brief popularity of styles of, 209; characteristics of new forms of letter introduced by, 217, 218
- Body, in types, illustration of various dimensions of, 29; description of, 31; regular and irregular, 58, 59; display and ornamental types usually cast on regular, 59; differences of, 106; name of type determined by size of, 110; to find the size of, 110, 111 (see also *note* 1); irregularity of, a serious fault, 124; beginning of irregularity in, 126; readjustment of, in France, 142, 143; comparative table of three different systems of, 157; change of, in English types, 158; relations as to ems existing between types of different, 179 (see also *note*), 180; regular and irregular progression of, illustrated, 181
- Body-mark, or Stem, in types, illustration of, 29; description of, 30; in 'pica, 36; in pearl, 36; should seem to be uniform, 49; improved joining of serif and, 51
- Bold-face, limitations of modern, 211; example of modern, on pica 211; many sizes needed to complete series of, 246; superiority of, over earlier fat-face, 284; condensed forms of, 284, 285; remarks upon the Aldine, 285; examples of condensed and extra condensed, 285; condensed old-style, 288; De Vinne, examples of, and remarks upon, 288, 289
- Book, the earliest bearing printed date, 72; first, entirely in Greek, 85; first, entirely in Hebrew, 85; first printed, in the English language, 297 (see also *note*)
- Books, early printed, copies of the manuscript model, 82; blanks left for decorations in early, seldom filled, 83
- Book-type, roman, requires engraving of nearly one hundred and fifty punches for font of, 12, 13; modern, seldom cut in series, 108; sizes embraced in series of, 240; importance of distinctness in, 254
- Book-work, types larger than great-primer rarely used for, 108
- Borders, added by professional illuminator to early printed books, 82; space left for, in some early printed books, 83; marked merit of those used by early French printers, 86
- Borussian, a useful letter for legal formularies, 306; examples of bold-face and light-face, 306
- Bourgeois (9-point), illustration of body of, 29; classed as an irregular body, 58; capital and lower-case alphabets of, 60, 61; probable origin of name, 66; examples of, solid and leaded, 90, 91; standard width of, 114

- Bradford, William, first printer in New York, sketch of, 211
- Bradford face. See *Römische*
- Brass, not a practical substitute for type-metal, 9
- Brasses, or Brass-leads, in printing, strips of rolled brass used as leads in many newspaper offices, 108
- Breitkopf, John Gottlob Immanuel, wide reputation of German type-foundry established by, 91
- Brevier (8-point), illustration of body of, 29; remarks upon durability of, 36; classed as a regular body, 58; capital and lower-case alphabets of, 60, 61; probable origin of name, 66 (see also *note*); examples of, solid and leaded, 92, 93; standard width of, 114. See also *Four-line brevier*
- Brilliant (4-point), capital and lower-case alphabets of, 60, 61; a size belonging to this century, 68; examples of, solid and leaded, 104, 105
- Brito, John, of Bruges, curious characters of, 93
- Broad-face, reasons for introduction of, 116 (*note*), 225; favored by publishers for juvenile school-books, 116 (*note*); examples of, on 10-point body, 225, 226; defects of, 226
- Bruce, David, head of the noted type-founding family, emigrates to New York, 103; with his younger brother, begins business as printer, 103; goes to London in search of information about stereotyping, 103; returns to New York and adds stereotyping to his business, 103; his valuable inventions, 103, 287
- Bruce, David, Jr., son of David, two patents granted to, 24 (*note* 3); devises force-pump attachment to mould, 26 (*note*); invents a type-casting machine, 26 (*note*); other improvements of, 26 (*note*); studies mechanics of type-casting at an early age, 103; his inventions, 103
- Bruce, David Wolfe, youngest son of George, succeeds his father, 103; produces an unusually complete series of penman scripts, 103; retires from business, 103; his successors, 103
- Bruce, George, brother of David, introduces columbian as a text-type, 64; becomes his brother's business partner, 103; an enthusiastic and indefatigable punch-cutter, 103; his services to type-founding, 103; first practical attempt at the establishment of correct proportions of types in America made by, 146, 147; his system of progression of type bodies, 147, 149; regular progression of type-bodies in system of, illustrated, 181
- Brujes, Caxton's first types probably made at, 93
- Buell, Abel, early American type-founder, 102
- Bullock, William, inventor of the Bullock press, sketch of, 278
- Bulmer, William, eminent English printer, Shakespeare Press ably managed by, 101
- Bur, in type-casting, description of, 24 (see also *notes* 2 and 3); importance of removal of, 47
- Cambridge, University of, rejects a condition imposed by the French Academy on purchase of Greek types, 96
- Canon (48-point), widely known as a type name, 57; capital and lower-case alphabets of, 60, 61; description and origin of name of, 62
- Capitals, number of roman, in font, 12; variation in angles of, 14, 15; imitations of Roman lapidary letters, 186; when, where, and by whom first made in type, 187; inadequate supply of large sizes of roman, 242; need for three widths of roman, 246, 247; the frailty of the modern-cut two-line, 248, 249; reasons for popularity of old-style, 249; introduction of condensed, 256; use of condensed, for book titles carried to excess, 257
- Capitals, Small, first appearance of, 187; weakness of, 236; ineffective in print, 236; suggestion of an improvement in, 236
- Caslon, William, of London, ablest type-founder of the eighteenth century, and his successors, 98
- Caslon face or style, made unpopular by an arbitrary standard, 118;

- contrasted with the modern-face, 189; peculiarities of, 191, 192; modern-face in strong contrast to, 192
- Catholicon of 1460, attributed to Gutenberg, 79
- Caxton, William, the first English printer, type on paragon body favored by, 63; used a type face similar to that of Mansion, 80; first types of, show Flemish mannerisms, 93; reticent concerning typography, 93; peculiarities of his later types, 93; some of his books printed at Paris and Rouen, 93; first book in the English language printed by, 297 (see also *note*); remarks upon, and example of, type used by, 297, 298
- Celtic, remarks upon, 325, 326, 327; examples of, 326
- Cennini, Bernard, of Florence, on the characters of his books, 77
- Century broad-face, the, made by the De Vinne Press, 377; use and characteristics of, 377
- Century face, the, introduction of, 231; example of, 376; designed for "The Century Magazine," 376; characteristics of, 376; meets with general approval, 376; advantage of, 376
- Chapel text, a modern variation of the old church text, 310; remarks upon, 310, 311; example of, 311
- Characters, uniformity of, 11; capitals, small capitals, and lower-case, number of, in font, 12; of other kinds, 12; irregular heights of, 13, 14; one mould used for a font of, 43; should please when alone and in composition, 49; number of, in different fonts, 166, 167; apportionment of, necessarily varied for different languages, 167, 168; table exhibiting number of, in a font of roman and italic, 169; peculiar, not kept in stock, 173; weakness of the minor, 240; vagueness of, never tolerated for serious books, 360; unwisdom preference of first Italian printers for large roman, 369
- Charles VII, King of France, sends Jenson to Mainz, 365
- Chiswick Press, the, Basle old-style of, 198, 199 (see also *note* 1); sketch of its founder, 199
- Church, Dr. William, of America, British patent for type-casting machine received by, 263
- Church text, a graceful ecclesiastic letter, 309; examples of, 310
- Clarendon, lighter faces of, preferred as emphasizing letters over small capitals, 236; examples of, 331
- Clymer, George, inventor of Columbian printing-press, sketch of, 220
- Colson, M., uses iron and tin in type-metal, 35 (*note*)
- Columbian (16-point), a neglected body, 64; first made in text-type by George Bruce of New York, 64; examples of, 80, 81
- Composing-room, wear of types in, 37
- Composite, example of, 305; a useful letter for legal formularies, 305, 306
- Composition, rudely cut or badly fitted type mars effect of, 49; various methods of measuring, 118, 120, 121; weight of six-topica leads in, 177, 178
- Composition. See *Type-setting*
- Compositor, advantages of newspaper work over book-work to the, 118
- Compressed-face, example of, 216; preferred in France and Spanish America, 217
- Conner, James, a type-founder of New York, first electrotype matrix used in foundry of, 18 (*note*); begins business as stereotyper, 103; makes first American stereotype edition of New Testament, 103; complete series of Scotch-face probably first shown in America by, 213
- Copley type, example of on double great-primer body, 250
- Copper, an occasional constituent of type-metal, 9, 32, 33; is not a practical substitute for type-metal, 9; sulphate of, needed in electrotyping, 18; a solution of, used in copper-facing, 41
- Copper-facing, the invention of, 41; description of the process, 41; advantages of, 41; differs from electrotyping, 41, 42; expense of, 42
- Cortelyou, Peter C., type-founder, sketch of, 104

- Cottrell, Thomas, an English type-founder, and his successors, 100
- Counter, in types, illustration of, 29; description of, 30; shallow, 36; should be sufficiently deep, 48
- Counter-punch, description of, 15, 16; utility of, 16
- Crapelet, G. A., a distinguished French printer and publisher, sketch of, 276
- Current, action of electric, in electrotyping, 18; use of galvanic, in copper-facing, 41
- Cushing style, or Monotone, introduction of, 231; example of, 250
- Cylinder machine, certain types not suited for, 49, 50
- Dalton, Michael, an American type-founder, 104
- Day, John, an eminent English typographer, biographical sketch of, 94, 95
- Decree, French, of 1649, 274
- Delusions, optical, necessary in the designing of types, 14, 15
- Derriey, Jacques Charles, a French type-founder, specimen album of, 89
- Descenders, types with long, 49, 50; types with short, 50
- De Vinne Press, introduction of Century face for, 231; Renner type made for, 368; Century broad-face made for, 376
- De Vinne type, the, examples of, and remarks upon, 288, 289, 373
- Diamond (4½-point), popular as a type name, 57; is classed as an irregular body, 58; the capital and lower-case alphabets of, 60, 61; first made, probably, by Voskens of Amsterdam, 67; selected by Pickering for his miniature editions of the classics, 68; examples of, 102, 103; standard width of, 114
- Dibdin, Thomas Froggall, English bibliographer, 94, 101
- Dickinson, Samuel Nelson, a noted American type-founder, 104; designs the Scotch-face type, 104, 212; first specimen-book of, 104; his successors, 104; sketch of his career, 201
- Didot, Ambroise Firmin-, a French printer and publisher, 224
- Didot, Firmin-, special mixture of type-metal used by, 35 (*note*); produces practicable stereotype plates, 97; biographical sketch of, 218
- Didot, François, first of a long line of French typographers, 203
- Didot, François-Ambroise, a noted French printer and type-founder, point system of, 142, 143; defect in the point system of, 145 (see also *note* 1), 146 (see also *note*); size of point devised by, 155 (see also *note*); sketch of his life, 215
- Didot, Henri, French type-founder, invents a "polymatype" mould, 22, 24 (see also *note* 1); cuts the letters for a font called *microscopique*, 68, 322; sketch of, 322
- Didot, Hyacinthe, brother of Ambroise Firmin-Didot, 277
- Didot, Jules, son of Pierre, sketch of, 276
- Didot, Pierre François, a French type-founder, paper-manufacturer, and publisher, 279
- Diphthongs, five series of, 240
- Display, former restrictions concerning, 255, 256
- Distributor, failure of first practical type-setting machine due to lack of, 265; use of, in connection with type-setting machine, 354
- Doric, example of, 324; remarks upon, 325
- Double english (28-point), capital and lower-case alphabets of, 60, 61; example of, 74
- Double great-primer (36-point), capital and lower-case alphabets of, 60, 61; example of, 73
- Double paragon (40-point), capital and lower-case alphabets of, 60, 61; example of, 72
- Double pica (24-point), capital and lower-case alphabets of, 60, 61; called two-line pica by English type-founders, 62; example of, 75
- Double small-pica (22-point), capital and lower-case alphabets of, 60, 61; known in England as double pica, 63; examples of, 76, 77
- Dressing-rod, in type-casting, description of, 24, 25
- Drive, description and construction of, 17; conversion of, into matrix, 18
- Ducal Printing House. See *Printing House, Ducal*

- Dupré, Jean, early French printer, statement of, concerning engraving in relief on copper, 84
- Dürer, Albert, German painter and engraver, models for types devised by, 11; his diagrams for the formation of letters, 12 (*note*); favors the roman character, 91
- Electrotyping, definition of, 10; matrices made by, 18, 19; experiments in, by Americans and others, 18 (*note*); supplants stereotyping in book-work, 40, 41; differs from copper-facing, 41, 42
- Elzevir, Daniel, his types made by Van Dijk, 67, 68
- Elzevir, Louis, and his descendants, sketch of, 200
- Elzevir style, the, remarks upon, 199 (see also *note* 2), 200 (see also *note*), 201; examples of, 200, 201; often preferred by French publishers, 215
- Em, or Em quadrat, in printing, the American unit of measure, 113; rules as to fractions of, 113; its unfairness as a measure, 117, 118
- Emerald, an English text-type, 67
- En, or En quadrat, the English unit of measure, 121; a change proposed in size of, 164
- England, distinction between two-line and double-bodied types not well observed in, 59; the roman form of letter introduced into, by Pynson, 93; black-letter never wholly in disuse in, 93; supplied with best types by early type-founders of Rouen, 294
- English (14-point), classed as an irregular body, 58; capital and lower-case alphabets of, 60, 61; one of the oldest of bodies, 64; origin of name, 64; examples of, 82, 83. See also *Double english*
- Engraver's hair-line, example of, 219; supplanted by other forms of light-face, 220
- Engraver's roman, examples of, 289, 290
- Engraving, of the early printers, sometimes done on brass, copper, or type-metal, 84
- Enschedé, Isaac, establishes the celebrated Haarlem type-foundry, 92
- Estienne (or, in English, Stephens), Henry, eminent French printer, and his descendants, 320
- Excelsior (3-point), used in America for music, piece-fractions, and borders only, 68; apparently the same as the English minikin, 68
- Expanded-face, example of, 227
- Face, in types, description of, 30; choice of, 48, 49; types with broad, 50; words used to distinguish varieties of, 113, 114; illustration of different widths of, 115; Scotch-face supplants types of wider and rounder, 116 (*note*); thinner in England and France than in America, 116 (*note*); methods observed in naming, 182; roman, in most request, 184
- Fat-face, or Title, a broad and thick style of roman, 184; Thorne's form of, lasts for many years, 209; example of, on paragon body, 210; characteristics of, 281, 282; accepted for display and title lines, 282; examples of early and modern styles of, 282, 283; formerly sometimes used as a text-letter, 282 (see also *note*); remarks upon italic, 283; newer forms of, better known as bold-face, 284; remarks upon extended, 286; old-style peculiarities applied to, 287; example of old-style, 287; rejection of Thorne and Didot forms of, 370
- Feather-edge, in type-casting, 27
- Feet, in types, illustration of, 29; description of, 31
- Fell, John, English scholar and prelate, presents type-foundry to Oxford University, 96
- Fergusson, James, of Scotland, plan of, for securing the uniformity of type bodies, 132, 133
- Fifteenth Century Style, remarks upon, 366, 367, 374, 375
- Figgins, Vincent, eminent English type-founder, his achievements and successors, 101
- Figures, number of, in font, 12; not provided for all fonts of large type, 166; superior, furnished only to order, 174; features of old-style and modern-cut, 237; cast on the n-set, 237; made on a wider set, 238; difficulty of dis-

- tinguishing certain, 238, 239 (see also *note 1*)
- Firm-face, characteristics and example of, 229
- Fitting-up, in type-making, definition of, 10; a nice operation, 18
- Five-line pica (60-point), example of, 70
- Florence, early printers of, 80
- Font, uniformity of characters in a full, 11; definition of, 32; all characters of, cast in one mould, 43; unequal heights of different characters of same, 46; importance of harmony of characters in, 49; dissimilarity in bodies of the same name, 124, 125; the unequal apportionment of characters in, 165; a table exhibiting number of characters in a so-called complete, 169; scheme for one - thousand - pound, 169-171; piece fractions not proper part of, 174; directions for using a new, 174; how weight of, is computed, 174, 175; economy of large and well-sorted, 175, 176; capacity of, largely extended by use of leads, 177; three series of characters in every complete roman, 185; addition of italic to roman, 185; number and cost of punches and matrices needed for full, 339; sizes of, for plain display and ornamental types, 340
- Foreman, Andrew, casts first types made in California, 104
- Forme, Lettre de, French bibliographers' name for pointed black-letter, 293 (see also *note 2*)
- Founders. See *Type-founders*
- Four-line brevier (32-point), 62
- Four-line pica (48-point), example of, 71
- Fournier the elder, Le Bé foundry bought and sustained by, 87
- Fournier, Pierre-Simon, the younger, "Manuel Typographique" of, cited, 11 (*note*), 16 (*note*), 20 (*note*); his estimate of the production of French hand-caster, 26; constituents of his hard and soft type-metal, 32 (*note*), establishment of type-foundry of, 89; invention of point system of type bodies by, 89; explanation of his system of typographic points by, 133-138; remarks on point system of, 138; illustration of fixed scale of, 139; description and illustration of implements used by, 140, 141 (see also *note*); advantages promised by system of, 141; object of his system, 141, 142; concurrent use of the point systems of Didot and, 143, 144; Didot's eleven-point body wrongly attributed to, 144; some Parisian printers prefer system of, 146 (see also *note*); true inventor of the point system, 155; condensed form of letter introduced to French printers by, 215
- Fox, John, English author, 94
- Fractions, number of, in font, 12; usually furnished with roman fonts from pearl to pica, 173; scheme of, 173; n-set too narrow for, 237, 238; made on the m-set, 238
- Fraktur, early admirers of, 91; accepted as the standard German text-type, 91; is not favored by Latin races or by English-speaking peoples, 91; contrasted with black-letter, 93; the only serious rival of roman in general literature, 184; never selected by English publishers, 296, 297; example of, 303; still retains its old popularity in Germany, 303 (see also *note*); preferred for newspapers and ordinary books, 304; example of, 304
- France, types of Jenson copied in books printed in, 80; becomes superior to Italy in the art of making books attractive, 86; coöperation of eminent publishers and printers with designers of, 86; improvement of type-founding in, 91; early English printers dependent on those of, 93; printers of, alter the italic of Aldus, 187; condensed faces popular in, 215, 216; early English printers favor type-founders of, 297
- Francis of Bologna, punches for Aldus's new italic cut by, 80
- Franklin, Benjamin, an American philosopher, statesman, and author, purchases in Paris complete equipment for a type-foundry, 102, 155 (*note*); with his grandson, begins type-founding in Philadelphia, 102, 155 (*note*);

- his birth and achievements, 195; laments innovations in printing, 360
- Franklin face, the, example of, 195
- French-face, standard of thirteen ems affects use of, 118; specimen of condensed, 215; example of eighteenth-century, 218
- Froben, John, of Basle, devises a nonpareil for black-letter edition of Bible, 67; remarks upon a style occasionally used by, 250
- Fry, Joseph, English type-founder, and his successors, 100
- Furniture, in printing, made to multiples of pica, 64, 145, 146
- Fust, John (with Peter Schoeffer), earliest book bearing printed date published by, 72
- Garamond, Claude, "father of letter-founders," 86; his characters much admired, 86; Greek characters of, 88; supplies Plantin with punches and matrices, 92; remodels italic capitals, 187
- Gauge, for type-bodies, illustration of, 152; for height-to-paper, illustration of, 153. See also *Type-gauge*
- Ged, William, of Edinburgh, the inventor of a process of stereotyping, 97, 283
- German-text, ornamented letters of "Theuerdank" is the model of modern, 91; how emphasis or display is secured in, 186; example of, 303; retains its old popularity in Germany, 303 (see also *note*); used in ornamental job-printing, 304; example of modern, 305
- Germany, type-metal of, 32 (*note*); use of numerical names of types limited in, 55 (*note*); readers in, slow to accept the roman character, 91; adherence to pointed letters in, 91; mongrel romans introduced in, 367
- Golden type, the, made by William Morris after Jenson model, 206; example of, 207; causes which impelled Morris to design, 361; Morris not entirely content with, 361. See also *Kelmscott Press* and *Morris, William*
- Gordon, George P., American printer and inventor, birth of, 225; makes improvements in small printing-machines, 225; patents machine now known as Gordon press, 225
- Gothic, simplest and rudest of all styles, 184; bibliographers' name for black-letter, 291 (see also *note*); round, one of the two styles selected by early printers, 293, 294 (see also *note* 1); revival of round, 299; is a misleading name, 315; a probable origin for name, 315; its English names, 315; remarks upon, 315, 316; examples of five styles of, 316; remarks upon different faces of, 317; old-style figures of, 317; remarks upon extended, 317 (see also *note*); five examples of condensed, 318; extra condensed and hair-line, 318; merit of, 318; defects of, 319; usefulness of lining, 319, 320; examples of different styles of, 320; examples of eccentric styles of, 321; inclined forms of, 321, 322; examples of condensed italic, 322; used by early Venetian printers, 369
- Granjon, Robert, French punch-cutter, boldness and originality of, 89; first punch-cutter to the Press of the Propaganda, 90; famous series of orientals begun by, 90; supplies Plantin with punches and matrices, 92; Plantin's favorite designer, 92; remarks upon a style probably drawn by, 250
- Great-primer (18-point), classed as a regular body, 58; capital and lower-case alphabets of, 60, 61; probable origin of its name, 63; Rowe Mores and Reed on, 63 (see also *note*); called text in Holland, Italy, and Spain, 63 (*note*); examples of, solid and leaded, 78, 79; few roman faces of decided character made on bodies larger than, 191. See also *Double great-primer*
- Greek, first volume entirely in, printed at Milan in 1476, 85
- Greeley, Horace, American journalist, author, and politician, biographical sketch of, 213
- Gregory IX, Pope, remarks upon the Decretals of, 66
- Gregory XIII, Pope, most notable Italian type-foundry, established by order of, 90

- Groove, in types, illustration of, 29; description of, 31
- Grosse bâtarde, Flemish, Caxton's capitals retain peculiarities of, 93; first book in the English language printed in, 297 (see also *note*); first used by Caxton in England, 297; not favored by English readers, 297, 298; revival of, 298; example of, 298. Also once known as *Old Flemish black* and *Secretary*
- Gutenberg, John, of Mentz, named by Zell, Trithemius, and John Schœffer as inventor of printing, 78; confirmed by tablets to his memory, and by writings of fifteenth century, 78, 79; pointed and round gothic faces used by, 81; two bodies of english made by, 81; Bible-text of, 91; works attributed to, 294 (*note* 1)
- Gutta-percha, not suitable for types, 10
- Haarlem Type-foundry, the foundries absorbed by, 92; largest in Holland, 92; celebrated for its orientals, 92. See also *Enschede, Isaac*
- Hagar, William, an American type-founder, begins business in New York, 103
- Hair-line, in types, illustration of, 29; description of, 30; in pica, 36; in pearl, 36; should have a sloping base, 48; types with long and sharp, 49, 50; supported by broad base in modern light-faced types, 51; frailty of the sharp, 230; should have a visible thickness, 230; maintenance of the sharp, 252; limitations of, 253; need for thicker, 253 (see also *note*); delicacy of, in large types, 258, 259; Caslon old-style characterized by firm, 268
- Hand-casters, French and English, production of, per day, 26
- Hand-casting, earliest method of, 25, 26
- Hand-press, permanence of, 358
- Hansard, Thomas Curson, English printer and author, on irregularities of type bodies, 123; early and later Caslon type bodies compared by, 128 (see also *note* 2); "Typographia" of, cited, 133; on the book-printing of his day, 241 (*note*); denounces fat-faced black, 301 (see also *note* 1); extract from "Typographia" of, 333 (*note*)
- Harper, James, founder of printing and publishing firm now known as Harper & Brothers, 226
- Hebrew, first book entirely in, printed at Soncino in 1488, 85
- Henry VIII, King of England, orders prayer-book printed for his subjects, 63 (*note*)
- Herbort, John, partner of Jenson, 365
- Hoe, Richard March, an American printing-press manufacturer, 223
- Holland, numerical names of types on point system partially adopted in, 56 (*note*); English demand for punches made in, 97
- Houghton, Henry O., an American printer and publisher, 228; unconventional book titles of, 244 (*note*)
- Illuminator, initials and borders added to early printed books by professional, 82; certificate of, to Bible of 42 lines, 82
- Imperial Printing House. See *Printing House, Imperial*
- Impression, in printing, variations of, for different types, 51, 52; effect of, upon light-faced and bold-faced types, 52
- Initials, added by the professional illuminator to all early printed books, 82; those of the Psalter of 1457 printed in two colors, 82; space left for, in some early printed books, 83; those of Ratdolt probably cut in high relief on metal, 84; white letters on gray groundwork, devised by early printers, 84; marked merit of those used by early French printers, 86
- Instruments, measuring, needed in punch-cutting, 14
- Ionic, example of, 324; remarks upon, 326
- Iron, use of, in type-metal, 33 (see also *note*)
- Italian, a form of roman, peculiarity of, 184
- Italic, variations in font of 14, 15; bad fitting not infrequent in some

- older fonts of, 45; should mate with roman, 48; that of Garamond much admired, 86; Bodoni's peculiar style of, 90; always accompanies full font of roman, 172; a simplified style of disconnected script, 184; an inseparable mate of roman, 185; first exhibited by Aldus in his octavo edition of Virgil, 187, 270; the text letter in many books of Aldus, 187; modern uses of, 269; difficult to cut and cast, 269, 270; few forms of faultless, 270 (see also *note*); remarks on original old-style, 270, 271 (see also *note* 1); rude forms of old, 271 (see also *note* 2); the Baskerville, 271; example and description of modernized old-style, 272; example of Elzevir, 273; peculiarities and illustration of French old-style, 274; example of the modern bold-face, 275; rarity of light-faced, 275; examples of modern French light-face, a condensed French-face, and an eighteenth-century French-face, 276, 277; different attitudes of American, English, and French publishers toward, 277; example of engraver's hair-line, 278; inclined roman a French variety of, 278; remarks upon, and example of, law, 279; description of elongated, 280; remarks upon figures and small capitals of, 280; gothics of inclined form usually named, 321; remarks upon, and examples of, gothic condensed, 321, 322
- Italy, numerical names of types on point system partially adopted in, 56 (*note*); valuable improvements made by printers of, 85; decadence of typography in, 90
- Jaekson, Joseph, a noted English type-founder, sketch of, 100, 101; wider and rounder faces of, supplanted by Scotch-face, 116 (*note*)
- Jacobi, Professor, of St. Petersburg, his successful electrotyping experiments, 18 (*note*)
- James, Thomas, an English type-founder, sketch of, 97
- Jannon, J., a printer of Sedan, 67
- Jaugeon, Nicolas, French archæologist and mechanician, recommends rules and diagrams for the designing of letters, 12 (*note*); receives commission from Louis XIV to make a truly "royal" type, 87; new types of, inferior in legibility and durability, 87
- Javal, Dr., French optician, remarks of, on use of serifs, 250; on the readability of types, 260; on the evolution of typography, 334
- Jenson, Nicolas, of Venice, on the cutting and casting of his types, 77; his types copied in books printed in France, 80; roman and round gothic made by, 81; roman perfected by, in 1471, 85; romans modeled after designs of, 88; capital and lower-case letters of, model for type-founders, 187; books in round gothic printed by, 294 (*note* 1); biographical sketch of, 365
- Jenson type, the, remarks upon, 364; example of, 365
- Jet, in type-casting, description of, 24 (see also *note* 3)
- John and Windelin of Speyer, remarks upon types used and books printed by, 366, 367, 368
- John of Cologne, associated with Jenson, 365
- John of Westphalia, begins printing at Alost in 1474, 80
- Johnson, Lawrence, a printer, establishes stereotype foundry at Philadelphia, 102; his successors, 102; Cincinnati branch foundry established by, 105
- Johnson, William, invents a type-casting machine, 26 (*note*)
- Jordan, J. C., successful electrotyping experiments of, 18 (*note*)
- Junius, Francis, punches and matrices collected by, 96
- Justification, in typography, advantage claimed for point system in, 160; difficulties of, 160, 161; spaces on point sets an aid to, 164
- Kelmescott Press, the, establishment of, 207; example of Golden type composed at, 207
- Kern, in types, description of, 30, 31; should be well supported, 48; unavoidable in italic, 269, 270
- Koster, Laurens, the legends of a Dutch invention by, 79; bad type-founding of, 92

- Lead, a constituent of type-metal, 9, 32 (see also *note*)
- Leads, in printing, graduated to divisions of pica, 64, 145, 146; difference in appearance of type produced by use of, 106, 107; illustration of various thicknesses of, 107; high and low, 107; usually cast in a mould, 107, 108; some made by rolling-machines, 108; made also of rolled brass, 108; capacity of a font extended by use of, 177; space occupied by one pound, 177; how to find required weight of, 177, 178 (see also *notes*)
- Leavenworth, William, adapts the pantograph to the manufacture of wood types, 348
- Le Bé, Guillaume, succeeds Garamond as leading French type-founder, 87; his descendants, 87
- Letters, full-bodied, 12; ascending, descending, and short, 13; variation in face heights of, 14; determination of proportions of, 15; use of model, in electrotyping, 18; kerned, 24, 32; illuminated initial, added to early printed books, 82; fashion of making white, 84; adherence of Germans to pointed, 91; lean and condensed, 114; various sizes of, defined, 116 (see also *note*); superior, furnished only to order, 174; description of swash, 187; specimens of six series of two-line, 251; examples of condensed two-line, 256, 258; decline in demand for highly ornamented, 359; demand for fantastic, 360; Morris's aversion to classic, and leaning to Teutonic forms of, 361; merit of the Kelmscott, 370
- Lettre de forme, Lettre de somme. See *Forme, Somme*
- Light-face, example of, 222; characteristics and example of modern French, 224; objections to, 228; many sizes needed to complete series of, 246
- Lindsay, James, type-founder, 103; specimen of condensed Scotch-face cut by, 214
- Linotype (or Mergenthaler) machine, success of, largely due to accuracy of matrices, 353; its construction and operation, 354-356
- Litteræ florentes, Ratdolt's name for decorative initials, 83
- Long-primer (10-point), illustration of body of, 29; classed as a regular body, 58; capital and lower-case alphabets of, 60, 61; origin of name, 65 (see also *note 2*); preferred for duodecimos, 66; examples of, solid and leaded, 88, 89; standard width of, 114; illustration of irregularities of measurement in four faces of, 119
- Lothian, George B., establishes a type-foundry at Pittsburgh, Pa., 102; his Greek faces much admired, 103
- Lothian, Robert, of Scotland, father of G. B. Lothian, begins a type-foundry in New York, 102
- Louis XIV, King of France, commissions Jaugeon to make a "royal" type, 87
- Lower-case, roman, as a name for small letters, technical and not generally understood, 185 (see also *note*); an imitation of characters of early French and Italian copyists, 186; when, where, and by whom first made, 187
- Lyman, Nathan, American type-founder, 104
- Lyons, early founders of, supply printers of all countries with punches, matrices, and fonts of type, 86, 87
- MacFarland face, the, example of, and remarks upon, 374, 375
- Machine, Cylinder, Type-casting, Type-revolving. See *Cylinder, Type-casting, Type-revolving*
- MacKellar, Thomas, American printer, sketch of, 229
- Mainz. See *Mentz*
- Making-ready, omission of, a cause of wear in types, 37, 38; the modern style of, 38; developed by Joseph Alexander Adams, 219
- Mansion, Colard, printer, uses types similar to those of Jenson, 80; curious characters of, 93; Blades and Madden on Caxton's business relations with, 297 (*note*)
- Manutius, Aldus, Italian printer, complains of piracy of his designs, 80; small capitals and italic first made for, and shown by, 187; italic the text-letter of many of

- his books, 187; first italic exhibited in his Virgil of 1501, 187, 270
- Mappa, Adam G., first type-founder in New York, 102
- Martens, Thierry, types of, 92
- Martin, Robert and William, noted English type-founders, sketch of, 101
- Matrix, description and construction of, 17; conversion of drive into, 18; also made by electrotyping, 18 (see also *note*), 19; impresses the fluid metal, 26; bad fitting-up of, 45, 46; frequently sold at close of fifteenth century, 80; liable to imperceptible displacement, 125
- Mayeur, Gustave, revival of the seventeenth-century, or Elzevir, style by, 199 (see also *note* 2), 200 (see also *note*); Didot style revived by, 219
- Mecom, Benjamin, printer, nephew of Franklin, attempts stereotyping, 102
- Mentz, or Mainz, Bible of 42 lines illuminated at, 74; the Bible of 36 lines believed to have been printed at, 74; type-making and printing practised at, before 1460, 75
- Meridian (44-point), 62
- Microscopique (2-point—Didot), cut by Henri Didot, 68, 322
- Milan, first volume in Greek printed at, in 1476, 85
- Miller, William, a Scottish type-founder, and his successors, 101
- Minikin. See *Excelsior*
- Minion (7-point), illustration of body of, 29; classed as an irregular body, 58, 66; capital and lower-case alphabets of, 60, 61; origin of its name, 66; examples of, 94, 95; standard width of, 114
- Minionette (6½-point), largely used in France for combination borders, 66; passing out of use in the United States, 66, 67; equivalent of English emerald, 67
- Minuscule, Dr. Taylor's name for lower-case letters, 185 (*note*); the Caroline, 186
- Missal, the German name of canon type, 62
- Mitchel, William Haslett, American inventor of a practical typesetting machine, 265
- Mitchelson, David, a London die-sinker, begins a type-foundry at Boston, 102
- Mittel. See *English*
- Modern-face, the prevailing style of roman type, 188; characteristics of, 188, 189, 190, 192, 193
- Monotone. See *Cushing*
- Monotype, Lanston, description of, and method of operation, 357
- Mores, Edward Rowe, an English antiquary and writer on typography, explanation of "the Pie" by, 64, 65; purchases contents of James foundry, 97
- Morris, William, English poet, artist, and typographer, devises a "Golden" type, based on Jenson's great-primer roman, 206, 361; contributes to this work an example of it, text written by himself, 208; favors quaintness and medieval methods, 361; his aversion to classic, and leaning to Teutonic forms, 361; issues a new form of black-letter, 361; difficulties encountered by, in designing the latter, 361, 362; remarks upon his new Troy type, 362; the reading world indebted to, for a really masculine style, 362; types of, rejected by publishers as unfit for ordinary books, 368; marked influence exerted by types of, 368, 370; his admirable methods, 370. See also *Kelmscott*
- Motteroz, Claude, French printer, sketch of, 232
- Motteroz face, the, characteristics of, 231; adopted by Municipal Council of Paris for its publications, 232; example of, 232, 233; contrasted with the Didot style, 233
- Mould, use of, in type-making, 9, 10; each matrix must be accurately fitted to, 17; all matrices of a font adjusted to a single, 19; trueness of, imperative, 19; description and construction of, 19, 20 (see also *note*), 21; efforts to cast many types at one operation from a multiple, 22; Didot's, not adopted by other founders, 24; its use in the process of hand-casting, 25, 26; in stereotyping, 39; its set altered with almost every change of matrix, 45; sim-

- ple form of, used by early printers, 81; liability of, to swell and wear, 125
- Moulding, papier-maché method of, injurious to types, 37
- Mould-making, definition of, 10
- Moxon, Joseph, first English writer on typography, scheme of, for designing letters, 12 (*note*), 13; his "Mechanick Exercises" cited, 20 (*note*); his moulds made of iron, 20 (*note*); his estimate of production of English hand-caster, 26; statement of, as to use of iron in type-metal, 33 (see also *note*); bodies now called irregular unknown to, 58; his works on typography, 96; his geometrical formulæ declared impracticable, 96; names ten bodies most used in England, 126, 127; rude and uncouth old-style italic of, 271 (*note* 2)
- Munsell, Joel, publisher and printer, sketch of, 214
- Napoleon I, Emperor of the French, despoils printing-offices of Propaganda at Rome and of Medicis at Florence, 88
- National (or Royal or Imperial) Printing House. See *Printing House, National*
- Neck, or Beard, in types, illustration of, 29; description of, 30
- Netherlands, early printers of, use type face similar to that of Jenson, 80; four bodies of english made by unknown early printer of, 81; improvement of type-founding in, 91
- Newton, Dr., of New York, invents copper-facing, 41
- Nick, in types, illustration of, 29; description of, 31; it should be clearly defined and different from other faces of same body, 48
- Nonpareil (6-point), illustration of body of, 29; widely known as type name, 57; classed as a regular body, 58; capital and lower-case alphabets of, 60, 61; most used of the small bodies, 67; invention and earliest uses of, 67; adjudged a marvel of letter-cutting, 67; examples of, 96, 97; advertisements in, 106; standard width of, 114
- Non-plus-ultra (2-point), cast on 4-point body, 68
- Old black, revival of lettre de somme, or round gothic, under name of, 299; example of, 299; characteristics and uses of, 299
- Old english, adheres closely to the models of first printers, 93; generally accepted name of pointed black-letter, 294; characteristics and uses of, 294, 295; example of, 295; preferred by Pickering, 295; commended by Moxon, 295, 296; more in fashion now than formerly, 296; its abbreviations used in facsimile reprints, 296
- Old Flemish black. See *Grosse bâtarde*
- Old Roman, characteristics of, and remarks upon, 378
- Old-style, the Caslon, 98, 100; is a subdivision of the roman form of type, 188; characteristics of, 188, 191; example of, 189; defects of, 192; features of modernized, 193, 194, 195; example of large-faced, 196; example and characteristics of original, 197; the Basle, or early-Italian, described and illustrated, 198, 199 (see also *note* 1); the Elzevir, or seventeenth-century, examples and peculiarities of, 199 (see also *note* 2), 200 (see also *note*), 201; Ronaldson, example of, 202; French, example of, 203; condensed, preferred by French printers for dictionaries and catalogues, 204; Portuguese, example of, 204, 206; condensed types made on model of, 266, 267, 268; example of extra condensed, 268; objectionable forms of condensed and extra condensed, 288
- Oriental, older forms of, have one series of characters only, 185
- Overlying, present method of, developed in United States, 219. See *Adams, Joseph Alexander*
- Oxford, early type-founders at, 96
- Pantograph, adaptation of, to the manufacture of wood types, 348; description and illustration of, 348-350
- Paper, varieties of, destructive to types, 38

- Paragon (20-point), widely known as a type name, 57; seldom selected now by American or English founders, 63; favored by Caxton and the printer of the Bible of 42 lines, 63; called text in Germany, 63; suitable book-types not made upon this body, 108. See also *Double paragon*
- Paris, the early founders of, supply printers of all countries with punches, matrices, and fonts, 86, 87; notable founders of, 87; books printed at, for Caxton and his successors, 93; return of Jenson to, 365; thick-stemmed roman types early made and used at, 370
- Parker, Matthew, an English archbishop and early patron of printing, 94
- Pearl (5-point), widely used as type name, 57; classed as a regular body, 58; capital and lower-case alphabets of, 60, 61; is used for pocket editions of Bible, prayer-books, and small manuals, 67; made famous by Jannon in his so-called "Diamond" editions, 67; examples of, solid and leaded, 100, 101; standard width of, 114
- Petrarch (Francesco Petrarca), Italian poet, italic of Aldus modeled on handwriting of, 187 (see also *note*)
- Phonotype, its needed new characters not in general use, 235
- Pica (12-point), spaces of, illustrated, 29; illustration of body of, 29; about one sixth of an inch in thickness of body, 31; all sizes above canon called by multiples of, 57; classed as a regular body, 58; capital and lower-case alphabets of, 60, 61; a favorite body for octavos, 64; the standard unit for determining sizes, 64; origin of name, 64; Rowe Mores on, 64, 65 (see also *note* 1); examples of, solid and leaded, 84, 85; a book in, 106; standard width of, 114; example and defects of an early form of condensed, 262, 263; illustration and characteristics of a later form of, 263; early faces of, too condensed, 263, 264; example of, and remarks upon, extra condensed, 265. See also *Double pica*, *Four-line pica*, *Five-line pica*, *Six-line pica*
- Pica, Friars de, origin of name, 65
- Pickering, William, English publisher, selects diamond type for his miniature editions of the classics, 68; requests Whittingham to reprint a diary in old-style letter, 98; unconventional book titles of, 244 (*note*); uses pointed black-letter for his Victorian edition of Book of Common Prayer, 295
- Pie, old English form of the Latin name Pica, 64, 65
- Pin-mark, in types. illustration of, 29; description of, 31
- Plane, in type-casting, use of, 25
- Plantin, Christopher, of Antwerp, orientals cut by Le Bé for, 87; newer styles of, 92; various type-founders work for, 92; Granjon his favorite designer, 92; his Flemish characters, 92
- Plates, zinc and copper, action of electric current on, 18, 19
- Poetic-face, a condensed old-style preferred in France for poetry, 204; example of, 205; great popularity of, 216
- Point, in typography, the American, 154, 155 (see also *note*); the Fournier, 155 (see also *note*); the Didot, 155; illustration of type bodies based on American, 156
- Points of punctuation, number of, in font, 12; objections to italic, 239; a real need for inclined, 239
- Point system, new names of types according to, 54, 55; is partially adopted in Italy, Spain, and Holland, 56 (*note*); Fournier's explanation of his, 133-138; advantages promised by, 141; adopted by French type-founders, 141; François-Ambroise Didot devises a new, 142, 143; concurrent use of Fournier's and of Didot's, 143, 144 (see also *note* 1); preference of the Parisian typographers for Fournier's, 146 (see also *note*); the American, 149, 150; adoption of the latter by United States Type Founders' Association, 150; basis of the American, 152 (see also *note*); comparison of Fournier's with the American, 155 (*note*); the American, adopted by many founders, 159; too much expected

- from, 159; helpful in algebraic work, 161; applied to the set, or width, of types, 161, 162; difficulties of such application, 162, 163; also applied to spaces, 163, 164; irregular progression of type bodies in American, illustrated, 181; type bodies clearly defined by numerical names in, 182
- Polyglot, London, of 1657, fourth great Bible of the world, 95
- Polymatye. See *Didot, Henri*, and *Pouchée, Louis John*
- Pouchée, Louis John, type-founder, adopts Didot's polymatye method, 102
- Presses, Cylinder, may be injurious to types, 37. See also *Cylinder*.
- Presswork, is marred by rudely cut or badly fitted type, 49; small types produce the effect of weakness in, 230; abandonment of old methods of, 253
- Price lists. See under *Tables*
- Print, date of oldest verified, 69
- Printers, bodies now called irregular unknown to early English, 58; early, engraved full-page borders and white initials on gray groundwork, 84; early Italian, made valuable improvements in typography, 85; early French, preferred the black-letter character, 86; improvements in typography made by French, 89; early types of Dutch founders preferred by London, 96; early, worked to great disadvantage, 106; a rude adjustable mould used for casting types by first, 126
- Printing, weak and misty style of, 254; demand for quaintness in decorative, 360; objections to new fashions in, 360; Morris's reported statement on the degradation of, 361
- Printing House, Ducal, of Parma, Bodoni invited to reconstruct and manage, 90
- Printing House, the Imperial, of Vienna, celebrated for its large collection of foreign types, 91
- Printing House, National (or Royal or Imperial), Le Bé cuts orientals for, 87; notable Paris type-founders dwarfed by growth of, 87; its punch-cutter Lucé disfigures the roman character, 88; high reputation of, 88; its typographical riches, 88, 89
- Printing, type, date of oldest, 70; practised at Mentz before 1460, 75
- Printing-types. See *Types*
- Propaganda, Press of the, punches of, 90; Bodoni manager of, 90
- Prototype, measuring instrument used by Fournier, 140, 141, 143
- Psalter of 1457, earliest book bearing a printed date, 72; its types cast on bodies of double paragon and double great-primer, 73; decorated with red ink and large initials, 73; imprint of, 75; contains great initials in two colors, 82; printed by Fust and Schœffer, 293 (*note 2*)
- Punch, description and construction of, 16, 17; impresses the matrix, 26; frequently sold at close of fifteenth century, 80; cut on steel for roman and italic, 339, 340
- Punch-cutter, the modern, not fettered by arbitrary rules, 11, 12 (*note*); how he begins his work, 13-15; difficulties of the early, 100; different aims of the old and the modern, 190 (see also *note*)
- Punch-cutters, in American type-foundries of the nineteenth century, 289, 290
- Punch-cutting, description of, 10-17; secrets of, jealously guarded, 100
- Punch-cutting machine, the Benton, features of the pantograph successfully incorporated in, 350; method of working, 350, 352, 353; illustration of, 351; superiority of punches produced by, 353
- Pynson, Richard, English printer, introduces into England the roman form of letter, 93; many of his punches and types brought from Rouen, 93; Moxon's model letters show no important departure from those used by, 300
- Quotation marks, superiority of French over English, 203, 204, 239 (see also *note 2*)
- Ratdolt, Erhard, of Venice, probably the first to make true decorative initials, 83; remarks upon the latter, 84; accepts the model introduced by Jenson, 367

- Readers, needs of, not intelligently regarded by type-founders, 253, 254; rights of, deserve more consideration, 254
- Reed, Sir Charles, an English type-founder, 100
- Reed, Talbot Baines, on the early use of great-primer for text of Bibles and prayer-books, 63 (*note*); possible origin of name bourgeois suggested by, 66; remarks of, on breviaries, 66 (*note*); on the use of black-letter in England, 93; on Day's excellence as a type-founder, 94; on the Oxford University Press, 96; on old English foundries, 97; the author's indebtedness to, 100; on the achievements of the type-founder Fig-gins, 101; on the Miller & Richard foundry, 101
- References, number of, in font, 12
- Reglet, in printing, 145, 146
- Renner, Franz, of Venice, accepts type standard introduced by Jen-son, 367; devises new style for his edition of the "Quadragesimale," 368; biographical sketch of, 369
- Renner type, the, designed after style of Franz Renner, 368; its characteristics, 368; example of, 369
- Riverside face, example and characteristics of, 228, 229; introduction of, a protest against effemina-cy of modern types, 231
- Roman, variations in a font of, 14, 15; one face of italic used with two or more faces of, 48; first founded by Sweinheim and Pan-nartz in 1465, 85; made perfect by Jenson in 1471, 85; Tory endeavors to extend the use of, 86; Garamond's form of much admired, 86; Bodoni's peculiar style of, 90; lack of harmonious series of faces in, 108, 109; full font of, always accompanied with italic, 172; characters omitted in regular font of, 172; preferred as text-letter by the English-speaking peoples and the Latin races, 184; largely used in Ger-many for scientific books, 184, 185; every complete font of, between pearl and great-primer pro-vided with three series of char-acters, 185 (see also *note*); italic an inseparable mate of, 185; addition of italic to font of, 185; five correlated series of the al-phabet in, 186; greatest merit of, 186; capitals of, imitations of Roman lapidary letters, 186; subdivided into two classes, 188; an object of experiment with type-founders for nearly four centuries, 191; defects of, most noticeable in the smaller sizes, 230; little change in general form of, 234, 235; rarity of large sizes of, 241, 242; example of inclined, 278; called white-letter to distin-guish it from black-letter, 292, 293; various styles of, for serious books, 360; first made at Subiaco, 367; uncouth shapes of, not tol-erated in fifteenth century, 367; model of, selected by Renner, 369
- Römische Antiqua and Versalien, illustration of capitals of, 372; remarks upon, 373, 374, 375; made and sold in New York under the name of Bradford face, 373
- Ronaldson, James, partner of Bin-ny, 102; receives loan of type-founding apparatus bought by Franklin, 155 (*note*); biographi-cal sketch of, 202
- Rouen, early founders of, supply printers of all countries, 86, 87; books printed at, for Caxton and his successors, 93; early English printers import their punches and types from, 93, 294
- Round-face, examples of, on pica and long-primer bodies, 220, 221; pre-vailling fancy for, 221; effective in leaded composition with broad margin, 221
- Ruby. See *Agate*
- Rules, brass, in printing, basis for sizes of, 64, 145, 146
- Runic, examples of, 326, 327
- Sanleque, Jacques de, French type-founder, 87
- Satanick type, example of, and re-marks upon, 363
- Sauer, or Sower, Christopher, es-tablishes type-foundry at Ger-mantown, Pa., 102
- Savage, William, author of a "Dic-tionary of Printing," 128, 129; his table of measurements of

- bodies made by founders of Great Britain, 129
- Scheme (or Bill in Great Britain), in typography, definition of, 165, 166; for different fonts, 166, 167; object of the, 168; not exactly alike in all foundries, 169; for a so-called complete font of roman and italic, 169; for one-thousand-pound font, 169-171; of fractions, 173
- Schœffer, John, son of Peter, claims Gutenberg as inventor of printing, 78
- Schœffer, Peter, prints the *Grammatica* at Mentz, 76; round gothic, or semi-gothic, of, 91; Latin Bible of 1462 printed by, 294 (*note* 1). See also *Fust, John*
- Schwabacher, the early admirers of, 91; was never selected by English publishers, 296, 297; example of, 303; still retains its old popularity, 303 (see also *note*); rounder, clearer, and simpler than the *fraktur*, 304; example of, 304
- Sciences, Académie des, commission of, formulates rules for designing letters, 12 (*note*)
- Scotch-face, standard of thirteen ems limits use of, 118; example of, on long-primer body, 212; origin and characteristics of, 212; a complete series first shown in America by James Conner, 212, 213; its grace acknowledged, 213; objections to, 213; example of, on 10-point body, 213; example of condensed, on english body, 214; many sizes needed to complete series of, 246
- Script, lack of durability of, 35; lighter impression necessary for page of, 51, 52; modeled on some fashion of letter used by early copyists, 184; the line separating italic from, not easily drawn, 279
- Secretary, of old form. See *Grosse bâtarde*
- Sedan, so-called "Diamond" editions printed by Jannon at, 67
- Sensenschmidt, John, prints Bamberg Missal of 1481 from largest text-types, 84
- Serif, in types, illustration of, 29; description of, 30; should have a sloping base, 48; should be of uniform length, 49; types with long and sharp, 49, 50; types with stubby, 50; strengthened with bracket-like curves in all modern light-faced types, 51; Dr. Javal's remarks upon the use of, 250; its place in typography, 253; absence of, in gothic, 315, 316, 318
- Set, in printing, definition of, 122
- Shakespeare Press, admirable books printed by, 101. See *Bulmer*
- Shells, electrotype, backing up of, 19
- Shoulder, in types, illustration of, 29; description of, 30; should be sufficiently low on body, 47, 48
- Signs, number of, in font, 12; special, not furnished in regular assortment for font, 12
- Six-line pica (72-point), example of, 69
- Sixtus IV, Pope, confers the title of Count Palatine on Jenson, 365
- Slug, in printing, its description and uses, 108
- Small capitals. See *Capitals, Small*
- Small-pica (11-point), illustration of body of, 29; classed as an irregular body, 58, 65; capital and lower-case alphabets of, 60, 61; in greater request than the regular body of pica, 65; examples of, solid and leaded, 86, 87; standard width of, 114. See also *Double small-pica*
- Société Littéraire-Typographique, Baskerville's types and his type-making material sold to, 99
- Somme, Lettre de, French bibliographers' name for round gothic, 293, 294 (see also *note* 1); revival of, and remarks upon, 299
- Soncino, first book entirely in Hebrew printed at, in 1488, 85
- Sorts, in printing, definition of, 32
- Sower. See *Sauer*
- Spaces, in types, illustrated, 29; table exhibiting point system applied to, 163; so-called patent, in use in large book offices, 164
- Spencer, Thomas, of Liverpool, a successful experimenter in electrotyping, 18 (*note*)
- Squirt machine, invention of, 26 (*note*)
- Standard, for measuring widths of types, remarks upon, 114-122
- Stanhope, Charles, third Earl Stanhope, English scientist, perfecter of stereotyping, 97, 283

- Star Chamber, Decree of, 95
- Starr, type-founders bearing family name of, 18 (*note*), 103, 104
- Stationers' Company, an injunction of, 95
- Stem, in types. See *Body-mark*
- Stephens. See *Estienne*
- Stephens, Robert, Garamond makes Greek characters under direction of, 88
- Stereotyping, moulding process of, injurious to types, 37; its advantages, 39; description of process, 39; freely made use of in America, 40; supplanted by electrotyping for book-work, 40; benefits of, 40, 41; early processes of, 97; applied to the casting of types, 346
- Straight-edge, its use in punch-cutting, 14
- Strasburg, able printers of classic texts at, 91
- Subiaco, first roman types made at, 187, 367
- Swash letters, example of, and remarks upon, 187; special form of old-style italic, used by Leadenhall Press, 271 (*note* 1)
- Sweinheim (Sweinheim, Sweynheim) and Pannartz, printers from Germany, first roman types made by, 85, 187, 367
- Tables—an exhibit of the American and English names of types, 54; French and German, 55; Italian, Spanish, and Dutch, 56; relations of all types to each other, 112 (see also *note*); different widths for type faces, 115; irregularities of measuring types, 119; Moxon's ten bodies most used in England, 127; Luckombe's proper dimensions of bodies, 127, 128 (see also *note* 1); lines of different sized type in one foot, 129; a comparative scale of ems in linear foot, 130; type bodies in point systems of Fournier and Didot, 144; Bruce system of geometrical progression of type bodies, 148; the American point system of type bodies, 151; comparison of three scientific systems of type bodies, 157; sizes of English types, 158; point system applied to spaces, 163; characters in so-called complete font of roman and italic, 169; scheme for thousand-pound font, 170, 171; number of solid pages composed with fonts of different weights, 176; number of ems in one pound of type of different bodies, composition solid, 177; the weight of six-to-pica leads in composition, 177, 178; square inches occupied by one thousand solid ems of different types, 179; relations of one thousand solid ems of one body to other bodies, 180; *price lists* of: American Type Founders Company, 338; English and Scotch type-founders, 341; French types, 342; German types, 343
- Taylor, Bayard, American author, sketch of, 278
- Taylor, Dr. Isaac, English philologist and antiquarian, remarks of, on the alphabet, 185 (*note*), 186
- Teutonic, 305, 306; example of, 307
- Text. See *Great-primer* and *Paragon*
- Text-letters. See *Text-types*, *Types*
- Text-types, beauty of, consists in their precision, 11, 12; multiplication of faces of, 53; of large quartos and folios, 63; largest in Sensenschmidt's Missal of 1481, 84; the three faces of greatest usefulness made in Italy, 85; the roman model accepted as best, 183; quaint styles of, 359 *et seq.*
- Theorists, French, models for types made by, 11
- Theuerdank, or Theuerdanck, ornamented letters of, the model of modern German-text, 91
- Thomas, Isaiah, printer and publisher, sketch of, 212
- Thorne, Robert, an English type-founder, designs a new series of bold-face types, 100
- Tin, a constituent of type-metal, 9, 32 (see also *note*), 33
- Title. See *Bold-face* and *Fat-face*
- Title-pages, closely graded series of uniform face needed for, 242, 243, 244; reasons for unsatisfactory, 243, 244 (see also *note*); two-line letters of three widths needed for, 246, 247, 248; use of condensed capitals for, carried to excess, 257
- Title-type. See *Fat-face*.
- Torresani, Andrew, an Italian

- printer, 66; procures strikes from punches of Jenson roman, 365
- Tory, Geoffrey, a French engraver and printer, 12 (*note*); endeavors to extend the use of roman letter, 86
- Treadwell, Daniel, an American inventor, sketch of, 275
- Trithemius, the Abbot, describes type-making, 76; names Gutenberg as inventor of printing, 78
- Trow, John F., of New York, first practical type-setting machine used in office of, 265
- Troy type, designed by Morris on the broad-faced form of round gothic, 362; remarks upon, 362
- Two-line pica. See *Double pica*
- Type-casting, explanation of, 10; once done by hand, now done by machine, 22; always done by early printers, 81
- Type-casting machine, its moulds made attachable to, 20; description and construction of, 20, 22, 24; illustration of the Bruce, 23; its popularity, 27; improvements of value added to it, 27; its great defect, 27; the new forms of, 27; Barth produces a complete, 27; foreign inventors of, 27; description and illustration of the Barth, 27, 28; machine for casting introduced in Great Britain by Miller & Richard, 101
- Type-dressing, definition of, 10
- Type-founders, secret formulæ of, 32; new type always provided for specimen-books of, 37; their preference for Latin phrases in old specimen-books explained, 43, 44; modern specimen-books of French, 55 (*note*); distinction between regular and irregular bodies made by, 58; two-line and double-bodied types separately named by American, 59; modern taste inclining to models of early Italian, 85; notable French, 87; improvements in types made by French, 89; some eminent German, 91; prominent Dutch, 92; biographical sketches of various, 94-105; named in Decree of Star Chamber, 95; early English, and their successors, 95, 96, 97; inaccuracy of the early, 125, 126; bodies made by all leading English, 129; deviations from standards by American, 130; precise height-to-paper gauge used by, 153; the needs of readers lightly regarded by, 253, 254; early, of Rouen, supply England with best types, 294; German forms reproduced by American, 305; disused process of casting in sand-moulds revived by, 345, 346; highly ornamented letters not in favor with, 359; inability of, to maintain exact uniformity in a full series of types, 375
- Type Founders' Association, United States, adoption of American point system by, 150; methods for securing uniformity of type bodies agreed upon by, 152; rejection of French system by, 154; point adopted by the, deviates little from that devised by Fournier, 154, 155
- Type Founders Company, American, branches of, 102, 103, 104, 105; price list of, 338; remarks upon the latter, 339
- Type-founding, not like other arts, 11 (*note*); one of the many forms of printing, 26; lack of system in early, 81; first made a distinct art in France, 86, 87; high reputation of French, 87; damage to German, 91; its status in the Netherlands during latter half of fifteenth century, 92
- Type-foundries, notices of, 94-105
- Type-gauge, description and illustration of, 159, 160. See *Gauge*
- Type-making, six distinct departments of, 10; practised at Mentz before 1460, 75; Ulric Zell and Trithemius on, 76; recent type-setting machines owe their utility to new processes for, 353; sketch of apparatus for, in Mergenthaler and Lanston machines, 354-357; other machines in process of development for, 357, 358; not probable that older methods of, will fall into disuse, 358
- Type-metal, no practical substitute for, 9, 10; model letters often cut on, 18; inflow of, into mould, 20; constituents of, 32 (see also *note*)-34; the useful properties of, 34; lack of durability of, 35; its use in stereotyping, 39; test of hardness in, 42; price of, varies with market rates of metals, 337

Type-mould. See *Mould*.

Type-revolving machine, adjudged injurious to types, 37; certain types not suited for, 49, 50, 116 (*note*)

Types, composition of, 9; utility of typography depends upon accuracy of, 9; large sizes, for posting-bills, generally made of wood, 10; beauty of text-, consists in their precision, 11, 12; characters in font of roman book-, 12; variations in depth of counters, 15, 16 (see also *note*); smaller sizes rapidly made, 22; imperfect as thrown from mould, 24; dressing or finishing of, 25; great improvement in casting, 25; various features of, illustrated and described, 29-32; soft metal used for ornamental, 32; lack of durability of, 35; difficulties in the making of hard, 35 (see also *note*); durability of, depends on size and cut of face, 36; differing views of publishers as to wear of, 36, 37; repeated handling of, injurious, 37; causes of wear in, 37, 38; varieties of paper destructive to, 38; durability of, promoted by cleanliness, 39; greater durability of copper-faced, 41; importance of solidity and even lining of, 43 (see also *note*); uneven lining of, and its frequent cause, 44; importance of fitting up of, 45; unequal height of, 46; legibility of, improved by close fitting, 47; importance of good mechanical finish of, 47; should be pleasing alone or in mass, 49; effect upon press-work of rudely cut or badly fitted, 49; inferior durability and readability of bold black-faced, 50; comparative durability of light-faced and heavy-faced, 51, 52; method of naming, 53; similarity of names of, in various countries misleading, 57; made and named everywhere without system, 57; bastard, 57, 58; two-line and double-bodied, 59; sizes and relative proportions of standard, 60, 61; text and ornamental, 62-68; wonderful as evidences of skill, 68; different sizes of, used at Mentz before 1460, 75; similar faces of, used by Caxton, Mansion, and other printers, 80; improvements

in, made by French printers, 89; Bodoni's peculiar roman and italic, 90; made by linotype machine, 105; steadily increasing demand for book and job, 105; differences between bodies of, 106; need for all present bodies of, 106; irregular sizes of, as common as regular, 106; proportions of different, 109; irregularities in faces of, 109, 110; names of, determined by size of body, 110; observations on leaded, 111 (see also *note* 2); standard widths of, 114, 116 (*note*); various sizes of, 116; stereotyping compels use of wider, 116 (*note*); broader face imperative for small, 117, 118; defect of the old system of naming, 123; their accuracy of the first importance, 125; affected by changes in heat, 125; variations in height to paper in different countries, 131 (see also *note*); six standard sizes of, 131, 132; basis of sizes of large wood and metal, 145, 146, 149; proposed change of height of, 153; injurious effects of altered standard of height, 154; change of body in English, 158; importance of uniformity in height of, 159; point system applied to the set, or width, of, 161, 162, 163; advantages of "self-spacing," 163; directions for using a new font of, 174; space covered by one pound of, 174; how to find weight of one page of, 174; square inches occupied by one thousand solid ems of various, 179; relations as to ems existing between different, 179 (see also *note*), 180; named and classified in an unsatisfactory manner, 183; fanciful names seldom given to roman, 183; arranged in three distinct classes, 183; changes in the fashion of, 209; objections to weak, 228; defects in ordinary faces of roman, 230; new styles made to conform to new methods, 234; sizes composing a full series of, for books and newspapers, 240; former rarity of complete series of, 241 (see also *note*); irregularities of two-line, 242, 243, 244, 245; need for larger sizes of two-line, 245, 246; examples of, and remarks upon, two-line, 251, 252; con-

- condensed, not popular in American and English book houses, 257; reaction against excessive use of condensed, for title-pages, 257, 258; delicacy of hair-line in large, 258, 259; limits to condensation of, 259 (see also *note*), 260; scarcity of moderately condensed, 262; condensed, appreciated by job printers, 262; capitals and lower-case not mates in some fonts, 263; utility and abuse of extra condensed, 264, 265; over-refinement in the designing of, 309; propriety of different prices for leading classes of, 336; other varieties of, sold at special and irregular rates, 336, 337; allowance for old, 337; changes in cost of metal cause changes in prices of, 337; cheaper now than before, 337; prices of American, 338; remarks upon the latter, 339; different rates in England for large and small fonts of, 340; dissimilar bodies of English and American, 340; prices of English, 341; rates for small and ornamental, higher in England than in America, 342; prices of French, 342; variable height of French and German, 342, 343; unsatisfactoriness of types cut-down, 343; prices of German, 343; duty on importations of, 344; obstacles hindering importation of, 344; reasons for former sparing use of large, 345; unsatisfactoriness of, when cast in sand-moulds, 345; abandonment of metal for larger sizes of, 346; different woods used for making large, 346; methods of, and tools used in, making wooden, 347, 348; proper function of, 359; not improved by decoration, 359; present forms of roman, held by some to be inartistic, 361; Morris on the need of better, 361; the first roman, 367; use of gothic, for later books of early Venetian printers, 369; early unacceptability of roman, 369; unsatisfactoriness of early forms of thick-stemmed roman, 370; generous relief of white space needed by, 370, 371, 372; impossibility of preserving uniformity in effect throughout series of, 375
- Type-setting, mechanical, former obstacles to, 354; the Mergenthaler and Lanston machines for, 354-357; other machines in process of development for, 357, 358; will never entirely supplant hand composition, 358
- Type-setting machines, usefulness of recent forms of, due to new processes for making types, 353; apparatus for making and setting types closely related, 353, 354
- Typographical Union, International, determination of standard widths of types by, 114
- Typography, utility of, 9; importance of skilful punch-cutting in, 11; faultless, to be had only from new type, 37; Gutenberg claimed as inventor of, 78, 79; key to the invention of, 79; most valuable improvements made in, by Italian printers, 85; Garamond accomplishes reforms in, 86; decadence of, in Italy, 90; Day's contributions to, 94; becomes decadent in England after Day's death, 95; best specimen of seventeenth-century English, 95; Moxon on, 96; Javal on the evolution of, 334; uniformity of every character a great merit, 361; Morris's views on the need of reform in, 361
- United States, scarcity of letter-signers in, 15
- United States Type Founders' Association. See *Type Founders' Association, United States*
- University Press, of Oxford, early types of, cast in foreign matrices, 96; had its own press as early as 1478, 96; contributions to, 96; its typographical riches, 96
- Van Benthuyzen, O. R., a printer, stereotyper, and type-founder, 104
- Van Dijk, Christoffel, Dutch type-founder, exhibits a size of type between pearl and diamond, 67, 68; cuts punches for the Elzevirs, 92; his types warmly praised by Moxon and Willems, 92
- Venice, first appearance of nonpareil roman in a Catholic manual printed at, 67; the goldsmiths cut punches for early printers at, 80;

- roman perfected by Jenson at, in 1471, 85; italic and small capitals introduced by Aldus Manutius at, in 1501, 85; orientals cut by Le Bé for printers of, 87; Jenson's death at, 365; thick-stemmed roman types at, 370
- Villiers, Abbé de, extract from, 273
- Virgil, or Vergil (Publius Vergilius Maro), Roman poet, italic of Aldus first used in octavo edition of, 187, 270
- Voltaire (François Marie Arouet), French writer, Beaumarchais superintends complete edition of, in Baskerville types, 99
- Voskens, Dirck, of Amsterdam, diamond type probably first made by, 67; supplies English printers with types, 92; foundry of, absorbed by Haarlem foundry, 92
- Weed, Thurlow, a printer, newspaper proprietor, and public man, sketch of, 196
- Wells, Darius, a New York printer, devotes himself to the manufacture of wooden type, 347
- Wells, Horace, an American type-founder, sketch of, 221
- White, Elihu, favors the Johnson type-casting machine, 26 (*note*); undertakes to make types without experience, 102; moves his type-foundry to New York, 102; establishes branches in Buffalo and Cincinnati, 102; his successors, 102; biographical sketch of, 222
- Whittingham, Charles, founder of the Chiswick Press, revives Caslon old-style, 98; sketch of, 199
- Wilson, Alexander, a Scottish type-founder, sketch of, 99
- Wood, large types made from, 10
- Woodcuts, the art of electrotyping first used for, 18 (*note*), 219
- Wood-engraving, early, 84
- Worde, Wynkyn de, pupil and successor of Caxton, 93; his later types cut by French artists, 93; many of his punches and types brought from Rouen, 93; discovery of some original punches of, 97; Moxon's model letters show no important departure from those used by, 300; Old English the character first used by, 301 (*note* 1)
- Zell, Ulric, on invention of type-making, 76; claims Gutenberg as inventor of printing, 78
- Zinc, unsuitability of, as an alloy of type-metal, 34 (see also *note*)



Z244
D33P7

